

**ELECTROMAGNETIC EMISSIONS COMPLIANCE REPORT
INTENTIONAL RADIATOR CERTIFICATION TO
FCC PART 15 SUBPART C
REQUIREMENT T**

OF

LED lamp

MODEL No.: GTB8R

Trademark: N/A

FCC ID: 2ACNS-GTB8R

REPORT NO: KAN150318069E

ISSUE DATE: May 17, 2015

Prepared for

NINGBO JINGHUI OPTO-ELECTRONIC CO., LTD

No.616 Qingqing Road, The District B, Zhenhai Economic Development Zone,
Ningbo China

Prepared by

SHENZHEN EMTEK CO., LTD

Bldg 69, Majialong Industry Zone, Nanshan District,
Shenzhen, Guangdong, China

TEL:0086-755-26954280

FAX: 0086-755-26954282

VERIFICATION OF COMPLIANCE

Applicant	:	NINGBO JINGHUI OPTO-ELECTRONIC CO., LTD No.616 Qingqing Road, The District B, Zhenhai Economic Development Zone, Ningbo China
Manufacturer	:	NINGBO JINGHUI OPTO-ELECTRONIC CO., LTD No.616 Qingqing Road, The District B, Zhenhai Economic Development Zone, Ningbo China
Product Description	:	LED lamp
Brand Name	:	N/A
Model Number	:	GTB8R
File Number	:	KAN150318069E
Date of Test:	:	April 06, 2015 to May 08, 2015

We hereby certify that:

The above equipment was tested by SHENZHEN EMTEK CO., LTD. The test data, data evaluation, test procedures, and equipment configurations shown in this report were made in accordance with the procedures given in ANSI C63.10-2013 and the energy emitted by the sample EUT tested as described in this report is in compliance with conducted and radiated emission limits of FCC Rules Part 15.247.

The test results of this report relate only to the tested sample identified in this report.

Date of Test : April 06, 2015 to May 08, 2015

Prepared by : 
Jack Li/Editor

Reviewer : 
Joe Xia/Supervisor

Approve & Authorized Signer : 
Lisa Wang/Manager

TABLE OF CONTENTS

1. GENERAL INFORMATION.....	5
1.1 Product Description	5
1.2 Test Methodology	5
1.3 Special Accessories	5
1.4 Equipment Modifications	5
1.5 Test Facility	6
2. SYSTEM TEST CONFIGURATION.....	7
2.1 EUT Configuration	7
2.2 EUT Exercise	7
2.3 Test Procedure.....	7
2.4 Configuration of Tested System.....	7
2.5 Equipment Used in Tested System.....	7
3. DESCRIPTION OF TEST MODES	8
4. CONDUCTED EMISSIONS TEST	9
4.1 Measurement Procedure	9
4.2 Test SET-UP (Block Diagram of Configuration).....	9
4.3 Measurement Equipment Used	9
4.4 Conducted Emission Limit	9
4.5 Measurement Result	9
5. RADIATED EMISSION TEST	12
5.1 Measurement Procedure	12
5.2 Test SET-UP (Block Diagram of Configuration).....	12
5.3 Measurement Equipment Used	13
5.4 Radiated emission limit.....	14
5.5 Measurement Result	14
6. 6DB BANDWIDTH MEASUREMENT.....	18
6.1 Measurement Procedure	18
6.2 Test SET-UP (Block Diagram of Configuration).....	18
6.3 Measurement Equipment Used	18
6.4 Limit	18
6.5 Measurement Results.....	18
7. MAXIMUM PEAK OUTPUT POWER TEST	21
7.1 Measurement Procedure	21
7.2 Test SET-UP (Block Diagram of Configuration).....	21
7.3 Measurement Equipment Used	21
7.4 Peak Power output limit.....	21
7.5 Measurement Results.....	21
8. POWER SPECTRAL DENSITY MEASUREMENT	24
8.1 Measurement Procedure	24
8.2 Test SET-UP (Block Diagram of Configuration).....	24
8.3 Measurement Equipment Used	24
8.4 Measurement Procedure	24

8.5	Measurement Results	24
9.	BAND EDGE TEST	29
9.1	Measurement Procedure	29
9.2	Test SET-UP (Block Diagram of Configuration).....	29
9.3	Measurement Equipment Used	30
9.4	Measurement Results.....	30
10.	ANTENNA APPLICATION	32
10.1	Antenna requirement	32
10.2	Result.....	32

1. GENERAL INFORMATION

1.1 Product Description

The NINGBO JINGHUI OPTO-ELECTRONIC CO., LTD, Model: GTB8R (referred to as the EUT in this report)
 The EUT is an short range, lower power transmitter. It is designed by way of utilizing the following modulation achieves the system operating.

- A). Operation Frequency: 2402-2480MHz
- B). Kind of device: Bluetooth 4.0(Only BLE)
- C). Modulation: GFSK
- D). Number of Channel: 40
- E). Channel space: 2MHz
- F). Measured RF Output Power: -1.19dBm (0.76mW)
- G). Antenna Type: Internal antenna
- H). Antenna GAIN: 4 dBi
- I). Input Rating: AC 100V-264V, 50/60Hz

Channel List:

Channel	Frequency (MHz)	Channel	Frequency (MHz)	Channel	Frequency (MHz)
00	2402	14	2430	28	2458
01	2404	15	2432	29	2460
02	2406	16	2434	30	2462
03	2408	17	2436	31	2464
04	2410	18	2438	32	2466
05	2412	19	2440	33	2468
06	2414	20	2442	34	2470
07	2416	21	2444	35	2472
08	2418	22	2446	36	2474
09	2420	23	2448	37	2476
10	2422	24	2450	38	2478
11	2424	25	2452		
12	2426	26	2454		

Note:

1. Test of channel was included the lowest 2402MHz, middle 2442MHz and highest frequency 2480MHz in highest data rate and to perform the test, then record on this report.

1.2 Test Methodology

Both conducted and radiated testing were performed according to the procedures in ANSI C63.10-2013. Radiated testing was performed at an antenna to EUT distance 3 meters.

Tested in accordance with FCC KDB Publication No. 558074 D01 DTS Meas. Guidance v03r02 for compliance to FCC 47CFR 15.247 requirements.

1.3 Special Accessories

Not available for this EUT intended for grant.

1.4 Equipment Modifications

Not available for this EUT intended for grant.

1.5 Test Facility

Site Description
EMC Lab.

- : Accredited by CNAS, 2013.10.29
The certificate is valid until 2016.10.28
The Laboratory has been assessed and proved to be in compliance with
CNAS/CL01:2006(identical to ISO/IEC17025: 2005)
The Certificate Registration Number is L2291

- Accredited by TUV Rheinland Shenzhen 2010.5.25
The Laboratory has been assessed according to the requirements ISO/IEC
17025

- Accredited by FCC, April 17, 2014
The Certificate Registration Number is 406365.

- Accredited by Industry Canada, March 5, 2010
The Certificate Registration Number is 4480A-2.

Name of Firm
Site Location

- : SHENZHEN EMTEK CO., LTD
- : Bldg 69, Majialong Industry Zone, Nanshan District, Shenzhen,
Guangdong, China

2. System Test Configuration

2.1 EUT Configuration

The EUT configuration for testing is installed on RF field strength measurement to meet the Commissions requirement and operating in a manner which intends to maximize its emission characteristics in a continuous transmission application.

2.2 EUT Exercise

The Transmitter was operated in the transmission operating mode. the Tx frequency was fixed which was for the purpose of the measurements.

2.3 Test Procedure

2.3.1 Conducted Emissions

The EUT is a placed on as turn table which is 0.8 m above ground plane. According to the requirements in Section 6.2 of ANSI C63.10-2013. Conducted emissions from the EUT measured in the frequency range between 0.15 MHz and 30MHz using CISPR Quasi-Peak and average detector mode.

2.3.2 Radiated Emissions

The turn table shall rotate 360 degrees to determine the position of maximum emission level. EUT is set 3m away from the receiving antenna which varied from 1m to 4m to find out the highest emission. And also, each emission was to be maximized by changing the polarization of receiving antenna both horizontal and vertical. In order to find out the max. emission, the relative positions of this LED lamp (EUT) was rotated through three orthogonal axes according to the requirements in section 6.4, section 6.5 and section 6.6 of ANSI C63.10-2013

2.4 Configuration of Tested System

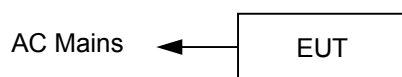

2.5 Equipment Used in Tested System

Item	Equipment	Mfr/Brand	Model/Type No.	FCC ID	Series No.	Note
1.	LED lamp	JINGHUI	GTB8R	2ACNS-GTB8R	N/A	EUT
\	\	\	\	\	\	\

Note:

1. Unless otherwise denoted as EUT in 『Remark』 column, device(s) used in tested system is a support equipment.

3. Description of Test Modes

The EUT has been tested under its typical operating condition. Pre-defined engineering program for regulatory testing used to control the EUT for staying in continuous transmitting. Only the worst case data were reported.

The EUT has been associated with peripherals pursuant to ANSI C63.10-2013 and configuration operated in a manner tended to maximize its emission characteristics in a typical application. Frequency range investigated: radiation (9 KHz to the 10th harmonic of the highest fundamental frequency or to 40 GHz, whichever is lower).

For Radiated: The EUT's antenna was pre-tested under the following modes:

Test Mode	Description
Mode A	X-Y axis
Mode B	Y-Z axis
Mode C	X-Z axis

From the above modes, the worst case was found in Mode A. Therefore only the test data of the mode was recorded in this report.

The details of test channels and bandwidth were for RF conductive measurement.

1. For lowest channel : 2402MHz(Channel 00)
2. For middle channel : 2442MHz(Channel 20)
3. For highest channel: 2480MHz(Channel 39)

4. Conducted Emissions Test

4.1 Measurement Procedure

1. The EUT was placed on a table which is 0.8m above ground plane.
2. Maximum procedure was performed on the three highest emissions to ensure EUT compliance.
3. Repeat above procedures until all frequency measured were complete.

4.2 Test SET-UP (Block Diagram of Configuration)

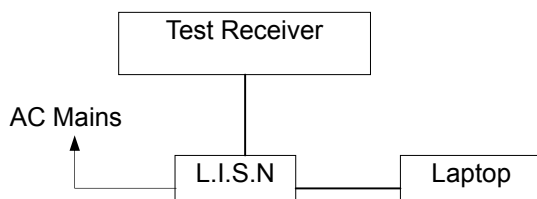

4.3 Measurement Equipment Used

Conducted Emission Test Site					
Equipment Type	MFR	Model Number	Serial Number	Last Cal.	Cal due.
Test Receiver	Rohde & Schwarz	ESCS30	828985/018	05/17/2014	05/16/2015
L.I.S.N.	Rohde & Schwarz	ENV216	101161	05/17/2014	05/16/2015
L.I.S.N.	Schwarzbeck	NNLK8129	8129203	05/17/2014	05/17/2015
50Ω Coaxial Switch	Anritsu	MP59B	M20531	N/A	N/A
Pulse Limiter	Rohde & Schwarz	ESH3-Z2	100006	05/17/2014	05/17/2015

4.4 Conducted Emission Limit

Frequency (MHz)	Limit (dBμV)	
	Quasi-peak Level	Average Level
0.15 ~ 0.50	66.0 ~ 56.0 *	56.0 ~ 46.0 *
0.50 ~ 5.00	56.0	46.0
5.00 ~ 30.00	60.0	50.0

NOTE1-The lower limit shall apply at the transition frequencies.
NOTE2-The limit decreases linearly with the logarithm of the frequency in the range 0.15MHz to 0.50MHz.

4.5 Measurement Result

Pass.
Please refer to the following data.

Worst Case Operating Mode: TX(2402MHz)

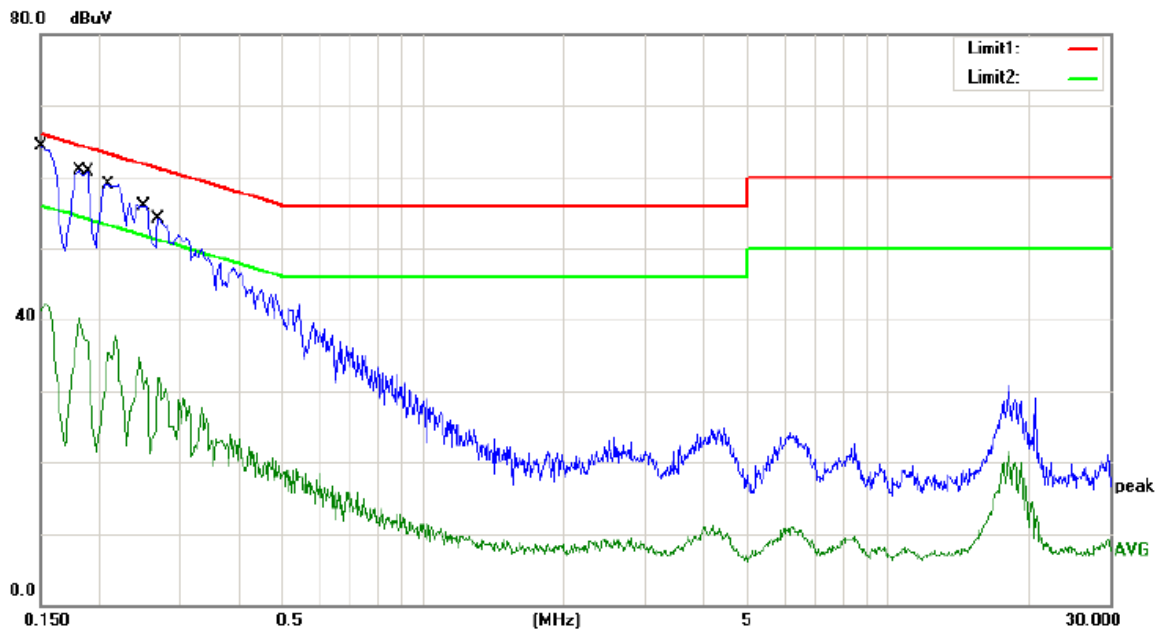

Site site #1 Phase: **L1** Temperature: 20
 Limit: (CE)FCC PART 15 Power: AC 120V/60Hz Humidity: 51 %
 EUT: LED Lamp
 M/N: GTB8R
 Mode: TX (2402MHz)
 Note:

No.	Mk.	Freq. MHz	Reading Level dBuV	Correct Factor dB	Measure- ment dBuV	Limit dBuV	Over dB	Detector	Comment
1		0.1500	45.40	11.00	56.40	66.00	-9.60	QP	
2		0.1500	30.30	11.00	41.30	56.00	-14.70	AVG	
3		0.1820	39.80	11.00	50.80	64.39	-13.59	QP	
4		0.1820	28.80	11.00	39.80	54.39	-14.59	AVG	
5		0.1900	39.70	11.00	50.70	64.04	-13.34	QP	
6		0.1900	24.80	11.00	35.80	54.04	-18.24	AVG	
7		0.2100	37.90	11.00	48.90	63.21	-14.31	QP	
8		0.2100	24.30	11.00	35.30	53.21	-17.91	AVG	
9		0.2507	34.90	11.00	45.90	61.73	-15.83	QP	
10		0.2507	19.60	11.00	30.60	51.73	-21.13	AVG	
11		0.2700	33.10	11.00	44.10	61.12	-17.02	QP	
12		0.2700	20.90	11.00	31.90	51.12	-19.22	AVG	

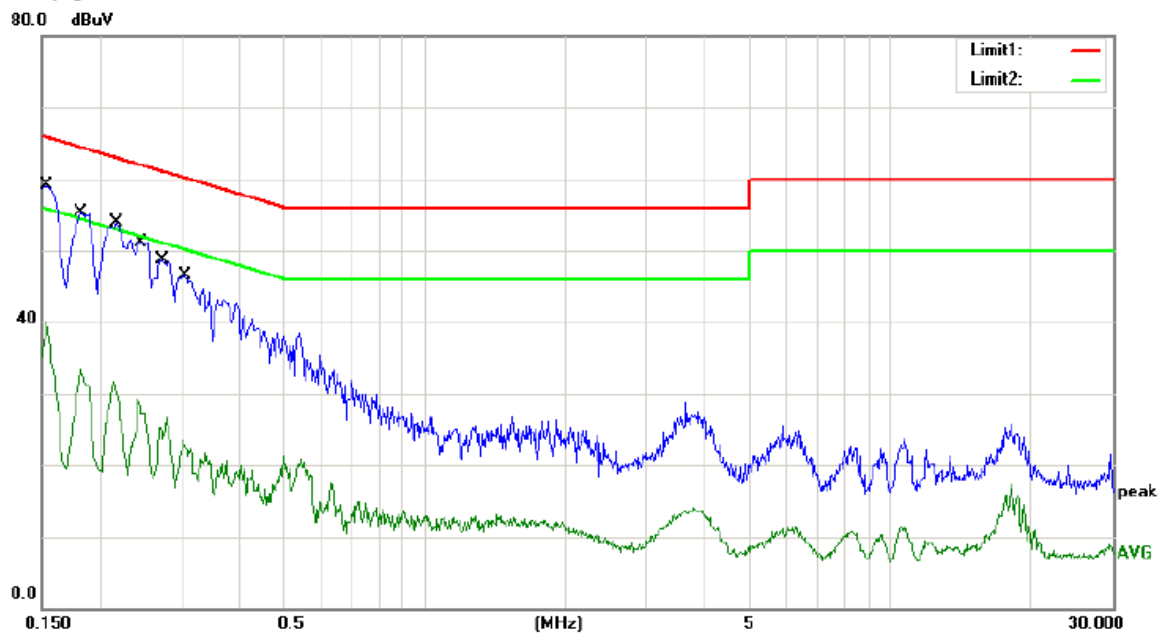

Site site #1
 Limit: (CE)FCC PART 15
 EUT: LED Lamp
 M/N: GTB8R
 Mode: TX (2402MHz)
 Note:

Phase: **N** Temperature: 20
 Power: AC 120V/60Hz Humidity: 51 %

No.	Mk.	Freq. MHz	Reading Level dBuV	Correct Factor dB	Measure- ment dBuV	Limit dBuV	Over dB	Detector	Comment
1		0.1540	41.60	11.00	52.60	65.78	-13.18	QP	
2		0.1540	29.10	11.00	40.10	55.78	-15.68	AVG	
3		0.1820	38.30	11.00	49.30	64.39	-15.09	QP	
4		0.1820	22.10	11.00	33.10	54.39	-21.29	AVG	
5		0.2180	42.80	11.00	53.80	62.89	-9.09	QP	
6		0.2180	19.10	11.00	30.10	52.89	-22.79	AVG	
7		0.2468	40.00	11.00	51.00	61.86	-10.86	QP	
8		0.2468	16.30	11.00	27.30	51.86	-24.56	AVG	
9		0.2740	37.60	11.00	48.60	61.00	-12.40	QP	
10		0.2740	12.70	11.00	23.70	51.00	-27.30	AVG	
11		0.3060	35.50	11.00	46.50	60.08	-13.58	QP	
12		0.3060	11.70	11.00	22.70	50.08	-27.38	AVG	

5. Radiated Emission Test

5.1 Measurement Procedure

1. The EUT was placed on a turntable which is 0.8m above ground plane.
2. Maximum procedure was performed on the six highest emissions to ensure EUT compliance.
3. And also, each emission was to be maximized by changing the polarization of receiving antenna both horizontal and vertical.
4. Repeat above procedures until all frequency measured was complete.

The frequency range from 30MHz to 1000MHz was pre-scanned with a peak detector (RBW=100kHz, VBW=300kHz) and all final readings of measurement from Test Receiver are Quasi-Peak values (Quasi Peak detector used with a bandwidth of 120 kHz).

The frequency range above 1GHz the measuring instrument use RBW=1 MHz and VBW=3 MHz with Peak Detector for Peak Values, and use RBW=1 MHz and VBW=10 Hz with Peak Detector for Average Values.

5.2 Test SET-UP (Block Diagram of Configuration)

(A) Radiated Emission Test Set-Up, Frequency below 30MHz

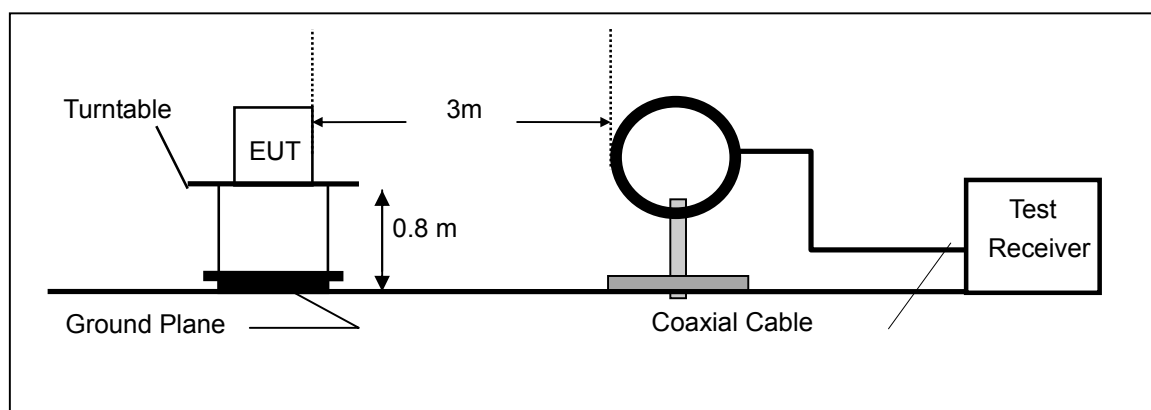

(B) Radiated Emission Test Set-Up, Frequency below 1000MHz

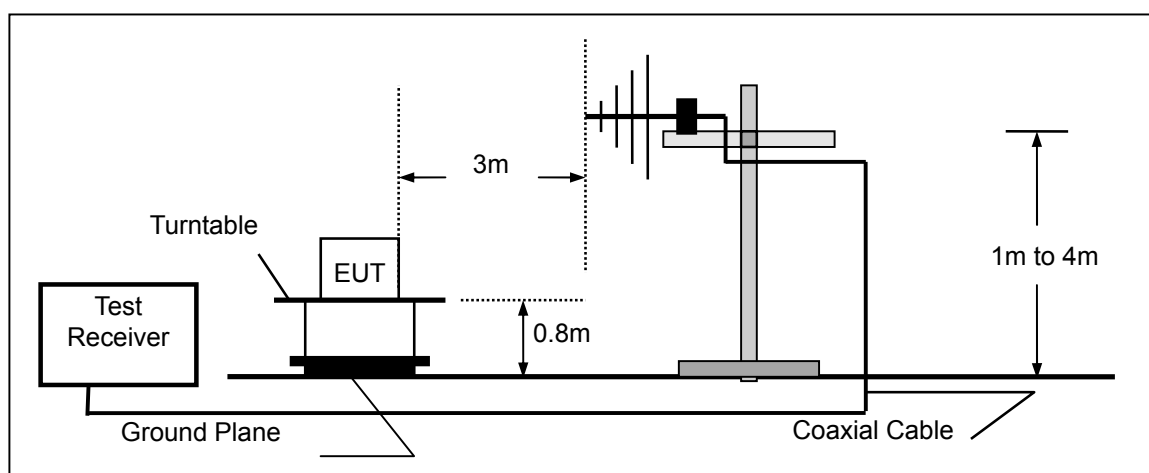

(C) Radiated Emission Test Set-Up, Frequency above 1000MHz

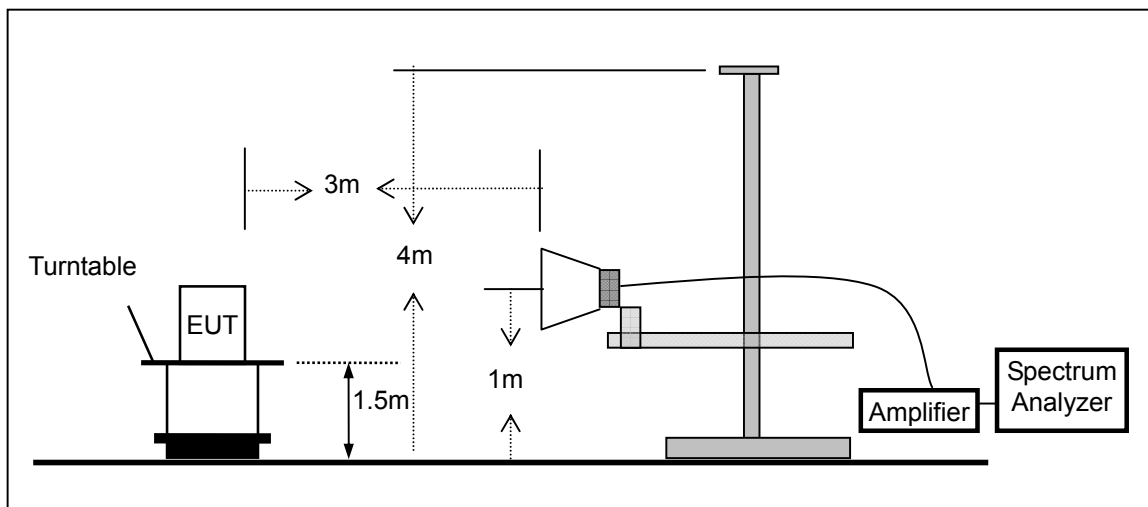

5.3 Measurement Equipment Used

Item	Equipment	Manufacturer	Model No.	Serial No.	Last Cal.	Cal. Interval
1.	EMI Test Receiver	Rohde & Schwarz	ESU	1302.6005.26	05/17/2014	1 Year
2.	Pre-Amplifier	HP	8447D	2944A07999	05/17/2014	1 Year
3.	Pre-Amplifier	A.H.	PAM-0126	1415261	05/17/2014	1 Year
4.	Bilog Antenna	Schwarzbeck	VULB9163	142	05/17/2014	1 Year
5.	Loop Antenna	Schwarzbeck	FMZB 1519	1519-012	05/17/2014	1 Year
6.	Horn Antenna	Schwarzbeck	BBHA 9170	BBHA9170399	05/17/2014	1 Year
7.	Horn Antenna	Schwarzbeck	BBHA 9120	D143	05/17/2014	1 Year
8.	Cable	Schwarzbeck	AK9513	ACRX1	05/17/2014	1 Year
9.	Cable	Rosenberger	N/A	FP2RX2	05/17/2014	1 Year
10.	Cable	Schwarzbeck	AK9513	CRPX1	05/17/2014	1 Year
11.	Cable	Schwarzbeck	AK9513	CRRX2	05/17/2014	1 Year

5.4 Radiated emission limit

Frequency (MHz)	Field strength $\mu\text{V/m}$	Distance(m)	Field strength at 3m $\text{dB}\mu\text{V/m}$
0.009~0.490	2400/F(KHz)	300	/
0.490~1.705	2400/F(KHz)	30	/
1.705~30.0	30	30	/
30-88	100	3	40
88-216	150	3	43.5
216-960	200	3	46
Above 960	500	3	54

5.5 Measurement Result

(For range 9KHz~30MHz, The measured value is really too low to be recorded.)

30M-1GHz:

Worst Case Operating Mode: TX(2402MHz)

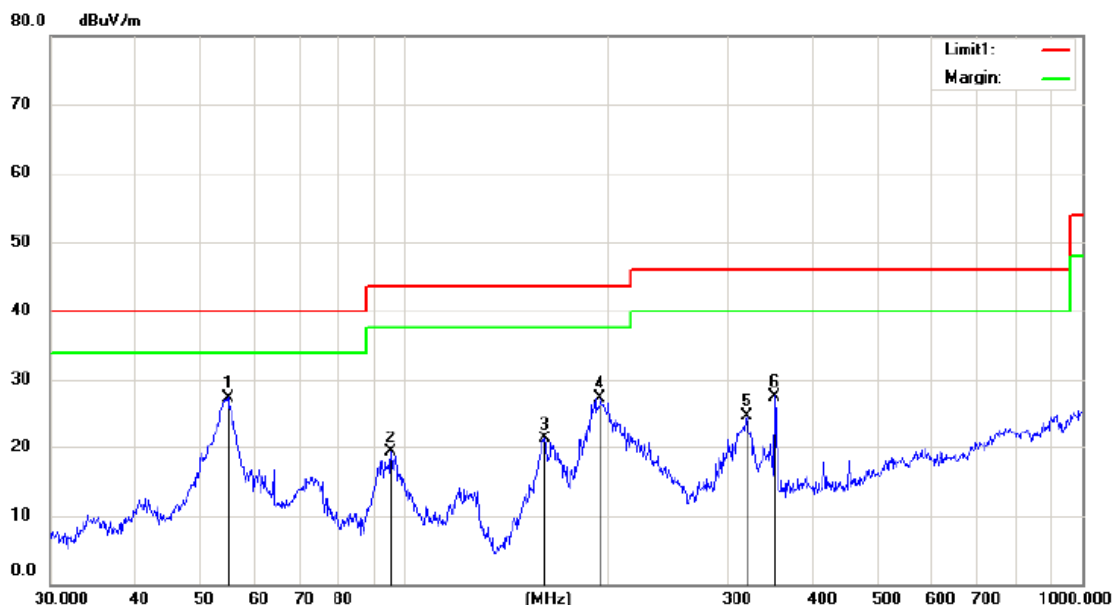

Site site #1 Polarization: **Horizontal** Temperature: 20 C
 Limit: FCC Part15 Class B 3M Radiation Power: AC 120V/60Hz Humidity: 52 %
 EUT: LED Lamp
 M/N: GTB8R
 Mode:TX(2402MHz)
 Note:

No.	Mk.	Freq.	Reading Level	Correct Factor	Measurement	Limit	Over	Antenna Height	Table Degree	
		MHz	dBuV	dB	dBuV/m	dBuV/m	dB	cm	degree	Comment
1		54.8348	47.16	-19.76	27.40	40.00	-12.60	QP		
2		95.4270	42.31	-23.01	19.30	43.50	-24.20	QP		
3		160.9090	46.84	-25.54	21.30	43.50	-22.20	QP		
4		194.4534	49.03	-21.73	27.30	43.50	-16.20	QP		
5		319.9370	42.75	-18.05	24.70	46.00	-21.30	QP		
6		351.7080	45.86	-18.26	27.60	46.00	-18.40	QP		

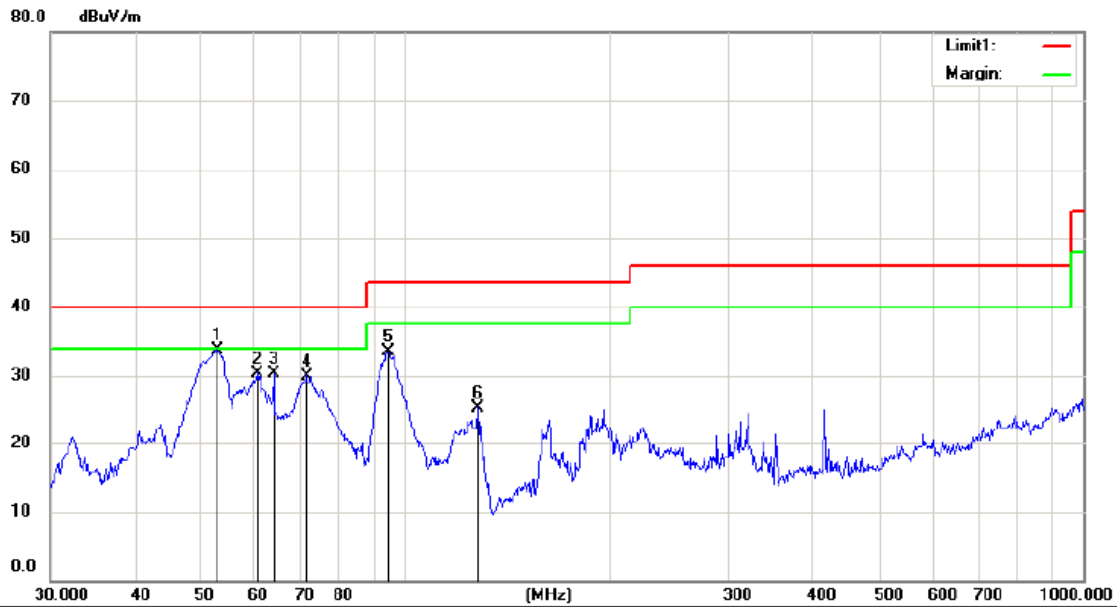

Site site #1 Polarization: **Vertical** Temperature: 20 C
 Limit: FCC Part15 Class B 3M Radiation Power: AC 120V/60Hz Humidity: 52 %
 EUT: LED Lamp
 M/N: GTB8R
 Mode:TX(2402MHz)
 Note:

No.	Mk.	Freq.	Reading Level	Correct Factor	Measurement	Limit	Over	Antenna Height	Table Degree	Detector	Comment
		MHz	dBuV	dB	dBuV/m	dBuV/m	dB	cm	degree		
1		52.9453	53.37	-19.57	33.80	40.00	-6.20			QP	
2		60.7043	52.36	-21.96	30.40	40.00	-9.60			QP	
3		63.9827	52.90	-22.60	30.30	40.00	-9.70			QP	
4		71.5805	54.59	-24.59	30.00	40.00	-10.00			QP	
5		94.4283	56.72	-23.22	33.50	43.50	-10.00			QP	
6		128.1130	50.12	-24.72	25.40	43.50	-18.10			QP	

Above 1000MHz:

Test Date : 05/04/2015 Temperature : 24 °C
 Test Result: Pass Humidity : 56 %
 Test By: KY

TX Mode (CH00: 2402MHz)							
Freq. (MHz)	Ant.Pol. (H/V)	Emission Level(dBuV/m)		Limit 3m(dBuV/m)		Margin(dB)	
		PK	AV	PK	AV	PK	AV
4804	H	63.92	45.49	74.00	54.00	-10.08	-8.51
7206	H	62.33	44.59	74.00	54.00	-11.67	-9.41
9608	H	62.12	43.69	74.00	54.00	-11.88	-10.31
12010	H	60.38	42.55	74.00	54.00	-13.62	-11.45
14412	H	59.23	40.93	74.00	54.00	-14.77	-13.07
4804	V	62.92	46.72	74.00	54.00	-11.08	-7.28
7206	V	62.12	45.49	74.00	54.00	-11.88	-8.51
9608	V	61.05	43.92	74.00	54.00	-12.95	-10.08
12010	V	59.38	43.62	74.00	54.00	-14.62	-10.38
14412	V	59.09	42.32	74.00	54.00	-14.91	-11.68

TX Mode (CH20: 2442MHz)							
Freq. (MHz)	Ant.Pol. (H/V)	Emission Level(dBuV/m)		Limit 3m(dBuV/m)		Margin(dB)	
		PK	AV	PK	AV	PK	AV
4884	H	63.48	44.69	74.00	54.00	-10.52	-9.31
7326	H	62.33	44.31	74.00	54.00	-11.67	-9.69
9768	H	61.97	43.08	74.00	54.00	-12.03	-10.92
12210	H	61.10	42.05	74.00	54.00	-12.90	-11.95
14652	H	59.87	40.61	74.00	54.00	-14.13	-13.39
4884	V	64.48	46.08	74.00	54.00	-9.52	-7.92
7326	V	63.97	45.05	74.00	54.00	-10.03	-8.95
9768	V	62.94	43.51	74.00	54.00	-11.06	-10.49
12210	V	61.74	43.21	74.00	54.00	-12.26	-10.79
14652	V	60.17	42.05	74.00	54.00	-13.83	-11.95

TX Mode (CH39: 2480MHz)							
Freq. (MHz)	Ant.Pol. (H/V)	Emission Level(dBuV/m)		Limit 3m(dBuV/m)		Margin(dB)	
		PK	AV	PK	AV	PK	AV
4960	H	63.83	46.05	74.00	54.00	-10.17	-7.95
7440	H	62.37	44.46	74.00	54.00	-11.63	-9.54
9920	H	61.89	43.38	74.00	54.00	-12.11	-10.62
12400	H	60.83	42.46	74.00	54.00	-13.17	-11.54
14880	H	59.07	41.41	74.00	54.00	-14.93	-12.59
4960	V	64.99	45.06	74.00	54.00	-9.01	-8.94
7440	V	63.79	43.49	74.00	54.00	-10.21	-10.51
9920	V	62.77	43.18	74.00	54.00	-11.23	-10.82
12400	V	61.96	42.05	74.00	54.00	-12.04	-11.95
14880	V	60.39	40.66	74.00	54.00	-13.61	-13.34

Other harmonics emissions are lower than 20dB below the allowable limit.

6. 6dB Bandwidth Measurement

6.1 Measurement Procedure

The EUT was operating in hopping mode or could be controlled its channel. Print out the test result from the spectrum by hard copy function.

6.2 Test SET-UP (Block Diagram of Configuration)



6.3 Measurement Equipment Used

Name of Equipment	Manufacturer	Model	Serial Number	Last Cal.	CAL DUE.
Spectrum Analyzer	Rohde & Schwarz	ESCI	10017	08/01/2014	08/01/2015

6.4 Limit

The minimum 6dB bandwidth shall be at least 500kHz.

6.5 Measurement Results

The following table is the setting of spectrum analyzer.

Attenuation	Auto
RB	100KHz
VB	300KHz
Detector	Peak
Trace	Max hold

Refer to attached data chart.

Spectrum Detector:	PK	Test Date :	04/25/2015
Test By:	Kuki	Temperature :	20 °C
Test Result:	Pass	Humidity :	54 %

Channel number	Channel frequency (MHz)	Measurement level (KHz)	Required Limit (KHz)
00	2402	700	>500
20	2442	700	>500
39	2480	700	>500

Channel 00:

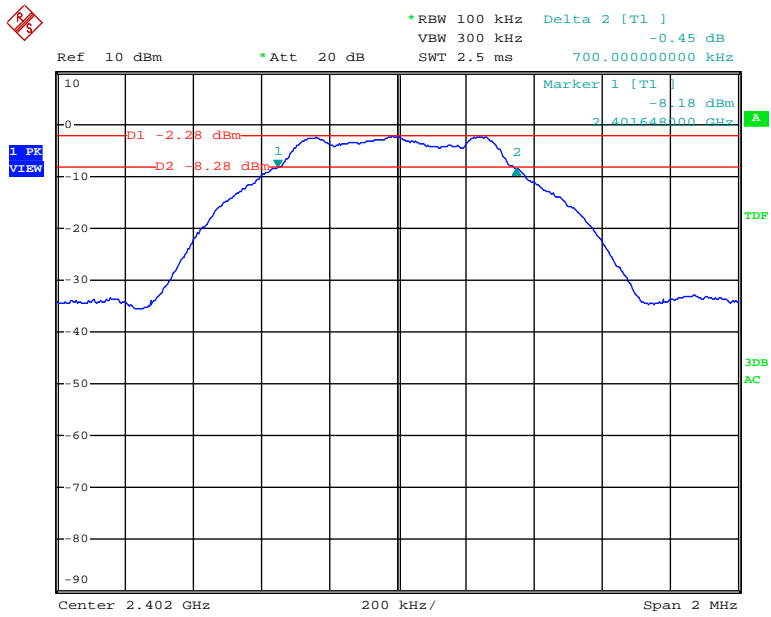

Date: 25.APR.2015 10:45:20

Channel 20:

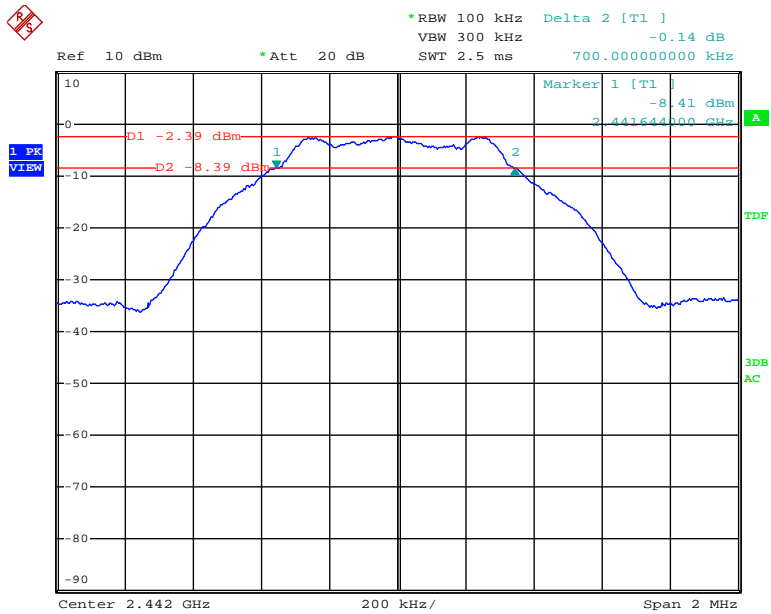

Date: 25.APR.2015 10:41:54

Channel 39:

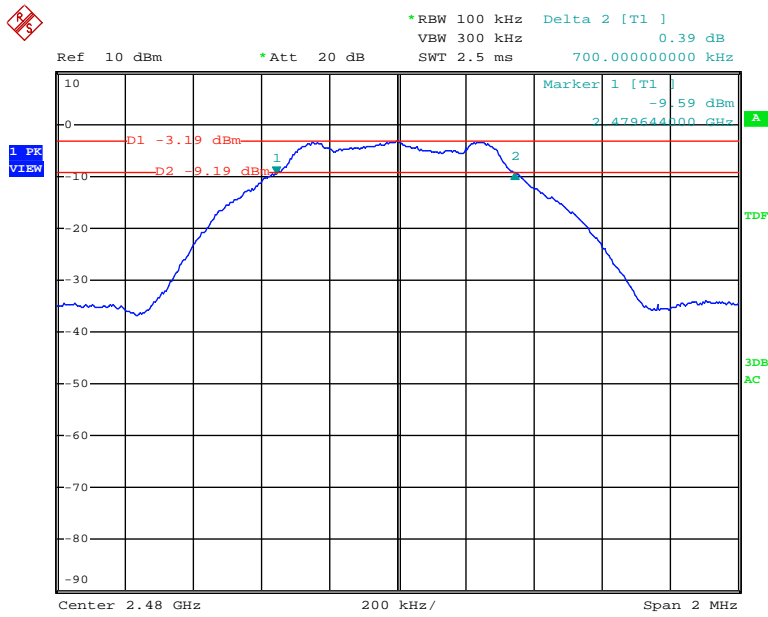

Date: 25.APR.2015 10:40:00

7. Maximum Peak Output Power Test

7.1 Measurement Procedure

- The Transmitter output (antenna port) was connected to the spectrum Analyzer.
- Turn on the EUT and then record the peak power value.
- Repeat above procedures on all channels needed to be tested.

7.2 Test SET-UP (Block Diagram of Configuration)

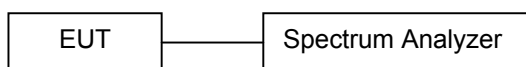

7.3 Measurement Equipment Used

Name of Equipment	Manufacturer	Model	Serial Number	Last Cal.	CAL DUE.
Spectrum Analyzer	Rohde & Schwarz	ESCI	10017	08/01/2014	08/01/2015

7.4 Peak Power output limit

The maximum peak power shall be less 1Watt.

7.5 Measurement Results

Refer to attached data chart.

Spectrum Detector:	PK	Test Date:	04/25/2015
Test By:	Kuki	Temperature:	20 °C
Test Result:	Pass	Humidity:	54 %

Channel number	Channel Frequency (MHz)	Peak Power output(dBm)	Peak Power output(mW)	Peak Power Limit(W)	Pass/Fail
00	2402	-1.19	0.76	1W(30dBm)	Pass
20	2442	-1.43	0.72	1W(30dBm)	Pass
39	2480	-1.80	0.66	1W(30dBm)	Pass

Channel 00:

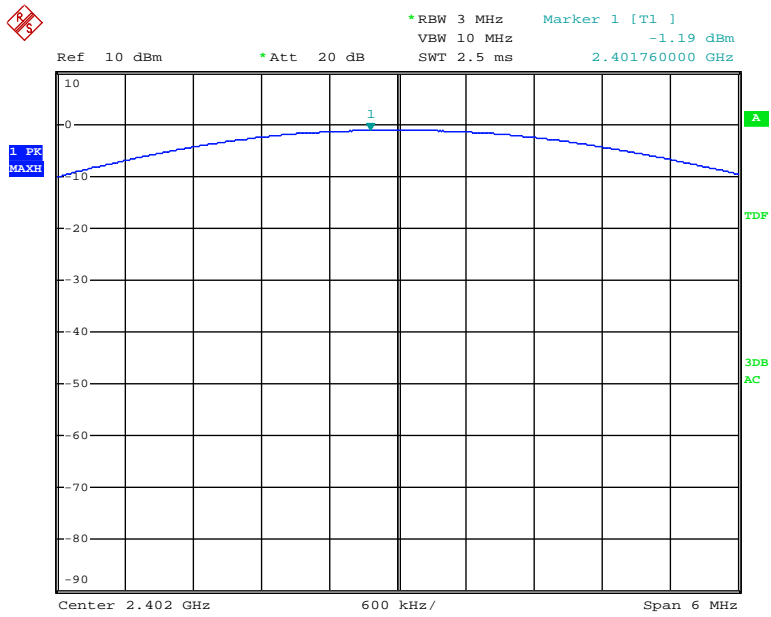

Date: 25.APR.2015 10:34:01

Channel 20:

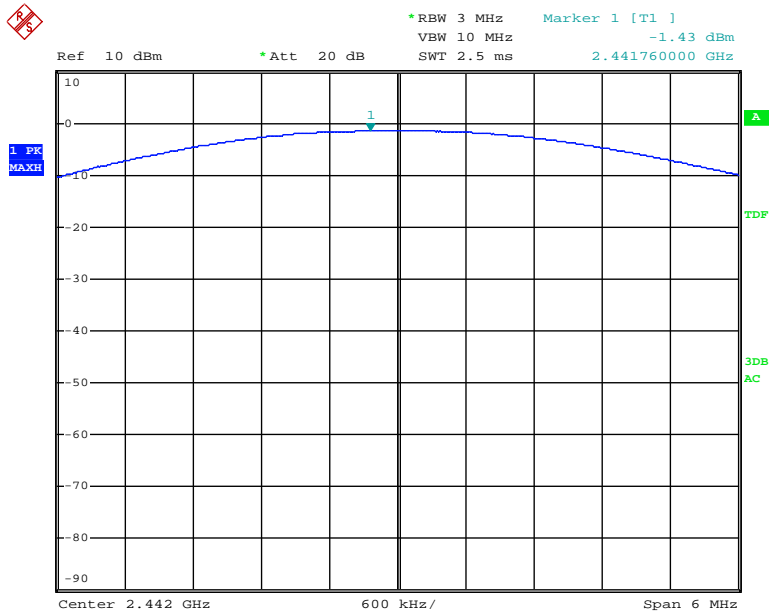

Date: 25.APR.2015 10:34:49

Channel 39:

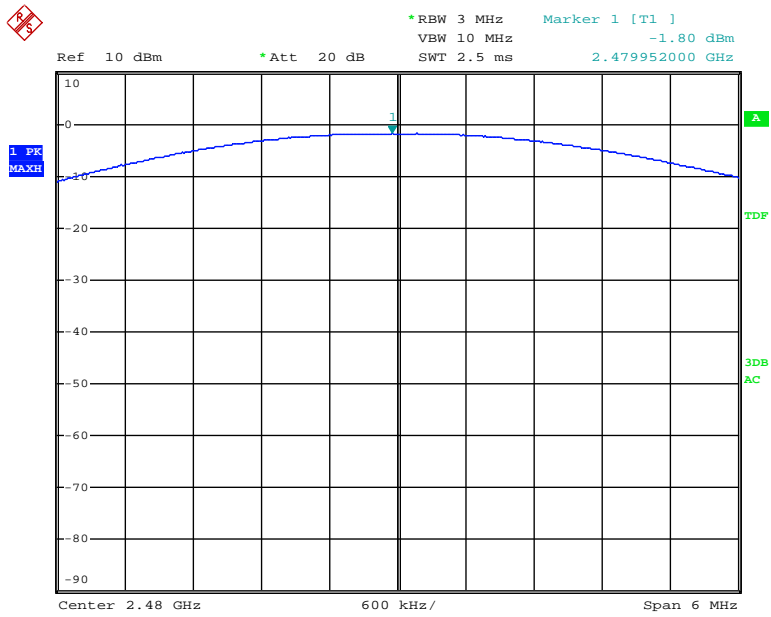

Date: 25.APR.2015 10:35:39

8. Power Spectral Density Measurement

8.1 Measurement Procedure

The EUT was operating in Bluetooth mode or could be controlled its channel. Printed out the test result from the spectrum by hard copy function.

8.2 Test SET-UP (Block Diagram of Configuration)

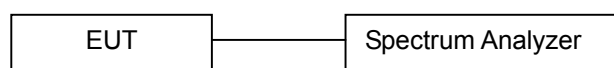

8.3 Measurement Equipment Used

Name of Equipment	Manufacturer	Model	Serial Number	Last Cal.	CAL DUE.
Spectrum Analyzer	Rohde & Schwarz	ESCI	10017	08/01/2014	08/01/2015

8.4 Measurement Procedure

- The RF output of EUT was connected to the spectrum analyzer by RF cable and attenuator. The path loss was compensated to the results for each measurement.
- Set to the maximum power setting and enable the EUT transmit continuously.
- Make the measurement with the spectrum analyzer's resolution bandwidth (RBW)=3 kHz. Video bandwidth VBW =10 kHz In order to make an accurate measurement, set the span to 1.5 times DTS Channel Bandwidth. (6dB BW)
- Detector =Peak, Sweep time =Auto couple, Trace mode =Max hold, Allow trace to fully stabilize. Use the peak marker function to determine the maximum power level.
- Measure and record the results in the test report.
- The Measured power density (dBm)/ 100KHz is a reference level and used as 20dBc down limit line for Conducted Band Edges and Conducted Spurious Emission.

8.5 Measurement Results

The following table is the setting of spectrum analyzer.

Spectrum analyzer	Setting
Attenuation	Auto
Span Frequency	Set the span to 1.5 times the DTS bandwidth.
RB	3KHz
VB	10KHz
Detector	Peak
Trace	Max hold
Sweep Time	Automatic

Refer to attached data chart.

Spectrum Detector:	PK	Test Date :	04/25/2015
Test By:	Kuki	Temperature :	20 °C
Test Result:	Pass	Humidity :	54 %

Channel number	Channel frequency (MHz)	Measurement level (dBm)		Required Limit (dBm/3kHz)	Pass/Fail
		PSD/100kHz	PSD/3kHz		
00	2402	-2.27	-16.84	8	Pass
20	2440	-2.34	-17.02	8	Pass
39	2480	-3.13	-18.05	8	Pass

Note:

1. Measured power density(dBm) has offset with cable loss.
2. The measured power density(dBm)/100KHz is reference level and used as 20dBc down for Conducted Band Edges and Conducted Spurious Emission limit line.

PSD 100kHz Plot: Channel 00

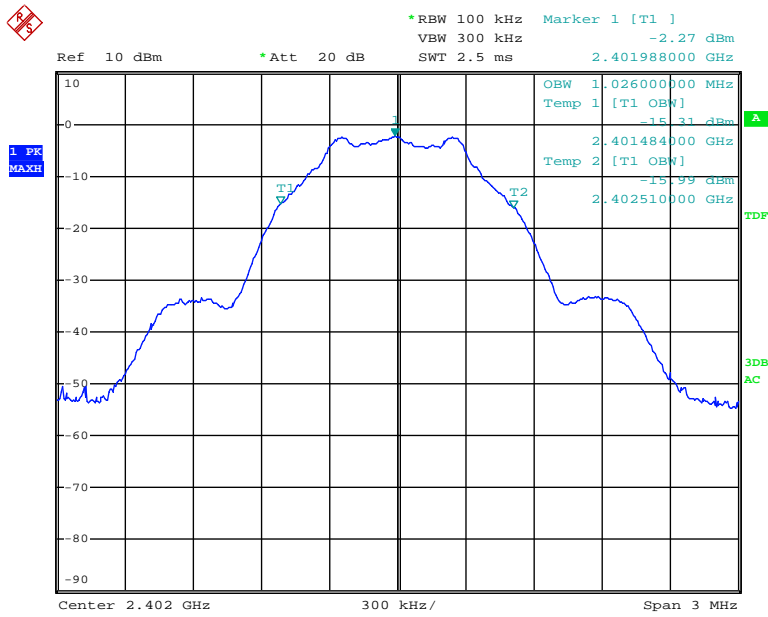

Date: 25.APR.2015 10:53:42

PSD 100kHz Plot: Channel 20

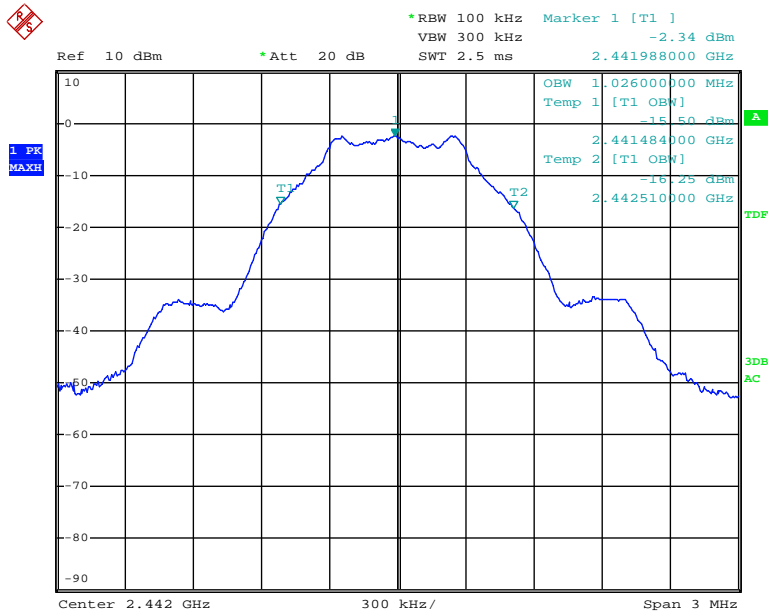

Date: 25.APR.2015 10:54:43

PSD 100kHz Plot: Channel 39

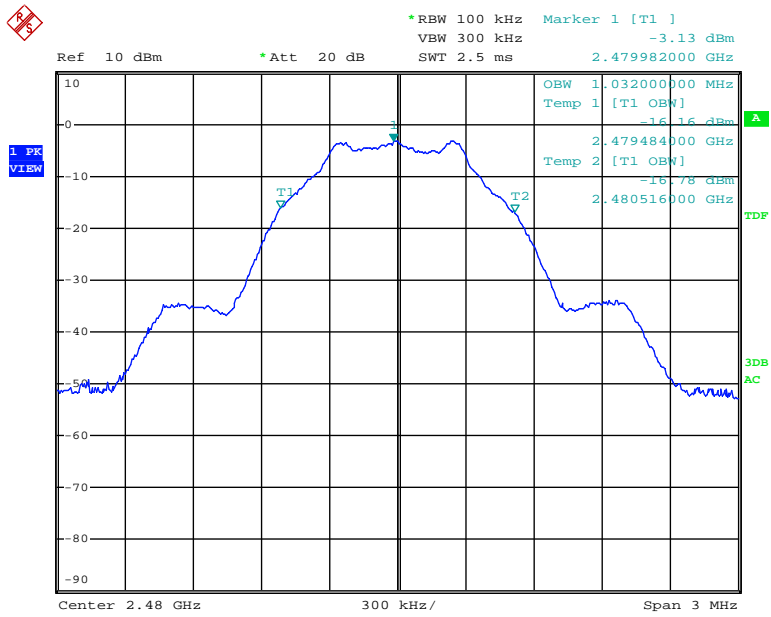

Date: 25.APR.2015 10:56:12

PSD 3kHz Plot: Channel 00

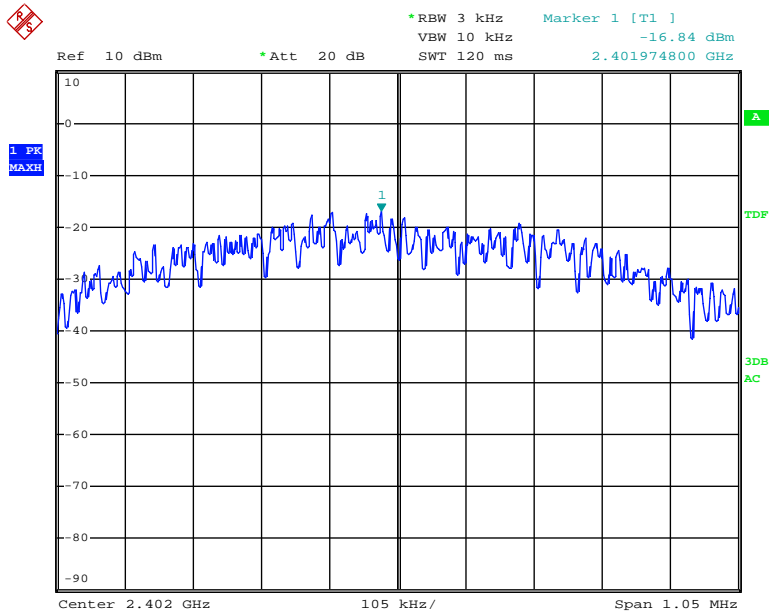

Date: 25.APR.2015 11:00:57

PSD 3kHz Plot: Channel 20

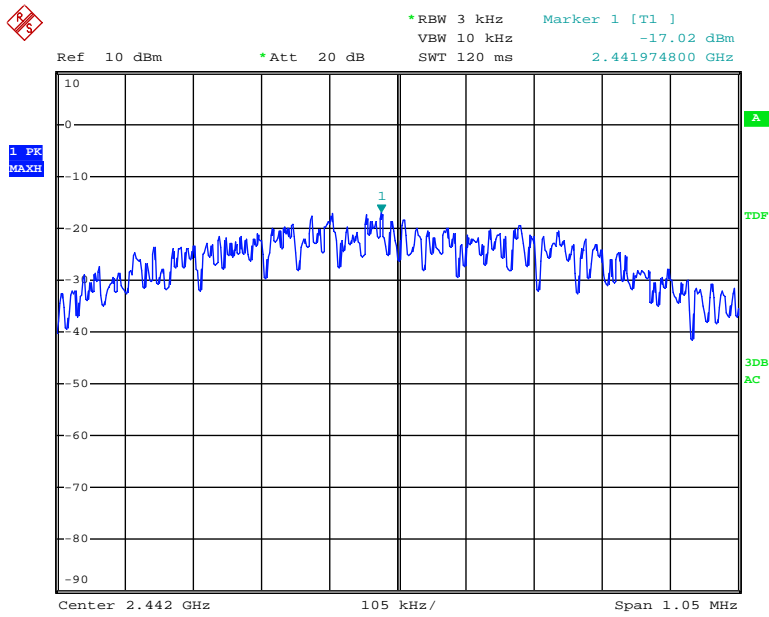

Date: 25.APR.2015 10:59:47

PSD 3kHz Plot: Channel 39

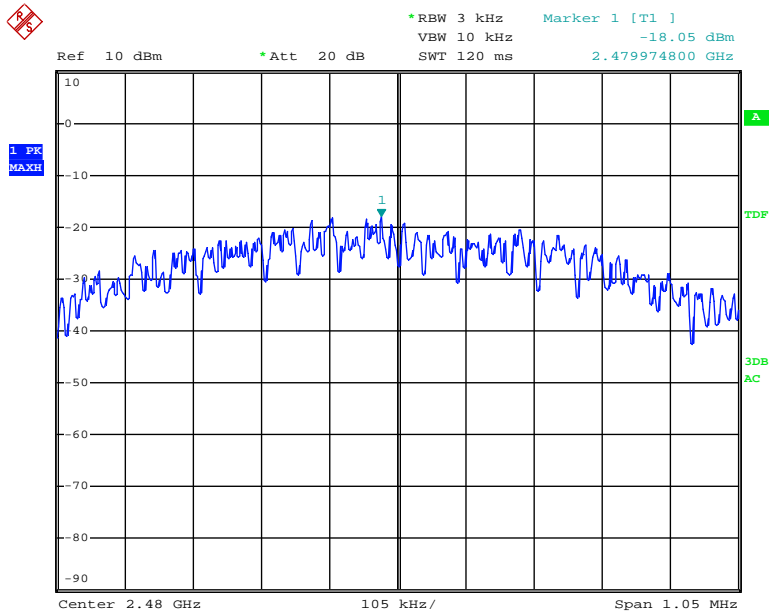

Date: 25.APR.2015 10:58:47

9. Band Edge Test

9.1 Measurement Procedure

(A) Conducted method:

- The transmitter output is connected to a spectrum analyzer. The resolution bandwidth is set to 100KHz. The video bandwidth is set to 300KHz.
- The spectrum from 30MHz to 26 GHz is investigated with the transmitter set to the lowest, middle, and highest channels.
- Preliminary tests on individual chains, and on all chains with a combiner, were performed. The worst-case configuration was with a combiner, therefore final test were preformed with all chains feeding a combiner.

(B) Radiated method:

- The EUT was Operating in hopping mode or could be controlled its channel. Printed out test result from the spectrum by hard copy function.
- The EUT was placed on a turn table which is 0.8m above ground plane.
- Maximum procedure was performed on the six highest emissions to ensure EUT compliance.
- And also, each emission was to be maximized by changing the polarization of receiving antenna both horizontal and vertical.
- Repeat above procedures until all frequency measured were complete.

(Peak measurement: Peak detector, RBW=1MHz, VBW=3MHz, Sweep=Auto)

(Average measurement: Peak detector, RBW=1MHz, VBW=10Hz, Sweep=Auto)

9.2 Test SET-UP (Block Diagram of Configuration)

Conducted method:

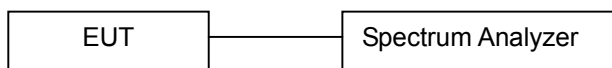

Radiated method:

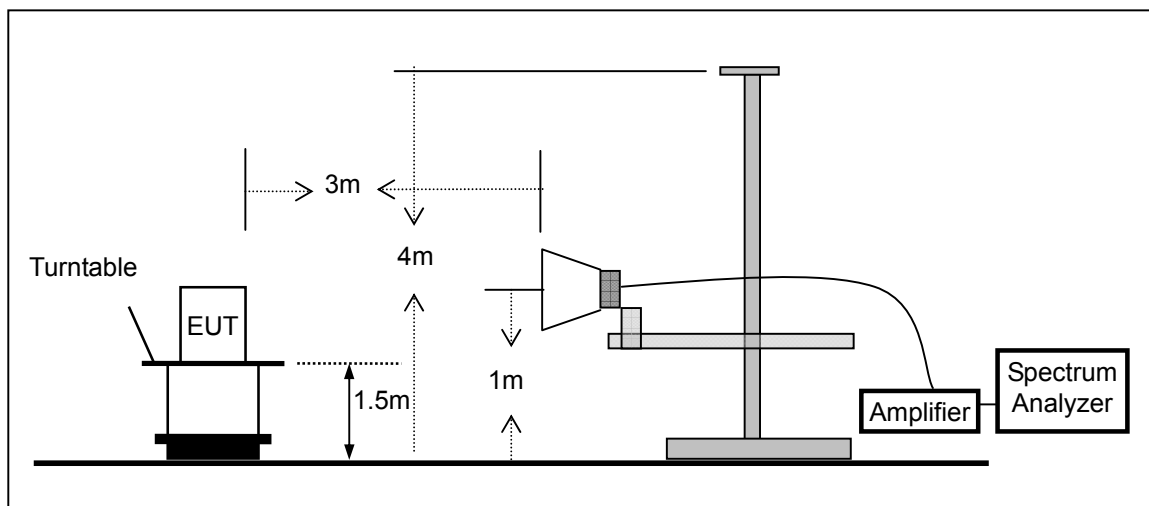

9.3 Measurement Equipment Used

Conducted method: Same as 6.3 Channel Separation Measurement.
Radiated method: Same as 5.3 Radiated Emission Measurement.

9.4 Measurement Results

Pass
Refer to attached data chart.

(A) Conducted method:

Spectrum Detector:	PK	Test Date :	04/25/2015
Test By:	Kuki	Temperature :	20 °C
Test Result:	Pass	Humidity :	54 %

Frequency (MHz)	Peak Power Output(dBm)	Emission read Value(dBm)	Result of Band edge(dBc)	Band edge Limit(dBc)
2399.72	-2.28	-54.08	51.8	>20dBc
2483.64	-3.15	-55.29	52.14	>20dBc

Test Plot:

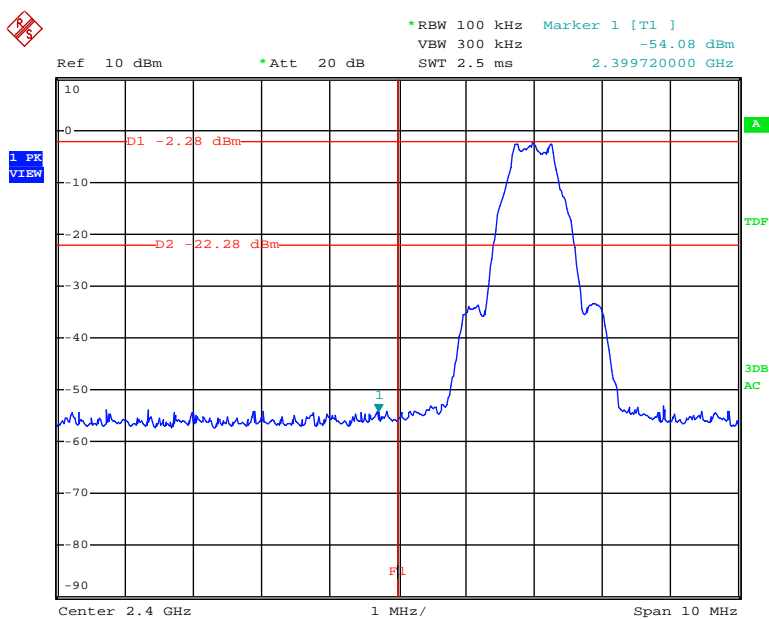

Date: 25.APR.2015 11:06:49

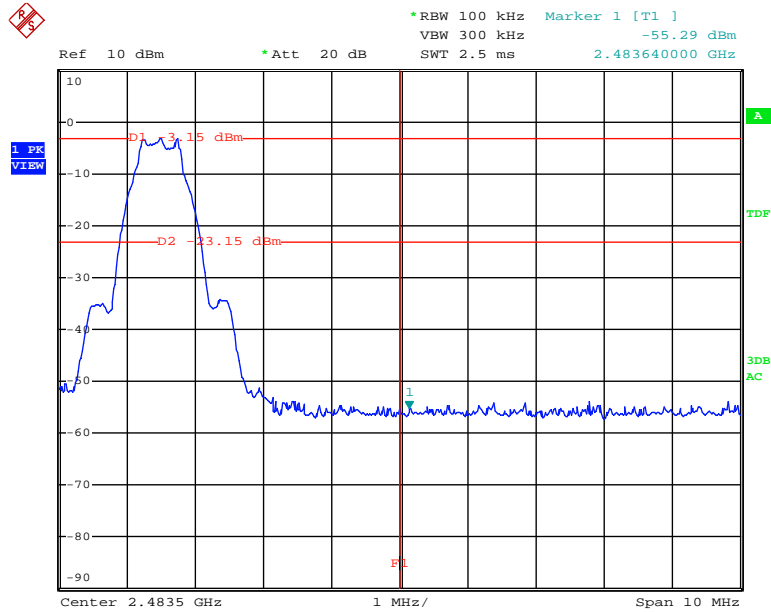

Date: 25.APR.2015 11:10:18

(B) Radiated method:

Frequency (MHz)	Antenna polarization (H/V)	Emission (dBuV/m)		Band edge Limit (dBuV/m)		Margin (dB)	
		PK	AV	PK	AV	PK	AV
2400.00	H	54.8	46.7	74.0	54.0	-19.2	-7.3
2400.00	V	55.5	47.6	74.0	54.0	-18.5	-6.4
2483.50	H	47.4	36.0	74.0	54.0	-26.6	-18.0
2483.50	V	48.7	36.8	74.0	54.0	-25.3	-17.2

10. Antenna Application

10.1 Antenna requirement

The EUT'S antenna is met the requirement of FCC part 15C section 15.203 and 15.240.

FCC part 15C section 15.247 requirements:

Systems operating in the 2402-2480MHz band that are used exclusively for fixed, point-to-point operations may employ transmitting antennas with directional gain greater than 6dBi provided the maximum peak output power of the intentional radiator is reduced by 1dB for every 3dB that the directional gain of the antenna exceeds 6dBi.

10.2 Result

The EUT's antenna used a Internal antenna, The antenna's gain is 4 dBi and meets the requirement

---The End---