

Wireless and batteryless lighting control

0 677 23L/73L/79L

0 770 53L - 6 000 83L

5 742 10/39/55 - 5 743 24

7 418 13L/43L/73L



Requires to install the connected starter pack and one or more «... with Netatmo» connected switch, micromodule or socket outlet.

Module Control

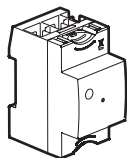

Or

Gateway power outlet and home/
away wireless master switch

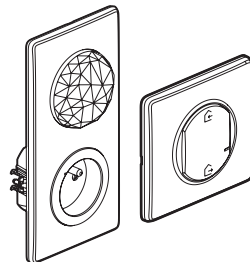

Pack contents:

Wireless, batteryless
lighting control

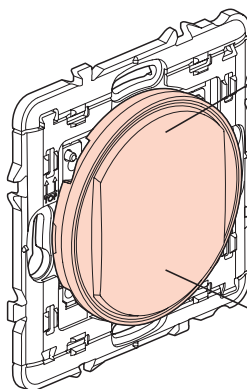
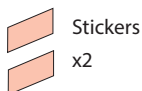

ON/OFF
(2 short pushes --> OFF)

ON/OFF
(2 short pushes --> OFF)

Frequency bands: 2.4 - 2.4835 GHz
Power level: < 100 mW

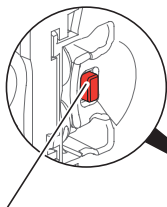

Setup button

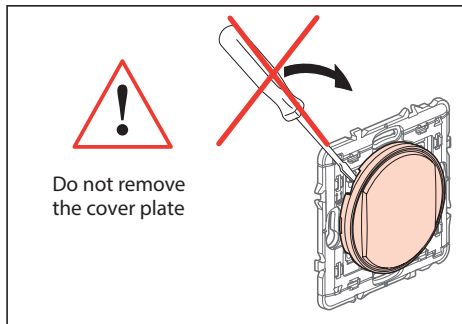
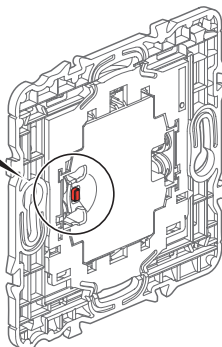

Do not remove
the cover plate

① Start the configuration

Press the configuration button of Module Control or press the middle of the wireless master switch until its light briefly turns green, and then stop pressing. All wired products lights will turn green.

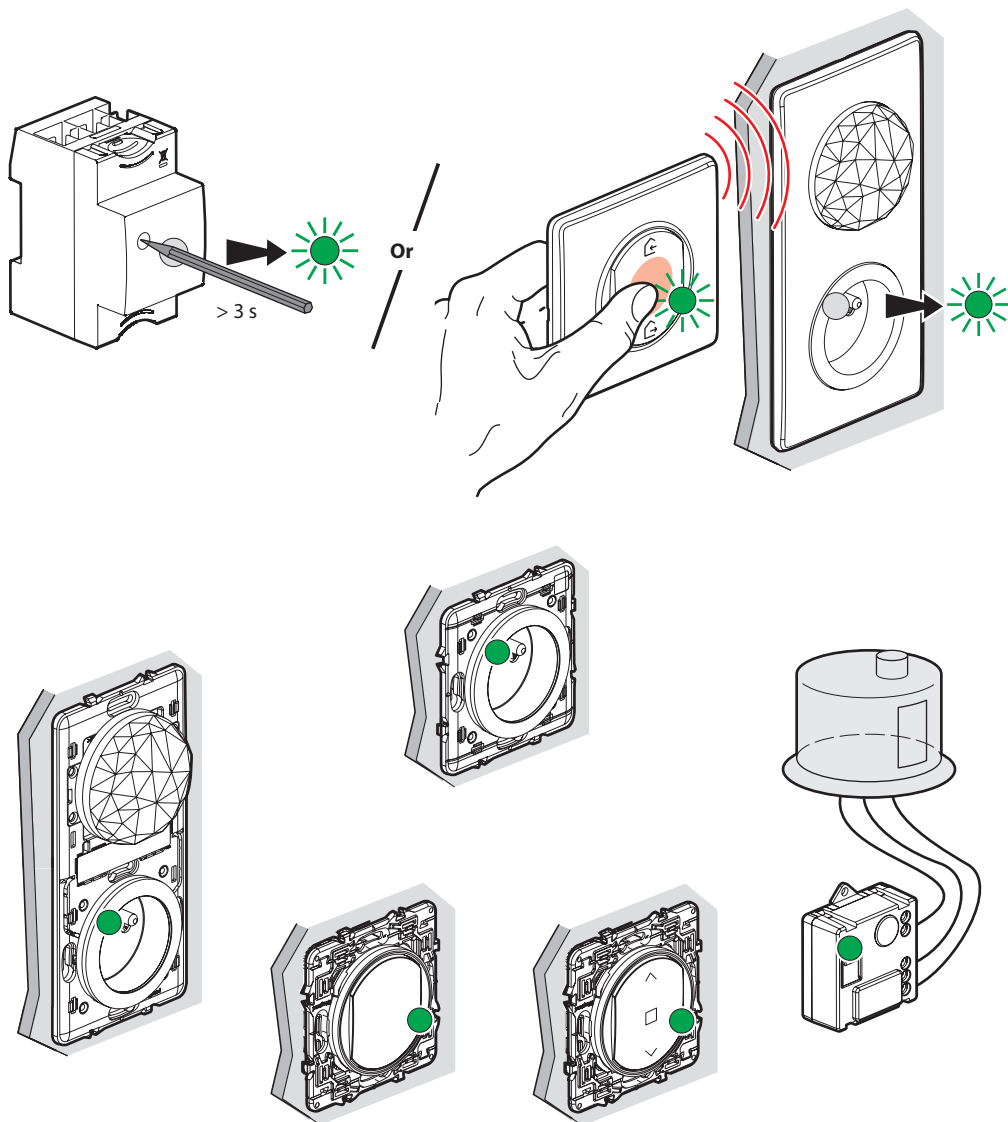

② Pair the wireless, batteryless switch to control the connected products (switch, micromodule, socket-outlet, latching relay).

 Make sure that the indicator lights on the wired products are green and not flashing. If not, go back to precedent step. ①.

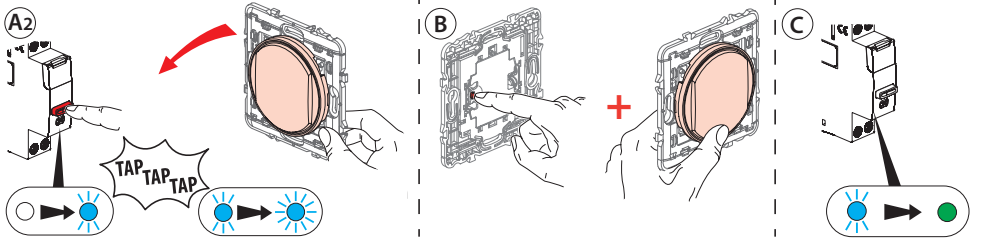
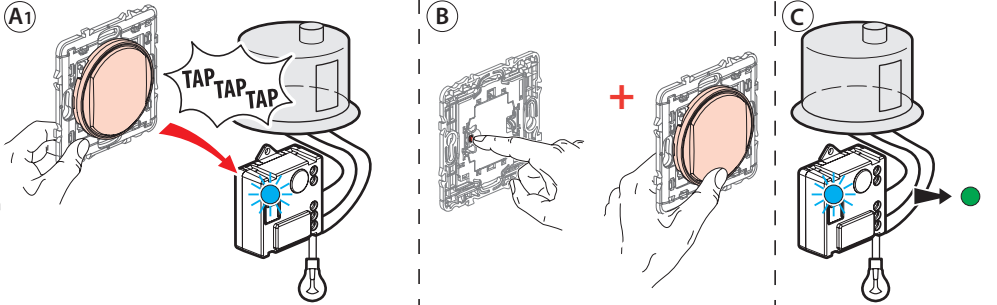
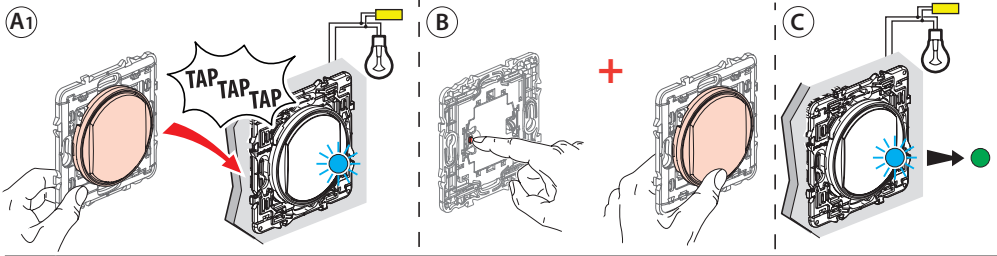

- A1** Tap 3 times the product to be controlled with the wireless, batteryless control. The light of the product to control flashes rapidly.
- A2** For the specific case of the latching relay, press the main button of the latching relay until the configuration indicator flashes slowly in blue, release it then tap the wired product you want to control 3 times with the wireless, batteryless control. The indicator light of the product to be controlled flashes rapidly.
- B** While holding the "setup" button on the wireless, batteryless control, briefly press the "ON" or "OFF" button on the wireless batteryless control.
- C** The indicator light of the product to control will briefly turn blue, and then will turn green again. The pairing was successful.

Check the correct pairing by pressing ON/OFF buttons

Multiple pairing: You can control several switches with the same wireless, batteryless switch by repeating the operation for each product that you want to control.

3 Complete the installation

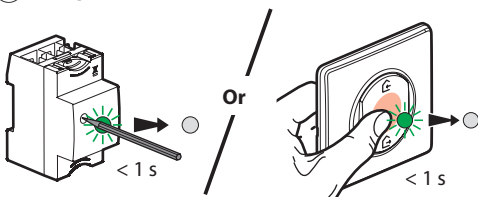

To complete your installation, **briefly** press the configuration of the **Module Control** or the middle of the **wireless Home / Away master switch**.

All the indicator lights on the products switch off

If necessary, erase the configuration of the wireless batteryless control (factory reset)

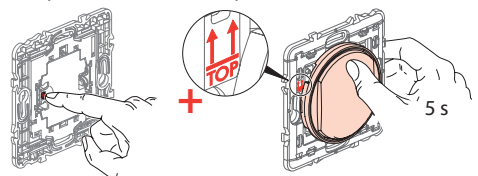

While holding the "setup" button on the wireless, batteryless control, press the upper button for 5 seconds.

Confirm that your control is correctly reset by making an ON command, then OFF

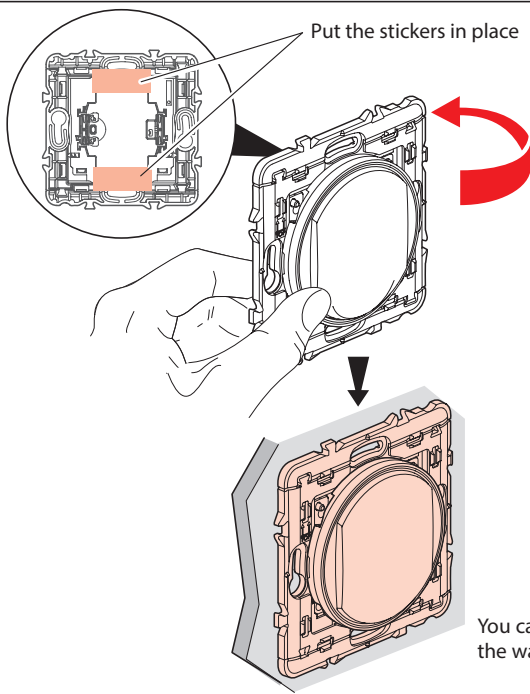

Put the stickers in place

 Before fixing the wireless control(s) with the removable stickers provided, test one on a non-visible area of the wall.

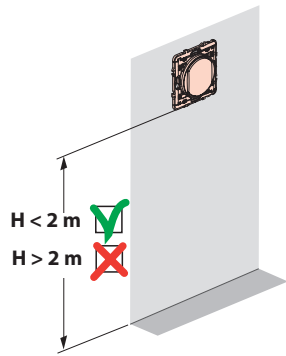

You can also fix the wireless control(s) permanently to the wall with screws.



www.legrandoc.com/067723L

LEGRAND - Pro and Consumer Service - BP 30076
87002 LIMOGES CEDEX FRANCE • www.legrand.com

The undersigned, Legrand declares that the radio-electric equipment type (0 677 23L/73L/79L - 0 770 53L - 6 000 83L - 5 742 10/39/55 - 5 743 24 - 7 418 13L/43L/73L) complies with directive 2014/53/EU. The full text of the EU declaration of conformity is available on the following website:
www.legrandoc.com

Download the app

Your installation is ready. You can download the **Legrand Home + Control** application to control your lights remotely.

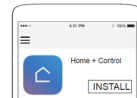

FCC ID: 2ACN8-ZLGP1X

IC: 12132A-ZLGP1X

Model : ZLGP17

This device contains licence-exempt transmitter(s)/receiver(s) that comply with FCC RF and Innovation, Science and Economic Development Canada's licence-exempt RSS(s). Operation is subject to the following two conditions: (1) this device may not cause interference, and (2) This device must accept any interference, including interference that may cause undesired operation of the device.

This device complies with FCC and ISED radiation exposure limits set forth for general population. This device must not be co-located or operating in conjunction with any other antenna or transmitter.

FCC Caution: the user that changes or modifications not expressly approved by the party responsible for compliance could void the user's authority to operate the equipment.

FCC NOTE: This equipment has been tested and found to comply with the limits for a Class B digital device, pursuant to part 15 of the FCC Rules. These limits are designed to provide reasonable protection against harmful interference in a residential installation. This equipment generates, uses and can radiate radio frequency energy and, if not installed and used in accordance with the instruction, may cause harmful interference to radio communications. However, there is no guarantee that interference will not occur in a particular installation. If this equipment does cause harmful interference to radio or television reception which can be determined by turning the equipment off and on, the user is encouraged to try to correct interference by one or more of the following measures:

- Reorient or relocate the receiving antenna.
- Increase the separation between the equipment and receiver.
- Connect the equipment into an outlet on circuit different from that to which the receiver is connected.
- Consult the dealer or an experienced radio/TV technician for help.

 **Safety instructions**

Make sure the power supply is disconnected before any intervention.
Strictly comply with instructions for installation and use.



 **green power**
certified by zigbee alliance
Model: ZLGP17