

QUICK START GUIDE

KIT CONTENT **Li-On Battery Operated Wireless Network Camera AWFB17R**

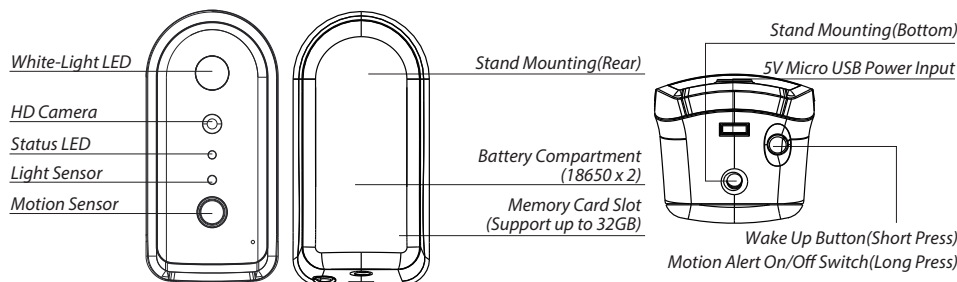
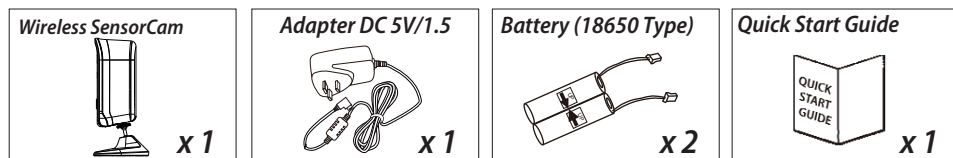

To Activate Motion Alert: Long press for 5 sec until Red LED blink once
To Deactivate Motion Alert: Long press for 5 sec until Blue LED blink once

⚠ IMPORTANT

Please Notice Below Before You Setup The SensorCam:

- SensorCam offers public cloud storage function, to use this function please have Google Drive or Dropbox account information ready.
- After initial setup, please charge the camera for 4 to 6 hours before going completely wireless. Once the camera is fully charged, user will receive push notification.
- You can search the "OMGuard HD" APP on the APP Store or Google Play Store. Or scan the QR code.



For iOS



For Android

- Make sure your device is connecting to Wi-Fi network.
- For maximum performance, please only use Class 10 rated SD card. Camera will not function without SD card inserted.
- Please make sure to unbind your cloud storage account before transferring ownership of the camera.

SETUP THE SENSORCAM

A. MicroSD Card/Battery Installation

(A1) Remove the battery compartment cover to insert MicroSD card. Follow the steps below to insert the MicroSD card.

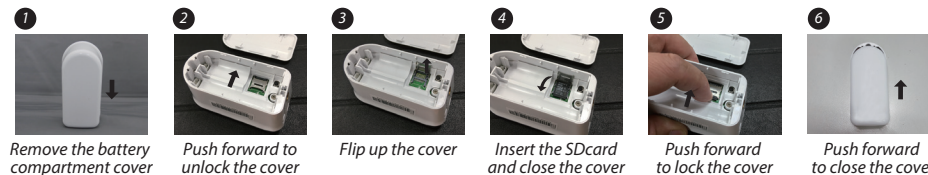

(A2) Insert two 18650 batteries and connect the wires. Then the camera will power up that status LED will flash red/blue (continue to Section B - Wi-Fi Network Setup). Make sure the battery cables are firmly connected to the camera, or press and hold the reset button until the status LED flashes red/blue.

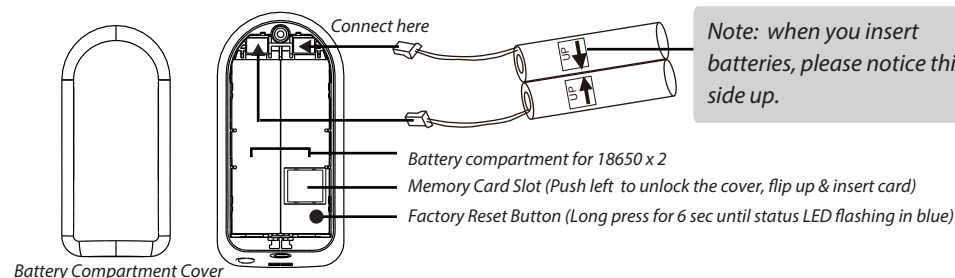

B. Wi-Fi Network Setup

- (B1) Launch SensorCam app and tap
- (B2) Scan the barcode label on the back of the camera to bring up the DID information, or manually type in the DID, including the dashes.



Barcode label: COXX-123456-ABCDE

Default PW: 123456
Wi-Fi Pairing Mode:
SSID: SensorCam-123456
Default PW: 12345678

- (B3) Name your camera (max. 20 characters).
- (B4) Enter default security code: 123456.
- (B5) Tap to save information and follow the in-app wizard to complete the setup process.

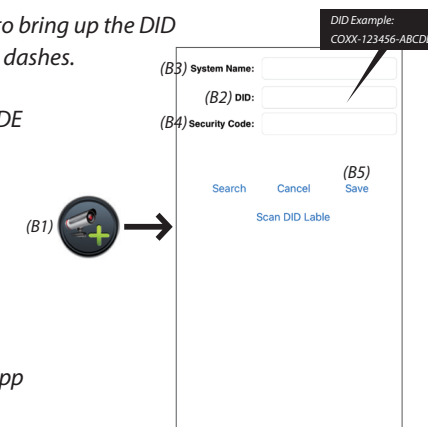

CAMERA INSTALLATION

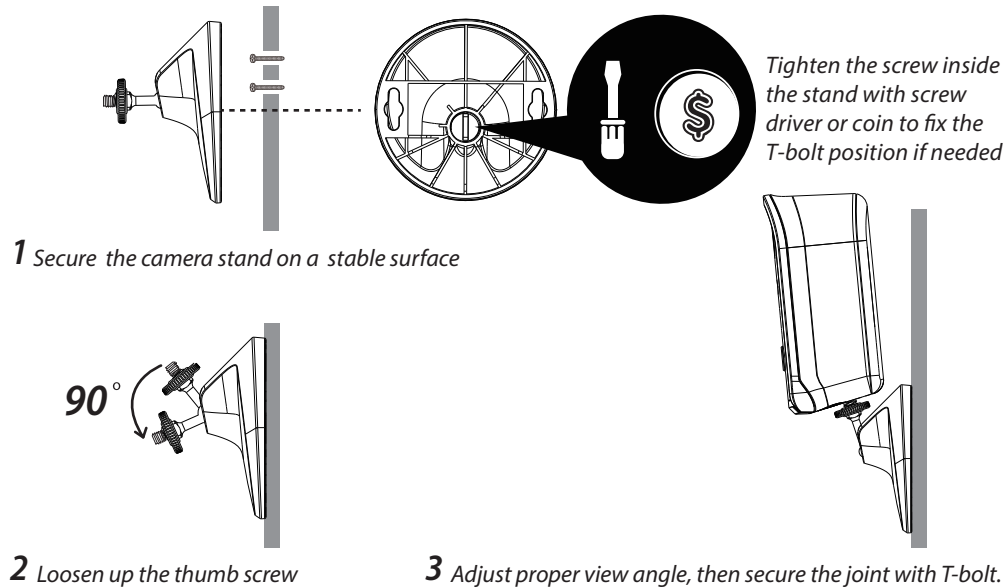

BASIC CAMERA OPERATION

From camera list section, tap the camera for live video.

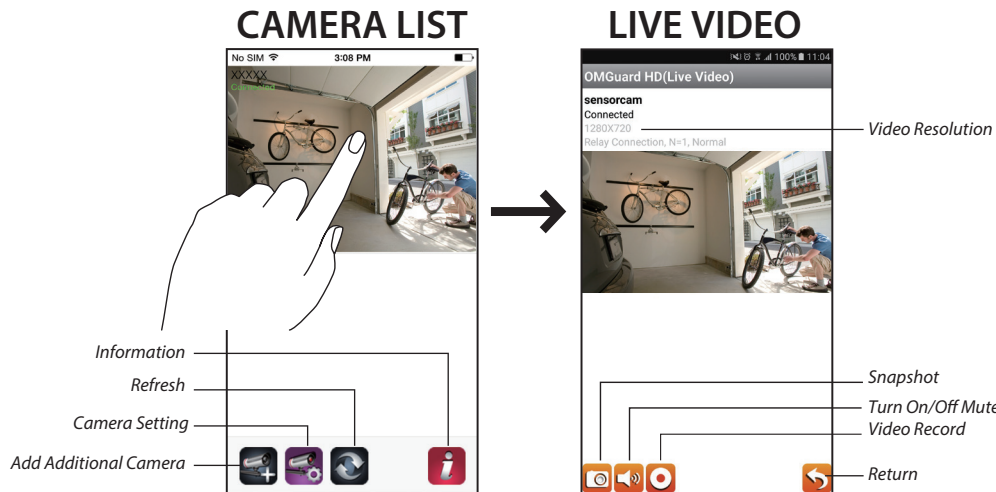

Follow the steps below for Event Playback.

1. Tap and then the .
2. Select the time interval for the event list.
3. Tap to select the file for playback.
4. If you want to store the files in mobile device, tap to download the file (Best while under Wi-Fi environment due to larger high definition data size).

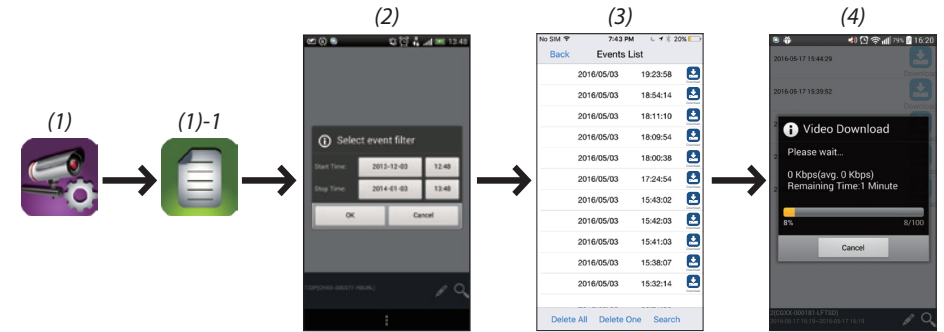

MOTION DETECTION / CAMERA SETTING TIPS

For optimum detection, we suggest the camera is to be mounted 6.6 feet (2 meters) from the floor, and:

- On a rigid vibration-free surface.
- So the expected movement of an intruder is across the fields of the detection pattern.

To avoid false alerts, please note this device is equipped with a PIR Motion Sensor that operates by detecting temperature changes in the area in front of the device; Please avoid placing the device under the following environments:

- (1) Aiming the camera at windows or glass doors.
- (2) Where small animals may enter the detection area.
- (3) Where a heat source (sunlight, incandescent light, car headlights, etc) may affect the motion sensor.
- (4) Where sudden temperature changes inside or around the detection area caused by hot or cold wind (fans, air conditioners, etc.).

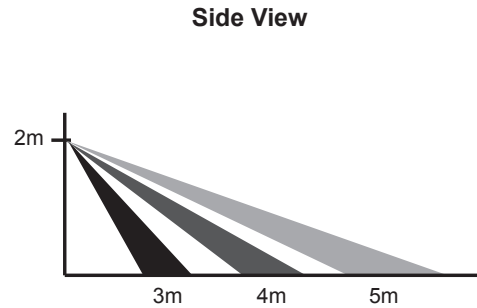
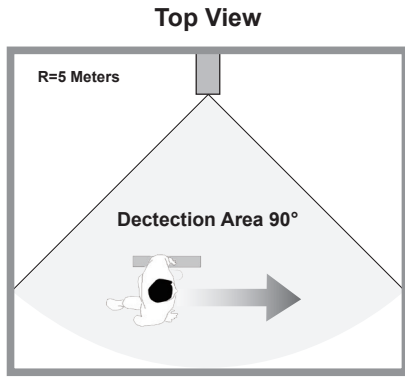

Please note this camera supports operation using both batteries (18650 rechargeable type) and external DC power via 5V USB port; however, there are certain function limitation when device is using batteries:

*Once the camera is in sleep mode; the user can no longer access it from mobile device.

The camera will become online when the motion detector has detected an event, or pressing the power button of the camera.

Device will return to sleep mode after:

The camera cannot secure Wi-Fi connection with the router after trigger event. Depending on the sleep timer setting (30s, 60s, 90s, 120s), the camera will enter and still attempt to establish connection with router during the countdown. If the camera is able to establish connection, the camera will enter sleep mode after data transfer (to cloud) completes.

How to Maximize Battery Power:

We suggest using the following setting to maximize battery power

- Install the camera where it can receive excellent Wi-Fi network signals (Weak Wi-Fi signal will force camera to operate with higher Wi-Fi Power, which may consume more power).
- Set auto sleep timer to 30 seconds.
- Place the camera in a brighter lighting environment and turn off night vision.
- Do not stay in live view or system setting mode unless it's necessary.

Changes or modifications not expressly approved by the party responsible for compliance could void the user's authority to operate the equipment.

This equipment has been tested and found to comply with the limits for a Class B digital device, pursuant to Part 15 of the FCC Rules. These limits are designed to provide reasonable protection against harmful interference in a residential installation.

This equipment generates uses and can radiate radio frequency energy and, if not installed and used in accordance with the instructions, may cause harmful interference to radio communications. However, there is no guarantee that interference will not occur in a particular installation. If this equipment does cause harmful interference to radio or television reception, which can be determined by turning the equipment off and on, the user is encouraged to try to correct the interference by one or more of the following measures:

- Reorient or relocate the receiving antenna.
- Increase the separation between the equipment and receiver.
- Connect the equipment into an outlet on a circuit different from that to which the receiver is connected.
- Consult the dealer or an experienced radio/TV technician for help

This device complies with part 15 of the FCC rules. Operation is subject to the following two conditions (1) this device may not cause harmful interference, and (2) this device must accept any interference received, including interference that may cause undesired operation.

This product is used and operated with a minimum distance of 20 cm between the radiator and user body.



Products with CE Marking comply with EMC Directive (2014/30/EU); Low Voltage Directive (2014/35/EU); RED (2014/53/EU); ROHS Directive (2011/65/EU) issued by the Commission of the European Community. Compliance with these directives implies conformity to the following European Norms:

EMC: EN 301 489
LVD: EN 60950
Radio: EN 300 328



If the camera system no longer functions or can no longer be repaired, it must be disposed of according to the valid statutory regulations.

Disposal of spent batteries/accumulators:

You are required by law (Battery Ordinance) to return all spent batteries and accumulators. Disposing of spent batteries/accumulators with common household waste is prohibited! Batteries/accumulators that contain hazardous substances are marked with the symbols on the side. These symbols indicate that it is prohibited to dispose of these batteries/accumulators in the household waste. The abbreviations for the respective heavy metals are: Cd=cadmium, Hg=mercury, Pb=lead. You can return spent batteries and accumulators that can no longer be charged to the designated collection points in your community, outlets or wherever batteries or accumulators are sold. Following these instructions will allow you to fulfill the legal requirements and contribute to the protection of our environment!

Write down your password below:

Log in password:

.....

Admin password:

.....

Wi-Fi password:

.....

Cloud password:

.....

Google drive password:

.....

Important: Please read following notes

1. Follow the instruction below to install batteries:

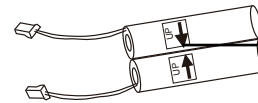

Note: when you insert batteries, please notice this side up.

2. Insert the SD card before setting up the camera to enable cloud services.
3. The recorded files have stored on your Google drive/Dropbox. All time live video is not available under battery mode.
4. Create a Google drive or a Dropbox account before setting up the camera.
5. Please unbind your cloud storage account before transferring the camera to others.
6. Enable motion alert: Long press for 5 sec until Red LED blink once.
Disable motion alert: Long press for 5 sec until Blue LED blink once.
7. Set up the camera by using a USB power cable supplied until the camera setting is done.