

# Cameron

## Outdoor HD Camera

# Cameron

SIMPLE WIRELESS SOLUTIONS

Model AMZ10W

Made in China. Distributed by Atoms Labs LLC

©2020 Atoms Labs LLC, Flower Mound, TX. All rights reserved. App Store logo is a registered trademark of Apple, Inc. Google Play logo is a registered trademark of Google, Inc. Amazon Appstore logo is a registered trademark of Amazon. Certain other product names, brand names, and company names may be trademarks or designations of their respective owners.

FCC Compliance Statement: This device complies with Part 15 of the FCC rules. Operation is subjected to the following two conditions: (1) this device may not cause harmful interference, and (2) this device must accept any interference received, including interference that may cause undesired operation.

**meet Cameron**  
Cameron sees EVERYTHING in range of your indoor or outdoor space, even when you can't. Alerts to your smartphone or tablet are sent when activity is detected. So you never have to worry when Cameron is on patrol.

[CameronCameras.com](http://CameronCameras.com)

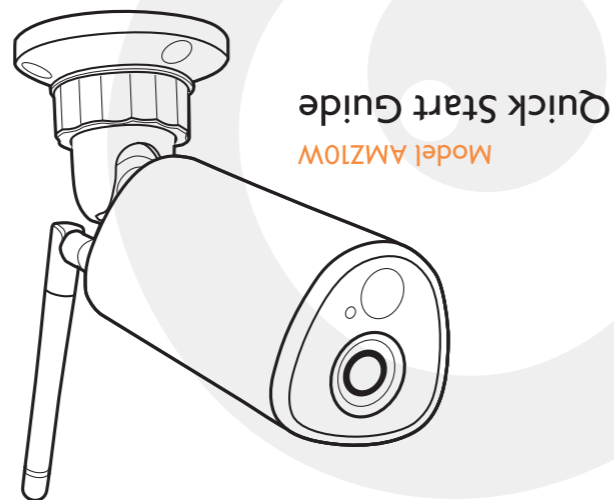

## Getting Started

### In the Box

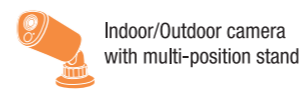

Indoor/Outdoor camera with multi-position stand



Antenna



AC Power Adapter



Screws and Anchor Kit



Power Extension Cable



Quick Start Guide

**What You Will Need:** Philips Screwdriver, access to circuit breaker, 2.4GHz Wi-Fi network, network name and password.

### Hmmm... where should I position Cameron?

Knowing where to place your pan 'n tilt camera is very important for optimal surveillance

#### When Considering Locations

**DO**

- Position in vulnerable areas such as:
  - Front Door
  - Back & Side Doors
  - Garage & Driveway
  - Interior Common Areas

**DON'T**

- Position camera in ways that violate your neighbor's privacy
- Install in areas inside where there is a warranted expectation of privacy, such as bedrooms and bathrooms

#### For Outdoor Installation

**DO**

- Install camera 8-10 feet from the ground
- Protect Camera from direct exposure to the elements

**DON'T**

- Point camera directly at the sun, it causes glares and high contrast
- Position camera where rain gutters, trees and heavy foliage can obstruct views

#### For Indoor Installation

**DO**

- Take advantage of corners to provide largest possible vantage point
- Angle for indirect light

**DON'T**

- Position camera directly toward light sources
- Point camera directly at windows as it can cause reflection issues

### Product Details

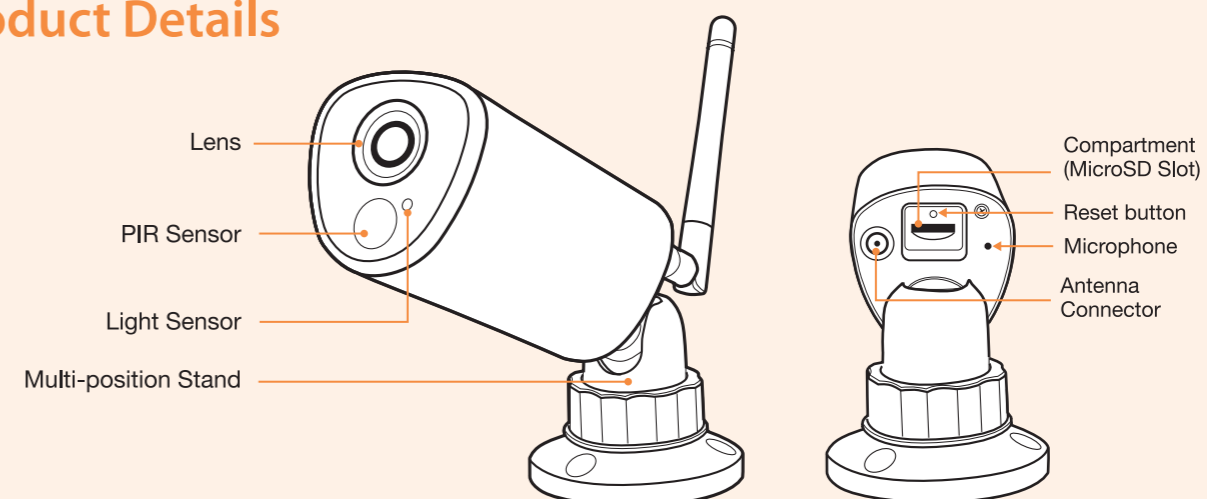

- 1 Device Setup** Download the **Cam Sees** App and open it. Use the Set Up Wizard to connect to your Wi-Fi network and follow the steps to finish installation.

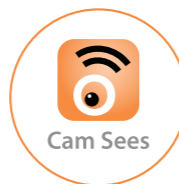

FREE APP  
DOWNLOAD

available at  
amazon appstore

Download on the  
App Store

GET IT ON  
Google Play

**TIP:**

It is highly recommended to set up your camera to Wi-Fi before installing it in its final location. After camera is successfully connected to Wi-Fi, (1) unplug camera power, (2) mount camera using multi-position bracket, (3) screw in antenna and (4) plug back in to power. Camera will power on and still be connected to Wi-Fi.

### App Download & Wi-Fi Connection

- A** From your smart device or tablet, DOWNLOAD and INSTALL the free **Cam Sees App**.

- B** Add antenna and plug camera into an electrical outlet (allow the camera up to 90 seconds to start up).

- C** Now, LAUNCH the Cam Sees App and the Setup Wizard will appear.

- D** Tap to start the Wizard and then tap **Add Device**.

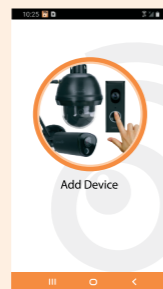

- E** Tap **New Device** and the unit will start searching.

**NOTE:** If the mobile device's Bluetooth is not turned on, a message will appear requesting to have the Bluetooth setting turned on.

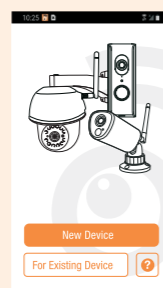

- F** Select **your home network** from the menu, and then enter your home network's Wireless Password. If you get an error, make sure to enter the correct password and repeat.

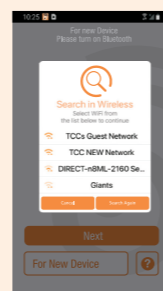

- G** At the next screen enter a **New Password/Security Code** twice. Tap **SAVE**.

**TIP:** Remember to write down your new password and save it somewhere safe and easy for you to access.

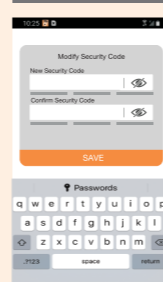

- H** Tap the **PLAY** icon or preview picture for live video.

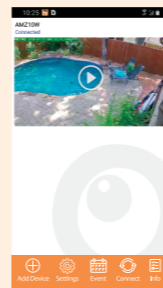

- 2** Screw the Antenna clockwise into the rear of the camera.

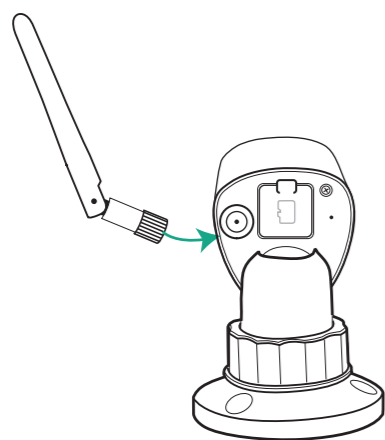

- 3** Secure the multi-position Camera Stand to a stable surface or wall using the three screws. If needed, three anchors are also included. **It should be look'in good.**

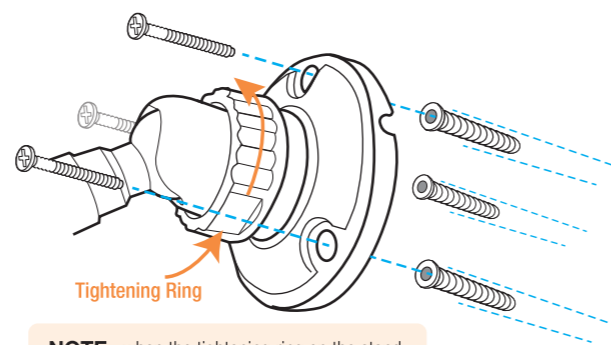

**NOTE:** when the tightening ring on the stand is loosened, the multi-position ball can pivot and rotate freely. Tighten when in desired position.

- 4** Connect the small end of the AC adapter to the camera's AC-in Plug located at the end of the bracket. **You're almost there.**

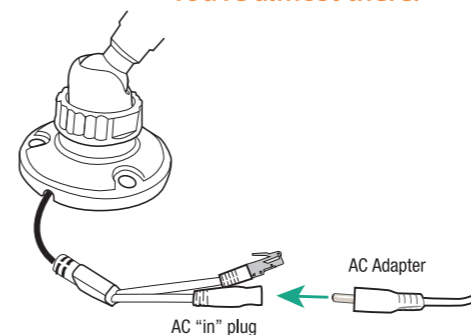

- 5** Plug into electrical outlet when ready to install Cam Sees App.

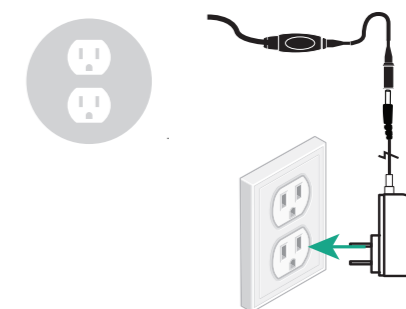

**TIP:** A 6 foot power extension cable is included for your camera setup if needed.

- 6** To record videos you must insert a microSD card, not included. The microSD slot is located under the flap on the rear of the camera.

**NOTE:** A Class 10 microSD card is required. This camera supports up to 128GB microSD card.

**CLOUD:** When an SD card is inserted and the Cloud option is activated (in Advanced Settings), recorded videos will automatically be transferred onto the cloud, i.e. Google Drive.

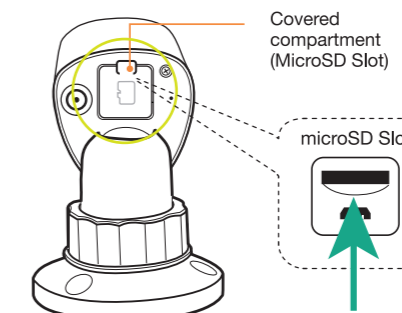

microSD card (not included). It is required for recording videos.

### Good stuff to know

- Tap **Snapshot** icon to save image to camera roll or gallery

- Tap to turn **volume ON** or OFF in Live View Mode

- Tap to **Record** to MicroSD card (pre-installed)

- Smart motion detection** push notification alerts

- Tap **Settings** icon from home page to access Advanced Settings and Customizing Features.

- Tap to **RETURN** icon to go back to main page

The default admin password is **123456**

- Tap to **EVENT** icon to review recorded files.

**NOTE:** To reset the camera back to factory default, use a paper clip to press and hold the Reset button for ~10 seconds. Reset button is located above the microSD card slot.

**NOTE:** Screen shots and icons may vary due to continuous updates to App and software development.

**CAUTION:** Do not submerge camera in water. **STRANGULATION HAZARD:** Infants have strangled in power cords. Keep power cords more than 3 feet away from cribs. When using your equipment, always follow basic safety precautions to reduce the risk of fire, electric shock and injury to persons. Illustrations are for reference only. Actual product specifications may vary.

For additional precautions and product information, please see owner's manual at [CameronCameras.com](http://CameronCameras.com)

FCC Compliance Statement: This device complies with Part 15 of the FCC rules. Operation is subjected to the following two conditions: (1) this device may not cause harmful interference, and (2) this device must accept any interference received, including interference that may cause undesired operation.

# Cameron

For detailed installation and setup, please refer to the Model AMZ10W complete User's Guide available on our website.

**Cameron Cares**

If you need assistance, please contact  
**CUSTOMER SUPPORT**  
at **1-800-275-9381**  
or email [info@cameronecameras.com](mailto:info@cameronecameras.com)



[CameronCameras.com](http://CameronCameras.com)

#### FCC Warning

This device complies with part 15 of the FCC rules. Operation is subject to the following two conditions: (1) this device may not cause harmful interference, and (2) this device must accept any interference received, including interference that may cause undesired operation.

Changes or modifications not expressly approved by the party responsible for compliance could void the user's authority to operate the equipment.

NOTE: This equipment has been tested and found to comply with the limits for a Class B digital device, pursuant to part 15 of the FCC Rules. These limits are designed to provide reasonable protection against harmful interference in a residential installation. This equipment generates uses and can radiate radio frequency energy and, if not installed and used in accordance with the instructions, may cause harmful interference to radio communications. However, there is no guarantee that interference will not occur in a particular installation. If this equipment does cause harmful interference to radio or television reception, which can be determined by turning the equipment off and on, the user is encouraged to try to correct the interference by one or more of the following measures:

- Reorient or relocate the receiving antenna.
- Increase the separation between the equipment and receiver.
- Connect the equipment into an outlet on a circuit different from that to which the receiver is connected.
- Consult the dealer or an experienced radio/TV technician for help.

#### Radiation Exposure Statement

This equipment complies with FCC radiation exposure limits set forth for an uncontrolled environment. This equipment should be installed and operated with minimum distance 20cm between the radiator and your body.