



FCC 47 CFR PART 15 SUBPART C

TEST REPORT

FOR

Embedded computer / module

Model : EC3100, SBC3100, H310, H330, D120

Trade Name: N/A

Issued to

IC NEXUS CO., LTD.

6F-1, No. 3-2 Park Street, Nan-Kang Dist., Taipei, Taiwan Post Code: 11503

Issued by

WH Technology Corp.



EMC Test Site	Xizhi Office and Lab	7F., No.262, Sec. 3, Datong Rd., Xizhi Dist., New Taipei City 221, Taiwan (R.O.C.)
----------------------	-----------------------------	---

Note: This test refers exclusively to the test presented test model and sample. This report shall not be reproduced except in full, without the written approval of WH Technology Corp. This document may be altered or revised by WH Technology Corp. Personnel only, and shall be noted in the revision section of the document.



TABLE OF CONTENTS----- 2

- 1. GENERAL INFORMATION ----- 3**
 - 1.1 DESCRIPTION OF THE TESTED SAMPLES----- 4
 - 1.2 SUMMARY OF TEST RESULTS----- 5
- 2. TEST METHODOLOGY ----- 6**
 - 2.1 GENERAL TEST PROCEDURES ----- 6
 - 2.2 FCC PART 15.205 RESTRICTED BANDS OF OPERATIONS ----- 7
 - 2.3 DESCRIPTION OF TEST MODES ----- 7
 - 2.4 DESCRIPTION OF THE SUPPORT EQUIPMENTS ----- 8
- 3. TEST AND MEASUREMENT EQUIPMENT -----10**
 - 3.1 CALIBRATION-----10
 - 3.2 EQUIPMENT -----10
- 4. SECTION 15.203 ANTENNA REQUIREMENTS-----12**
 - 4.1 STANDARD APPLICABLE -----12
 - 4.2 ANTENNA CONSTRUCTION AND DIRECTIONAL GAIN -----12
- 5. SECTION 15.249 REQUIREMENTS (FUNDAMENTAL/ HARMONICS) -----13**
 - 5.1 TEST SETUP -----13
 - 5.2 LIMIT-----13
 - 5.3 RESULT: PASSED-----13
 - 5.4 TEST DATA -----14
- 6. SECTION 15.205 REQUIREMENTS (BAND EDGE) -----19**
 - 6.1 TEST SETUP -----19
 - 6.2 LIMIT-----19
 - 6.3 RESULT: PASSED-----19
 - 6.4 TEST DATA -----20
- 7. SECTION 15.209 REQUIREMENTS (GENERAL RADIATED EMISSION) -----23**
 - 7.1 TEST SETUP -----23
 - 7.2 LIMIT-----24
 - 7.3 TEST PROCEDURE -----24
 - 7.4 RESULT: PASSED-----24
 - 7.5 TEST DATA -----24
- 8. SECTION 15.207 REQUIREMENTS (POWERLINE CONDUCTED EMISSIONS)-----28**
 - 8.1 TEST SETUP -----28
 - 8.2 LIMIT-----28
 - 8.3 TEST PROCEDURE -----28
 - 8.4 TEST SPECIFICATION -----29
 - 8.5 RESULT: PASSED-----29
 - 8.6 TEST DATA -----30
- 9. SECTION 15.215 REQUIREMENT (20DB BANDWIDTH TEST)-----32**
 - 9.1 TEST SETUP-----32
 - 9.2 TEST PROCEDURE -----32
 - 9.3 RESULT: PASSED-----32
 - 9.4 TEST DATA -----33



1. GENERAL INFORMATION

Applicant : IC NEXUS CO., LTD.
Address : 6F-1, No. 3-2 Park Street, Nan-Kang Dist., Taipei, Taiwan Post Code: 11503
Manufacturer : IC NEXUS CO., LTD.
Address : 6F-1, No. 3-2 Park Street, Nan-Kang Dist., Taipei, Taiwan Post Code: 11503
EUT : Embedded computer / module
Model Name : EC3100, SBC3100, H310, H330, D120
Model Differences : For marketing purpose

Is here with confirmed to comply with the requirements set out in the FCC Rules and Regulations Part 15 Subpart C and the measurement procedures were according to ANSI C63.10:2013. The said equipment in the configuration described in this report shows the maximum emission levels emanating from equipment are within the compliance requirements.

FCC part 15 subpart C

Receipt Date : 11/02/2018

Final Test Date : 01/29/2019

Tested By:

Reviewed by:

Jan. 29, 2019
Date

Bing Chang / Engineer

Jan. 29, 2019
Date

Bell Wei / Manager

Designation Number: TW2954



1.1 DESCRIPTION OF THE TESTED SAMPLES

EUT Name : Embedded computer / module

Model Number : EC3100

FCCID : 2ACLCECNSDSBC310H80

Receipt Date : 11/02/2018

Input Voltage : AC 110V

Power From : Inside Outside
 Adaptor Battery AC Power Source
 DC Power Source Support Unit PC

Operate Frequency : Refer to the channel list as described below (2402~2480MHz)

Modulation Technique : GFSK

Number of Channels : 79

Channel spacing : N/A 1 MHz

Operating Mode : Simplex Half Duplex

Antenna Type : Dipole Antenna

Antenna gain : 2 dBi



Channel	Frequency (MHz)	Channel	Frequency (MHz)	Channel	Frequency (MHz)	Channel	Frequency (MHz)
00	2402	20	2422	40	2442	60	2462
01	2403	21	2423	41	2443	61	2463
02	2404	22	2424	42	2444	62	2464
03	2405	23	2425	43	2445	63	2465
04	2406	24	2426	44	2446	64	2466
05	2407	25	2427	45	2447	65	2467
06	2408	26	2428	46	2448	66	2468
07	2409	27	2429	47	2449	67	2469
08	2410	28	2430	48	2450	68	2470
09	2411	29	2431	49	2451	69	2471
10	2412	30	2432	50	2452	70	2472
11	2413	31	2433	51	2453	71	2473
12	2414	32	2434	52	2454	72	2474
13	2415	33	2435	53	2455	73	2475
14	2416	34	2436	54	2456	74	2476
15	2417	35	2437	55	2457	75	2477
16	2418	36	2438	56	2458	76	2478
17	2419	37	2439	57	2459	77	2479
18	2420	38	2440	58	2460	78	2480
19	2421	39	2441	59	2461	---	---

1.2 SUMMARY OF TEST RESULTS

FCC Rule	Description of Test	Result
15.203	Antenna Requirements	Pass
15.249	. Fundamental/ Harmonics	Pass
15.205	. Band Edge	Pass
15.209	. Radiated Emission	Pass
15.207	. Conducted Emission	Pass
15.215	. 20dB bandwidth test	Pass



2. TEST METHODOLOGY

All testing as described bellowed were performed in accordance with ANSI C63.10:2013 and FCC CFR 47 Part 15 Subpart C.

2.1 GENERAL TEST PROCEDURES

Conducted Emissions

The EUT is placed on a wood table, which is at 0.8 m above ground plane acceding to clause 15.207 and requirements of ANSI C63.10:2013. Conducted emissions from the EUT measured in the frequency range between 0.15 MHz and 30MHz are using CISPR Quasi-Peak / Average detectors.

Radiated Emissions

The EUT is a placed on a turn table, which is 0.8 m above ground plane. The turntable was rotated through 360 degrees to determine the position of maximum emission level. The EUT is placed at 3m away from the receiving antenna, which varied from 1m to 4m to find out the highest emission. Each emission was to be maximized by changing the polarization of receiving antenna both horizontal and vertical.



2.2 FCC PART 15.205 RESTRICTED BANDS OF OPERATIONS

(a) Except as shown in paragraph (d) of this section, only spurious emissions are permitted in any of the frequency bands listed below:

MHz	MHz	MHz	GHz
0.090 - 0.110	16.42 - 16.423	399.9 - 410	4.5 - 5.15
10.495 - 0.505	16.69475 - 16.69525	608 - 614	5.35 - 5.46
2.1735 - 2.1905	16.80425 - 16.80475	960 - 1240	7.25 - 7.75
4.125 - 4.128	25.5 - 25.67	1300 - 1427	8.025 - 8.5
4.17725 - 4.17775	37.5 - 38.25	1435 - 1626.5	9.0 - 9.2
4.20725 - 4.20775	73 - 74.6	1645.5 - 1646.5	9.3 - 9.5
6.215 - 6.218	74.8 - 75.2	1660 - 1710	10.6 - 12.7
6.26775 - 6.26825	108 - 121.94	1718.8 - 1722.2	13.25 - 13.4
6.31175 - 6.31225	123 - 138	2200 - 2300	14.47 - 14.5
8.291 - 8.294	149.9 - 150.05	2310 - 2390	15.35 - 16.2
8.362 - 8.366	156.52475 - 156.52525	2483.5 - 2500	17.7 - 21.4
8.37625 - 8.38675	156.7 - 156.9	2655 - 2900	22.01 - 23.12
8.41425 - 8.41475	162.0125 - 167.17	3260 - 3267	23.6 - 24.0
12.29 - 12.293	167.72 - 173.2	3332 - 3339	31.2 - 31.8
12.51975 - 12.52025	240 - 285	3345.8 - 3358	36.43 ² - 36.5
12.57675 - 12.57725	322 - 335.4	3600 - 4400	(¹)
13.36 - 13.41			

1 Until February 1, 1999, this restricted band shall be 0.490-0.510 MHz.

2 Above 38.6

(b) Except as provided in paragraphs (d) and (e), the field strength of emissions appearing within these frequency bands shall not exceed the limits shown in Section 15.209. At frequencies equal to or less than 1000 MHz, compliance with the limits in Section 15.209 shall be demonstrated using measurement instrumentation employing a CISPR quasi-peak detector. Above 1000 MHz, compliance with the emission limits in Section 15.209 shall be demonstrated based on the average value of the measured emissions. The provisions in Section 15.35 apply to these measurements.

2.3 DESCRIPTION OF TEST MODES

The EUT was tested under following modes:

Modes:

1. Continuous transmitting

Channels:

1. 2.402 GHz (Lowest Channel)
2. 2.441 GHz (Middle Channel)
3. 2.480 GHz (Highest Channel)



2.4 DESCRIPTION OF THE SUPPORT EQUIPMENTS

Setup Diagram

CE

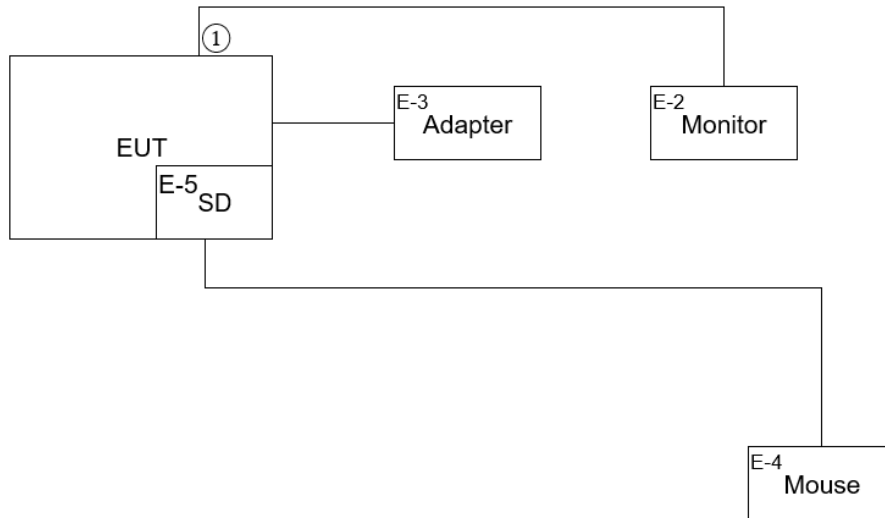

RE

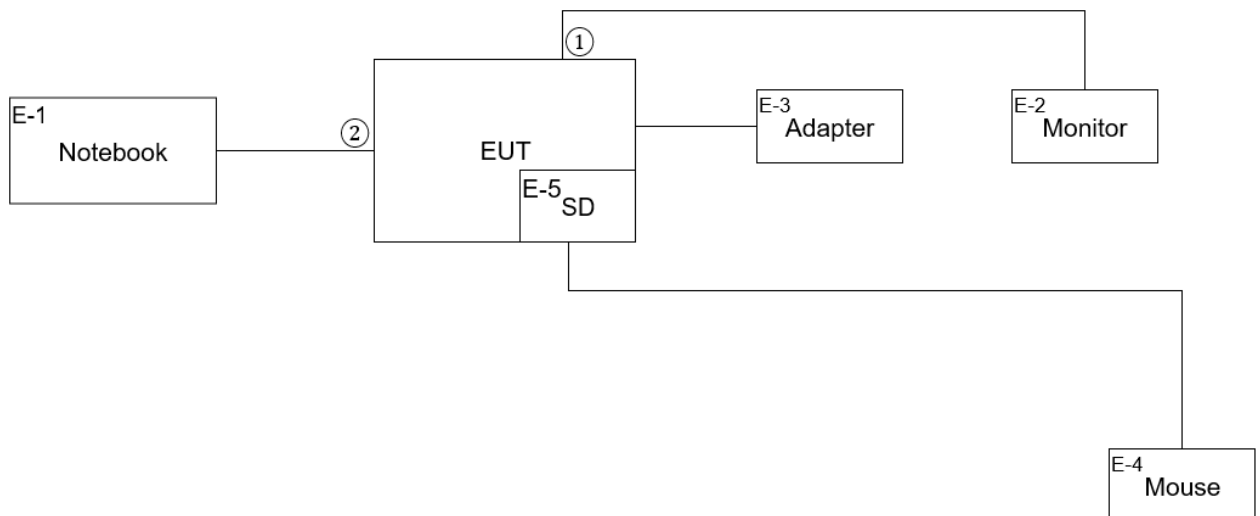



Support Equipment

Peripherals Devices:

OUTSIDE SUPPORT EQUIPMENT							
No.	Equipment	Model	Serial No.	FCC ID/ BSMI ID	Trade name	Data Cable	Power Cord
E-2	Monitor	S2817Qt	NA	R43004	DELL	Shielded 1.8m	Unshielded 1.8m
E-4	Mouse	MS116p	CN-04DW DN-73826 -5CM-012 0	R41108	DELL	Shielded 1.8m / USB	N/A
E-1	Notebook	B470	WB06048 23	R33B65	Lenovo	N/A	Unshielded 1.8m
E-3	Adaptor	LTE-12WS- S2	N/A	N/A	LTE	N/A	N/A
E-5	SD Card	16G	N/A	N/A	SanDisk	N/A	N/A
EUT							
No.	Equipment	Model	Serial No.	FCC ID/ BSMI ID	Trade name	Data Cable	Power Cord
1	DDR RAM	4GB	NA	NA	NA	NA	NA
2	Flash ROM	16GB	NA	NA	NA	NA	NA

Note: All the above equipment /cable were placed in worse case position to maximize emission signals during emission test

Grounding: Grounding was in accordance with the manufacturer's requirement and conditions for the intended use.



3. TEST AND MEASUREMENT EQUIPMENT

3.1 CALIBRATION

The measuring equipment utilized to perform the tests documented in the report has been calibrated once a year or in accordance with the manufacturer’s recommendations, and is traceable to recognized national standards.

3.2 EQUIPMENT

The following list contains measurement equipment used for testing. The equipment conforms to the requirement of CISPR 16-1, ANSI C63.2 and. Other required standards.

Calibration of all test and measurement, including any accessories that may effect such calibration, is checked frequently to ensure the accuracy. Adjustments are made and correction factors are applied in accordance with the instructions contained in the respective.

Table 1 List of Test and Measurement Equipment

Test Site	Instrument	Manufacturer	Model No.	S/N	Next Cal. Date
Conduction	Spectrum (9K--3GHz)	R&S	FSP3	833387/010	2019/12/07
	EMI Receiver	R&S	ESHS10	830223/008	2019/06/06
	LISN	Rolf Heine Hochfrequenztechnik	NNB-2/16z	98062	2019/06/11
	ISN	Schwarzbeck	8-Wire ISN CAT5	CAT5-8158-0 094	2019/09/21
	RF Cable	N/A	N/A	EMI-3	2019/10/17
Radiation	Bilog antenna (30M-1G)	ETC	MCTD2786B	BLB16M0400 4/JB-5-004	2019/05/18
	Double Ridged Guide Horn antenna (1G-18G)	ETC	MCTD 1209	DRH15N0 2009	2019/11/28
	Horn antenna (18G-26G)	com-power	AH-826	81000	2019/08/16
	LOOP Antenna (Below 30M)	com-power	AL-130	17117	2019/11/12
	Pre amplifier (30M-1G)	EMC INSTRUMENT	EMC9135	980334	2019/05/08
	Microwave Preamplifier (1G-18G)	EMC INSTRUMENT	EMC051845	980108&AT -18001	2019/11/27



	Pre amplifier (18G~26G)	MITEQ	JS4-18002600-30-5A	808329	2019/08/09
	EMI Test Receiver	R&S	ESVS30 (20M-1000MHz)	826006/002	2019/11/07
	RF Cable (9K-1GHz)	EMCI	N male on end of both sides (EMI4)	30m	2019/11/09
	RF Cable (1~26G)	HARBOUT INDUSTRIES	LL142MI(4M+4M)	NA	2019/04/17
	RF Cable (1~18G)	HARBOUR INDUSTRIES	LL142MI(7M)	NA	2019/08/09
	RF CABLE (18~26GHz)	AGILENT	EMC102-KM-KM -600	160102	2019/04/18
	Spectrum (9K--7GHz)	R&S	FSP7	830180/006	2019/04/18
	Spectrum (9K--40GHz)	AGILENT	8564EC	4046A0032	2019/02/28
Software	e3	AUDIX	N/A	N/A	N/A
SG	SINGAL GENERATOR (100k-1GHz)	HP	8648A	3619U00426	N/A

● CALIBRATION INTERVAL OF INSTRUMENTS LISTED ABOVE IS ONE YEAR



4. SECTION 15.203 ANTENNA REQUIREMENTS

4.1 STANDARD APPLICABLE

For intentional device, according to FCC 47 CFR Section 15.203, an intentional radiator shall be designed to ensure that no antenna other than that furnished by the responsible party shall be used with the device.

4.2 ANTENNA CONSTRUCTION AND DIRECTIONAL GAIN: MEET FCC 47 CFR SECTION 15.203 REQUIREMENT.

BT:

Antenna Type:dipole antenna

Antenna Gain: 2 dBi

The EUT and antenna incorporate non-standard connector (Reversed SMA connector), which the antenna connector not readily available to general public.



5. SECTION 15.249 REQUIREMENTS (FUNDAMENTAL/ HARMONICS)

5.1 TEST SETUP

Refer to paragraph 6.1.

5.2 LIMIT

Fundamental Frequency (MHz)	Field Strength of Fundamental (dBμV/m at 3-meter)	Detector
902 - 928 2400 – 2483 5725 - 5875	114	Peak
902 - 928 2400 – 2483 5725 - 5875	94	AV

Fundamental Frequency (MHz)	Field Strength of Harmonics (dBμV/m at 3-meter)	Detector
902 - 928 2400 – 2483 5725 - 5875	74	Peak
902 - 928 2400 – 2483 5725 - 5875	54	AV

5.3 RESULT: PASSED



5.4 TEST DATA

Fundamental

Power	: AC 110V	Pol/Phase	: HORIZONTAL
Test Mode 1	: TX-LO 2402-MI 2440-HI 2480 MHz	Temperature	: 22 °C
Memo	: Dipole Antenna	Humidity	: 57 %

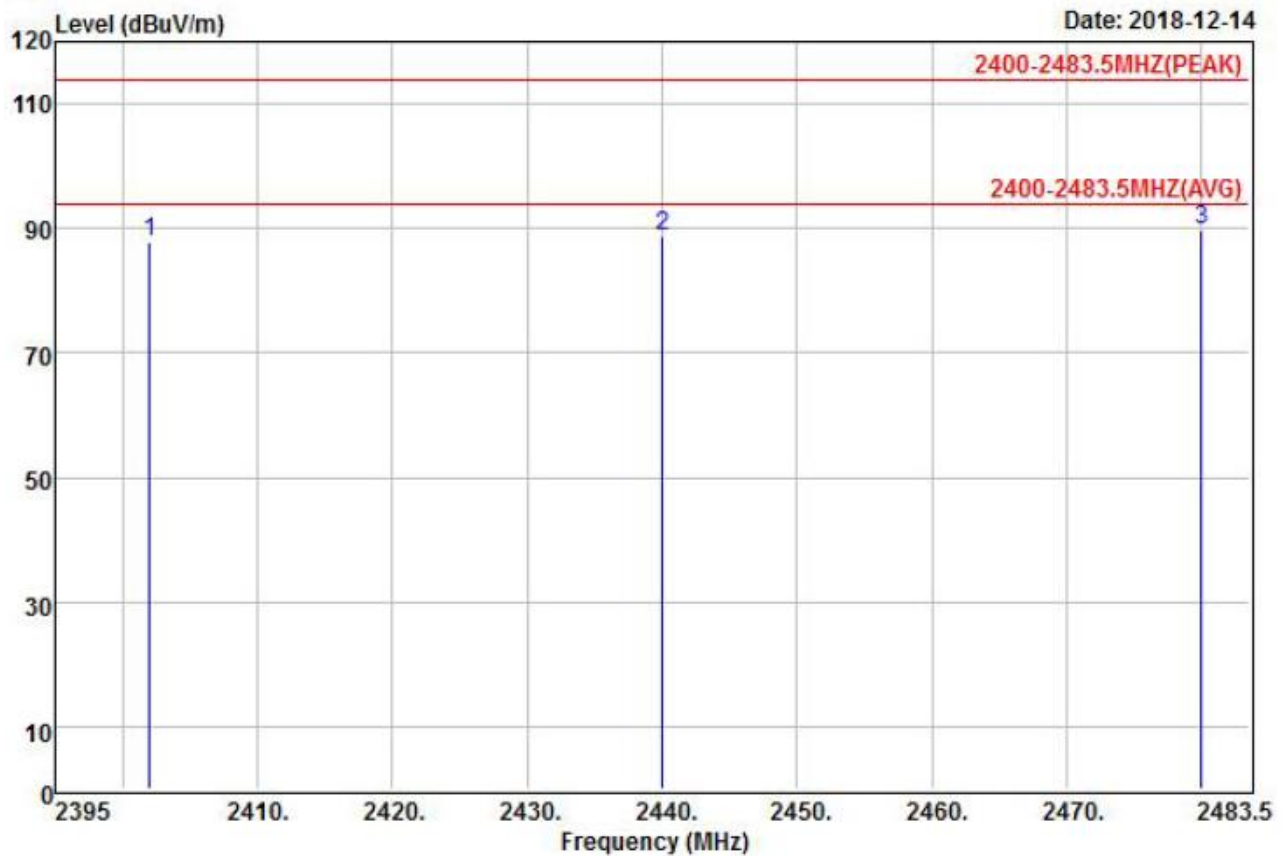

Remarks

: 1.Result=Read Value+Factor
: 2.Factor=Antenna Factor-Cable loss-
: Amplifier Factor

	Read	Limit	Over			
Freq	Level	Factor	Level	Line	Limit	Remark
MHz	dBuV	dB/m	dBuV/m	dBuV/m	dB	
1	2402.00	100.60	-12.87	87.73	114.00	-26.27 Peak
2	2440.00	101.60	-12.69	88.91	114.00	-25.09 Peak
3 @	2480.00	102.24	-12.52	89.72	114.00	-24.28 Peak



Power	: AC 110V	Pol/Phase	: VERTICAL
Test Mode 1	: TX-LO 2402-MI 2440-HI 2480 MHz	Temperature	: 22 °C
Memo	: Dipole Antenna	Humidity	: 57 %

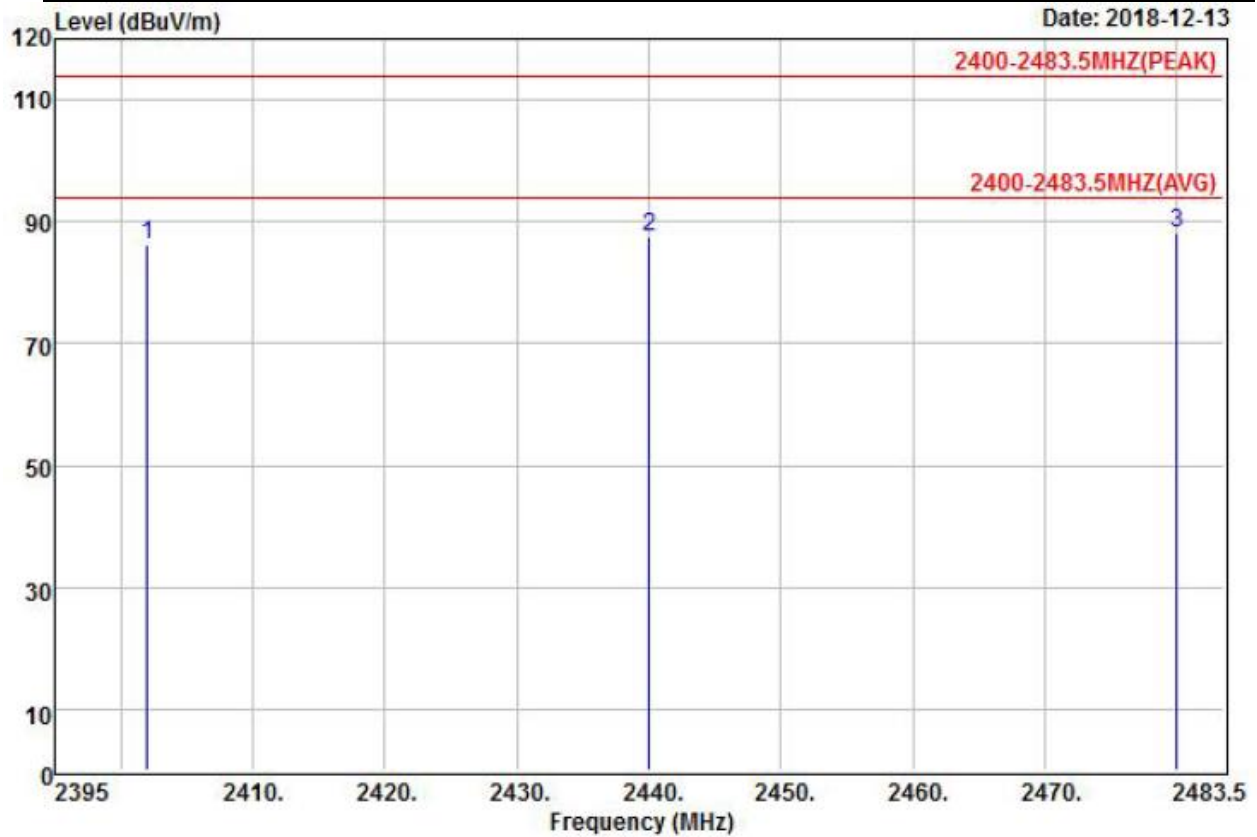

Remarks : 1.Result=Read Value+Factor
: 2.Factor=Antenna Factor-Cable loss-
: Amplifier Factor

	Read	Limit	Over				
Freq	Level	Factor	Level	Line	Limit	Remark	
MHz	dBuV	dB/m	dBuV/m	dBuV/m	dB		
1	2402.00	99.24	-12.87	86.37	114.00	-27.63	Peak
2	2440.00	100.13	-12.69	87.44	114.00	-26.56	Peak
3 @	2480.00	100.77	-12.52	88.25	114.00	-25.75	Peak



Harmonics

Power	: AC 110V	Pol/Phase	: HORIZONTAL
Test Mode 1	: TX-LO 2402-MI 2440-HI 2480 MHz	Temperature	: 22 °C
Memo	: Dipole Antenna	Humidity	: 57 %

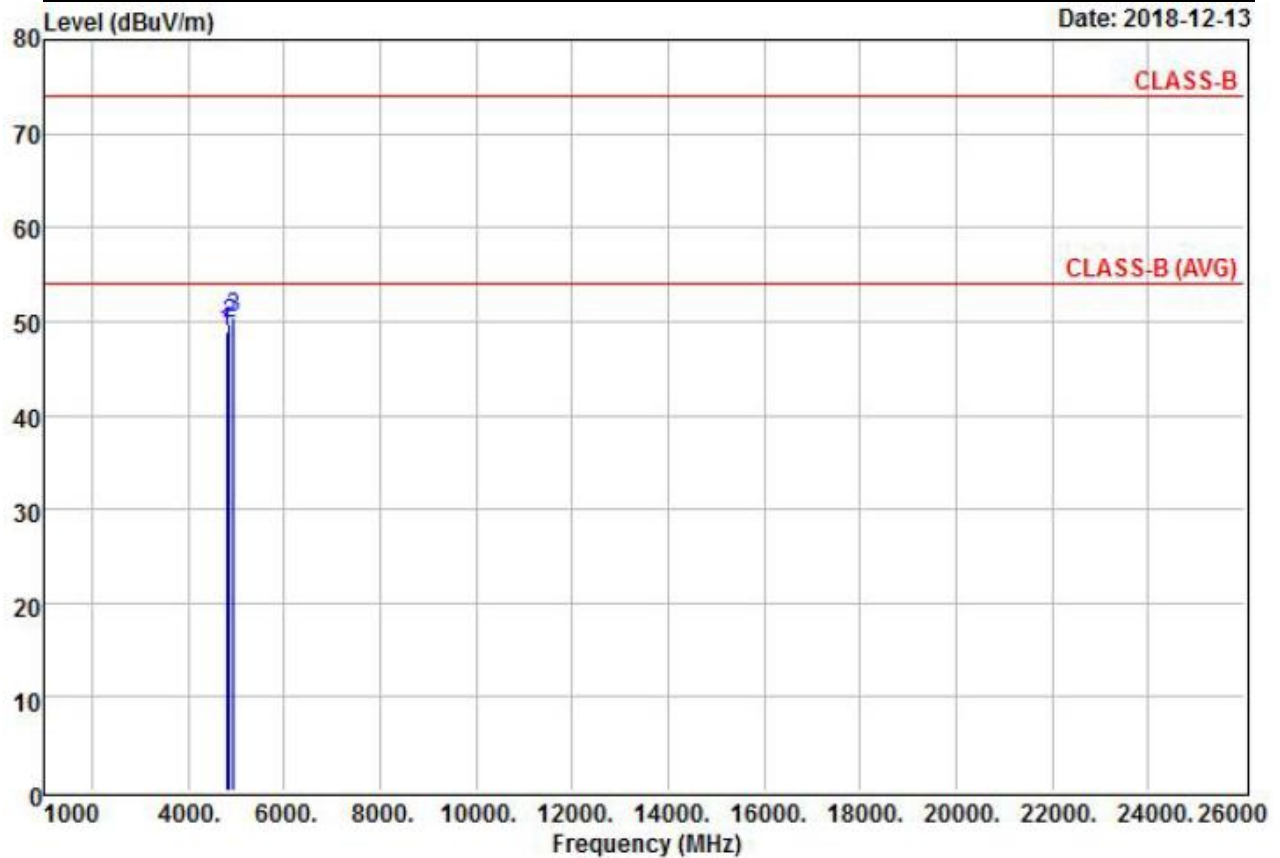

Remarks : 1.Result=Read Value+Factor
: 2.Factor=Antenna Factor-Cable loss-
: Amplifier Factor

	Freq	Read	Factor	Level	Limit	Over	Remark
	MHz	dBuV	dB/m	dBuV/m	dBuV/m	dB	
1	4804.00	54.14	-5.33	48.81	74.00	-25.19	Peak
2	4880.00	54.84	-5.07	49.77	74.00	-24.23	Peak
3 @	4960.00	55.28	-4.79	50.49	74.00	-23.51	Peak



Power	: AC 110V	Pol/Phase	: VERTICAL
Test Mode 1	: TX-LO 2402-MI 2440-HI 2480 MHz	Temperature	: 22 °C
Memo	: Dipole Antenna	Humidity	: 57 %

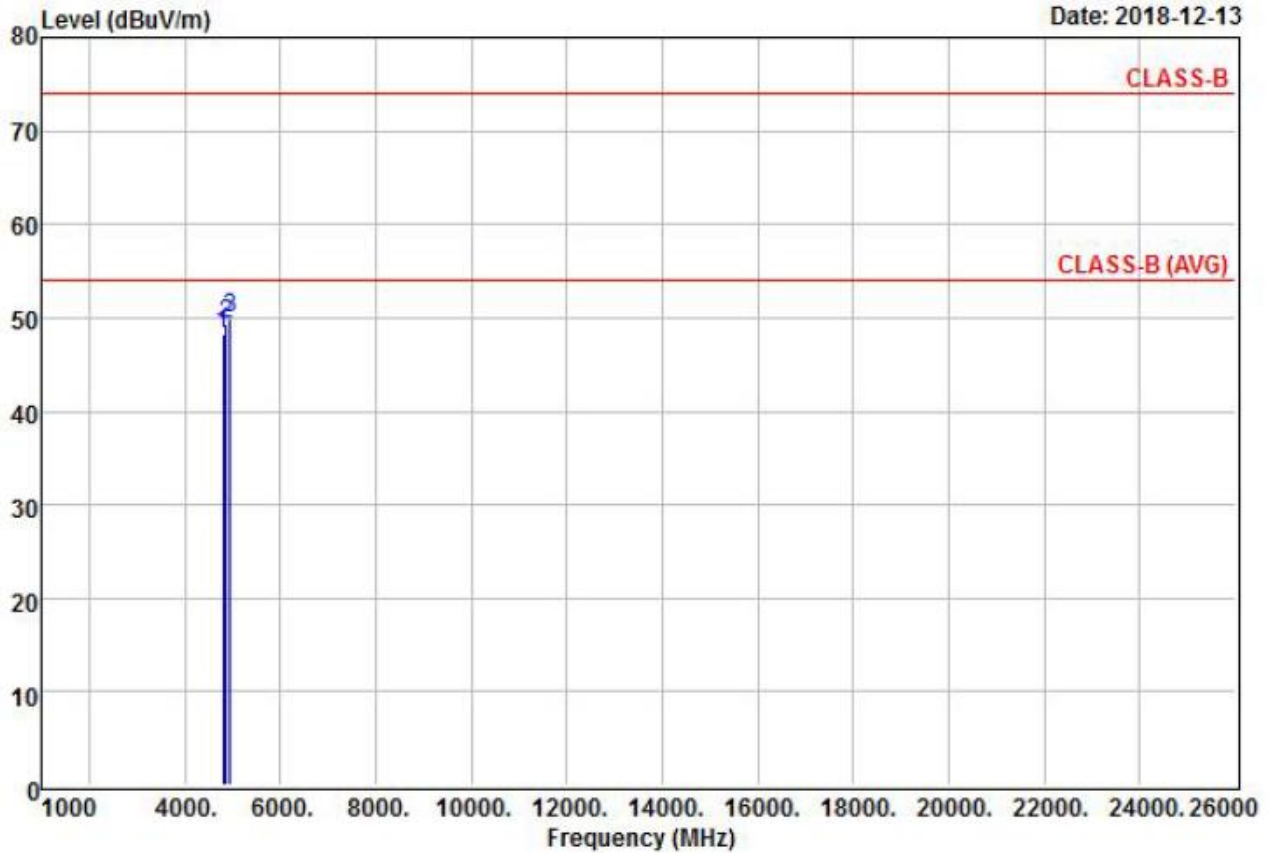

Remarks : 1.Result=Read Value+Factor
: 2.Factor=Antenna Factor-Cable loss-
: Amplifier Factor

	Read	Limit	Over				
Freq	Level	Factor	Level	Line			
MHz	dBuV	dB/m	dBuV/m	dBuV/m			
				Limit			
				Over			
				Limit			
				dB			
1	4804.00	53.68	-5.33	48.35	74.00	-25.65	Peak
2	4880.00	54.36	-5.07	49.29	74.00	-24.71	Peak
3 @	4960.00	54.81	-4.79	50.02	74.00	-23.98	Peak



Note:

1. Emission level = Reading level + Correction factor
2. Correction factor : Antenna factor, Cable loss, Pre-Amp, etc.
3. All emissions as described above were determining by rotating the EUT through three orthogonal axes to maximizing the emissions if the EUT belongs to hand-held or body-worn devices.
4. Measurements above 1000 MHz, Peak detector setting: use a 1 MHz RBW, a 3 MHz VBW.
5. Measurements above 1000 MHz, Average detector setting: 1 MHz RBW with 10 Hz VBW
6. Peak detector measurement data will represent the worst case results.
7. “---” denotes the data which is not available.



6. SECTION 15.205 REQUIREMENTS (BAND EDGE)

6.1 TEST SETUP

Refer to paragraph 6.1.

6.2 LIMIT

Restricted Bands:

MHz	MHz	MHz	GHz
0.090 - 0.110	16.42 - 16.423	399.9 - 410	4.5 - 5.15
¹ 0.495 - 0.505	16.69475 - 16.69525	608 - 614	5.35 - 5.46
2.1735 - 2.1905	16.80425 - 16.80475	960 - 1240	7.25 - 7.75
4.125 - 4.128	25.5 - 25.67	1300 - 1427	8.025 - 8.5
4.17725 - 4.17775	37.5 - 38.25	1435 - 1626.5	9.0 - 9.2
4.20725 - 4.20775	73 - 74.6	1645.5 - 1646.5	9.3 - 9.5
6.215 - 6.218	74.8 - 75.2	1660 - 1710	10.6 - 12.7
6.26775 - 6.26825	108 - 121.94	1718.8 - 1722.2	13.25 - 13.4
6.31175 - 6.31225	123 - 138	2200 - 2300	14.47 - 14.5
8.291 - 8.294	149.9 - 150.05	2310 - 2390	15.35 - 16.2
8.362 - 8.366	156.52475 - 156.52525	2483.5 - 2500	17.7 - 21.4
8.37625 - 8.38675	156.7 - 156.9	2690 - 2900	22.01 - 23.12
8.41425 - 8.41475	162.0125 - 167.17	3260 - 3267	23.6 - 24.0
12.29 - 12.293	167.72 - 173.2	3332 - 3339	31.2 - 31.8
12.51975 - 12.52025	240 - 285	3345.8 - 3358	36.43 - 36.5
12.57675 - 12.57725	322 - 335.4	3600 - 4400	(²)
13.36 - 13.41			

Operation within the bands:

902 - 928 MHz, 2400 - 2483.5 MHz, 5725 - 5875 MHz, and 24.0 - 24.25 GHz.

Frequency (Hz)	Field Strength (μV/m at 3-meter)	Field Strength (dBμV/m at 3-meter)
1.705-30	30 (at 30-meter)	49.5
30-88	100	40
88-216	150	43
216-960	200	46
Above 960	500	54

6.3 RESULT: PASSED



6.4 TEST DATA

Power	: AC 110V	Pol/Phase	: HORIZONTAL
Test Mode 1	: CH LO & HI –Restricted Bands	Temperature	: 17 °C
Memo	: Dipole Antenna	Humidity	: 72 %

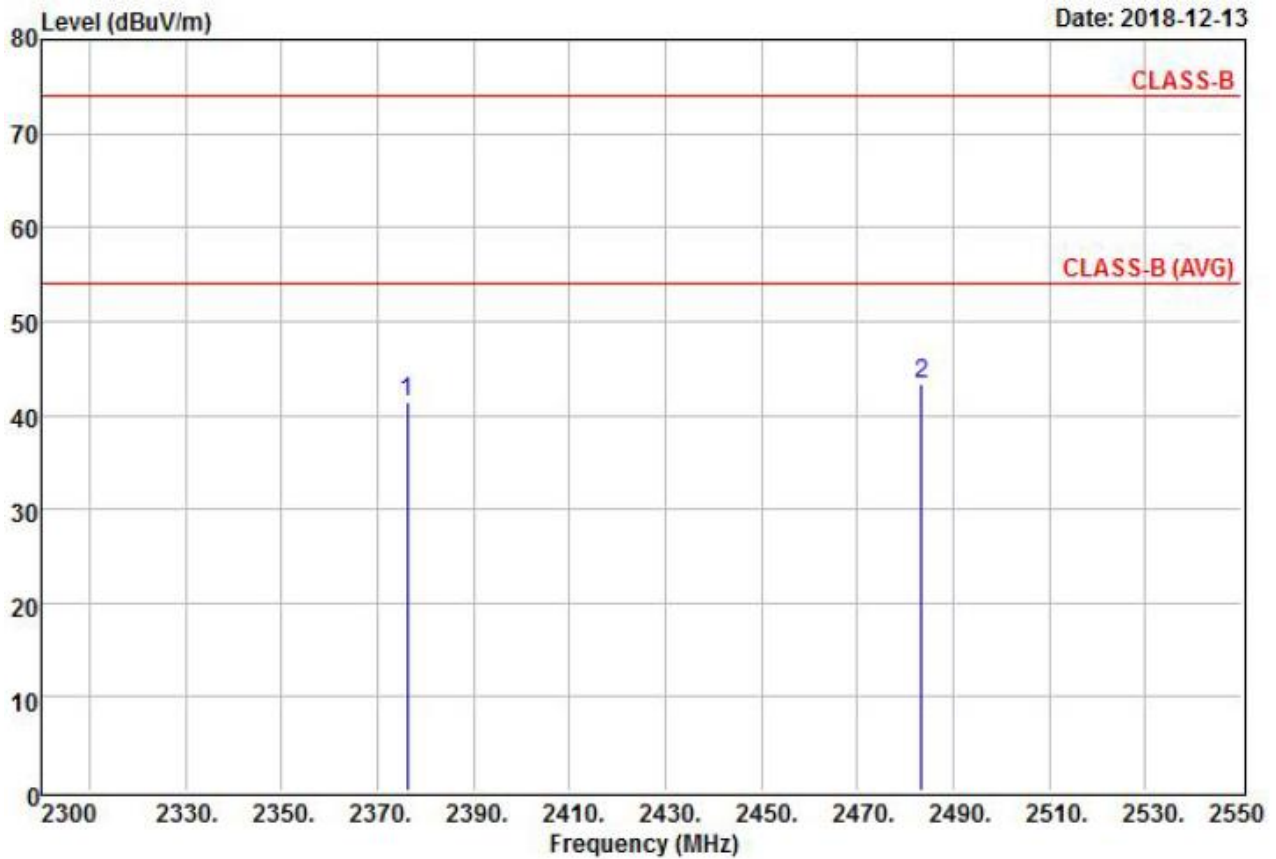

Remarks : 1.Result=Read Value+Factor
: 2.Factor=Antenna Factor-Cable loss-
: Amplifier Factor

	Freq	Read Level	Factor	Level	Limit Line	Over Limit	Remark
	MHz	dBuV	dB/m	dBuV/m	dBuV/m	dB	
1	2376.20	54.28	-12.97	41.31	74.00	-32.69	Peak
2 @	2483.50	55.91	-12.50	43.41	74.00	-30.59	Peak



Power	: AC 110V	Pol/Phase	: VERTICAL
Test Mode 1	: CH LO & HI –Restricted Bands	Temperature	: 17 °C
Memo	: Dipole Antenna	Humidity	: 72 %

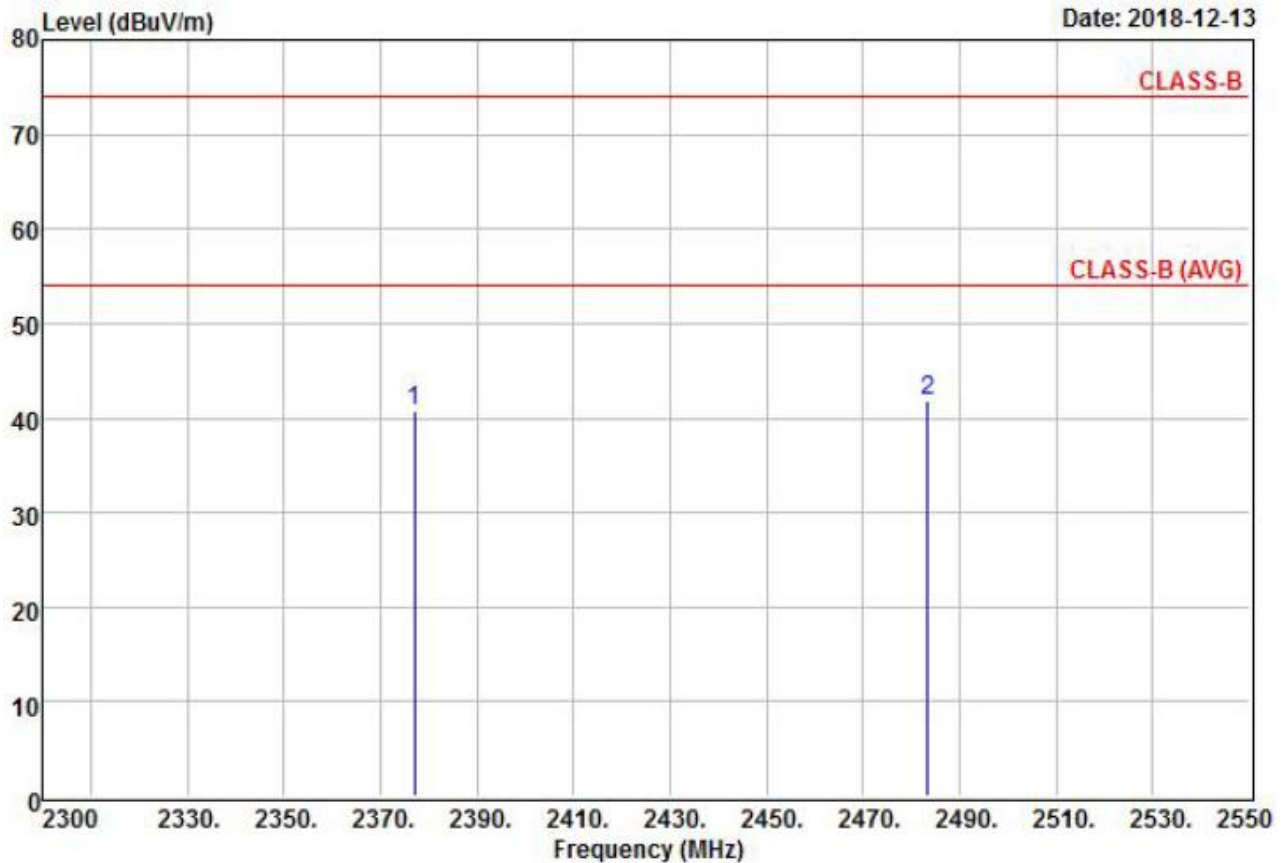

Remarks : 1.Result=Read Value+Factor
: 2.Factor=Antenna Factor-Cable loss-
: Amplifier Factor

	Read	Limit	Over				
Freq	Level	Factor	Level	Line			
MHz	dBuV	dB/m	dBuV/m	dBuV/m			
1	2377.10	53.78	-12.97	40.81	74.00	-33.19	Peak
2 @	2483.50	54.27	-12.50	41.77	74.00	-32.23	Peak



Note:

1. Emission level = Reading level + Correction factor
2. Correction factor : Antenna factor, Cable loss, Pre-Amp, etc.
3. All emissions as described above were determining by rotating the EUT through three orthogonal axes to maximizing the emissions if the EUT belongs to hand-held or body-worn devices.
4. Measurements above 1000 MHz, Peak detector setting: use a 1 MHz RBW, a 3 MHz VBW.
5. Measurements above 1000 MHz, Average detector setting: 1 MHz RBW with 10 Hz VBW.
6. Peak detector measurement data will represent the worst case results.



7. SECTION 15.209 REQUIREMENTS (GENERAL RADIATED EMISSION)

7.1 TEST SETUP

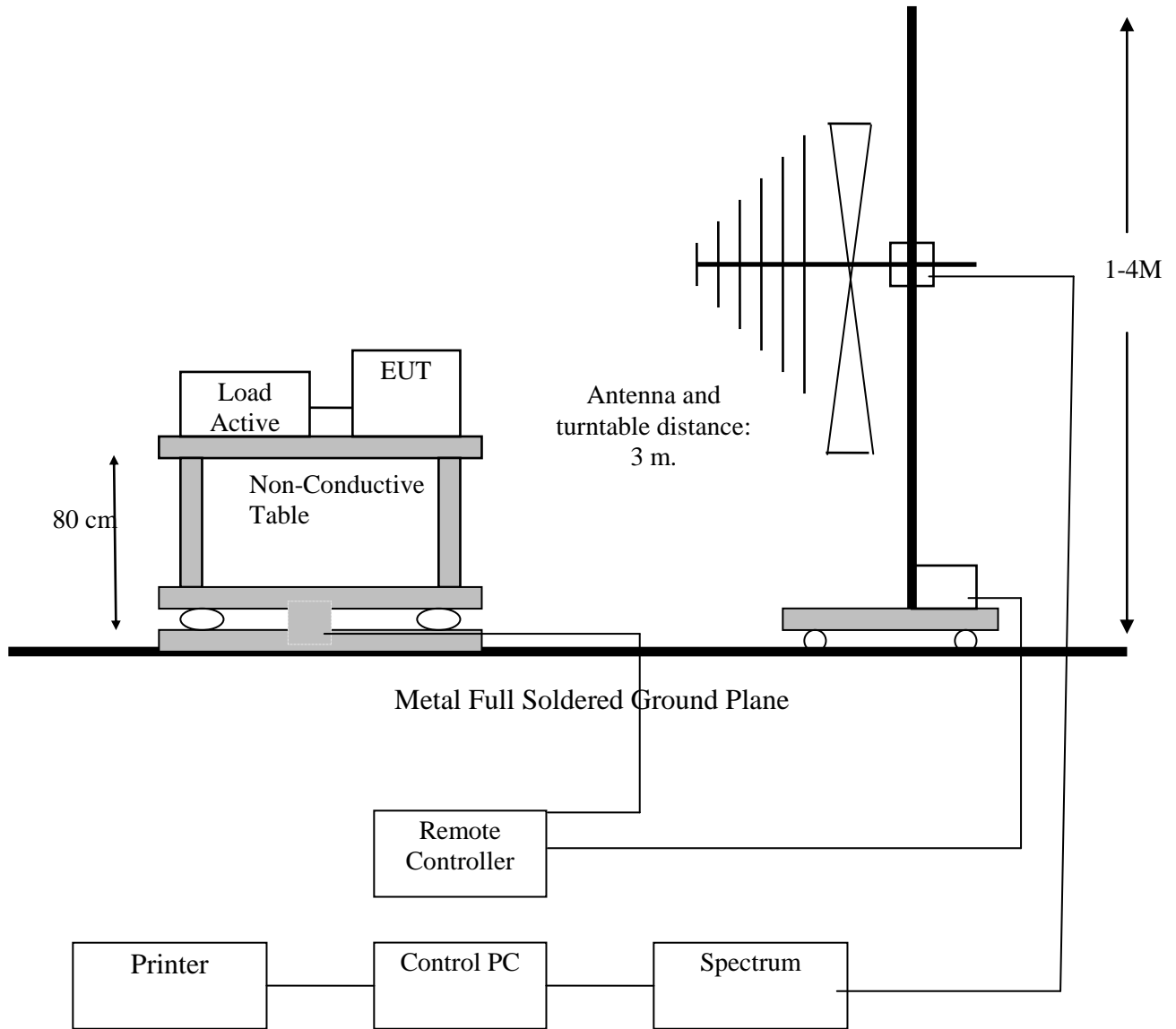



7.2 LIMIT

The field strength of any emissions which appear outside of this band shall not exceed the general radiated emission limits in section 15.209 as below.

Frequency (MHz)	Field Strength (mV/m)	Measurement Distance (m)
1.705-30	30	30
30-88	100*	3
88-216	150*	3
216-960	200*	3
Above 960	500*	3

**Except as provided in paragraph (g), fundamental emissions from intentional radiators operating under this Section shall not be located in the frequency bands 54-72 MHz, 76-88 MHz, 174-216 MHz or 470-806 MHz. However, operation within these frequency bands is permitted under other sections of this Part, e.g., Sections 15.231 and 15.241.*

In the above emission table, the tighter limit applies at the band edges.

Frequency (Hz)	Field Strength (μV/m at 3-meter)	Field Strength (dBμV/m at 3-meter)
1.705-30	30 (at 30-meter)	49.5
30-88	100	40
88-216	150	43
216-960	200	46
Above 960	500	54

7.3 TEST PROCEDURE

1. The EUT was placed on a turntable, which was 0.8m above ground plane.
2. The turntable was rotated for 360 degrees to determine the position of maximum emission level.
3. EUT was set at 3m away from the receiving antenna, which was varied from 1m to 4m to find out the highest emissions.
4. Maximum procedure was performed on the six highest emissions to ensure EUT compliance.
5. And also, each emission was maximized by changing the polarization of receiving antenna, both horizontal and vertical.
6. Repeated above procedures until the measurements for all frequencies are completed.

7.4 RESULT: PASSED

7.5 TEST DATA

All frequencies not described in this test report and within the range of the general radiated emission limits are not detectable significantly. The table as below is representing worst emissions found.



Power	: AC 110V	Pol/Phase	: HORIZONTAL
Test Mode 1	: TX 2480 MHz	Temperature	: 17 °C
Memo	: Dipole Antenna	Humidity	: 72 %

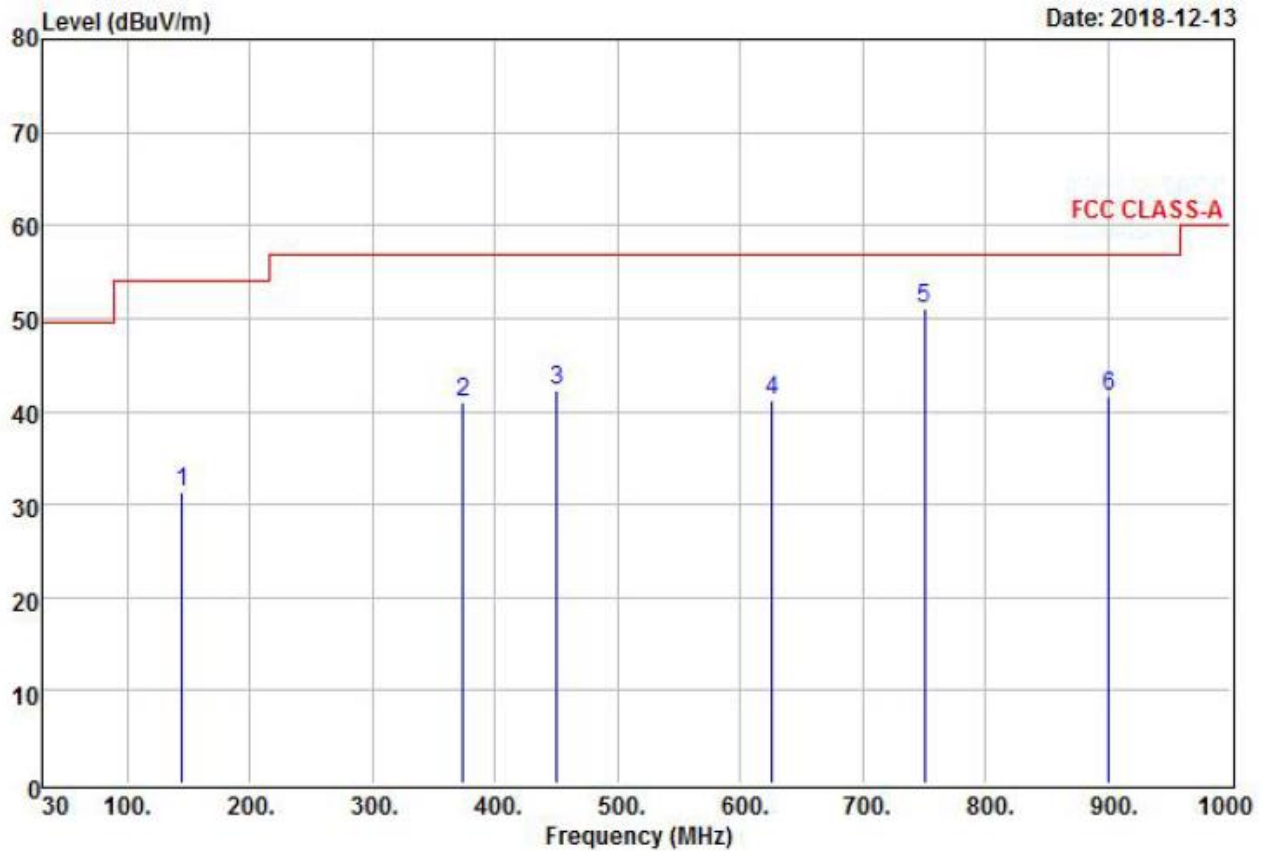

Remarks : 1.Result=Read Value+Factor
: 2.Factor=Antenna Factor-Cable loss-
: Amplifier Factor

	Freq	Read	Limit	Over			
	MHz	Level	Factor	Level	Line	Limit	Remark
		dBuV	dB/m	dBuV/m	dBuV/m	dB	
1	144.42	46.47	-15.18	31.29	54.00	-22.71	QP
2	374.15	52.56	-11.51	41.05	56.90	-15.85	QP
3	450.33	52.35	-10.06	42.29	56.90	-14.61	QP
4	626.37	49.21	-8.03	41.18	56.90	-15.72	QP
5 @	750.65	56.95	-5.83	51.12	56.90	-5.78	QP
6	901.07	45.24	-3.71	41.53	56.90	-15.37	QP



Power	: AC 110V	Pol/Phase	: VERTICAL
Test Mode 1	: TX 2480 MHz	Temperature	: 17 °C
Memo	: Dipole Antenna	Humidity	: 72 %

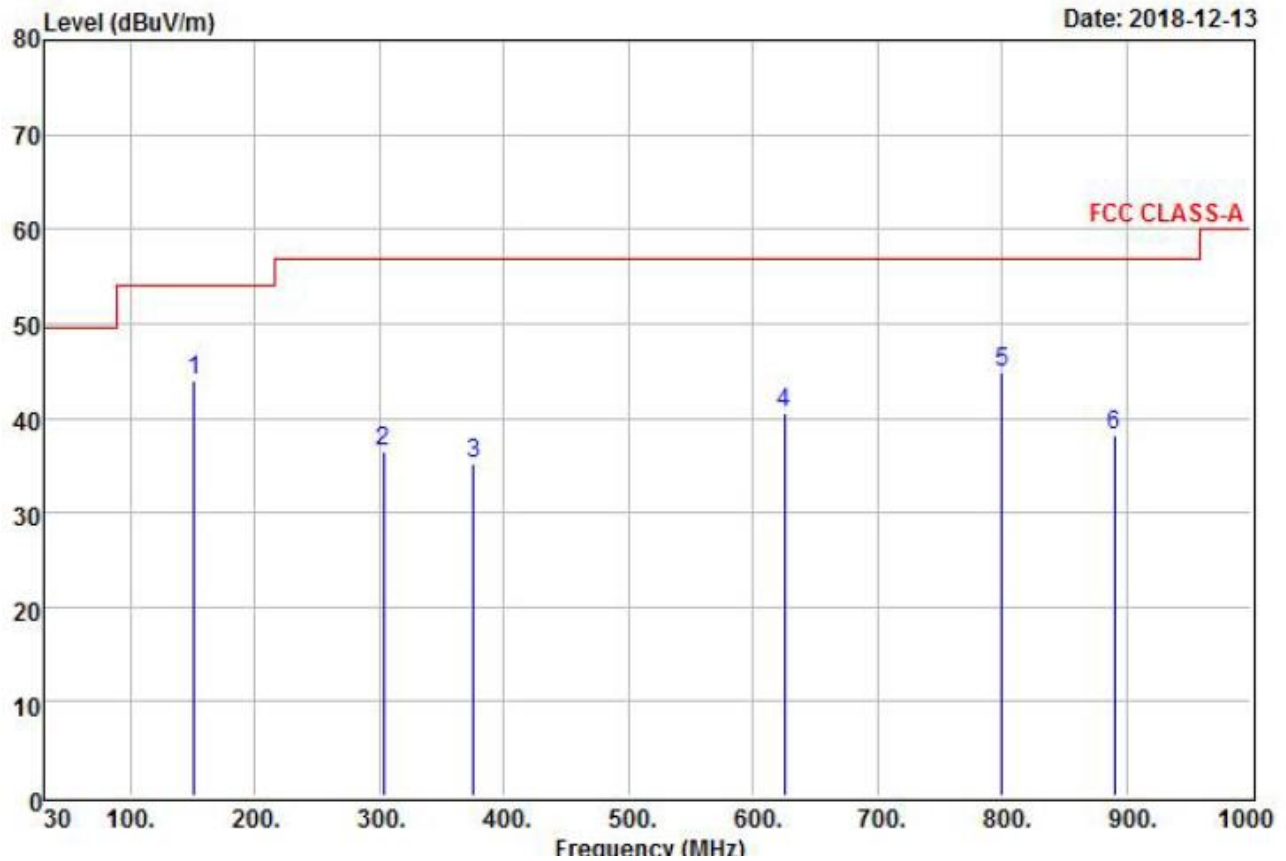

Remarks : 1.Result=Read Value+Factor
: 2.Factor=Antenna Factor-Cable loss-
: Amplifier Factor

	Freq	Read	Factor	Level	Limit	Over	Remark
	MHz	dBuV	dB/m	dBuV/m	dBuV/m	dB	
1 @	150.62	59.72	-15.65	44.07	54.00	-9.93	QP
2	302.78	49.62	-13.26	36.36	56.90	-20.54	QP
3	375.36	46.57	-11.46	35.11	56.90	-21.79	QP
4	625.61	48.69	-8.06	40.63	56.90	-16.27	QP
5	800.34	49.65	-4.92	44.73	56.90	-12.17	QP
6	890.82	41.92	-3.76	38.16	56.90	-18.74	QP



Note:

1. Emission level = Reading level + Correction factor
2. Correction factor : Antenna factor, Cable loss, Pre-Amp, etc.
3. All emissions as described above were determining by rotating the EUT through three orthogonal axes to maximizing the emissions if the EUT belongs to hand-held or body-worn devices.
4. Measurements from 9 kHz to 150 kHz, Peak detector setting: 100 Hz RBW
5. Measurements from 150 kHz to 30MHz, Peak detector setting: 10 kHz RBW
6. Measurements from 30 MHz to 1000 MHz, Peak detector setting: 100 kHz RBW
7. Measurements from 9 kHz to 150 kHz, CISPR Quasi-Peak detector: 200 Hz RBW
8. Measurements from 150 kHz to 30MHz, CISPR Quasi-Peak detector: 9 kHz RBW
9. Measurements from 30 MHz to 1000 MHz, CISPR Quasi-Peak detector: 120 kHz RBW
10. Peak detector measurement data will represent the worst case results.



8. SECTION 15.207 REQUIREMENTS (POWERLINE CONDUCTED EMISSIONS)

8.1 TEST SETUP

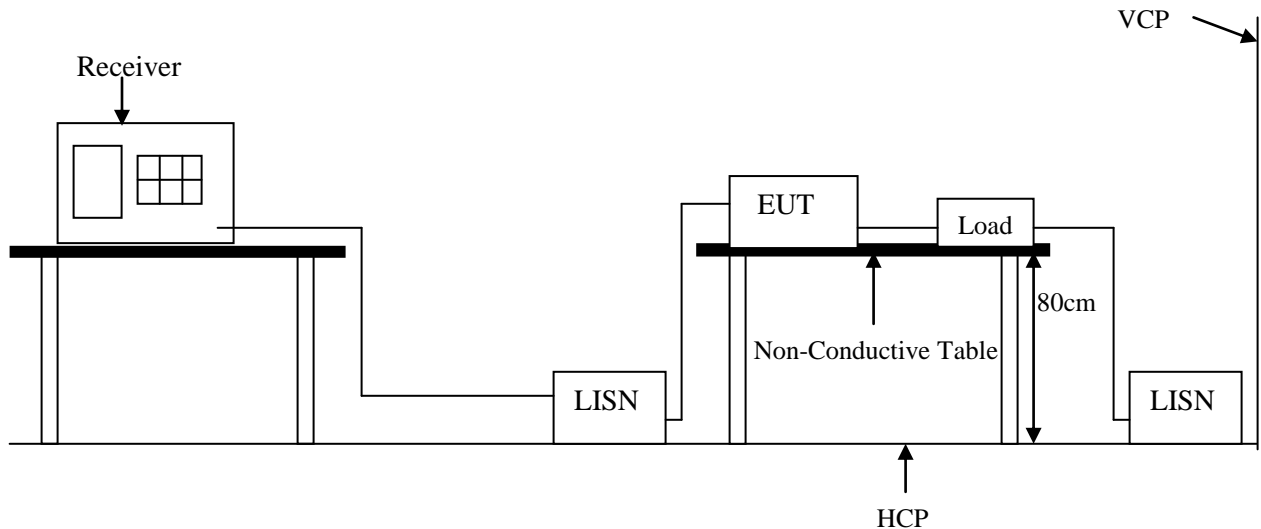

8.2 LIMIT

Frequency range (MHz)	CLASS B	
	QP dB(uV)	Average dB(uV)
0.15-0.5	66 - 56 dBuV	56 - 46 dBuV
0.5-5.0	56 dBuV	46 dBuV
5.0-30.0	60 dBuV	50 dBuV

Remark: In the above table, the tighter limit applies at the band edges.

8.3 TEST PROCEDURE

The EUT and simulators are connected to the main power through a line impedance stabilization network (LISN). It provides a 50 ohm / 50 μ H coupling impedance for the measuring equipment. The peripheral devices are also connected to the main power through a LISN that provides a 50 ohm / 50 μ H coupling impedance with 50 ohm termination. (Please refer to the block diagram of the test setup and photograph.)

Both sides of AC line are checked for the maximum conducted emission interference. In order to find the maximum emissions, the relating positions of equipment and all of the interference cables must be changed according to EN 55022 regulations: The measurement procedure on conducted emission interference.

The resolution bandwidth of the field strength meter is set at 9 KHz.



8.4 TEST SPECIFICATION

According to PART15.207

8.5 RESULT: PASSED

EMI Receiver/Spectrum Analyzer Configuration (for the frequencies tested)

Frequency Range:	150KHz--30MHz
Detector Function:	Quasi-Peak / Average Mode
Resolution Bandwidth:	9KHz



8.6 TEST DATA

Power	: AC 110V	Pol/Phase	: LINE
Test Mode 1	: TX 2480 MHz	Temperature	: 24 °C
Memo	:	Humidity	: 53 %

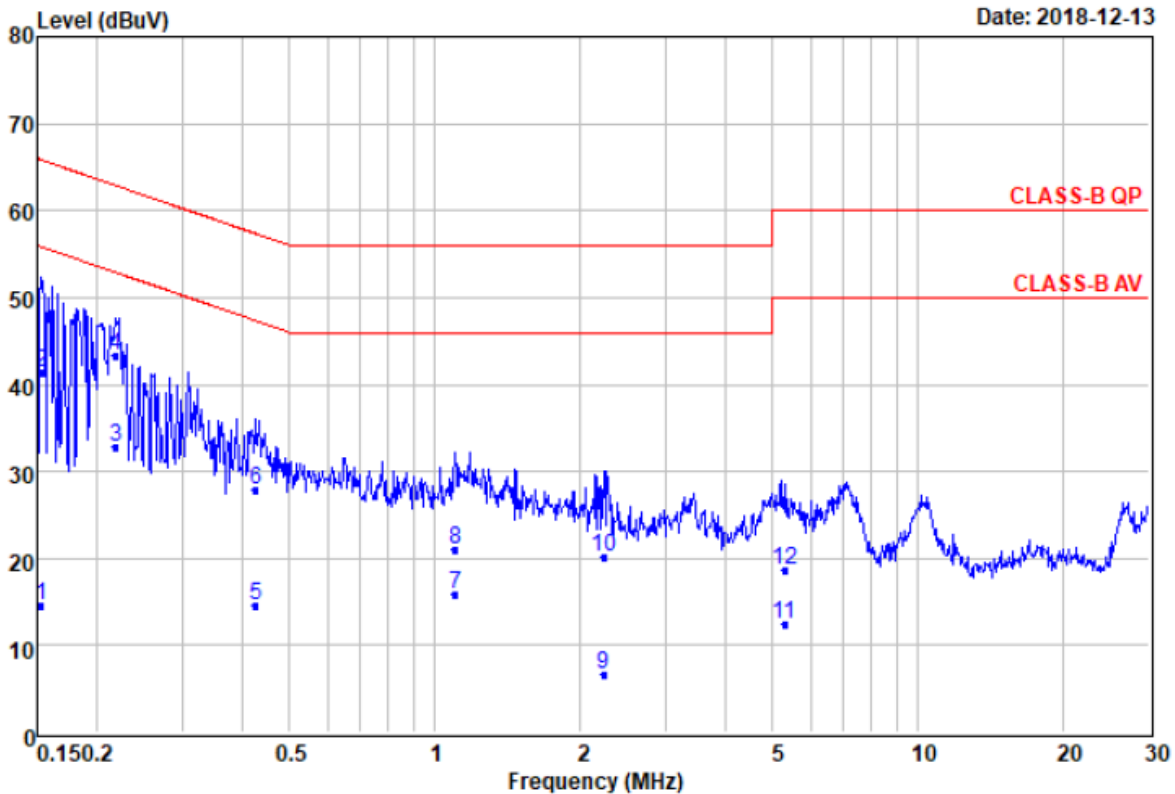

Remarks

: Factor=Insrtion loss+Cable loss

	Freq	Read Level	Level Factor	Over Limit	Limit Line	Remark
	MHz	dBuV	dBuV	dB	dB	dBuV
1	0.15	4.59	14.69	10.10	-41.13	55.82 Average
2	0.15	31.30	41.40	10.10	-24.42	65.82 QP
3 A	0.22	22.82	32.91	10.09	-19.97	52.88 Average
4 @	0.22	33.16	43.25	10.09	-19.63	62.88 QP
5	0.43	4.52	14.62	10.10	-32.71	47.33 Average
6	0.43	17.78	27.88	10.10	-29.45	57.33 QP
7	1.10	5.77	15.90	10.13	-30.10	46.00 Average
8	1.10	10.79	20.92	10.13	-35.08	56.00 QP
9	2.24	-3.61	6.58	10.19	-39.42	46.00 Average
10	2.24	10.02	20.21	10.19	-35.79	56.00 QP
11	5.28	2.11	12.40	10.29	-37.60	50.00 Average
12	5.28	8.42	18.71	10.29	-41.29	60.00 QP



Power	: AC 110V	Pol/Phase	: NEUTRAL
Test Mode 1	: TX 2480 MHz	Temperature	: 24 °C
Memo	:	Humidity	: 53 %

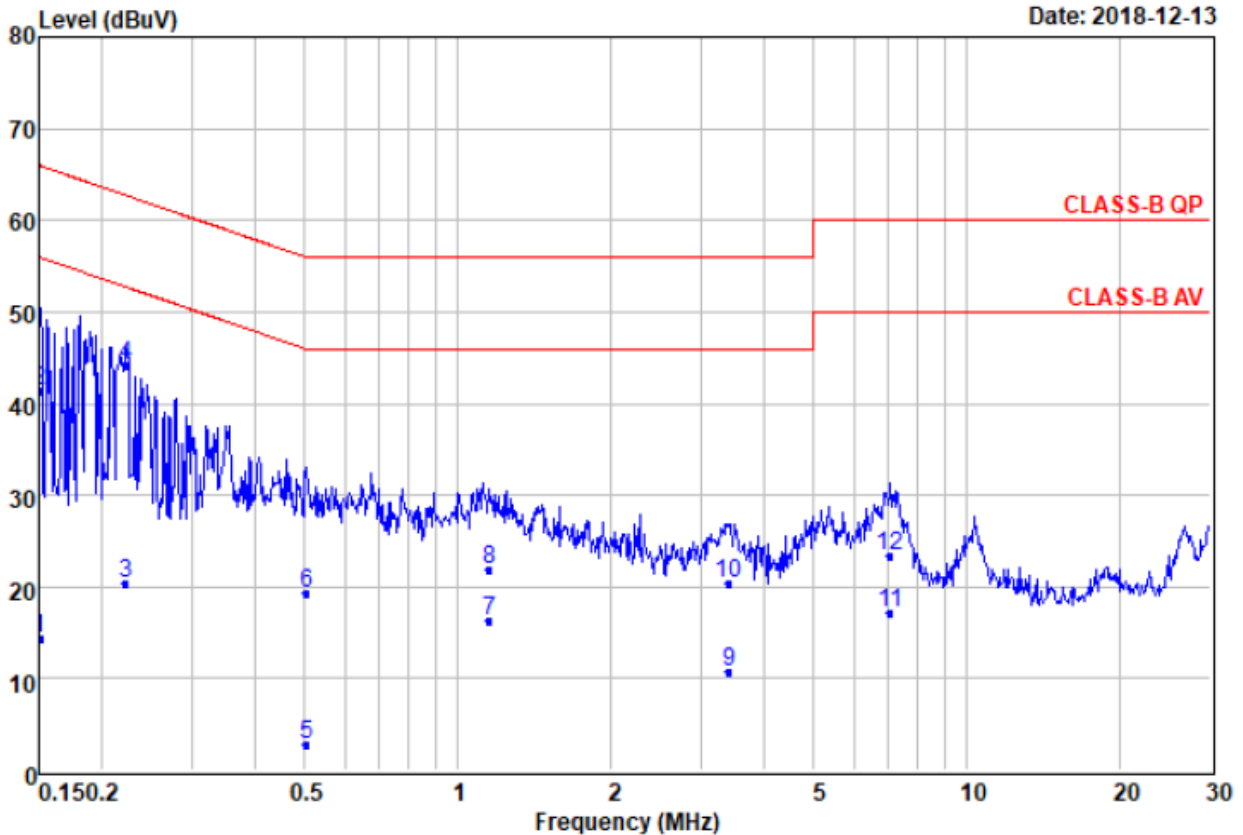

Remarks

: Factor=Insrtion loss+Cable loss

	Freq	Read Level	Level	Factor	Over Limit	Limit Line	Remark
	MHz	dBuV	dBuV	dB	dB	dBuV	
1	0.15	4.38	14.46	10.08	-41.50	55.96	Average
2	0.15	31.36	41.44	10.08	-24.52	65.96	QP
3	0.22	10.36	20.44	10.08	-32.30	52.74	Average
4 @	0.22	34.08	44.16	10.08	-18.58	62.74	QP
5	0.50	-7.21	2.89	10.10	-43.11	46.00	Average
6	0.50	9.16	19.26	10.10	-36.74	56.00	QP
7 ▲	1.15	6.10	16.23	10.13	-29.77	46.00	Average
8	1.15	11.80	21.93	10.13	-34.07	56.00	QP
9	3.40	0.42	10.63	10.21	-35.37	46.00	Average
10	3.40	10.21	20.42	10.21	-35.58	56.00	QP
11	7.06	6.76	17.08	10.32	-32.92	50.00	Average
12	7.06	12.97	23.29	10.32	-36.71	60.00	QP



9. SECTION 15.215 REQUIREMENT (20DB BANDWIDTH TEST)

9.1 TEST SETUP

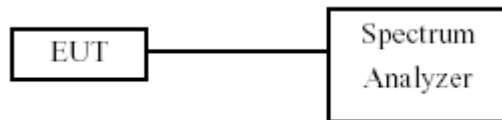

9.2 TEST PROCEDURE

- a. The transmitter output was connected to the spectrum analyzer.
- b. Set RBW=30KHz and VBW=100KHz.
- c. The 20 dB bandwidth is defined as the total spectrum the power of which is higher than peak power minus 20 dB.
- d. The 20 dB Bandwidth was measured and recorded.

9.3 RESULT: PASSED



9.4 TEST DATA

Test Date: Jan. 29, 2019

Temperature: 22°C

Atmospheric pressure: 1025 hPa

Humidity: 55%

Modulation Standard	Channel	Frequency (MHz)
GFSK	00	2402MHz
GFSK	38	2440MHz
GFSK	78	2480MHz

Modulation Standard: GFSK
Channel: 00

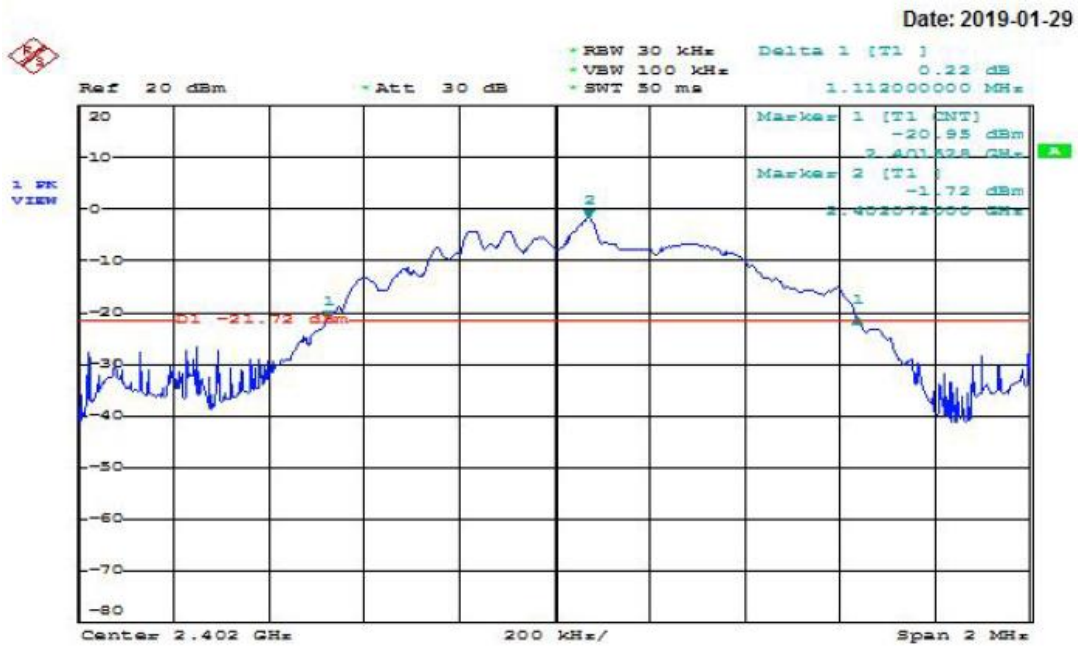



Modulation Standard: GFSK
Channel: 38

Date: 2019-01-29

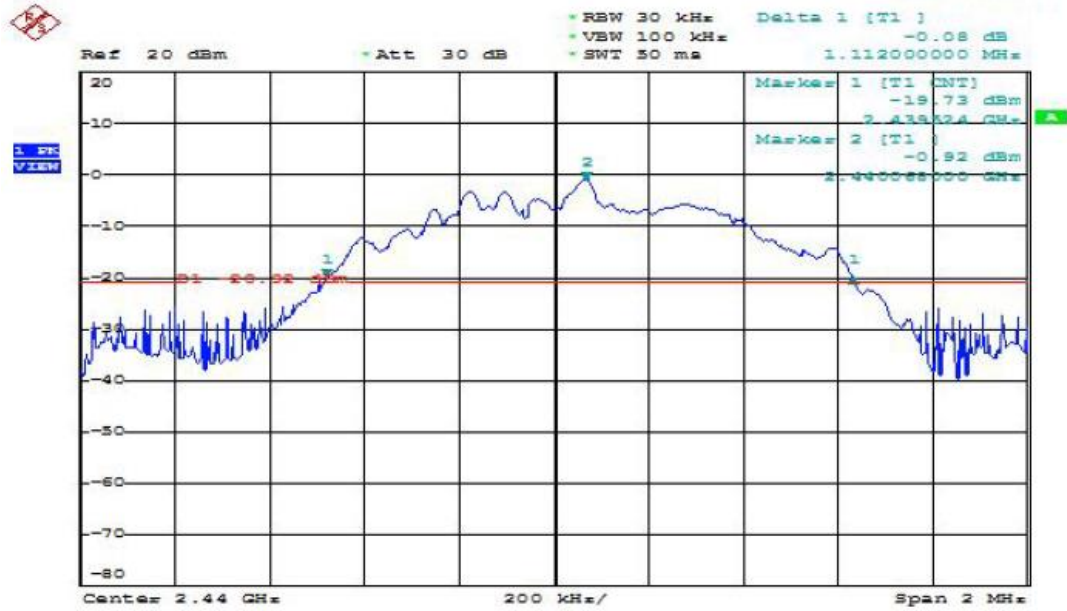

Modulation Standard: GFSK
Channel: 78

Date: 2019-01-29

