



FCC 47 CFR PART 15 SUBPART C 15.247

TEST REPORT

FOR

Embedded computer / module

Model : EC3100, SBC3100, H310, H330, D120

Trade Name : N/A

Issued to

IC NEXUS CO., LTD.

6F-1, No. 3-2 Park Street, Nan-Kang Dist., Taipei, Taiwan Post Code: 11503

Issued by

WH Technology Corp.



EMC Test Site	Xizhi Office and Lab	7F., No.262, Sec. 3, Datong Rd., Xizhi Dist., New Taipei City 221, Taiwan (R.O.C.)
Tel.: +886-2-7729-7707 Fax: +886-2- 8648-1311		

Note: This test refers exclusively to the test presented test model and sample. This report shall not be reproduced except in full, without the written approval of WH Technology Corp. This document may be altered or revised by WH Technology Corp. Personnel only, and shall be noted in the revision section of the document.



Contents

Appendix A.

1. General Information	3
2. Report of Measurements and Examinations	4
2.1 List of Measurements and Examinations	5
3. Test Configuration of Equipment under Test	6
3.1 Description of the tested samples	6
3.2 Carrier Frequency of Channels	7
3.3 Test Mode and Test Software	8
3.4 TEST Methodology & General Test Procedures	9
3.5 Measurement Uncertainty	10
3.6 Description of the Support Equipments	10
4. Test and measurement equipment	12
4.1 calibration	12
4.2 equipment	12
5. Antenna Requirements	15
5.1 Standard Applicable	15
5.2 Antenna Construction and Directional Gain	15
6. Test of Conducted Emission	16
6.1 Test Limit	16
6.2 Test Procedures	16
6.3 Typical Test Setup	17
6.4 Test Result and Data	18
7. Test of Radiated Emission	20
7.1 Test Limit	20
7.2 Test Procedures	20
7.3 Typical Test Setup	22
7.4 Test Result and Data (9kHz ~ 30MHz)	23
7.5 Test Result and Data (30MHz ~ 1GHz, worst emissions found)	23
7.6 Test Result and Data (Above 1GHz)	25
8. 6dB Bandwidth Measurement Data	28
8.1 Test Limit	28
8.2 Test Procedures	28
8.3 Test Setup Layout	28
8.4 Test Result and Data	29
9. Maximum Peak and Average Output Power	35
9.1 Test Limit	35
9.2 Test Procedures	35



9.3	Test Setup Layout	35
9.4	Test Result and Data	36
10.	Power Spectral Density	40
10.1	Test Limit	40
10.2	Test Procedures	40
10.3	Test Setup Layout	40
10.4	Test Result and Data	41
11.	Band Edges Measurement	47
11.1	Test Limit	47
11.2	Test Procedure	47
11.3	Test Setup Layout	47
11.4	Test Result and Data	48
11.5	Restrict Band Emission Measurement Data	52
12.	Restricted Bands of Operation	56
12.1	Labeling Requirement	56



1. General Information

Applicant : IC NEXUS CO., LTD.

Address : 6F-1, No. 3-2 Park Street, Nan-Kang Dist., Taipei, Taiwan
Post Code: 11503

Manufacturer : IC NEXUS CO., LTD.

Address : 6F-1, No. 3-2 Park Street, Nan-Kang Dist., Taipei, Taiwan
Post Code: 11503

EUT : Embedded computer / module

Model Name : EC3100, SBC3100, H310, H330, D120

Model Differences : For marketing purpose

Is here with confirmed to comply with the requirements set out in the FCC Rules and Regulations Part 15 Subpart C and the measurement procedures were according to ANSI C63.10:2013. The said equipment in the configuration described in this report shows the maximum emission levels emanating

FCC part 15 subpart C

Receipt Date : 11/02/2018

Final Test Date : 12/14/2018

Tested By:

Reviewed by:

Dec. 14, 2018

Dec. 14, 2018

Date

Bing Chang / Engineer

Date

Bell Wei / Manager
Designation Number: TW2954



2. Report of Measurements and Examinations

2.1 List of Measurements and Examinations

FCC Rule	Description of Test	Result
15.203	. Antenna Requirement	Pass
15.207	. Conducted Emission	Pass
15.209 15.247(d)	. Radiated Emission	Pass
15.247(a)(2)	. 6dB Bandwidth	Pass
15.247(b)	. Maximum Peak Output Power	Pass
15.247(d)	. 100kHz Bandwidth of Frequency Band Edges	Pass
15.247(e)	. Power Spectral Density	Pass
1.1307 1.1310 2.1091 2.1093	. RF Exposure Compliance	Pass



3. Test Configuration of Equipment under Test

3.1 Description of the tested samples

EUT Name : Embedded computer / module

Model Number : EC3100

FCCID : 2ACLCECNSDSBC310H80

Receipt Date : 11/02/2018

Power From : Inside Outside
Adaptor Battery AC Power Source DC Power Source
Support Unit PC

Operate Frequency : Refer to the channel list as described below (2.412 ~2.462 GHz)

Modulation Technique : 802.11b : 11 Mbps
802.11g : 54 Mbps
802.11n HT20 : 130 Mbps

Number of Channels : 802.11b, 802.11g, 802.11n, HT20 : 11

Channel spacing : N/A 5 MHz

Operating Mode : Simplex Half Duplex

Antenna Type : dipole antenna

Channel bandwidth : 5 MHz

Antenna gain : 2 dBi



3.2 Carrier Frequency of Channels

802.11b, 802.11g, 802.11n HT 20 (2412MHz~2462MHz)

Channel	Frequency(MHz)	Channel	Frequency(MHz)
01	2412	07	2442
02	2417	08	2447
03	2422	09	2452
04	2427	10	2457
05	2432	11	2462
06	2437	---	---



3.3 Test Mode and Test Software

- a. During testing, the interface cables and equipment positions were varied according to ANSI C63.10.
- b. The complete test system included Notebook and EUT for RF test.
- c. An executive "QATool.exe" under WIN7 was executed to keep transmitting and receiving data via Wireless.
- d. The following test modes were performed for test:
 - 802.11b/g/n HT20: CH01: 2412MHz, CH06: 2437MHz, CH11: 2462MHz



3.4 TEST Methodology & General Test Procedures

All testing as described bellowed were performed in accordance with ANSI C63.10 and FCC CFR 47 Part 15 Subpart C.

Conducted Emissions

The EUT is placed on a wood table, which is at 0.8 m above ground plane acceding to clause 15.207 and requirements of ANSI C63.10. Conducted emissions from the EUT measured in the frequency range between 0.15 MHz and 30MHz are using CISPR Quasi-Peak / Average detectors.

Radiated Emissions

The EUT is a placed on a turn table, which is 0.8 m above ground plane. The turntable was rotated through 360 degrees to determine the position of maximum emission level. The EUT is placed at 3m away from the receiving antenna, which varied from 1m to 4m to find out the highest emission. Each emission was to be maximized by changing the polarization of receiving antenna both horizontal and vertical.

- 1) Putting the EUT on the platform and turning on the EUT (on/off button on the bottom of the EUT).
- 2) Setting test channel described as “Channel setting and operating condition”, and testing channel by channel.
- 3) For the maximum output power measurement, we followed the method of measurement KDB558074 D01.
- 4) For the spurious emission test based on ANSI(2014), at the frequency where below 1GHz used quasi-peak detector mode; where above 1GHz used the peak and average detector mode. IF the peak value may be under average limit, the average mode will not be performed.



3.5 Measurement Uncertainty

Measurement Item	Uncertainty
Radiated emission	$\pm 4.11\text{dB}$
Peak Output Power(conducted)	$\pm 1.38\text{dB}$
Peak Output Power(Radiated)	$\pm 1.70\text{dB}$
Power Spectral Density	$\pm 1.39\text{dB}$
Radiated emission(3m)	$\pm 4.11\text{dB}$
Radiated emission(10m)	$\pm 3.89\text{dB}$

3.6 Description of the Support Equipments

Setup Diagram

CE

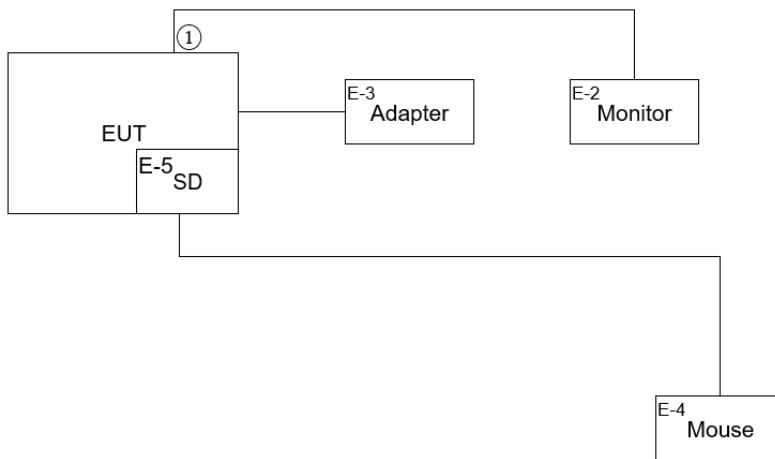

RE

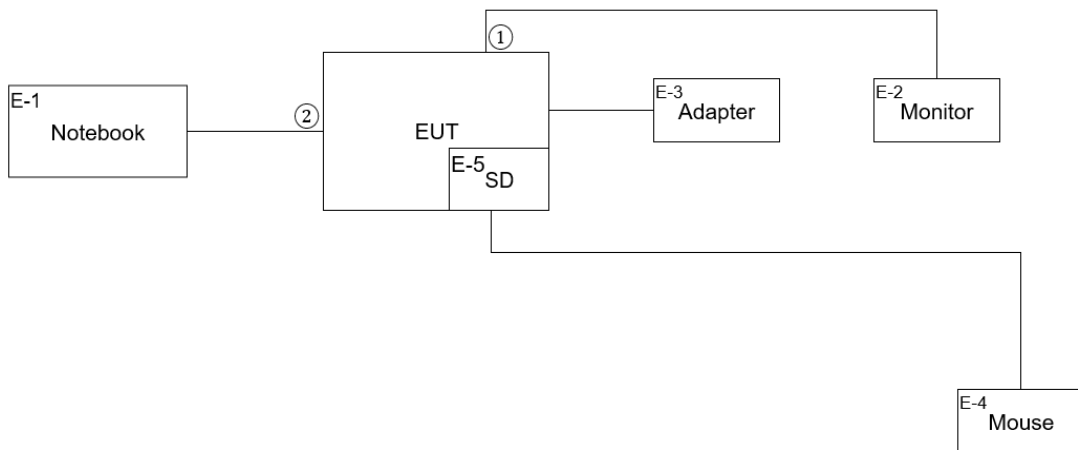



Support Equipment

Peripherals Devices:

OUTSIDE SUPPORT EQUIPMENT							
No.	Equipment	Model	Serial No.	FCC ID/ BSMI ID	Trade name	Data Cable	Power Cord
E-2	Monitor	S2817Qt	NA	R43004	DELL	Shielded 1.8m	Unshielded 1.8m
E-4	Mouse	MS116p	CN-04DW DN-73826 -5CM-012 0	R41108	DELL	Shielded 1.8m / USB	N/A
E-1	Notebook	B470	WB06048 23	R33B65	Lenovo	N/A	Unshielded 1.8m
E-3	Adaptor	LTE-12WS-S 2	N/A	N/A	LTE	N/A	N/A
E-5	SD Card	16G	N/A	N/A	SanDisk	N/A	N/A
EUT							
No.	Equipment	Model	Serial No.	FCC ID/ BSMI ID	Trade name	Data Cable	Power Cord
1	DDR RAM	4GB	NA	NA	NA	NA	NA
2	Flash ROM	16GB	NA	NA	NA	NA	NA

Note: All the above equipment /cable were placed in worse case position to maximize emission signals during emission test

Grounding: Grounding was in accordance with the manufacturer's requirement and conditions for the intended use.



4. Test and measurement equipment

4.1 calibration

The measuring equipment utilized to perform the tests documented in the report has been calibrated once a year or in accordance with the manufacturer's recommendations, and is traceable to recognized national standards.

4.2 equipment

The following list contains measurement equipment used for testing. The equipment conforms to the requirement of CISPR 16-1, ANSI C63.2 and. Other required standards.

Calibration of all test and measurement, including any accessories that may effect such calibration, is checked frequently to ensure the accuracy. Adjustments are made and correction factors are applied in accordance with the instructions contained in the respective.



TABLELIST OF TEST AND MEASUREMENT EQUIPMENT

Test Site	Instrument	Manufacturer	Model No.	S/N	Next Cal. Date
Conduction	Spectrum (9K--3GHz)	R&S	FSP3	833387/010	2019/12/07
	EMI Receiver	R&S	ESHS10	830223/008	2019/06/06
	LISN	Rolf Heine Hochfrequenztechnik	NNB-2/16z	98062	2019/06/11
	ISN	Schwarzbeck	8-Wire ISN CAT5	CAT5-8158-0094	2019/10/19
	RF Cable	N/A	N/A	EMI-3	2019/10/17
Radiation	Bilog antenna(30M-1G)	ETC	MCTD2786B	BLB16M04004/JB-5-004	2019/05/18
	Double Ridged Guide Horn antenna(1G-18G)	ETC	MCTD 1209	DRH15N02009	2019/11/28
	Horn antenna (18G-26G)	com-power	AH-826	81000	2019/08/16
	LOOP Antenna (Below 30M)	com-power	AL-130	17117	2019/11/12
	Pre amplifier (30M-1G)	EMC INSTRUMENT	EMC9135	980334	2019/05/03
	Microwave Preamplifier (1G-18G)	EMC INSTRUMENT	EMC051845	980108&AT-18001	2019/11/27
	Pre amplifier (18G~26G)	MITEQ	JS4-18002600-30-5A	808329	2019/08/09
	EMI Test	R&S	ESVS30	826006/002	2019/11/07



	Receiver		(20M-1000MHz)		
	RF Cable (open site)	EMCI	N male on end of both sides (EMI4)	30m	2019/11/09
	RF CABLE (1~26G)	HARBOUT INDUSTRIES	LL142MI(4M+4M)	NA	2019/04/17
	RF CABLE (1~26G)	HARBOUR INDUSTRIES	LL142MI(7M)	NA	2019/08/09
	Spectrum (9K--7GHz)	R&S	FSP7	830180/006	2019/04/14
	Spectrum (9K--40GHz)	AGILENT	8564EC	4046A0032	2019/03/01
Software	e3	AUDIX	N/A	N/A	N/A
SG	SINGAL GENERATOR (100k-1GHz)	HP	8648A	3619U0042 6	N/A

***CALIBRATION INTERVAL OF INSTRUMENTS LISTED ABOVE IS ONE YEAR**



5. Antenna Requirements

5.1 Standard Applicable

For intentional device, according to FCC 47 CFR Section 15.203, an intentional radiator shall be designed to ensure that no antenna other than that furnished by the responsible party shall be used with the device.

And according to FCC 47 CFR Section 15.247 (b), if transmitting antennas of directional gain greater than 6dBi are used, the power shall be reduced by the amount in dB that the directional gain of the antenna exceeds 6dBi.

5.2 Antenna Construction and Directional Gain

802.11b/g/n:

Antenna Type:dipole antenna

Antenna Gain: 2 dBi



6. Test of Conducted Emission

6.1 Test Limit

Conducted Emissions were measured from 150 kHz to 30 MHz with a bandwidth of 9 KHz on the 120 VAC power and return leads of the EUT according to the methods defined in ANSI C63.4-2014 Section 3.1. The EUT was placed on a nonmetallic stand in a shielded room 0.8 meters above the ground plane as shown in section 2.2. The interface cables and equipment positioning were varied within limits of reasonable applications to determine the position produced maximum conducted emissions.

Frequency (MHz)	Quasi Peak (dB μ V)	Average (dB μ V)
0.15 – 0.5	66-56*	56-46*
0.5 – 5.0	56	46
5.0 – 30.0	60	50

*Decreases with the logarithm of the frequency.

6.2 Test Procedures

- a. The EUT was placed 0.4 meter from the conducting wall of the shielding room was kept at least 80 centimeters from any other grounded conducting surface.
- b. Connect EUT to the power mains through a line impedance stabilization network (LISN).
- c. All the support units are connecting to the other LISN.
- d. The LISN provides 50 ohm coupling impedance for the measuring instrument.
- e. The FCC states that a 50 ohm, 50 micro-Henry LISN should be used.
- f. Both sides of AC line were checked for maximum conducted interference.
- g. The frequency range from 150 kHz to 30 MHz was searched.
- h. Set the test-receiver system to Peak Detect Function and Specified Bandwidth with Maximum Hold Mode.



6.3 Typical Test Setup

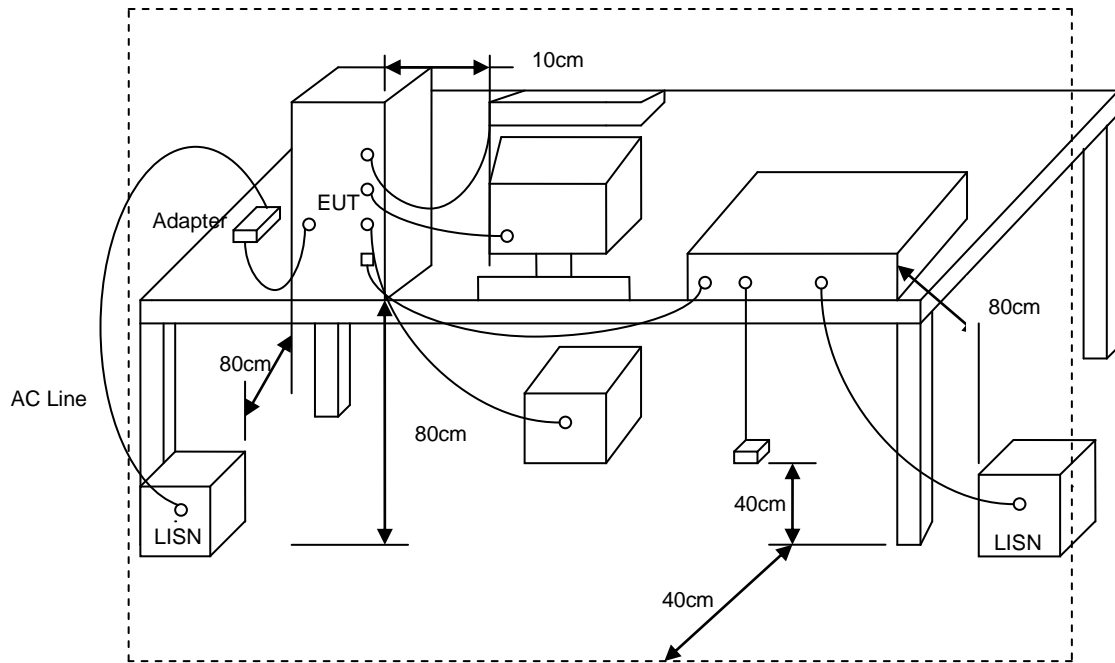



6.4 Test Result and Data

Power	: AC 110V	Pol/Phase	: LINE
Test Mode	: TX b CH11 2462MHz	Temperature	: 24 °C
Memo	:	Humidity	: 53 %

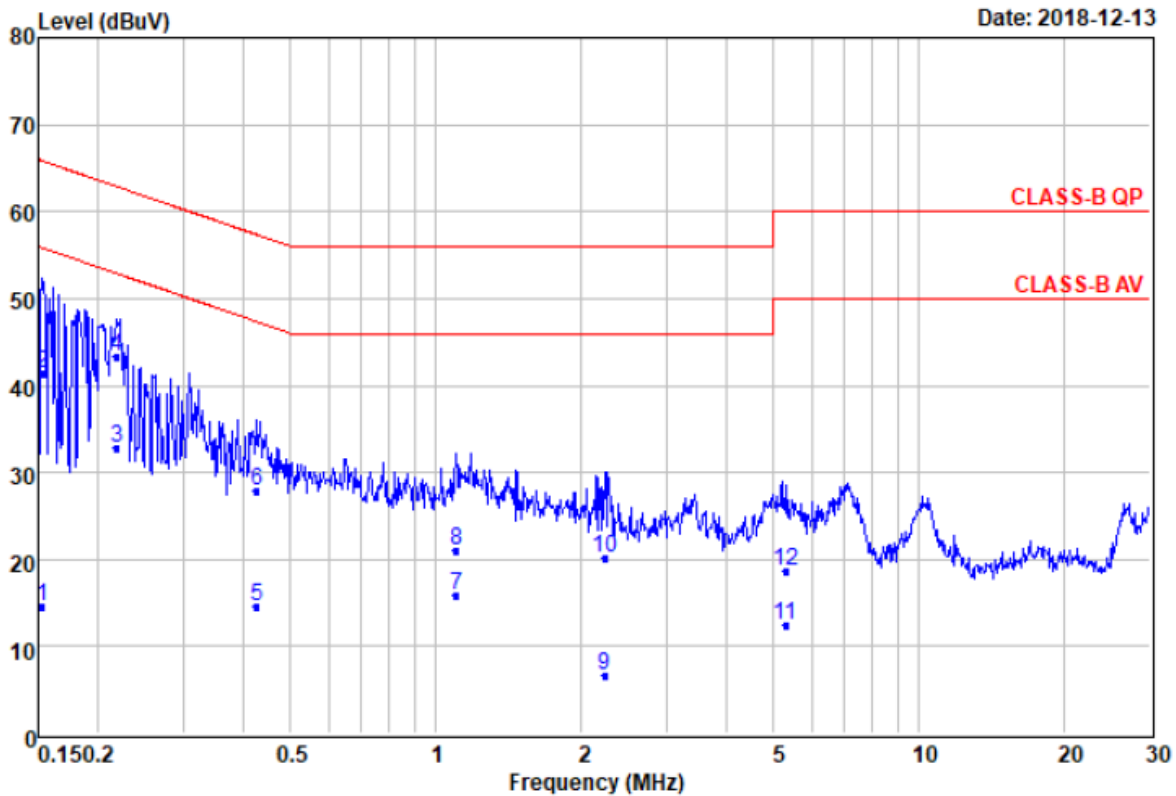

Remarks

: Factor=Insrtion loss+Cable loss

	Read	Over	Limit			
Freq	Level	Level	Factor	Limit	Line	Remark
MHz	dBuV	dBuV	dB	dB	dBuV	
1	0.15	4.59	14.69	10.10	-41.13	55.82 Average
2	0.15	31.30	41.40	10.10	-24.42	65.82 QP
3 A	0.22	22.82	32.91	10.09	-19.97	52.88 Average
4 @	0.22	33.16	43.25	10.09	-19.63	62.88 QP
5	0.43	4.52	14.62	10.10	-32.71	47.33 Average
6	0.43	17.78	27.88	10.10	-29.45	57.33 QP
7	1.10	5.77	15.90	10.13	-30.10	46.00 Average
8	1.10	10.79	20.92	10.13	-35.08	56.00 QP
9	2.24	-3.61	6.58	10.19	-39.42	46.00 Average
10	2.24	10.02	20.21	10.19	-35.79	56.00 QP
11	5.28	2.11	12.40	10.29	-37.60	50.00 Average
12	5.28	8.42	18.71	10.29	-41.29	60.00 QP



Power	: AC 110V	Pol/Phase	: NEUTRAL
Test Mode	: TX b CH11 2462MHz	Temperature	: 24 °C
Memo	:	Humidity	: 53 %

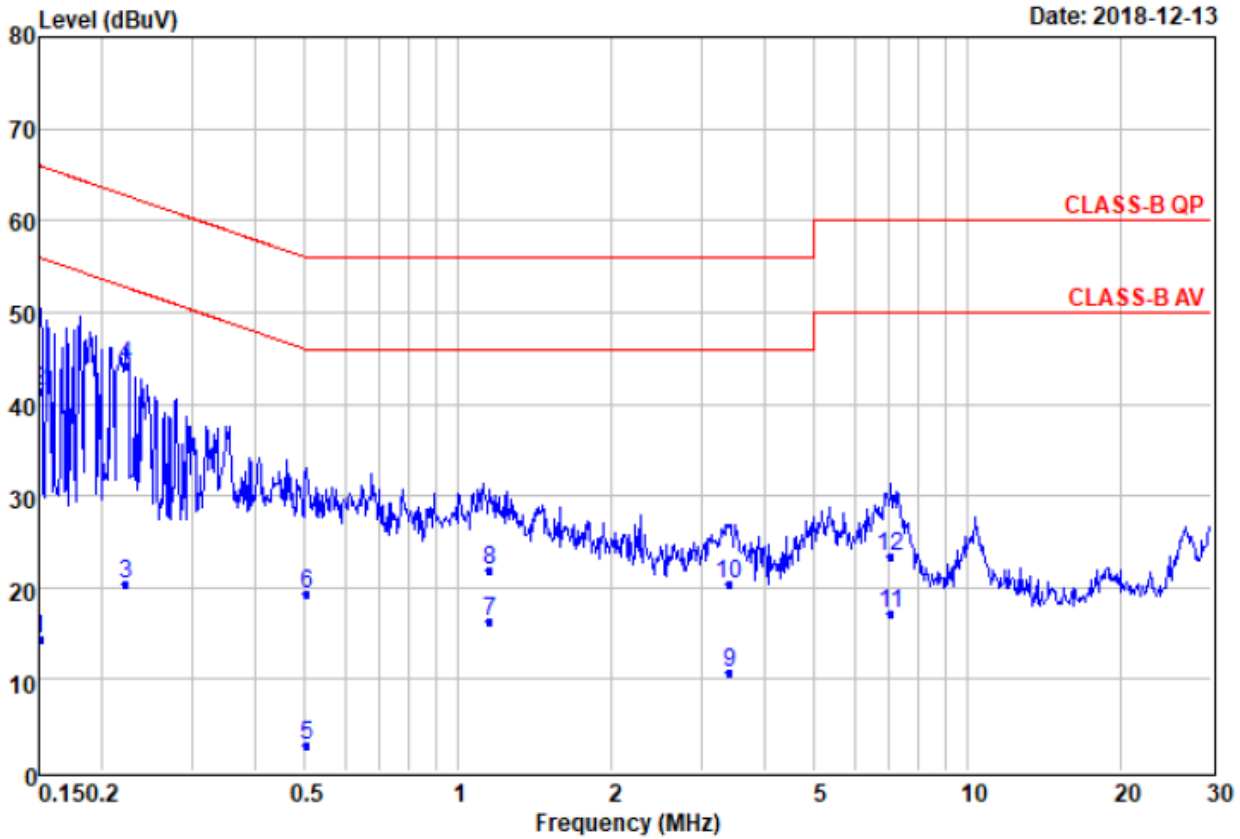

Remarks

: Factor=Insrtion loss+Cable loss

	Freq	Read Level	Level	Factor	Over Limit	Limit Line	Remark
	MHz	dBuV	dBuV	dB	dB	dBuV	
1	0.15	4.38	14.46	10.08	-41.50	55.96	Average
2	0.15	31.36	41.44	10.08	-24.52	65.96	QP
3	0.22	10.36	20.44	10.08	-32.30	52.74	Average
4	0.22	34.08	44.16	10.08	-18.58	62.74	QP
5	0.50	-7.21	2.89	10.10	-43.11	46.00	Average
6	0.50	9.16	19.26	10.10	-36.74	56.00	QP
7	1.15	6.10	16.23	10.13	-29.77	46.00	Average
8	1.15	11.80	21.93	10.13	-34.07	56.00	QP
9	3.40	0.42	10.63	10.21	-35.37	46.00	Average
10	3.40	10.21	20.42	10.21	-35.58	56.00	QP
11	7.06	6.76	17.08	10.32	-32.92	50.00	Average
12	7.06	12.97	23.29	10.32	-36.71	60.00	QP



7. Test of Radiated Emission

7.1 Test Limit

In any 100kHz bandwidth outside the frequency band in which the spread spectrum or digitally modulated intentional radiator is operating, the radio frequency power that is produced by the intentional radiator shall be at least 20dB below that in the 100kHz bandwidth within the band that contains the highest level of the desired power, based on either an RF conducted or a radiated measurement. If the transmitter measurement is based on the maximum conducted output power, the attenuation required under this paragraph shall be 30dB instead of 20dB. In addition, radiated emissions which fall in section 15.205(a) the restricted bands must also comply with the radiated emission limit specified in section 15.209(a).

Frequency (MHz)	Field Strength (microvolt/meter)	Measurement Distance (meters)
0.009 ~ 0.490	2400/F(kHz)	300
0.490 ~ 1.705	24000/F(kHz)	30
1.705 ~ 30.0	30	30
30 ~ 88	100	3
88 ~ 216	150	3
216 ~ 960	200	3
Above 960	500	3

7.2 Test Procedures

- a. The EUT was placed on a rotatable table top 0.8 meter above ground.
- b. The EUT was set 3 meters from the interference receiving antenna which was mounted on the top of a variable height antenna tower.
- c. The table was rotated 360 degrees to determine the position of the highest radiation.
- d. The antenna is a broadband antenna and its height is varied between one meter and four meters above ground to find the maximum value of the field strength both horizontal polarization and vertical polarization of the antenna are set to make the measurement.
- e. For each suspected emission the EUT was arranged to its worst case and then tune the antenna tower (from 1 M to 4 M) and turn table (from 0 degree to 360 degrees) to find the maximum reading.
- f. Set the test-receiver system to Peak or CISPR quasi-peak Detect Function and specified bandwidth with Maximum Hold Mode.
- g. If the emission level of the EUT in peak mode was 3 dB lower than the limit specified, then testing will be stopped and peak values of EUT will be reported, otherwise, the emissions which do not have 3 dB margin will be repeated one by one using the quasi-peak method and reported.
- h. For testing above 1GHz, the emission level of the EUT in peak mode was 20dB lower than



average limit (that means the emission level in peak mode also complies with the limit in average mode), then testing will be stopped and peak values of EUT will be reported, otherwise, the emissions will be measured in average mode again and reported.

- i. "Cone of radiation" has been considered to be 3dB bandwidth of the measurement antenna.



7.3 Typical Test Setup

For radiated emissions below 30MHz

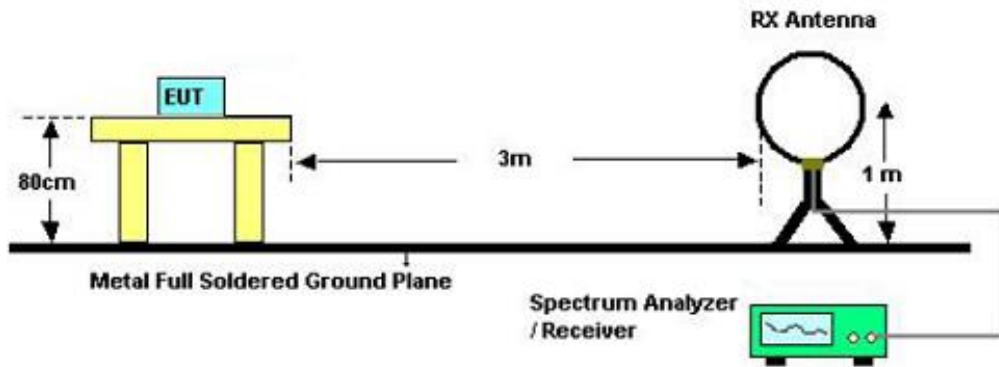

For radiated emissions above 30MHz

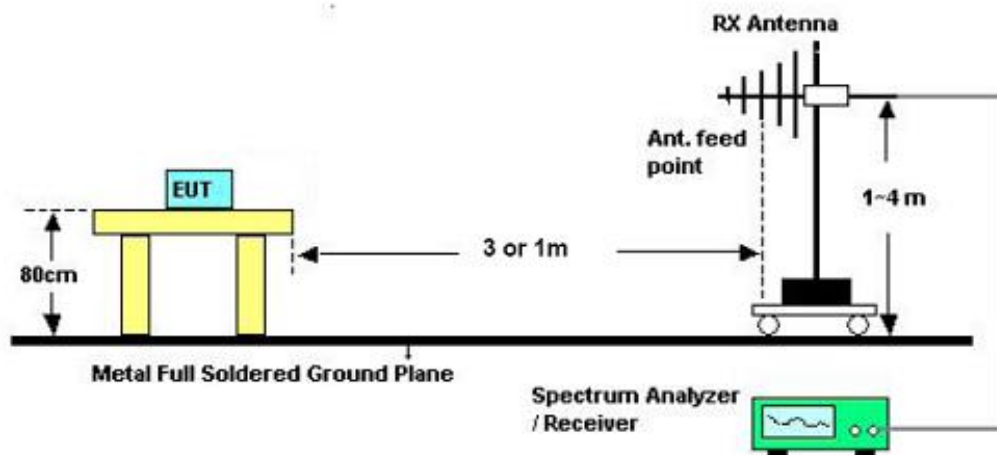

For radiated emissions above 1GHz

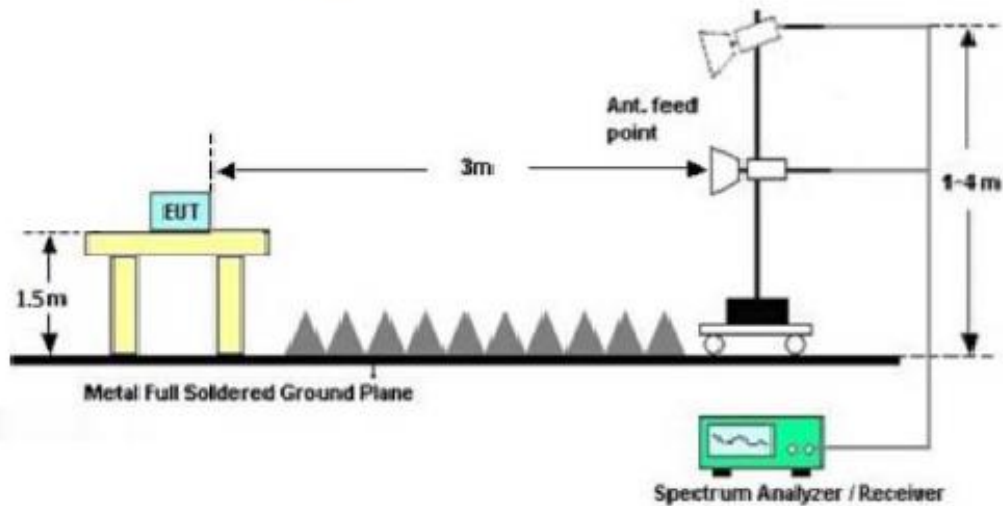



7.4 Test Result and Data (9kHz ~ 30MHz)

The 9kHz - 30MHz spurious emission is under limit 20dB more.

7.5 Test Result and Data (30MHz ~ 1GHz, worst emissions found)

Power	: AC 110V	Pol/Phase	: HORIZONTAL
Test Mode	: TX b CH11 2462MHz	Temperature	: 17 °C
Memo	:	Humidity	: 72 %

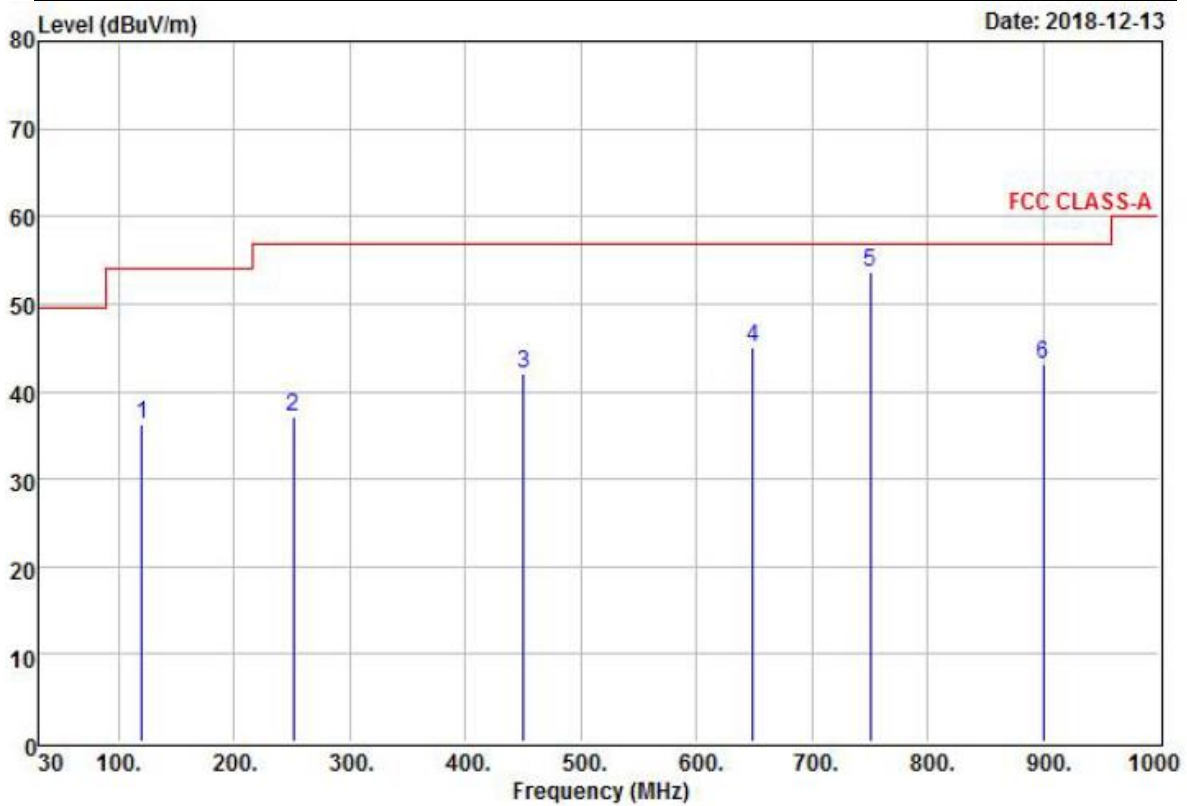

Remarks : 1.Result=Read Value+Factor
: 2.Factor=Antenna Factor-Cable loss-
: Amplifier Factor

	Freq	Read	Factor	Level	Limit	Over	Remark
	MHz	dBuV	dB/m	dBuV/m	dBuV/m	dB	
1	119.89	51.43	-15.19	36.24	54.00	-17.76	QP
2	250.93	52.56	-15.37	37.19	56.90	-19.71	QP
3	450.23	52.08	-10.07	42.01	56.90	-14.89	QP
4	649.00	52.14	-7.13	45.01	56.90	-11.89	QP
5 @	750.56	59.54	-5.83	53.71	56.90	-3.19	QP
6	900.03	46.85	-3.76	43.09	56.90	-13.81	QP



Power	: AC 110V	Pol/Phase	: VERTICAL
Test Mode	: TX b CH11 2462MHz	Temperature	: 17 °C
Memo	:	Humidity	: 72 %

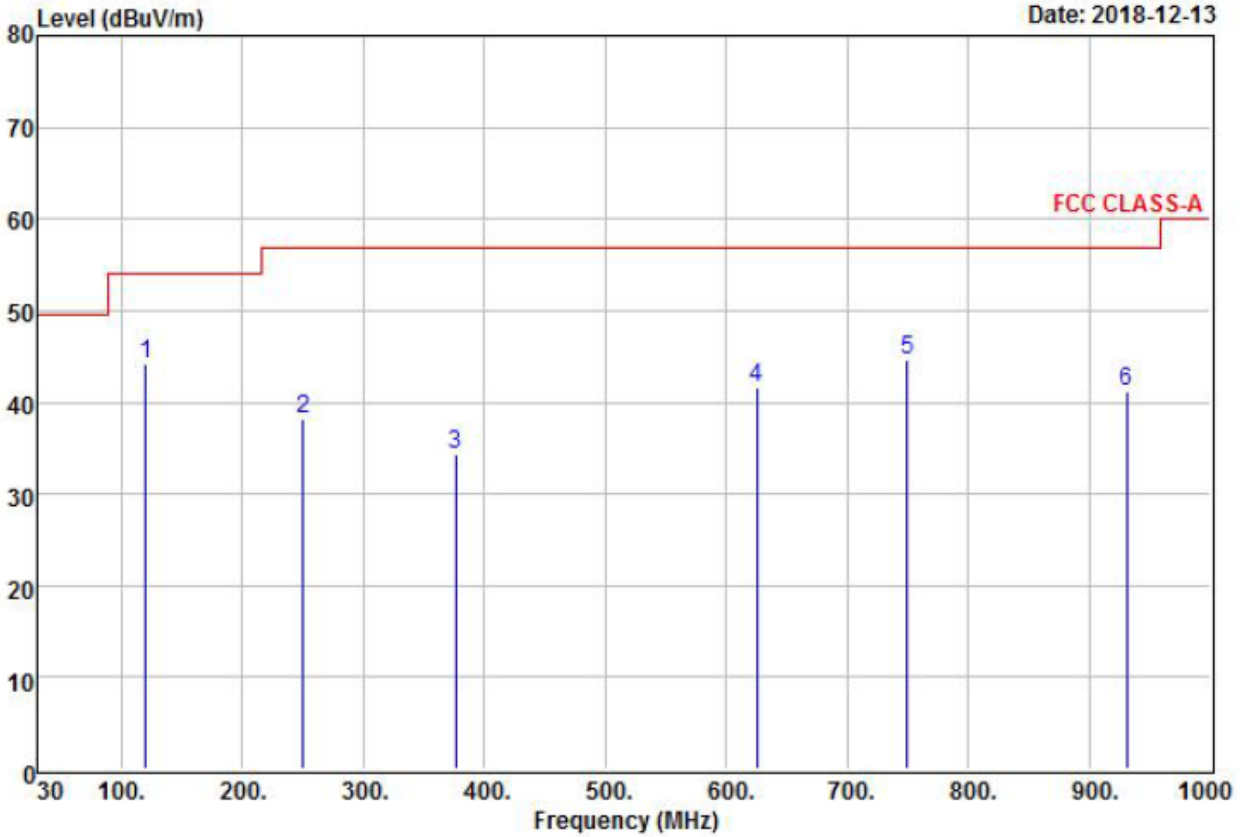

 Remarks : 1.Result=Read Value+Factor
 : 2.Factor=Antenna Factor-Cable loss-
 : Amplifier Factor

	Freq	Read Level	Factor	Level	Limit Line	Over Limit	Remark
	MHz	dBuV	dB/m	dBuV/m	dBuV/m	dB	
1 @	119.74	59.44	-15.20	44.24	54.00	-9.76	QP
2	250.13	53.61	-15.42	38.19	56.90	-18.71	QP
3	375.96	45.77	-11.45	34.32	56.90	-22.58	QP
4	625.39	49.65	-8.07	41.58	56.90	-15.32	QP
5	750.00	50.55	-5.84	44.71	56.90	-12.19	QP
6	931.12	43.27	-2.14	41.13	56.90	-15.77	QP



7.6 Test Result and Data (Above 1GHz)

Power	: AC 110V	Test Date	: 2018/12/14
Temperature	: 17 °C	Humidity	: 72 %
Test Mode	802.11b		

1GHz—25GHz Radiated emission Test result

Channel 1 Fundamental Frequency: 2412 MHz

Frequency (MHz)	Ant-Pol H/V	Meter Reading (dBuV)	Corrected Factor (dB)	Result (dBuV/m)	Remark	Limit (dBuV/m)		Margin (dB)
						Peak	Ave	
4824.00	H	53.38	-5.26	48.12	Peak	74	54	-25.88
---	H	---	---	---	Ave	74	54	---
4824.00	V	53.25	-5.26	47.99	Peak	74	54	-26.01
---	V	---	---	---	Ave	74	54	---

Channel 6 Fundamental Frequency: 2437 MHz

Frequency (MHz)	Ant-Pol H/V	Meter Reading (dBuV)	Corrected Factor (dB)	Result (dBuV/m)	Remark	Limit (dBuV/m)		Margin (dB)
						Peak	Ave	
4874.00	H	54.15	-5.10	49.05	Peak	74	54	-24.95
---	H	---	---	---	Ave	74	54	---
4874.00	V	53.83	-5.10	48.73	Peak	74	54	-25.27
---	V	---	---	---	Ave	74	54	---

Channel 11 Fundamental Frequency: 2462 MHz

Frequency (MHz)	Ant-Pol H/V	Meter Reading (dBuV)	Corrected Factor (dB)	Result (dBuV/m)	Remark	Limit (dBuV/m)		Margin (dB)
						Peak	Ave	
4924.00	H	53.39	-4.93	48.46	Peak	74	54	-25.54
---	H	---	---	---	Ave	74	54	---
4924.00	V	53.29	-4.93	48.36	Peak	74	54	-25.64
---	V	---	---	---	Ave	74	54	---

1. Emission level = Reading level + Correction factor
2. Correction factor : Antenna factor, Cable loss, Pre-Amp, etc.
3. Measuring frequency from 1GHz to 25GHz
4. Measurements above 1000 MHz, Peak detector setting: 1 MHz RBW with 1 MHz VBW.
5. Measurements above 1000 MHz, Average detector setting: 1 MHz RBW with 10Hz VBW.
6. Peak detector measurement data will represent the worst case results.
7. Where limits are specified for both average and peak detector functions, if the peak measured value complies with the average limit, it is unnecessary to perform an average measurement.
8. The other emission levels were 20dB below the limit.



Power	: AC 110V	Test Date	: 2018/12/14
Temperature	: 17 °C	Humidity	: 72 %
Test Mode	802.11g		

1GHz—25GHz Radiated emission Test result

Channel 1		Fundamental Frequency: 2412 MHz						
Frequency (MHz)	Ant-Pol H/V	Meter Reading (dBuV)	Corrected Factor (dB)	Result (dBuV/m)	Remark	Limit (dBuV/m)		Margin (dB)
						Peak	Ave	
4824.00	H	54.22	-5.26	48.96	Peak	74	54	-25.04
---	H	---	---	---	Ave	74	54	---
4824.00	V	53.90	-5.26	48.64	Peak	74	54	-25.36
---	V	---	---	---	Ave	74	54	---
Channel 6		Fundamental Frequency: 2437 MHz						
Frequency (MHz)	Ant-Pol H/V	Meter Reading (dBuV)	Corrected Factor (dB)	Result (dBuV/m)	Remark	Limit (dBuV/m)		Margin (dB)
						Peak	Ave	
4874.00	H	54.51	-5.10	49.41	Peak	74	54	-24.59
---	H	---	---	---	Ave	74	54	---
4874.00	V	54.21	-5.10	49.11	Peak	74	54	-24.89
---	V	---	---	---	Ave	74	54	---
Channel 11		Fundamental Frequency: 2462 MHz						
Frequency (MHz)	Ant-Pol H/V	Meter Reading (dBuV)	Corrected Factor (dB)	Result (dBuV/m)	Remark	Limit (dBuV/m)		Margin (dB)
						Peak	Ave	
4924.00	H	54.82	-4.93	49.89	Peak	74	54	-24.21
---	H	---	---	---	Ave	74	54	---
4924.00	V	54.41	-4.93	49.48	Peak	74	54	-24.52
---	V	---	---	---	Ave	74	54	---

1. Emission level = Reading level + Correction factor
2. Correction factor : Antenna factor, Cable loss, Pre-Amp, etc.
3. Measuring frequency from 1GHz to 25GHz
4. Measurements above 1000 MHz, Peak detector setting: 1 MHz RBW with 1 MHz VBW.
5. Measurements above 1000 MHz, Average detector setting: 1 MHz RBW with 10Hz VBW.
6. Peak detector measurement data will represent the worst case results.
7. Where limits are specified for both average and peak detector functions, if the peak measured value complies with the average limit, it is unnecessary to perform an average measurement.
8. The other emission levels were 20dB below the limit.



Power	: AC 110V	Test Date	: 2018/12/14
Temperature	: 17 °C	Humidity	: 72 %
Test Mode	802.11n HT20		

1GHz—25GHz Radiated emission Test result

Channel 1						Fundamental Frequency: 2412 MHz		
Frequency (MHz)	Ant-Pol H/V	Meter Reading (dBuV)	Corrected Factor (dB)	Result (dBuV/m)	Remark	Limit (dBuV/m)		Margin (dB)
						Peak	Ave	
4824.00	H	54.91	-5.26	49.65	Peak	74	54	-24.35
---	H	---	---	---	Ave	74	54	---
4824.00	V	54.53	-5.26	49.27	Peak	74	54	-24.73
---	V	---	---	---	Ave	74	54	---

Channel 6						Fundamental Frequency: 2437 MHz		
Frequency (MHz)	Ant-Pol H/V	Meter Reading (dBuV)	Corrected Factor (dB)	Result (dBuV/m)	Remark	Limit (dBuV/m)		Margin (dB)
						Peak	Ave	
4874.00	H	55.09	-5.10	49.99	Peak	74	54	-24.01
---	H	---	---	---	Ave	74	54	---
4874.00	V	54.80	-5.10	49.70	Peak	74	54	-24.30
---	V	---	---	---	Ave	74	54	---

Channel 11						Fundamental Frequency: 2462 MHz		
Frequency (MHz)	Ant-Pol H/V	Meter Reading (dBuV)	Corrected Factor (dB)	Result (dBuV/m)	Remark	Limit (dBuV/m)		Margin (dB)
						Peak	Ave	
4924.00	H	55.23	-4.93	50.30	Peak	74	54	-23.70
---	H	---	---	---	Ave	74	54	---
4924.00	V	54.93	-4.93	50.00	Peak	74	54	-24.00
---	V	---	---	---	Ave	74	54	---

1. Emission level = Reading level + Correction factor
2. Correction factor : Antenna factor, Cable loss, Pre-Amp, etc.
3. Measuring frequency from 1GHz to 25GHz
4. Measurements above 1000 MHz, Peak detector setting: 1 MHz RBW with 1 MHz VBW.
5. Measurements above 1000 MHz, Average detector setting: 1 MHz RBW with 10Hz VBW.
6. Peak detector measurement data will represent the worst case results.
7. Where limits are specified for both average and peak detector functions, if the peak measured value complies with the average limit, it is unnecessary to perform an average measurement.
8. The other emission levels were 20dB below the limit.



8. 6dB Bandwidth Measurement Data

8.1 Test Limit

The minimum of 6dB Bandwidth Measurement is 0.5 MHz.

8.2 Test Procedures

- a. The transmitter output was connected to the spectrum analyzer.
- b. Set RBW of spectrum analyzer to 1~5% of the emission bandwidth and $VBW \geq 3x RBW$.
- c. The 6 dB bandwidth is defined as the total spectrum the power of which is higher than peak power minus 6 dB.
- d. The 6dB Bandwidth was measured and recorded.

8.3 Test Setup Layout

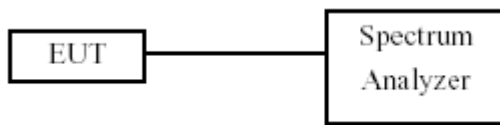



8.4 Test Result and Data

Test Date: Dec. 13, 2018

Temperature: 22 °C

Atmospheric pressure: 1002 pha

Humidity: 57 %

Modulation Standard	Channel	Frequency (MHz)	6dB Bandwidth (MHz)
802.11b (11Mbps)	01	2412	8.56
	06	2437	8.08
	11	2462	8.16
802.11g (6Mbps)	01	2412	16.24
	06	2437	16.36
	11	2462	16.24
802.11n HT20 (6.5Mbps)	01	2412	17.52
	06	2437	17.48
	11	2462	17.52



Modulation Standard: 802.11b (11Mbps)
Channel: 01

Date: 2018-12-13

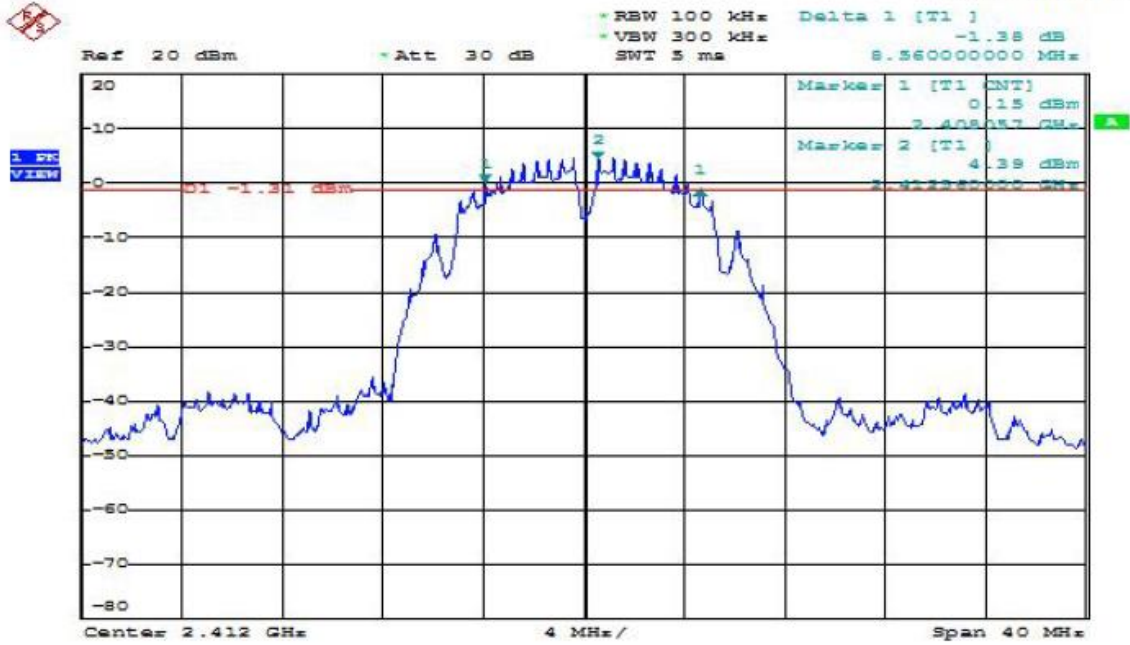

Date: 13.DEC.2018 15:18:56

Modulation Standard: 802.11b (11Mbps)
Channel: 06

Date: 2018-12-13

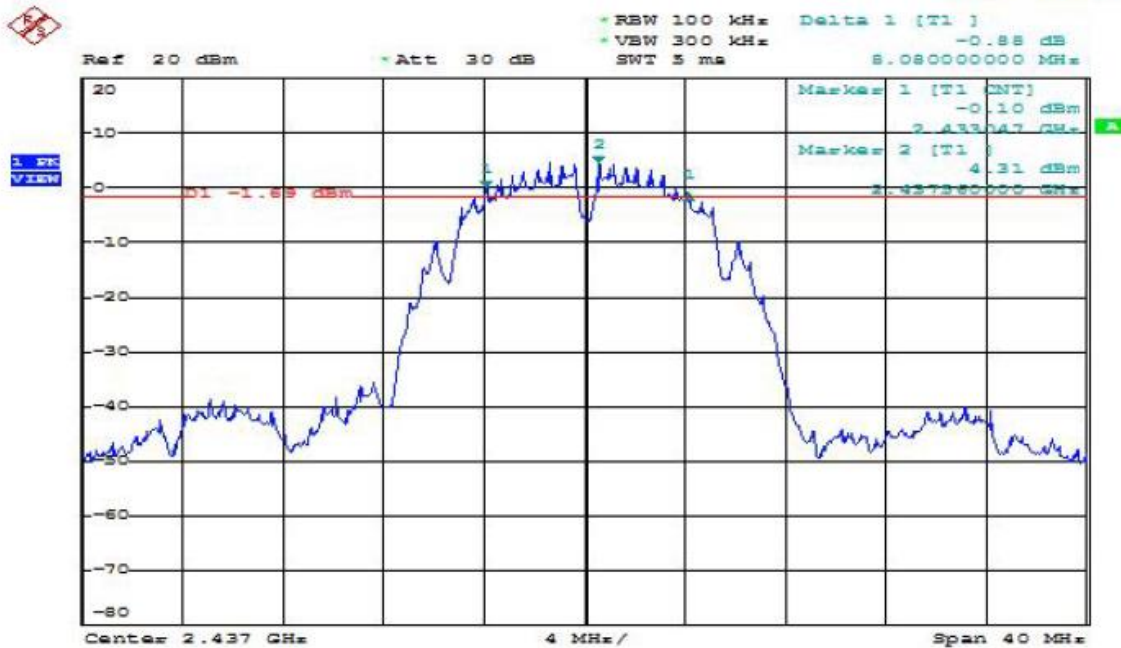

Date: 13.DEC.2018 15:19:56



Modulation Standard: 802.11b (11Mbps)
Channel: 11

Date: 2018-12-13

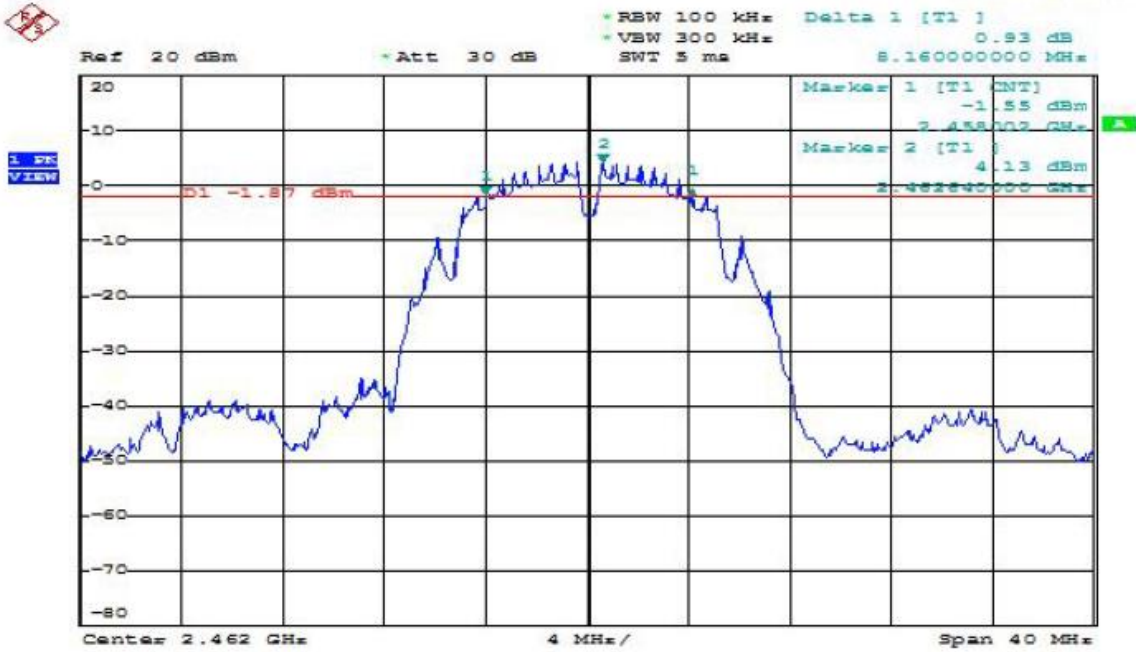

Date: 13.DEC.2018 15:21:04

Modulation Standard: 802.11g (6Mbps)
Channel: 01

Date: 2018-12-13

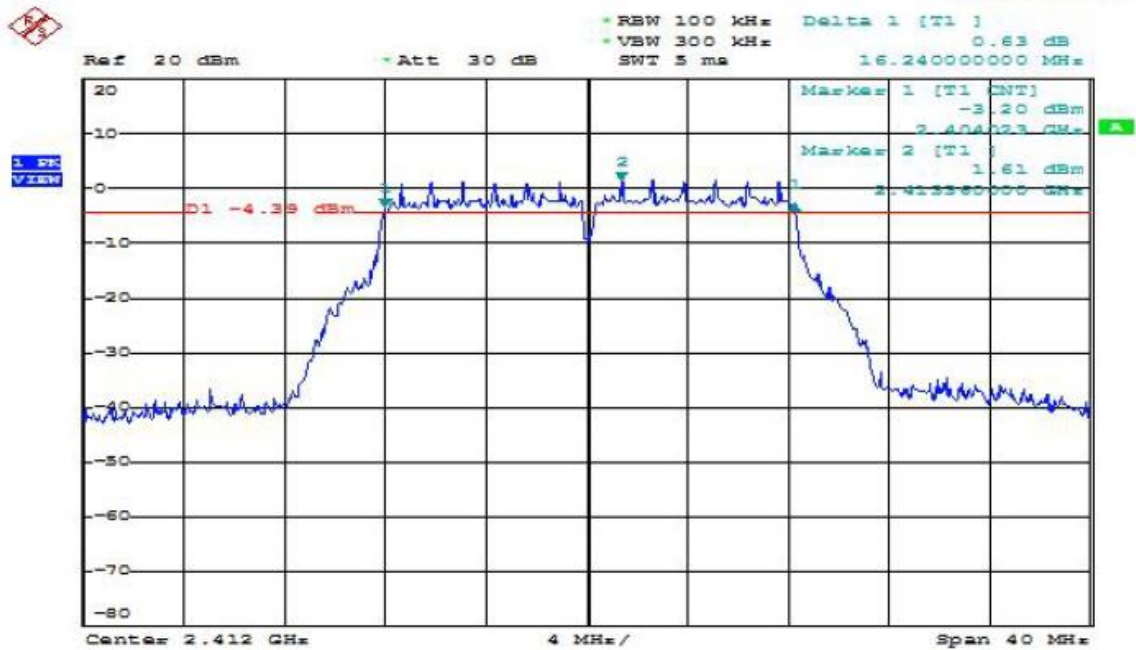

Date: 13.DEC.2018 15:22:29



Modulation Standard: 802.11g (6Mbps)
Channel: 06

Date: 2018-12-13

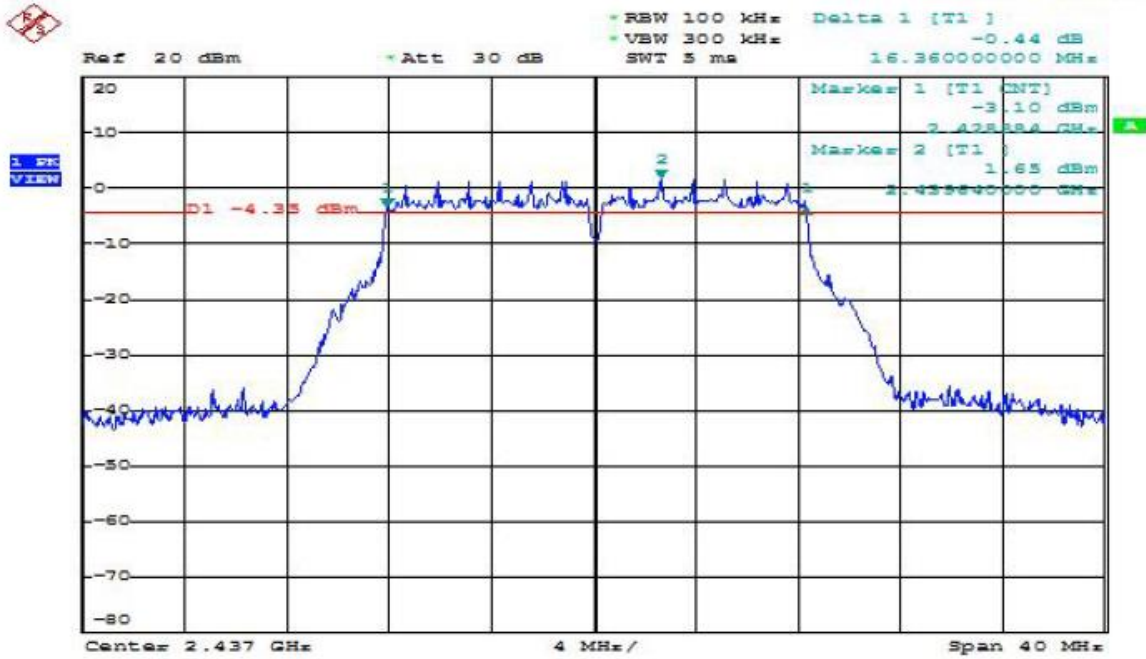

Date: 13.DEC.2018 15:24:07

Modulation Standard: 802.11g (6Mbps)
Channel: 11

Date: 2018-12-13

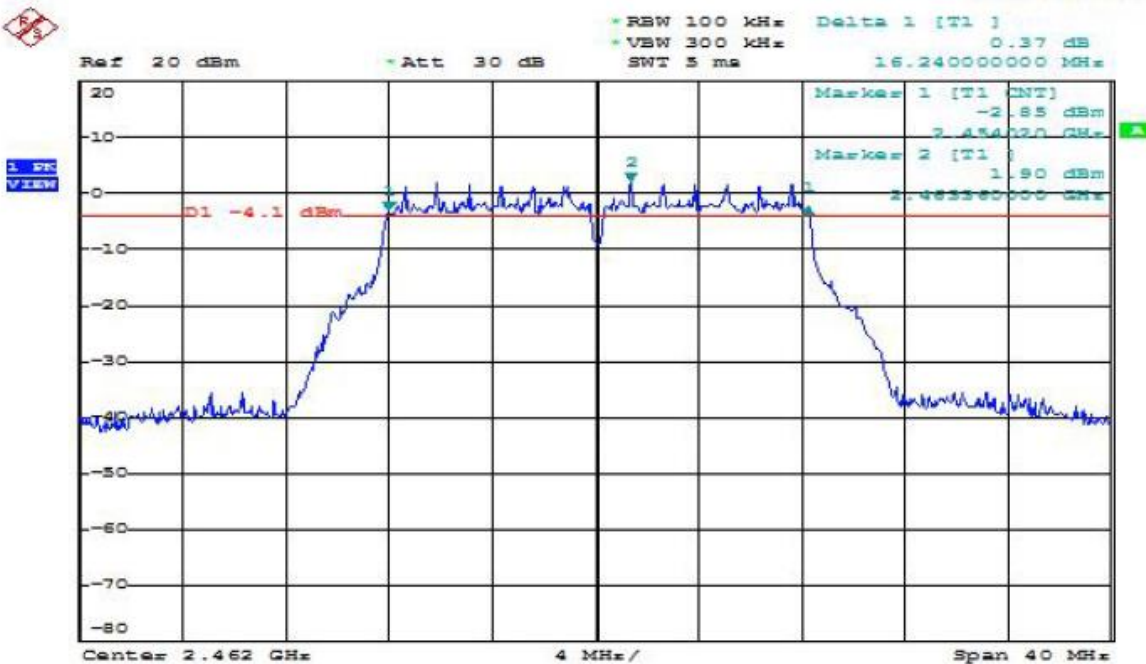

Date: 13.DEC.2018 15:26:08



Modulation Standard: 802.11n HT20 (6.5Mbps)
Channel: 01

Date: 2018-12-13

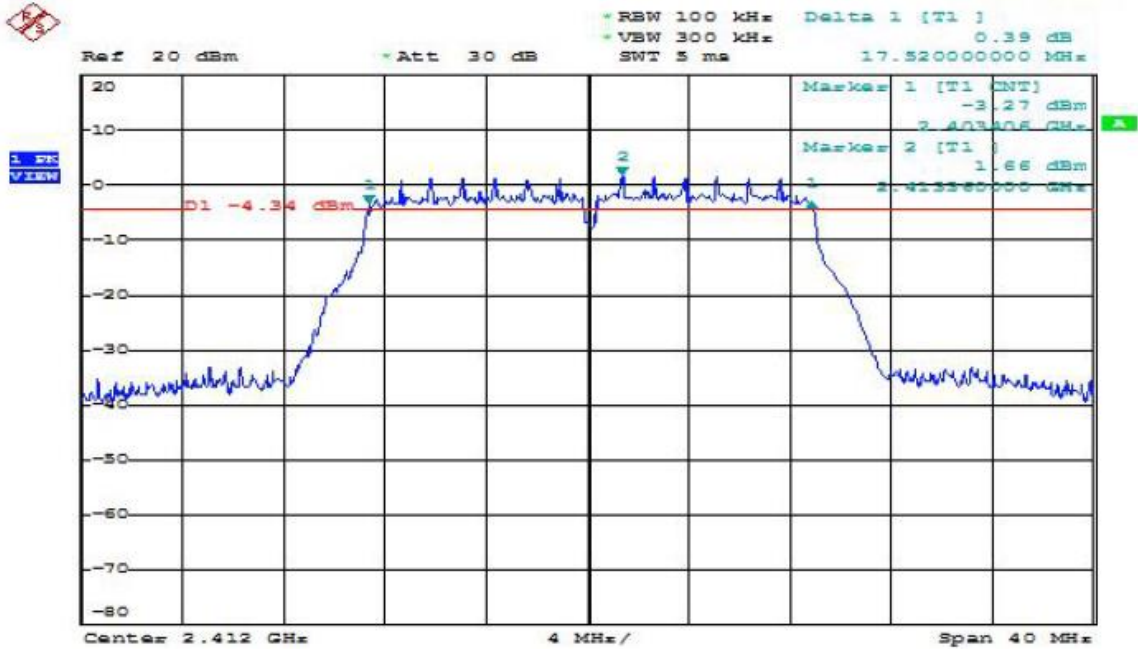

Date: 13.DEC.2018 15:29:43

Modulation Standard: 802.11n HT20 (6.5Mbps)
Channel: 06

Date: 2018-12-13

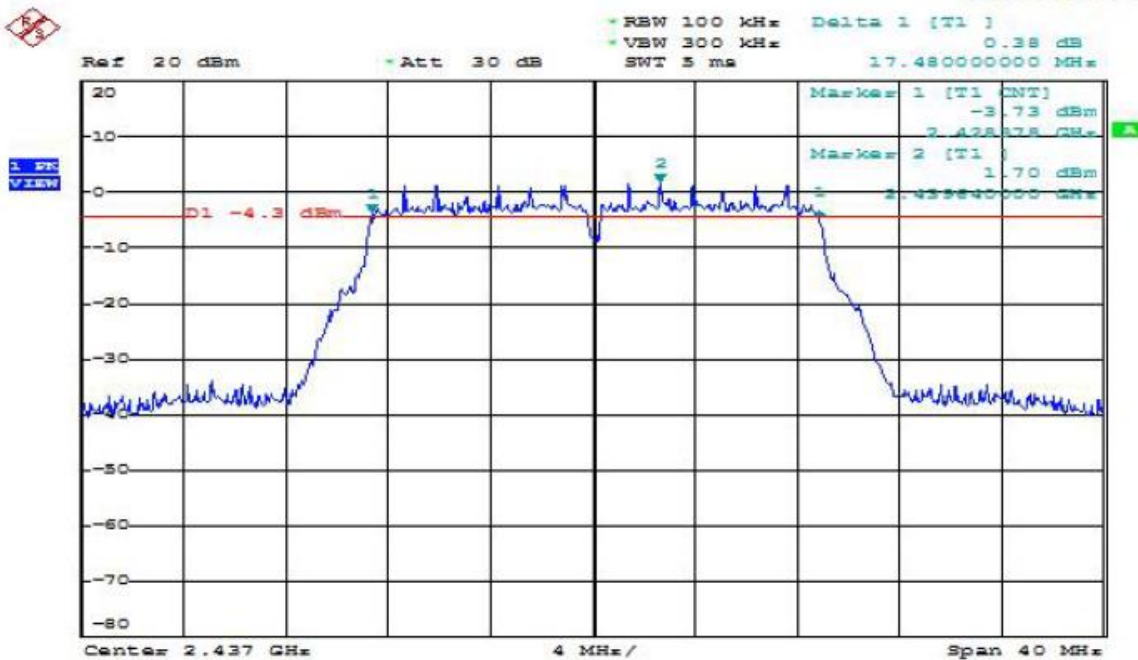

Date: 13.DEC.2018 15:30:35



Modulation Standard: 802.11n HT20 (6.5Mbps)
Channel: 11

Date: 2018-12-13

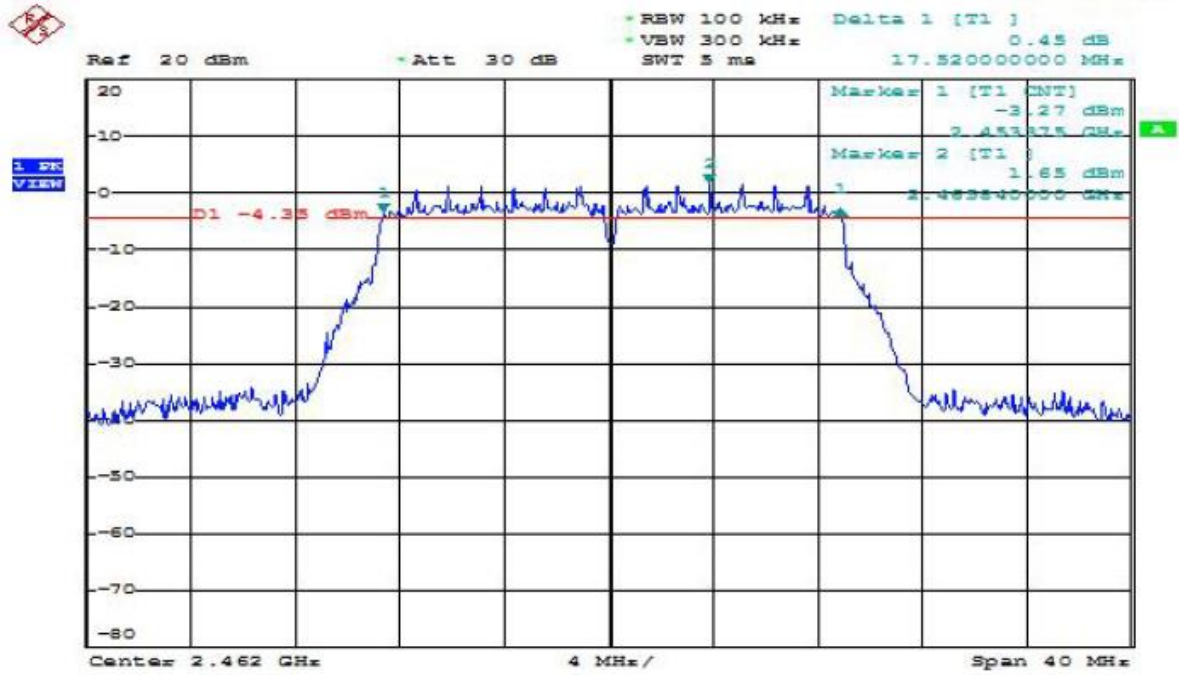

Date: 13.DEC.2018 15:31:33



9. Maximum Peak Output Power

9.1 Test Limit

The Maximum Peak Output Power Measurement is 30dBm.

9.2 Test Procedures

- a. The transmitter output was connected to spectrum analyzer.
- b. The spectrum analyzer's resolution bandwidth were set at 1MHz RBW and 3MHz VBW as that of the fundamental frequency. Set the sweep time=auto couple.
- c. Use the spectrum analyzer's band/channel power measurement function with the band limits set equal to the DTS bandwidth edges (for some analyzers, this may require a manual override to ensure use of peak detector).
- d. Employ trace averaging in power averaging (RMS) mode over a minimum of 100 traces.
- e. Use the spectrum analyzer's band power measurement function with band limits set equal to the EBW band edges.
- f. The peak and average output power was measured and recorded.

9.3 Test Setup Layout

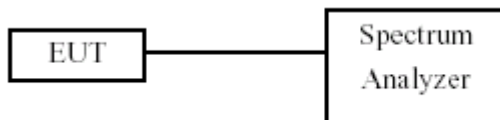



9.4 Test Result and Data

Test Date: Dec. 14, 2018

Temperature: 22 °C

Atmospheric pressure: 1002 pha

Humidity: 57 %

Modulation Standard	Channel	Frequency (MHz)	Peak Power Output (dBm)	Peak Power Output(mW)
802.11b (11Mbps)	01	2412	15.98	39.627
	06	2437	16.33	42.953
	11	2462	16.22	41.879
802.11g (6Mbps)	01	2412	21.24	133.045
	06	2437	21.38	137.404
	11	2462	21.47	140.281

Modulation Standard	Channel	Frequency (MHz)	Peak Power Output (dBm)	Peak Power Output (mW)
802.11n HT20 (6.5Mbps)	01	2412	21.28	134.276
	06	2437	21.43	138.995
	11	2462	21.53	142.232



Peak Output Power

Modulation Standard: 802.11b (11Mbps)

Channel: 01

Date: 2018-12-13

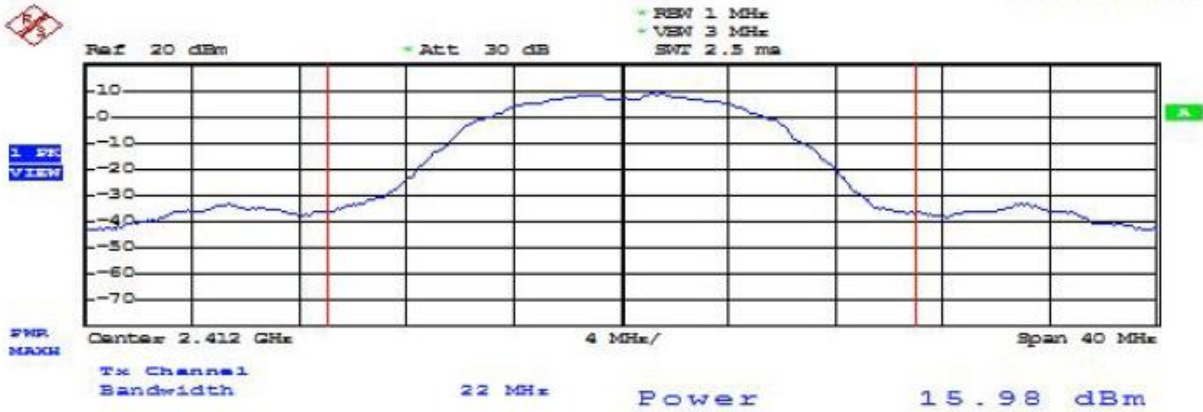

Modulation Standard: 802.11b (11Mbps)

Channel: 06

Date: 2018-12-13

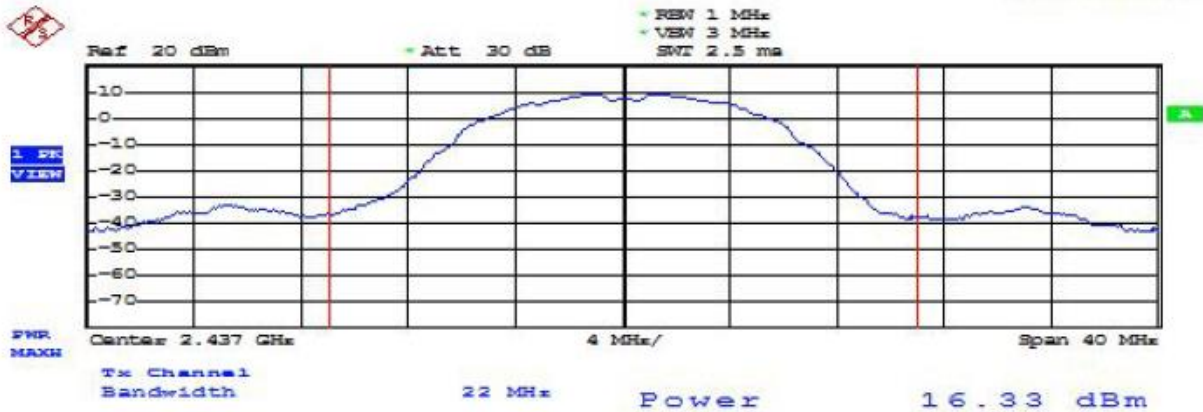

Modulation Standard: 802.11b (11Mbps)

Channel: 11

Date: 2018-12-13

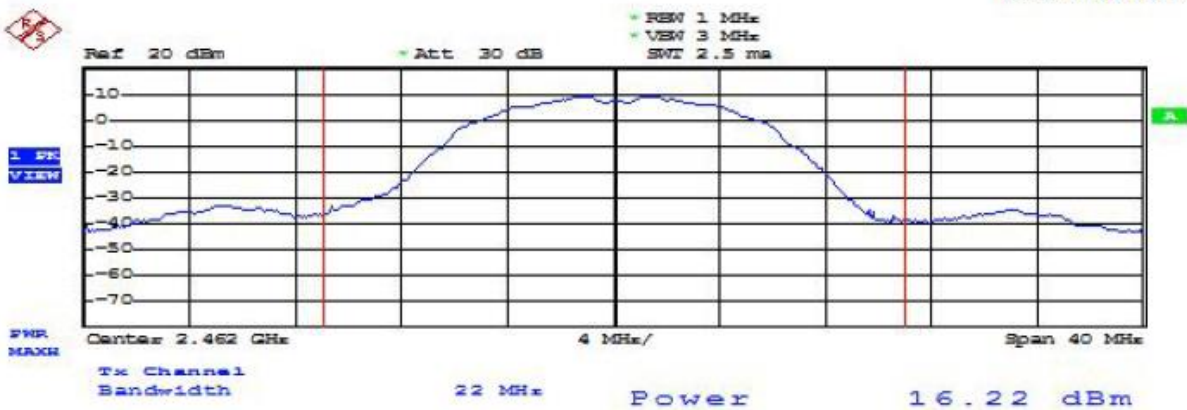



Modulation Standard: 802.11g (6Mbps)
Channel: 01

Date: 2018-12-13

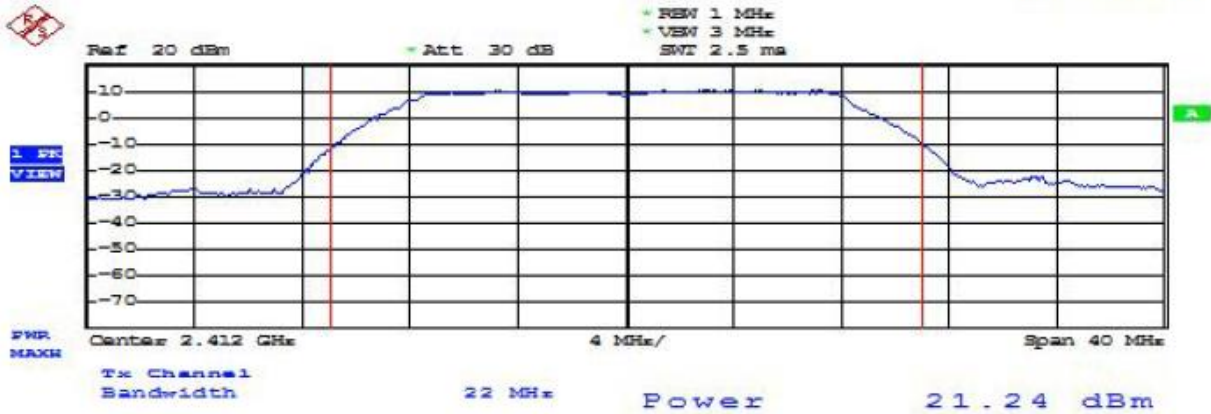

Modulation Standard: 802.11g (6Mbps)
Channel: 06

Date: 2018-12-13

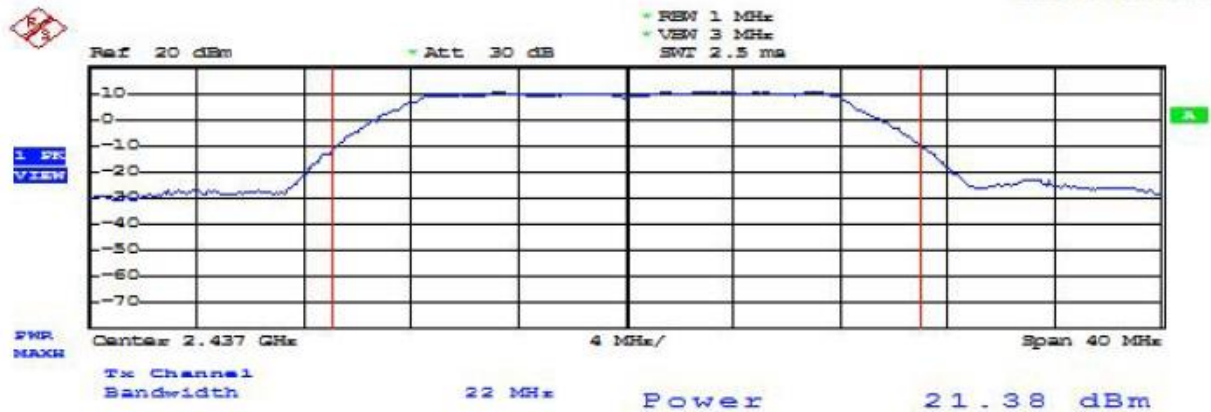

Modulation Standard: 802.11g (6Mbps)
Channel: 11

Date: 2018-12-13

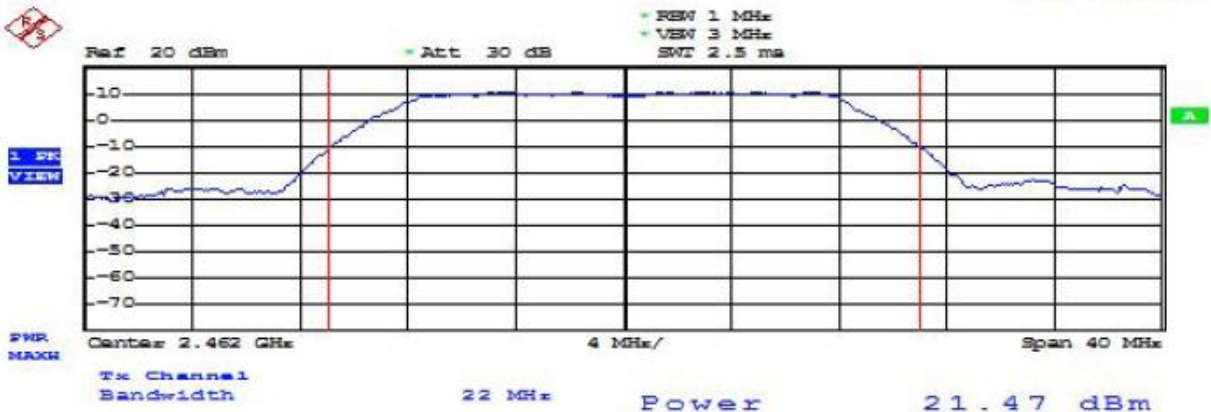



Modulation Standard: 802.11n HT20 (6.5Mbps)
Channel: 01

Date: 2018-12-13

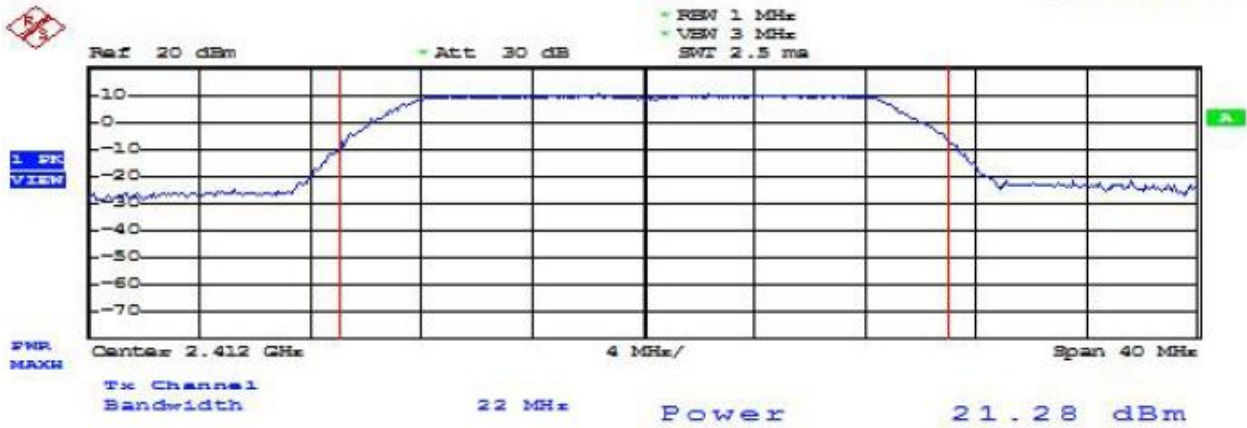

Modulation Standard: 802.11n HT20 (6.5Mbps)
Channel: 06

Date: 2018-12-13

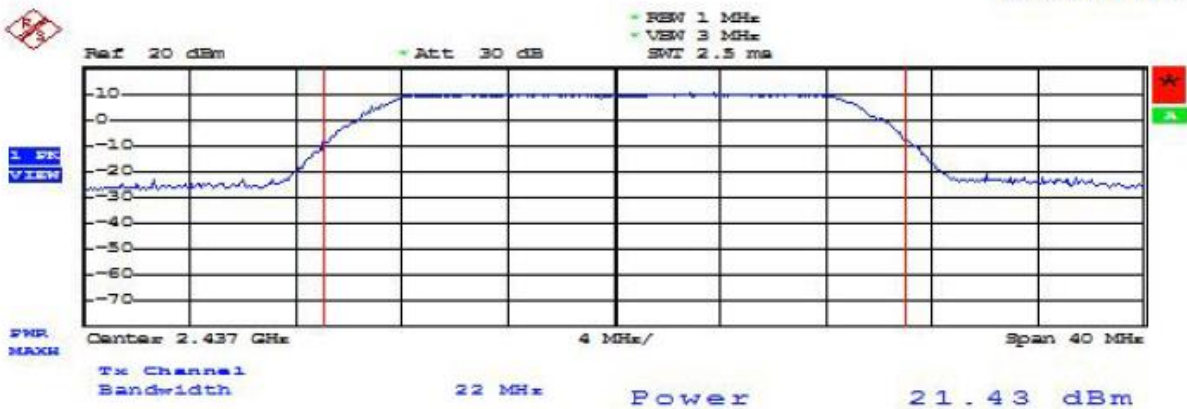

Modulation Standard: 802.11n HT20 (6.5Mbps)
Channel: 11

Date: 2018-12-13

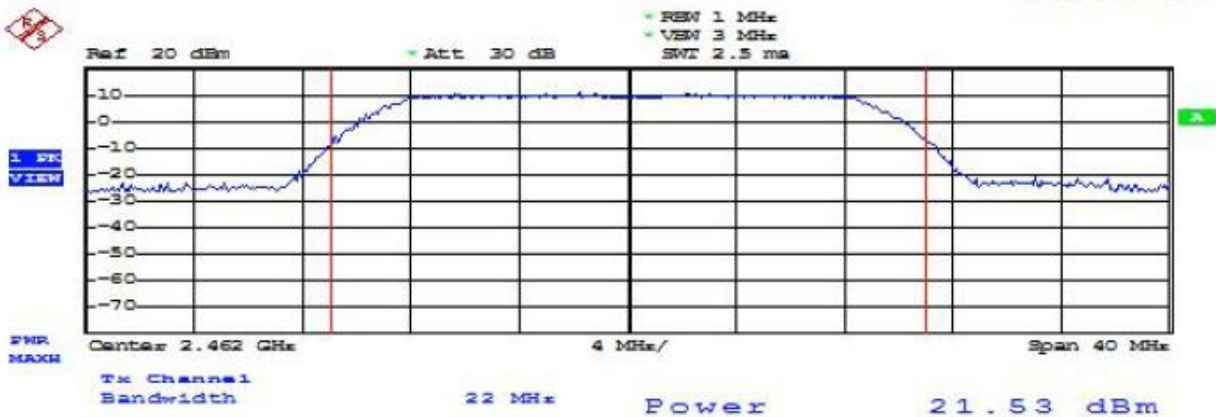



10. Power Spectral Density

10.1 Test Limit

The Maximum of Power Spectral Density Measurement is 8dBm

10.2 Test Procedures

- g. The transmitter output was connected to spectrum analyzer.
- h. The spectrum analyzer's resolution bandwidth were set at 3KHz RBW and 10KHz VBW as that of the fundamental frequency. Set the sweep time=auto couple.
- i. The power spectral density was measured and recorded.

10.3 Test Setup Layout

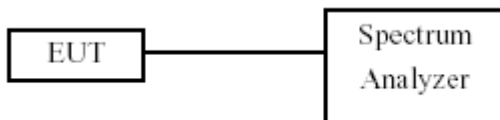



10.4 Test Result and Data

Test Date: Dec. 14, 2018

Temperature: 22 °C

Atmospheric pressure: 1002 pha

Humidity: 57%

Modulation Standard	Channel	Frequency (MHz)	Measured Power Density (dBm)
802.11b (11Mbps)	01	2412	-9.15
	06	2437	-9.03
	11	2462	-8.74
802.11g (6Mbps)	01	2412	-12.02
	06	2437	-12.02
	11	2462	-12.33

Modulation Standard	Channel	Frequency (MHz)	Measured Power Density (dBm)
802.11n HT20 (6.5Mbps)	01	2412	-14.36
	06	2437	-12.13
	11	2462	-12.99



Modulation Standard: 802.11b (11Mbps)
Channel: 01

Date: 2018-12-14

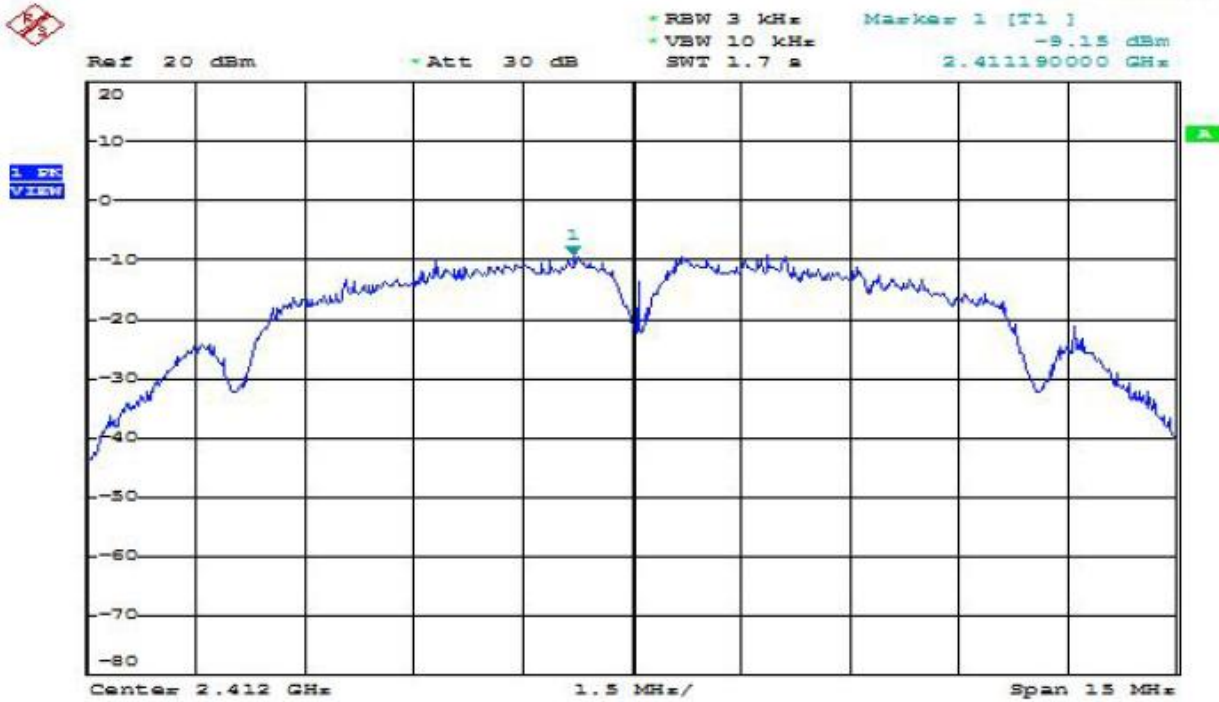

Modulation Standard: 802.11b (11Mbps)
Channel: 06

Date: 2018-12-14

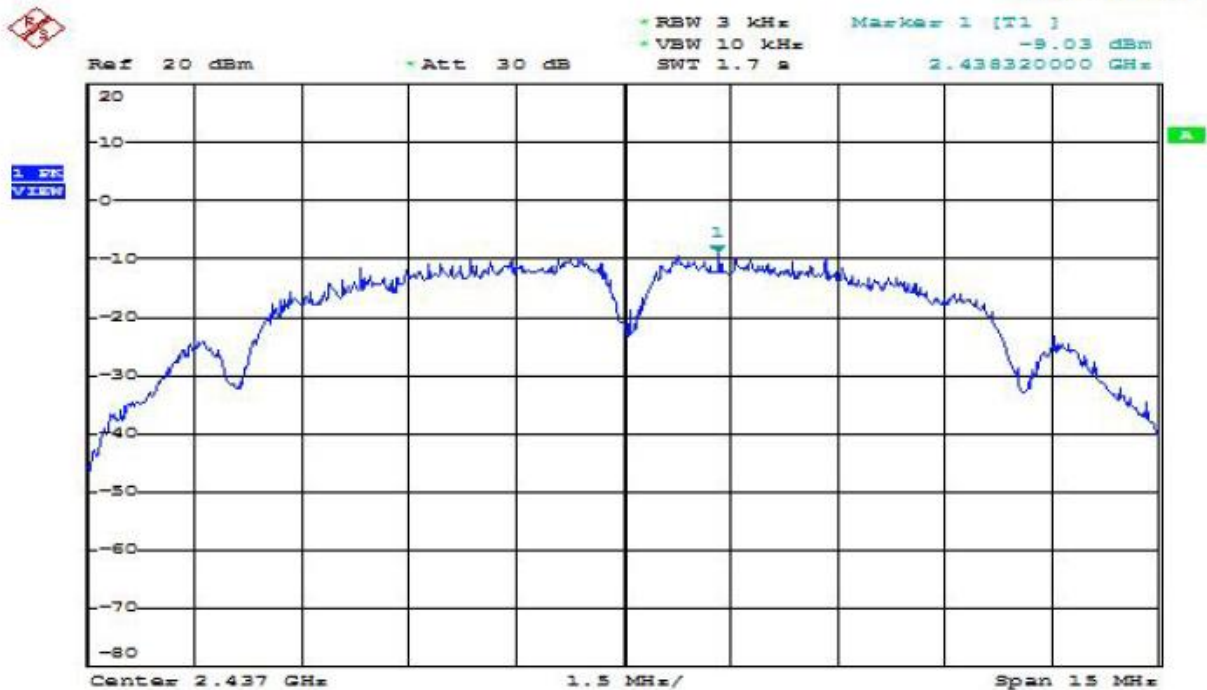



Modulation Standard: 802.11b (11Mbps)
Channel: 11

Date: 2018-12-14

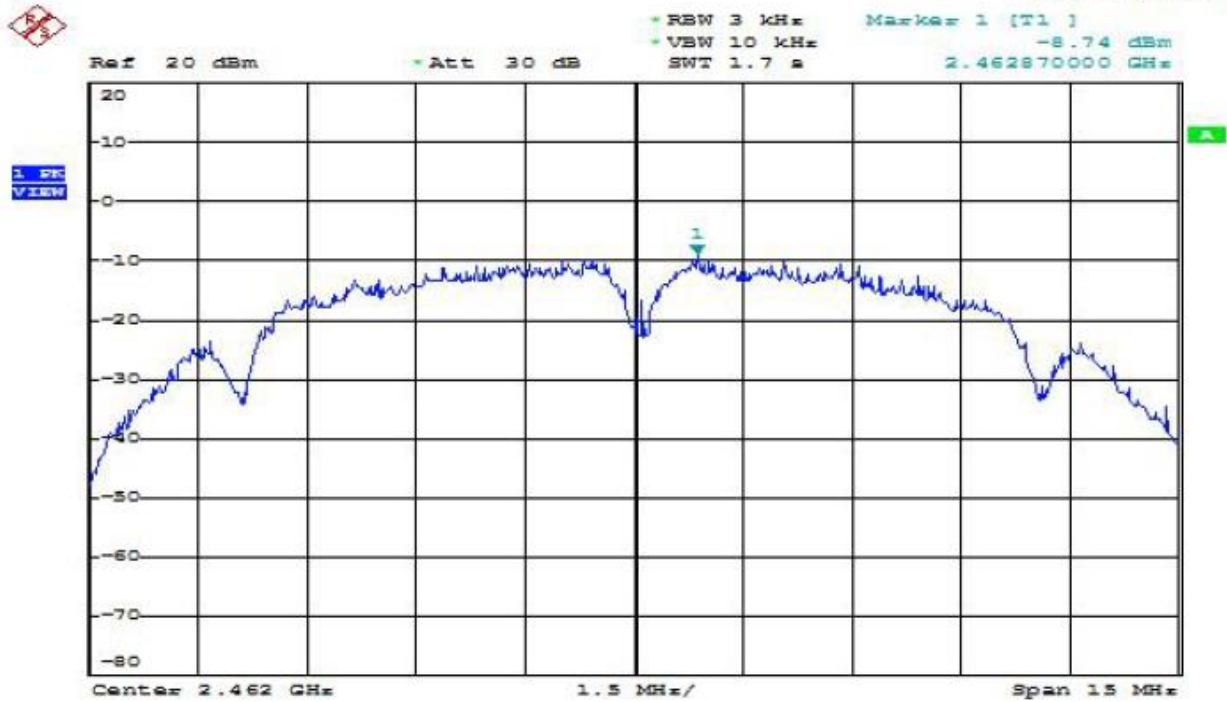

Modulation Standard: 802.11g (6Mbps)
Channel: 01

Date: 2018-12-14

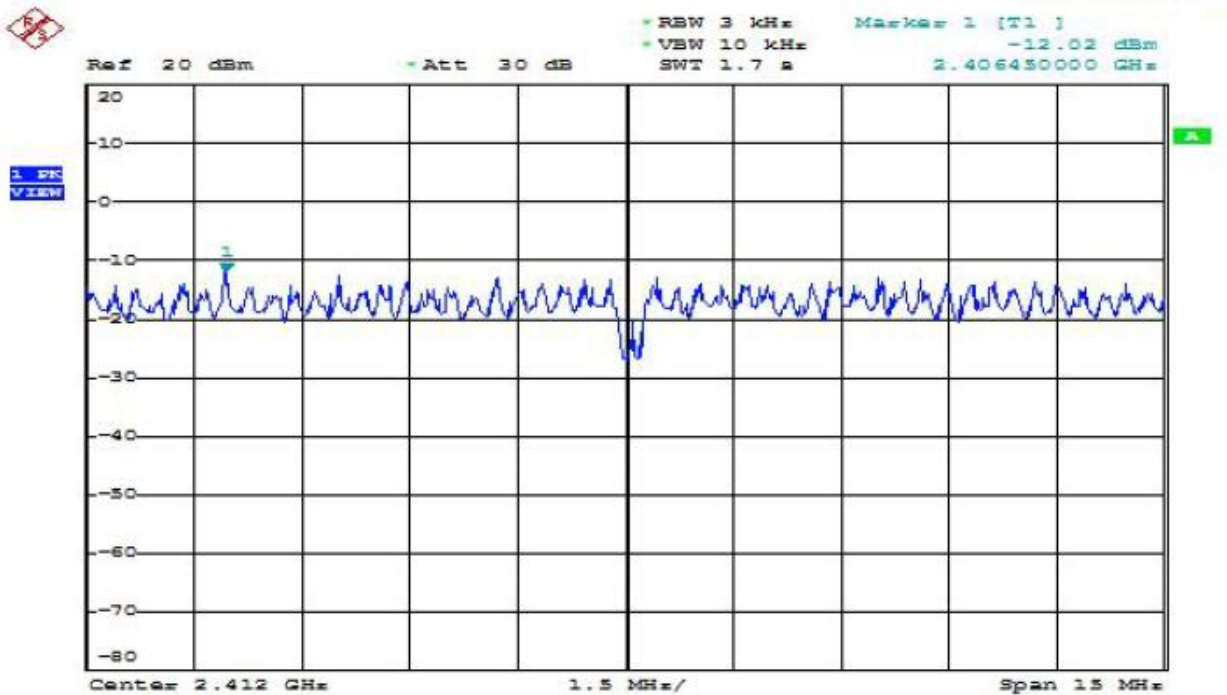



Modulation Standard: 802.11g (6Mbps)
Channel: 06

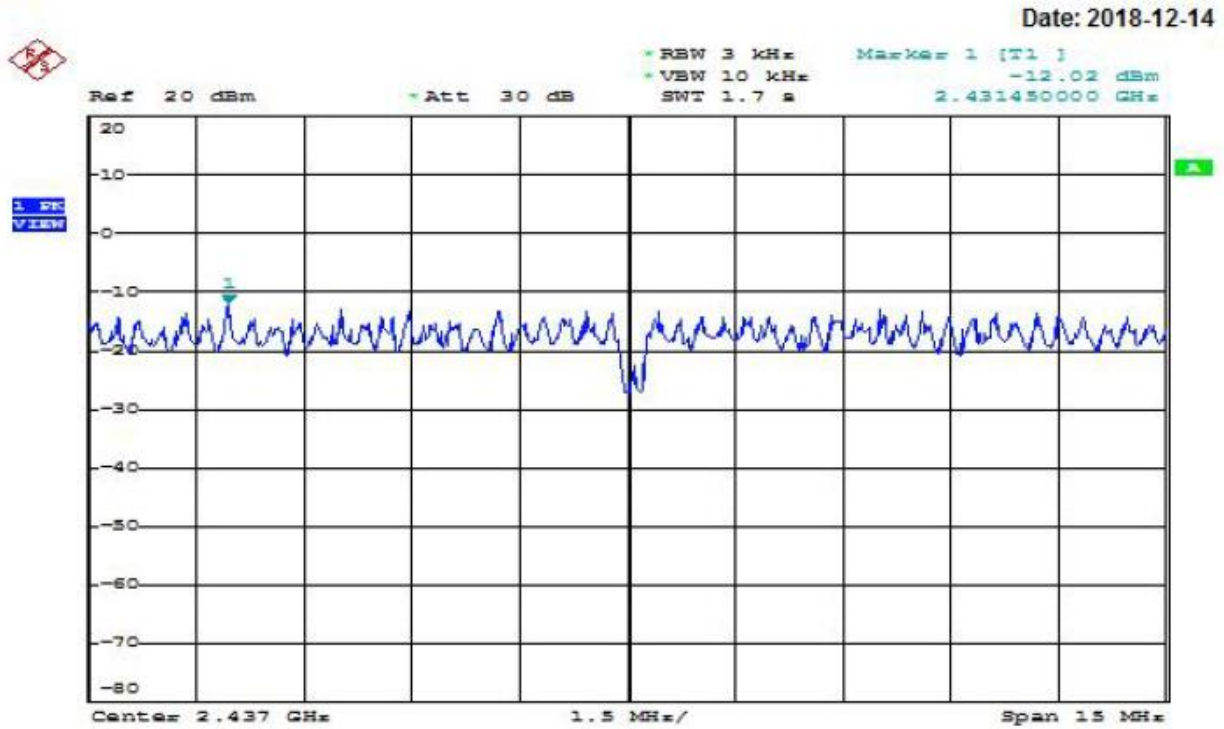

Modulation Standard: 802.11g (6Mbps)
Channel: 11

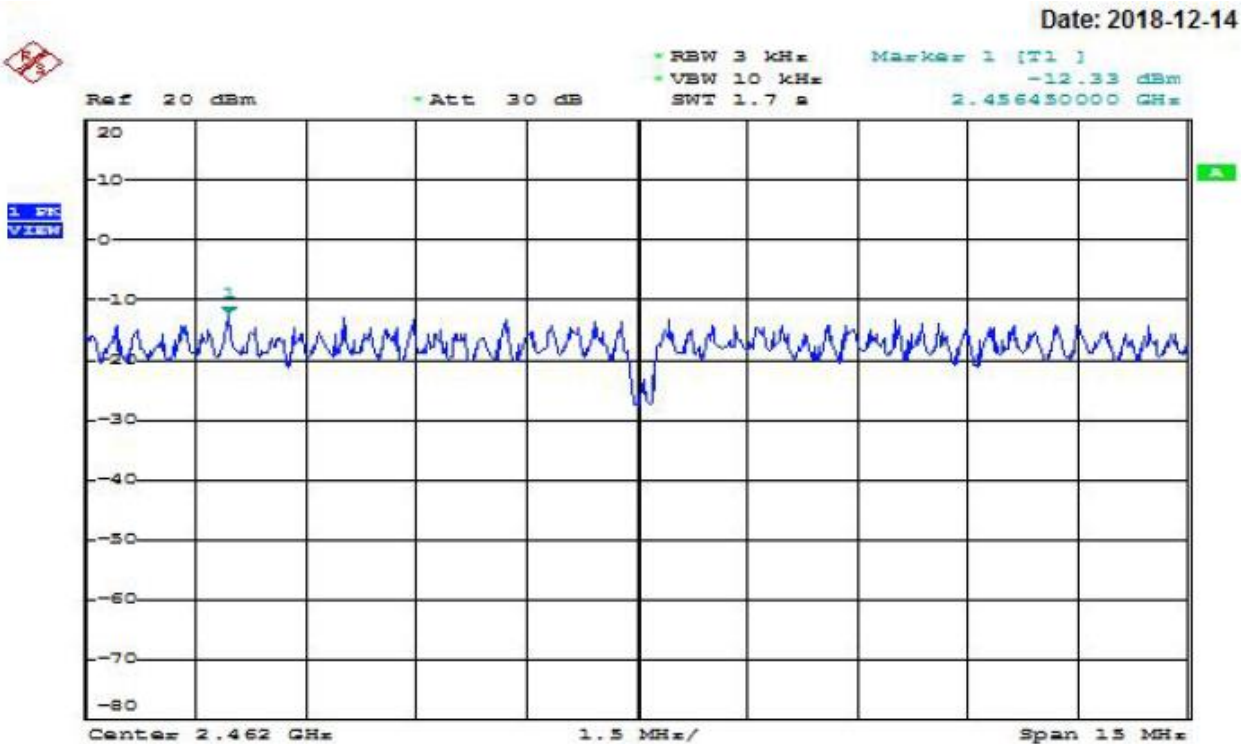



Modulation Standard: 802.11n HT20 (6.5Mbps)
Channel: 01

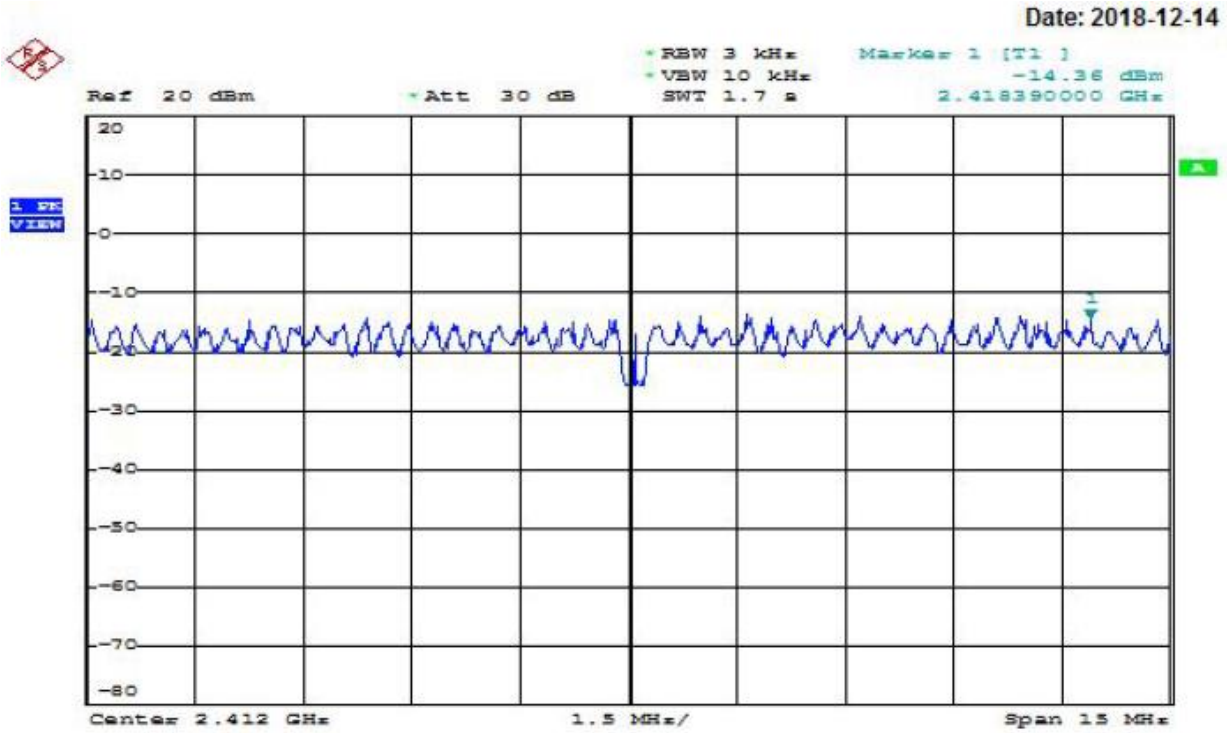

Modulation Standard: 802.11n HT20 (6.5Mbps)
Channel: 06

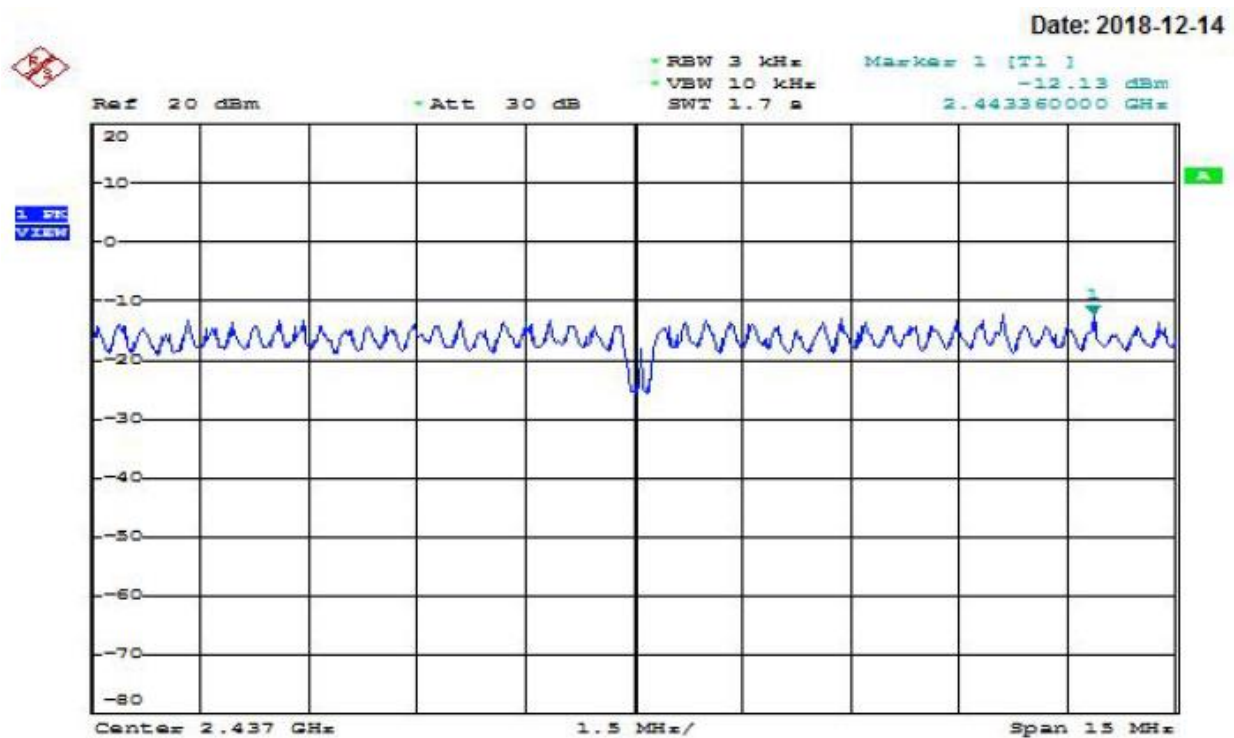



Modulation Standard: 802.11n HT20 (6.5Mbps)
Channel: 11

Date: 2018-12-14

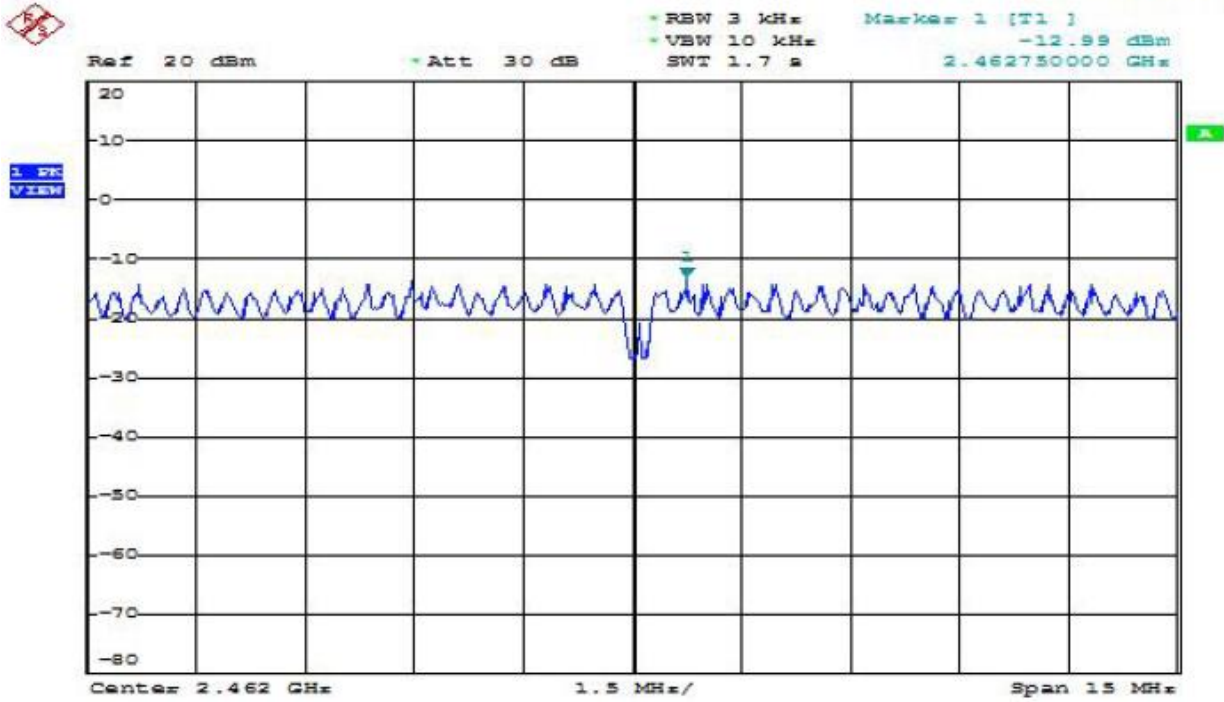



11. Band Edges Measurement

11.1 Test Limit

Below -20dB of the highest emission level of operating band (In 100 kHz Resolution Bandwidth)

11.2 Test Procedure

- a. The transmitter output was connected to the spectrum analyzer via a low lose cable.
- b. Set RBW of spectrum analyzer to 100 KHz and VBW of spectrum analyzer to 300 KHz with convenient frequency span including 100 KHz bandwidth from band edge.
- c. Peak conducted output power measured within any 100 kHz outside the authorized frequency band shall be attenuated by at least 20dB relative to the maximum measured in-band peak PSD level.
- d. The band edges was measured and recorded.

11.3 Test Setup Layout

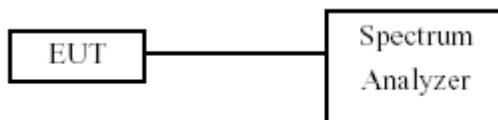



11.4 Test Result and Data

Test Date: Feb. 07, 2018

Temperature: 22 °C

Atmospheric pressure: 1002 pha

Humidity: 57 %

Modulation Standard	Channel	Frequency (MHz)	maximum value in frequency (MHz)	maximum value (dBm)
802.11b (11Mbps)	01	2412	2397.2	-38.83
	11	2462	2483.5	-46.05
802.11g (6Mbps)	01	2412	2397.2	-37.43
	11	2462	2483.5	-41.77
802.11n HT20 (6.5Mbps)	01	2412	2398.4	-34.34
	11	2462	2484.3	-40.30



Modulation Standard: 802.11b (11Mbps)
Channel: 01

Date: 2018-12-13

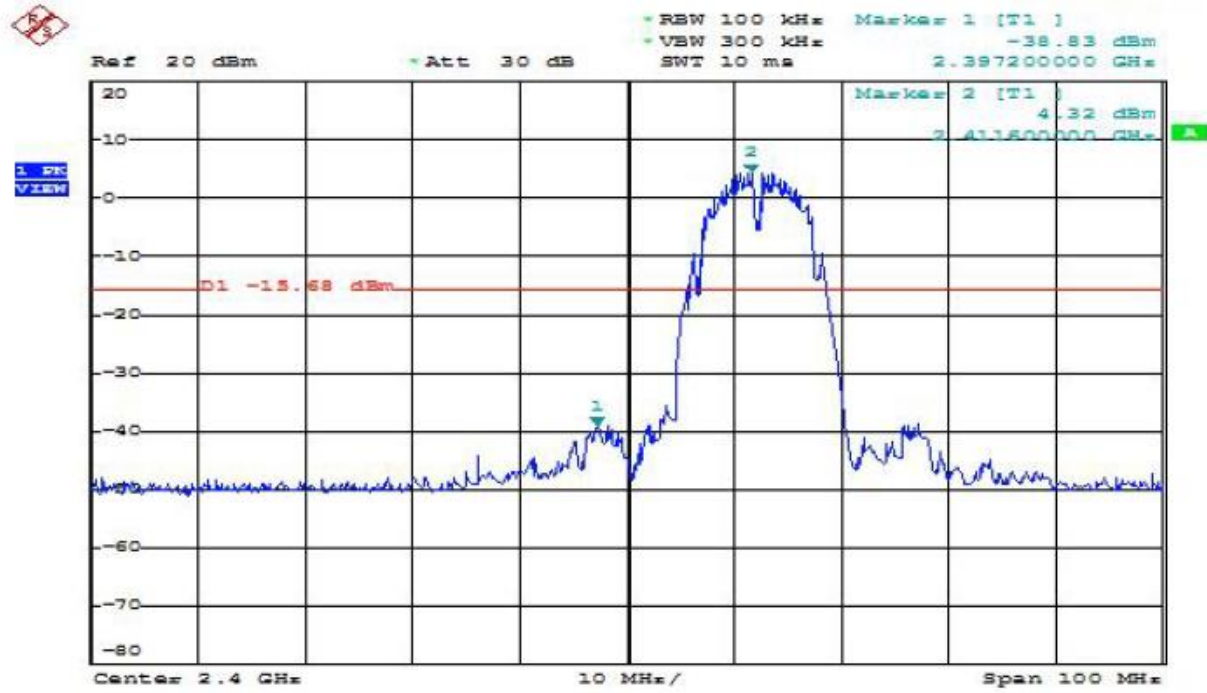

Modulation Standard: 802.11b (11Mbps)
Channel: 11

Date: 2018-12-13

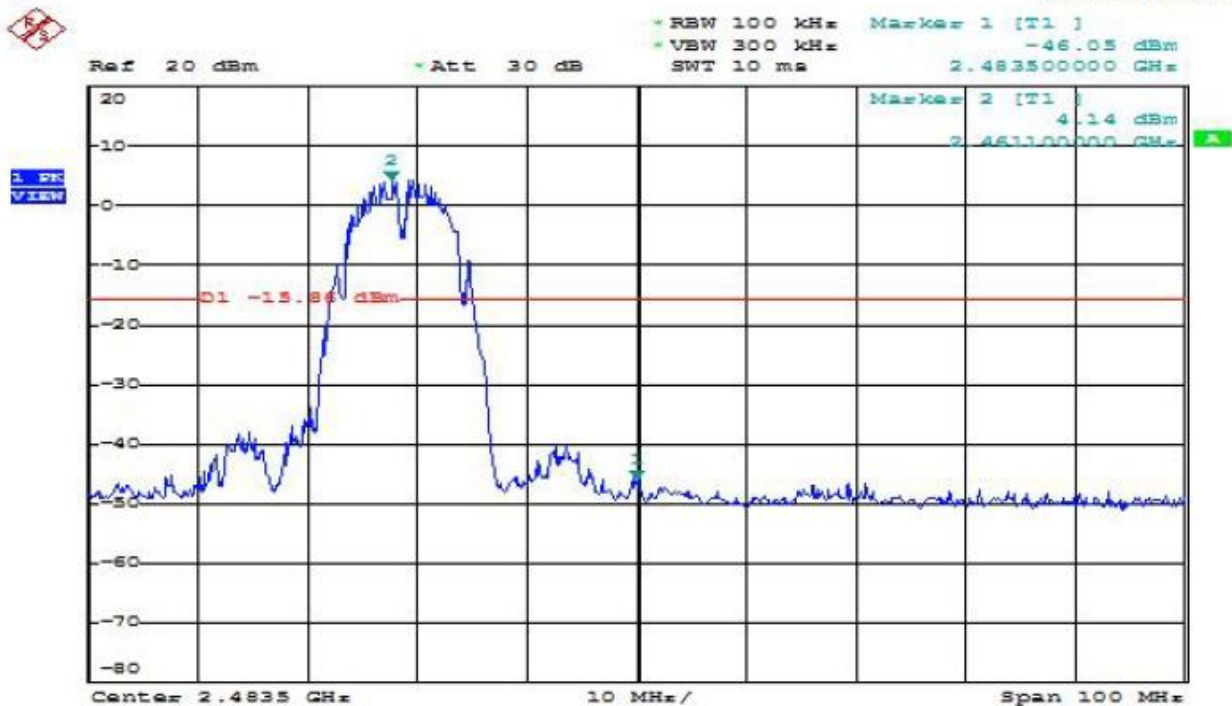



Modulation Standard: 802.11g (6Mbps)
Channel: 01

Date: 2018-12-13

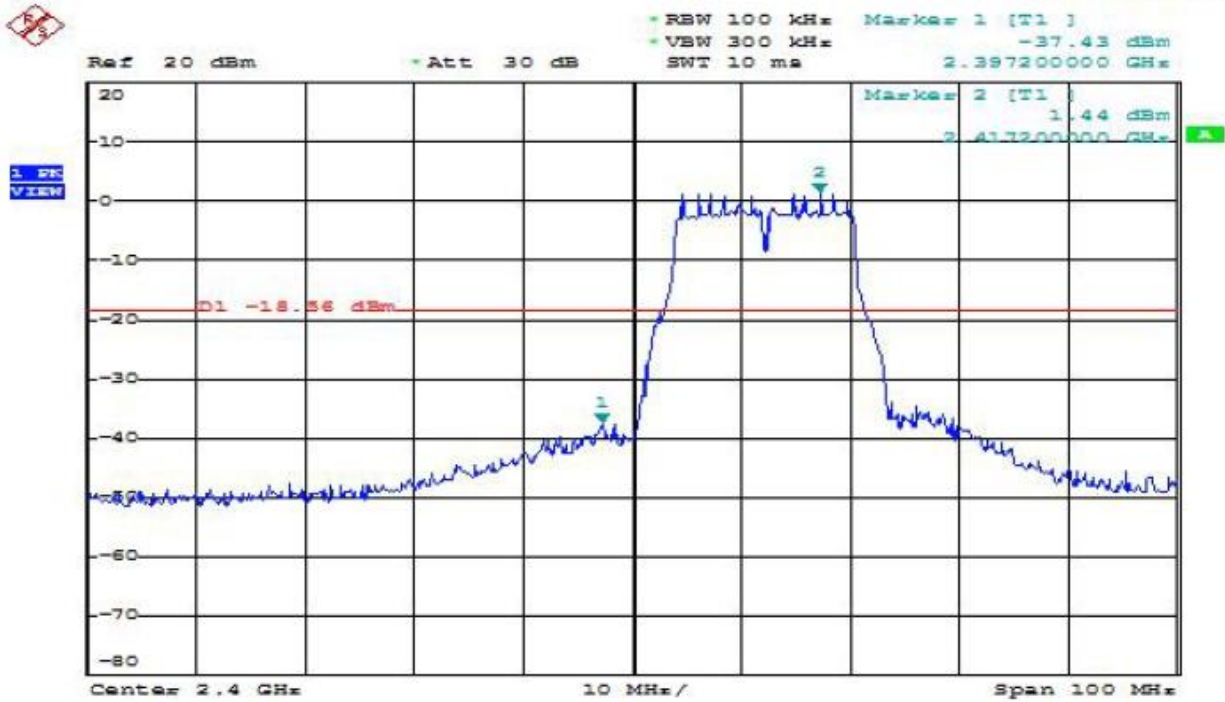

Modulation Standard: 802.11g (6Mbps)
Channel: 11

Date: 2018-12-13

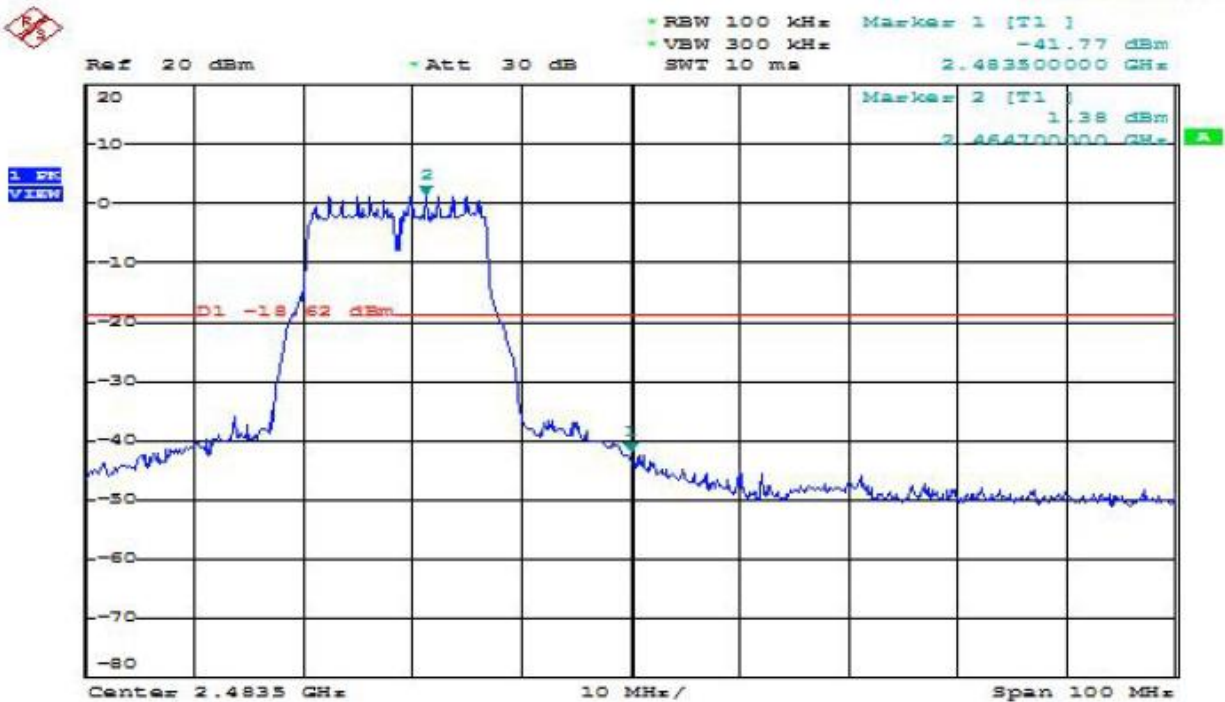



Modulation Standard: 802.11n HT20 (6.5Mbps)
Channel: 01

Date: 2018-12-13

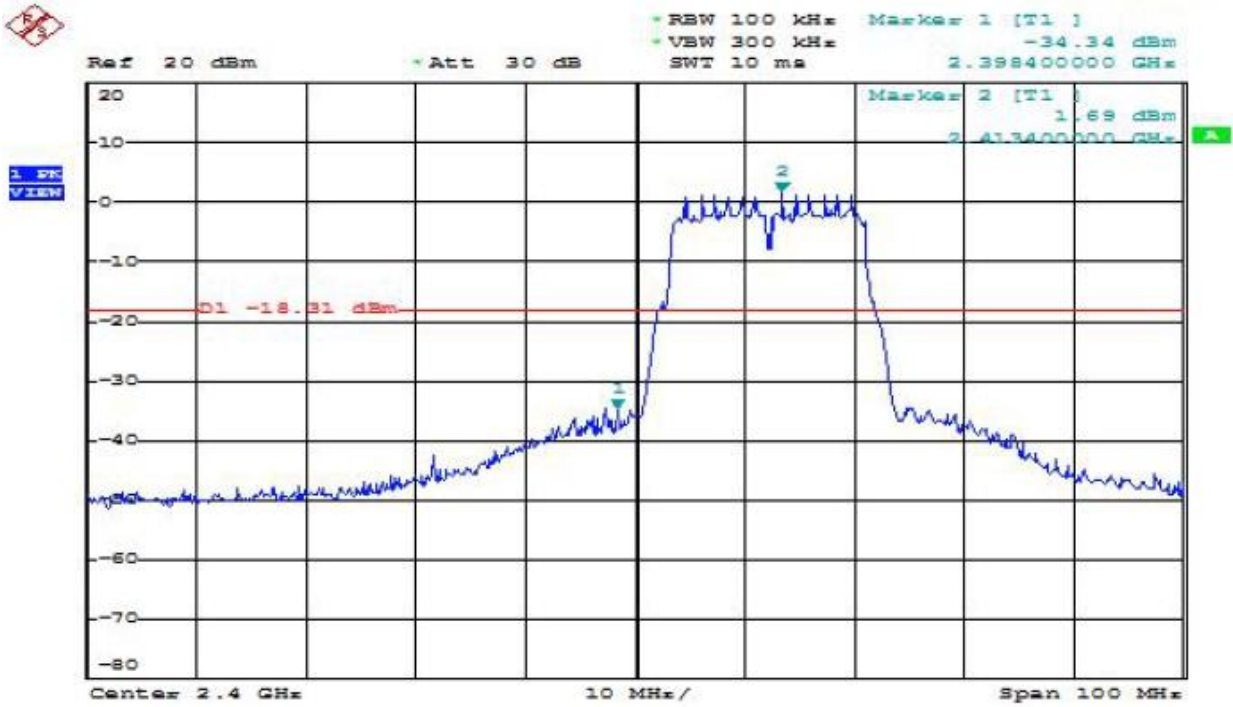

Modulation Standard: 802.11n HT20 (6.5Mbps)
Channel: 11

Date: 2018-12-13

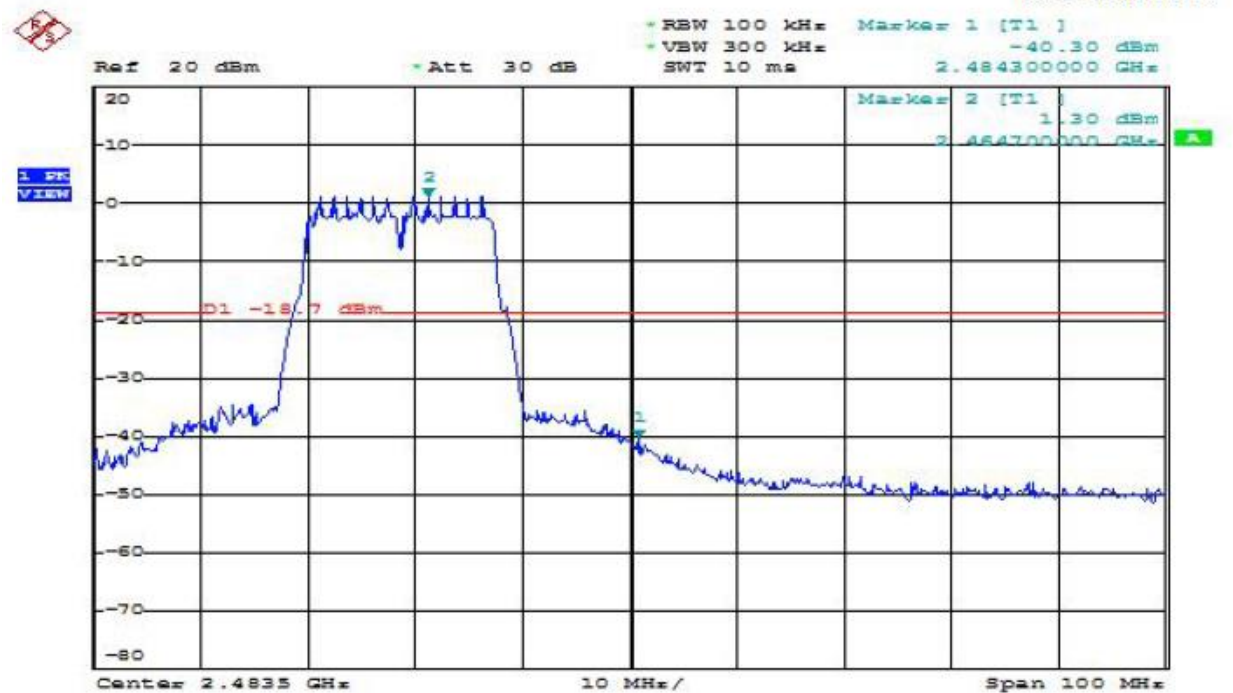



11.5 Restrict Band Emission Measurement Data

Power	: AC 110V	Pol/Phase	: H/V
Test Mode	: 802.11b	Temperature	: 17 °C
Memo	:	Humidity	: 72 %

Channel 1						Fundamental Frequency: 2412 MHz		
Frequency (MHz)	Ant-Pol H/V	Meter Reading (dBuV)	Corrected Factor (dB)	Result (dBuV/m)	Remark	Limit (dBuV/m)		Margin (dB)
						Peak	Ave	
2386.00	H	60.96	-12.94	48.02	Peak	74	54	-25.98
---	H	---	---	---	Ave	74	54	---
2386.00	V	58.22	-12.94	45.28	Peak	74	54	-28.72
---	V	---	---	---	Ave	74	54	---

Channel 11						Fundamental Frequency: 2462 MHz		
Frequency (MHz)	Ant-Pol H/V	Meter Reading (dBuV)	Corrected Factor (dB)	Result (dBuV/m)	Remark	Limit (dBuV/m)		Margin (dB)
						Peak	Ave	
2483.50	H	58.58	-12.50	46.08	Peak	74	54	-27.92
---	H	---	---	---	Ave	74	54	---
2483.50	V	56.80	-12.50	44.30	Peak	74	54	-29.70
---	V	---	---	---	Ave	74	54	---



Power	: AC 110V	Pol/Phase	: H/V
Test Mode	: 802.11g	Temperature	: 17 °C
Memo	:	Humidity	: 72 %

Channel 1						Fundamental Frequency: 2412 MHz		
Frequency (MHz)	Ant-Pol H/V	Meter Reading (dBuV)	Corrected Factor (dB)	Result (dBuV/m)	Remark	Limit (dBuV/m)		Margin (dB)
						Peak	Ave	
2390.00	H	63.03	-12.91	50.12	Peak	74	54	-23.88
---	H	---	---	---	Ave	74	54	---
2390.00	V	61.65	-12.91	48.74	Peak	74	54	-25.26
---	V	---	---	---	Ave	74	54	---
Channel 11						Fundamental Frequency: 2462 MHz		
Frequency (MHz)	Ant-Pol H/V	Meter Reading (dBuV)	Corrected Factor (dB)	Result (dBuV/m)	Remark	Limit (dBuV/m)		Margin (dB)
						Peak	Ave	
2483.50	H	63.24	-12.50	50.74	Peak	74	54	-23.26
---	H	---	---	---	Ave	74	54	---
2483.50	V	62.25	-12.50	49.75	Peak	74	54	-24.25
---	V	---	---	---	Ave	74	54	---



Power	: AC 110V	Pol/Phase	: H/V
Test Mode	: 802.11n HT20	Temperature	: 17 °C
Memo	:	Humidity	: 72 %

Channel 1						Fundamental Frequency: 2412 MHz		
Frequency (MHz)	Ant-Pol H/V	Meter Reading (dBuV)	Corrected Factor (dB)	Result (dBuV/m)	Remark	Limit (dBuV/m)		Margin (dB)
						Peak	Ave	
2390.00	H	64.17	-12.91	51.26	Peak	74	54	-22.74
---	H	---	---	---	Ave	74	54	---
2390.00	V	63.40	-12.91	50.49	Peak	74	54	-23.51
---	V	---	---	---	Ave	74	54	---

Channel 11						Fundamental Frequency: 2462 MHz		
Frequency (MHz)	Ant-Pol H/V	Meter Reading (dBuV)	Corrected Factor (dB)	Result (dBuV/m)	Remark	Limit (dBuV/m)		Margin (dB)
						Peak	Ave	
2483.50	H	64.71	-12.50	52.21	Peak	74	54	-21.79
---	H	---	---	---	Ave	74	54	---
2483.50	V	63.49	-12.50	50.99	Peak	74	54	-23.01
---	V	---	---	---	Ave	74	54	---



Note:

1. Emission level = Reading level + Correction factor
2. Correction factor : Antenna factor, Cable loss, Pre-Amp, etc.
3. Measurements above 1000 MHz, Peak detector setting:
1 MHz RBW with 1 MHz VBW.
4. Measurements above 1000 MHz, Average detector setting:
1 MHz RBW with 10Hz VBW.
5. Peak detector measurement data will represent the worst case results.
6. Where limits are specified for both average and peak detector functions, if the peak measured value complies with the average limit, it is unnecessary to perform an average measurement.
7. The other emission levels were 20dB below the limit.



12. Restricted Bands of Operation

Only spurious emissions are permitted in any of the frequency bands listed below:

MHz	MHz	MHz	GHz
0.09000 – 0.11000	16.42000 – 16.42300	399.9 – 410.0	4.500 – 5.150
0.49500 – 0.505**	16.69475 – 16.69525	608.0 – 614.0	5.350 – 5.460
2.17350 – 2.19050	16.80425 – 16.80475	960.0 – 1240.0	7.250 – 7.750
4.12500 – 4.12800	25.50000 – 25.67000	1300.0 – 1427.0	8.025 – 8.500
4.17725 – 4.17775	37.50000 – 38.25000	1435.0 – 1626.5	9.000 – 9.200
4.20725 – 4.20775	73.00000 – 74.60000	1645.5 – 1646.5	9.300 – 9.500
6.21500 – 6.21800	74.80000 – 75.20000	1660.0 – 1710.0	10.600 – 12.700
6.26775 – 6.26825	108.00000 – 121.94000	1718.8 – 1722.2	13.250 – 13.400
6.31175 – 6.31225	123.00000 – 138.00000	2200.0 – 2300.0	14.470 – 14.500
8.29100 – 8.29400	149.90000 – 150.05000	2310.0 – 2390.0	15.350 – 16.200
8.36200 – 8.36600	156.52475 – 156.52525	2483.5 – 2500.0	17.700 – 21.400
8.37625 – 8.38675	156.70000 – 156.90000	2655.0 – 2900.0	22.010 – 23.120
8.41425 – 8.41475	162.01250 – 167.17000	3260.0 – 3267.0	23.600 – 24.000
12.29000 – 12.29300	167.72000 – 173.20000	3332.0 – 3339.0	31.200 – 31.800
12.51975 – 12.52025	240.00000 – 285.00000	3345.8 – 3358.0	36.430 – 36.500
12.57675 – 12.57725	322.00000 – 335.40000	3600.0 – 4400.0	Above 38.6
13.36000 – 13.41000			

** : Until February 1, 1999, this restricted band shall be 0.490-0.510 MHz

12.1 Labeling Requirement

The device shall bear the following statement in a conspicuous location on the device:

This device complies with part 15 of the FCC Rules. Operation is subject to the following two conditions: (1) This device may not cause harmful interference, and (2) this device must accept any interference received, including interference that may cause undesired operation.