

# Global EMC Inc. Labs

## EMC & RF Test Report

As per

**RSS 210 Issue 8**

**&**

**FCC Part 15 Subpart C**

**Unlicensed Intentional Radiators**

on the

**XH2298**

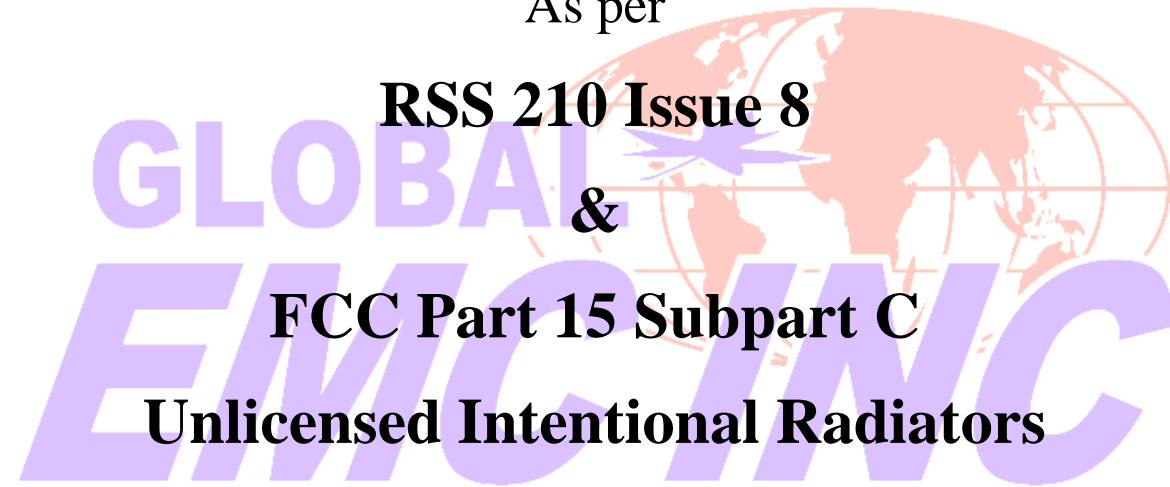

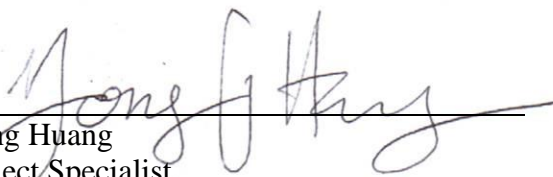

Yong Huang  
Project Specialist  
Global EMC Inc. Laval  
2972 Joseph-A-Bombardier  
Laval, QC, H7P 6E3 CANADA  
Ph: (450) 687- 4976

Testing produced for



See Appendix A for full customer & EUT details.



Client	Fortin Auto Radio Inc.	
Product	XH2298	
Standard(s)	RSS 210 Issue 8/ FCC Part 15 Subpart C 15	

## Table of Contents

Table of Contents .....	2
Report Scope .....	3
Summary .....	4
Test Results Summary .....	5
Justifications, Descriptions, or Deviations.....	7
Applicable Standards, Specifications and Methods.....	8
Sample calculation(s).....	9
Document Revision Status.....	9
Definitions and Acronyms .....	10
Testing Facility .....	11
Calibrations and Accreditations.....	11
Testing Environmental Conditions and Dates .....	12
Detailed Test Results Section .....	13
20 dB Bandwidth of Periodically Operated Transmitters.....	14
Radiated Emissions of Fundamental.....	17
Unintentional Radiated Emissions and Spurious Emissions .....	26
Appendix A – EUT Summary.....	39
Appendix B – EUT and Test Setup Photographs.....	41

Client	Fortin Auto Radio Inc.	
Product	XH2298	
Standard(s)	RSS 210 Issue 8/ FCC Part 15 Subpart C 15	

## Report Scope

This report addresses the EMC verification testing and test results of the XH2298, herein referred to as EUT (Equipment Under Test) performed at Global EMC Labs.

The EUT was tested for compliance against the following standards:

RSS 210 Issue 8/ FCC Part 15 Subpart C 15

Test procedures, results, justifications, and engineering considerations, if any, follow later in this report.

The results contained in this report relate only to the item(s) tested.

This report does not imply product endorsement by A2LA or any other accreditation agency, any government, or Global EMC Inc.

Opinions/interpretations expressed in this report, if any, are outside the scope of Global EMC Inc accreditation. Any opinions expressed do not necessarily reflect the opinions of Global EMC Inc, unless otherwise stated.

Client	Fortin Auto Radio Inc.	
Product	XH2298	
Standard(s)	RSS 210 Issue 8/ FCC Part 15 Subpart C 15	

## Summary

The results contained in this report relate only to the item(s) tested.

EUT FCC Certification #, FCC ID:	2ACKU-A2W01FM
EUT Industry Canada Certification #, IC:	12084A-A2W01FM
EUT Passed all tests performed.	Yes (see test results summary)
Tests conducted by	Yong Huang

Client	Fortin Auto Radio Inc.	
Product	XH2298	
Standard(s)	RSS 210 Issue 8/ FCC Part 15 Subpart C 15	

## Test Results Summary

Standard/Method	Description	Class/Limit	Result
FCC 15.203	Antenna Requirement	Unique	Pass See Justification
FCC 15.205 RSS 210 (Table 1)	Restricted Bands for intentional operation	QuasiPeak Average	Pass
FCC 15.207	Power line conducted emissions	QuasiPeak Average	See Justification
FCC 15.209 RSS-210 (Table 2)  FCC 15.231(b) RSS-210 (Table 4)	Intentional / Spurious Radiated emissions	QuasiPeak Average	Pass
FCC 15.231(a) RSS-210 A1.1	Type of transmission	Not a continuous transmissions, voice, video or radio control of toys.	Pass See Justification
FCC 15.231 (a)(1) RSS-210 A1.1.1(a)	Manual transmission Release holdover	< 5 seconds	Pass See Justification
FCC 15.231 (a)(2) RSS-210 A1.1.1(b)	Automatic transmission Transmission time	< 5 seconds	Pass See Justification
FCC 15.231 (a)(3) RSS-210 A1.1.1(c)	Predetermined intervals Transmission	None	Pass See Justification
FCC 15.231 (a)(3) RSS-210 A1.1.1(c)	Predetermined intervals Transmission Security/Safety	< 2 seconds per hour	Pass See Justification
FCC 15.231 (c) RSS-210 A1.1.3	20 dB Bandwidth	< 0.25% of carrier	Pass
<b>Overall Result</b>			<b>PASS</b>

Client	Fortin Auto Radio Inc.	
Product	XH2298	
Standard(s)	RSS 210 Issue 8/ FCC Part 15 Subpart C 15	

All tests were performed by Yong Huang.

If the product as tested or otherwise complies with the specification, the EUT is deemed to comply with the requirement and is deemed a 'PASS' grade. If not 'FAIL' grade will be issued. Note that 'PASS' / 'FAIL' grade is independent of any measurement uncertainties. A 'PASS' / 'FAIL' grade within measurement uncertainty is marked with a '\*'.

Client	Fortin Auto Radio Inc.	
Product	XH2298	
Standard(s)	RSS 210 Issue 8/ FCC Part 15 Subpart C 15	

### ***Justifications, Descriptions, or Deviations***

The following justifications for tests not performed or deviations from the above listed specifications apply:

For the Antenna requirement specified in FCC 15.203 (RSS 210 section 5.5), this device is designed with an integral antenna or proprietary antenna connector which meets the requirements of FCC 15.203.

For the Restricted Bands of operation as specified in FCC 15.205, the EUT is designed to only operate at 433.92 MHz

For the scope of this test report, radiated testing of the EUT was pre-scanned in three orthogonal axis to maximize emissions. Maximum emissions were found in the vertical EUT polarization. This setup was used for all testing in this report.

For the power line conducted emissions requirements, the EUT is DC powered, and this test does not apply.

The type of transmission is a data signal sent with a control signal, which complies with the requirements of 15.231(a) / 15.231(e).

The manual transmission (achieved by pressing the learn button), release holdover time was verified to be for all practical circumstances, instantaneous. This is significantly less than the 5 second requirement.

The EUT transmits a pulse to a receiver unit each time it detects the presence of a current, and another when the current is removed. This transmission does not occur continuously, only enough to signal the receiver of the presence of a current. For the purpose of determining compliance with FCC 15.231(a)(1) or FCC 15.231(a)(2), this transmission is 10.7 milliseconds, and does not transmit for the entire duration of the sensed current. For the purpose of average duty cycle calculations, the maximum time to which this could repeat is over 100 milliseconds. The duty cycle average factor is calculated at  $20 \log (10.7/100 \text{ dB}) = -19.4 \text{ dB}$ .

For 15.231(a)(3) compliance, this device does not transmit at pre-determined intervals. This device requires end-user motion to trigger the transmit function

Client	Fortin Auto Radio Inc.	
Product	XH2298	
Standard(s)	RSS 210 Issue 8/ FCC Part 15 Subpart C 15	

### ***Applicable Standards, Specifications and Methods***

- ANSI C63.4:2009 - Methods of Measurement of Radio-Noise Emissions from Low-Voltage Electrical and Electronic Equipment in the Range of 9 kHz to 40 GHz
- CFR 47 FCC 15 - Code of Federal Regulations – Radio Frequency Devices
- CISPR 22:2008 - Information technology equipment – Radio disturbance characteristics – Limits and methods of measurement
- ICES-003:2012 - Digital Apparatus - Spectrum Management and Telecommunications Policy Interference-Causing Equipment Standard
- ISO 17025:2005 - General Requirements for the competence of testing and calibration laboratories
- RSS 210:2010 - Issue 8: Spectrum Management and Telecommunications Policy. Radio Standards Specification Low Power Licence-Exempt Radio communication Devices



Client	Fortin Auto Radio Inc.	
Product	XH2298	
Standard(s)	RSS 210 Issue 8/ FCC Part 15 Subpart C 15	

### ***Sample calculation(s)***

Margin = limit – (received signal + antenna factor + cable loss – pre-amp gain)

Margin = 50.5dBuV/m – (50dBuV + 10dB + 2.5dB – 20dB)

Margin = 8.5 dB

### ***Document Revision Status***

Revision 1 - Released on June 20<sup>th</sup>, 2014

Revision 2 - Revised on June 27<sup>th</sup>, 2014, according to TCB/FCC requirement.

Client	Fortin Auto Radio Inc.	
Product	XH2298	
Standard(s)	RSS 210 Issue 8/ FCC Part 15 Subpart C 15	

## Definitions and Acronyms

The following definitions and acronyms are applicable in this report.  
See also ANSI C63.14.

**AE** – Auxillary Equipment.

**BW** – Bandwidth. Unless otherwise stated, this is refers to the 6 dB bandwidth.

**EMC** – Electro-Magnetic Compatibility

**EMI** – Electro-Magnetic Immunity

**EUT** – Equipment Under Test

**ITE** – Information Technology Equipment with a primary function(s) of entry, storage, display, retrieval, transmission, processing, switching, or control, of data.

**LISN** – Line impedance stabilization network

**NCR** – No Calibration Required

**RF** – Radio Frequency

Client	Fortin Auto Radio Inc.	
Product	XH2298	
Standard(s)	RSS 210 Issue 8/ FCC Part 15 Subpart C 15	

## Testing Facility

Testing for EMC on the EUT was carried out at Global EMC labs in Montréal, Québec, Canada. The testing lab consists of a 3m semi-anechoic chamber calibrated to be able to allow measurements on an EUT with a maximum width or length of up to 2m and height up to 3m. The chamber is equipped with a turn table that is capable of testing devices up to 3300lb in weight. This facility is capable of testing products that are rated for 120 Vac and 240Vac single phase, or 208 Vac 3 phase input. DC capability is also available. The chamber is equipped with an antenna mast that controls polarization and height from the control room adjoining the shielded chamber. Radiated emissions measurements are performed using a Bilog, and Horn antenna where applicable. Conducted emissions, unless otherwise stated, are performed using a LISN.

### ***Calibrations and Accreditations***

The measurement site used is registered with Federal Communications Commission (FCC) and Industry Canada (IC). This site is calibrated for Normalized Site Attenuation (NSA) using test procedures outlined in ANSI C63.4 “Methods of Measurement of Radio-Noise Emissions from Low-Voltage Electrical and Electronic Equipment in the Range of 9 kHz to 40 GHz”. The semi-anechoic chamber is lined with ferrite tiles and absorption cones to minimize any undesired reflections. All measuring equipment is calibrated on an annual or bi-annual basis as listed for each respective test.

Client	Fortin Auto Radio Inc.	
Product	XH2298	
Standard(s)	RSS 210 Issue 8/ FCC Part 15 Subpart C 15	

### ***Testing Environmental Conditions and Dates***

Following were the environmental conditions in the facility during time of testing –

<b>Date</b>	<b>Test</b>	<b>Init.</b>	<b>Temperature (°C)</b>	<b>Humidity (%)</b>	<b>Pressure (kPa)</b>
2014.06.11	All	YH	20-25°C	30-45%	100 -103kPa

Client	Fortin Auto Radio Inc.	
Product	XH2298	
Standard(s)	RSS 210 Issue 8/ FCC Part 15 Subpart C 15	

## Detailed Test Results Section

Client	Fortin Auto Radio Inc.	
Product	XH2298	
Standard(s)	RSS 210 Issue 8/ FCC Part 15 Subpart C 15	

## ***20 dB Bandwidth of Periodically Operated Transmitters***

### **Purpose**

The purpose of this test is to ensure that the bandwidth occupied does not exceed a stated minimum. This helps ensure the utilization of the frequency allocation is sufficiently narrow, and not occupying excessive spectrum. This also helps prevent accidentally interference of data by ensuring adequate data separation to distinguish the reception of the intended information by enabling the receiver to have a relatively narrow band response tuned to the transmitters frequency.

### **Limits**

The Limit is as specified in FCC Part 15 and RSS 210.

For periodic transmitters below 900 MHz, this should not exceed 0.25 % of the fundamental frequency. For periodic transmitters above 900 MHz, this should not exceed 0.5 % of the fundamental frequency. This should be measured with a RBW equal to approximately %1 of the 20 dB BW of the signal and a VBW > then the RBW.

### **Results**

The EUT passed. The 20 dB BW measured was 84.0 kHz and the requirement was that this be less than 1.08 MHz.

Client	Fortin Auto Radio Inc.	
Product	XH2298	
Standard(s)	RSS 210 Issue 8/ FCC Part 15 Subpart C 15	

### Graph(s)

The graphs shown below shows the channel spacing during the operation of the device. This is measured by a max hold on the spectrum analyzer and the highest resolution bandwidth that is approximately 1 % of the 20 dB BW during operation of the EUT. This measurement is a peak measurement. Max hold is performed for a duration of not less then 1 minute. Markers are set at 20 dB below peak.

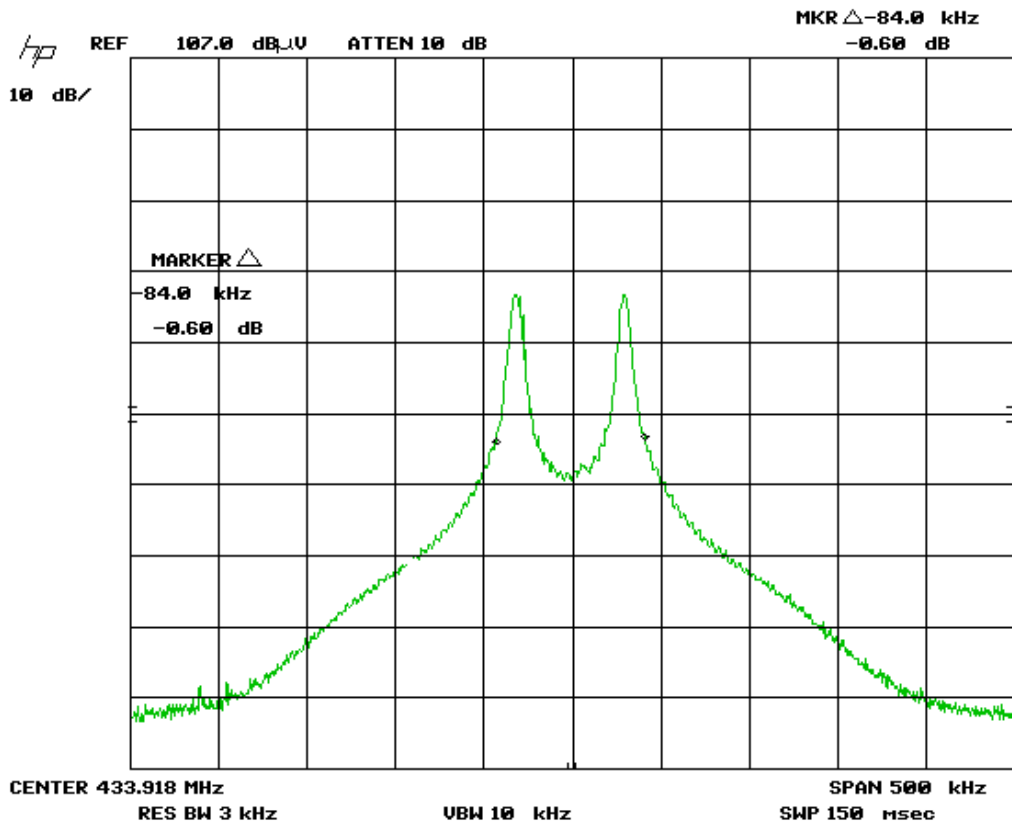

Note: See ‘Appendix B – EUT & Test Setup Photographs’ for photos showing the test set-up.

Client	Fortin Auto Radio Inc.	
Product	XH2298	
Standard(s)	RSS 210 Issue 8/ FCC Part 15 Subpart C 15	

## Test Equipment List

Equipment	Model No.	Manufacturer	Last calibration date	Next calibration due date	Asset #
Spectrum Analyzer	8566B	HP	1/22/13	1/22/15	4169
Quasi Peak Adapter	85650A	HP	1/23/13	1/23/15	4170
BiLog Antenna	3142-C	ETS	4/25/13	4/25/15	4002
Attenuator 3 dB	FP-50-3	Trilithic	N/A	N/A	4028
9kHz-1GHz, 28dB preamp	LNA 6901	Teseq	8-6-13	8-6-15	4036
RF Cable 7m	LMR-400-7M-50OHM-MN-MN	LexTec	NCR	NCR	4026
RF Cable 1M	LMR-400-1M-50OHM-MN-MN	LexTec	N/A	N/A	4039
RF Cable 10m	LMR-400-10M-50OHM-MN-MN	LexTec	NCR	NCR	4025

This report module is based on GEMC template "FCC - 15.231 - 20dB Bandwidth\_Rev1.doc"



Client	Fortin Auto Radio Inc.	
Product	XH2298	
Standard(s)	RSS 210 Issue 8/ FCC Part 15 Subpart C 15	

## ***Radiated Emissions of Fundamental***

### **Purpose**

The purpose of this test is to ensure that the RF energy intentionally emitted from the EUT does not exceed the limit listed below as defined in the applicable test standard, as measured from a receiving antenna. This helps protect other periodic operating devices, and licensed broadcasting devices, and so on, from unwanted interference.

### **Limit(s) and Method**

The method is as defined in ANSI C63.4:2003.

The limits are as defined in FCC Part 15, Section 15.231 (b), and is specific for the one frequency for the fundamental transmit frequency.

433.92 MHz – 80.8 dBuV/m<sup>1</sup>.

433.92 MHz – 100.8 dBuV/m<sup>2</sup>

<sup>1</sup>Based on the average value of the measured emissions. As an alternative, compliance with the limits in the above table may be based on the use of measurement instrumentation with a CISPR quasi-peak detector.

<sup>2</sup>Based on peak detector measured emissions.

Client	Fortin Auto Radio Inc.	
Product	XH2298	
Standard(s)	RSS 210 Issue 8/ FCC Part 15 Subpart C 15	

**Typical Radiated Emissions Setup**

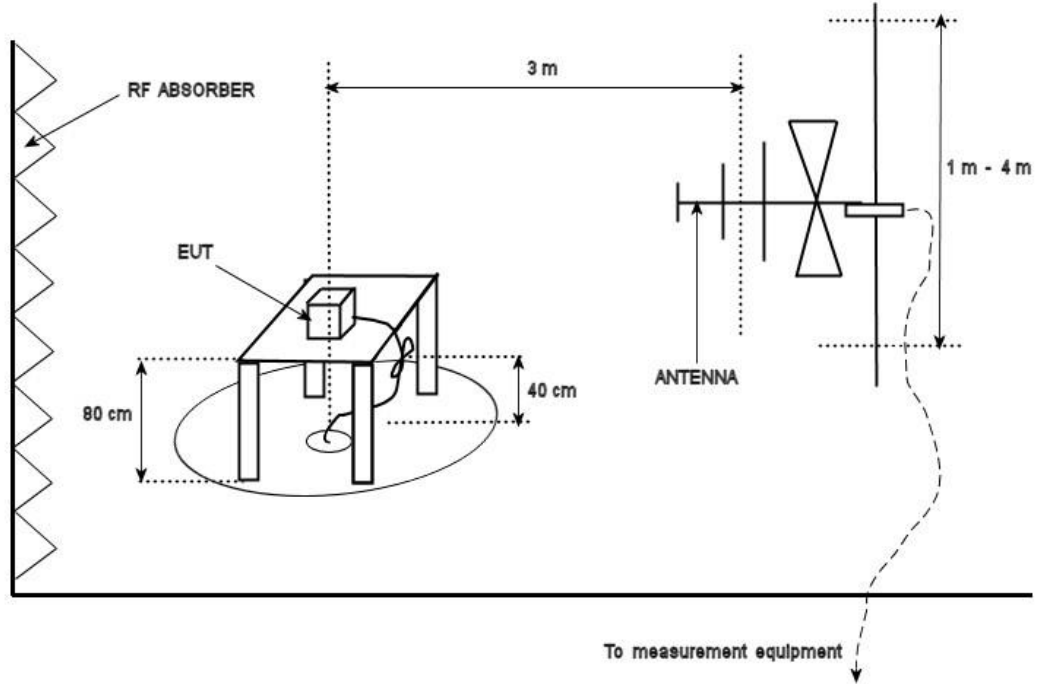

Client	Fortin Auto Radio Inc.	
Product	XH2298	
Standard(s)	RSS 210 Issue 8/ FCC Part 15 Subpart C 15	

### Measurement Uncertainty

The expanded measurement uncertainty is calculated in accordance with CISPR 16-4-2 and is +/-4.4 dB with a 'k=2' coverage factor and a 95% confidence level.

### Preliminary Graphs

Note the graphs shown below are for graphical illustration only. For final measurements with the appropriate detector, please refer to the final measurement table where applicable. The graph shown below is a maximized peak measurement graph, measured with a resolution bandwidth greater than the final required detector and over a full 0-360 rotation. This peaking process is done as a worst case measurement. This process enables the detection of frequencies of concern for final measurement, and provides considerable time savings. Final measurements are performed over a full 0-360 degrees rotation and 1 – 4 meter height of measurement antenna.

Client	Fortin Auto Radio Inc.	
Product	XH2298	
Standard(s)	RSS 210 Issue 8/ FCC Part 15 Subpart C 15	

Screen capture of fundamental emission

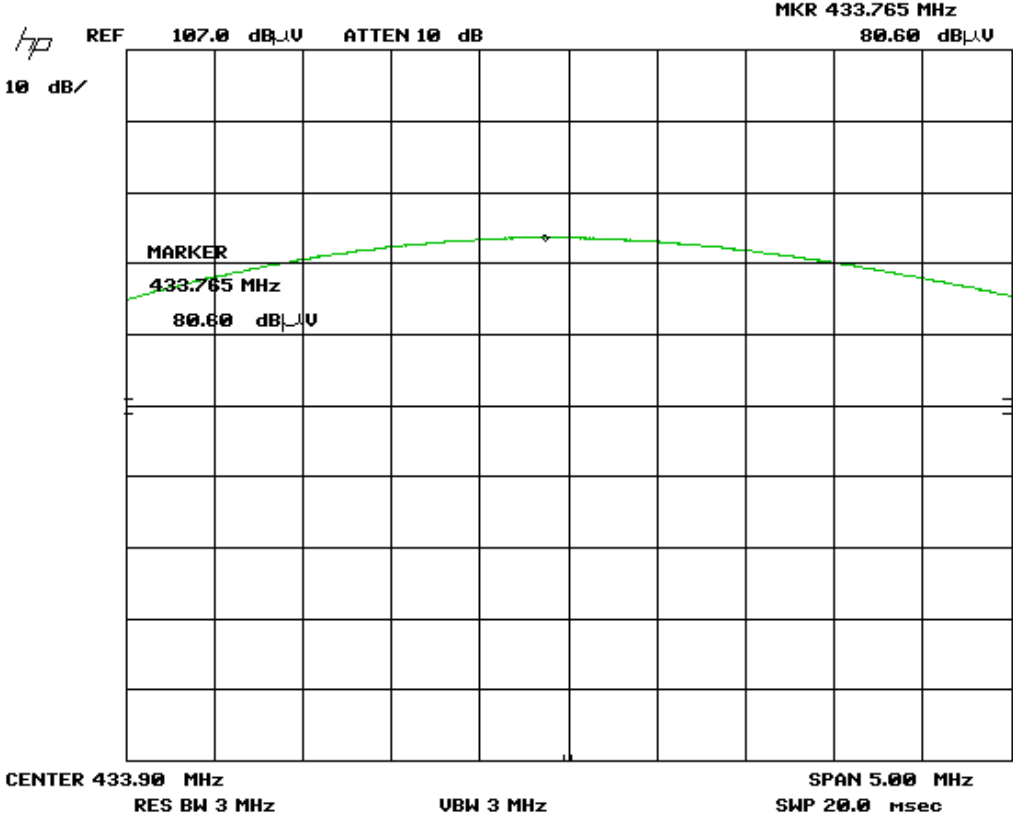

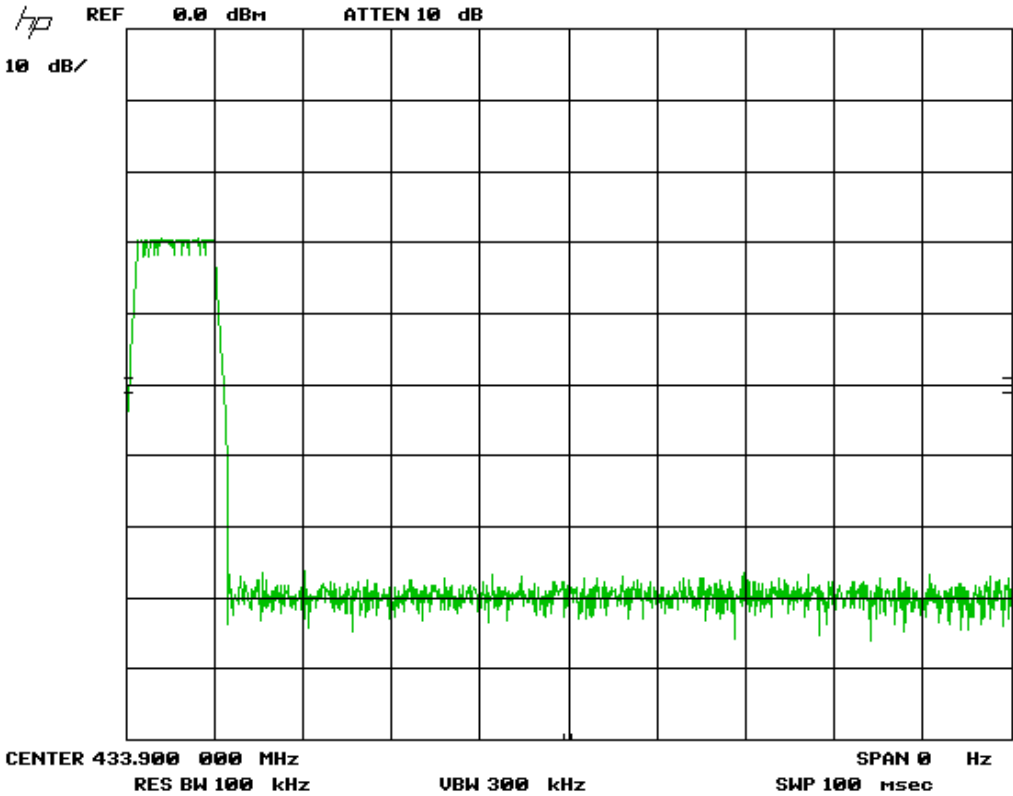

Client	Fortin Auto Radio Inc.	
Product	XH2298	
Standard(s)	RSS 210 Issue 8/ FCC Part 15 Subpart C 15	

Screen capture of pulse width – duty cycle



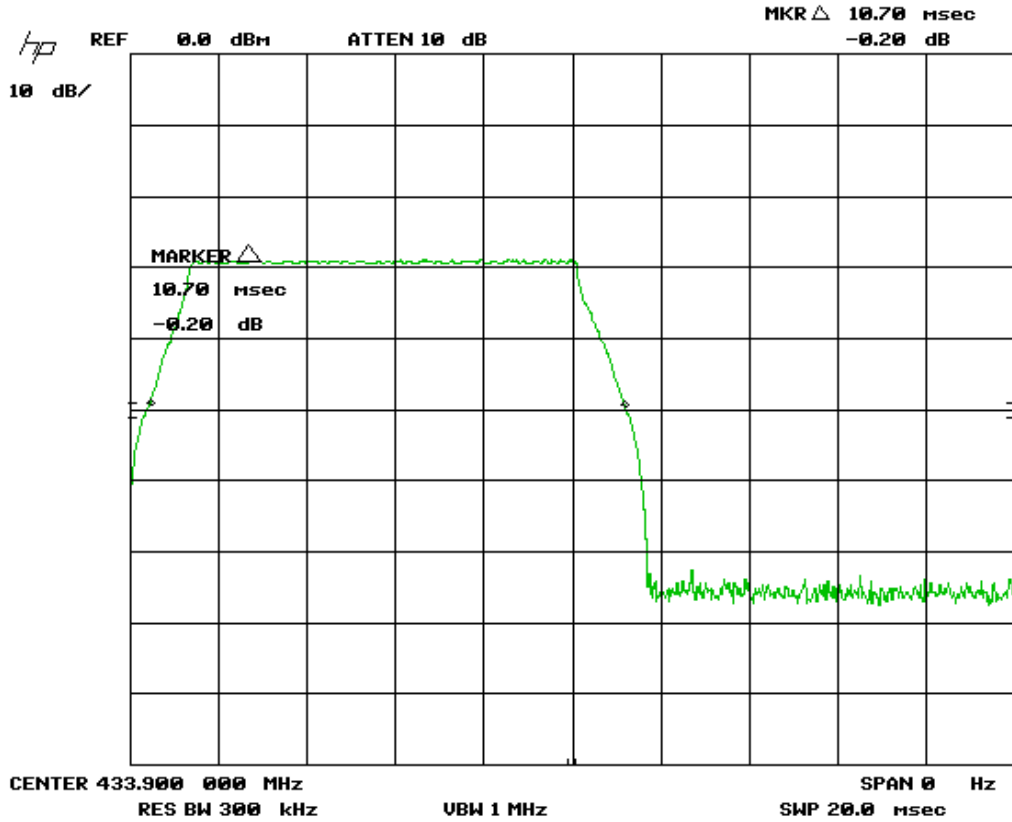

Client	Fortin Auto Radio Inc.	
Product	XH2298	
Standard(s)	RSS 210 Issue 8/ FCC Part 15 Subpart C 15	

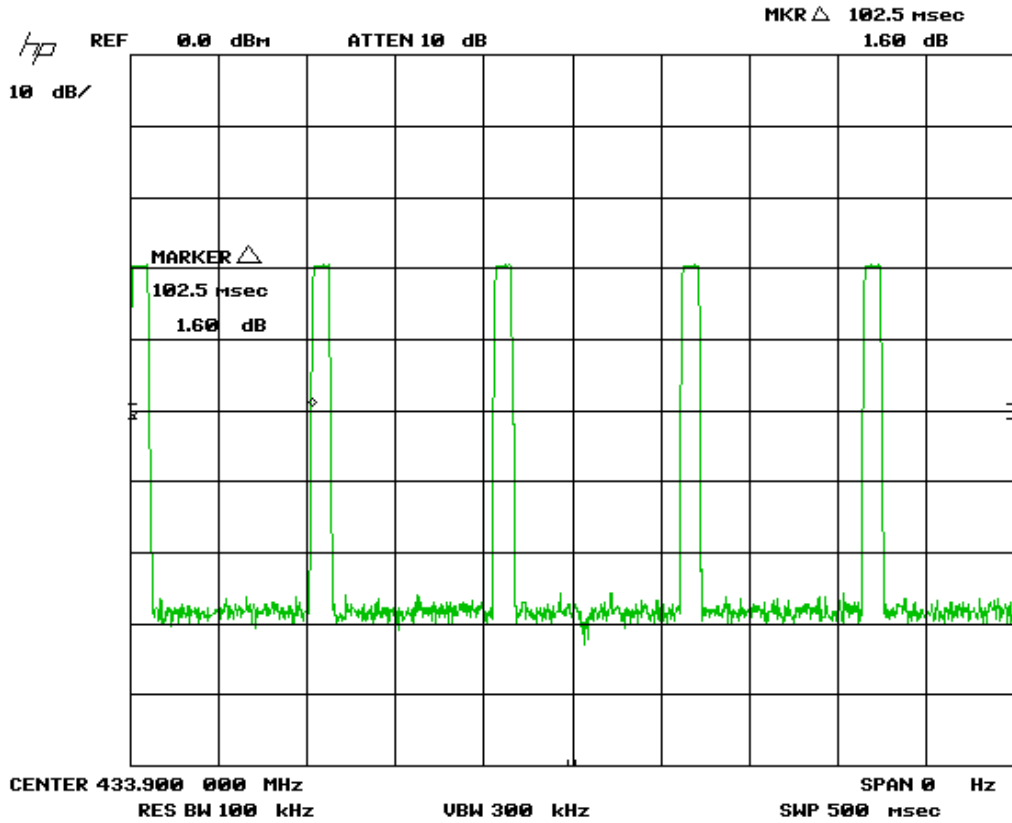

Client	Fortin Auto Radio Inc.	
Product	XH2298	
Standard(s)	RSS 210 Issue 8/ FCC Part 15 Subpart C 15	

Maximum repeat time.



Client	Fortin Auto Radio Inc.	
Product	XH2298	
Standard(s)	RSS 210 Issue 8/ FCC Part 15 Subpart C 15	

## Final Measurements

The device complies with the requirement. A worst case measurement of 99.6 dBuV/m at 3 meters was obtained at a center frequency of 433.92 MHz in the vertical polarity. The worst case measurement as listed in the table below appeared at a vertical antenna height of 140 cm and a table azimuth of 200 degrees, as pictured in Appendix A.

Test Freq. (MHz)	Detection mode	Antenna polarity (Horz/Vert)	Raw signal dB(μV)	Antenna factor dB	Cable loss dB	Atten. dB	Received signal dB(μV/m)	Emission limit dB(μV/m)	Margin dB(μV)	Result
433.92	Peak	Horz	80.6	17.1	0	1.9	99.6	100.8	1.2	PASS
433.92	Avg	Horz	61.2	17.1	0	1.9	80.2	80.8	0.6	PASS
433.92	Peak	Vert	75.6	16.5	0	1.9	94.0	100.8	6.8	PASS
433.92	Avg	Vert	56.2	16.5	0	1.9	74.6	80.8	6.2	PASS

The averaging factor was calculated from an ON time of 10.7ms per pulse using  $20\log(10.7\text{ms}/100\text{ms}) = -19.4\text{dB}$ . The Calculated Average is therefore  $99.6-19.4=80.2\text{dBuV/m}$ . The limit is  $80.8\text{dBuV/m}$ .

This is passing with 0.6 dB of margin to the requirement.



Client	Fortin Auto Radio Inc.	
Product	XH2298	
Standard(s)	RSS 210 Issue 8/ FCC Part 15 Subpart C 15	

## Test Equipment List

Equipment	Model No.	Manufacturer	Last calibration date	Next calibration due date	Asset #
Spectrum Analyzer	8566B	HP	1/22/13	1/22/15	4169
Quasi Peak Adapter	85650A	HP	1/23/13	1/23/15	4170
BiLog Antenna	3142-C	ETS	4/25/13	4/25/15	4002
Attenuator 3 dB	FP-50-3	Trilithic	N/A	N/A	4028
9kHz-1GHz, 28dB preamp	LNA 6901	Teseq	8-6-13	8-6-15	4036
RF Cable 7m	LMR-400-7M-50OHM-MN-MN	LexTec	NCR	NCR	4026
RF Cable 1M	LMR-400-1M-50OHM-MN-MN	LexTec	N/A	N/A	4039
RF Cable 10m	LMR-400-10M-50OHM-MN-MN	LexTec	NCR	NCR	4025

This report module is based on GEMC template "FCC - 15.209 - Radiated Emissions\_Rev5.doc"

Client	Fortin Auto Radio Inc.	
Product	XH2298	
Standard(s)	RSS 210 Issue 8/ FCC Part 15 Subpart C 15	

## ***Unintentional Radiated Emissions and Spurious Emissions***

### **Purpose**

The purpose of this test is to ensure that the RF energy unintentionally emitted from the EUT does not exceed the limits listed below as defined in the applicable test standard, as measured from a receiving antenna. This helps protect broadcast radio services such as television, FM radio, pagers, cellular telephones, emergency services, and so on, from unwanted interference.

### **Limit(s) and Method**

The method is as defined in ANSI C63.4:2003.

The limits are as defined in FCC Part 15, Section 15.231 (b), and 15.209 (a) in the frequency ranges specified in 15.205 (a). The tables below show the values of these limits.

#### FCC 15.231 (b) Emission Limits:

Fundamental frequency (MHz)	Field strength of fundamental (microvolts/meter)	Field strength of spurious emissions (microvolts/meter)
40.66–40.70	2,250	225
70–130	1,250	125
130–174	<sup>1</sup> 1,250 to 3,750	<sup>1</sup> 125 to 375
174–260	3,750	375
260–470	<sup>1</sup> 3,750 to 12,500	<sup>1</sup> 375 to 1,250
Above 470	12,500	1,250

<sup>1</sup>Linear interpolations.

(1) The above field strength limits are specified at a distance of 3 meters. The tighter limits apply at the band edges.

#### FCC 15.205 (a) Restricted Frequency Bands:

Client	Fortin Auto Radio Inc.	
Product	XH2298	
Standard(s)	RSS 210 Issue 8/ FCC Part 15 Subpart C 15	

MHz	MHz	MHz	GHz
0.090–0.110	16.42–16.423	399.9–410	4.5–5.15
<sup>1</sup> 0.495–0.505	16.69475–16.69525	608–614	5.35–5.46
2.1735–2.1905	16.80425–16.80475	960–1240	7.25–7.75
4.125–4.128	25.5–25.67	1300–1427	8.025–8.5
4.17725–4.17775	37.5–38.25	1435–1626.5	9.0–9.2
4.20725–4.20775	73–74.6	1645.5–1646.5	9.3–9.5
6.215–6.218	74.8–75.2	1660–1710	10.6–12.7
6.26775–6.26825	108–121.94	1718.8–1722.2	13.25–13.4
6.31175–6.31225	123–138	2200–2300	14.47–14.5
8.291–8.294	149.9–150.05	2310–2390	15.35–16.2
8.362–8.366	156.52475–156.52525	2483.5–2500	17.7–21.4
8.37625–8.38675	156.7–156.9	2690–2900	22.01–23.12
8.41425–8.41475	162.0125–167.17	3260–3267	23.6–24.0
12.29–12.293	167.72–173.2	3332–3339	31.2–31.8
12.51975–12.52025	240–285	3345.8–3358	36.43–36.5
12.57675–12.57725	322–335.4	3600–4400	( <sup>2</sup> )
13.36–13.41			

<sup>1</sup>Until February 1, 1999, this restricted band shall be 0.490–0.510 MHz.

<sup>2</sup>Above 38.6

#### FCC 15.209 (a) Emission Limits

Frequency (MHz)	Field strength (microvolts/meter)	Measurement distance (meters)
0.009–0.490	2400/F(kHz)	300
0.490–1.705	24000/F(kHz)	30
1.705–30.0	30	30
30–88	100**	3
88–216	150**	3
216–960	200**	3
Above 960	500	3

Note: A peak limit that is 20 dB higher than the limits specified above applies.

Client	Fortin Auto Radio Inc.	
Product	XH2298	
Standard(s)	RSS 210 Issue 8/ FCC Part 15 Subpart C 15	

### Typical Radiated Emissions Setup

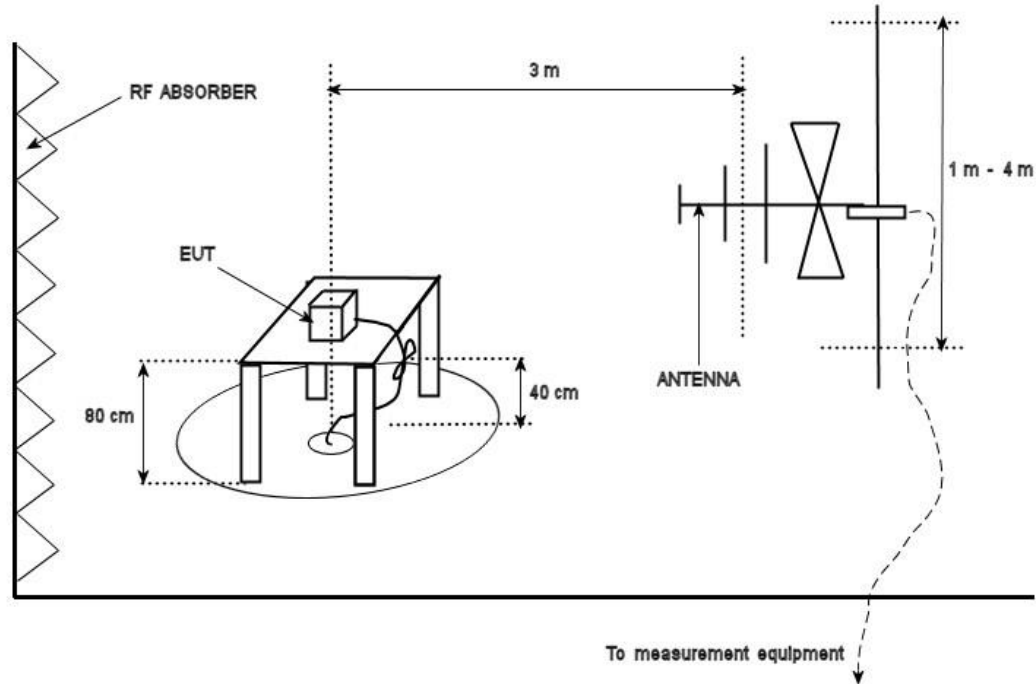

### Measurement Uncertainty

The expanded measurement uncertainty is calculated in accordance with CISPR 16-4-2 and is +/-4.4 dB with a 'k=2' coverage factor and a 95% confidence level.

### Preliminary Graphs

Note the graphs shown below are for graphical illustration only. For final measurements with the appropriate detector, please refer to the final measurement table where applicable. The graph shown below is a maximized peak measurement graph, measured with a resolution bandwidth greater than the final required detector and over a full 0-360 rotation. This peaking process is done as a worst case measurement. This process enables the detection of frequencies of concern for final measurement, and provides considerable time savings. Final measurements are performed over a full 0-360 degrees rotation and 1 – 4 meter height of measurement antenna.

In accordance with FCC Part 15, Subpart A, Section 15.33, the device was scanned to a minimum of a 4.4 GHz.

Client	Fortin Auto Radio Inc.	
Product	XH2298	
Standard(s)	RSS 210 Issue 8/ FCC Part 15 Subpart C 15	

Loop @ 0 degree – Peak Emissions Graph

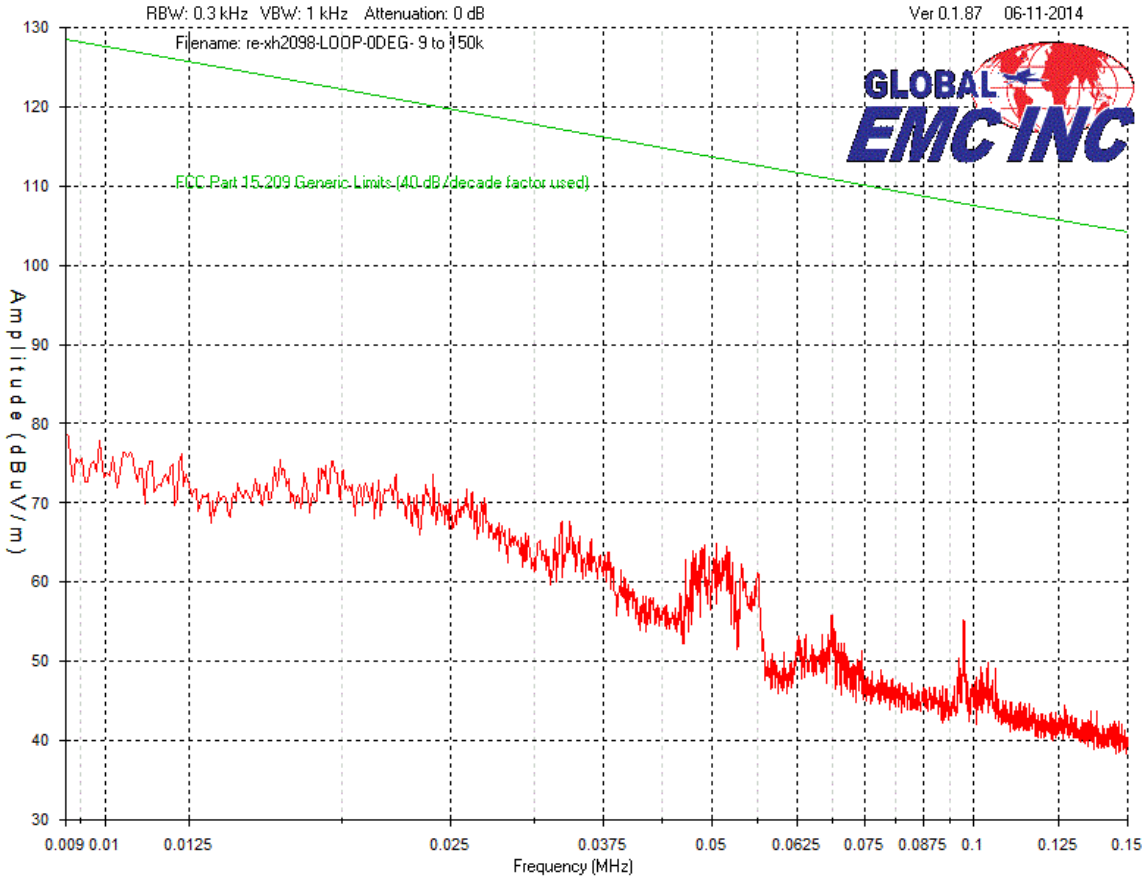

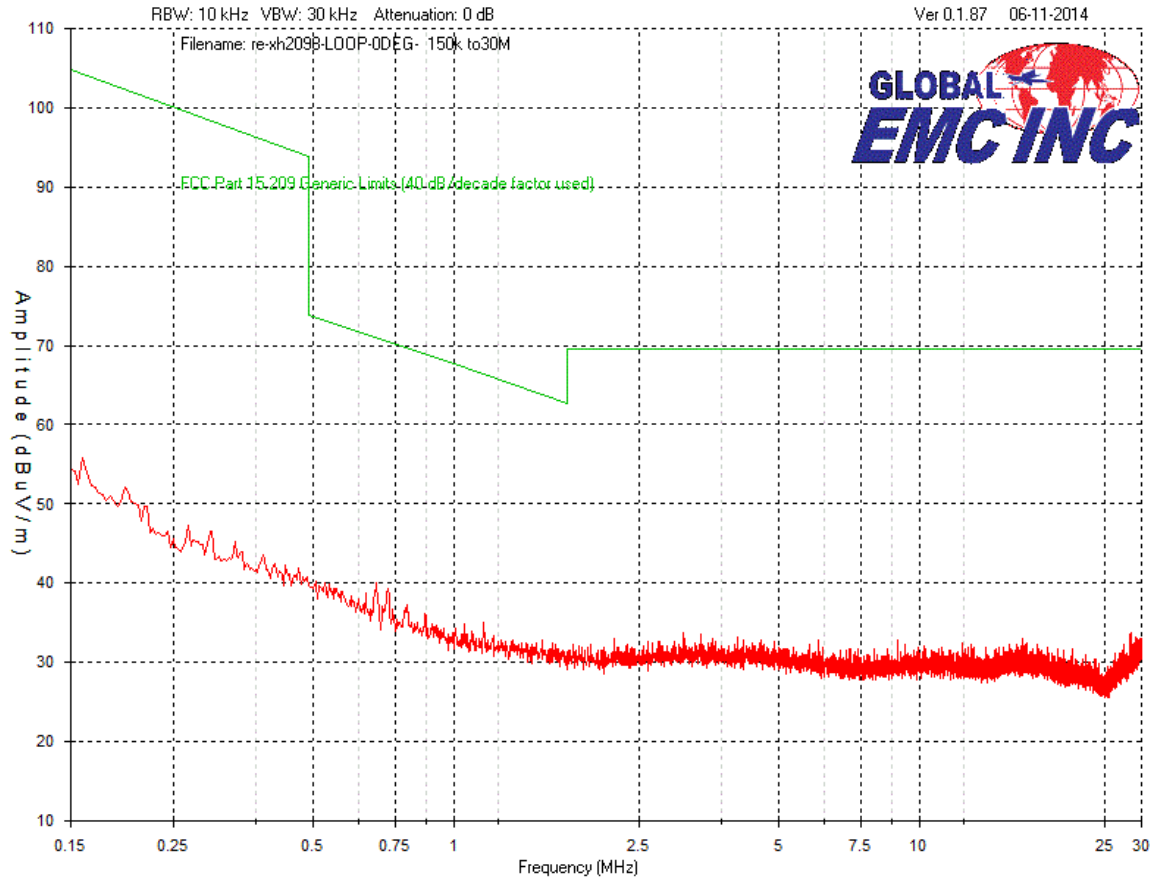

Client	Fortin Auto Radio Inc.
Product	XH2298
Standard(s)	RSS 210 Issue 8/ FCC Part 15 Subpart C 15

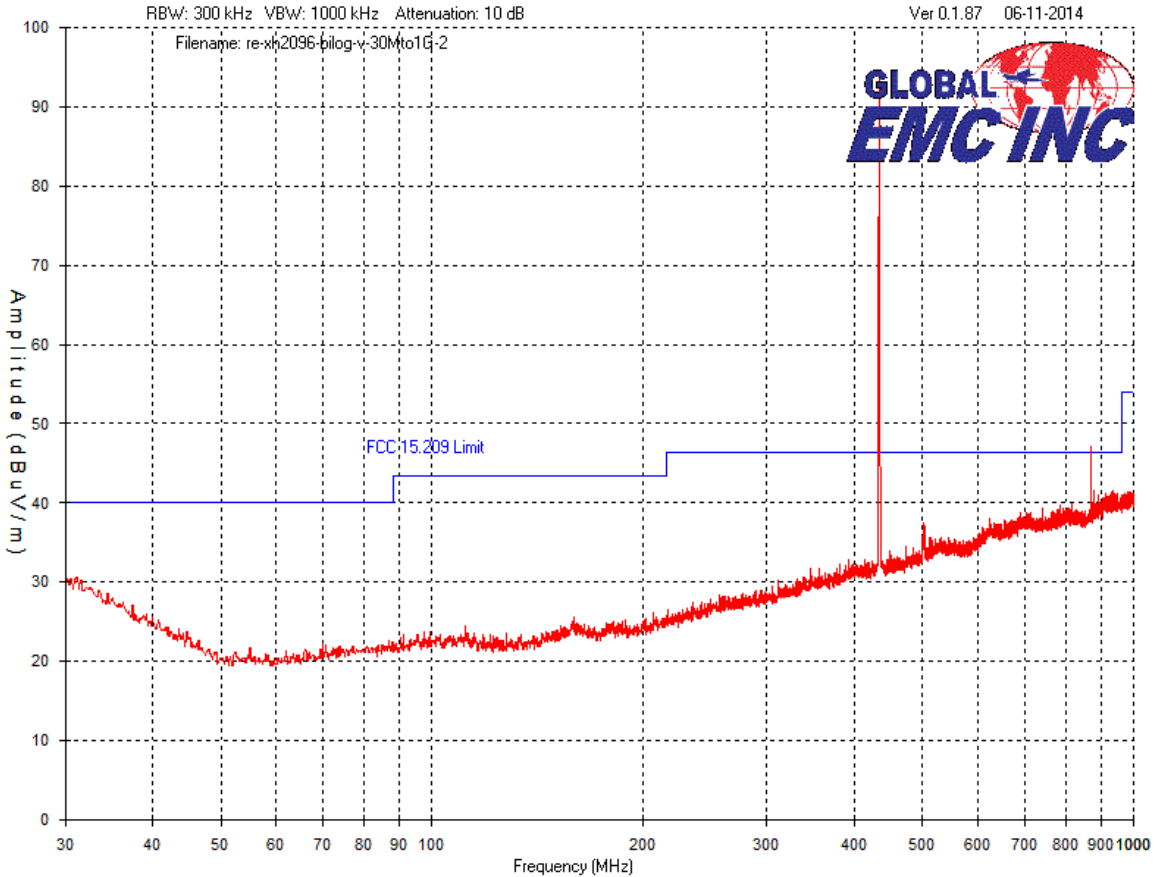

Client	Fortin Auto Radio Inc.	
Product	XH2298	
Standard(s)	RSS 210 Issue 8/ FCC Part 15 Subpart C 15	

Vertical – Peak Emissions Graph



Client	Fortin Auto Radio Inc.	
Product	XH2298	
Standard(s)	RSS 210 Issue 8/ FCC Part 15 Subpart C 15	

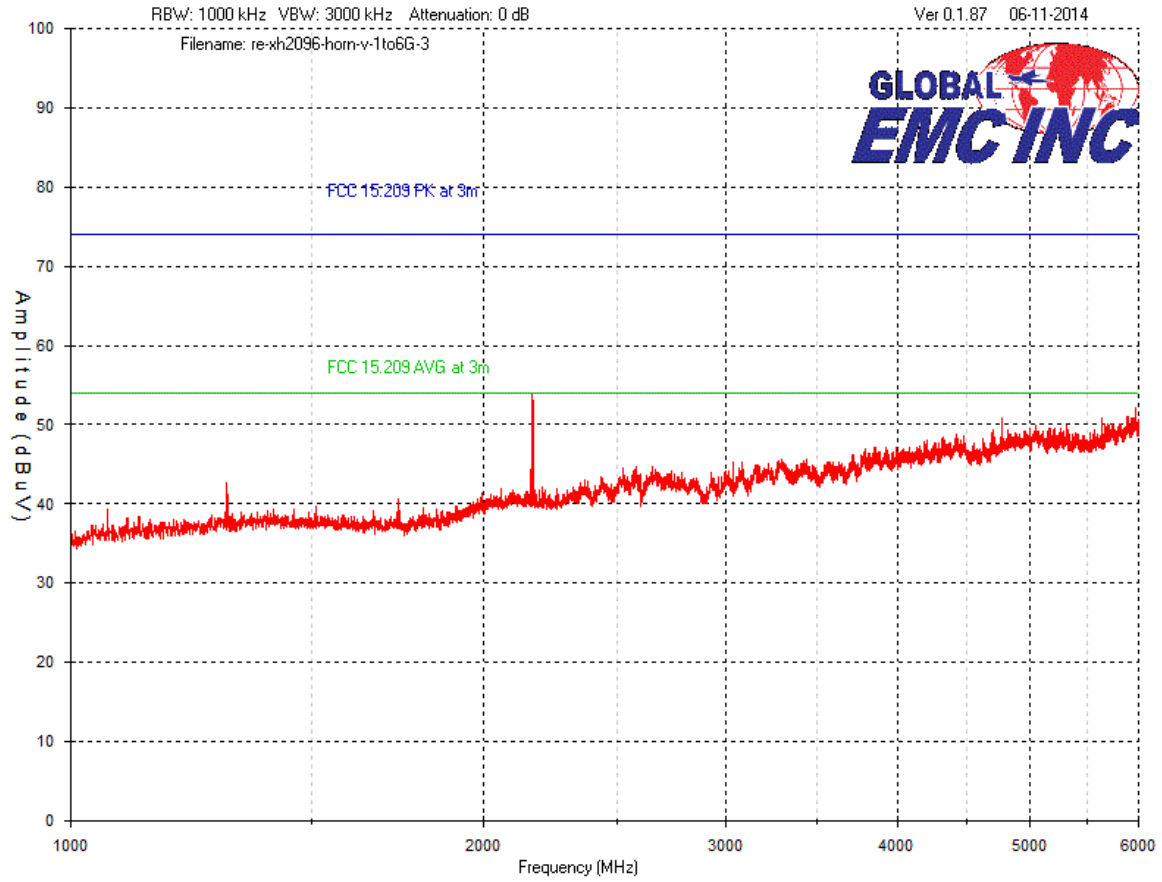



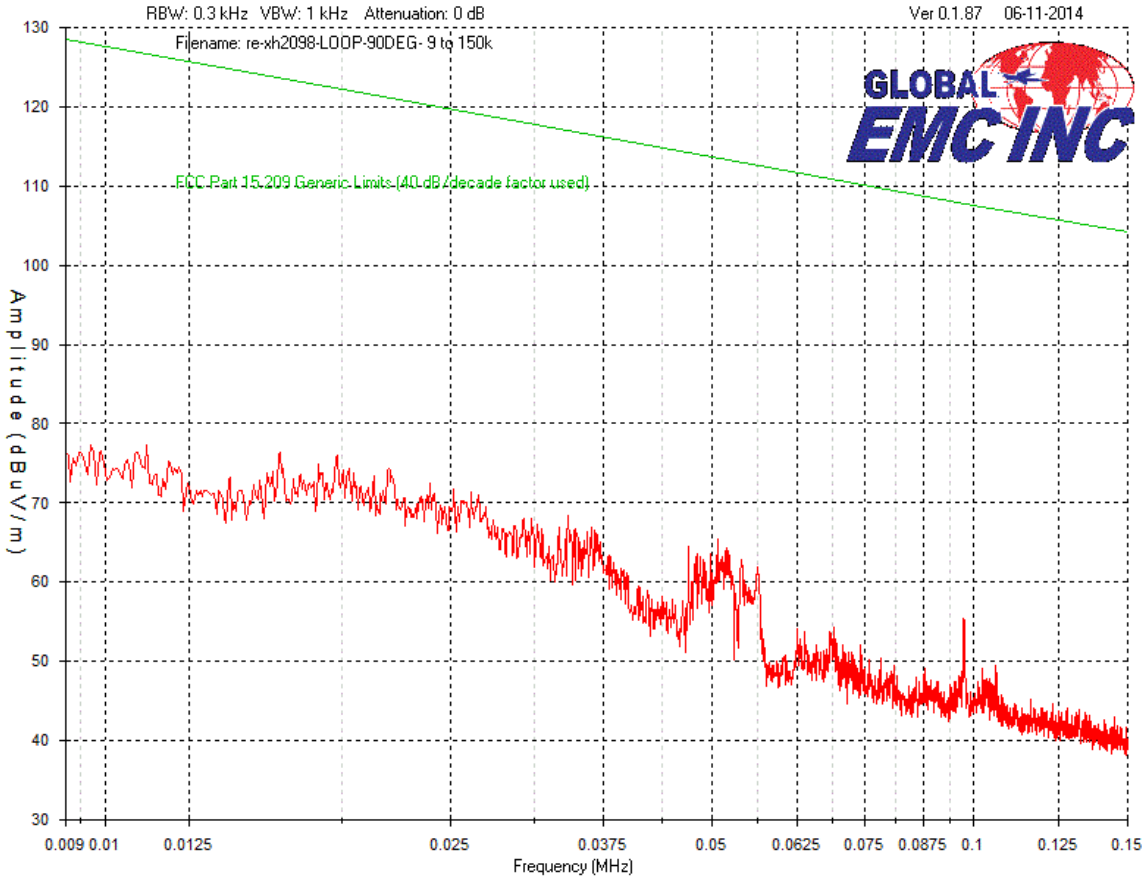

Client	Fortin Auto Radio Inc.	
Product	XH2298	
Standard(s)	RSS 210 Issue 8/ FCC Part 15 Subpart C 15	

Loop @ 90 degree – Peak Emissions Graph



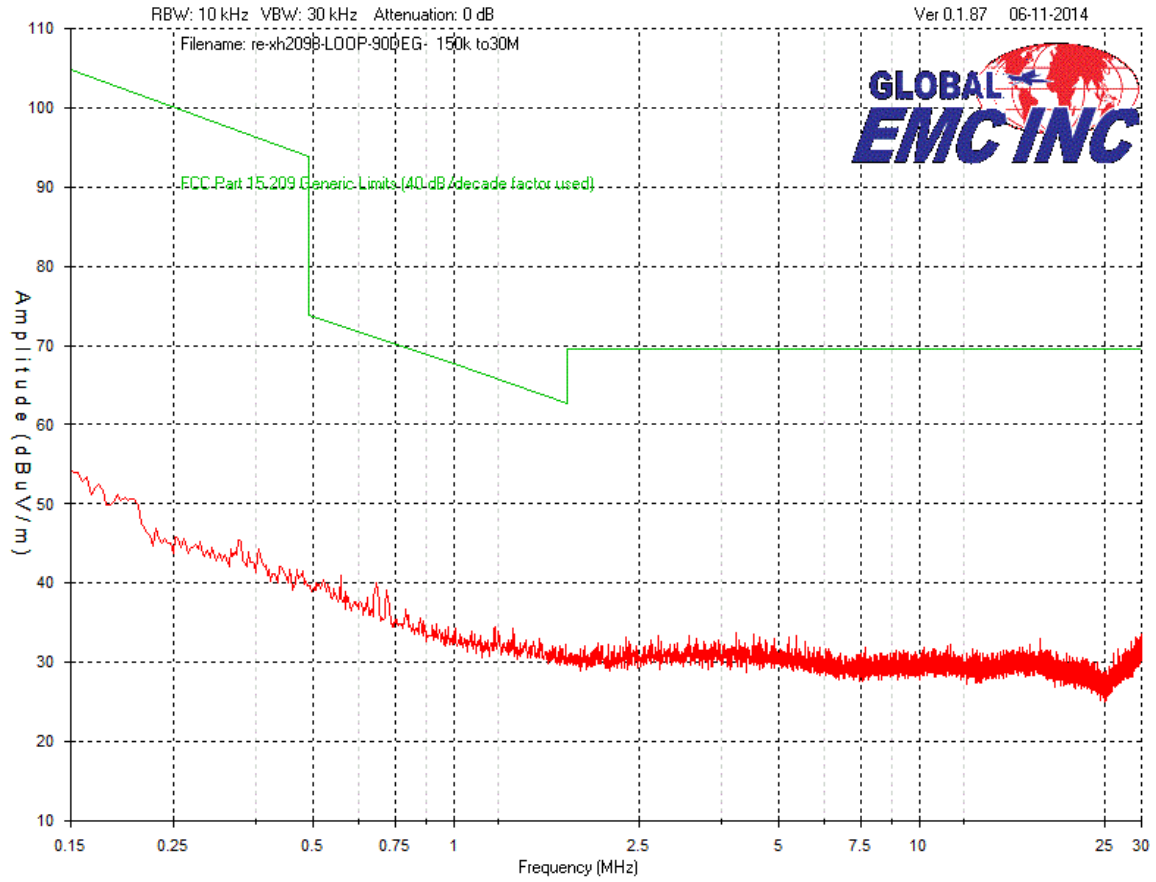

Client	Fortin Auto Radio Inc.
Product	XH2298
Standard(s)	RSS 210 Issue 8/ FCC Part 15 Subpart C 15



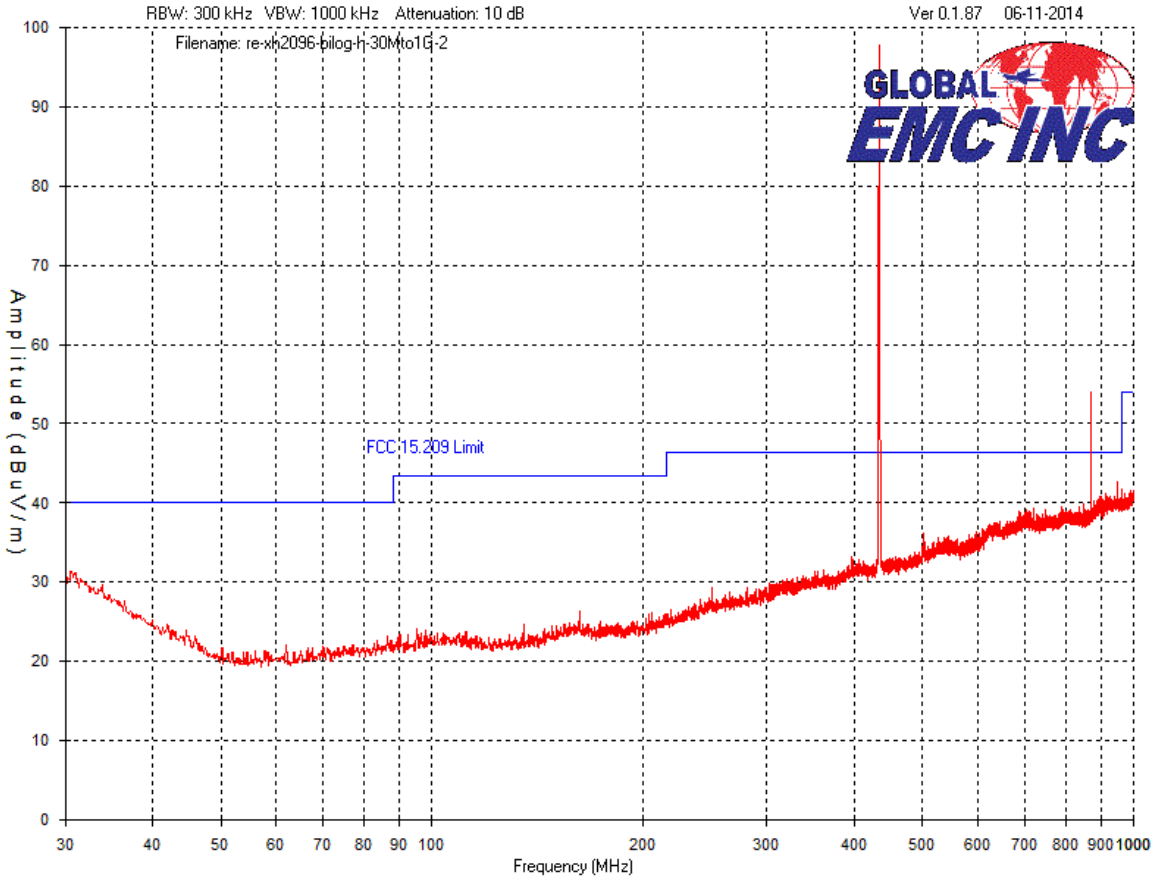

Client	Fortin Auto Radio Inc.	
Product	XH2298	
Standard(s)	RSS 210 Issue 8/ FCC Part 15 Subpart C 15	

Horizontal – Peak Emissions Graph

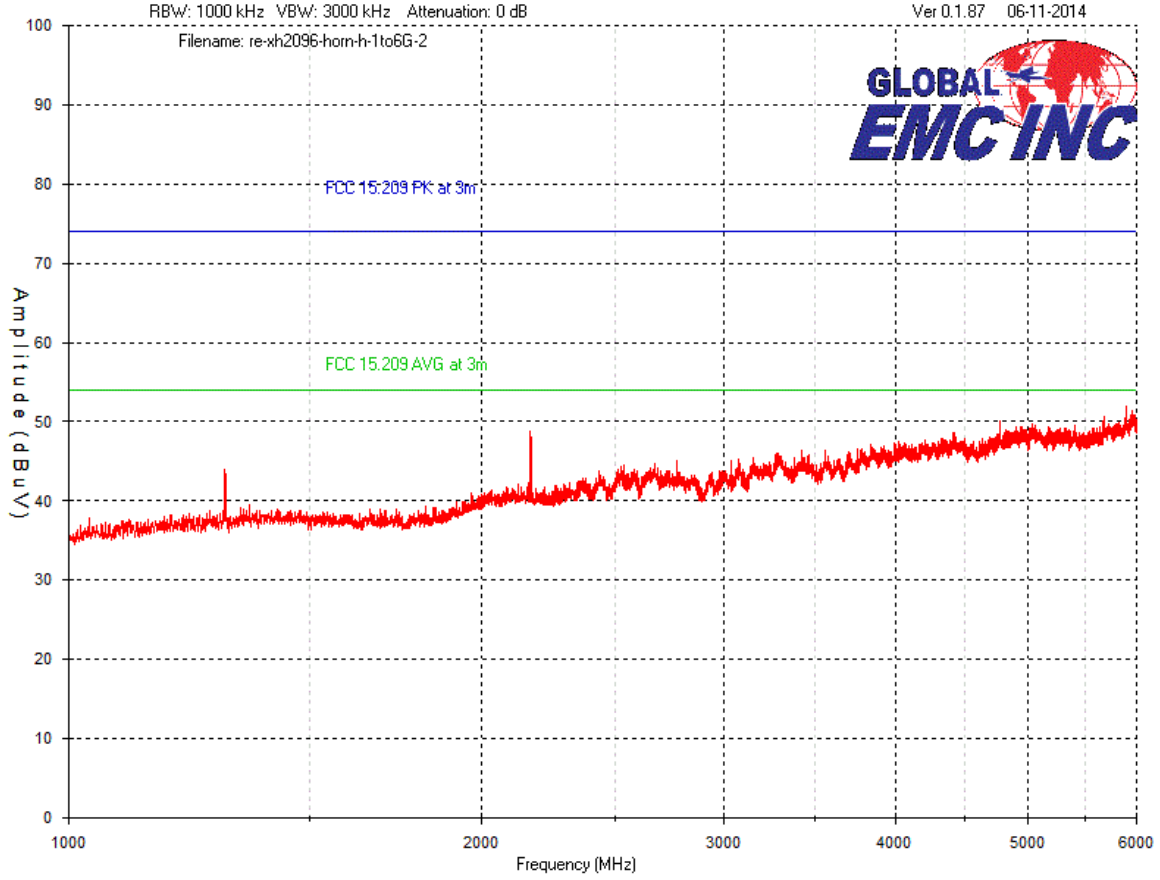

Client	Fortin Auto Radio Inc.	
Product	XH2298	
Standard(s)	RSS 210 Issue 8/ FCC Part 15 Subpart C 15	



Client	Fortin Auto Radio Inc.	
Product	XH2298	
Standard(s)	RSS 210 Issue 8/ FCC Part 15 Subpart C 15	

## Final Measurements

The device complies with the requirement. A worst case measurement of 54.0 dBuV/m at 3 meters was obtained at a frequency of 868 MHz. The worst case measurement as listed in the table below appeared at a vertical antenna height of 120 cm and a table azimuth of 260 degrees, as pictured in Appendix A.

Test Freq. (MHz)	Det. mode	Antenna polarity (Horz/Vert)	Raw signal dB $\mu$ V	Ant. factor dB	Att. dB	Cable loss dB	Pre-Amp Gain dB	Received signal dB( $\mu$ V/m)	Emission limit dB( $\mu$ V/m)	Margin dB $\mu$ V	Result
868	Peak	Horz	50.9	22.9	6	2.7	-28.5	54.0	80.8	26.8	PASS
868	Avg	Horz	31.5	22.9	6	2.7	-28.5	34.6	60.8	26.2	PASS
868	Peak	Vert	44.0	22.9	6	2.7	-28.5	47.1	80.8	33.7	PASS
868	Avg	Vert	24.6	22.9	6	2.7	-28.5	27.7	60.8	33.1	PASS
1302	Peak	Horz	49.4	25	0	3.4	-33.7	44.1	74	29.9	PASS
1302	Avg	Horz	30.0	25	0	3.4	-33.7	24.7	54	29.3	PASS
1302	Peak	Vert	48.0	25	0	3.4	-33.7	42.7	74	31.3	PASS
1302	Avg	Vert	28.6	25	0	3.4	-33.7	23.3	54	30.7	PASS
2170	Peak	Horz	50.1	27.2	0	4.6	-33.1	48.8	80.8	32.0	PASS
2170	Avg	Horz	30.7	27.2	0	4.6	-33.1	29.4	60.8	31.4	PASS
2170	Peak	Vert	55.1	27.2	0	4.6	-33.1	53.8	80.8	27.0	PASS
2170	Avg	Vert	35.7	27.2	0	4.6	-33.1	34.4	60.8	26.4	PASS

Note: Average measurements are shown by applying a duty cycle correction factor, as reported previously in this test report, to the peak data.

Client	Fortin Auto Radio Inc.	
Product	XH2298	
Standard(s)	RSS 210 Issue 8/ FCC Part 15 Subpart C 15	

## Test Equipment List

Equipment	Model No.	Manufacturer	Last calibration date	Next calibration due date	Asset #
Spectrum Analyzer	8566B	HP	1/22/13	1/22/15	4169
Quasi Peak Adapter	85650A	HP	1/23/13	1/23/15	4170
Loop Antenna	EM 6879	Electro-Metrics	10-11-13	10-11-15	4040
BiLog Antenna	3142-C	ETS	4/25/13	4/25/15	4002
Attenuator 3 dB	FP-50-3	Trilithic	N/A	N/A	4028
9kHz-1GHz, 28dB preamp	LNA 6901	Teseq	8-6-13	8-6-15	4036
Horn Antenna	ATH1G18G	AR	4/3/13	4/3/15	4003
1GHz-26.5GHz preamp	HP 8449B	HP	4/25/13	4/25/15	4006
RF Cable 7m	LMR-400-7M-50OHM-MN-MN	LexTec	NCR	NCR	4026
RF Cable 1M	LMR-400-1M-50OHM-MN-MN	LexTec	N/A	N/A	4039
RF Cable 10m	LMR-400-10M-50OHM-MN-MN	LexTec	NCR	NCR	4025

This report module is based on GEMC template "FCC - 15.209 - Radiated Emissions\_Rev5.doc"

Client	Fortin Auto Radio Inc.	
Product	XH2298	
Standard(s)	RSS 210 Issue 8/ FCC Part 15 Subpart C 15	

## Appendix A – EUT Summary

For further details for filing purposes, refer to filing package.

### General EUT Description

Client Details	
Organization / Address	Fortin Auto Radio Inc. 5540 Metropolitan E. Montreal, Qc, H1S 1A6 Canada
Contact	Martin Tessier
Phone	514-255-2720 ext 231
Email	Martin.tessier@fortinradio.ca
EUT (Equipment Under Test) Details	
EUT Name (for report title)	XH2298
EUT revision	New Product
Software version	1.0
EUT is powered using	DC
Input voltage range(s) (V)	12 Volts
Frequency range(s) (Hz)	433.92Mhz
Rated input current (A)	32 mA
Number of power supplies in EUT	0
Transmits RF energy? (describe)	10dB
Basic EUT functionality description	Sleep and wait for data until a valid message is detect. When the valid message is detect, the ETU sends a confirmation/ACK command to the remote key fob.
Customer to setup EUT on site?	yes
EUT response time (ms)	NA
EUT setup time (min)	1
Frequency of all clocks present in EUT	26 Mhz
Dimensions of product	L 76mm W 24mm H 9mm

Client	Fortin Auto Radio Inc.	
Product	XH2298	
Standard(s)	RSS 210 Issue 8/ FCC Part 15 Subpart C 15	

Note the EUT is considered to have been received the date of the commencement of the first test, unless otherwise stated. For a close-up picture of the EUT, see ‘Appendix B – EUT & Test Setup Photographs’.



Client	Fortin Auto Radio Inc.	
Product	XH2298	
Standard(s)	RSS 210 Issue 8/ FCC Part 15 Subpart C 15	

## Appendix B – EUT and Test Setup Photographs

Note: These photos are for information purposes only. Also refer to PDF files that are separate from this test report.

Client	Fortin Auto Radio Inc.	
Product	XH2298	
Standard(s)	RSS 210 Issue 8/ FCC Part 15 Subpart C 15	

**EUT's Photo**



Client	Fortin Auto Radio Inc.	
Product	XH2298	
Standard(s)	RSS 210 Issue 8/ FCC Part 15 Subpart C 15	

**Radiated Emission Test Setup Photo #1:**



Client	Fortin Auto Radio Inc.	
Product	XH2298	
Standard(s)	RSS 210 Issue 8/ FCC Part 15 Subpart C 15	

**Radiated Emission Test Setup Photo #2:**



Client	Fortin Auto Radio Inc.	
Product	XH2298	
Standard(s)	RSS 210 Issue 8/ FCC Part 15 Subpart C 15	

**Radiated Emission Test Setup Photo #3:**

