

TEST REPORT

Report Number: 103224477MPK-006

Project Number: G103224477

December 27, 2017

**Testing performed on the
FIBERGATEWAY**

Model Number: GR240BG

FCC ID: 2ACJF-FGW-GR240BG

to

**FCC Part 15, Subpart E
(DFS Report)**

For

Altice Labs, SA

Test Performed by:

Intertek

1365 Adams Court

Menlo Park, CA 94025 USA

Test Authorized by:

Altice Labs, SA

Rua Eng. Ferreira Pinto Basto

3810-106 Aveiro, Portugal

Prepared by:



Anderson Soungpanya

Date: December 27, 2017

Reviewed by:



Krishna K Vemuri

Date: December 27, 2017

This report is for the exclusive use of Intertek's Client and is provided pursuant to the agreement between Intertek and its Client. Intertek's responsibility and liability are limited to the terms and conditions of the agreement. Intertek assumes no liability to any party, other than to the Client in accordance with the agreement, for any loss, expense or damage occasioned by the use of this report. Only the Client is authorized to copy or distribute this report and then only in its entirety. Any use of the Intertek name or one of its marks for the sale or advertisement of the tested material, product or service must first be approved in writing by Intertek. The observations and test results in this report are relevant only to the sample tested. This report by itself does not imply that the material, product, or service is or has ever been under an Intertek certification program. This report must not be used to claim product endorsement by A2LA, NIST nor any other agency of the U.S. Government.

VERIFICATION OF COMPLIANCE

Report No. 103224477MPK-006

Verification is hereby issued to the named APPLICANT and is VALID ONLY for the equipment identified hereon for use under the rules and regulations listed below.

Equipment Under Test:	FIBERGATEWAY
Trade Name:	Altice Labs, SA
Model No.:	GR240BG
Applicant:	Altice Labs, SA
Contact:	Ricardo Cunha
Address:	Altice Labs, SA Rua Eng. Ferreira Pinto Basto 3810-106 Aveiro
Country	Portugal
Tel. Number:	351234403200
Email:	Rcunha@ptinovacao.pt
Applicable Regulation:	FCC Part 15, Subpart E
Date of Test:	November 28 to December 13, 2017

We attest to the accuracy of this report:



Anderson Soungpanya
EMC Project Engineer



Krishna K Vemuri
Engineering Team Lead

TABLE OF CONTENTS

1.0	Introduction.....	5
1.1	Summary of Tests.....	5
2.0	General Description	6
2.1	Product Description.....	6
2.2	Related Submittal(s) Grants	7
2.3	Test Methodology	7
2.4	Test Facility.....	7
2.5	Measurement Uncertainty	7
3.0	System Test Configuration.....	8
3.1	Equipment Under Test	8
3.2	Support Equipment and description	8
3.4	Mode of Operation During Test	8
3.5	Modifications required for Compliance	9
3.6	Additions, deviations and exclusions from standards.....	9
4.0	Dynamic Frequency Selection (DFS).....	10
4.1	Requirement.....	10
4.1.1	DFS Detection Thresholds for Master or Client Devices with DFS Detection	11
4.1.2	Test Waveform.....	12
4.2	DFS Waveform Calibration.....	17
4.2.1	Calibration Procedure.....	17
4.2.2	Calibration Results	18
4.3	DFS Test Procedures.....	26
4.4	U-NII Detection Bandwidth	27
4.4.1	Test Procedure.....	27
4.4.2	Test Results	28
4.5	Initial Channel Availability Check Time.....	32
4.5.1	Test Procedure.....	32
4.5.2	Test Results	33
4.6	Radar Burst at the Beginning of the Channel Availability Check Time.....	34
4.6.1	Test Procedure.....	34
4.6.2	Test Results	35
4.7	Radar Burst at the End of the Channel Availability Check Time	36
4.7.1	Test Procedure.....	36
4.7.2	Test Results	37
4.8	In-Service Monitoring for Channel Move Time, Channel Closing Transmission Time and Non-Occupancy Period	38
4.8.1	Test Procedure.....	38
4.8.1	Test Results Channel Move time.....	39
4.8.2	Test Results Channel Close Time	40
4.8.3	Test Results Non-Occupancy Period.....	42
4.8.4	Test Results Channel Loading.....	43
4.9	Statistical Performance Check.....	44
4.9.1	Test Procedure.....	44

4.9.2	Test Results 802.11a at 5700MHz	45
4.9.3	Test Results 802.11n 20MHz at 5700MHz.....	51
4.9.4	Test Results 802.11n 40MHz at 5670MHz.....	57
4.9.5	Test Results 802.11ac 80MHz at 5530MHz	63
5.0	List of Test Equipment	69
6.0	Document History	70
	Appendix A - FCC Radar Type 5 Waveform	71

1.0 Introduction

1.1 Summary of Tests

Test	Reference FCC	Result
Dynamic Frequency Selection (DFS)		
U-NII Detection Bandwidth	15.407(h)	Complies
Initial Channel Availability Check Time	15.407(h)	Complies
Channel Availability Check Time in Beginning	15.407(h)	Complies
Channel Availability Check Time at End	15.407(h)	Complies
In Service Monitoring – Channel Closing Transmission Time	15.407(h)	Complies
In Service Monitoring – Channel Closing Move Time	15.407(h)	Complies
In Service Monitoring – Non-Occupancy Period	15.407(h)	Complies
In Service Monitoring – Statistical Performance Check	15.407(h)	Complies

EUT receive date: September 18, 2017

EUT receive condition: The pre-production version of the EUT was received in good condition with no apparent damage. As declared by the Applicant, it is identical to the production units.

Test start date: November 28, 2017

Test completion date: December 13, 2017

The test results in this report pertain only to the item tested.

2.0 General Description

2.1 Product Description

Altice Labs, SA supplied the following description of the EUT:

The FiberGateway GR240AG is an ONT (Optical Network Terminal) solution based on Rec. ITU-T G.984.x that supports triple play services (high speed internet, voice and video) which are deployed over Ethernet and Wi-Fi interfaces. GEM (GPON encapsulation method) is employed to adapt technologies. This system can be used in triple play service delivery network solutions. It includes Home Gateway functionalities, 4 GbE ports and Wi-Fi Dual-Band Concurrent (2.4 GHz bgn 4x4 + 5 GHz anac 4x4) for internet access and IPTV, 2 FXS ports for voice and 1 USB 2.0 port.

For more information, see user’s manual provided by the manufacturer.

The information about the 5GHz radio, installed in the model GR240BG, is presented below.

Applicant	Altice Labs, SA
Model No.	GR240BG
FCC ID	2ACJF-FGW-GR240BG
Rated RF Output	802.11a: 21.48dBm (U-NII 2A); 21.59dBm (U-NII 2C) 802.11n 20MHz: 21.39dBm (U-NII 2A); 21.62dBm (U-NII 2C) 802.11n 40MHz: 22.34dBm (U-NII 2A); 22.03dBm (U-NII 2C) 802.11ac 80MHz: 20.99dBm (U-NII 2A); 20.79dBm (U-NII 2C)
Master or Client Device	Master
Frequency Range	U-NII 2A: 5250 – 5350 MHz U-NII 2C: 5470 – 5725 MHz
Operating Mode	Master with DFS detection capabilities
Type of modulation	OFDM
Antenna(s) & Gain	Internal Antenna, 4.95 dBi calculated peak gain Ant 0 – DB1: 4.8dBi, Vertical Ant 1 – DB2: 3.4dBi, Horizontal Ant 2 – DB3: 4.0dBi, Horizontal Ant 3 – DB4: 5.1dBi, Vertical
Manufacturer Name & Address	Altice Labs, SA Rua Eng. Ferreira Pinto Basto 3810-106 Aveiro Portugal

The EUT supports a wide range of data rates in the U-NII 1 band:

- IEEE 802.11a
- IEEE 802.11n 20MHz
- IEEE 802.11n 40MHz
- IEEE 802.11ac 20MHz
- IEEE 802.11ac 40MHz
- IEEE 802.11ac 80MHz

2.2 Related Submittal(s) Grants

None.

2.3 Test Methodology

Antenna conducted measurements were performed according to the FCC documents “Guidelines for Compliance Testing of Unlicensed National Information Infrastructure (U-NII) Devices Part 15, Subpart E” (789033 D02 General U-NII Test Procedures New Rules v01r04 & 905462 D02 UNII DFS Compliance Procedures New Rules v02).

Both AC mains line-conducted and radiated emissions measurements were performed according to the procedures in ANSI C63.4. Radiated tests were performed at an antenna to EUT distance of 3 meters, unless stated otherwise in the "**Data Sheet**" of this Application.

All other measurements were made in accordance with the procedures in part 2 of CFR 47.

2.4 Test Facility

The test site used to collect the radiated data is site 1 (10-m semi-anechoic chamber). This test facility and site measurement data have been fully placed on file with the FCC, IC and A2LA accredited.

2.5 Measurement Uncertainty

Compliance with the limits was based on the results of the measurements and doesn't take into account the measurement uncertainty.

Estimated Measurement Uncertainty

Measurement	Expanded Uncertainty (k=2)
	1 GHz – 6 GHz
Dynamic Frequency Selection (Conducted Measurement)	1.5 dB

3.0 System Test Configuration

3.1 Equipment Under Test

Equipment Under Test			
Description	Manufacturer	Model Number	Serial Number
FiberGateway (Conducted Unit)	Altice Labs, SA	GR240BG	5054494E912C0D4F
AC/DC Power Adapter	Airline mechanical Co Ltd	EOSA+4B120-4000	AB1708240092570

3.2 Support Equipment and description

Description	Manufacturer	Model No./ Part No.
USB Wifi Adapter	TP-Link	Archer T2U
Laptop	HP	EliteBook 8470p
Laptop	HP	EliteBook 8470p

3.3 Justification

Preliminary testing was performed for all modulation/data rate modes. The following modes, in which the highest power was detected, were selected for final measurements:

- OFDM, 6MB/s – for 802.11a (Power Setting on test firmware: 15)
- OFDM, MCS0 – for 802.11n 20MHz (Power Setting on test firmware: 15)
- OFDM, MCS0 – for 802.11n 40MHz (Power Setting on test firmware: 16)
- OFDM, MCS0 – for 802.11ac 80MHz (Power Setting on test firmware: 15)

According to the manufacture, the FiberGateway utilizes cross-polarized antennas with two vertical (Ant 1 & Ant 4) and two Horizontal (Ant 2 & Ant 3). Per FCC KDB “662911 D01 Multiple Transmitter Output v02r01”, the directional gain of the antenna is calculated as below:

$$\text{Directional gain} = 10 \log[(10^{G1/10} + 10^{G2/10} + \dots + 10^{GN/10})/N_{\text{ANT}}] \text{ dBi}$$

$$\text{Vertical Gain} = 10 \log[(10^{(4.8/10)} + 10^{(5.1/10)})/2] = 4.9\text{dBi}$$

$$\text{Horizontal Gain} = 10 \log[(10^{(3.4/10)} + 10^{(4/10)})/2] = 3.7\text{dBi}$$

According to the manufacture, only 1 receive chain from the vertical and horizontal antenna port has DFS detection capabilities. The lowest receive antenna gain is 3.4dBi in the horizontal polarity. Therefore, DFS detection threshold is based on the gain of 3.4dBi.

3.4 Mode of Operation During Test

During transmitter testing, the transmitter was setup to transmit continuously using the maximum RF power setting. Their corresponding output power in dBm can be found in section 4.2 of this report.

3.5 Modifications required for Compliance

No other modifications were made during compliance testing in order to bring the product into compliance

3.6 Additions, deviations and exclusions from standards

No additions, deviations or exclusion have been made from standard.

4.0 Dynamic Frequency Selection (DFS)

4.1 Requirement

Applicability of DFS Requirements Prior to Use of a Channel

Requirement	Operational Mode		
	Master	Client Without Radar Detection	Client With Radar Detection
<i>Non-Occupancy Period</i>	Yes	Not Required	Yes
<i>DFS Detection Threshold</i>	Yes	Not Required	Yes
<i>Channel Availability Check Time</i>	Yes	Not Required	Not Required
<i>U-NII Detection Bandwidth</i>	Yes	Not Required	Yes

Applicability of DFS requirements during normal operation

Requirement	Operational Mode	
	Master Device or Client with Radar Detection	Client With Radar Detection
<i>DFS Detection Threshold</i>	Yes	Not Required
<i>Channel Closing Transmission Time</i>	Yes	Yes
<i>Channel Move Time</i>	Yes	Yes
<i>U-NII Detection Bandwidth</i>	Yes	Not Required

Additional requirements for devices with multiple bandwidth modes	Master Device or Client with Radar Detection	Client Without Radar Detection
<i>U-NII Detection Bandwidth and Statistical Performance Check</i>	All BW modes must be tested	Not required
<i>Channel Move Time and Channel Closing Transmission Time</i>	Test using widest BW mode available	Test using the widest BW mode available for the link
<i>All other tests</i>	Any single BW mode	Not required

Note: Frequencies selected for statistical performance check should include several frequencies within the radar detection bandwidth and frequencies near the edge of the radar detection bandwidth. For 802.11 devices it is suggested to select frequencies in each of the bonded 20 MHz channels and the channel center frequency.

4.1.1 DFS Detection Thresholds for Master or Client Devices with DFS Detection

Maximum Transmit Power	Values (See Notes 1, 2, and 3)
<i>EIRP ≥ 200 milliwatt</i>	-64 dBm
<i>EIRP < 200 milliwatt and power spectral density < 10 dBm/MHz</i>	-62 dBm
<i>EIRP < 200 milliwatt that do not meet the power spectral density requirement</i>	-64 dBm
<p>Note 1: This is the level at the input of the receiver assuming a 0 dBi receive antenna.</p> <p>Note 2: Throughout these test procedures an additional 1 dB has been added to the amplitude of the test transmission waveforms to account for variations in measurement equipment. This will ensure that the test signal is at or above the detection threshold level to trigger a DFS response.</p> <p>Note3: EIRP is based on the highest antenna gain. For MIMO devices refer to KDB Publication 662911 D01</p>	

Parameter	Value
<i>Non-Occupancy Period</i>	Minimum 30 minutes
<i>Channel Availability Check Time</i>	60 Seconds
<i>Channel Move Time</i>	10 seconds (see note 1)
<i>Channel Closing Transmission Time</i>	200 ms + an aggregate of 60 ms over remaining 10 Second period. (see note 1 and 2)
<i>U-NII Detection Bandwidth</i>	Minimum 100% of the U-NII 99% transmission power bandwidth. (see note 3)
<p>Note 1: <i>Channel Move Time</i> and the <i>Channel Closing Transmission Time</i> should be performed with Radar Type 0. The measurement timing begins at the end of the Radar Type 0 burst.</p> <p>Note 2: The <i>Channel Closing Transmission Time</i> is comprised of 200 milliseconds starting at the beginning of the <i>Channel Move Time</i> plus any additional intermittent control signals required to facilitate a <i>Channel</i> move (an aggregate of 60 milliseconds) during the remainder of the 10 second period. The aggregate duration of control signals will not count quiet periods in between transmissions.</p> <p>Note 3: During the <i>U-NII Detection Bandwidth</i> detection test, radar type 0 should be used. For each frequency step the minimum percentage of detection is 90 percent. Measurements are performed with no data traffic.</p>	

4.1.2 Test Waveform

Radar Type	Pulse Width (µsec)	PRI (µsec)	Number of Pulses	Minimum Percentage of Successful Detection	Minimum Number of Trials
0	1	1428	18	See Note 1	See Note 1
1	1	Test A: 15 unique PRI values randomly selected from the list of 23 PRI values in Table 5a	$\text{Roundup} \left\{ \left(\frac{1}{360} \cdot \left(\frac{19 \cdot 10^6}{\text{PRI}_{\mu\text{sec}}} \right) \right) \right\}$	60.00%	30
		Test B: 15 unique PRI values randomly selected within the range of 518-3066 µsec, with a minimum increment of 1 µsec, excluding PRI values selected in Test A			
2	1-5	150-230	23-29	60%	30
3	6-10	200-500	16-18	60%	30
4	11-20	200-500	12-16	60%	30
Aggregate (Radar Types 1-4)				80%	120
Note 1: Short Pulse Radar Type 0 should be used for the detection bandwidth test, channel move time, and channel closing time tests.					

A minimum of 30 unique waveforms are required for each of the Short Pulse Radar Types 2 through 4. If more than 30 waveforms are used for Short Pulse Radar Types 2 through 4, then each additional waveform must also be unique and not repeated from the previous waveforms. If more than 30 waveforms are used for Short Pulse Radar Type 1, then each additional waveform is generated with Test B and must also be unique and not repeated from the previous waveforms in Tests A or B.

Pulse Repetition Intervals Values for Test A

Pulse Repetition Frequency Number	Pulse Repetition Frequency (Pulses Per Second)	Pulse Repetition Interval (Microseconds)
1	1930.5	518
2	1858.7	538
3	1792.1	558
4	1730.1	578
5	1672.2	598
6	1618.1	618
7	1567.4	638
8	1519.8	658
9	1474.9	678
10	1432.7	698
11	1392.8	718
12	1355.0	738
13	1319.3	758
14	1285.3	778
15	1253.1	798
16	1222.5	818
17	1193.3	838
18	1165.6	858
19	1139.0	878
20	1113.6	898
21	1089.3	918
22	1066.1	938
23	326.2	3066

The aggregate is the average of the percentage of successful detections of Short Pulse Radar Types 1-4. For example, the following table indicates how to compute the aggregate of percentage of successful detections.

Radar Type	Number of Trials	Number of Successful Detections	Minimum Percentage of Successful Detection
1	35	29	82.9%
2	30	18	60.0%
3	30	27	90.0%
4	50	44	88.0%
Aggregate $(82.9\% + 60\% + 90\% + 88\%)/4 = 80.2\%$			

Long Pulse Radar Test Waveform

Radar Type	Pulse Width (µsec)	Chirp Width (MHz)	PRI (µsec)	Number of Pulses per Burst	Number of Burst	Minimum Percentage of Successful Detection	Minimum Number of Trials
5	50-100	5-20	1000-2000	1-3	8-20	80%	30

The parameters for this waveform are randomly chosen. Thirty unique waveforms are required for the Long Pulse radar test signal. If more than 30 waveforms are used for the Long Pulse radar test signal, then each additional waveform must also be unique and not repeated from the previous waveforms.

1. The transmission period for the Long Pulse Radar test signal is 12 seconds.
2. There are a total of 8 to 20 *Bursts* in the 12 second period, with the number of *Bursts* being randomly chosen. This number is *Burst Count*.
3. Each *Burst* consists of 1 to 3 pulses, with the number of pulses being randomly chosen. Each *Burst* within the 12 second sequence may have a different number of pulses.
4. The pulse width is between 50 and 100 microseconds, with the pulse width being randomly chosen. Each pulse within a *Burst* will have the same pulse width. Pulses in different *Bursts* may have different pulse widths.
5. Each pulse has a linear frequency modulated chirp between 5 and 20 MHz, with the chirp width being randomly chosen. Each pulse within a *transmission period* will have the same chirp width. The chirp is centered on the pulse. For example, with a radar frequency of 5300 MHz and a 20 MHz chirped signal, the chirp starts at 5290 MHz and ends at 5310 MHz.
6. If more than one pulse is present in a *Burst*, the time between the pulses will be between 1000 and 2000 microseconds, with the time being randomly chosen. If three pulses are present in a *Burst*, the random time interval between the first and second pulses is chosen independently of the random time interval between the second and third pulses.
7. The 12 second transmission period is divided into even intervals. The number of intervals is equal to *Burst Count*. Each interval is of length $(12,000,000 / \textit{Burst Count})$ microseconds. Each interval contains one *Burst*. The start time for the *Burst*, relative to the beginning of the interval, is between 1 and $[(12,000,000 / \textit{Burst Count}) - (\textit{Total Burst Length}) + (\textit{One Random PRI Interval})]$ microseconds, with the start time being randomly chosen. The step interval for the start time is 1 microsecond. The start time for each *Burst* is chosen randomly.

A representative example of a Long Pulse Radar Type waveform:

- 1) The total test waveform length is 12 seconds.
- 2) Eight (8) *Bursts* are randomly generated for the *Burst Count*.
- 3) *Burst 1* has 2 randomly generated pulses.
- 4) The pulse width (for both pulses) is randomly selected to be 75 microseconds.
- 5) The PRI is randomly selected to be at 1213 microseconds.
- 6) *Bursts 2* through 8 are generated using steps 3 – 5.
- 7) Each *Burst* is contained in even intervals of 1,500,000 microseconds. The starting location for Pulse 1, *Burst 1* is randomly generated (1 to 1,500,000 minus the total *Burst 1* length + 1 random PRI interval) at the 325,001 microsecond step. *Bursts 2* through 8 randomly fall in successive 1,500,000 microsecond intervals (i.e. *Burst 2* falls in the 1,500,001 – 3,000,000 microsecond range).

Long Pulse Radar Test Signal Waveform
12 Second Transmission

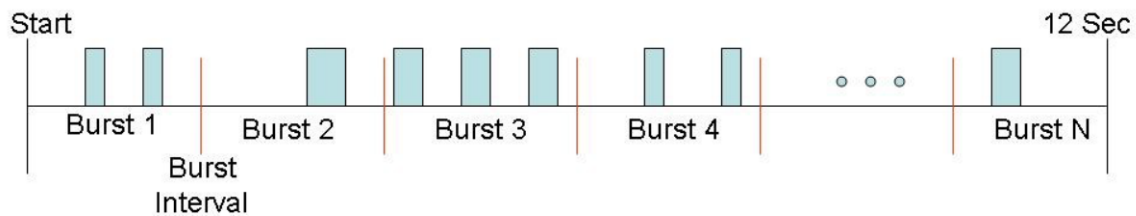

Graphical Representation of a Long Pulse Radar Type Waveform

Frequency Hopping Radar Test Waveform

Radar Type	Pulse Width (µsec)	PRI (µsec)	Pulses per Hop	Hopping Rate (kHz)	Hopping Sequence Length (msec)	Minimum Percentage of Successful Detection	Minimum Number of Trials
6	1	333	9	0.333	300	70%	30

For the Frequency Hopping Radar Type, the same *Burst* parameters are used for each waveform. The hopping sequence is different for each waveform and a 100-length segment is selected from the hopping sequence defined by the following algorithm:

The first frequency in a hopping sequence is selected randomly from the group of 475 integer frequencies from 5250 – 5724 MHz. Next, the frequency that was just chosen is removed from the group and a frequency is randomly selected from the remaining 474 frequencies in the group. This process continues until all 475 frequencies are chosen for the set. For selection of a random frequency, the frequencies remaining within the group are always treated as equally likely.

4.2 DFS Waveform Calibration

4.2.1 Calibration Procedure

The radar calibration was setup as pictured below. Each FCC radar (types 0-6) were generated from the a signal generator and measured using a spectrum analyzer. The spectrum analyzer’s resolution bandwidth was set to 3 MHz and the video bandwidth was set to 3 MHz with peak detection. The span was set to zero span and the timing was adjusted to capture the wave form. The DFS signal was calibrated to a field strength of -60.6 dBm (represented by red line in plots) to account for the 3.4 dBi Antenna used in the EUT. Plots for the radar calibration is presented in section 4.3.2.

DFS Detection Threshold	Antenna Gain	Target Calibration
dBm	dBi	dBm
-64	3.4	-60.6

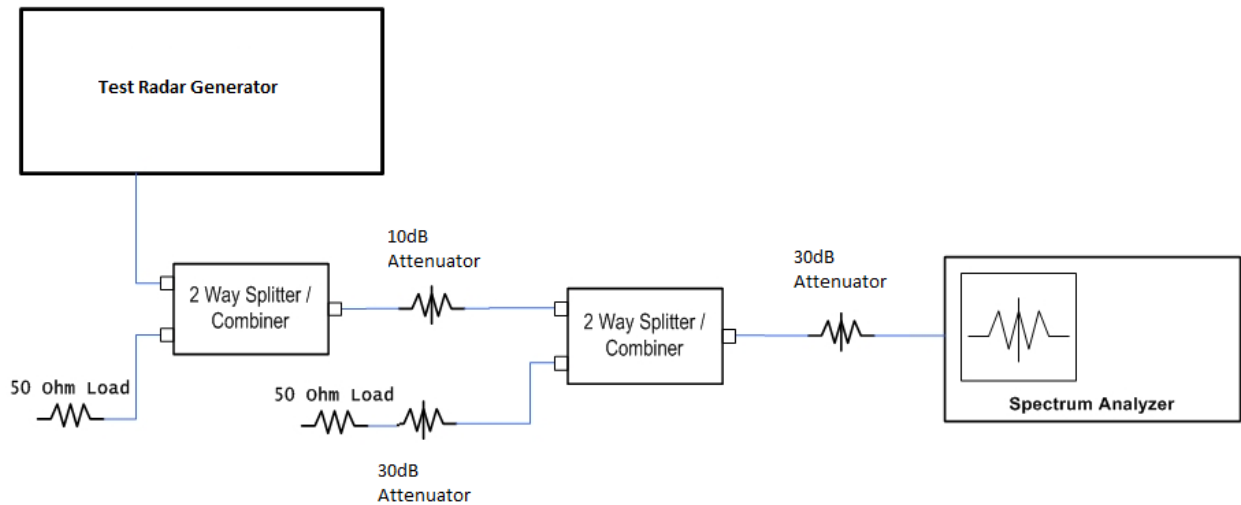

Tested By:	Anderson Soungpanya
Test Date:	November 28, 2017 and December 13, 2017

4.2.2 Calibration Results

Radar Type 0 Calibration

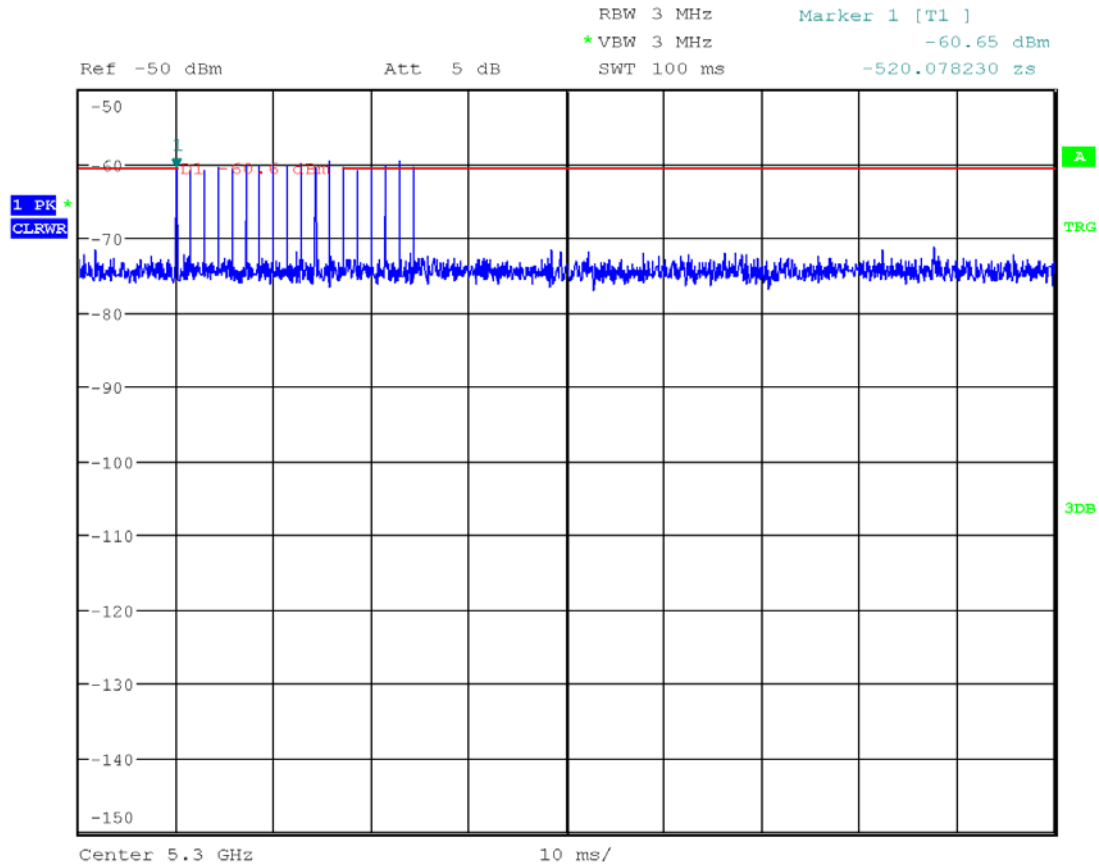

Date: 28.NOV.2017 07:15:06

Radar Type 1A Calibration

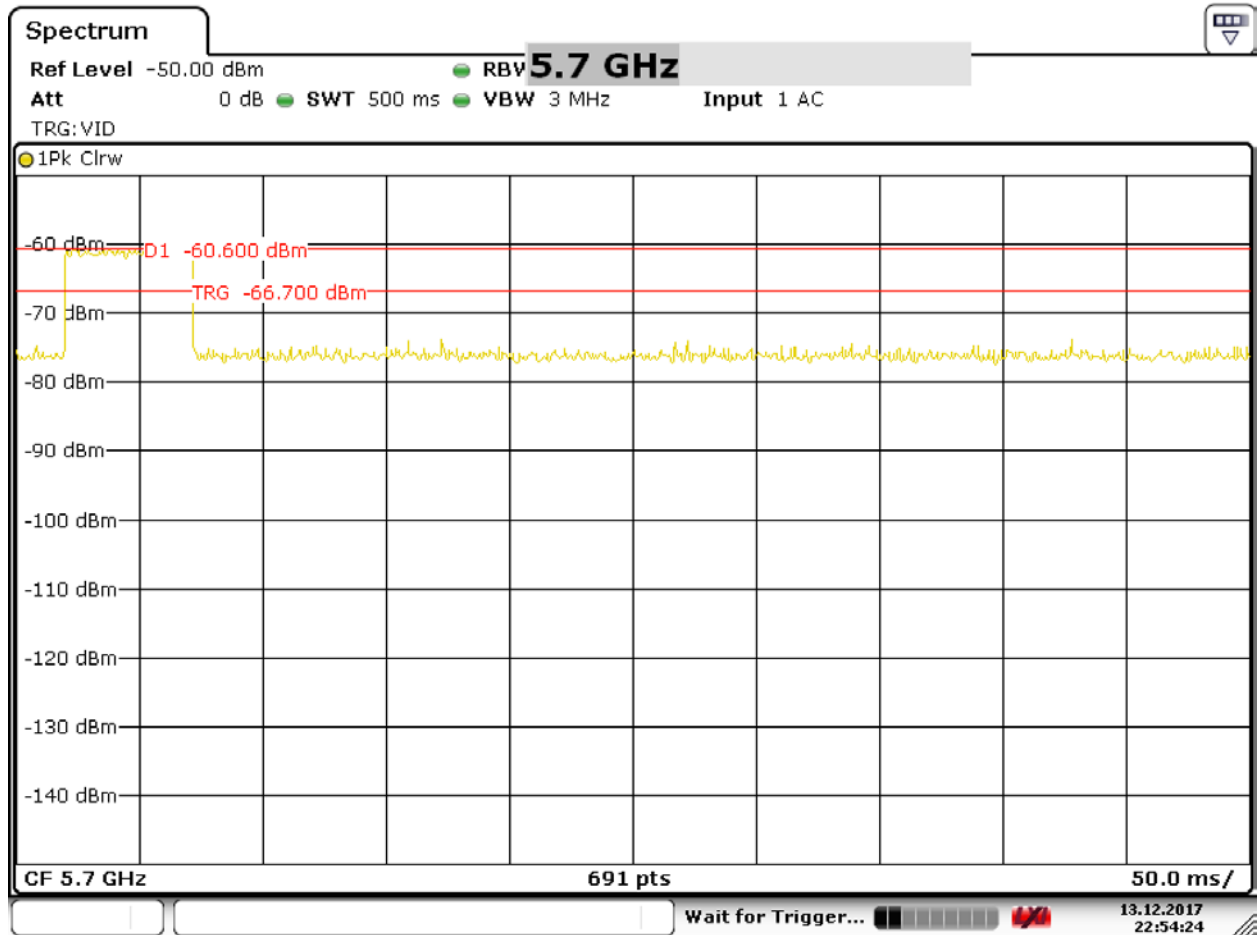

Date: 13.DEC.2017 22:54:24

Radar Type 1B Calibration

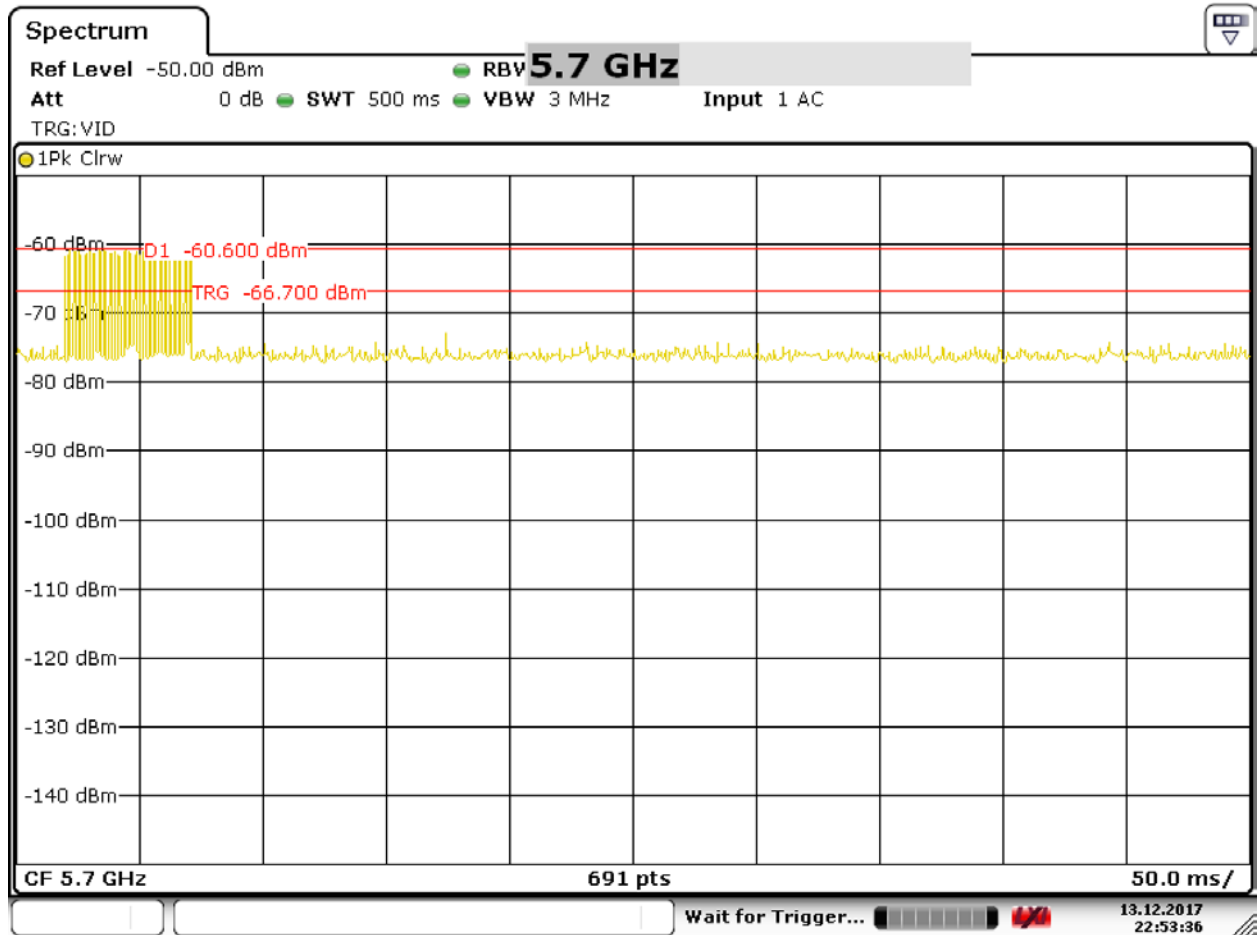

Date: 13.DEC.2017 22:53:35

Radar Type 2 Calibration

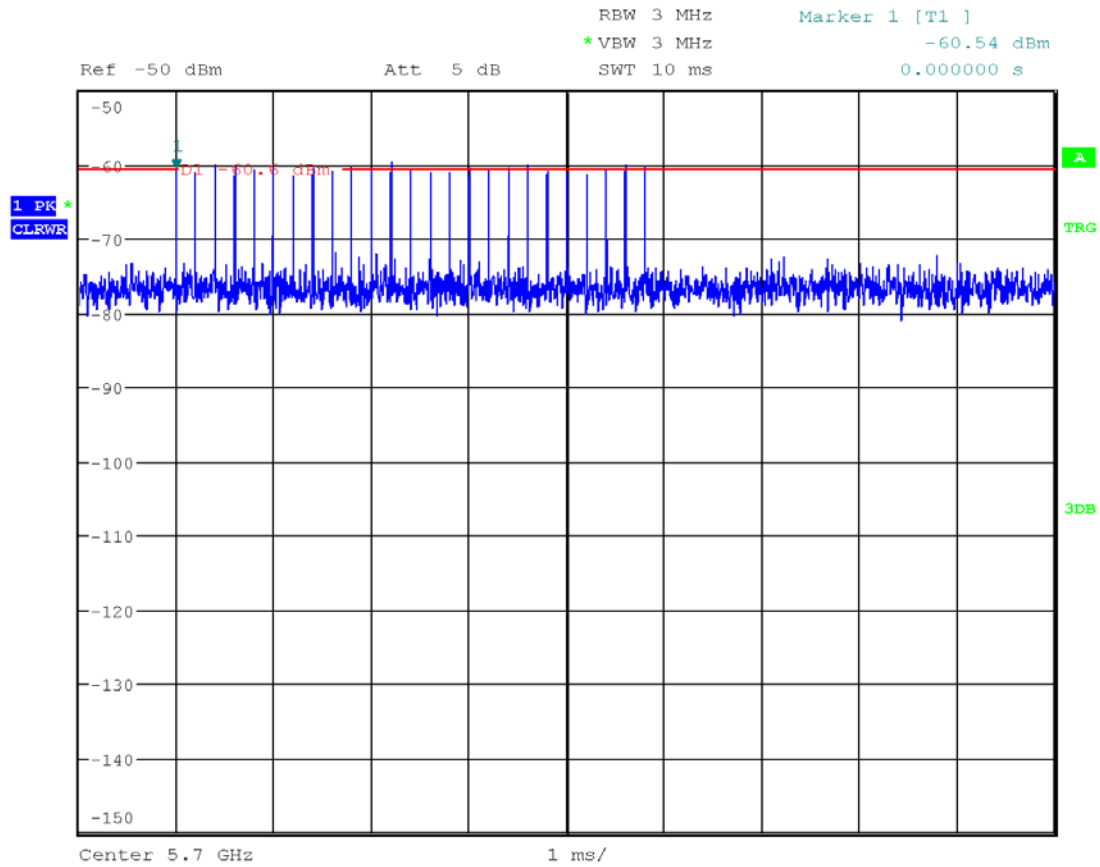

Date: 28.NOV.2017 07:20:29

Radar Type 3 Calibration

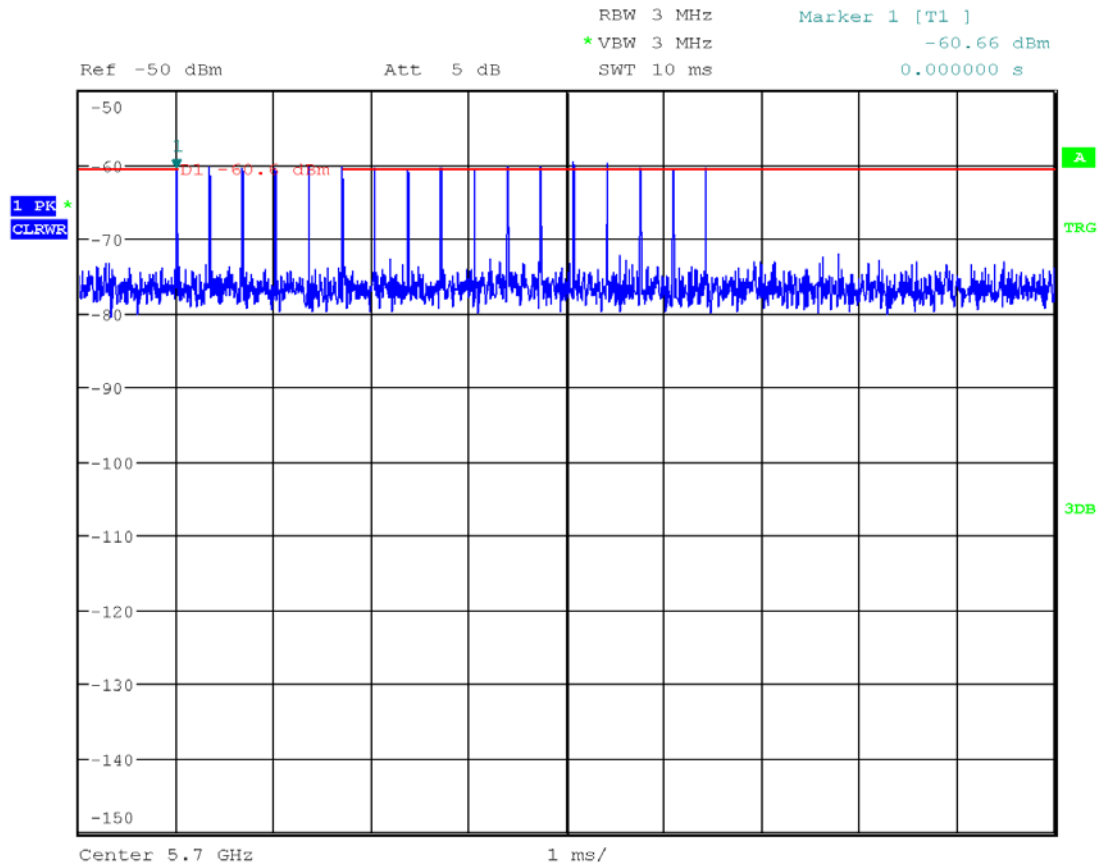

Date: 28.NOV.2017 07:21:59

Radar Type 4 Calibration

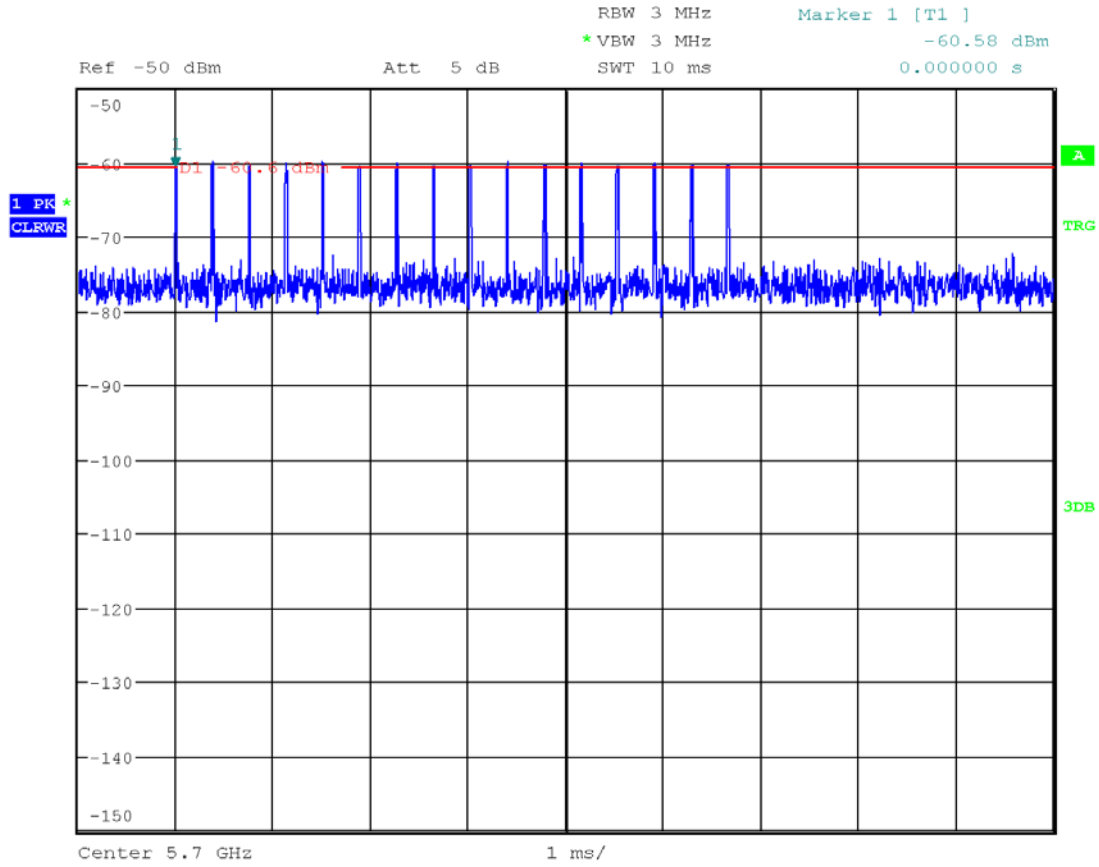

Date: 28.NOV.2017 07:23:02

Radars Type 5 Calibration

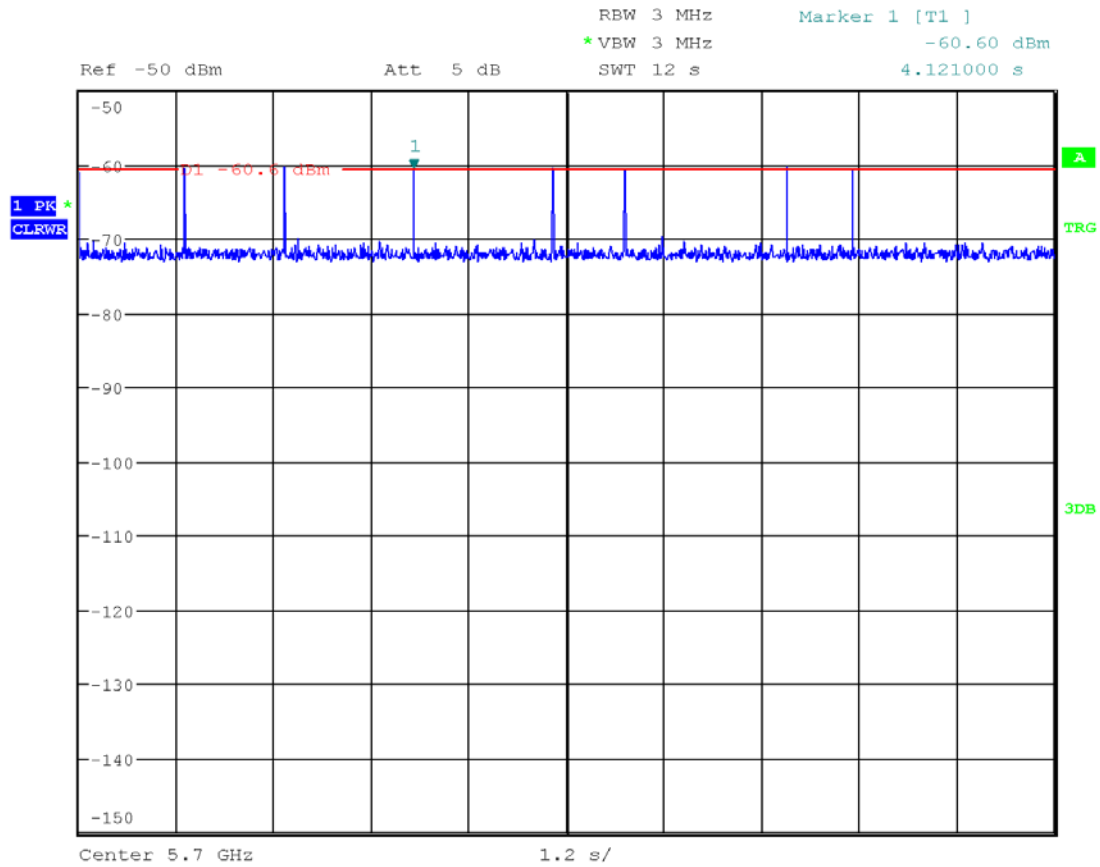

Date: 28.NOV.2017 07:35:29

Radar Type 6 Calibration

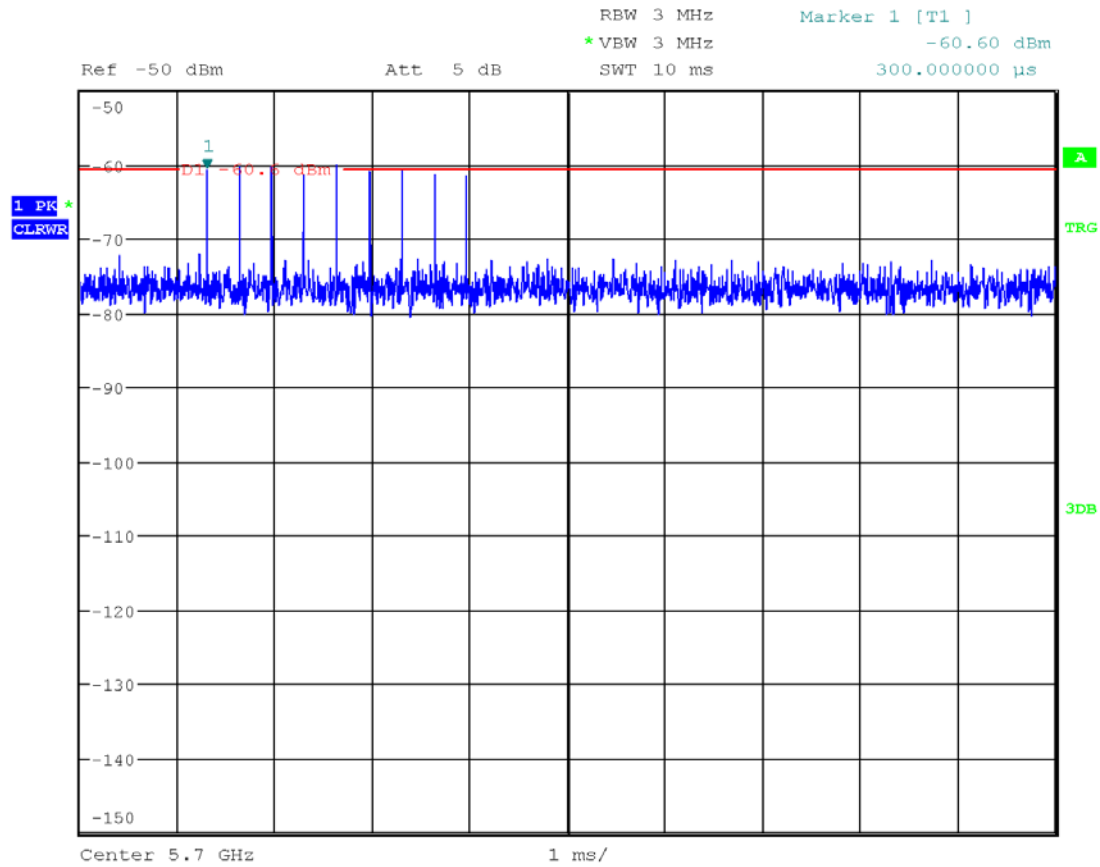

Date: 28.NOV.2017 07:32:36

4.3 DFS Test Procedures

Test procedures were made in accordance to 905462 D02 UNII DFS Compliance Procedures New Rules v02.

A conducted test method was used, and the test setup was made as depicted in the diagram below. DFS testing was setup as a master with injection into the master.

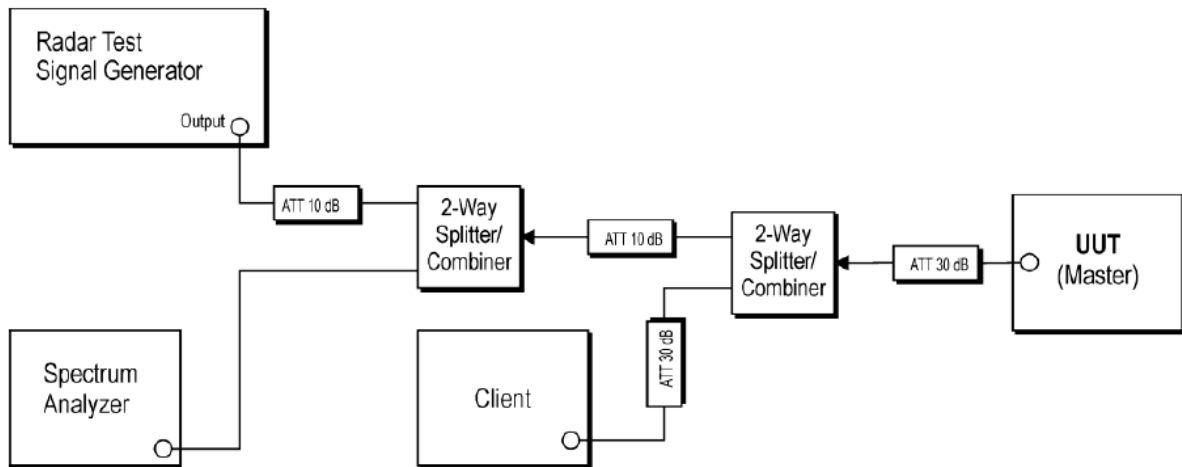

4.4 U-NII Detection Bandwidth

4.4.1 Test Procedure

The equipment is setup for conducted test. The generating equipment is setup to produce a single burst of the Short Pulse Radar Type 0 at the center frequency of the UUT Operating Channel. The test level is set to the DFS Detection Threshold. The EUT is setup as a standalone device (no associated Client) and with no traffic.

A single radar Burst is sent to the EUT and the response of the EUT is noted. This is repeated for a minimum of 10 trials.

Radar test frequency selected is started at the center frequency of the EUT operating Channel. The center channel of the radar frequency is increased and decreased in 5 MHz steps until the detection rate falls below the U-NII Detection Bandwidth criterion. When rate falls below the U-NII Detection Bandwidth criterion the radar frequency is increased and decreased in 1MHz steps. The highest (f_H) and lowest (f_L) frequency at which detection is greater than or equal to the U-NII Detection Bandwidth criterion is recorded.

The U-NII Detection Bandwidth is calculated as follows: $U\text{-NII Detection Bandwidth} = f_H - f_L$

The U-NII Detection Bandwidth must meet the U-NII Detection Bandwidth criterion which is 100% of the EUT 99% Bandwidth. Otherwise, the UUT does not comply with DFS requirements.

4.4.2 Test Results

EUT Frequency- 5300MHz 20MHz BW (802.11a)											
DFS Detection Trials (1=Detection, 0= No Detection)											
Radar Frequency (MHz)	1	2	3	4	5	6	7	8	9	10	Detection Rate (%)
5315	0	0	0	0	0	0	0	0	0	0	0
5311	0	0	0	0	0	0	0	0	0	0	0
5310 _{PH}	1	1	1	1	1	1	1	1	1	1	100
5305	1	1	1	1	1	1	1	1	1	1	100
5300	1	1	1	1	1	1	1	1	1	1	100
5295	1	1	1	1	1	1	1	1	1	1	100
5290 _{PL}	1	1	1	1	1	1	1	1	1	1	100
5289	0	0	0	0	0	0	0	0	0	0	0
5285	0	0	0	0	0	0	0	0	0	0	0
Overall Detection Percentage											100.00
Detection Bandwidth = $f_H - f_L = 5310\text{MHz} - 5290\text{MHz} = 20\text{MHz}$											
EUT 99% Bandwidth = 17.2MHz											

4.4.2 U-NII Detection Bandwidth (Continued)

EUT Frequency- 5300MHz 20MHz BW (802.11n)											
DFS Detection Trials (1=Detection, 0= No Detection)											
Radar Frequency (MHz)	1	2	3	4	5	6	7	8	9	10	Detection Rate (%)
5315	0	0	0	0	0	0	0	0	0	0	0
5311	0	0	0	0	0	0	0	0	0	0	0
5310 _{TH}	1	1	1	1	1	1	1	1	1	1	100
5305	1	1	1	1	1	1	1	1	1	1	100
5300	1	1	1	1	1	1	1	1	1	1	100
5295	1	1	1	1	1	1	1	1	1	1	100
5290 _{FL}	1	1	1	1	1	1	1	1	1	1	100
5289	0	0	0	0	0	0	0	0	0	0	0
5285	0	0	0	0	0	0	0	0	0	0	0
Overall Detection Percentage											100.00
Detection Bandwidth = $f_H - f_L = 5310\text{MHz} - 5290\text{MHz} = 20\text{MHz}$											
EUT 99% Bandwidth = 18.4MHz											

4.4.2 U-NII Detection Bandwidth (Continued)

EUT Frequency- 5310MHz 40MHz BW (802.11n)											
DFS Detection Trials (1=Detection, 0= No Detection)											
Radar Frequency (MHz)	1	2	3	4	5	6	7	8	9	10	Detection Rate (%)
5335	0	0	0	0	0	0	0	0	0	0	0
5331	0	0	0	0	0	0	0	0	0	0	0
5330 _{TH}	1	1	1	1	1	1	1	1	1	1	100
5325	1	1	1	1	1	1	1	1	1	1	100
5320	1	1	1	1	1	1	1	1	1	1	100
5315	1	1	1	1	1	1	1	1	1	1	100
5310	1	1	1	1	1	1	1	1	1	1	100
5305	1	1	1	1	1	1	1	1	1	1	100
5300	1	1	1	1	1	1	1	1	1	1	100
5295	1	1	1	1	1	1	1	1	1	1	100
5290 _{TL}	1	1	1	1	1	1	1	1	1	1	100
5289	0	0	0	0	0	0	0	0	0	0	0
5285	0	0	0	0	0	0	0	0	0	0	0
Overall Detection Percentage											100.00
Detection Bandwidth = $f_H - f_L = 5330\text{MHz} - 5290\text{MHz} = 40\text{MHz}$											
EUT 99% Bandwidth = 36.6MHz											

4.4.2 U-NII Detection Bandwidth (Continued)

EUT Frequency- 5290MHz 80MHz BW (802.11ac)											
DFS Detection Trials (1=Detection, 0= No Detection)											
Radar Frequency (MHz)	1	2	3	4	5	6	7	8	9	10	Detection Rate (%)
5330	0	0	0	0	0	0	0	0	0	0	0
5329 _{fH}	1	1	1	1	1	1	1	1	1	1	100
5328	1	0	1	1	1	1	1	1	1	1	90
5327	1	1	1	1	1	1	1	1	1	0	90
5326	1	1	1	1	1	1	1	1	1	1	100
5325	1	1	1	1	1	1	1	1	1	1	100
5320	1	1	1	1	1	1	1	1	1	1	100
5315	1	1	1	1	1	1	1	1	1	1	100
5310	1	1	1	1	1	1	1	1	1	1	100
5305	1	1	1	1	1	1	1	1	1	1	100
5300	1	1	1	1	1	1	1	1	1	1	100
5295	1	1	1	1	1	1	1	1	1	1	100
5290	1	1	1	1	1	1	1	1	1	1	100
5285	1	1	1	1	1	1	1	1	1	1	100
5280	1	1	1	1	1	1	1	1	1	1	100
5275	1	1	1	1	1	1	1	1	1	1	100
5270	1	1	1	1	1	1	1	1	1	1	100
5265	1	1	1	1	1	1	1	1	1	1	100
5260	1	1	1	1	1	1	1	1	1	1	100
5255	1	1	1	1	1	0	1	1	1	1	90
5254	1	1	1	1	1	1	1	1	1	1	100
5253	0	1	1	1	1	1	1	1	1	1	90
5252	1	1	1	1	1	1	1	1	1	1	100
5251 _{fL}	1	1	1	1	1	1	1	1	1	1	100
5250	0	0	0	0	0	0	0	0	0	0	0
Overall Detection Percentage											98.26
Detection Bandwidth = $f_H - f_L = 5329\text{MHz} - 5251\text{MHz} = 78\text{MHz}$											
EUT 99% Bandwidth = 76.1MHz											

4.5 Initial Channel Availability Check Time

4.5.1 Test Procedure

The Initial Channel Availability Check Time (CACT) tests that the UUT does not emit beacon, control, or data signals on the test Channel until the power-up sequence has been completed and the U-NII device checks for Radar Waveforms for one minute on the test Channel. This test does not use any Radar Waveforms and only needs to be performed one time.

- a) The U-NII devices was powered on and instructed to operate on the appropriate U-NII Channel that incorporated DFS functions. At the same time the UUT is powered on, the spectrum analyzer was set to zero span mode with a 3 MHz RBW and 3 MHz VBW on the Channel occupied by the radar with a 2.5-minute sweep time. The spectrum analyzer's sweep was started at the same time power is applied to the U-NII device.
- b) The UUT should not transmit any beacon or data transmissions until at least 1 minute after the completion of the power-on cycle.
- c) Marker 1 shows the beginning of the power-on cycle. Marker 2 shows 60 seconds prior to the power-on cycle which is beginning of the CACT.
- d) The plot shall be confirmed for power-on cycle.

4.5.2 Test Results

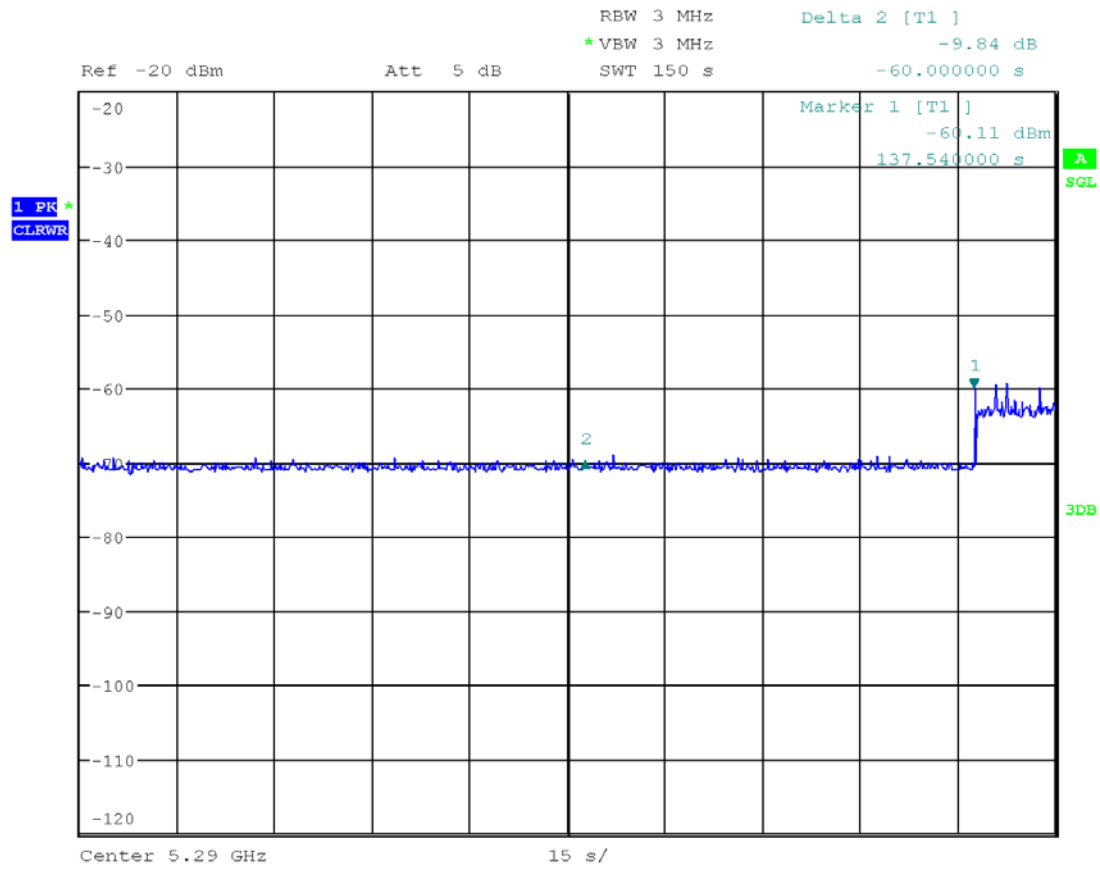

Date: 28.NOV.2017 09:53:10

4.6 Radar Burst at the Beginning of the Channel Availability Check Time

4.6.1 Test Procedure

The Initial Channel Availability Check Time (CACT) tests that the UUT does not emit beacon, control, or data signals on the test Channel until the power-up sequence has been completed and the U-NII device checks for Radar Waveforms for one minute on the test Channel. This test does not use any Radar Waveforms and only needs to be performed one time.

- a) The U-NII devices was powered on and instructed to operate on the appropriate U-NII Channel that incorporated DFS functions. At the same time the UUT is powered on, the spectrum analyzer was set to zero span mode with a 3 MHz RBW and 3 MHz VBW on the Channel occupied by the radar with a 2.5-minute sweep time. The spectrum analyzer's sweep was started at the same time power is applied to the U-NII device.
- b) The UUT should not transmit any beacon or data transmissions until at least 1 minute after the completion of the power-on cycle.
- c) A single type 0 Radar (threshold +1dB) was transmitted to the EUT at the beginning of the CACT time. Radar was sent within 2 seconds after marker 2 in plot below.
- d) The plot shall be confirmed for no transmission after Marker 1 (power-on cycle)

4.6.2 Test Results

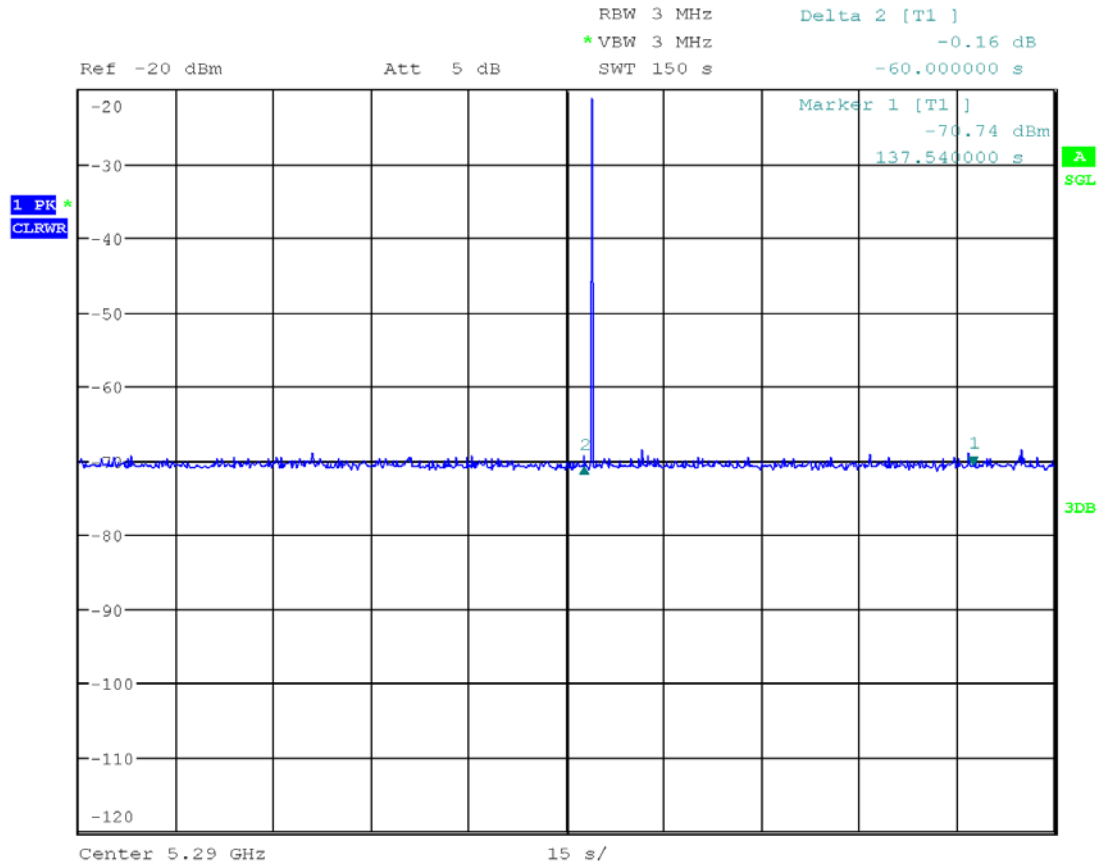

Date: 28.NOV.2017 10:05:23

4.7 Radar Burst at the End of the Channel Availability Check Time

4.7.1 Test Procedure

The Initial Channel Availability Check Time (CACT) tests that the UUT does not emit beacon, control, or data signals on the test Channel until the power-up sequence has been completed and the U-NII device checks for Radar Waveforms for one minute on the test Channel. This test does not use any Radar Waveforms and only needs to be performed one time.

- a) The U-NII devices was powered on and instructed to operate on the appropriate U-NII Channel that incorporated DFS functions. At the same time the UUT is powered on, the spectrum analyzer was set to zero span mode with a 3 MHz RBW and 3 MHz VBW on the Channel occupied by the radar with a 2.5-minute sweep time. The spectrum analyzer's sweep was started at the same time power is applied to the U-NII device.
- b) The UUT should not transmit any beacon or data transmissions until at least 1 minute after the completion of the power-on cycle.
- c) A single type 0 Radar (threshold +1dB) was transmitted to the EUT at the beginning of the CACT time. Radar was sent within 2 seconds prior to marker 1 in plot below.
- d) The plot shall be confirmed for no transmission after Marker 1 (power-on cycle)

4.7.2 Test Results

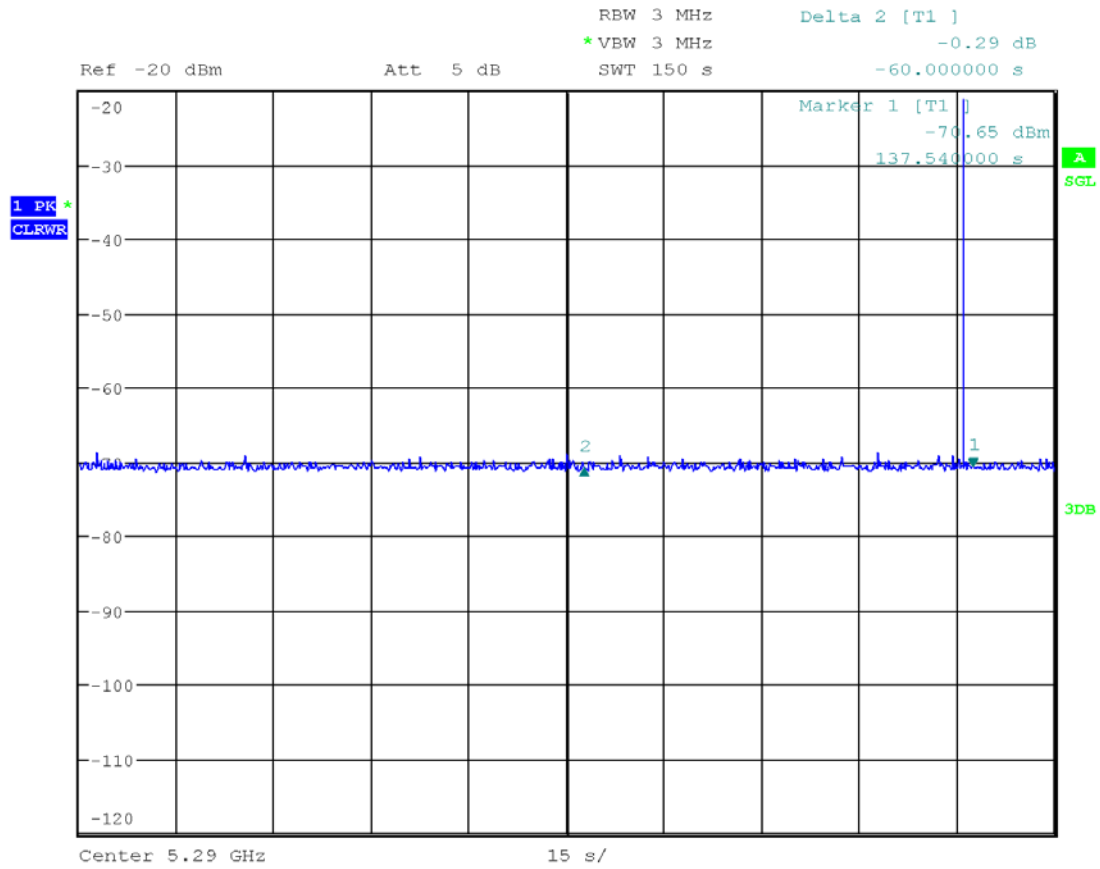

Date: 28.NOV.2017 10:16:47

4.8 In-Service Monitoring for Channel Move Time, Channel Closing Transmission Time and Non-Occupancy Period

4.8.1 Test Procedure

The EUT was configured to communicate with a client device. The MPEG test file was streamed from the Master (EUT) to the Client on the selected test channel. Measurements were made while utilizing the widest bandwidth of the EUT.

Channel closing transmission time and channel move time were measured by applying a radar type 0 at threshold + 1dB to the EUT. The EUT transmissions were observed on the DFS control frequency. The time between the end of the applied radar waveform and the final transmission on the channel is the channel move time. The channel closing transmission time comprises only those fragments of the channel move time during which the EUT transmits.

The Channel Move time shall be less than 10 seconds.

The Channel Close time shall be 200ms +60ms of aggregate time.

The Non-occupancy time shall 30 minutes or greater.

The Channel Loading shall be approximately 17% or greater.

4.8.1 Test Results Channel Move time

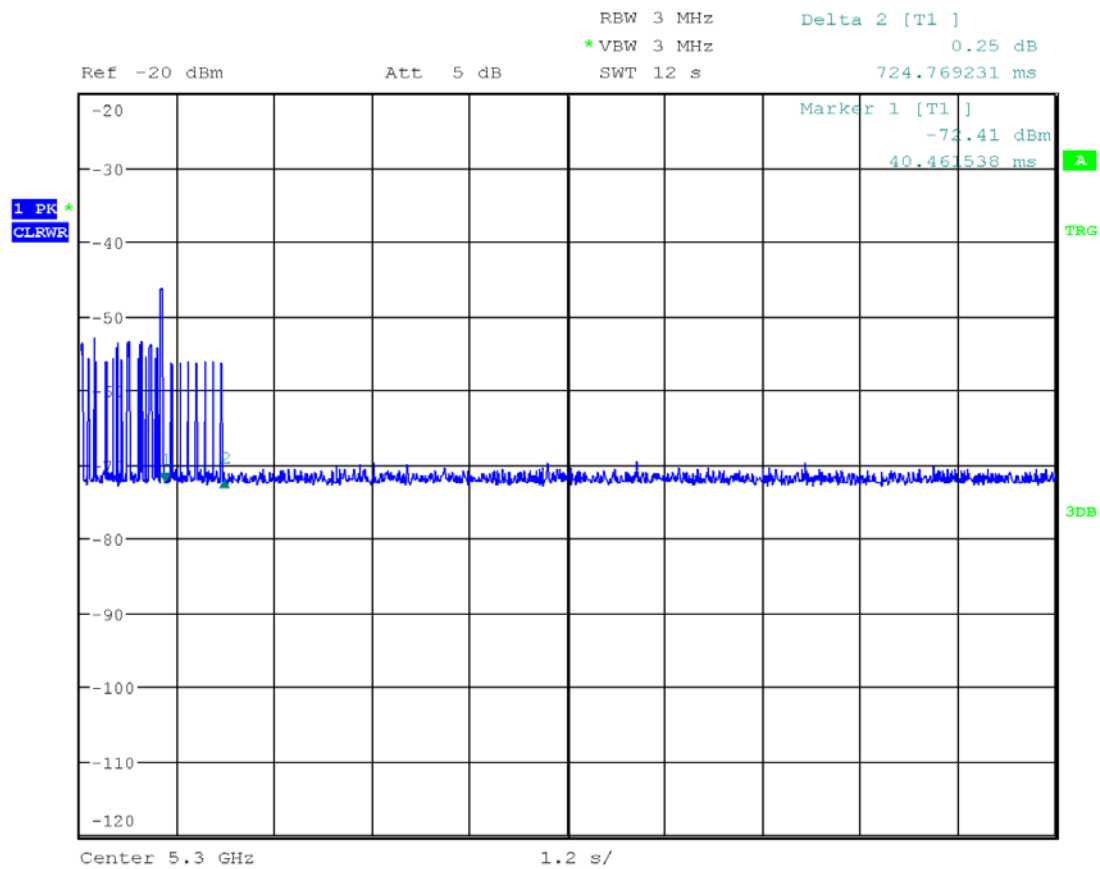

Date: 28.NOV.2017 10:52:11

Channel Move Time					
Frequency	Bandwidth	DFS Control Frequency	Measured Value	Limit Requirements	Results
5310 MHz	80 MHz	5300 MHz	724.78 ms	10 s	Pass

4.8.2 Test Results Channel Close Time

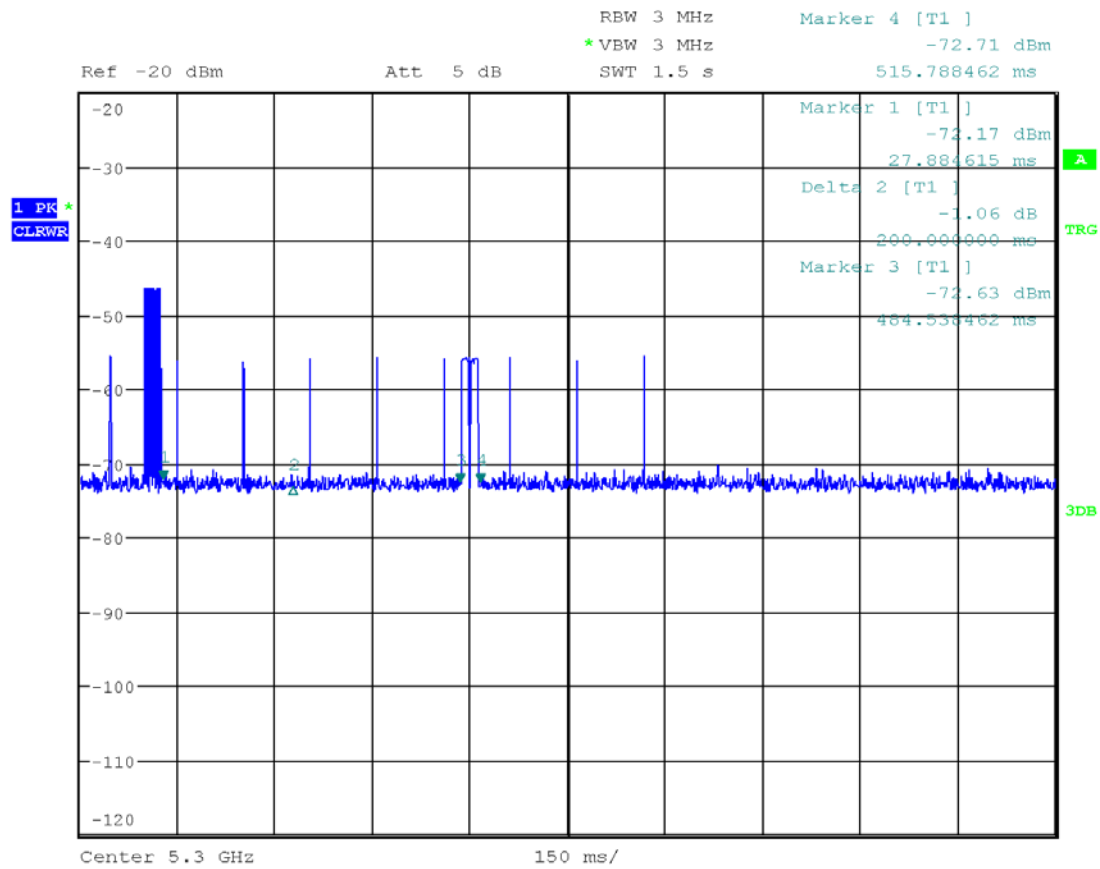

Date: 28.NOV.2017 11:45:08

4.8.2 Test Results Channel Close Time (Continued)

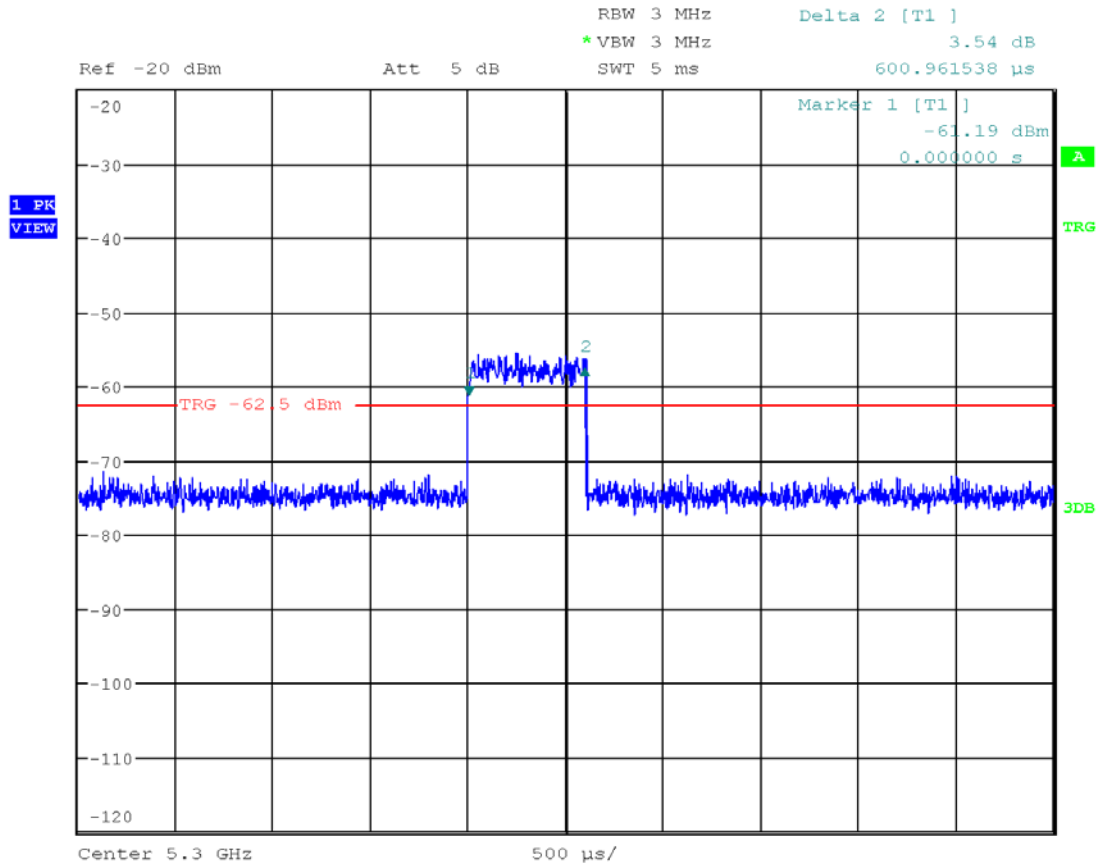

Date: 28.NOV.2017 11:15:33

Channel Move Time					
Frequency	Bandwidth	DFS Control Frequency	Measured Value	Limit Requirements	Results
5310 MHz	80 MHz	5300 MHz	<200 ms	200 ms	Pass
			Aggregate Measured Value after 200 ms	Limit Requirements	Results
			34.9 ms	60 ms	Pass

4.8.3 Test Results Non-Occupancy Period

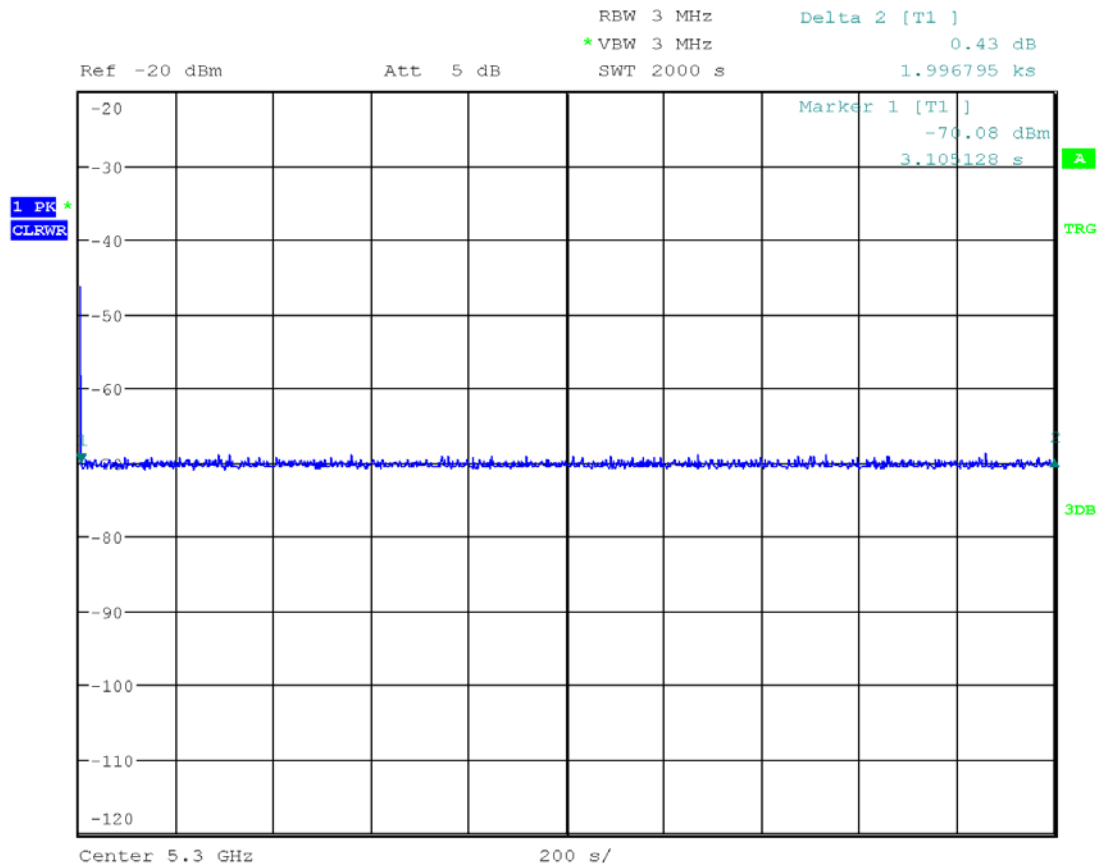

Date: 28.NOV.2017 12:27:28

Non-Occupancy Period					
Frequency	Bandwidth	DFS Control Frequency	Measured Value	Limit Requirements	Results
5310 MHz	80 MHz	5300 MHz	> 30min	30min	Pass

4.8.4 Test Results Channel Loading

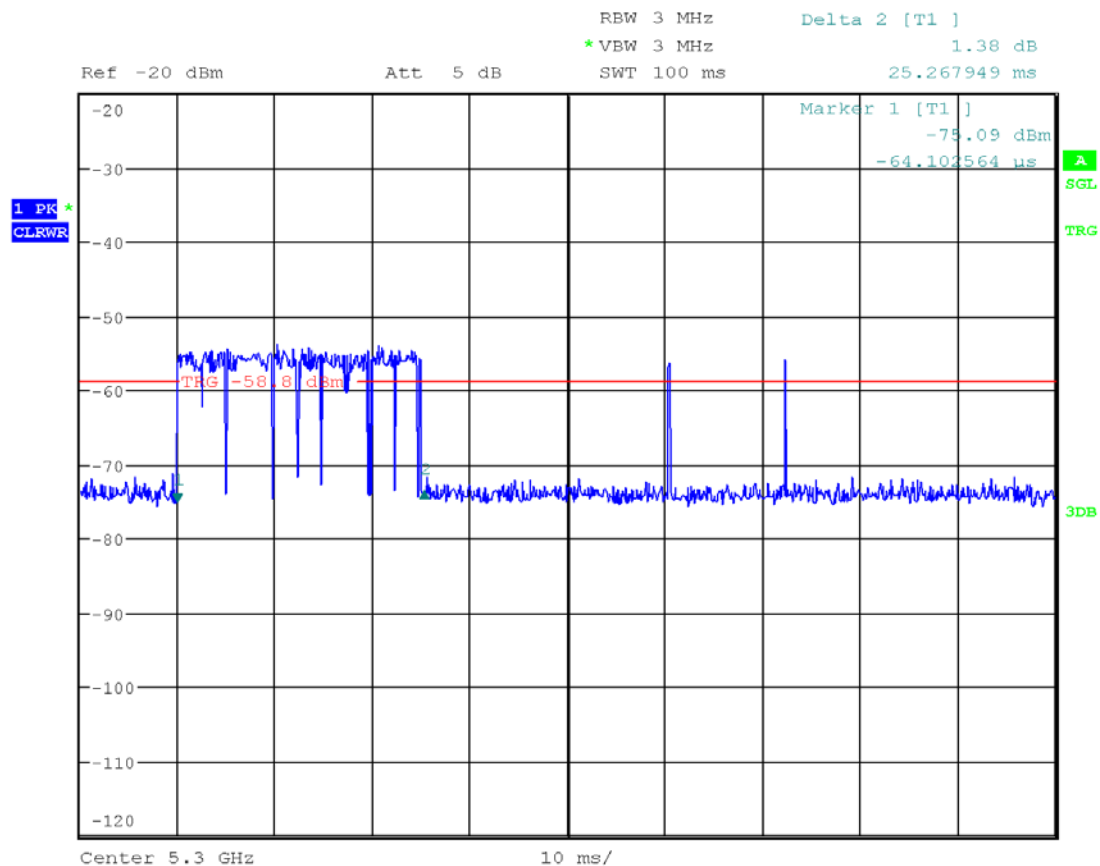

Date: 28.NOV.2017 10:47:57

Channel Loading					
Frequency	Bandwidth	DFS Control Frequency	Measured Value	Requirements	Results
5310 MHz	80 MHz	5300 MHz	27%	>17 %	Pass

4.9 Statistical Performance Check

4.9.1 Test Procedure

The EUT was configured to communicate with a client device. The MPEG test file was streamed from the Master (EUT) to the Client on the selected test channel. Channel move was disabled. Measurements were made while utilizing all the bandwidths of the EUT.

Short Pulse Radar Test

Once the performance requirements check is complete, statistical data was gathered, to determine the ability of the device to detect the radar test waveforms (Short Pulse Radar Types 1-4). The percentage of successful detection is calculated. In addition, an aggregate minimum percentage of successful detection across all Short Pulse Radar Types 1-4 is calculated.

Long Pulse Radar Test

Statistical data were gathered to determine the ability of the device to detect the Long Pulse Radar Type 5. Three subsets of trials were performed with a minimum of ten trials per subset. The subset of trials differ in where the Long Pulse Type 5 Signal is tuned in frequency:

For subset case 1: the center frequency of the signal generator will remain fixed at the center of the UUT Channel.

For subset case 2: to retain 90% frequency overlap between the radar signal and the UUT Occupied Bandwidth, the center frequency of the signal generator will vary for each of the ten trials in subset case 2. The center frequency of the signal generator for each trial is calculated by:
 $FL+(0.4*Ch\ irp\ Width\ [in\ MHz])$

For subset case 3: to retain 90% frequency overlap between the radar signal and the UUT Occupied Bandwidth, the center frequency of the signal generator will vary for each of the ten trials in subset case 3. The center frequency of the signal generator for each trial is calculated by:
 $FH-(0.4*Ch\ irp\ Width\ [in\ MHz])$

Frequency Hopping Radar Test

Statistical data will be gathered to determine the ability of the device to detect the Frequency Hopping radar test signal (radar type 6).

4.9.2 Test Results 802.11a at 5700MHz

Radar Type 1

Trial #	Number of Pulses per Burst	Pulse Width (µsec)	PRI (µs)	Detection (y/n)
1	76	1	698	y
2	63	1	838	y
3	78	1	678	y
4	86	1	618	y
5	83	1	638	n
6	65	1	818	y
7	62	1	858	y
8	89	1	598	n
9	102	1	518	y
10	92	1	578	y
11	98	1	538	y
12	81	1	658	y
13	57	1	938	y
14	58	1	918	n
15	70	1	758	y
16	47	1	1123	y
17	22	1	2396	y
18	49	1	1097	n
19	28	1	1918	y
20	32	1	1686	y
21	26	1	2036	y
22	19	1	2894	n
23	39	1	1365	y
24	52	1	1017	y
25	21	1	2571	y
26	24	1	2273	y
27	67	1	796	y
28	38	1	1393	y
29	20	1	2697	y
30	96	1	554	y
Total Detection Percentage				83.33 %

4.9.2 Test Results 802.11a at 5700MHz (Continued)

Radar Type 2

Trial #	Number of Pulses per Burst	Pulse Width (µsec)	PRI (µs)	Detection (y/n)
1	28	3.4	207	n
2	23	2.3	205	y
3	29	5.0	164	y
4	26	1.0	200	y
5	24	1.4	202	y
6	26	4.7	222	y
7	28	4.0	183	y
8	29	3.3	207	y
9	24	1.5	154	y
10	26	3.9	208	y
11	26	4.5	168	y
12	25	2.2	155	y
13	23	2.6	169	y
14	25	3.4	161	y
15	26	2.7	219	y
16	23	1.5	197	y
17	24	1.4	225	y
18	28	4.8	155	n
19	27	1.6	165	y
20	27	2.9	151	n
21	28	1.9	210	n
22	26	2.1	223	y
23	25	4.5	204	n
24	27	3.4	168	y
25	25	2.8	153	y
26	24	2.5	159	y
27	26	2.0	171	y
28	27	3.1	186	y
29	26	1.0	218	y
30	24	1.9	218	y
Total Detection Percentage				83.33 %

4.9.2 Test Results 802.11a at 5700MHz (Continued)

Radar Type 3

Trial #	Number of Pulses per Burst	Pulse Width (µsec)	PRI (µs)	Detection (y/n)
1	17	7.4	205	y
2	17	6.8	348	y
3	17	7.8	276	y
4	17	9.5	214	y
5	18	8.5	482	y
6	16	8.0	368	y
7	17	10	368	y
8	18	9.2	229	y
9	17	7.7	321	y
10	17	6.7	483	y
11	17	8.9	260	y
12	17	8.5	477	n
13	17	7.5	409	y
14	16	6.7	210	y
15	18	6.4	359	n
16	18	7.7	207	y
17	17	8.0	403	y
18	17	7.0	249	y
19	16	7.2	266	y
20	16	6.7	393	y
21	17	6.7	253	y
22	17	8.9	335	n
23	18	7.9	226	n
24	18	9.9	283	y
25	18	6.7	458	y
26	17	6.2	400	y
27	16	8.9	291	n
28	17	9.6	467	y
29	17	6.5	203	y
30	16	9.4	219	y
Total Detection Percentage				83.33 %

4.9.2 Test Results 802.11a at 5700MHz (Continued)

Radar Type 4

Trial #	Number of Pulses per Burst	Pulse Width (µsec)	PRI (µs)	Detection (y/n)
1	16	14.8	464	n
2	13	11.7	220	y
3	14	17.0	301	y
4	13	18.2	281	n
5	13	19.8	464	n
6	14	17.7	270	n
7	13	15.7	314	y
8	12	14.5	228	y
9	13	19.4	288	n
10	14	17.2	293	y
11	16	12.8	440	y
12	13	13.7	466	y
13	14	16.6	465	y
14	15	14.2	421	y
15	14	13.7	252	n
16	15	15.6	250	y
17	14	19.7	469	y
18	14	18.0	304	y
19	16	16.9	245	n
20	14	14.0	498	y
21	14	14.2	461	y
22	13	18.6	405	y
23	16	13.3	299	y
24	14	17.4	414	y
25	13	18.9	395	y
26	15	18.2	283	y
27	14	19.7	287	y
28	14	16.2	375	y
29	15	11.8	253	y
30	13	14.1	274	y
Total Detection Percentage				76.67 %

802.11a Aggregated Detection 1-4

Type 1	Type 2	Type 3	Type 4	Aggregate	Limit	Results
83.33%	83.33%	83.33%	76.67%	81.67%	>80%	Pass

4.9.2 Test Results 802.11a at 5700MHz (Continued)

Radar Type 5

Trial #	Radar Type	Waveform #	Detection (y/n)
1	FCC Radar Type 5	Waveform #1	n
2	FCC Radar Type 5	Waveform #2	y
3	FCC Radar Type 5	Waveform #3	y
4	FCC Radar Type 5	Waveform #4	y
5	FCC Radar Type 5	Waveform #5	y
6	FCC Radar Type 5	Waveform #6	y
7	FCC Radar Type 5	Waveform #7	y
8	FCC Radar Type 5	Waveform #8	y
9	FCC Radar Type 5	Waveform #9	y
10	FCC Radar Type 5	Waveform #10	y
11	FCC Radar Type 5	Waveform #11	y
12	FCC Radar Type 5	Waveform #12	y
13	FCC Radar Type 5	Waveform #13	y
14	FCC Radar Type 5	Waveform #14	n
15	FCC Radar Type 5	Waveform #15	y
16	FCC Radar Type 5	Waveform #16	y
17	FCC Radar Type 5	Waveform #17	y
18	FCC Radar Type 5	Waveform #18	y
19	FCC Radar Type 5	Waveform #19	y
20	FCC Radar Type 5	Waveform #20	y
21	FCC Radar Type 5	Waveform #21	y
22	FCC Radar Type 5	Waveform #22	y
23	FCC Radar Type 5	Waveform #23	n
24	FCC Radar Type 5	Waveform #24	y
25	FCC Radar Type 5	Waveform #25	y
26	FCC Radar Type 5	Waveform #26	y
27	FCC Radar Type 5	Waveform #27	y
28	FCC Radar Type 5	Waveform #28	n
29	FCC Radar Type 5	Waveform #29	y
30	FCC Radar Type 5	Waveform #30	y
Total Detection Percentage			86.67 %

4.9.2 Test Results 802.11a at 5700MHz (Continued)

Radar Type 6

Trial #	Radar Type	Waveform #	Detection (y/n)
1	FCC Radar Type 6	Sequencing List #1	n
2	FCC Radar Type 6	Sequencing List #2	y
3	FCC Radar Type 6	Sequencing List #3	y
4	FCC Radar Type 6	Sequencing List #4	y
5	FCC Radar Type 6	Sequencing List #5	y
6	FCC Radar Type 6	Sequencing List #6	y
7	FCC Radar Type 6	Sequencing List #7	y
8	FCC Radar Type 6	Sequencing List #8	y
9	FCC Radar Type 6	Sequencing List #9	y
10	FCC Radar Type 6	Sequencing List #10	y
11	FCC Radar Type 6	Sequencing List #11	y
12	FCC Radar Type 6	Sequencing List #12	y
13	FCC Radar Type 6	Sequencing List #13	y
14	FCC Radar Type 6	Sequencing List #14	y
15	FCC Radar Type 6	Sequencing List #15	y
16	FCC Radar Type 6	Sequencing List #16	y
17	FCC Radar Type 6	Sequencing List #17	y
18	FCC Radar Type 6	Sequencing List #18	y
19	FCC Radar Type 6	Sequencing List #19	y
20	FCC Radar Type 6	Sequencing List #20	y
21	FCC Radar Type 6	Sequencing List #21	y
22	FCC Radar Type 6	Sequencing List #22	y
23	FCC Radar Type 6	Sequencing List #23	y
24	FCC Radar Type 6	Sequencing List #24	y
25	FCC Radar Type 6	Sequencing List #25	n
26	FCC Radar Type 6	Sequencing List #26	y
27	FCC Radar Type 6	Sequencing List #27	y
28	FCC Radar Type 6	Sequencing List #28	n
29	FCC Radar Type 6	Sequencing List #29	n
30	FCC Radar Type 6	Sequencing List #30	n
Total Detection Percentage			83.33 %

4.9.3 Test Results 802.11n 20MHz at 5700MHz

Radar Type 1

Trial #	Number of Pulses per Burst	Pulse Width (µsec)	PRI (µs)	Detection (y/n)
1	76	1	698	n
2	63	1	838	y
3	78	1	678	y
4	86	1	618	y
5	83	1	638	y
6	65	1	818	n
7	62	1	858	y
8	89	1	598	y
9	102	1	518	y
10	92	1	578	y
11	98	1	538	y
12	81	1	658	y
13	57	1	938	y
14	58	1	918	y
15	70	1	758	y
16	47	1	1123	y
17	22	1	2396	n
18	49	1	1097	y
19	28	1	1918	y
20	32	1	1686	y
21	26	1	2036	y
22	19	1	2894	y
23	39	1	1365	y
24	52	1	1017	y
25	21	1	2571	y
26	24	1	2273	y
27	67	1	796	y
28	38	1	1393	y
29	20	1	2697	y
30	96	1	554	y
Total Detection Percentage				93.33 %

4.9.3 Test Results 802.11n 20MHz at 5700MHz (Continued)

Radar Type 2

Trial #	Number of Pulses per Burst	Pulse Width (µsec)	PRI (µs)	Detection (y/n)
1	28	3.4	207	y
2	23	2.3	205	y
3	29	5.0	164	y
4	26	1.0	200	y
5	24	1.4	202	y
6	26	4.7	222	y
7	28	4.0	183	y
8	29	3.3	207	y
9	24	1.5	154	n
10	26	3.9	208	y
11	26	4.5	168	y
12	25	2.2	155	y
13	23	2.6	169	y
14	25	3.4	161	y
15	26	2.7	219	y
16	23	1.5	197	y
17	24	1.4	225	y
18	28	4.8	155	y
19	27	1.6	165	y
20	27	2.9	151	y
21	28	1.9	210	y
22	26	2.1	223	y
23	25	4.5	204	y
24	27	3.4	168	y
25	25	2.8	153	n
26	24	2.5	159	y
27	26	2.0	171	y
28	27	3.1	186	y
29	26	1.0	218	y
30	24	1.9	218	y
Total Detection Percentage				93.33 %

4.9.3 Test Results 802.11n 20MHz at 5700MHz (Continued)

Radar Type 3

Trial #	Number of Pulses per Burst	Pulse Width (µsec)	PRI (µs)	Detection (y/n)
1	17	7.4	205	y
2	17	6.8	348	y
3	17	7.8	276	y
4	17	9.5	214	y
5	18	8.5	482	y
6	16	8.0	368	y
7	17	10	368	y
8	18	9.2	229	y
9	17	7.7	321	y
10	17	6.7	483	y
11	17	8.9	260	y
12	17	8.5	477	y
13	17	7.5	409	n
14	16	6.7	210	n
15	18	6.4	359	y
16	18	7.7	207	y
17	17	8.0	403	y
18	17	7.0	249	y
19	16	7.2	266	y
20	16	6.7	393	y
21	17	6.7	253	n
22	17	8.9	335	y
23	18	7.9	226	y
24	18	9.9	283	y
25	18	6.7	458	y
26	17	6.2	400	y
27	16	8.9	291	y
28	17	9.6	467	y
29	17	6.5	203	y
30	16	9.4	219	y
Total Detection Percentage				90.00 %

4.9.3 Test Results 802.11n 20MHz at 5700MHz (Continued)

Radar Type 4

Trial #	Number of Pulses per Burst	Pulse Width (µsec)	PRI (µs)	Detection (y/n)
1	16	14.8	464	n
2	13	11.7	220	y
3	14	17.0	301	y
4	13	18.2	281	n
5	13	19.8	464	y
6	14	17.7	270	y
7	13	15.7	314	y
8	12	14.5	228	y
9	13	19.4	288	y
10	14	17.2	293	y
11	16	12.8	440	y
12	13	13.7	466	n
13	14	16.6	465	y
14	15	14.2	421	y
15	14	13.7	252	y
16	15	15.6	250	n
17	14	19.7	469	y
18	14	18.0	304	y
19	16	16.9	245	n
20	14	14.0	498	y
21	14	14.2	461	y
22	13	18.6	405	y
23	16	13.3	299	y
24	14	17.4	414	y
25	13	18.9	395	y
26	15	18.2	283	y
27	14	19.7	287	y
28	14	16.2	375	y
29	15	11.8	253	y
30	13	14.1	274	y
Total Detection Percentage				83.33 %

802.11n 20MHz Aggregated Detection 1-4

Type 1	Type 2	Type 3	Type 4	Aggregate	Limit	Results
93.33%	93.33%	90.00%	83.33%	90.00%	>80%	Pass

4.9.3 Test Results 802.11n 20MHz at 5700MHz (Continued)

Radar Type 5

Trial #	Radar Type	Waveform #	Detection (y/n)
1	FCC Radar Type 5	Waveform #1	n
2	FCC Radar Type 5	Waveform #2	y
3	FCC Radar Type 5	Waveform #3	y
4	FCC Radar Type 5	Waveform #4	y
5	FCC Radar Type 5	Waveform #5	y
6	FCC Radar Type 5	Waveform #6	y
7	FCC Radar Type 5	Waveform #7	n
8	FCC Radar Type 5	Waveform #8	y
9	FCC Radar Type 5	Waveform #9	y
10	FCC Radar Type 5	Waveform #10	y
11	FCC Radar Type 5	Waveform #11	y
12	FCC Radar Type 5	Waveform #12	y
13	FCC Radar Type 5	Waveform #13	y
14	FCC Radar Type 5	Waveform #14	y
15	FCC Radar Type 5	Waveform #15	n
16	FCC Radar Type 5	Waveform #16	y
17	FCC Radar Type 5	Waveform #17	n
18	FCC Radar Type 5	Waveform #18	n
19	FCC Radar Type 5	Waveform #19	y
20	FCC Radar Type 5	Waveform #20	y
21	FCC Radar Type 5	Waveform #21	n
22	FCC Radar Type 5	Waveform #22	y
23	FCC Radar Type 5	Waveform #23	y
24	FCC Radar Type 5	Waveform #24	y
25	FCC Radar Type 5	Waveform #25	y
26	FCC Radar Type 5	Waveform #26	y
27	FCC Radar Type 5	Waveform #27	y
28	FCC Radar Type 5	Waveform #28	y
29	FCC Radar Type 5	Waveform #29	y
30	FCC Radar Type 5	Waveform #30	y
Total Detection Percentage			83.33 %

4.9.3 Test Results 802.11n 20MHz at 5700MHz (Continued)

Radar Type 6

Trial #	Radar Type	Waveform #	Detection (y/n)
1	FCC Radar Type 6	Sequencing List #1	y
2	FCC Radar Type 6	Sequencing List #2	y
3	FCC Radar Type 6	Sequencing List #3	y
4	FCC Radar Type 6	Sequencing List #4	y
5	FCC Radar Type 6	Sequencing List #5	y
6	FCC Radar Type 6	Sequencing List #6	y
7	FCC Radar Type 6	Sequencing List #7	y
8	FCC Radar Type 6	Sequencing List #8	y
9	FCC Radar Type 6	Sequencing List #9	y
10	FCC Radar Type 6	Sequencing List #10	y
11	FCC Radar Type 6	Sequencing List #11	y
12	FCC Radar Type 6	Sequencing List #12	y
13	FCC Radar Type 6	Sequencing List #13	y
14	FCC Radar Type 6	Sequencing List #14	n
15	FCC Radar Type 6	Sequencing List #15	y
16	FCC Radar Type 6	Sequencing List #16	y
17	FCC Radar Type 6	Sequencing List #17	y
18	FCC Radar Type 6	Sequencing List #18	y
19	FCC Radar Type 6	Sequencing List #19	y
20	FCC Radar Type 6	Sequencing List #20	y
21	FCC Radar Type 6	Sequencing List #21	y
22	FCC Radar Type 6	Sequencing List #22	y
23	FCC Radar Type 6	Sequencing List #23	y
24	FCC Radar Type 6	Sequencing List #24	y
25	FCC Radar Type 6	Sequencing List #25	y
26	FCC Radar Type 6	Sequencing List #26	y
27	FCC Radar Type 6	Sequencing List #27	y
28	FCC Radar Type 6	Sequencing List #28	n
29	FCC Radar Type 6	Sequencing List #29	y
30	FCC Radar Type 6	Sequencing List #30	n
Total Detection Percentage			90.00 %

4.9.4 Test Results 802.11n 40MHz at 5670MHz

Radar Type 1

Trial #	Number of Pulses per Burst	Pulse Width (µsec)	PRI (µs)	Detection (y/n)
1	76	1	698	y
2	63	1	838	y
3	78	1	678	y
4	86	1	618	y
5	83	1	638	y
6	65	1	818	y
7	62	1	858	y
8	89	1	598	y
9	102	1	518	y
10	92	1	578	y
11	98	1	538	y
12	81	1	658	y
13	57	1	938	y
14	58	1	918	y
15	70	1	758	y
16	47	1	1123	y
17	22	1	2396	y
18	49	1	1097	y
19	28	1	1918	y
20	32	1	1686	y
21	26	1	2036	y
22	19	1	2894	n
23	39	1	1365	y
24	52	1	1017	y
25	21	1	2571	y
26	24	1	2273	y
27	67	1	796	y
28	38	1	1393	y
29	20	1	2697	y
30	96	1	554	y
Total Detection Percentage				96.67 %

4.9.4 Test Results 802.11n 40MHz at 5670MHz (Continued)

Radar Type 2

Trial #	Number of Pulses per Burst	Pulse Width (µsec)	PRI (µs)	Detection (y/n)
1	28	3.4	207	y
2	23	2.3	205	y
3	29	5.0	164	y
4	26	1.0	200	y
5	24	1.4	202	y
6	26	4.7	222	y
7	28	4.0	183	y
8	29	3.3	207	y
9	24	1.5	154	y
10	26	3.9	208	y
11	26	4.5	168	y
12	25	2.2	155	y
13	23	2.6	169	y
14	25	3.4	161	y
15	26	2.7	219	y
16	23	1.5	197	y
17	24	1.4	225	y
18	28	4.8	155	y
19	27	1.6	165	y
20	27	2.9	151	y
21	28	1.9	210	y
22	26	2.1	223	y
23	25	4.5	204	y
24	27	3.4	168	y
25	25	2.8	153	y
26	24	2.5	159	y
27	26	2.0	171	y
28	27	3.1	186	y
29	26	1.0	218	y
30	24	1.9	218	y
Total Detection Percentage				100.00 %

4.9.4 Test Results 802.11n 40MHz at 5670MHz (Continued)

Radar Type 3

Trial #	Number of Pulses per Burst	Pulse Width (µsec)	PRI (µs)	Detection (y/n)
1	17	7.4	205	y
2	17	6.8	348	y
3	17	7.8	276	y
4	17	9.5	214	y
5	18	8.5	482	y
6	16	8.0	368	y
7	17	10	368	y
8	18	9.2	229	y
9	17	7.7	321	y
10	17	6.7	483	y
11	17	8.9	260	y
12	17	8.5	477	y
13	17	7.5	409	y
14	16	6.7	210	y
15	18	6.4	359	y
16	18	7.7	207	y
17	17	8.0	403	y
18	17	7.0	249	y
19	16	7.2	266	y
20	16	6.7	393	y
21	17	6.7	253	y
22	17	8.9	335	y
23	18	7.9	226	y
24	18	9.9	283	y
25	18	6.7	458	y
26	17	6.2	400	y
27	16	8.9	291	y
28	17	9.6	467	y
29	17	6.5	203	y
30	16	9.4	219	y
Total Detection Percentage				100.00 %

4.9.4 Test Results 802.11n 40MHz at 5670MHz (Continued)

Radar Type 4

Trial #	Number of Pulses per Burst	Pulse Width (µsec)	PRI (µs)	Detection (y/n)
1	16	14.8	464	y
2	13	11.7	220	y
3	14	17.0	301	n
4	13	18.2	281	y
5	13	19.8	464	y
6	14	17.7	270	n
7	13	15.7	314	y
8	12	14.5	228	y
9	13	19.4	288	y
10	14	17.2	293	y
11	16	12.8	440	y
12	13	13.7	466	y
13	14	16.6	465	y
14	15	14.2	421	y
15	14	13.7	252	y
16	15	15.6	250	y
17	14	19.7	469	n
18	14	18.0	304	y
19	16	16.9	245	n
20	14	14.0	498	y
21	14	14.2	461	y
22	13	18.6	405	y
23	16	13.3	299	y
24	14	17.4	414	y
25	13	18.9	395	y
26	15	18.2	283	y
27	14	19.7	287	y
28	14	16.2	375	n
29	15	11.8	253	y
30	13	14.1	274	y
Total Detection Percentage				83.33 %

802.11n 40MHz Aggregated Detection 1-4

Type 1	Type 2	Type 3	Type 4	Aggregate	Limit	Results
96.67%	100%	100%	83.33%	95%	>80%	Pass

4.9.4 Test Results 802.11n 40MHz at 5670MHz (Continued)

Radar Type 5

Trial #	Radar Type	Waveform #	Detection (y/n)
1	FCC Radar Type 5	Waveform #1	y
2	FCC Radar Type 5	Waveform #2	y
3	FCC Radar Type 5	Waveform #3	y
4	FCC Radar Type 5	Waveform #4	y
5	FCC Radar Type 5	Waveform #5	y
6	FCC Radar Type 5	Waveform #6	y
7	FCC Radar Type 5	Waveform #7	y
8	FCC Radar Type 5	Waveform #8	n
9	FCC Radar Type 5	Waveform #9	n
10	FCC Radar Type 5	Waveform #10	y
11	FCC Radar Type 5	Waveform #11	y
12	FCC Radar Type 5	Waveform #12	y
13	FCC Radar Type 5	Waveform #13	y
14	FCC Radar Type 5	Waveform #14	y
15	FCC Radar Type 5	Waveform #15	y
16	FCC Radar Type 5	Waveform #16	y
17	FCC Radar Type 5	Waveform #17	y
18	FCC Radar Type 5	Waveform #18	n
19	FCC Radar Type 5	Waveform #19	y
20	FCC Radar Type 5	Waveform #20	y
21	FCC Radar Type 5	Waveform #21	n
22	FCC Radar Type 5	Waveform #22	y
23	FCC Radar Type 5	Waveform #23	y
24	FCC Radar Type 5	Waveform #24	y
25	FCC Radar Type 5	Waveform #25	y
26	FCC Radar Type 5	Waveform #26	y
27	FCC Radar Type 5	Waveform #27	y
28	FCC Radar Type 5	Waveform #28	y
29	FCC Radar Type 5	Waveform #29	y
30	FCC Radar Type 5	Waveform #30	y
Total Detection Percentage			86.67 %

4.9.4 Test Results 802.11n 40MHz at 5670MHz (Continued)

Radar Type 6

Trial #	Radar Type	Waveform #	Detection (y/n)
1	FCC Radar Type 6	Sequencing List #1	y
2	FCC Radar Type 6	Sequencing List #2	y
3	FCC Radar Type 6	Sequencing List #3	y
4	FCC Radar Type 6	Sequencing List #4	y
5	FCC Radar Type 6	Sequencing List #5	y
6	FCC Radar Type 6	Sequencing List #6	y
7	FCC Radar Type 6	Sequencing List #7	y
8	FCC Radar Type 6	Sequencing List #8	y
9	FCC Radar Type 6	Sequencing List #9	y
10	FCC Radar Type 6	Sequencing List #10	y
11	FCC Radar Type 6	Sequencing List #11	y
12	FCC Radar Type 6	Sequencing List #12	y
13	FCC Radar Type 6	Sequencing List #13	y
14	FCC Radar Type 6	Sequencing List #14	n
15	FCC Radar Type 6	Sequencing List #15	y
16	FCC Radar Type 6	Sequencing List #16	y
17	FCC Radar Type 6	Sequencing List #17	y
18	FCC Radar Type 6	Sequencing List #18	y
19	FCC Radar Type 6	Sequencing List #19	y
20	FCC Radar Type 6	Sequencing List #20	y
21	FCC Radar Type 6	Sequencing List #21	y
22	FCC Radar Type 6	Sequencing List #22	y
23	FCC Radar Type 6	Sequencing List #23	y
24	FCC Radar Type 6	Sequencing List #24	y
25	FCC Radar Type 6	Sequencing List #25	y
26	FCC Radar Type 6	Sequencing List #26	y
27	FCC Radar Type 6	Sequencing List #27	y
28	FCC Radar Type 6	Sequencing List #28	n
29	FCC Radar Type 6	Sequencing List #29	y
30	FCC Radar Type 6	Sequencing List #30	n
Total Detection Percentage			90.00%

4.9.5 Test Results 802.11ac 80MHz at 5530MHz

Radar Type 1

Trial #	Number of Pulses per Burst	Pulse Width (µsec)	PRI (µs)	Detection (y/n)
1	76	1	698	y
2	63	1	838	y
3	78	1	678	y
4	86	1	618	y
5	83	1	638	y
6	65	1	818	y
7	62	1	858	y
8	89	1	598	y
9	102	1	518	y
10	92	1	578	y
11	98	1	538	y
12	81	1	658	y
13	57	1	938	y
14	58	1	918	y
15	70	1	758	y
16	47	1	1123	y
17	22	1	2396	y
18	49	1	1097	y
19	28	1	1918	y
20	32	1	1686	n
21	26	1	2036	y
22	19	1	2894	y
23	39	1	1365	y
24	52	1	1017	y
25	21	1	2571	y
26	24	1	2273	n
27	67	1	796	y
28	38	1	1393	y
29	20	1	2697	y
30	96	1	554	y
Total Detection Percentage				93.33 %

4.9.5 Test Results 802.11ac 80MHz at 5530MHz (Continued)

Radar Type 2

Trial #	Number of Pulses per Burst	Pulse Width (µsec)	PRI (µs)	Detection (y/n)
1	28	3.4	207	y
2	23	2.3	205	y
3	29	5.0	164	y
4	26	1.0	200	y
5	24	1.4	202	y
6	26	4.7	222	y
7	28	4.0	183	y
8	29	3.3	207	y
9	24	1.5	154	y
10	26	3.9	208	y
11	26	4.5	168	y
12	25	2.2	155	y
13	23	2.6	169	y
14	25	3.4	161	y
15	26	2.7	219	y
16	23	1.5	197	y
17	24	1.4	225	y
18	28	4.8	155	y
19	27	1.6	165	y
20	27	2.9	151	n
21	28	1.9	210	y
22	26	2.1	223	y
23	25	4.5	204	y
24	27	3.4	168	y
25	25	2.8	153	y
26	24	2.5	159	y
27	26	2.0	171	y
28	27	3.1	186	y
29	26	1.0	218	y
30	24	1.9	218	y
Total Detection Percentage				96.67 %

4.9.5 Test Results 802.11ac 80MHz at 5530MHz (Continued)

Radar Type 3

Trial #	Number of Pulses per Burst	Pulse Width (µsec)	PRI (µs)	Detection (y/n)
1	17	7.4	205	n
2	17	6.8	348	y
3	17	7.8	276	y
4	17	9.5	214	y
5	18	8.5	482	y
6	16	8.0	368	y
7	17	10	368	y
8	18	9.2	229	y
9	17	7.7	321	y
10	17	6.7	483	y
11	17	8.9	260	y
12	17	8.5	477	y
13	17	7.5	409	y
14	16	6.7	210	y
15	18	6.4	359	y
16	18	7.7	207	y
17	17	8.0	403	y
18	17	7.0	249	y
19	16	7.2	266	y
20	16	6.7	393	y
21	17	6.7	253	y
22	17	8.9	335	y
23	18	7.9	226	y
24	18	9.9	283	y
25	18	6.7	458	y
26	17	6.2	400	y
27	16	8.9	291	y
28	17	9.6	467	y
29	17	6.5	203	y
30	16	9.4	219	n
Total Detection Percentage				93.33 %

4.9.5 Test Results 802.11ac 80MHz at 5530MHz (Continued)

Radar Type 4

Trial #	Number of Pulses per Burst	Pulse Width (µsec)	PRI (µs)	Detection (y/n)
1	16	14.8	464	y
2	13	11.7	220	y
3	14	17.0	301	y
4	13	18.2	281	y
5	13	19.8	464	y
6	14	17.7	270	y
7	13	15.7	314	y
8	12	14.5	228	y
9	13	19.4	288	y
10	14	17.2	293	n
11	16	12.8	440	n
12	13	13.7	466	y
13	14	16.6	465	y
14	15	14.2	421	y
15	14	13.7	252	y
16	15	15.6	250	y
17	14	19.7	469	y
18	14	18.0	304	n
19	16	16.9	245	y
20	14	14.0	498	y
21	14	14.2	461	y
22	13	18.6	405	y
23	16	13.3	299	y
24	14	17.4	414	n
25	13	18.9	395	y
26	15	18.2	283	y
27	14	19.7	287	n
28	14	16.2	375	y
29	15	11.8	253	y
30	13	14.1	274	y
Total Detection Percentage				83.33 %

802.11n 80MHz Aggregated Detection 1-4

Type 1	Type 2	Type 3	Type 4	Aggregate	Limit	Results
93.33%	96.67%	93.33%	83.33%	91.67%	>80%	Pass

4.9.5 Test Results 802.11ac 80MHz at 5530MHz (Continued)

Radar Type 5

Trial #	Radar Type	Waveform #	Detection (y/n)
1	FCC Radar Type 5	Waveform #1	y
2	FCC Radar Type 5	Waveform #2	y
3	FCC Radar Type 5	Waveform #3	y
4	FCC Radar Type 5	Waveform #4	y
5	FCC Radar Type 5	Waveform #5	y
6	FCC Radar Type 5	Waveform #6	y
7	FCC Radar Type 5	Waveform #7	y
8	FCC Radar Type 5	Waveform #8	y
9	FCC Radar Type 5	Waveform #9	y
10	FCC Radar Type 5	Waveform #10	y
11	FCC Radar Type 5	Waveform #11	y
12	FCC Radar Type 5	Waveform #12	y
13	FCC Radar Type 5	Waveform #13	y
14	FCC Radar Type 5	Waveform #14	n
15	FCC Radar Type 5	Waveform #15	y
16	FCC Radar Type 5	Waveform #16	y
17	FCC Radar Type 5	Waveform #17	y
18	FCC Radar Type 5	Waveform #18	y
19	FCC Radar Type 5	Waveform #19	y
20	FCC Radar Type 5	Waveform #20	y
21	FCC Radar Type 5	Waveform #21	n
22	FCC Radar Type 5	Waveform #22	y
23	FCC Radar Type 5	Waveform #23	n
24	FCC Radar Type 5	Waveform #24	y
25	FCC Radar Type 5	Waveform #25	y
26	FCC Radar Type 5	Waveform #26	y
27	FCC Radar Type 5	Waveform #27	y
28	FCC Radar Type 5	Waveform #28	n
29	FCC Radar Type 5	Waveform #29	y
30	FCC Radar Type 5	Waveform #30	y
Total Detection Percentage			86.67 %

4.9.5 Test Results 802.11ac 80MHz at 5530MHz (Continued)

Radar Type 6

Trial #	Radar Type	Waveform #	Detection (y/n)
1	FCC Radar Type 6	Sequencing List #1	y
2	FCC Radar Type 6	Sequencing List #2	y
3	FCC Radar Type 6	Sequencing List #3	y
4	FCC Radar Type 6	Sequencing List #4	y
5	FCC Radar Type 6	Sequencing List #5	y
6	FCC Radar Type 6	Sequencing List #6	y
7	FCC Radar Type 6	Sequencing List #7	y
8	FCC Radar Type 6	Sequencing List #8	y
9	FCC Radar Type 6	Sequencing List #9	y
10	FCC Radar Type 6	Sequencing List #10	y
11	FCC Radar Type 6	Sequencing List #11	y
12	FCC Radar Type 6	Sequencing List #12	y
13	FCC Radar Type 6	Sequencing List #13	y
14	FCC Radar Type 6	Sequencing List #14	y
15	FCC Radar Type 6	Sequencing List #15	y
16	FCC Radar Type 6	Sequencing List #16	y
17	FCC Radar Type 6	Sequencing List #17	y
18	FCC Radar Type 6	Sequencing List #18	y
19	FCC Radar Type 6	Sequencing List #19	y
20	FCC Radar Type 6	Sequencing List #20	y
21	FCC Radar Type 6	Sequencing List #21	y
22	FCC Radar Type 6	Sequencing List #22	y
23	FCC Radar Type 6	Sequencing List #23	y
24	FCC Radar Type 6	Sequencing List #24	y
25	FCC Radar Type 6	Sequencing List #25	y
26	FCC Radar Type 6	Sequencing List #26	y
27	FCC Radar Type 6	Sequencing List #27	y
28	FCC Radar Type 6	Sequencing List #28	y
29	FCC Radar Type 6	Sequencing List #29	y
30	FCC Radar Type 6	Sequencing List #30	n
Total Detection Percentage			96.67%

5.0 List of Test Equipment

Measurement equipment used for emission compliance testing utilized the equipment on the following list:

Equipment	Manufacturer	Model/Type	Asset #	Cal Int	Cal Due
Spectrum Analyzer	Rohde and Schwarz	FSU	00913	12	01/12/18
RF Cable	Megaphase	EMC1-K1K1-236	01538	12	06/13/18
RF Cable	Megaphase	TM40-K1K1-19	01154	12	01/26/18
RF Cable	Megaphase	TM40-K1K1-59 RF	01156	12	01/26/18
Signal Generator	Rohde and Schwarz	SMW 200A	102707	12	05/10/18
Combiner/Splitter	SM Electronics	MP0208-2	001195	VBU	VBU
Combiner/Splitter	SM Electronics	MP0208-2	001196	VBU	VBU
10dB Attenuator	Mini Circuit	BW-S10W5+	01582	12	08/31/18
10dB Attenuator	Narda	FSCM99899	01583	12	08/31/18
30dB Attenuator	Fairview	SA 18H-30	01632	VBU	VBU
30dB Attenuator	Fairview	SA 18H-30	01633	VBU	VBU

VBU-Verified before use

Software used for emission compliance testing utilized the following:

Name	Manufacturer	Version	Template/Profile
RS Commander	Rohde Schwarz	1.9.3, 1.16.2017	Not Applicable (Screen grabber)
Pulse Sequencer	Rohde Schwarz	1.5, 9.5.2017	FCC KDB 905462 D02

6.0 Document History

Revision/ Job Number	Writer Initials	Reviewer Initials	Date	Change
1.0 / G103224477	AS	KV	December 27, 2017	Original document

Appendix A - FCC Radar Type 5 Waveform

Waveform #1 Parameters

Burst	Number of Pulses	Pulse Width (μsec)	Chirp Width (MHz)	Pulse 1-to-2 Spacing (μsec)	Pulse 2-to-3 Spacing (μsec)	Start Location Within Interval (msec)
1	1	75.8	6			606
2	2	95.7	15	1504		112
3	3	86.1	7	1318	1646	131
4	2	68.3	6	1289		1060
5	2	91.2	12	1425		339
6	2	80.1	12	1595		711
7	1	62.9	18			657
8	2	66.9	20	1760		503
9						
10						
11						
12						
13						
14						
15						
16						
17						
18						
19						
20						

Waveform #2 Parameters

Burst	Number of Pulses	Pulse Width (µsec)	Chirp Width (MHz)	Pulse 1-to-2 Spacing (µsec)	Pulse 2-to-3 Spacing (µsec)	Start Location Within Interval (msec)
1	2	94.5	13	1699		935
2	3	95.7	13	1524	1092	1115
3	2	68.6	6	1803		299
4	2	77.3	13	1141		206
5	1	91.1	8			137
6	3	64	6	1602	1067	251
7	2	59.8	8	1118		534
8	2	98.7	11	947		572
9	3	74.6	18	1554	1133	345
10						
11						
12						
13						
14						
15						
16						
17						
18						
19						
20						

Waveform #3 Parameters

Burst	Number of Pulses	Pulse Width (µsec)	Chirp Width (MHz)	Pulse 1-to-2 Spacing (µsec)	Pulse 2-to-3 Spacing (µsec)	Start Location Within Interval (msec)
1	2	98.9	10	1287		24
2	1	54.7	18			1168
3	3	53.1	12	1605	1339	152
4	2	57.2	5	1009		48
5	2	92.6	9	1895		570
6	1	71.4	18			60
7	1	92	18			182
8	2	57.7	19	1004		827
9	3	86.3	9	1178	1135	887
10	2	54.6	8	1227		849
11						
12						
13						
14						
15						
16						
17						
18						
19						
20						

Waveform #4 Parameters

Burst	Number of Pulses	Pulse Width (µsec)	Chirp Width (MHz)	Pulse 1-to-2 Spacing (µsec)	Pulse 2-to-3 Spacing (µsec)	Start Location Within Interval (msec)
1	2	70.8	19	1553		352
2	3	75.6	13	1356	1194	986
3	1	87.2	17			577
4	2	64.6	11	1479		201
5	2	63.3	11	1563		612
6	3	66.2	12	1796	1024	819
7	2	72.6	13	1896		924
8	2	86.8	19	1042		847
9	2	98.2	7	1136		247
10	3	63.5	11	1381	1790	843
11	1	54.5	15			968
12						
13						
14						
15						
16						
17						
18						
19						
20						

Waveform #5 Parameters

Burst	Number of Pulses	Pulse Width (µsec)	Chirp Width (MHz)	Pulse 1-to-2 Spacing (µsec)	Pulse 2-to-3 Spacing (µsec)	Start Location Within Interval (msec)
1	3	58.8	13	1078	1413	116
2	1	70.9	10			468
3	2	62.2	9	1727		480
4	2	52.1	12	1682		362
5	2	66.4	13	1532		424
6	1	56.7	11			261
7	2	57.8	9	1484		200
8	3	73.5	9	974	1213	682
9	2	98.5	6	1230		250
10	2	50.8	19	1027		394
11	3	85.4	19	1005	1191	968
12	2	74.9	5	1218		987
13						
14						
15						
16						
17						
18						
19						
20						

Waveform #6 Parameters

Burst	Number of Pulses	Pulse Width (µsec)	Chirp Width (MHz)	Pulse 1-to-2 Spacing (µsec)	Pulse 2-to-3 Spacing (µsec)	Start Location Within Interval (msec)
1	2	81.4	18	1882		355
2	2	78	17	1117		774
3	1	99.2	19			322
4	2	51.4	15	1689		149
5	2	79.9	14	1093		844
6	2	71.3	7	1585		743
7	3	67.7	7	1020	1579	496
8	1	52.7	13			224
9	3	79.8	13	1484	1332	565
10	3	88.4	13	1012	1910	541
11	3	100	19	1623	902	669
12	1	61.3	7			320
13	2	56.7	19	1014		292
14						
15						
16						
17						
18						
19						
20						

Waveform #7 Parameters

Burst	Number of Pulses	Pulse Width (µsec)	Chirp Width (MHz)	Pulse 1-to-2 Spacing (µsec)	Pulse 2-to-3 Spacing (µsec)	Start Location Within Interval (msec)
1	2	81.2	18	1615		755
2	2	61.6	19	1216		99
3	1	77	20			98
4	2	67.2	8	1863		702
5	3	50.7	20	1129	1313	760
6	2	96.9	6	1320		517
7	1	57.4	6			556
8	2	74	11	1071		368
9	2	76.7	8	1481		522
10	3	90.5	9	1603	1621	829
11	2	66.9	20	1093		785
12	3	94.1	14	1721	956	0
13	3	95	10	1519	1711	590
14	3	88.4	10	959	1502	320
15						
16						
17						
18						
19						
20						

Waveform #8 Parameters

Burst	Number of Pulses	Pulse Width (µsec)	Chirp Width (MHz)	Pulse 1-to-2 Spacing (µsec)	Pulse 2-to-3 Spacing (µsec)	Start Location Within Interval (msec)
1	1	71.8	8			490
2	1	90.3	12			682
3	1	86.7	12			451
4	1	95.4	12			475
5	2	59	13	1859		117
6	2	77.7	14	1249		695
7	3	95.8	5	943	1014	254
8	1	81.3	6			705
9	1	81.5	18			165
10	2	62	9	1713		397
11	1	61.1	13			733
12	1	69.5	19			478
13	2	87.3	13	1890		513
14	3	50.2	14	1943	1457	448
15	3	82.3	6	1041	1471	650
16						
17						
18						
19						
20						

Waveform #9 Parameters

Burst	Number of Pulses	Pulse Width (µsec)	Chirp Width (MHz)	Pulse 1-to-2 Spacing (µsec)	Pulse 2-to-3 Spacing (µsec)	Start Location Within Interval (msec)
1	2	50.9	18	1625		344
2	1	82.6	20			507
3	1	65.8	10			637
4	1	80.2	13			524
5	3	80.3	6	1840	1815	447
6	2	67.5	20	1080		248
7	1	66.7	6			368
8	2	99.6	11	1033		686
9	2	67.6	5	1845		291
10	2	67.8	12	1727		538
11	2	69.5	5	1472		108
12	1	66.6	9			166
13	2	81.3	11	1079		493
14	2	77.9	15	1778		733
15	2	74.6	11	1415		160
16	2	90.5	20	1643		682
17						
18						
19						
20						

Waveform #10 Parameters

Burst	Number of Pulses	Pulse Width (µsec)	Chirp Width (MHz)	Pulse 1-to-2 Spacing (µsec)	Pulse 2-to-3 Spacing (µsec)	Start Location Within Interval (msec)
1	2	67.6	6	1109		183
2	2	89.2	9	1108		324
3	1	56.2	18			290
4	1	57	14			326
5	1	62.3	9			609
6	3	81.1	18	1137	1318	123
7	2	76.9	5	1769		636
8	2	98.1	15	1380		104
9	1	85.5	11			190
10	3	77.4	10	1362	1774	102
11	2	94	7	1840		70
12	1	93.2	14			89
13	1	92	8			420
14	1	64.2	7			303
15	2	72	12	1887		201
16	1	75.3	12			182
17	3	73.9	13	1501	1609	175
18						
19						
20						

Waveform #11 Parameters

Burst	Number of Pulses	Pulse Width (µsec)	Chirp Width (MHz)	Pulse 1-to-2 Spacing (µsec)	Pulse 2-to-3 Spacing (µsec)	Start Location Within Interval (msec)
1	1	64.2	14			283
2	1	87.5	12			199
3	2	72.2	9	1424		304
4	2	87.9	13	1115		250
5	1	51.6	13			330
6	1	86.6	5			605
7	2	87.3	10	1849		229
8	2	96	17	1077		618
9	2	53.6	5	1691		557
10	3	99.3	8	1630	1607	232
11	3	99.2	10	949	1605	238
12	1	78.9	18			134
13	2	74.6	8	1430		631
14	2	54.5	9	1755		361
15	1	91.5	6			374
16	2	65.9	14	952		319
17	1	53.2	13			651
18	3	91.1	17	1596	1196	502
19						
20						

Waveform #12 Parameters

Burst	Number of Pulses	Pulse Width (µsec)	Chirp Width (MHz)	Pulse 1-to-2 Spacing (µsec)	Pulse 2-to-3 Spacing (µsec)	Start Location Within Interval (msec)
1	2	57.6	18	1672		200
2	1	65.2	12			343
3	2	74.5	18	933		145
4	2	60.3	13	1156		597
5	3	60.4	18	1876	1399	56
6	1	60.5	13			166
7	1	84.8	5			117
8	1	84.8	14			163
9	2	71.5	15	1437		351
10	2	60.3	18	1527		480
11	3	91.7	12	1161	1233	591
12	1	79	10			277
13	1	61.5	10			68
14	2	80.8	5	1495		266
15	2	85.9	13	1072		18
16	2	74.6	8	1504		262
17	2	75.6	19	1212		240
18	2	62.6	11	1267		353
19	2	88.5	20	1087		603
20						

Waveform #13 Parameters

Burst	Number of Pulses	Pulse Width (µsec)	Chirp Width (MHz)	Pulse 1-to-2 Spacing (µsec)	Pulse 2-to-3 Spacing (µsec)	Start Location Within Interval (msec)
1	3	68.5	6	1815	1155	223
2	2	89.4	14	1663		458
3	2	82.4	11	1838		211
4	1	51.2	18			538
5	3	86.5	20	1549	1167	467
6	2	66.3	10	1435		420
7	2	55.6	14	1622		122
8	2	60.2	11	1014		307
9	2	79.3	8	931		120
10	1	76.9	15			546
11	3	57	6	1857	1864	533
12	2	74.1	5	1880		351
13	1	91.7	9			440
14	1	94.8	20			198
15	2	70	20	1770		92
16	1	95.9	13			577
17	2	87.3	6	1420		215
18	3	65	11	1694	1786	89
19	3	94.7	13	1171	1463	573
20	2	87.5	20	1655		164

Waveform #14 Parameters

Burst	Number of Pulses	Pulse Width (μsec)	Chirp Width (MHz)	Pulse 1-to-2 Spacing (μsec)	Pulse 2-to-3 Spacing (μsec)	Start Location Within Interval (msec)
1	3	95.9	15	1320	1751	1017
2	3	66.7	14	1376	1502	108
3	3	84.8	17	1359	933	948
4	3	69.9	12	1140	1561	1320
5	2	54.4	9	1510		695
6	2	67.1	14	1105		984
7	1	83.4	11			1221
8	2	54.8	13	1834		332
9						
10						
11						
12						
13						
14						
15						
16						
17						
18						
19						
20						

Waveform #15 Parameters

Burst	Number of Pulses	Pulse Width (µsec)	Chirp Width (MHz)	Pulse 1-to-2 Spacing (µsec)	Pulse 2-to-3 Spacing (µsec)	Start Location Within Interval (msec)
1	2	92	13	1097		1126
2	2	73.6	12	1654		945
3	3	67.9	13	1275	1210	59
4	3	92.6	6	1859	1511	557
5	2	99.4	8	1511		830
6	2	66.4	12	1840		506
7	3	61.9	17	972	1174	535
8	1	91.7	18			788
9	3	80.3	9	1533	1509	714
10						
11						
12						
13						
14						
15						
16						
17						
18						
19						
20						

Waveform #16 Parameters

Burst	Number of Pulses	Pulse Width (μsec)	Chirp Width (MHz)	Pulse 1-to-2 Spacing (μsec)	Pulse 2-to-3 Spacing (μsec)	Start Location Within Interval (msec)
1	2	75.1	9	1772		154
2	2	98.6	17	1058		563
3	2	72.8	9	1358		951
4	1	99.5	8			742
5	3	60.6	15	1035	1064	873
6	1	100	10			134
7	3	97.1	15	1498	1356	405
8	2	50.9	11	1331		529
9	2	98.9	5	1012		240
10	1	77.9	17			240
11						
12						
13						
14						
15						
16						
17						
18						
19						
20						

Waveform #17 Parameters

Burst	Number of Pulses	Pulse Width (µsec)	Chirp Width (MHz)	Pulse 1-to-2 Spacing (µsec)	Pulse 2-to-3 Spacing (µsec)	Start Location Within Interval (msec)
1	3	67.6	20	1709	1059	430
2	2	82.3	17	1861		435
3	2	80.8	11	1374		940
4	2	79.9	12	1184		972
5	2	94.8	6	1385		602
6	2	73.4	10	1784		113
7	3	62.7	13	1214	1436	1062
8	3	79.3	6	1460	1030	838
9	1	54.6	8			240
10	2	75.9	10	1606		798
11	2	93.9	11	1128		728
12						
13						
14						
15						
16						
17						
18						
19						
20						

Waveform #18 Parameters

Burst	Number of Pulses	Pulse Width (µsec)	Chirp Width (MHz)	Pulse 1-to-2 Spacing (µsec)	Pulse 2-to-3 Spacing (µsec)	Start Location Within Interval (msec)
1	1	87.9	13			757
2	1	83.9	19			697
3	1	79.7	12			389
4	2	95.5	5	1468		640
5	3	82.1	5	1099	1001	751
6	2	63.4	18	1075		371
7	2	70.7	11	1266		724
8	3	73.7	15	958	1325	791
9	1	85	5			942
10	2	91.2	6	1610		80
11	2	74.2	8	987		412
12	3	78.2	7	1849	1083	973
13						
14						
15						
16						
17						
18						
19						
20						

Waveform #19 Parameters

Burst	Number of Pulses	Pulse Width (µsec)	Chirp Width (MHz)	Pulse 1-to-2 Spacing (µsec)	Pulse 2-to-3 Spacing (µsec)	Start Location Within Interval (msec)
1	1	71.5	20			336
2	2	94.5	6	1023		4
3	1	78.5	11			129
4	1	85.5	9			474
5	3	54.6	18	1612	1372	241
6	2	70.4	10	1405		844
7	2	87.4	20	1315		189
8	3	57.4	20	1594	1824	49
9	1	90.6	8			168
10	3	71.5	10	1915	1648	734
11	1	96.7	13			201
12	3	94.8	9	1904	931	336
13	3	66.1	12	1105	1856	173
14						
15						
16						
17						
18						
19						
20						

Waveform #20 Parameters

Burst	Number of Pulses	Pulse Width (µsec)	Chirp Width (MHz)	Pulse 1-to-2 Spacing (µsec)	Pulse 2-to-3 Spacing (µsec)	Start Location Within Interval (msec)
1	1	60.4	13			526
2	3	80.4	9	1340	1098	155
3	1	72.8	8			136
4	2	92.9	8	1193		25
5	2	91.9	14	1332		845
6	3	74.1	7	1559	1267	762
7	1	63.9	7			137
8	2	87	10	1749		472
9	2	100	13	1286		94
10	1	73.2	18			240
11	1	56.5	13			35
12	3	64.1	19	1365	1897	598
13	3	60.6	13	1214	1484	67
14	2	63.1	5	1403		253
15						
16						
17						
18						
19						
20						

Waveform #21 Parameters

Burst	Number of Pulses	Pulse Width (µsec)	Chirp Width (MHz)	Pulse 1-to-2 Spacing (µsec)	Pulse 2-to-3 Spacing (µsec)	Start Location Within Interval (msec)
1	1	50.2	9			209
2	3	59	9	1910	1016	512
3	3	87.2	5	1625	1565	404
4	3	86.2	15	1005	1619	499
5	2	51.3	11	1349		438
6	2	55.6	7	1385		729
7	1	60	13			618
8	2	90.3	7	1084		682
9	2	56.4	8	1689		701
10	1	75	11			379
11	3	79.4	6	1008	1032	387
12	1	60.9	17			727
13	2	76	9	1169		728
14	2	84.1	5	1765		346
15	1	82.6	20			704
16						
17						
18						
19						
20						

Waveform #22 Parameters

Burst	Number of Pulses	Pulse Width (µsec)	Chirp Width (MHz)	Pulse 1-to-2 Spacing (µsec)	Pulse 2-to-3 Spacing (µsec)	Start Location Within Interval (msec)
1	2	99.1	11	1894		634
2	2	93.4	10	1021		237
3	2	69	12	1494		583
4	2	64.2	11	1674		285
5	3	50.2	20	1659	1264	355
6	3	87.8	13	1048	1287	299
7	2	73.6	11	1160		506
8	2	70.9	8	1597		551
9	3	60.4	17	1820	1115	599
10	3	69.7	6	1519	1128	492
11	3	58.5	13	1146	1722	128
12	3	90	10	1274	1892	201
13	3	51.4	9	1550	1202	3
14	2	82.5	14	1460		438
15	2	97.4	7	1043		637
16	2	70	19	1745		42
17						
18						
19						
20						

Waveform #23 Parameters

Burst	Number of Pulses	Pulse Width (µsec)	Chirp Width (MHz)	Pulse 1-to-2 Spacing (µsec)	Pulse 2-to-3 Spacing (µsec)	Start Location Within Interval (msec)
1	3	64.7	8	1789	1569	579
2	3	74.1	19	1813	1698	694
3	2	64.9	13	1693		536
4	1	87.9	9			488
5	2	85.2	13	1070		60
6	1	86.6	5			697
7	2	98.4	10	1406		597
8	2	77.7	9	1603		270
9	1	61.9	13			434
10	2	86.2	8	1829		387
11	1	95.3	10			434
12	2	63.4	17	1320		227
13	2	69	17	1131		432
14	3	98.5	7	1640	1278	273
15	2	80.8	17	1908		483
16	2	96.6	19	1699		217
17	1	83.9	19			457
18						
19						
20						

Waveform #24 Parameters

Burst	Number of Pulses	Pulse Width (µsec)	Chirp Width (MHz)	Pulse 1-to-2 Spacing (µsec)	Pulse 2-to-3 Spacing (µsec)	Start Location Within Interval (msec)
1	1	57.4	13			380
2	1	83.5	20			132
3	3	76.5	7	1323	1195	453
4	1	96.8	19			359
5	3	98.7	11	1809	1114	399
6	3	50.9	13	1672	1843	626
7	3	64.7	7	1697	1506	577
8	2	95	6	1523		286
9	1	93.9	7			639
10	2	91.5	9	1005		251
11	2	73.4	19	1903		415
12	1	81.1	18			354
13	2	92.4	9	1810		343
14	3	58.7	11	1325	1626	401
15	3	67	13	1320	1890	249
16	1	73.8	5			214
17	2	94.9	13	1659		92
18						
19						
20						

Waveform #25 Parameters

Burst	Number of Pulses	Pulse Width (µsec)	Chirp Width (MHz)	Pulse 1-to-2 Spacing (µsec)	Pulse 2-to-3 Spacing (µsec)	Start Location Within Interval (msec)
1	3	80.6	8	1319	1171	480
2	3	98.3	11	1855	918	1
3	1	94.1	13			465
4	2	80.4	8	1002		413
5	1	99.7	11			153
6	3	87	10	1073	1489	100
7	2	64	15	1185		514
8	1	97.1	10			525
9	2	82.1	17	967		413
10	3	93.8	8	1264	1269	264
11	1	68.9	20			634
12	3	69.3	13	1059	1876	190
13	2	74.7	13	1821		314
14	2	97.1	7	964		249
15	2	65.4	6	1005		647
16	2	93.8	15	1508		627
17	3	79.7	19	1830	1069	381
18	1	52.8	14			496
19						
20						

Waveform #26 Parameters

Burst	Number of Pulses	Pulse Width (μsec)	Chirp Width (MHz)	Pulse 1-to-2 Spacing (μsec)	Pulse 2-to-3 Spacing (μsec)	Start Location Within Interval (msec)
1	3	60.4	5	1562	1819	39
2	2	84.2	19	1166		337
3	1	52.2	13			193
4	1	80.6	11			282
5	2	86	6	1359		302
6	3	96.5	9	1887	1160	117
7	3	90.2	12	1043	1322	492
8	2	79.5	9	1588		418
9	2	57.1	14	1050		546
10	3	79.1	13	1452	1085	583
11	3	69.5	13	1389	1600	190
12	1	52.8	12			206
13	2	92.7	13	1636		482
14	3	87	11	1074	1879	374
15	2	93.7	11	1045		564
16	1	50.8	11			585
17	2	81.9	18	1757		409
18	3	88.6	20	1581	1154	208
19	3	84.1	12	1501	1519	70
20						

Waveform #27 Parameters

Burst	Number of Pulses	Pulse Width (µsec)	Chirp Width (MHz)	Pulse 1-to-2 Spacing (µsec)	Pulse 2-to-3 Spacing (µsec)	Start Location Within Interval (msec)
1	1	52.1	17			394
2	2	52.2	13	1765		253
3	2	77.7	13	1676		284
4	1	67	15			496
5	1	96.9	13			463
6	2	73.4	11	1806		472
7	1	58.4	13			350
8	1	93.8	7			432
9	2	71.9	17	1296		102
10	2	73.2	5	1411		554
11	3	53.7	5	1312	1066	256
12	2	53.2	9	1298		307
13	3	73.3	5	1683	1343	22
14	3	68	11	1711	1130	189
15	1	67.8	19			131
16	2	89.7	13	1225		298
17	2	50.2	20	1615		330
18	2	86.8	17	1037		480
19	2	63.3	12	1682		61
20	2	63.2	5	1037		183

Waveform #28 Parameters

Burst	Number of Pulses	Pulse Width (μsec)	Chirp Width (MHz)	Pulse 1-to-2 Spacing (μsec)	Pulse 2-to-3 Spacing (μsec)	Start Location Within Interval (msec)
1	1	52.4	12			827
2	2	99.4	14	1215		199
3	1	89.8	10			55
4	2	65.6	15	1233		1442
5	3	82.8	15	1609	1376	246
6	2	98	18	1663		1338
7	2	69.3	8	1105		928
8	2	67.5	5	1520		237
9						
10						
11						
12						
13						
14						
15						
16						
17						
18						
19						
20						

Waveform #29 Parameters

Burst	Number of Pulses	Pulse Width (μsec)	Chirp Width (MHz)	Pulse 1-to-2 Spacing (μsec)	Pulse 2-to-3 Spacing (μsec)	Start Location Within Interval (msec)
1	1	93.3	7			936
2	3	91.8	9	1002	1623	1072
3	2	92.6	9	1528		1237
4	2	81.3	12	1202		748
5	3	83.1	13	1344	1609	158
6	1	97.3	7			762
7	2	90.9	17	1072		612
8	2	66.8	5	1323		1009
9	2	64.1	14	1218		295
10						
11						
12						
13						
14						
15						
16						
17						
18						
19						
20						

Waveform #30 Parameters

Burst	Number of Pulses	Pulse Width (μsec)	Chirp Width (MHz)	Pulse 1-to-2 Spacing (μsec)	Pulse 2-to-3 Spacing (μsec)	Start Location Within Interval (msec)
1	2	89.9	5	946		1139
2	3	91.2	8	1748	1067	932
3	2	81.9	17	1032		8
4	2	54.6	15	963		124
5	1	71.6	13			1056
6	2	64.5	12	1239		472
7	1	74.2	6			328
8	2	93.4	9	1698		316
9	2	80.5	19	1093		509
10	2	98.5	13	1424		359
11						
12						
13						
14						
15						
16						
17						
18						
19						
20						

END OF REPORT