

TEST REPORT

Report Number: 103224477MPK-003A

Project Number: G103224477

October 18, 2017

**Testing performed on the
FIBERGATEWAY
Model Number: GR240BG
FCC ID: 2ACJF-FGW-GR240BG**

**to
FCC Part 15, Subpart E**

For

Altice Labs, SA

Test Performed by:
Intertek
1365 Adams Court
Menlo Park, CA 94025 USA

Test Authorized by:
Altice Labs, SA
Rua Eng. Ferreira Pinto Basto
3810-106 Aveiro, Portugal

Prepared by:  _____ **Date:** October 18, 2017
Minh Ly

Reviewed by:  _____ **Date:** October 18, 2017
Krishna K Vemuri

This report is for the exclusive use of Intertek's Client and is provided pursuant to the agreement between Intertek and its Client. Intertek's responsibility and liability are limited to the terms and conditions of the agreement. Intertek assumes no liability to any party, other than to the Client in accordance with the agreement, for any loss, expense or damage occasioned by the use of this report. Only the Client is authorized to copy or distribute this report and then only in its entirety. Any use of the Intertek name or one of its marks for the sale or advertisement of the tested material, product or service must first be approved in writing by Intertek. The observations and test results in this report are relevant only to the sample tested. This report by itself does not imply that the material, product, or service is or has ever been under an Intertek certification program. This report must not be used to claim product endorsement by A2LA, NIST nor any other agency of the U.S. Government.

VERIFICATION OF COMPLIANCE**Report No. 103224477MPK-003A**

Verification is hereby issued to the named APPLICANT and is VALID ONLY for the equipment identified hereon for use under the rules and regulations listed below.

Equipment Under Test:	FIBERGATEWAY
Trade Name:	Altice Labs, SA
Model No.:	GR240BG
Applicant:	Altice Labs, SA
Contact:	Ricardo Cunha
Address:	Rua Eng. Ferreira Pinto Basto 3810-106 Aveiro
Country:	Portugal
Tel. Number:	351234403200
Email:	Rcunha@ptinovacao.pt
Applicable Regulation:	FCC Part 15, Subpart E
Date of Test:	September 20 – October 11, 2017

We attest to the accuracy of this report:



Minh Ly
Project Engineer

Anderson Soungpanya
Project Engineer



Krishna K Vemuri
Engineering Team Lead

TABLE OF CONTENTS

1.0	Introduction.....	4
1.1	Summary of Tests.....	4
2.0	General Description	5
2.1	Product Description.....	5
2.2	Related Submittal(s) Grants	6
2.3	Test Methodology	6
2.4	Test Facility.....	6
2.5	Measurement Uncertainty	6
3.0	System Test Configuration.....	7
3.1	Support Equipment	7
3.2	Block Diagram of Test Setup	7
3.3	Justification	8
3.4	Mode of Operation During Test	8
3.5	Modifications required for Compliance	9
3.6	Additions, deviations and exclusions from standards.....	9
4.0	Measurement Results.....	10
4.1	Emission Bandwidth and 99% Occupied Bandwidth.....	10
4.1.1	Procedure	10
4.1.2	Test Result	11
4.2	Maximum Conducted Output Power.....	21
4.2.1	Requirement.....	21
4.2.2	Procedure	21
4.2.3	Test Results.....	22
4.3	Peak Power Spectral Density.....	42
4.3.1	Requirement.....	42
4.3.2	Procedure	42
4.3.3	Test Result	43
4.4	Frequency stability	45
4.4.1	Requirement.....	45
4.4.2	Procedure	45
4.4.3	Result	46
4.5	Transmitter Radiated Emissions.....	47
4.5.1	Requirement.....	47
4.5.2	Procedure	48
4.5.3	Field Strength Calculation.....	49
4.5.4	Test Results.....	50
4.5.5	Test setup photographs.....	77
5.0	List of Test Equipment	79
6.0	Document History	80

1.0 Introduction

1.1 Summary of Tests

Test	Reference FCC	Result
26 dB Emission Band width and 99% Occupied Bandwidth	15.407(a)(1)(2)(3)	Complies
Conducted Output Power	15.407(a)(1)(2)(3)	Complies
Peak Power Spectral Density	15.407(a)(1)(2)(3)	Complies
Undesirable Emissions	15.407(b)(1-8)	Complies
Transmitter Radiated Emissions	15.407(b)(1-8) 15.209, 15.205	Complies
Frequency stability	15.407(g)	Complies
Antenna Requirement	15.203	Complies (Unique Connector & Internal Antenna)
AC Line Conducted Emission	15.207	Complies*

*See Report 103224477MPK-002B for compliance data

EUT receive date: September 18, 2017

EUT receive condition: The pre-production version of the EUT was received in good condition with no apparent damage. As declared by the Applicant, it is identical to the production units.

Test start date: September 20, 2017

Test completion date: October 11, 2017

The test results in this report pertain only to the item tested.

2.0 General Description

2.1 Product Description

Altice Labs, SA supplied the following description of the EUT:

The FiberGateway GR240BG is an ONT (Optical Network Terminal) solution based on Rec. ITU-T G.984.x that supports triple play services (high speed internet, voice and video) which are deployed over Ethernet and Wi-Fi interfaces. GEM (GPON encapsulation method) is employed to adapt technologies. This system can be used in triple play service delivery network solutions. It includes Home Gateway functionalities, 4 GbE ports and Wi-Fi Dual-Band Concurrent (2.4 GHz bgn 4x4 + 5 GHz anac 4x4) for internet access and IPTV, 2 FXS ports for voice and 1 USB 2.0 port.

The information about the 5GHz radio, installed in the model GR240BG, is presented below.

Applicant	Altice Labs, SA
Model No.	GR240BG
FCC ID	2ACJF-FGW-GR240BG
Rated RF Output	802.11a: 20.63 dBm 802.11n 20MHz: 20.67 dBm 802.11n 40MHz: 17.70 dBm 802.11ac 80MHz: 16.73 dBm
Frequency Range	U-NII 1: 5150 – 5250 MHz
Type of modulation	OFDM
Antenna(s) & Gain	Internal Antenna, 4.95 dBi calculated peak gain Ant 0 – DB1: 4.8dBi, Vertical Ant 1 – DB2: 3.4dBi, Horizontal Ant 2 – DB3: 4.0dBi, Horizontal Ant 3 – DB4: 5.1dBi, Vertical
Manufacturer Name & Address	Altice Labs, SA Rua Eng. Ferreira Pinto Basto 3810-106 Aveiro Portugal

The EUT supports a wide range of data rates in the U-NII 1 band:

- IEEE 802.11a
- IEEE 802.11n 20MHz
- IEEE 802.11n 40MHz
- IEEE 802.11ac 20MHz
- IEEE 802.11ac 40MHz
- IEEE 802.11ac 80MHz

2.2 Related Submittal(s) Grants

None.

2.3 Test Methodology

Antenna conducted measurements were performed according to the FCC documents “Guidelines for Compliance Testing of Unlicensed National Information Infrastructure (U-NII) Devices Part 15, Subpart E” (789033 D02 General U-NII Test Procedures New Rules v01r04, and 662911 D01 Multiple Transmitter Output v02r01).

Both AC mains line-conducted and radiated emissions measurements were performed according to the procedures in ANSI C63.4. Radiated tests were performed at an antenna to EUT distance of 3 meters, unless stated otherwise in the "**Data Sheet**" of this Application.

All other measurements were made in accordance with the procedures in part 2 of CFR 47.

2.4 Test Facility

The test site used to collect the radiated data is site 1 (10-m semi-anechoic chamber). This test facility and site measurement data have been fully placed on file with the FCC, IC and A2LA accredited.

2.5 Measurement Uncertainty

Compliance with the limits was based on the results of the measurements and doesn't take into account the measurement uncertainty.

Estimated Measurement Uncertainty

Measurement	Expanded Uncertainty (k=2)		
	0.15 MHz – 1 GHz	1 GHz – 6 GHz	> 6 GHz
RF Power and Power Density – antenna conducted	1.1 dB	1.5 dB	–
Unwanted emissions - antenna conducted	1.2 dB	1.7 dB	2.0 dB
Bandwidth – antenna conducted	50 Hz	100 Hz	–
Radiated emissions	4.2 dB	5.4 dB	
AC mains conducted emissions	2.4 dB	-	-

3.0 System Test Configuration

3.1 Support Equipment

Description	Manufacturer	Model No./ Part No.
Laptop	HP	EliteBook 8470p
Optical Line Termination	Cisco	Cisco ME 4600 Series
Flash Drive	Kingston	DT101G2 8GB
Telephone	TKT	1700137823
Telephone	Alcatel	N/A
Router	Linksys	BEFSR81

3.2 Block Diagram of Test Setup

Equipment Under Test			
Description	Manufacturer	Model Number	Serial Number
FiberGateway (Radiated Unit)	Altice Labs, SA	GR240BG	5054494E912154CF
AC/DC Power Adapter	Airline mechanical Co Ltd	EOSA+4B120-4000	AB1708240092570
FiberGateway (Conducted Unit)	Altice Labs, SA	GR240BG	5054494E9121874F

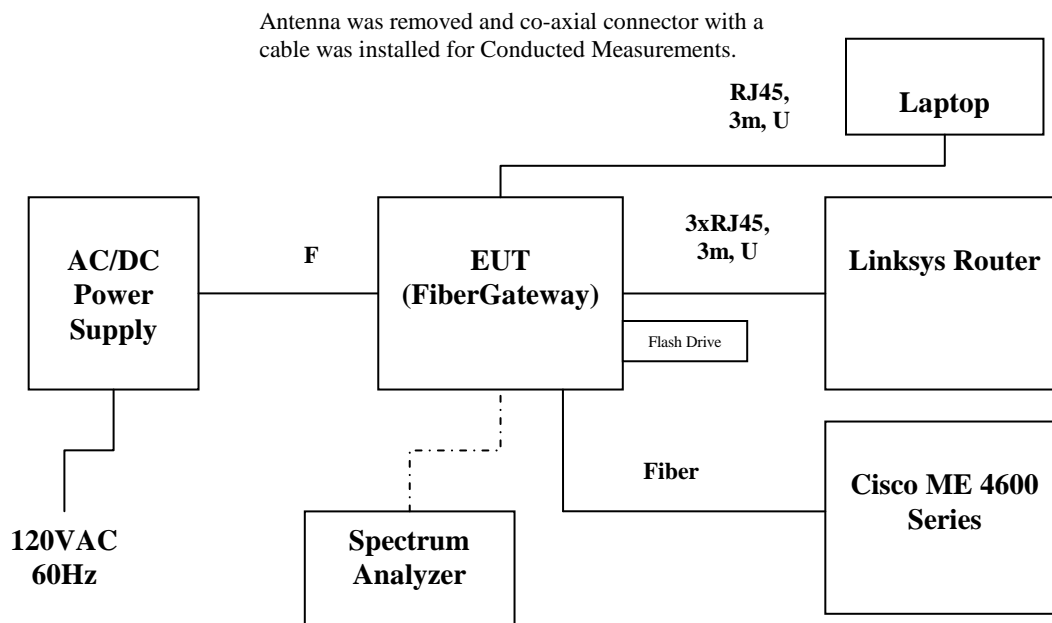

S = Shielded	F = With Ferrite
U = Unshielded	m = Meter

3.3 Justification

Preliminary testing was performed for all modulation/data rate modes. The following modes, in which the highest power was detected, were selected for final measurements:

- OFDM, 6MB/s – for 802.11a (Power Setting on test firmware: 15)
- OFDM, MCS0 – for 802.11n 20MHz (Power Setting on test firmware: 15)
- OFDM, MCS0 – for 802.11n 40MHz (Power Setting on test firmware: 12)
- OFDM, MCS0 – for 802.11ac 80MHz (Power Setting on test firmware: 12)

According to the manufacture, the FiberGateway utilizes cross-polarized antennas with two vertical (Ant 1 & Ant 4) and two Horizontal (Ant 2 & Ant 3). Per FCC KDB “662911 D01 Multiple Transmitter Output v02r01”, the directional gain of the antenna is calculated as below:

$$\text{Directional gain} = 10 \log[(10^{G1/10} + 10^{G2/10} + \dots + 10^{GN/10})/N_{\text{ANT}}] \text{ dBi}$$

$$\text{Vertical Gain} = 10 \log[(10^{(4.8/10)} + 10^{(5.1/10)})/2] = 4.9\text{dBi}$$

$$\text{Horizontal Gain} = 10 \log[(10^{(3.4/10)} + 10^{(4/10)})/2] = 3.7\text{dBi}$$

3.4 Mode of Operation During Test

During transmitter testing, the transmitter was setup to transmit continuously using the maximum RF power setting. Their corresponding output power in dBm can be found in section 4.2 of this report.

3.5 Modifications required for Compliance

The following modification was made by the manufacturer to the EUT in order to bring the EUT into compliance:

- Added a ferrite with double loop (Manufacture: Wurth Electronics, Part Number: 74271633S) at the DC input of the FiberGateway (See below).



3.6 Additions, deviations and exclusions from standards

No additions, deviations or exclusion have been made from standard.

4.0 Measurement Results

4.1 Emission Bandwidth and 99% Occupied Bandwidth

15.407(a)(1)(2)

4.1.1 Procedure

The Procedure, described in the FCC Publication 789033 D02 General U-NII Test Procedures New Rules v01r04, was used. Specifically Section C for Emission Bandwidth and Section D was used for 99% Occupied Bandwidth.

The antenna port of the EUT was connected to the input of a spectrum analyzer (SA). For each RF output channel investigated, the spectrum analyzer center frequency was set to the channel carrier.

The Occupied bandwidth was measured using the build-in spectrum analyzer facility for 99% power bandwidth measurement.

Tested By:	Anderson Soungpanya
Test Date:	September 26, 2017

4.1.2 Test Result

Refer to the following plots for the test result:

Mode	Channel	Frequency, MHz	26-dB Bandwidth, MHz	Occupied Bandwidth, MHz	Plot #
802.11a	36	5180	21.967	17.48	1.1
	40	5200	21.733	17.46	1.2
	48	5240	21.923	17.5	1.3
802.11n 20MHz	36	5180	21.987	18.32	1.4
	40	5200	21.923	18.34	1.5
	48	5240	22.247	18.48	1.6
802.11n 40MHz	38	5190	40.384	36.6	1.7
	46	5230	40.256	36.64	1.8
802.11ac 80MHz	42	5210	81.909	75.04	1.9

Plot 1. 1 802.11a 5180MHz

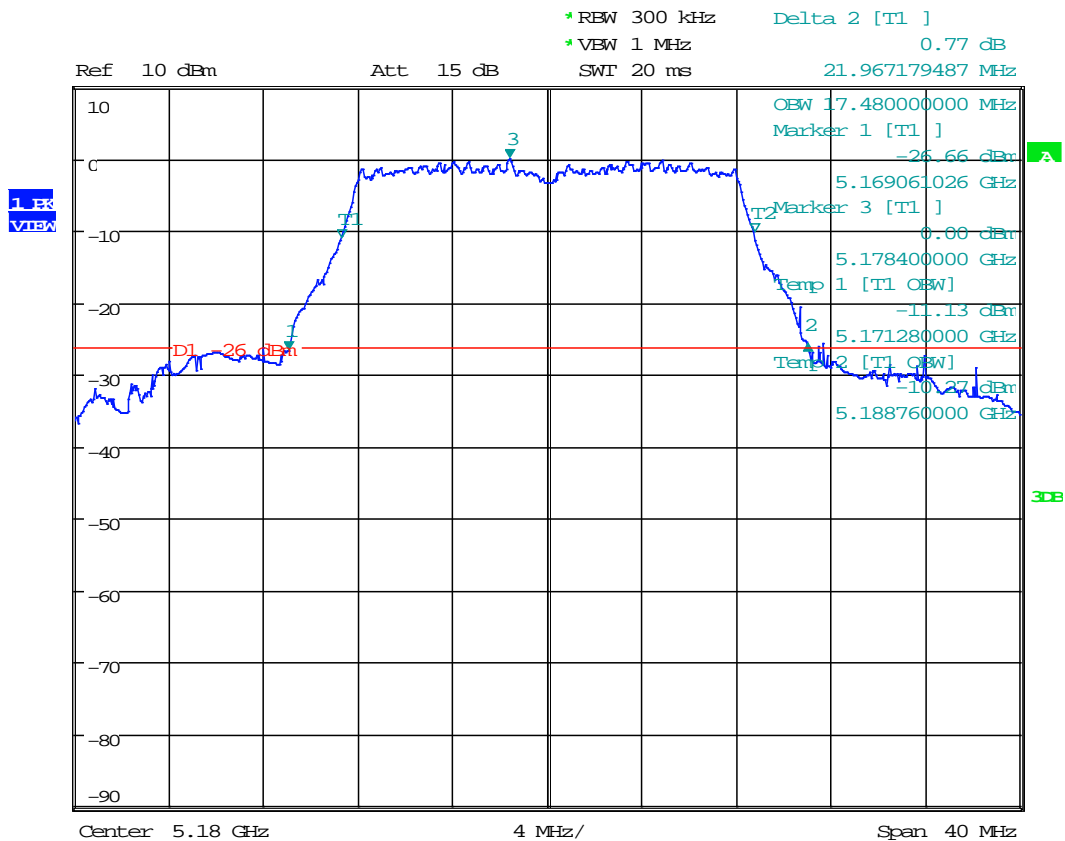

Date: 26.SEP.2017 09:53:19

Plot 1. 2
802.11a 5200MHz

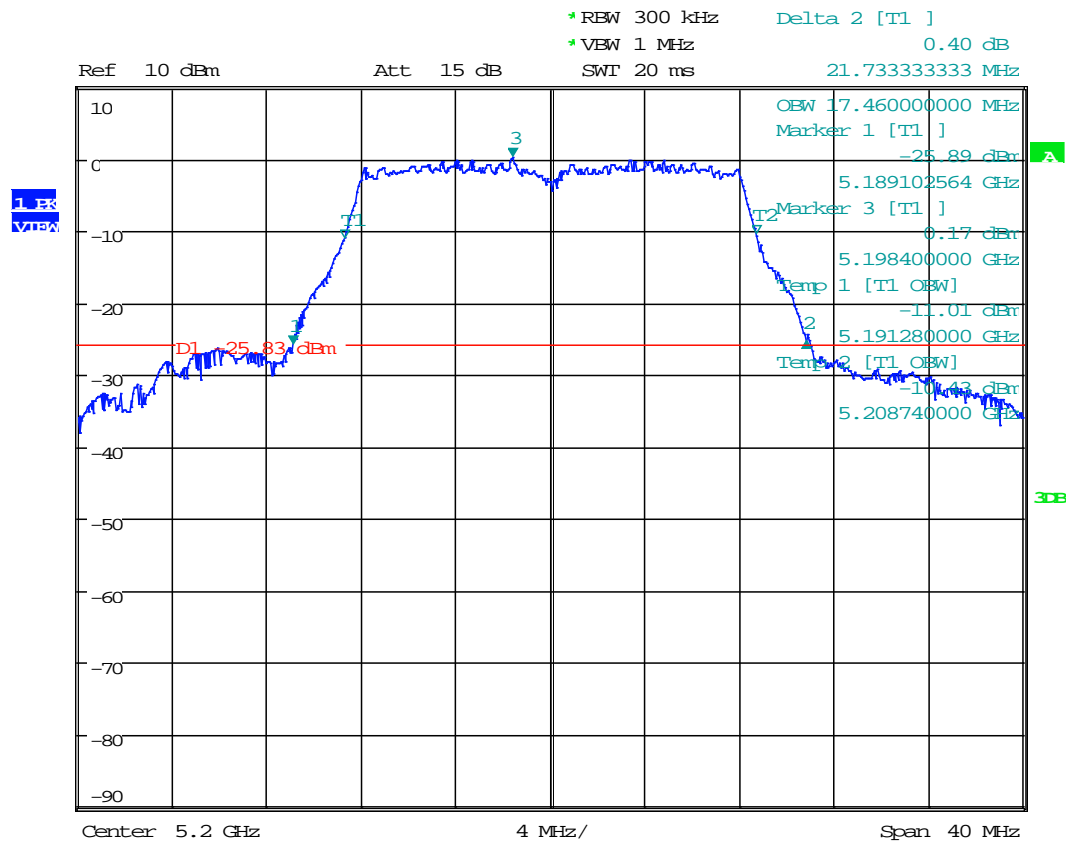

Date: 26.SEP.2017 09:57:16

Plot 1.3
802.11a 5240MHz

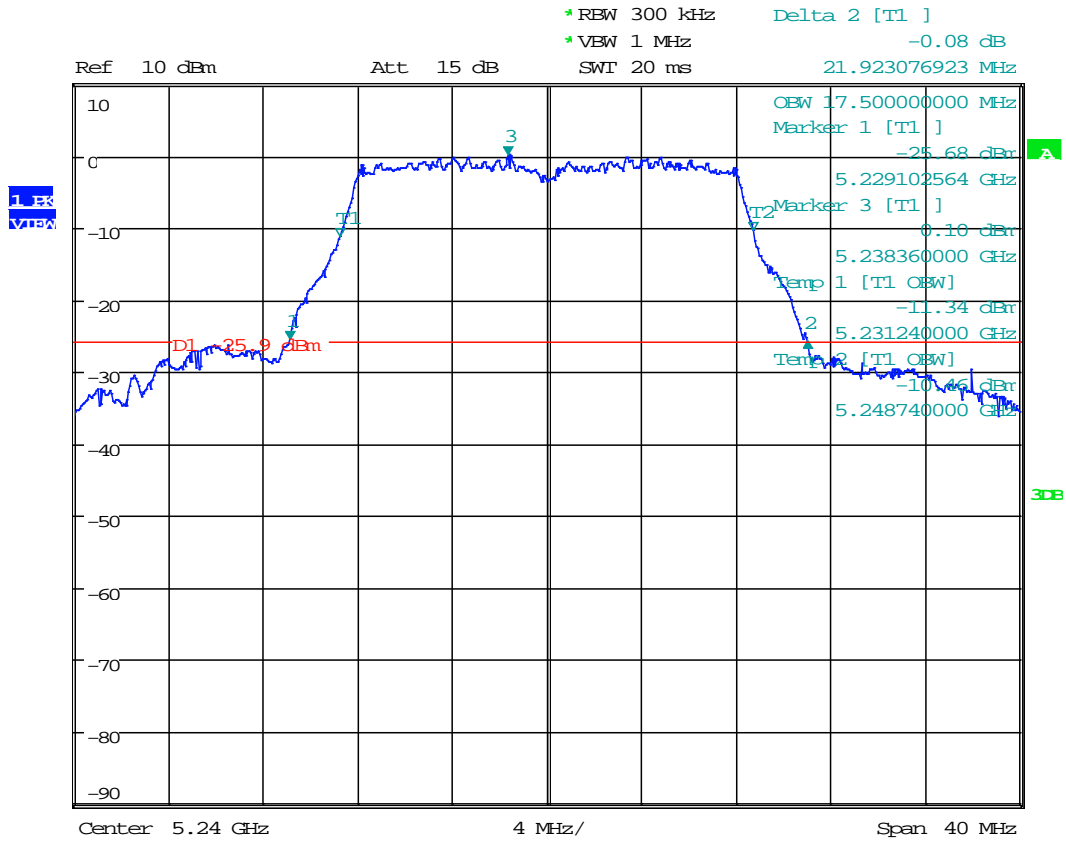

Date: 26.SEP.2017 10:05:47

*Upper 99% occupied bandwidth at 5248.74MHz. Therefore, it does not straddles into U-NII 2A band.

Plot 1.4

802.11n 20MHz, 5180MHz

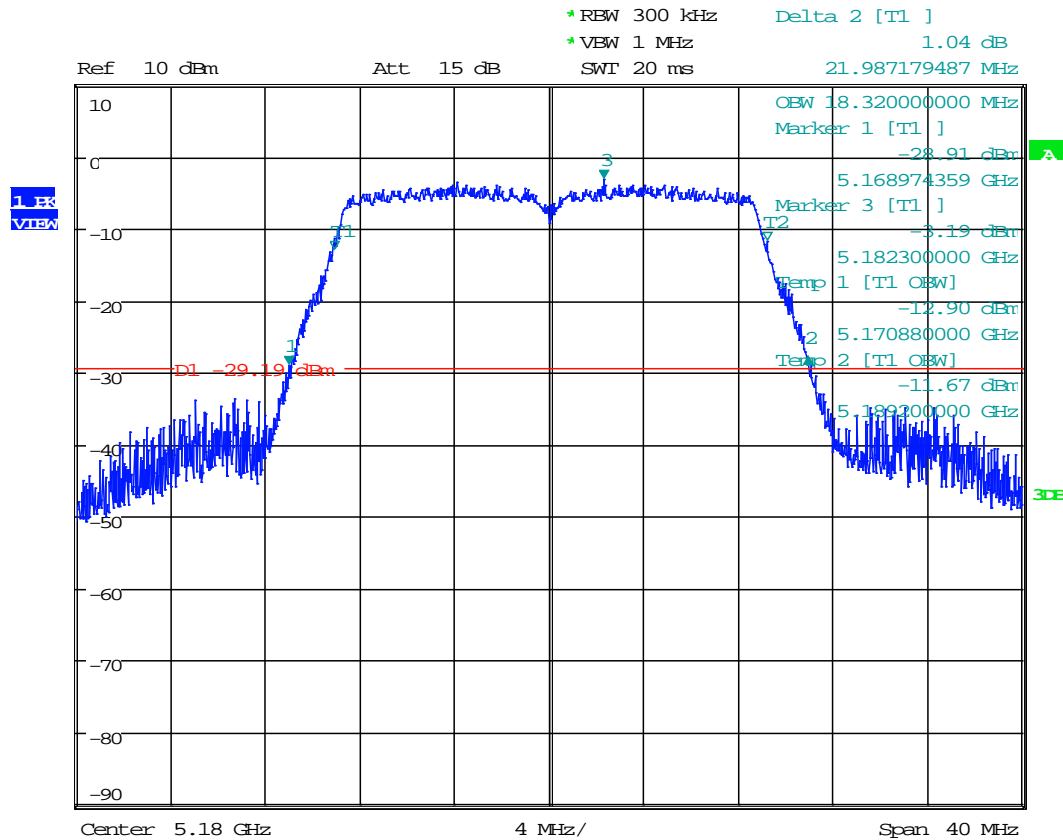

Date: 26.SEP.2017 10:11:03

Plot 1.5 802.11n 20MHz, 5200MHz

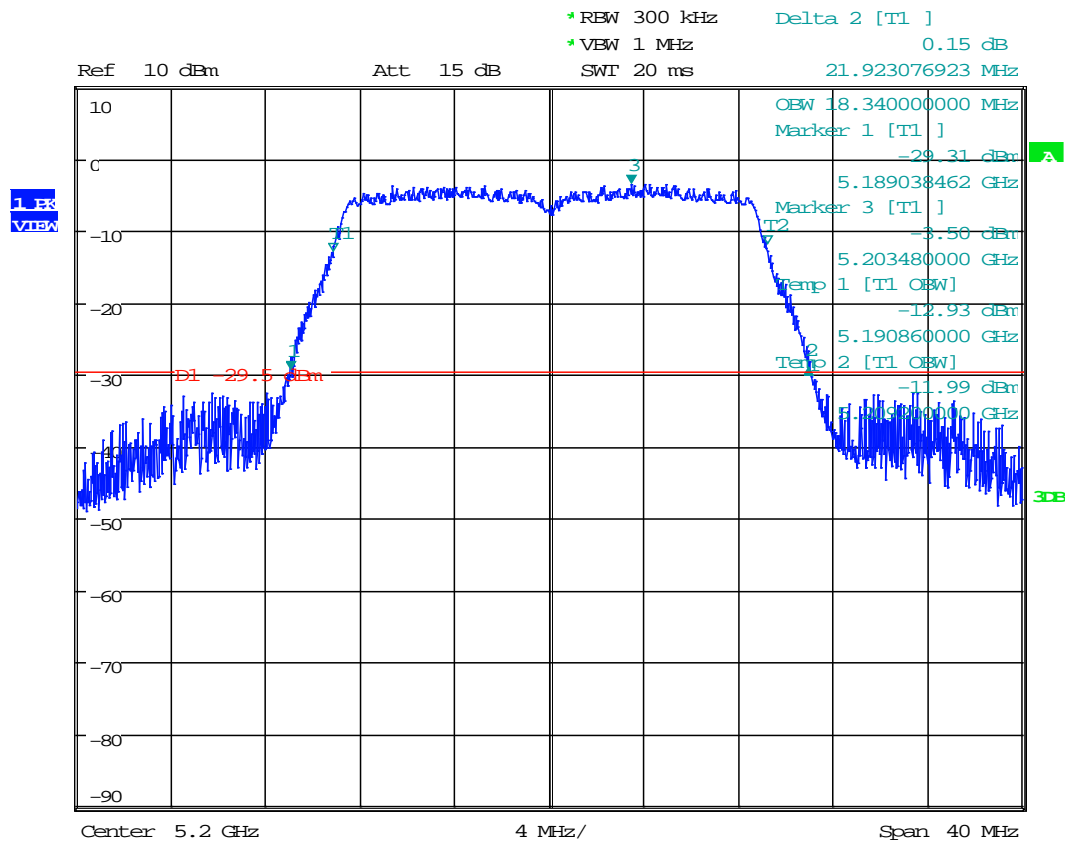

Date: 26.SEP.2017 10:13:10

Plot 1.7 802.11n 40MHz, 5190MHz

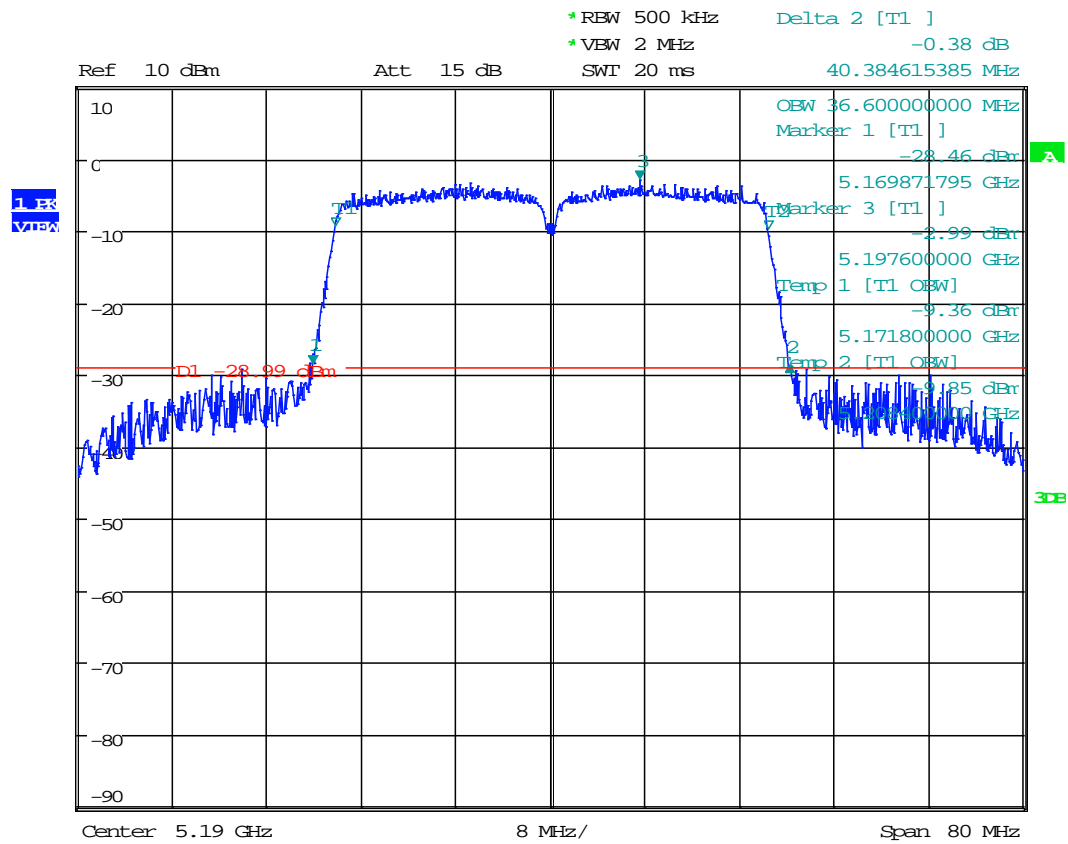

Date: 26.SEP.2017 10:47:47

Plot 1.9
802.11ac 80MHz, 5210MHz

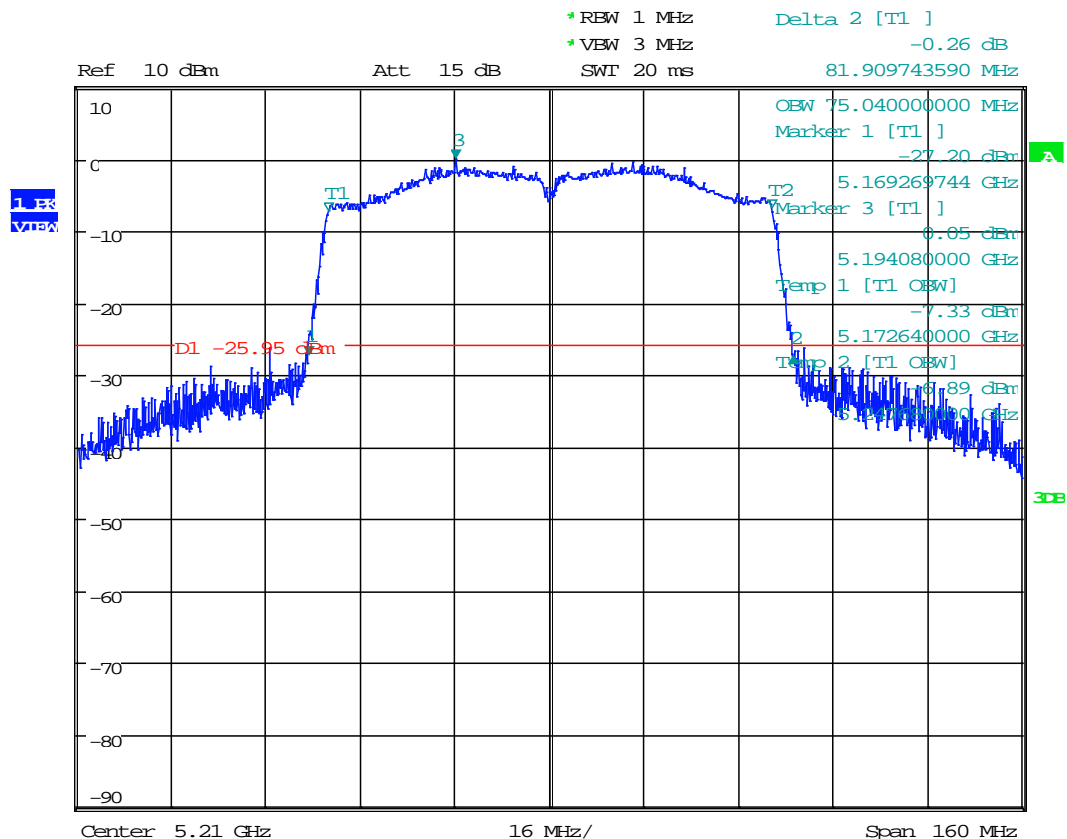

Date: 26.SEP.2017 10:57:23

*Upper 99% occupied bandwidth at 5247.66MHz. Therefore, it does not straddle into U-NII 2A band.

4.2 Maximum Conducted Output Power
FCC Rule 15.407(a)(1)(ii)

4.2.1 Requirement

For an indoor access point operating in the band 5.15-5.25 GHz, the maximum conducted output power over the frequency band of operation shall not exceed 1 W provided the maximum antenna gain does not exceed 6 dBi. In addition, the maximum power spectral density shall not exceed 17 dBm in any 1 megahertz band. If transmitting antennas of directional gain greater than 6 dBi are used, both the maximum conducted output power and the maximum power spectral density shall be reduced by the amount in dB that the directional gain of the antenna exceeds 6 dBi.

4.2.2 Procedure

The Procedure, described in the FCC Publication 789033 D02 General U-NII Test Procedures New Rules v01r04, was used. Specifically Section E (2) (b) Method SA-1 for Maximum Conducted Output Power

The antenna port output of the EUT was connected to the input of a spectrum analyzer to measure the Maximum Conducted Transmitter Output Power.

Tested By:	Minh Ly
Test Date:	October 04, 2017

4.2.3 Test Results

Refer to the following plots for the test result:

802.11a (6Mbps) – Conducted Average Power

CH	Frequency MHz	Ant 0 – DB1 (dBm)	Plot #	Ant 1 – DB2 (dBm)	Plot #	Ant 2 – DB3 (dBm)	Plot #	Ant 3 – DB4 (dBm)	Plot #
36	5180	14.43	2.1	14.16	2.4	13.93	2.7	14.49	2.10
40	5200	14.49	2.2	14.62	2.5	14.29	2.8	14.92	2.11
48	5240	14.57	2.3	14.58	2.6	14.30	2.9	14.96	2.12

802.11n 20MHz (MCS0) – Conducted Average Power

CH	Frequency MHz	Ant 0 – DB1 (dBm)	Plot #	Ant 1 – DB2 (dBm)	Plot #	Ant 2 – DB3 (dBm)	Plot #	Ant 3 – DB4 (dBm)	Plot #
36	5180	14.28	2.13	14.29	2.16	14.05	2.19	14.65	2.22
40	5200	14.67	2.14	14.64	2.17	14.25	2.20	14.99	2.23
48	5240	14.61	2.15	14.59	2.18	14.16	2.21	15.00	2.24

802.11n 40MHz (MCS0) – Conducted Average Power

CH	Frequency MHz	Ant 0 – DB1 (dBm)	Plot #	Ant 1 – DB2 (dBm)	Plot #	Ant 2 – DB3 (dBm)	Plot #	Ant 3 – DB4 (dBm)	Plot #
38	5190	11.48	2.25	11.31	2.27	10.84	2.29	11.57	2.31
46	5230	11.69	2.26	11.71	2.28	11.34	2.30	11.97	2.32

802.11ac 80MHz (MCS0) – Conducted Average Power

CH	Frequency MHz	Ant 0 – DB1 (dBm)	Plot #	Ant 1 – DB2 (dBm)	Plot #	Ant 2 – DB3 (dBm)	Plot #	Ant 3 – DB4 (dBm)	Plot #
42	5210	10.73	2.33	10.90	2.34	10.03	2.35	11.10	2.36

CH	Frequency (MHz)	Summed power (dBm)	Summed power (W)
802.11a			
36	5180	20.28	0.107
40	5200	20.61	0.115
48	5240	20.63	0.116
802.11n 20MHz			
36	5180	20.34	0.108
40	5200	20.67	0.117
48	5240	20.62	0.115
802.11n 40MHz			
38	5190	17.33	0.054
46	5230	17.70	0.059
802.11ac 80MHz			
42	5210	16.73	0.047

Plot 2.1

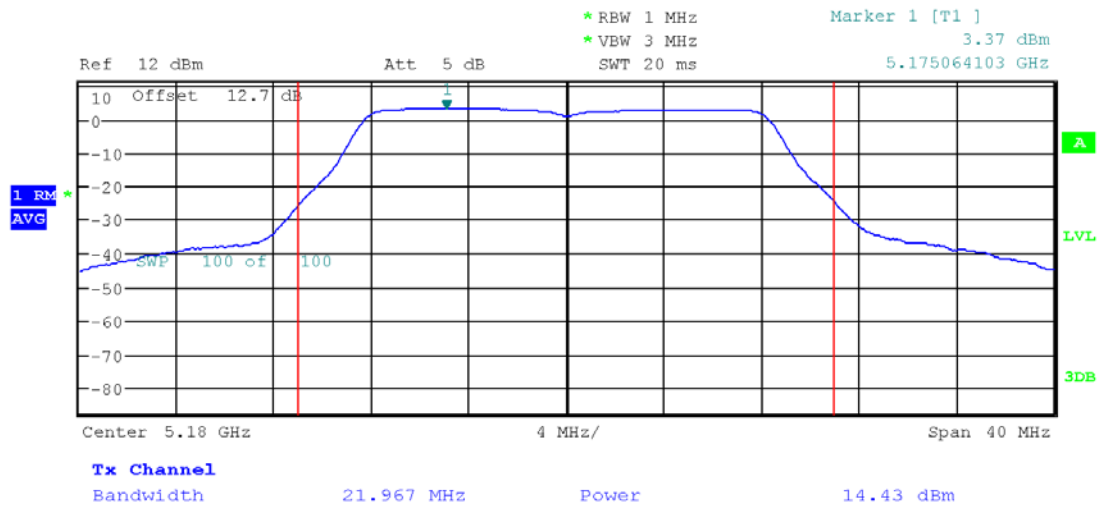

Plot 2.2

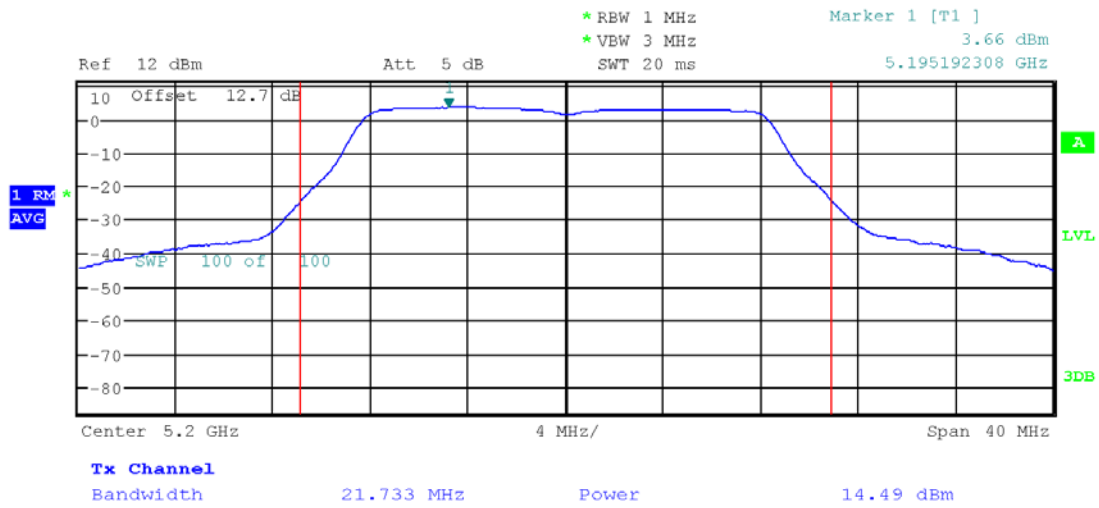

Plot 2.3

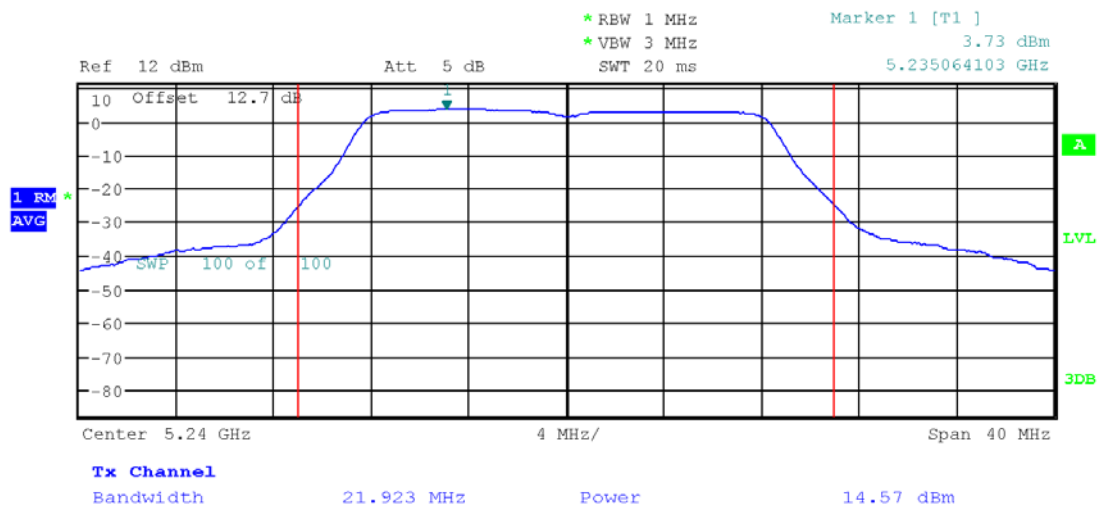

Plot 2.4

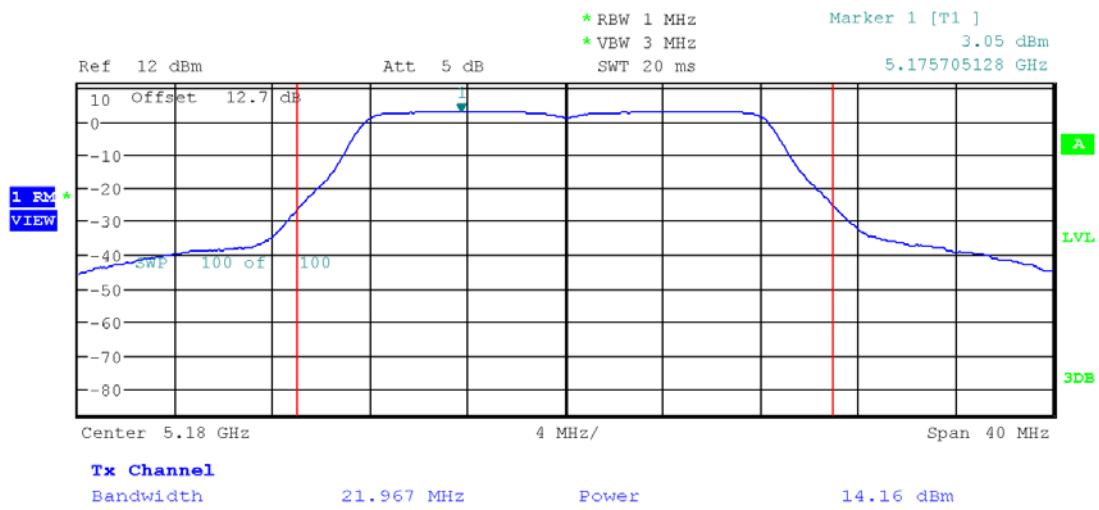

Plot 2.5

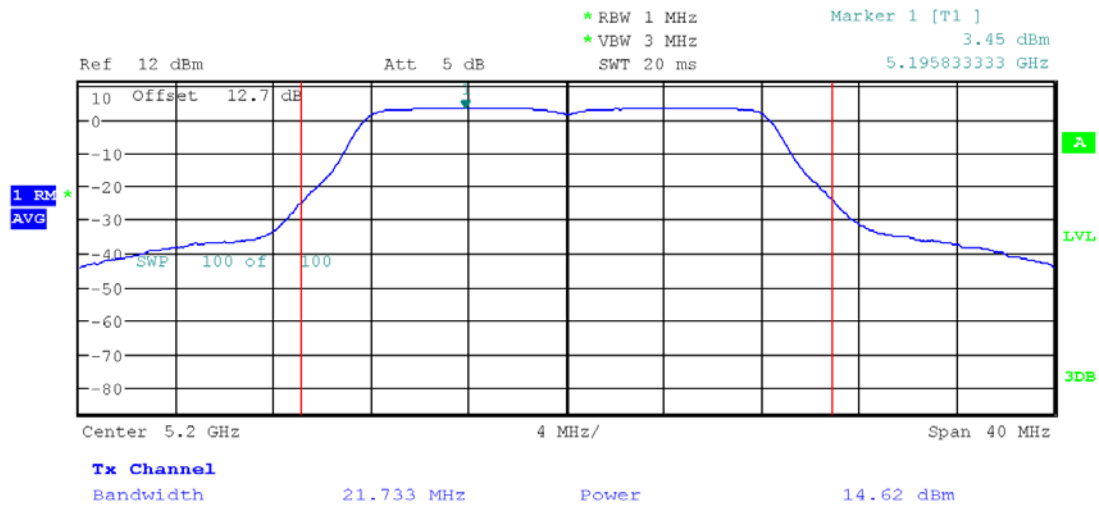

Plot 2.6

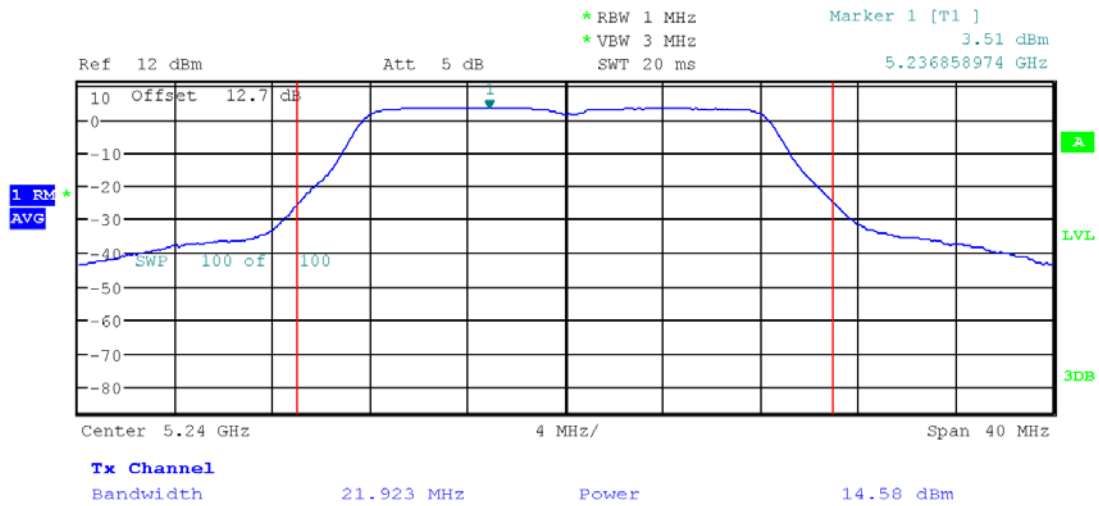

Plot 2. 7

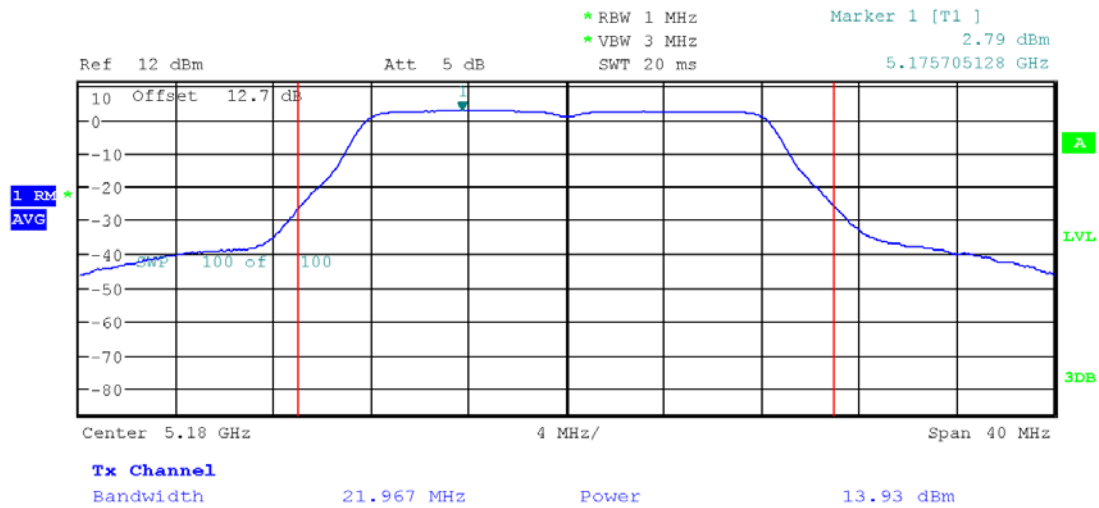

Plot 2. 8

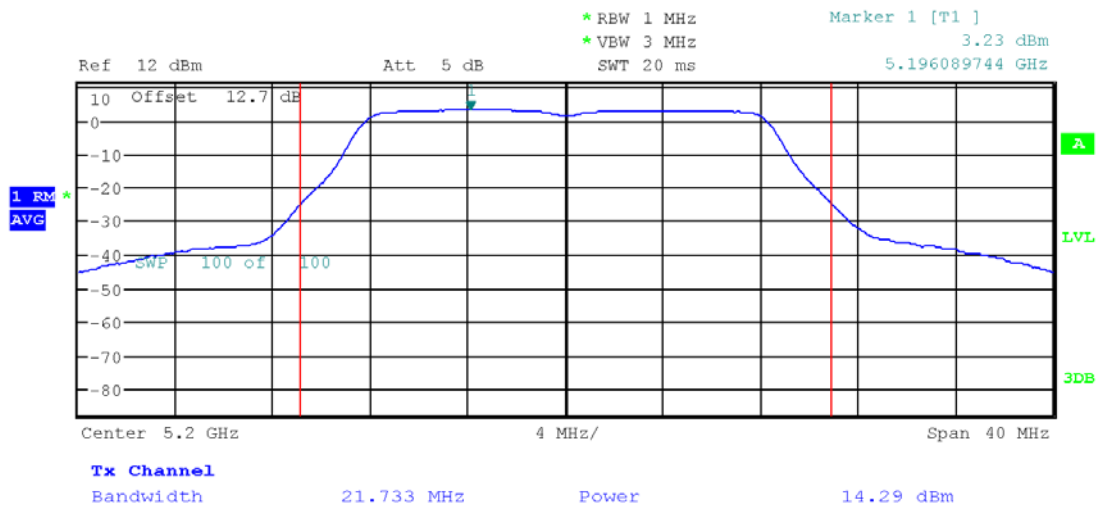

Plot 2. 9

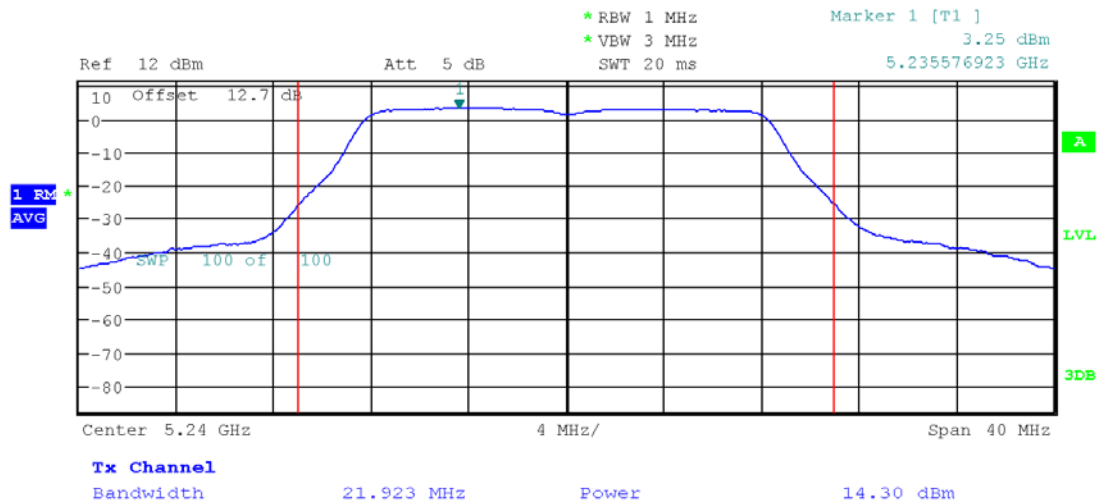

Plot 2. 10

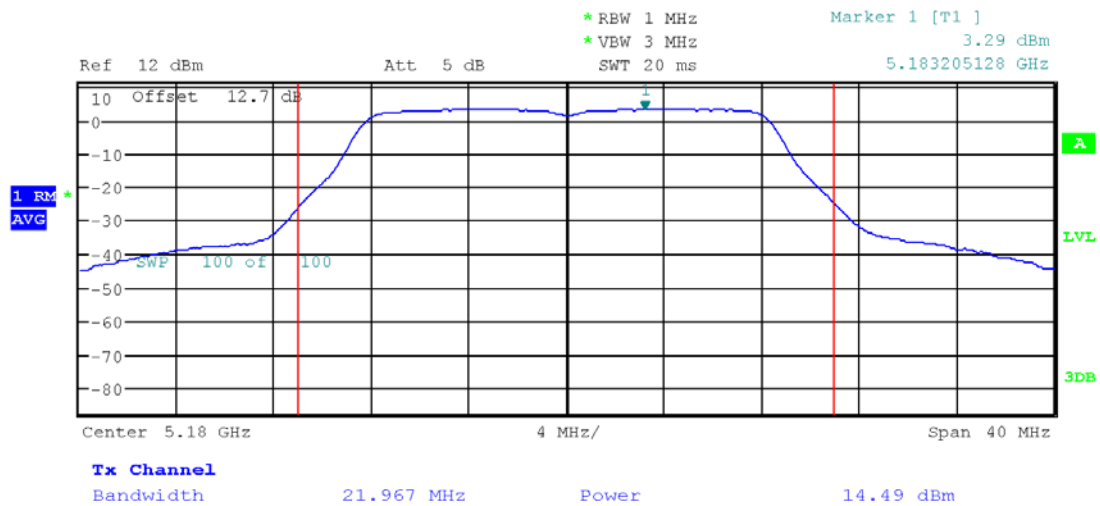

Plot 2. 11

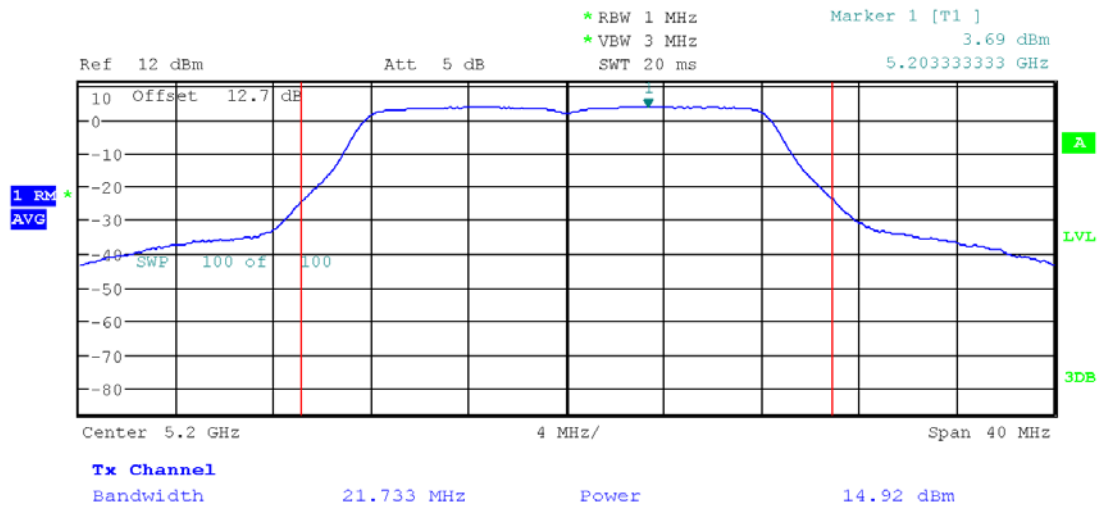

Plot 2. 12

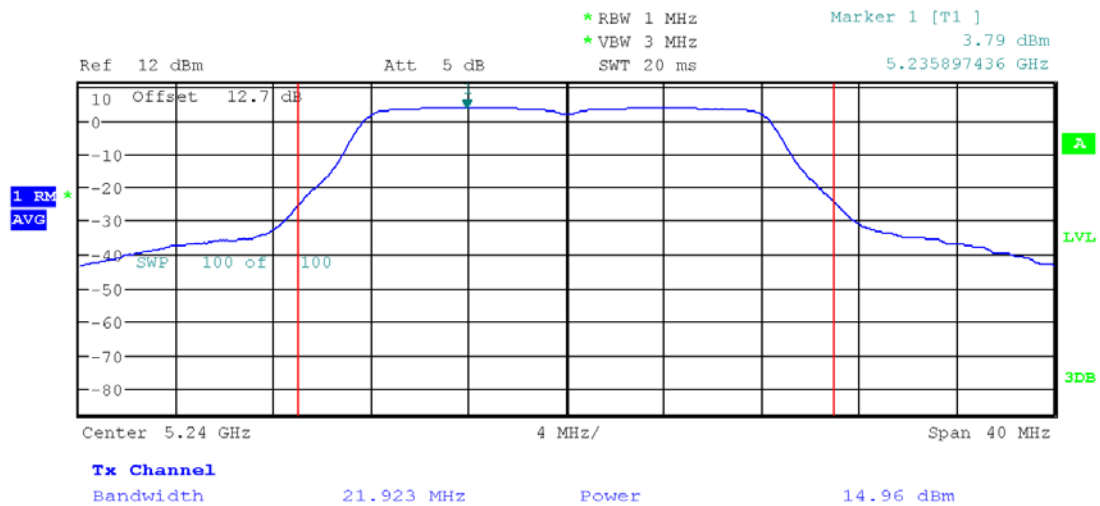

Plot 2. 13

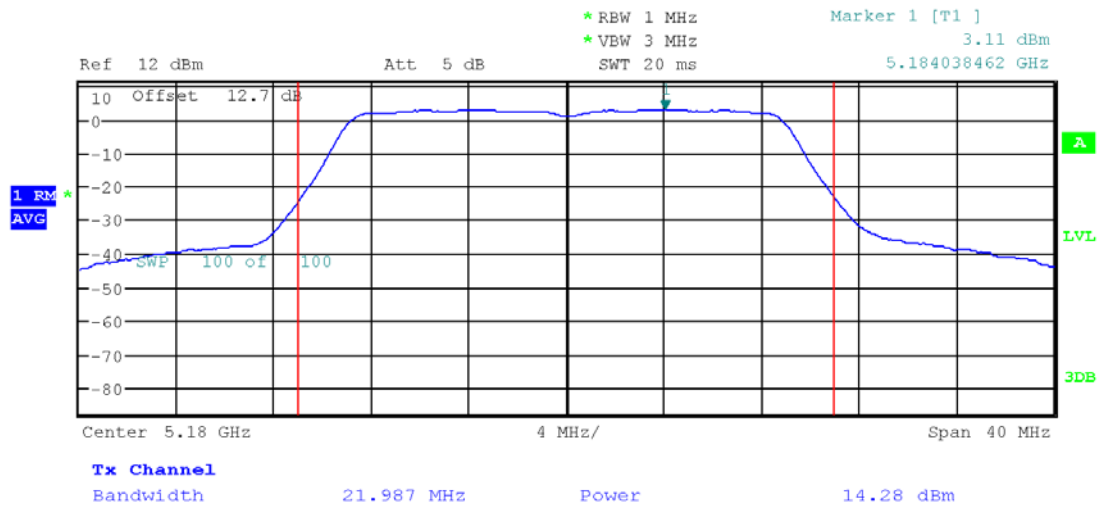

Plot 2. 14

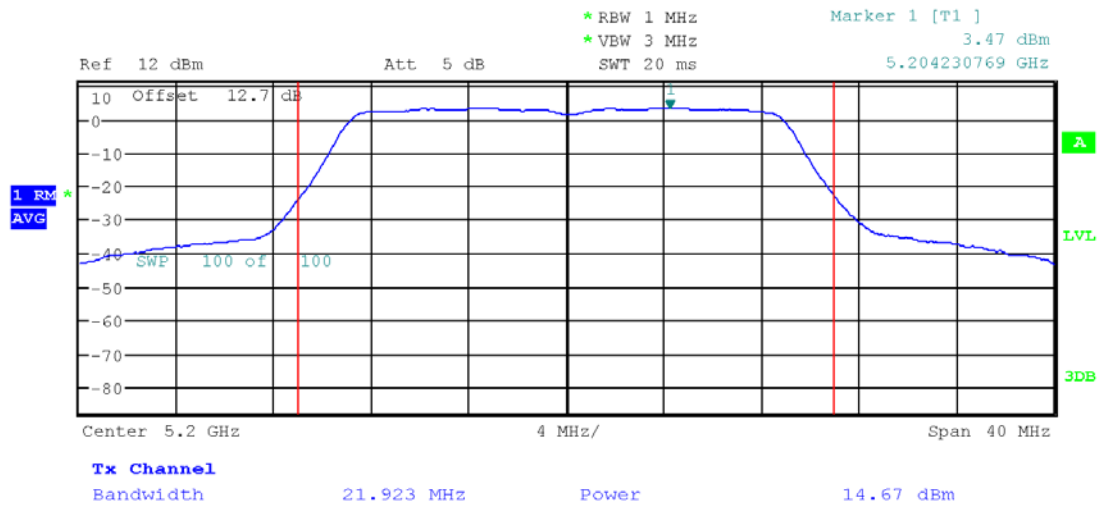

Plot 2. 15

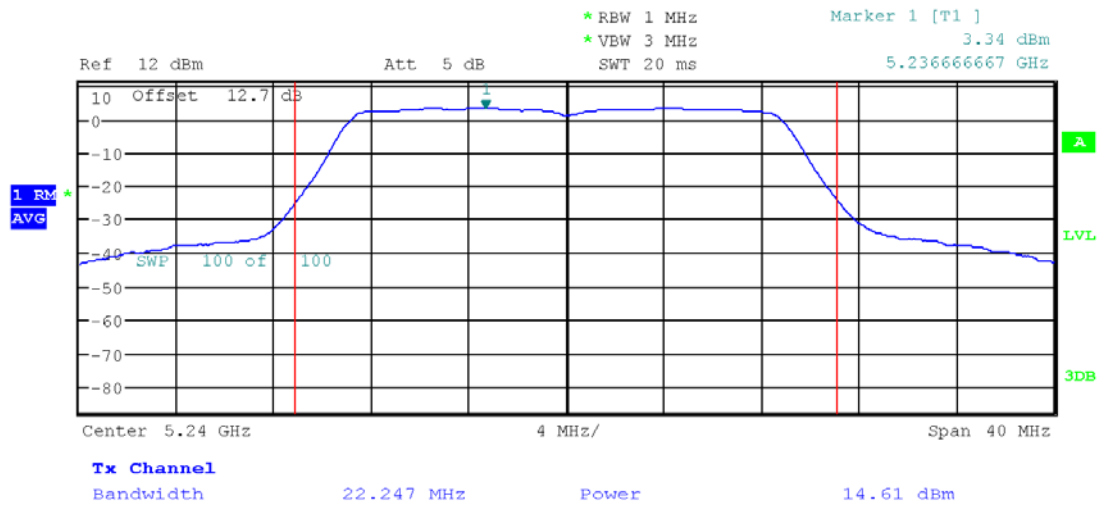

Plot 2. 16

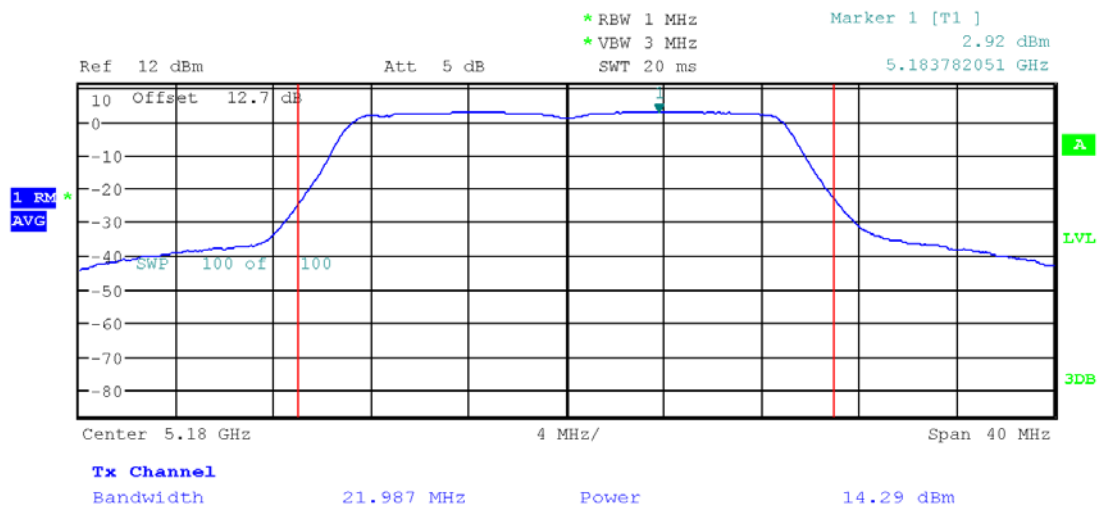

Plot 2. 17

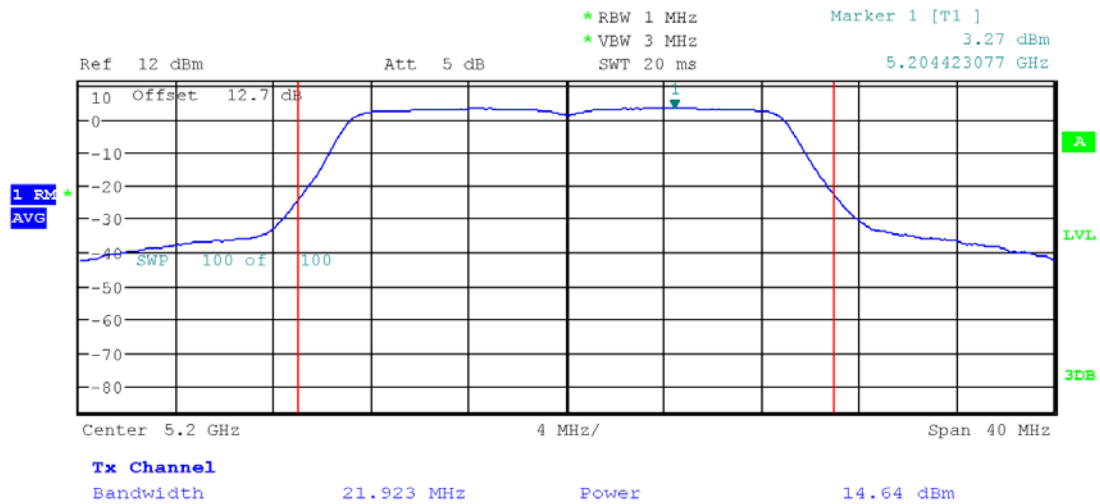

Plot 2. 18

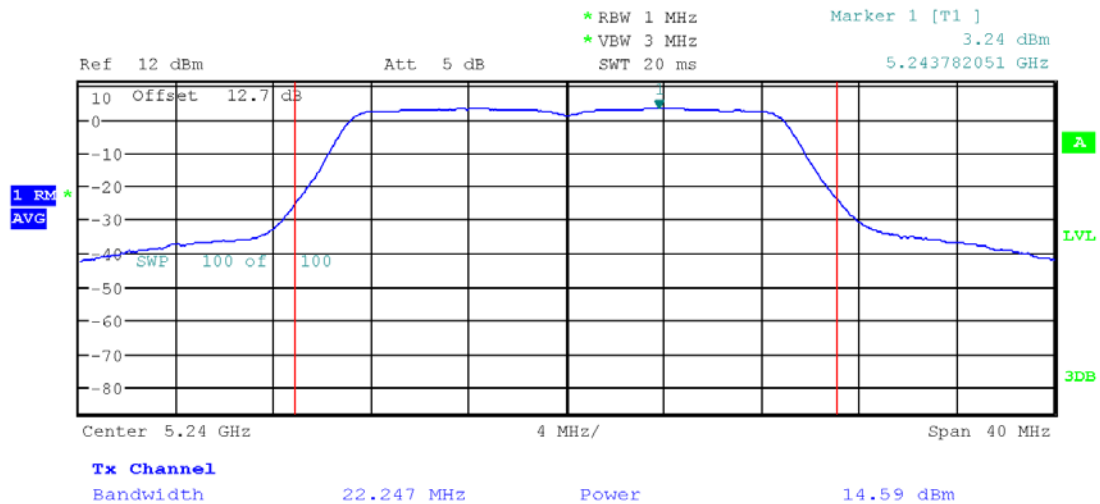

Plot 2. 19

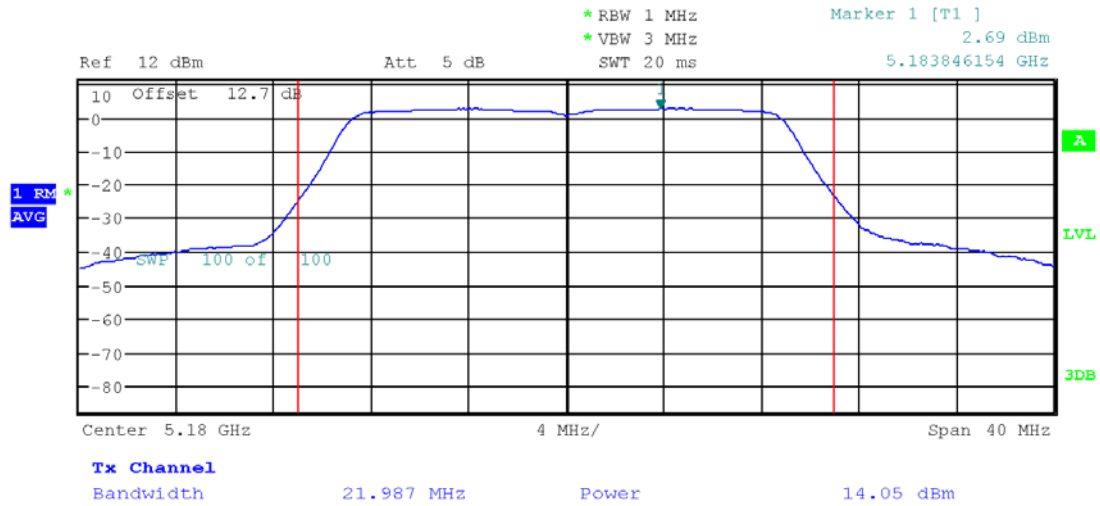

Plot 2. 20

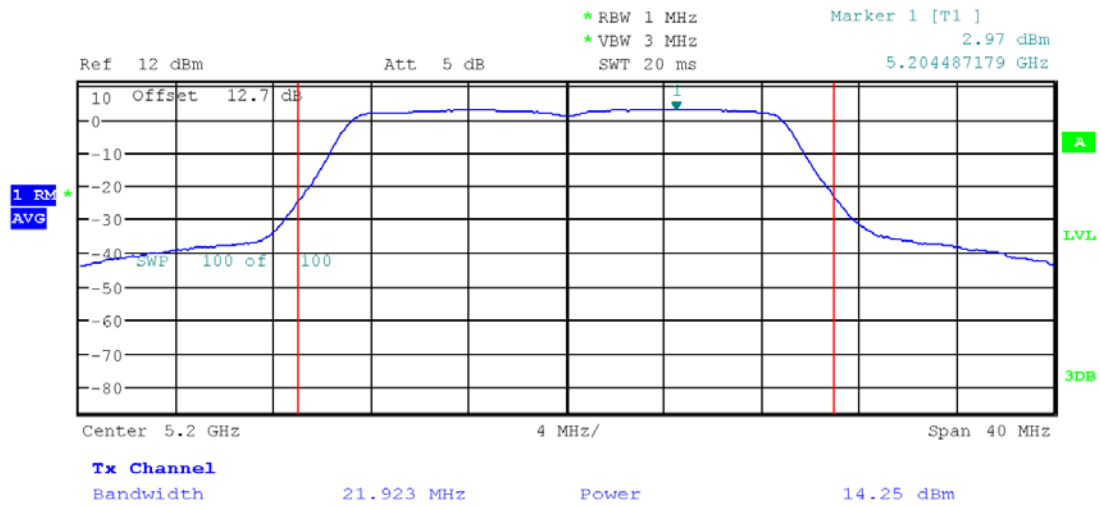

Plot 2. 21

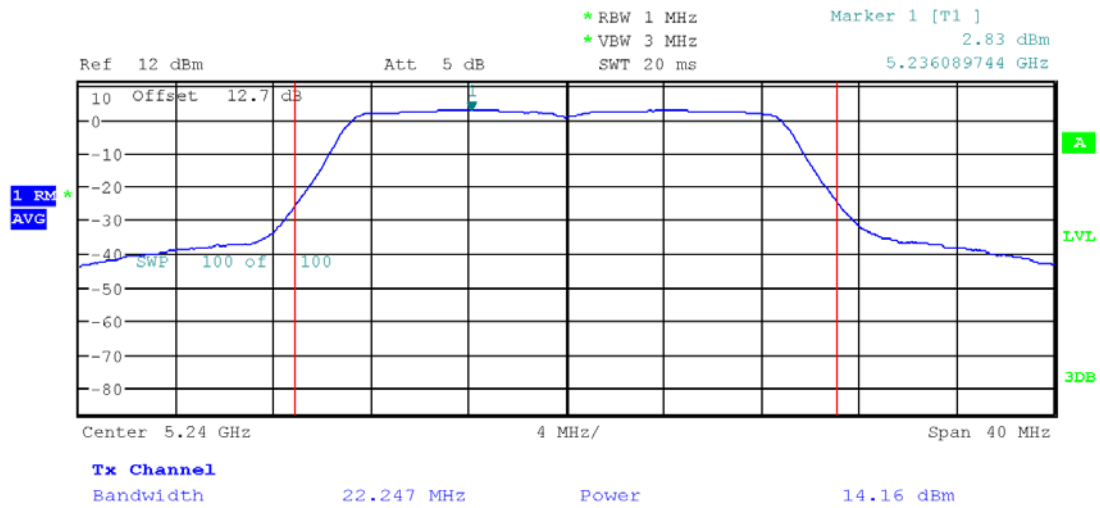

Plot 2. 22

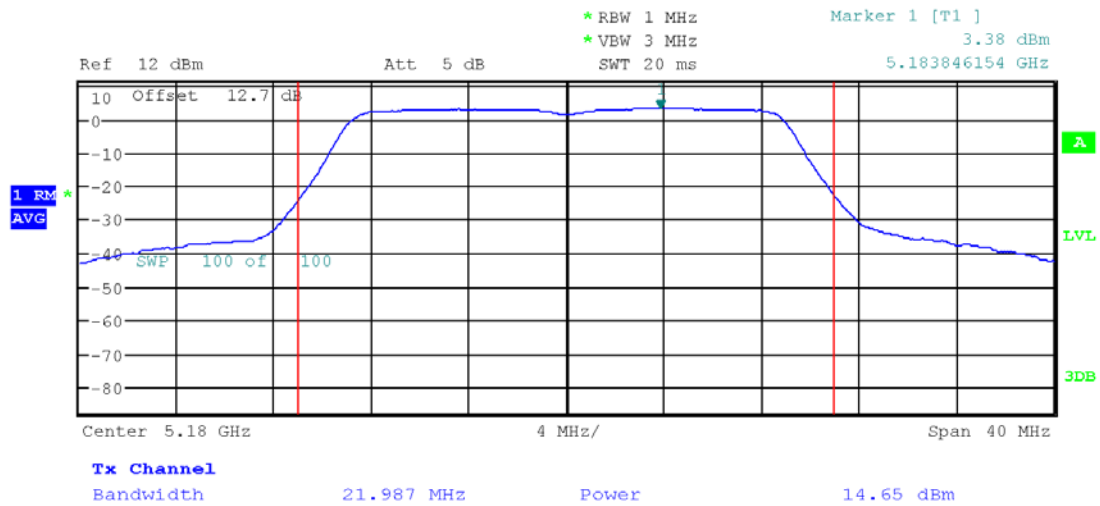

Plot 2. 23

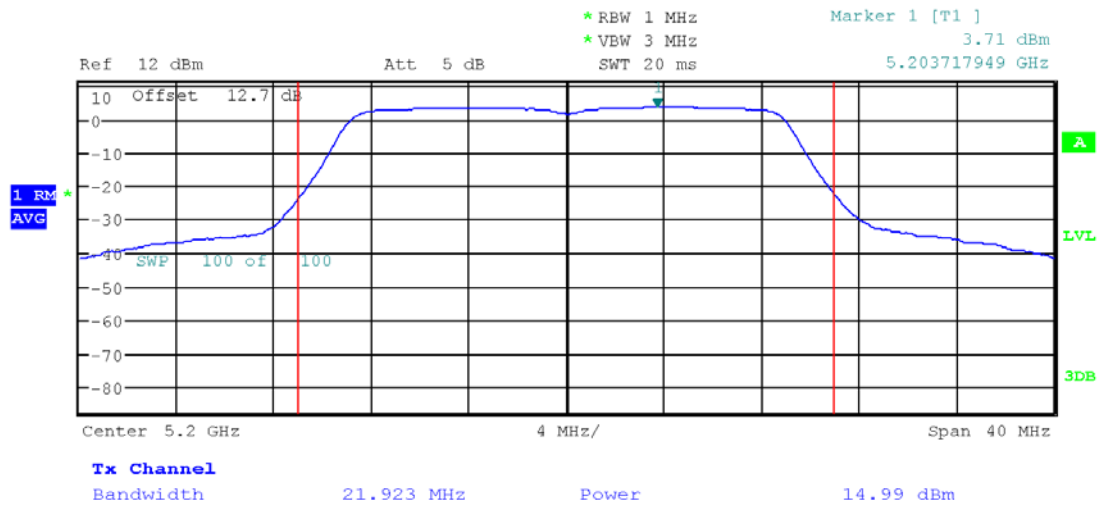

Plot 2. 24

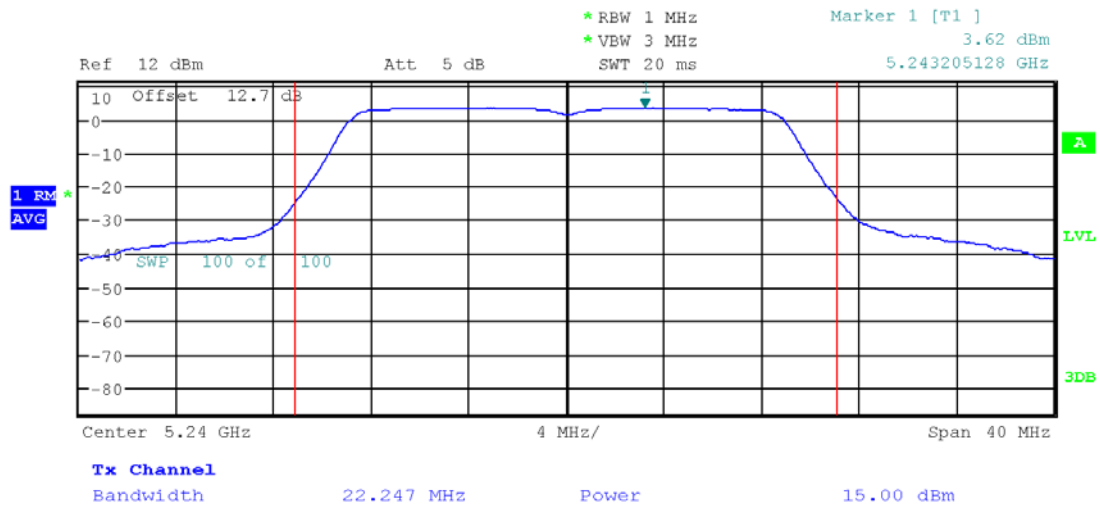

Plot 2. 25

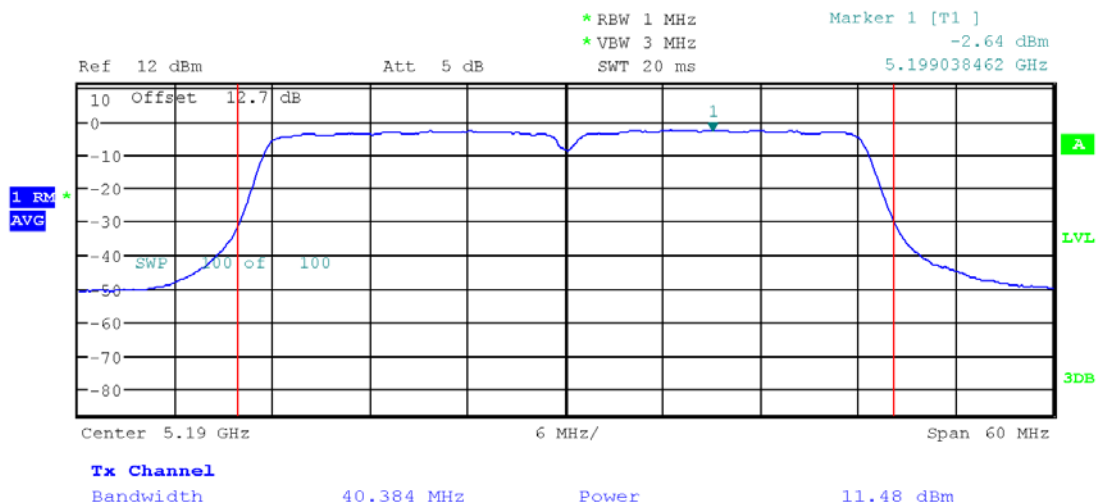

Plot 2. 26

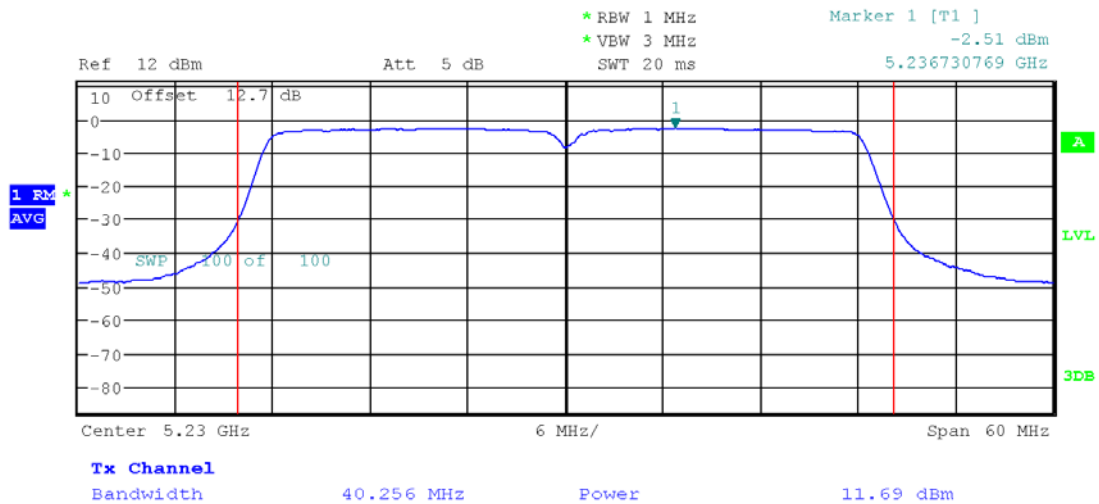

Plot 2. 27

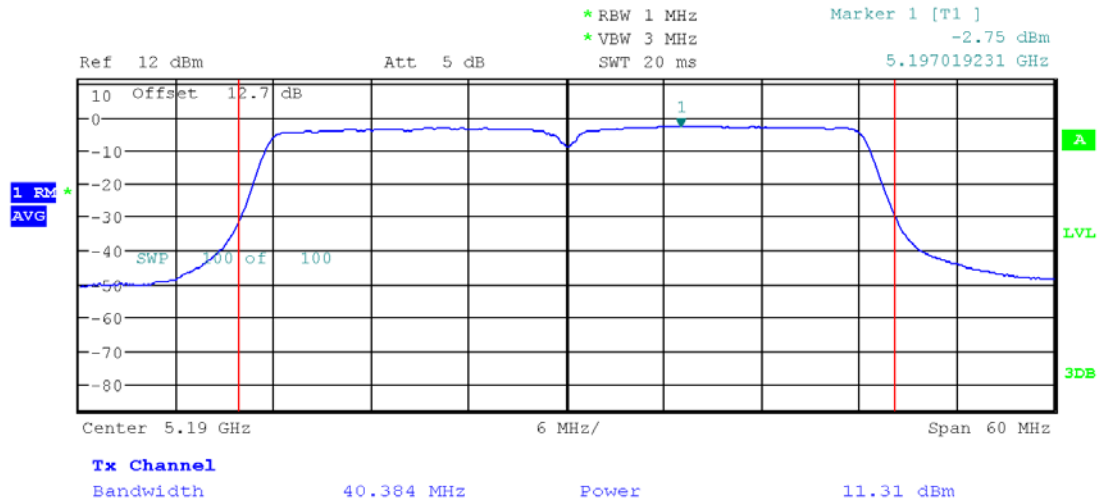

Plot 2. 28

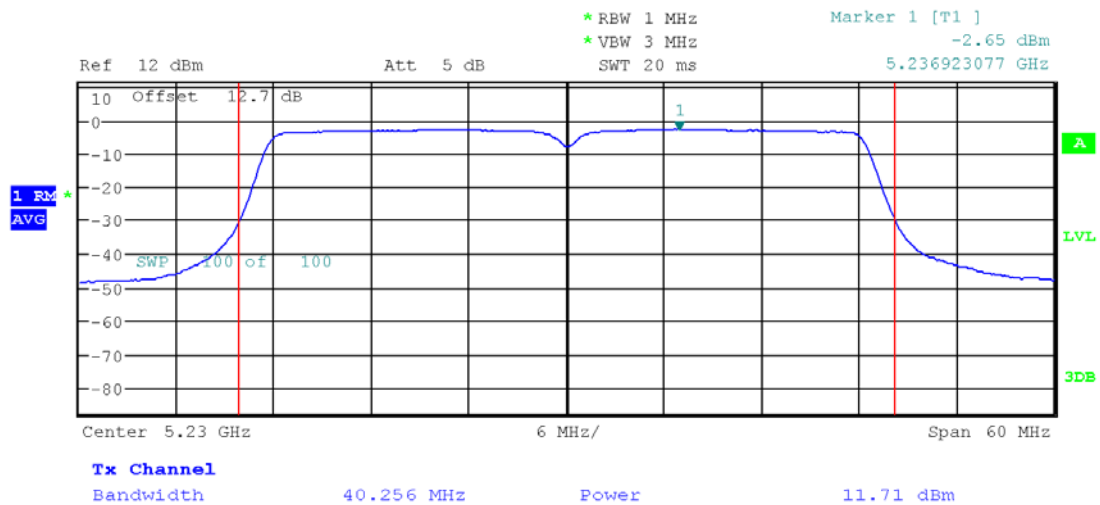

Plot 2. 29

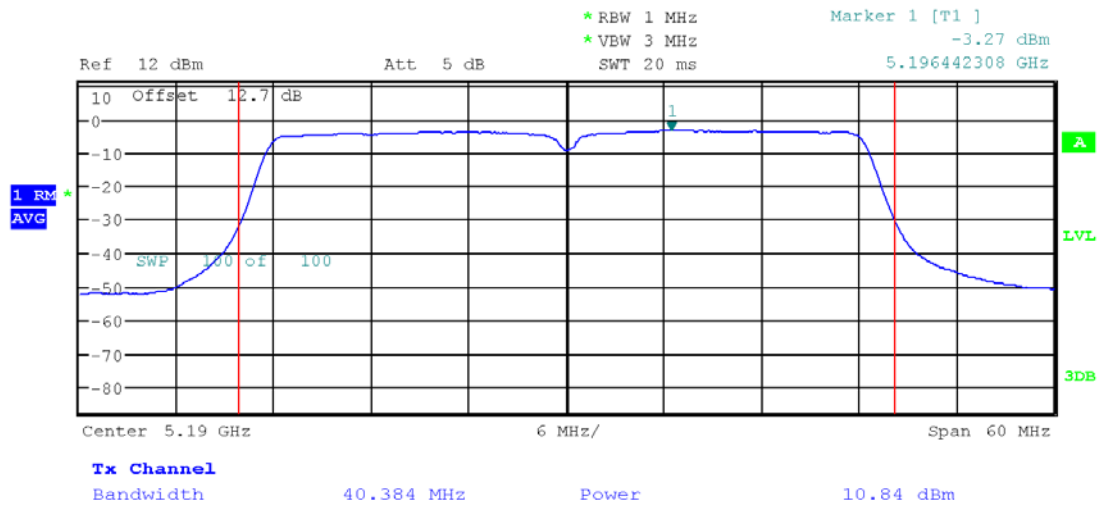

Plot 2. 30

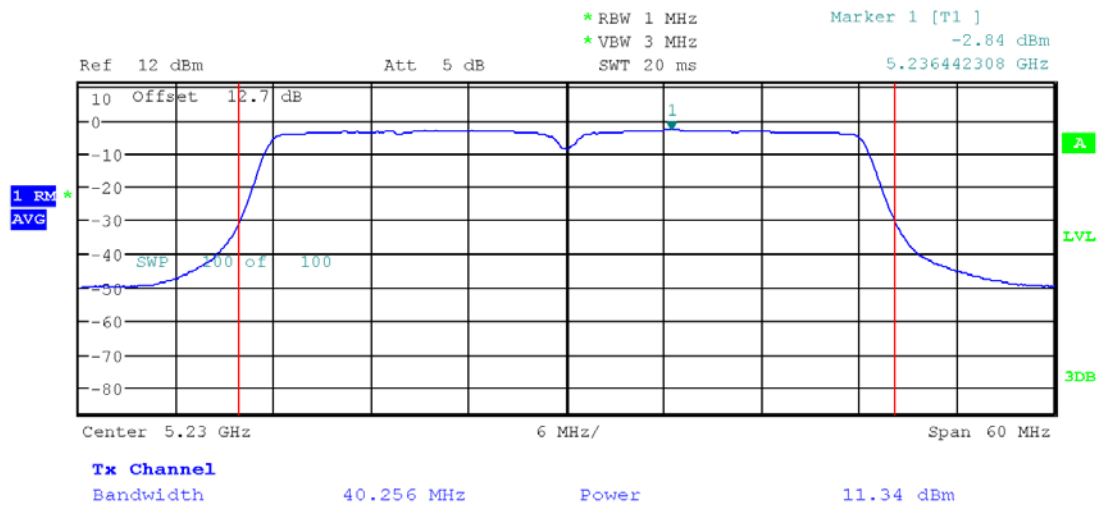

Plot 2. 31

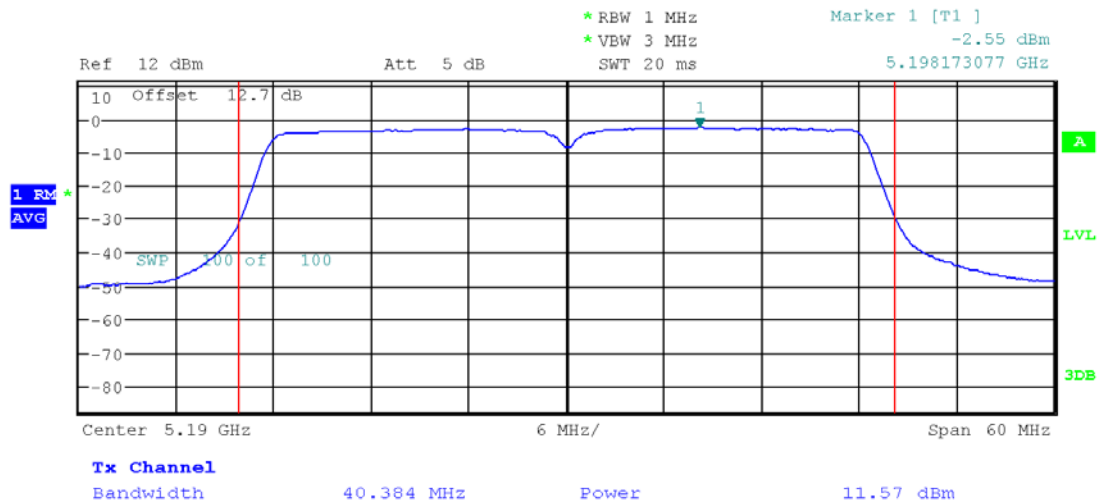

Plot 2. 32

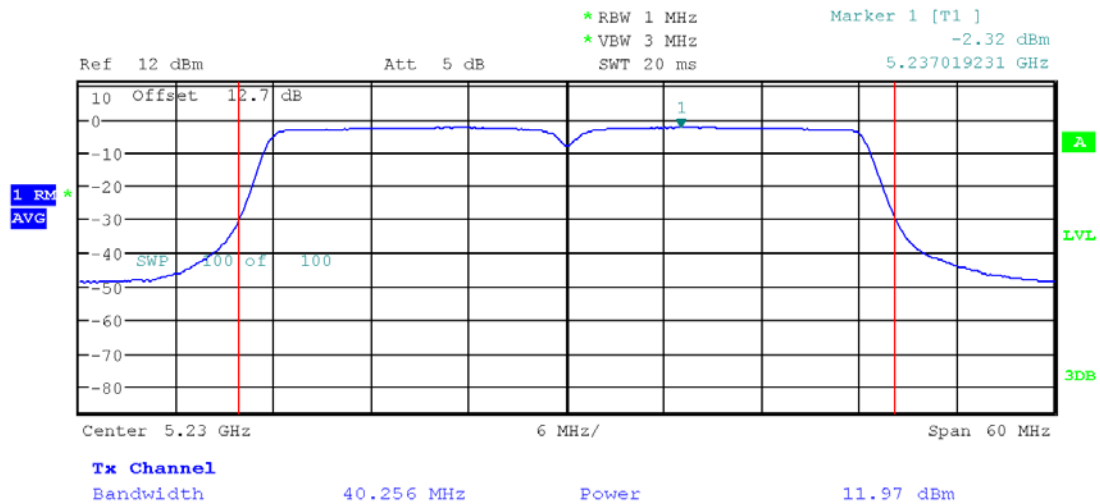

Plot 2. 33

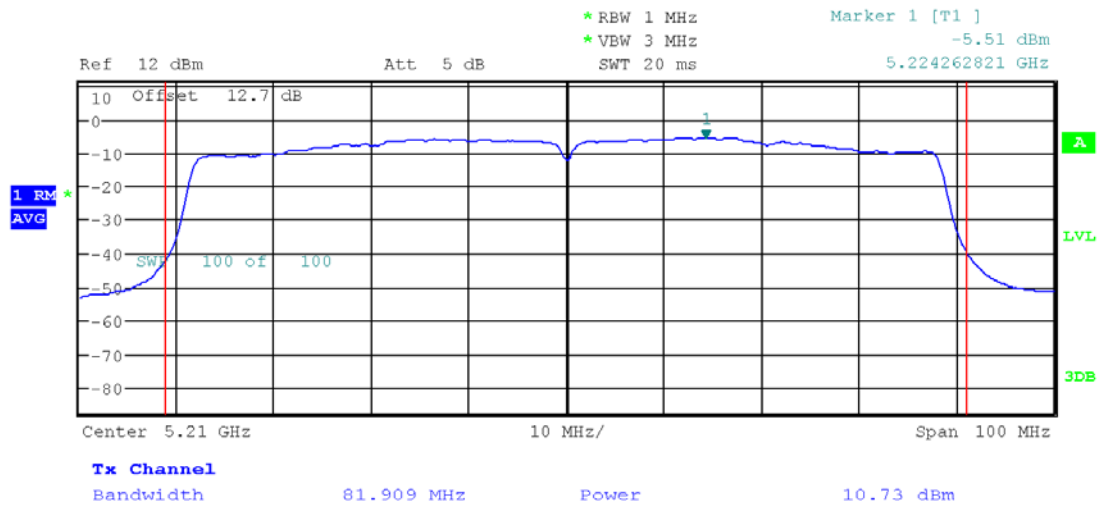

Plot 2. 34

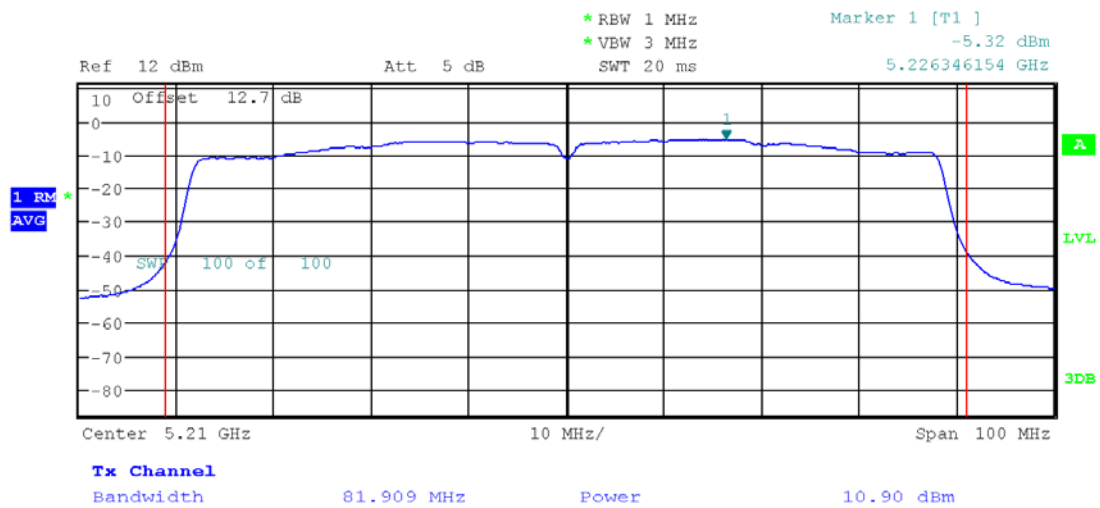

Plot 2. 35

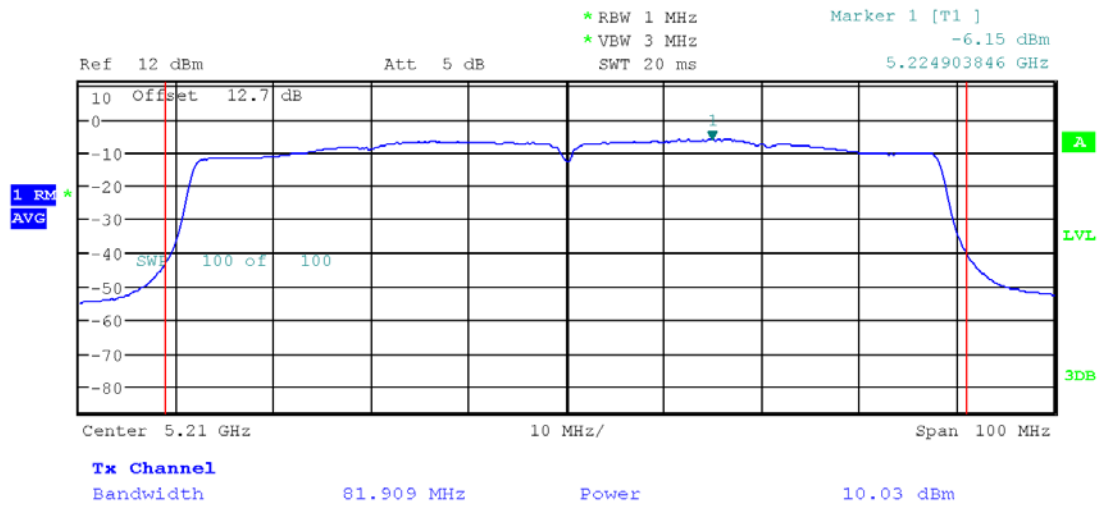

Plot 2. 36

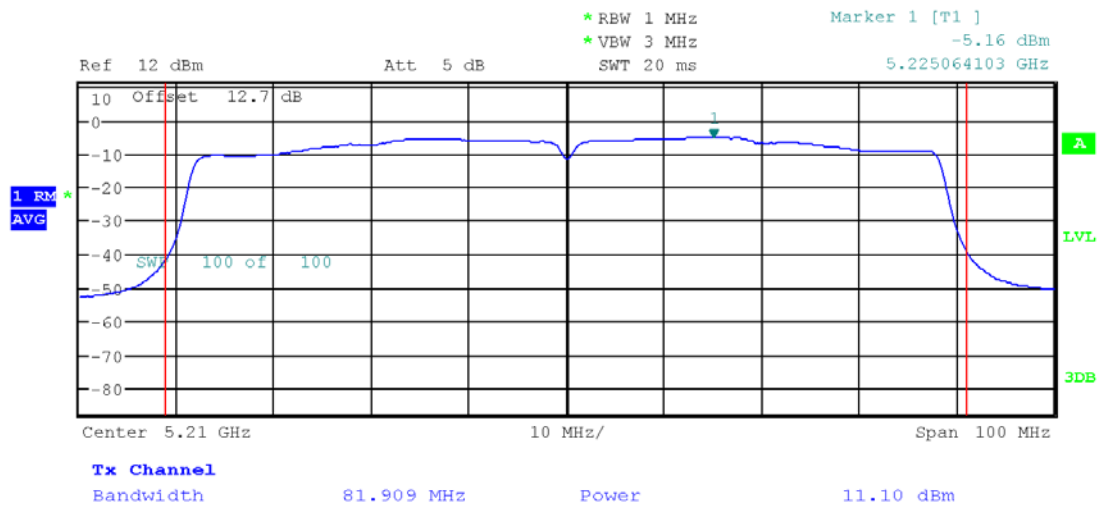

4.3 Peak Power Spectral Density
FCC Rule 15.407(a)(1)(ii)

4.3.1 Requirement

For an indoor access point operating in the band 5.15-5.25 GHz, the maximum conducted output power over the frequency band of operation shall not exceed 1 W provided the maximum antenna gain does not exceed 6 dBi. In addition, the maximum power spectral density shall not exceed 17 dBm in any 1 megahertz band. If transmitting antennas of directional gain greater than 6 dBi are used, both the maximum conducted output power and the maximum power spectral density shall be reduced by the amount in dB that the directional gain of the antenna exceeds 6 dBi.

4.3.2 Procedure

Each antenna port of the EUT was connected to the input of a spectrum analyzer to measure the Peak Power Spectral Density (PPSD) and recorded.

The Procedure, described in the FCC Publication 789033 D02 General U-NII Test Procedures New Rules v01r04, was used. Specifically procedure from Section F was utilized for Maximum Power Spectral Density (PSD).

Tested By:	Minh Ly
Test Date:	October 04, 2017

4.3.3 Test Result

Refer to the following plots for the test result

802.11a (6Mbps) – Peak Power Spectral Density

CH	Frequency MHz	Ant 0 – DB1 (dBm)	Plot #	Ant 1 – DB2 (dBm)	Plot #	Ant 2 – DB3 (dBm)	Plot #	Ant 3 – DB4 (dBm)	Plot #
36	5180	3.37	2.1	3.05	2.4	2.79	2.7	3.29	2.10
40	5200	3.66	2.2	3.45	2.5	3.23	2.8	3.69	2.11
48	5240	3.73	2.3	3.51	2.6	3.25	2.9	3.79	2.12

* Worse-case margin to 17dBm limit: -13.21dBm

802.11n 20MHz (MCS0) –Power Spectral Density

CH	Frequency MHz	Ant 0 – DB1 (dBm)	Plot #	Ant 1 – DB2 (dBm)	Plot #	Ant 2 – DB3 (dBm)	Plot #	Ant 3 – DB4 (dBm)	Plot #
36	5180	3.11	2.13	2.92	2.16	2.69	2.19	3.38	2.22
40	5200	3.47	2.14	3.27	2.17	2.97	2.20	3.71	2.23
48	5240	3.34	2.15	3.24	2.18	2.83	2.21	3.62	2.24

802.11n 40MHz (MCS0) –Power Spectral Density

CH	Frequency MHz	Ant 0 – DB1 (dBm)	Plot #	Ant 1 – DB2 (dBm)	Plot #	Ant 2 – DB3 (dBm)	Plot #	Ant 3 – DB4 (dBm)	Plot #
38	5190	-2.64	2.25	-2.75	2.27	-3.27	2.29	-2.55	2.31
46	5230	-2.51	2.26	-2.65	2.28	-2.84	2.30	-2.32	2.32

802.11n 40MHz (MCS0) –Power Spectral Density

CH	Frequency MHz	Ant 0 – DB1 (dBm)	Plot #	Ant 1 – DB2 (dBm)	Plot #	Ant 2 – DB3 (dBm)	Plot #	Ant 3 – DB4 (dBm)	Plot #
42	5210	-5.51	2.33	-5.32	2.34	-6.15	2.35	-5.16	2.36

MIMO - Power Spectral Density

CH	Frequency (MHz)	Summed PSD (dBm)	Limit (dBm)	Margin (dB)
802.11a				
36	5180	9.15	17	-7.85
40	5200	9.53	17	-7.47
48	5240	9.60	17	-7.40
802.11n 20MHz				
36	5180	9.05	17	-7.95
40	5200	9.38	17	-7.62
48	5240	9.29	17	-7.71
802.11n 40MHz				
38	5190	3.23	17	-13.77
46	5230	3.44	17	-13.56
802.11ac 80MHz				
42	5210	0.50	17	-16.50

4.4 Frequency stability
FCC 15.407(g)

4.4.1 Requirement

Manufacturers of U-NII devices are responsible for ensuring frequency stability such that an emission is maintained within the band of operation under all conditions of normal operation as specified in the user's manual.

4.4.2 Procedure

The EUT was placed in a temperature chamber and setup to transmit. Procedures for frequency stability in ANSIC63.10:2013 section 6.8 was utilized.

The carrier frequency was measured with the spectrum analyzer with resolution bandwidth of 1 kHz for lower band edge measurement. For upper band edge, 99% occupied bandwidth was used. The temperature was varied from 0°C to 50°C, as declared by manufacturer.

The EUT in this report is powered by 120.0VAC which was varied to 85% and 115% for testing. Testing was performed at a temperature of 20°C.

After the temperature stabilized for approximately 20 minutes, the transmitting frequency was measured.

Tested By:	Anderson Soungpanya
Test Date:	September 29, 2017

4.4.3 Result

Temperature, °C	-26dB Band Edge at nominal voltage, (MHz)	Maximum deviation from frequency at 20°C, ppm
Nominal Frequency: 5180 MHz		
50	5170.509946	3.707
40	5170.519764	2.877
30	5170.504487	4.653
20	5170.558846	0.000
10	5170.464744	3.675
0	5170.584615	3.069
Voltage at 20°C	-26dB Band Edge at nominal voltage, (MHz)	Maximum deviation from frequency at 20°C, ppm
120V – 15%	5170.526667	1.188
120V + 15%	5170.524559	1.661

Temperature, °C	99% Occupied Bandwidth Upper Band Edge, (MHz)
Nominal Frequency: 5180MHz	
50	5248.730000
40	5248.700000
30	5248.730000
20	5248.740000
10	5248.760000
0	5248.750000
Voltage at 20°C	99% Occupied Bandwidth Upper Band Edge, (MHz)
120V – 15%	5248.740000
120V + 15%	5248.730000

4.5 Transmitter Radiated Emissions FCC Rule 15.407(b) (1-8) 15.209, 15.205

4.5.1 Requirement

(b) Undesirable emission limits. Except as shown in paragraph (b) (7) of this section, the maximum emissions outside of the frequency bands of operation shall be attenuated in accordance with the following limits:

- (1) For transmitters operating in the 5.15-5.25 GHz band: All emissions outside of the 5.15-5.35 GHz band shall not exceed an e.i.r.p. of -27 dBm/MHz.
- (2) For transmitters operating in the 5.25-5.35 GHz band: All emissions outside of the 5.15-5.35 GHz band shall not exceed an e.i.r.p. of -27 dBm/MHz.
- (3) For transmitters operating in the 5.47-5.725 GHz band: All emissions outside of the 5.47-5.725 GHz band shall not exceed an e.i.r.p. of -27 dBm/MHz.
- (4) For transmitters operating in the 5.725-5.85 GHz band:
 - (i) All emissions shall be limited to a level of -27 dBm/MHz at 75 MHz or more above or below the band edge increasing linearly to 10 dBm/MHz at 25 MHz above or below the band edge, and from 25 MHz above or below the band edge increasing linearly to a level of 15.6 dBm/MHz at 5 MHz above or below the band edge, and from 5 MHz above or below the band edge increasing linearly to a level of 27 dBm/MHz at the band edge.
- (5) The emission measurements shall be performed using a minimum resolution bandwidth of 1 MHz. A lower resolution bandwidth may be employed near the band edge, when necessary, provided the measured energy is integrated to show the total power over 1 MHz.
- (6) Unwanted emissions below 1 GHz must comply with the general field strength limits set forth in §15.209. Further, any U-NII devices using an AC power line are required to comply also with the conducted limits set forth in §15.207.
- (7) The provisions of §15.205 apply to intentional radiators operating under this section.
- (8) When measuring the emission limits, the nominal carrier frequency shall be adjusted as close to the upper and lower frequency band edges as the design of the equipment permits.

Emissions which fall in the restricted bands, as defined in §15.205(a), must comply with the radiated emission limits specified in §15.209(a) (see §15.205(c)).

For transmitters operating in the 5.15–5.25 GHz band: all emissions outside of the 5.15–5.35 GHz band shall not exceed an EIRP of -27 dBm/MHz.

Note: An out-of-band emission that complies with both the average and peak limits of Section 15.209 is not required to satisfy the -27 dBm/MHz peak emission limit.

4.5.2 Procedure

Radiated emission measurements were performed from 30 MHz to 40 GHz according to the procedure described in ANSIC64.10. Spectrum Analyzer Resolution Bandwidth is 100 kHz or greater for frequencies 30 MHz to 1000 MHz, 1 MHz for frequencies above 1000 MHz. Above 1000 MHz Peak and Average measurements were performed.

The EUT is placed on a plastic turntable that is 80 cm in height for below 1000MHz and 1.5m in height for above 1GHz. If the EUT attaches to peripherals, they are connected and operational (as typical as possible). During testing, all cables were manipulated to produce worst-case emissions. The signal is maximized through rotation. The antenna height and polarization are varied during the search for maximum signal level. The antenna height is varied from 1 to 4 meters.

Radiated emissions are taken at 1 meter for Band Edge measurements. Radiated spurious emissions are taken at 3 meters for frequencies above 1 GHz and at 10 meters for frequencies below 1 GHz.

The 2.4GHz and 5GHz radio can transmit simultaneously; both of the transmitters are turned on during spurious emission to investigate for inter-modulation emission. Measurements made from 1 GHz to 18 GHz had a 2.4-2.5GHz and 5GHz (U-NII 1 & U-NII 3 band respectively) notch filter in place. A preamp was used from 30MHz to 40GHz.

All measurements were made with a Peak Detector and compared to QP limits for 30MHz – 1GHz and Average limits for 1GHz – 40 GHz.

Data is included of the worst-case configuration (the configuration which resulted in the highest emission levels).

4.5.3 Field Strength Calculation

Field Strength Calculation

The field strength is calculated by adding the Antenna Factor and Cable Factor, and subtracting the Amplifier Gain (if any) from the measured reading. The basic equation with a sample calculation is as follows:

$FS = RA + AF + CF - AG$; if measurement is performed at a distance other than specified in the rule, a Distance Correction Factor (DCF) shall be added.

Where FS = Field Strength in dB(μ V/m)

RA = Receiver Amplitude (including preamplifier) in dB(μ V); AF = Antenna Factor in dB(1/m)

CF = Cable Attenuation Factor in dB; AG = Amplifier Gain in dB

Assume a receiver reading of 52.0 dB(μ V) is obtained. The antennas factor of 7.4 dB(1/m) and cable factor of 1.6 dB is added. The amplifier gain of 29 dB is subtracted, giving field strength of 32 dB(μ V/m). This value in dB(μ V/m) was converted to its corresponding level in μ V/m.

RA = 52.0 dB(μ V)

AF = 7.4 dB(1/m)

CF = 1.6 dB

AG = 29.0 dB

FS = $52.0 + 7.4 + 1.6 - 29.0 = 32$ dB(μ V/m).

Level in μ V/m = Common Antilogarithm [$(32 \text{ dB}\mu\text{V/m})/20$] = 39.8 μ V/m.

4.5.4 Test Results

The data on the following pages list the significant emission frequencies, the limit and the margin of compliance where emissions are within 3dB of the limit.

Radiated emission measurements were performed up to 40GHz. No Emissions were identified when scanned from 18-40 GHz.

Test Results: 15.209/15.205 Restricted Band Emissions

Tested By:	Minh Ly
Test Date:	September 26 – October 10, 2017

Out-of-Band Spurious Emissions at the Band Edge @1m Distance 802.11a, 5180 MHz

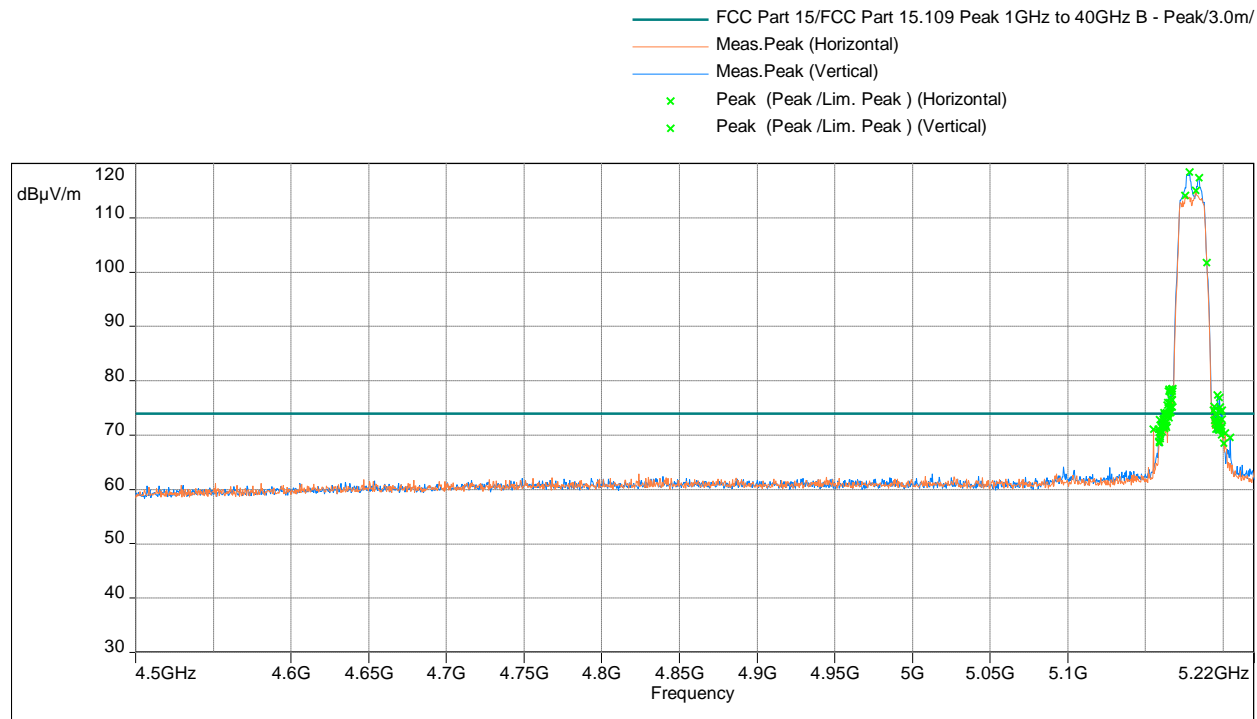

- FCC Part 15/FCC Part 15.109 30M-40GHz B - Average/3.0m/
- Meas.Peak (Horizontal)
- Meas.Peak (Vertical)
- × Peak (Peak /Lim. Average) (Horizontal)
- × Peak (Peak /Lim. Average) (Vertical)

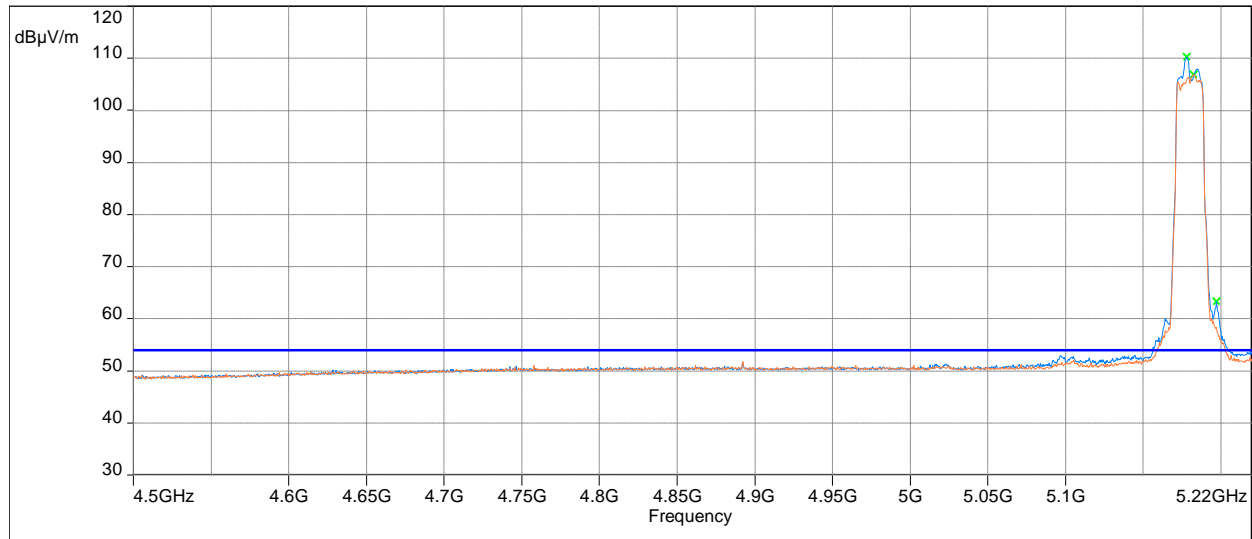

Model: ; Client: ; Comments: ; Test Date: 10/03/2017 08:51

Frequency (MHz)	Average (dBµV/m)	Lim. Avg (dBµV/m)	Margin (dB)	Height (m)	Angle (°)	Polarization	Correction (dB)
5149.905	52.2	54.0	-1.8	1.5	132.5	Horizontal	32.8
5098.522	53.7	54.0	-0.3	1.7	131.8	Vertical	32.6
5137.112	53.2	54.0	-0.8	1.6	131.8	Vertical	32.7
5150.000	53.3	54.0	-0.7	1.6	132.0	Vertical	32.8

Out-of-Band Spurious Emissions at the Band Edge @1m Distance 802.11 n 20MHz, 5180 MHz

- FCC Part 15/FCC Part 15.109 Peak 1GHz to 40GHz B - Peak/3.0m/
- Meas.Peak (Horizontal)
- Meas.Peak (Vertical)
- x Peak (Peak /Lim. Peak) (Horizontal)
- x Peak (Peak /Lim. Peak) (Vertical)

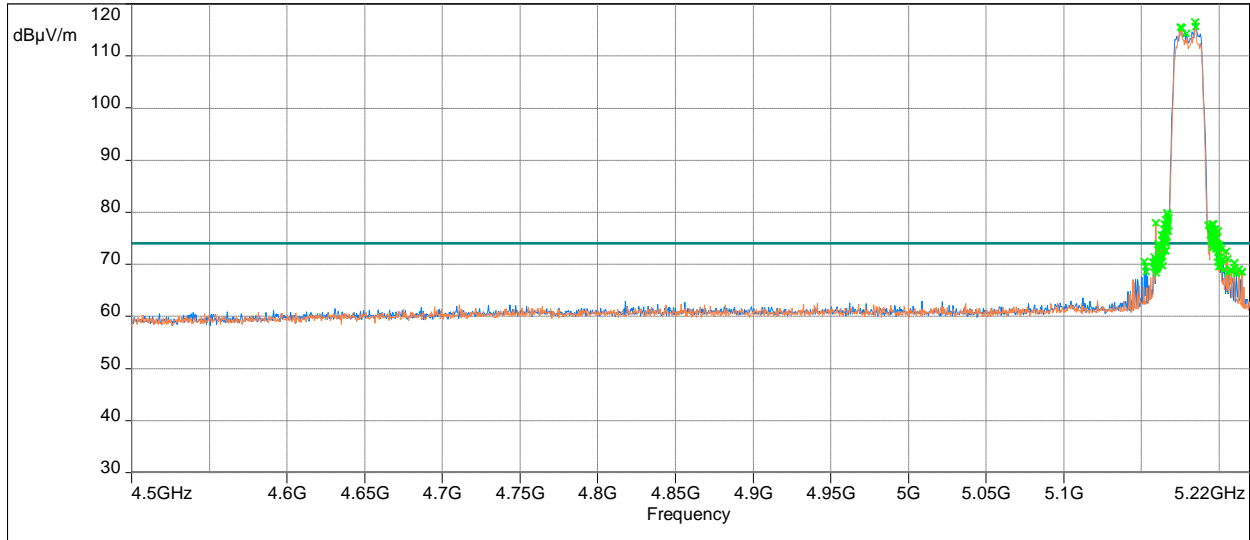

Model: ; Client: ; Comments: ; Test Date: 10/03/2017 09:49

- FCC Part 15/FCC Part 15.109 30M-40GHz B - Average/3.0m/
- Meas.Peak (Horizontal)
- Meas.Peak (Vertical)
- × Meas.CISPR.AVG (Max Hold Manual meas.) (Horizontal)
- × Meas.CISPR.AVG (Max Hold Manual meas.) (Vertical)

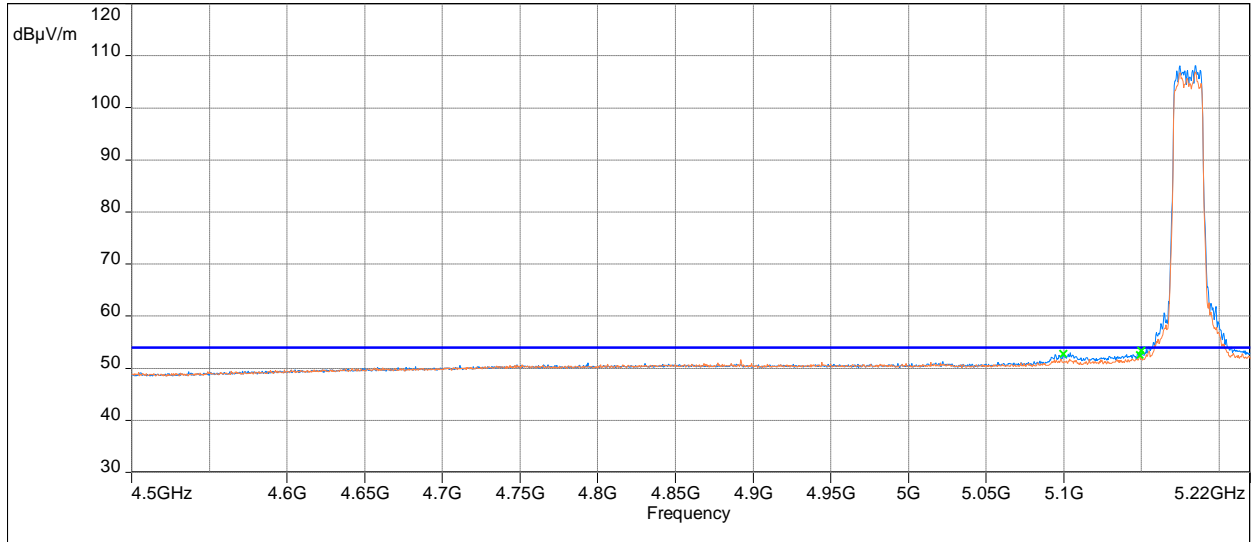

Model: ; Client: ; Comments: ; Test Date: 10/03/2017 09:10

Frequency (MHz)	Average (dBµV/m)	Lim. Avg (dBµV/m)	Margin (dB)	Height (m)	Angle (°)	Polarization	Correction (dB)
5148.909	52.5	54.0	-1.5	1.7	148.3	Horizontal	32.8
5099.193	52.8	54.0	-1.2	1.6	148.3	Vertical	32.6
5150.000	53.3	54.0	-0.7	1.6	148.5	Vertical	32.8

**Out-of-Band Spurious Emissions at the Band Edge @1m Distance
802.11n 40MHz, 5190 MHz**

- FCC Part 15/FCC Part 15.109 Peak 1GHz to 40GHz B - Peak/3.0m/
- ◊ Level (Manual suspects) (Vertical)
- Meas.Peak (Horizontal)
- Meas.Peak (Vertical)
- × Peak (Peak /Lim. Peak) (Horizontal)
- × Peak (Peak /Lim. Peak) (Vertical)

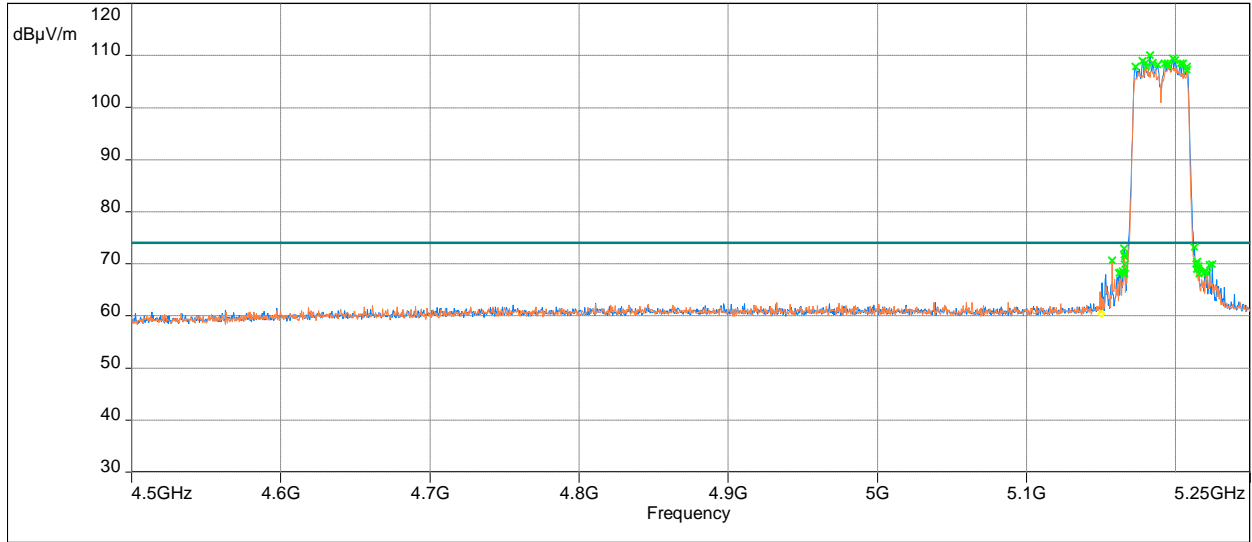

Model: ; Client: ; Comments: ; Test Date: 10/05/2017 10:08

Frequency (MHz)	Peak (dBµV/m)	Lim. PK (dBµV/m)	Margin (dB)	Height (m)	Angle (°)	Polarization	Correction (dB)
5150.000	60.36	74.0	-13.6	1.5	123.0	Vertical	32.8

- FCC Part 15/FCC Part 15.109 30M-40GHz B - Average/3.0m/
- ◊ Level (Manual suspects) (Vertical)
- Meas.Peak (Horizontal)
- Meas.Peak (Vertical)
- × Meas.CISPR.AVG (Max Hold Manual meas.) (Horizontal)
- × Meas.CISPR.AVG (Max Hold Manual meas.) (Vertical)

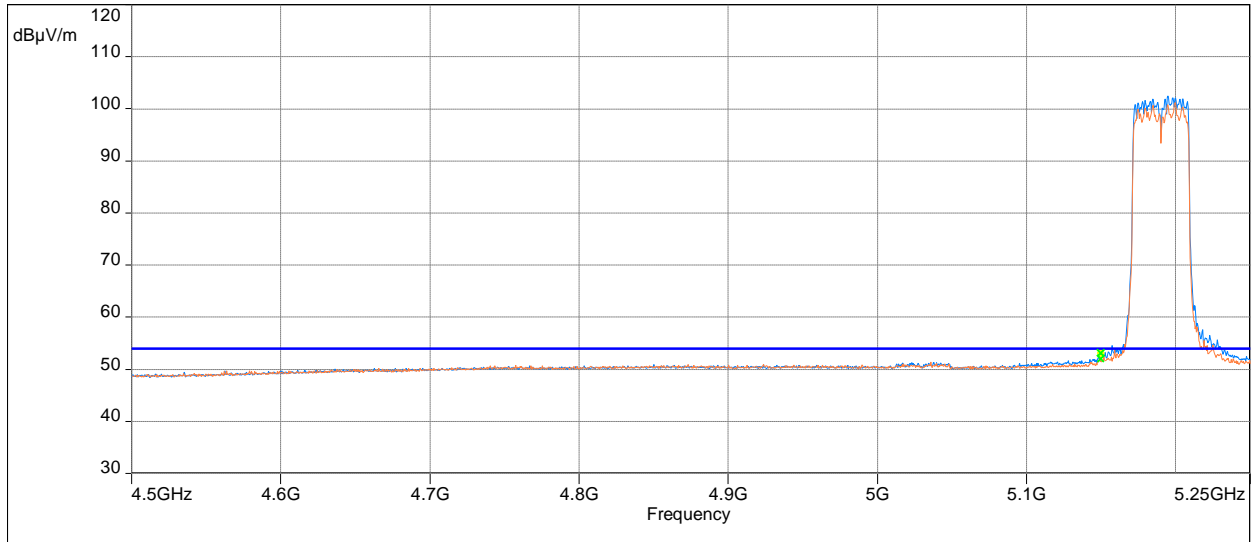

Model: ; Client: ; Comments: ; Test Date: 10/03/2017 10:55

Frequency (MHz)	Average (dBµV/m)	Lim. Avg (dBµV/m)	Margin (dB)	Height (m)	Angle (°)	Polarization	Correction (dB)
5149.704	52.0	54.0	-2.0	1.8	143.8	Horizontal	32.8
5150.000	53.2	54.0	-0.8	1.8	139.3	Vertical	32.8

**Out-of-Band Spurious Emissions at the Band Edge @1m Distance
802.11ac 80MHz, 5210 MHz**

- FCC Part 15/FCC Part 15.109 Peak 1GHz to 40GHz B - Peak/3.0m/
- ◊ Level (Manual suspects) (Vertical)
- Meas.Peak (Horizontal)
- Meas.Peak (Vertical)
- × Peak (Peak /Lim. Peak) (Horizontal)
- × Peak (Peak /Lim. Peak) (Vertical)

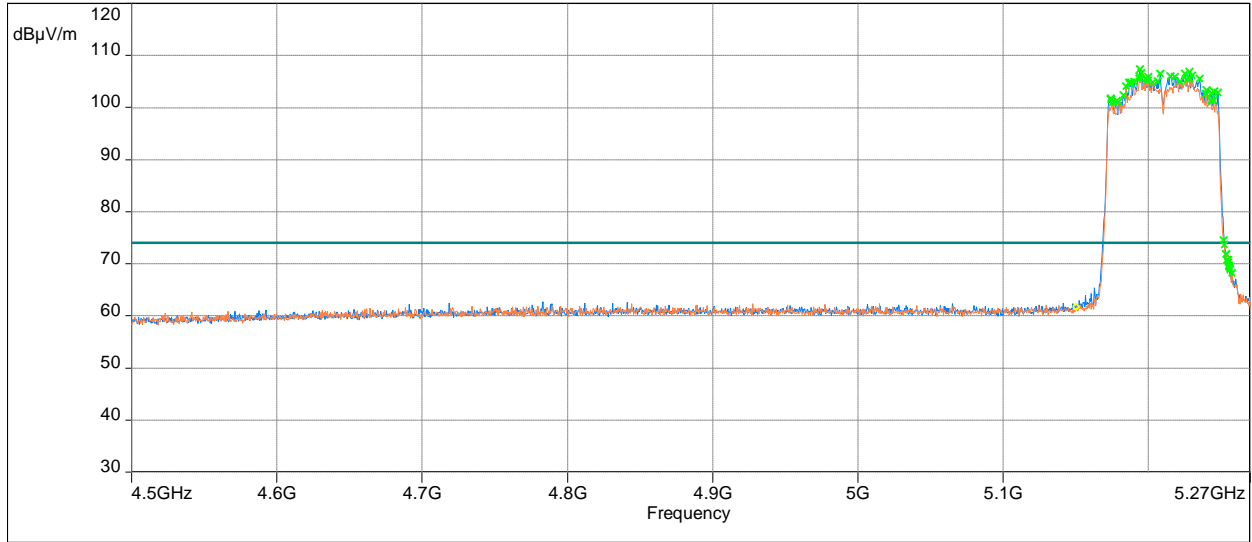

Model: ; Client: ; Comments: ; Test Date: 10/05/2017 10:34

Frequency (MHz)	Peak (dBµV/m)	Lim. PK (dBµV/m)	Margin (dB)	Height (m)	Angle (°)	Polarization	Correction (dB)
5150.000	61.78	74.0	-12.2	1.5	110	Vertical	32.8

- FCC Part 15/FCC Part 15.109 30M-40GHz B - Average/3.0m/
- Meas.Peak (Horizontal)
- Meas.Peak (Vertical)
- × Meas.CISPR.AVG (Max Hold Manual meas.) (Vertical)

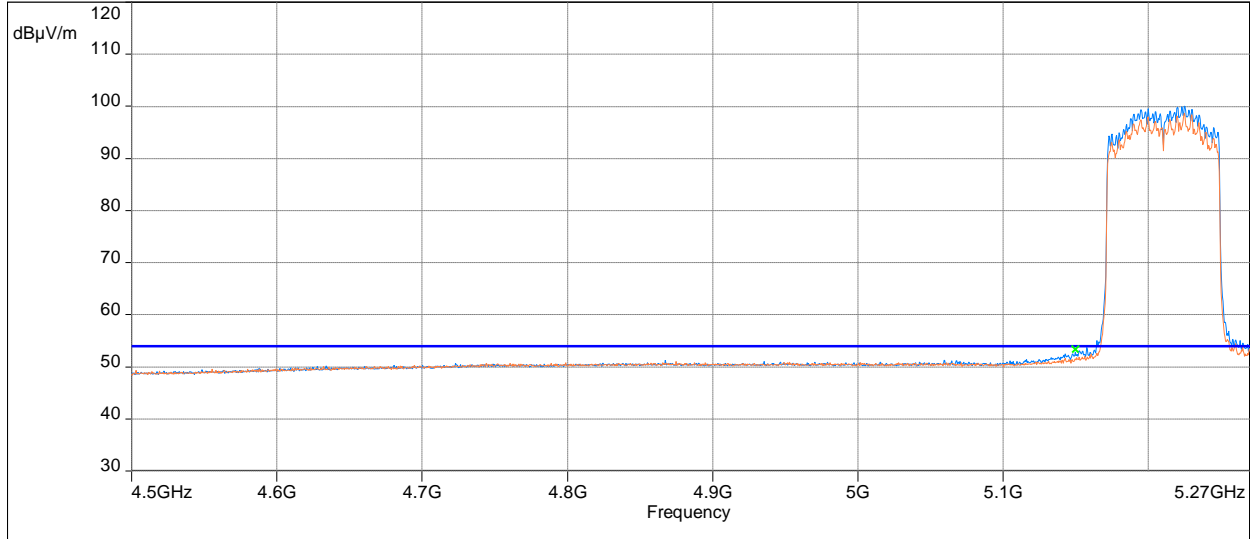

Model: ; Client: ; Comments: ; Test Date: 10/03/2017 12:40

Frequency (MHz)	Average (dBµV/m)	Lim. Avg (dBµV/m)	Margin (dB)	Height (m)	Angle (°)	Polarization	Correction (dB)
5150.000	53.4	54.0	-0.7	1.6	127.8	Vertical	32.8

**Test Results: 15.209 Radiated Spurious Emissions Low Channel,
Tx at 802.11b 2412MHz, and 802.11a 5180MHz**

Radiated Spurious Emissions - 30 MHz to 1000 MHz

- FCC Part 15/FCC Part 15.205/15.209, 30MHz-1GHz - QPeak/10.0m/
- Meas.Peak (Horizontal)
- Meas.Peak (Vertical)
- x Peak (Peak /Lim. QPeak) (Horizontal)
- x Peak (Peak /Lim. QPeak) (Vertical)
- o FS (Final QP) (Vertical)

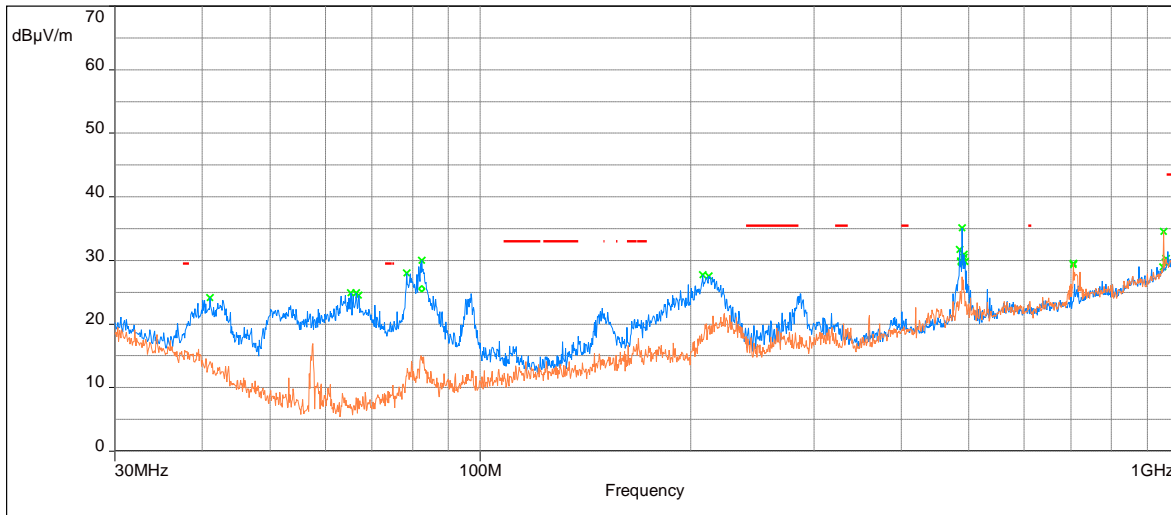

Model: ; Client: ; Comments: ; Test Date: 09/22/2017 16:00

Radiated Spurious Emissions 1000 - 18000 MHz, Peak Scan vs Peak Limit

- FCC Part 15/15.407 UNII Peak 1GHz - 40GHz B - Peak/3.0m/
- Meas.Peak (Horizontal)
- Meas.Peak (Vertical)
- x Peak (Peak /Lim. Peak) (Horizontal)
- x Peak (Peak /Lim. Peak) (Vertical)

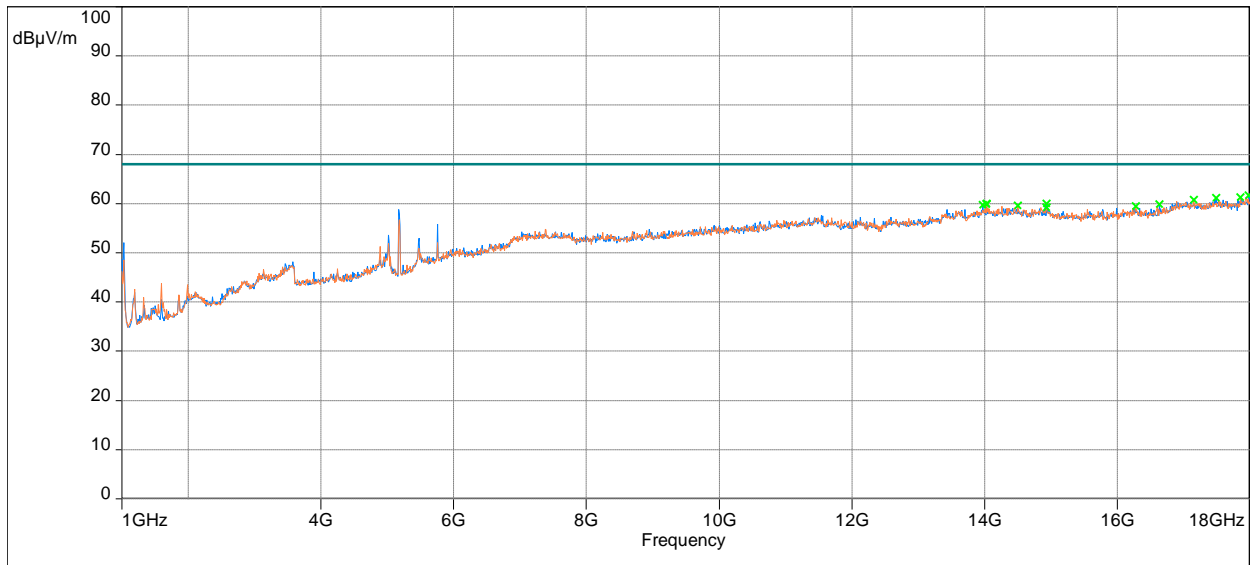

Model: ; Client: ; Comments: ; Test Date: 10/02/2017 10:56

Radiated Spurious Emissions 1000 - 18000 MHz, Avg Scan vs Avg Limit

- FCC Part 15/FCC Part 15.109 30M-40GHz B - Average/3.0m/
- Meas.Peak (Horizontal)
- Meas.Peak (Vertical)
- x Peak (Peak /Lim. Average) (Horizontal)
- x Peak (Peak /Lim. Average) (Vertical)

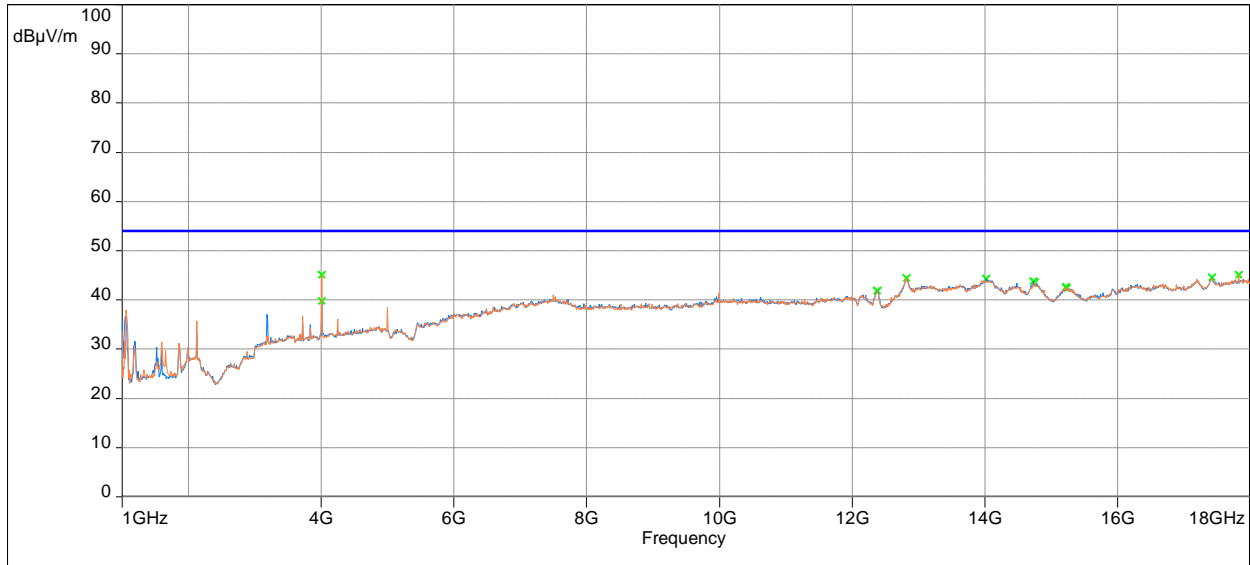

Model: ; Client: ; Comments: ; Test Date: 09/28/2017 11:56

Note: Radiated emission measurements were performed up to 40GHz. No Emissions were identified when scanned from 18-40 GHz

**Test Results: 15.209 Radiated Spurious Emissions Mid Channel,
Tx at 802.11b 2437MHz, and 802.11a 5200MHz
Radiated Spurious Emissions - 30 MHz to 1000 MHz**

- FCC Part 15/FCC Part 15.205/15.209, 30MHz-1GHz - QPeak/10.0m/
- Meas.Peak (Horizontal)
- Meas.Peak (Vertical)
- × Peak (Peak /Lim. QPeak) (Horizontal)
- × Peak (Peak /Lim. QPeak) (Vertical)
- ◊ FS (Final QP) (Vertical)

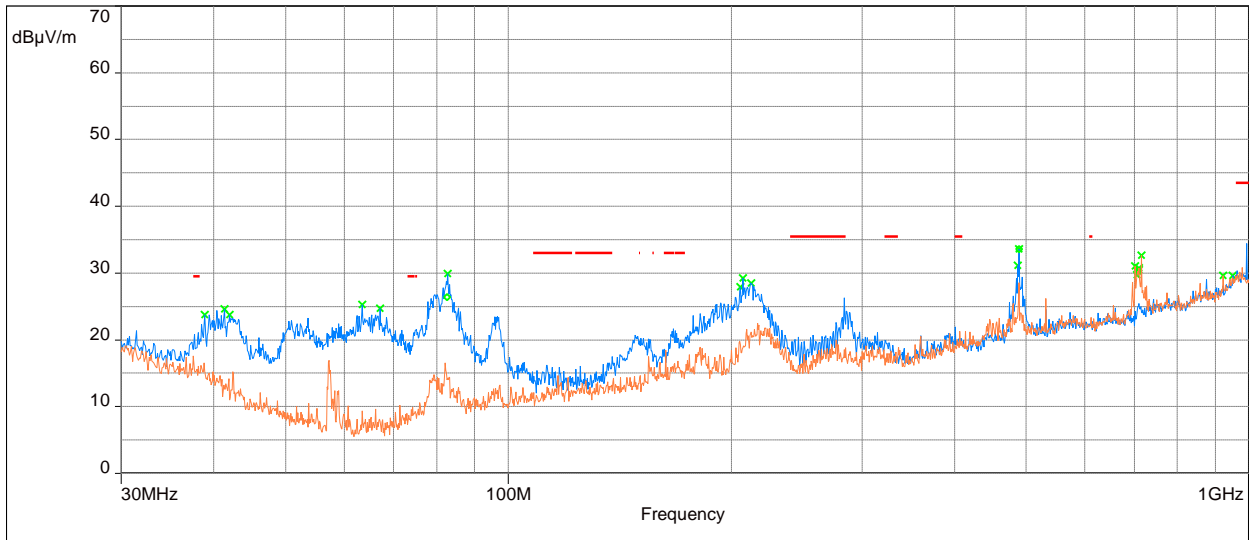

Model: ; Client: ; Comments: ; Test Date: 09/22/2017 15:16

Radiated Spurious Emissions 1000 - 18000 MHz, Peak Scan vs Peak Limit

- FCC Part 15/15.407 UNII Peak 1GHz - 40GHz B - Peak/3.0m/
- Meas.Peak (Horizontal)
- Meas.Peak (Vertical)
- × Peak (Peak /Lim. Peak) (Horizontal)
- × Peak (Peak /Lim. Peak) (Vertical)

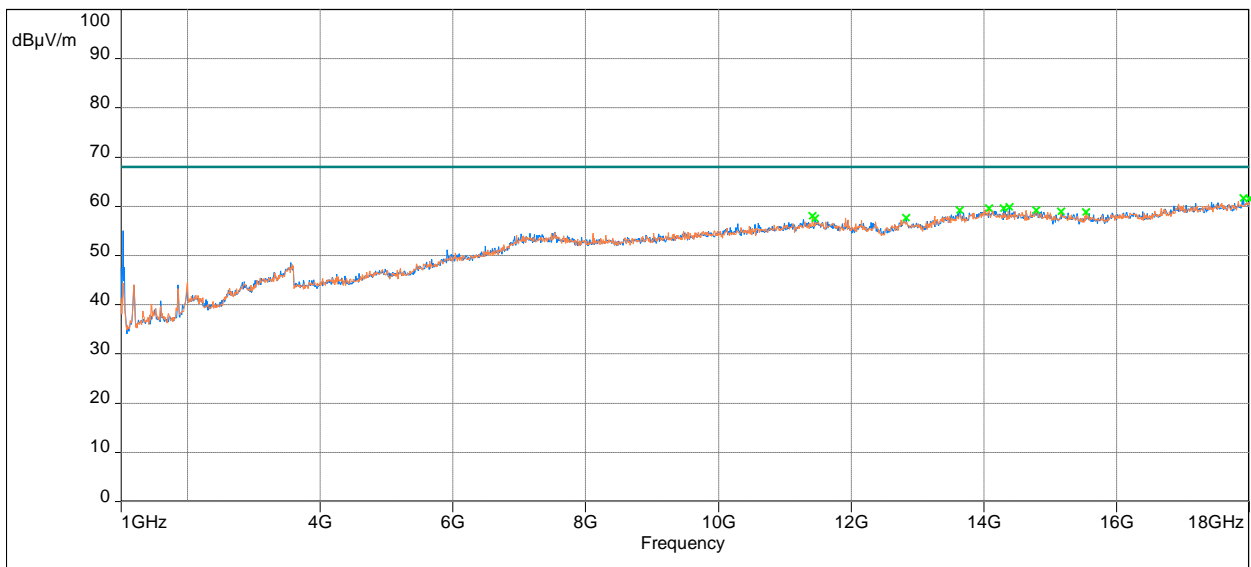

Model: ; Client: ; Comments: ; Test Date: 10/02/2017 10:45

Radiated Spurious Emissions 1000 - 18000 MHz, Avg Scan vs Avg Limit

- FCC Part 15/FCC Part 15.109 30M-40GHz B - Average/3.0m/
- Meas.Peak (Horizontal)
- Meas.Peak (Vertical)
- x Peak (Peak /Lim. Average) (Horizontal)
- x Peak (Peak /Lim. Average) (Vertical)

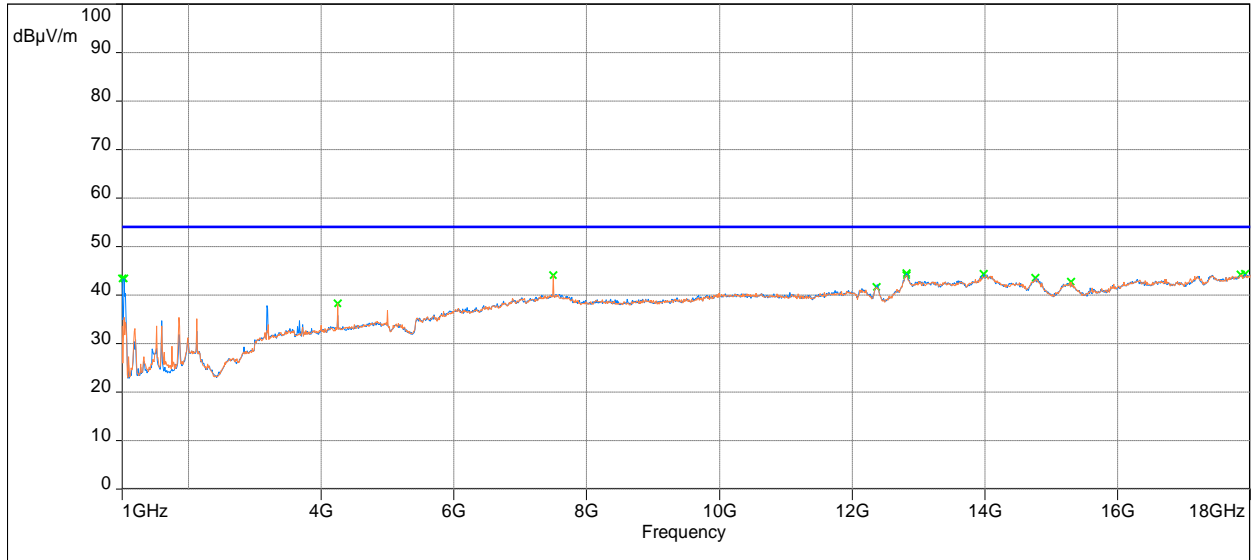

Model: ; Client: ; Comments: ; Test Date: 10/02/2017 10:32

Note: Radiated emission measurements were performed up to 40GHz. No Emissions were identified when scanned from 18-40 GHz

**Test Results: 15.209 Radiated Spurious Emissions High Channel,
Tx at 802.11b 2462MHz, and 802.11a 5240MHz
Radiated Spurious Emissions - 30 MHz to 1000 MHz**

- FCC Part 15/FCC Part 15.205/15.209, 30MHz-1GHz - QPeak/10.0m/
- Meas.Peak (Horizontal)
- Meas.Peak (Vertical)
- × Peak (Peak /Lim. QPeak) (Horizontal)
- × Peak (Peak /Lim. QPeak) (Vertical)
- ◇ FS (Final QP) (Vertical)

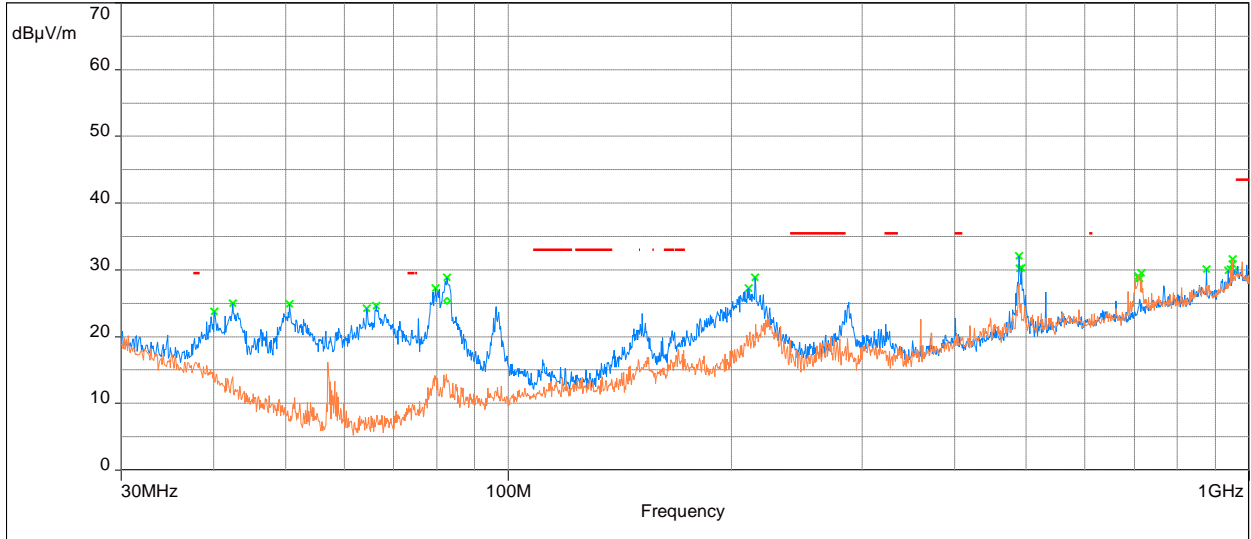

Model: ; Client: ; Comments: ; Test Date: 09/22/2017 16:25

Radiated Spurious Emissions 1000 - 18000 MHz, Peak Scan vs Peak Limit

- FCC Part 15/15.407 UNII Peak 1GHz - 40GHz B - Peak/3.0m/
- Meas.Peak (Horizontal)
- Meas.Peak (Vertical)
- × Peak (Peak /Lim. Peak) (Horizontal)
- × Peak (Peak /Lim. Peak) (Vertical)

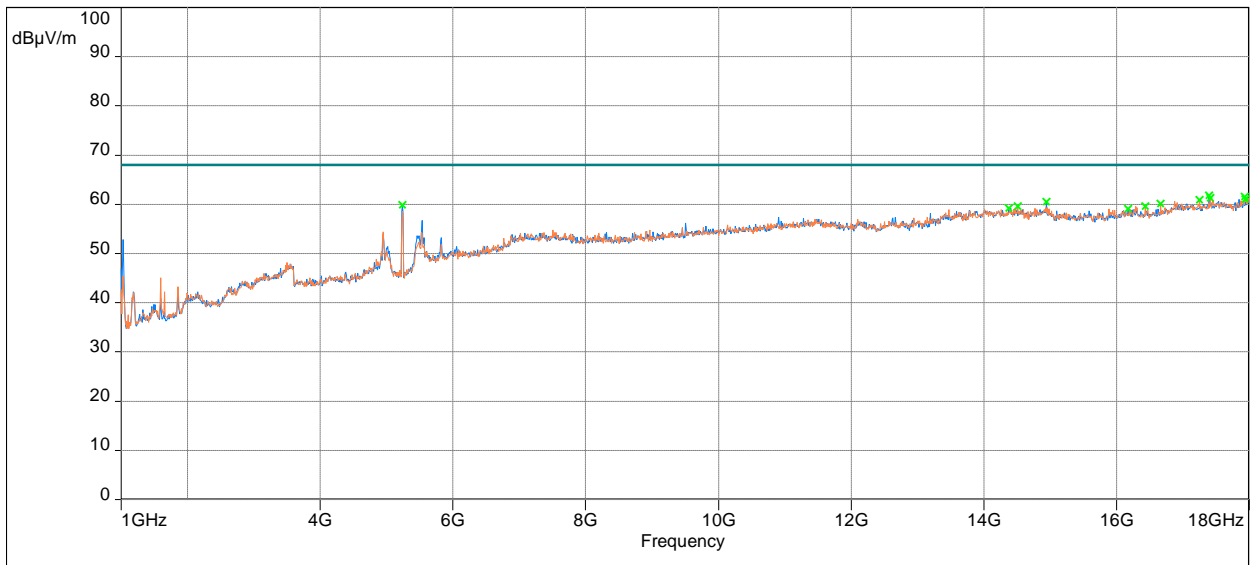

Model: ; Client: ; Comments: ; Test Date: 10/02/2017 11:30

Radiated Spurious Emissions 1000 - 18000 MHz, Avg Scan vs Avg Limit

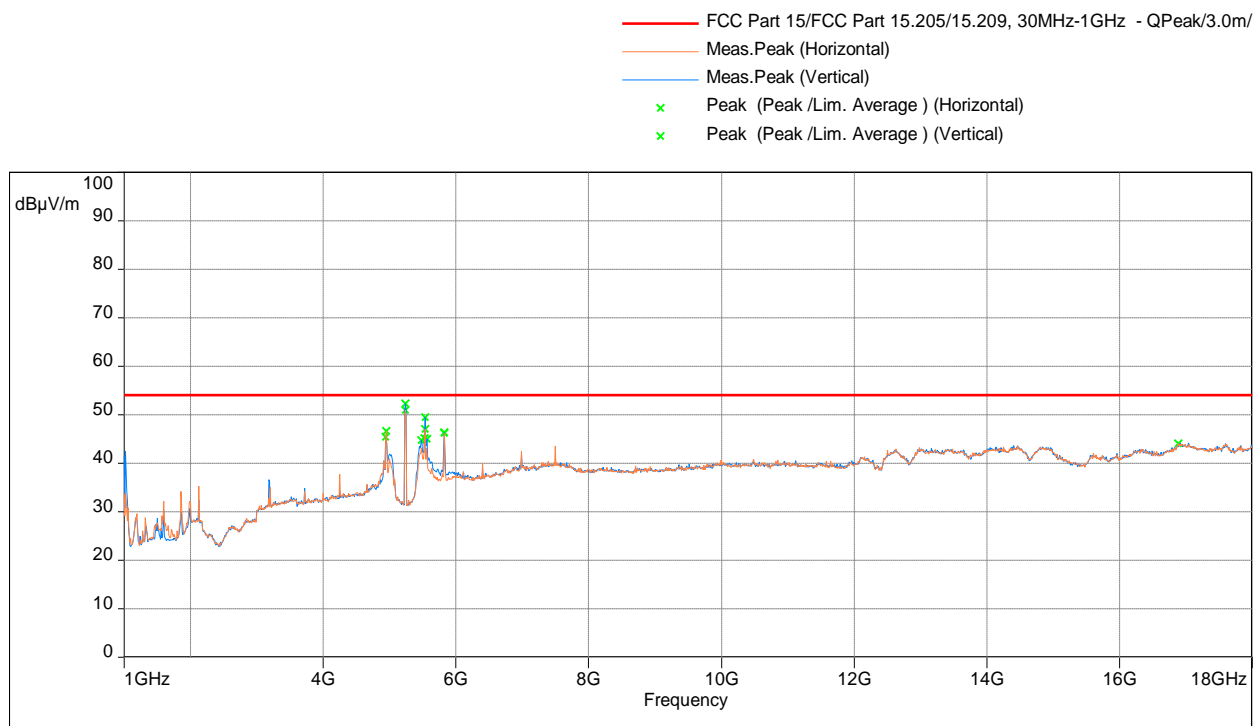

- Emission at 5537.3MHz peak is not in restricted band (15.205). Therefore the limit of 15.209 does not apply to this particular frequency. Compliance for this frequency outside the restricted band is shown in report number 103224477MPK-002A; section 4.4.

Note: Radiated emission measurements were performed up to 40GHz. No Emissions were identified when scanned from 18-40 GHz

**Test Results: 15.209 Radiated Spurious Emissions Low Channel,
Tx at 802.11g 2412MHz, and 802.11n 20MHz 5180MHz**

Radiated Spurious Emissions - 30 MHz to 1000 MHz

- FCC Part 15/FCC Part 15.205/15.209, 30MHz-1GHz - QPeak/10.0m/
- Meas.Peak (Horizontal)
- Meas.Peak (Vertical)
- × Peak (Peak /Lim. QPeak) (Horizontal)
- × Peak (Peak /Lim. QPeak) (Vertical)

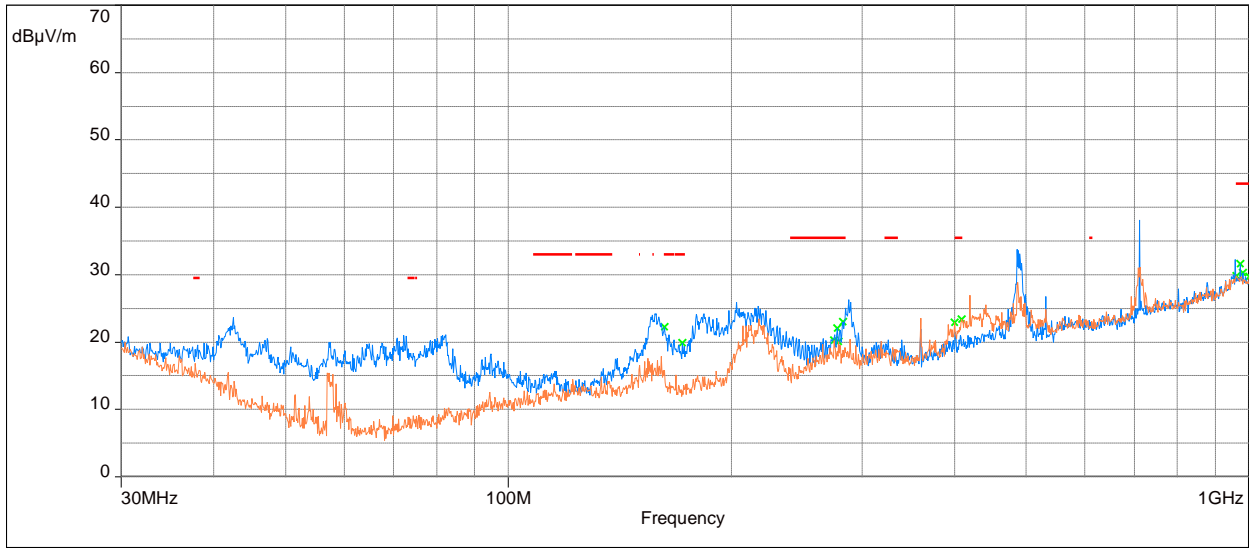

Model: ; Client: ; Comments: ; Test Date: 09/26/2017 07:49

Radiated Spurious Emissions 1000 - 18000 MHz, Peak Scan vs Peak Limit

- FCC Part 15/15.407 UNII Peak 1GHz - 40GHz B - Peak/3.0m/
- Meas.Peak (Horizontal)
- Meas.Peak (Vertical)
- × Peak (Peak /Lim. Peak) (Horizontal)
- × Peak (Peak /Lim. Peak) (Vertical)

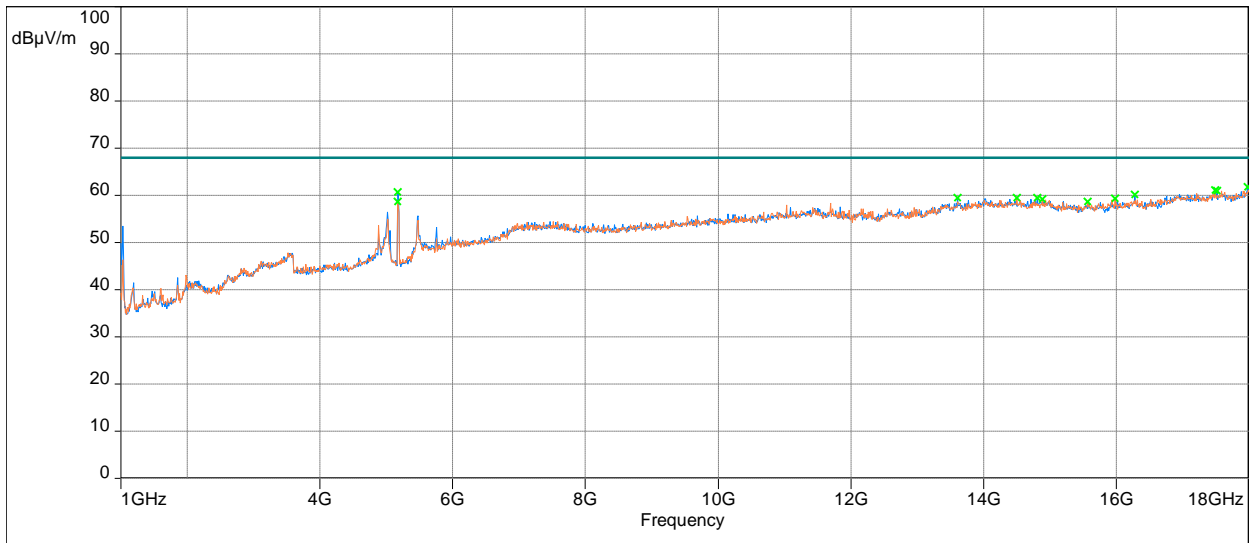

Model: ; Client: ; Comments: ; Test Date: 10/02/2017 11:55

Radiated Spurious Emissions 1000 - 18000 MHz, Avg Scan vs Avg Limit

- FCC Part 15/FCC Part 15.109 30M-40GHz B - Average/3.0m/
- Meas.Peak (Horizontal)
- Meas.Peak (Vertical)
- × Peak (Peak /Lim. Average) (Horizontal)
- × Peak (Peak /Lim. Average) (Vertical)

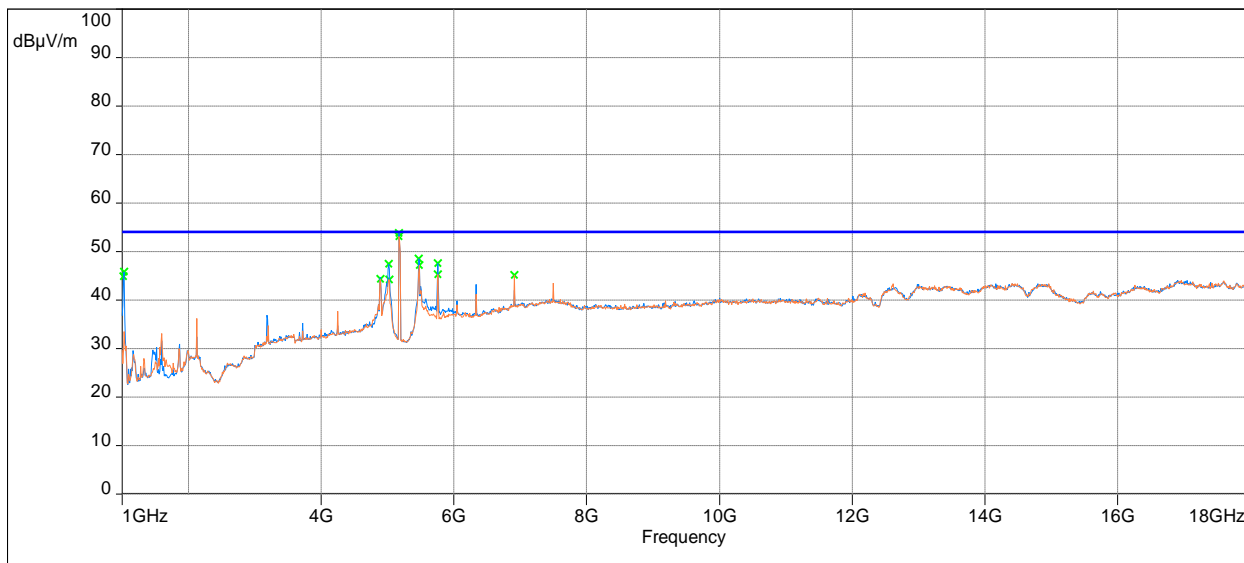

Model: ; Client: ; Comments: ; Test Date: 10/02/2017 11:49

- Emission at 5472.7MHz peak is not in restricted band (15.205). Therefore the limit of 15.209 does not apply to this particular frequency. Compliance for this frequency outside the restricted band is shown in report number 103224477MPK-002A; section 4.4.

Note: Radiated emission measurements were performed up to 40GHz. No Emissions were identified when scanned from 18-40 GHz

**Test Results: 15.209 Radiated Spurious Emissions Mid Channel,
Tx at 802.11g 2437MHz, and 802.11n 20MHz 5200MHz
Radiated Spurious Emissions - 30 MHz to 1000 MHz**

- FCC Part 15/FCC Part 15.205/15.209, 30MHz-1GHz - QPeak/10.0m/
- Meas.Peak (Horizontal)
- Meas.Peak (Vertical)
- × Peak (Peak /Lim. QPeak) (Horizontal)
- × Peak (Peak /Lim. QPeak) (Vertical)

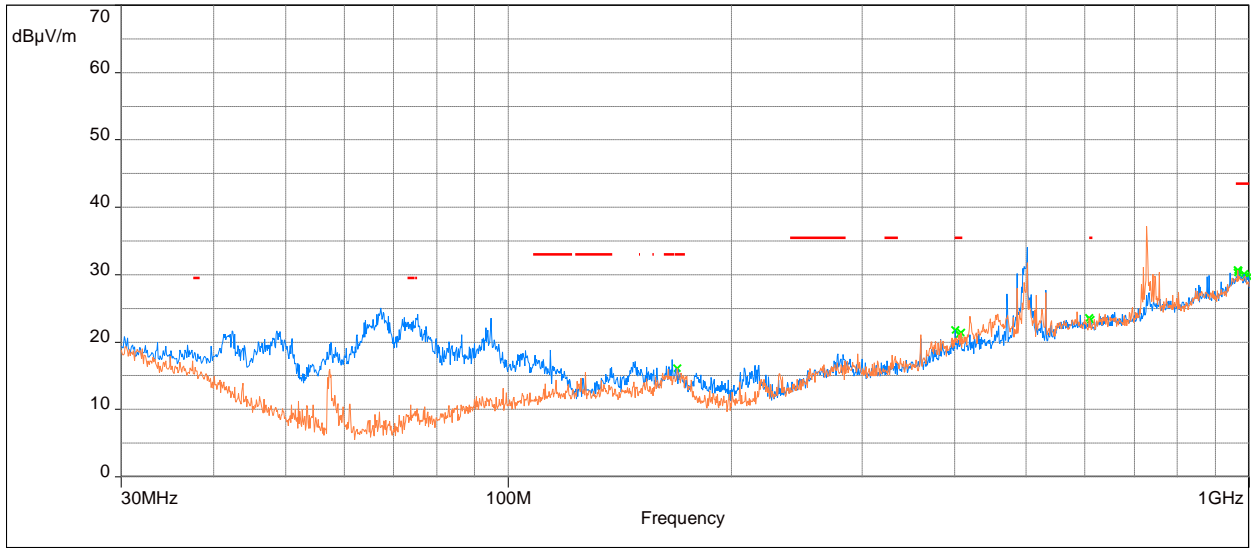

Model: ; Client: ; Comments: ; Test Date: 09/28/2017 10:12

Radiated Spurious Emissions 1000 - 18000 MHz, Peak Scan vs Peak Limit

- FCC Part 15/15.407 UNII Peak 1GHz - 40GHz B - Peak/3.0m/
- Meas.Peak (Horizontal)
- Meas.Peak (Vertical)
- × Peak (Peak /Lim. Peak) (Horizontal)
- × Peak (Peak /Lim. Peak) (Vertical)

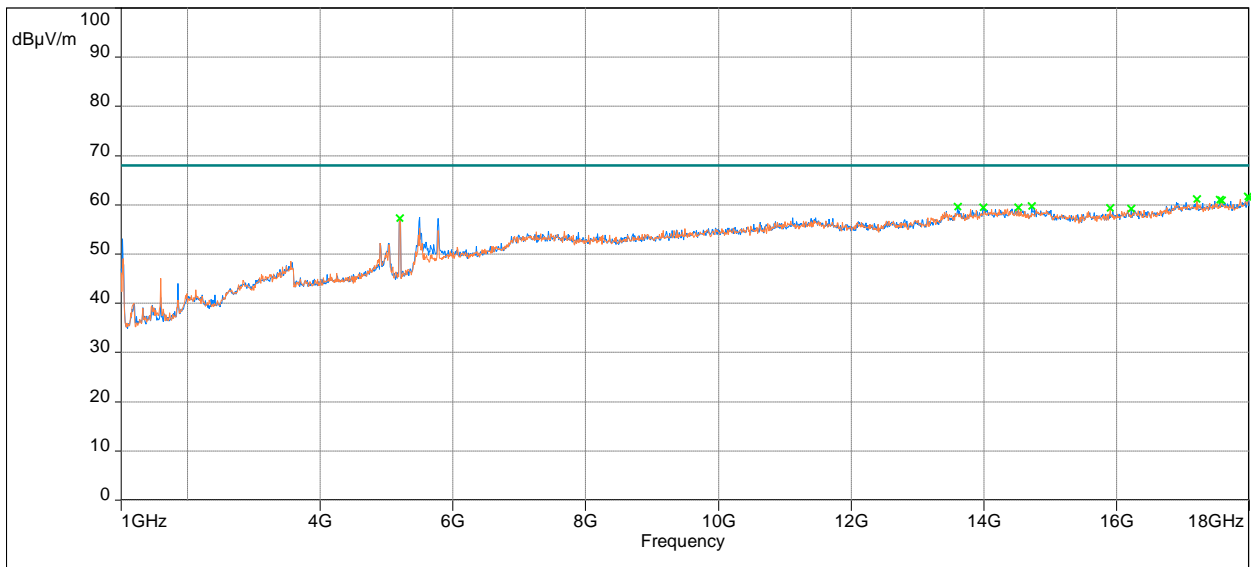

Model: ; Client: ; Comments: ; Test Date: 10/02/2017 12:13

Radiated Spurious Emissions 1000 - 18000 MHz, Avg Scan vs Avg Limit

- FCC Part 15/FCC Part 15.109 30M-40GHz B - Average/3.0m/
- Meas.Peak (Horizontal)
- Meas.Peak (Vertical)
- × Peak (Peak /Lim. Average) (Horizontal)
- × Peak (Peak /Lim. Average) (Vertical)

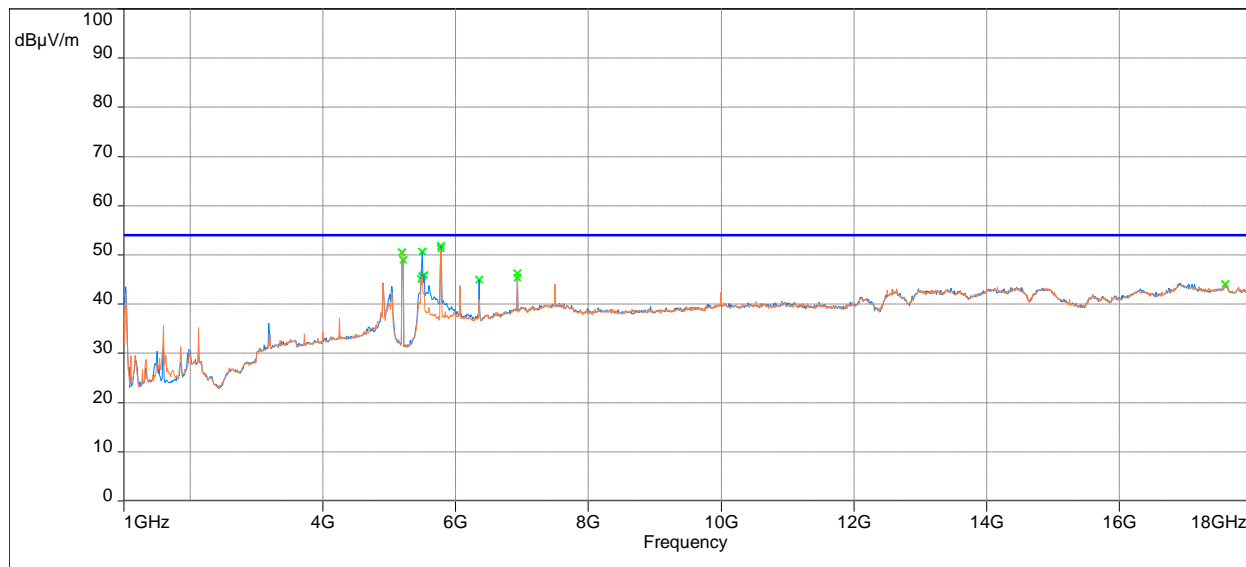

Model: ; Client: ; Comments: ; Test Date: 10/02/2017 12:07

- Emission at 5525.4MHz and 5777MHz peak is not in restricted band (15.205). Therefore the limit of 15.209 does not apply to this particular frequency. Compliance for this frequency outside the restricted band is shown in report number 103224477MPK-002A; section 4.4.

Note: Radiated emission measurements were performed up to 40GHz. No Emissions were identified when scanned from 18-40 GHz

**Test Results: 15.209 Radiated Spurious Emissions High Channel,
Tx at 802.11g 2462MHz and 802.11n 20MHz 5240MHz
Radiated Spurious Emissions - 30 MHz to 1000 MHz**

- FCC Part 15/FCC Part 15.205/15.209, 30MHz-1GHz - QPeak/10.0m/
- Meas.Peak (Horizontal)
- Meas.Peak (Vertical)
- × Peak (Peak /Lim. QPeak) (Horizontal)
- × Peak (Peak /Lim. QPeak) (Vertical)

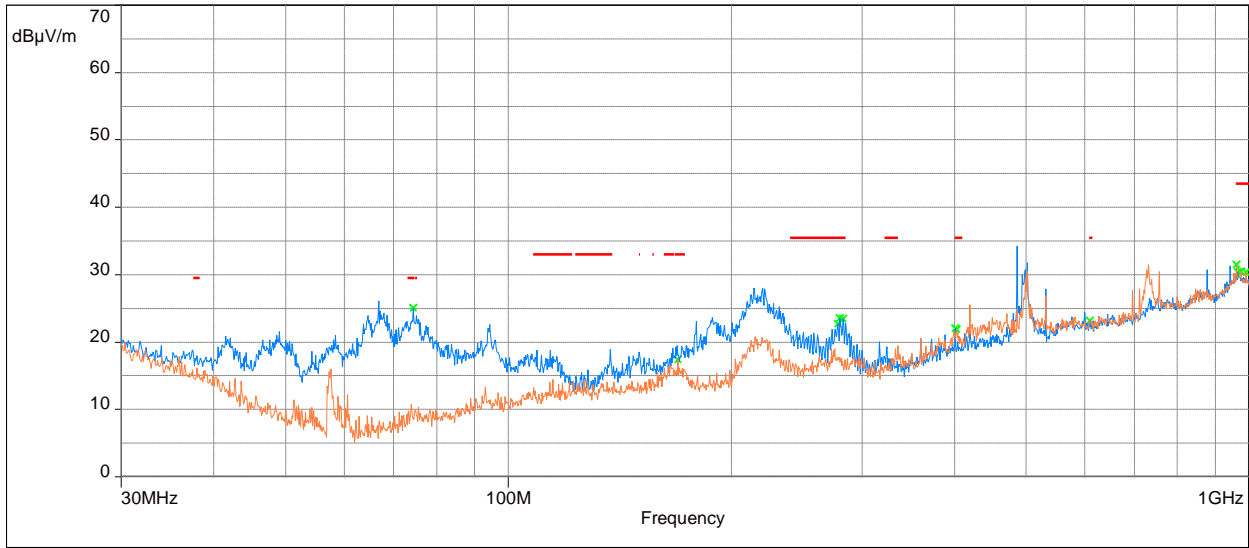

Model: ; Client: ; Comments: ; Test Date: 09/28/2017 10:26

Radiated Spurious Emissions 1000 - 18000 MHz, Peak Scan vs Peak Limit

- FCC Part 15/15.407 UNII Peak 1GHz - 40GHz B - Peak/3.0m/
- Meas.Peak (Horizontal)
- Meas.Peak (Vertical)
- × Peak (Peak /Lim. Peak) (Horizontal)
- × Peak (Peak /Lim. Peak) (Vertical)

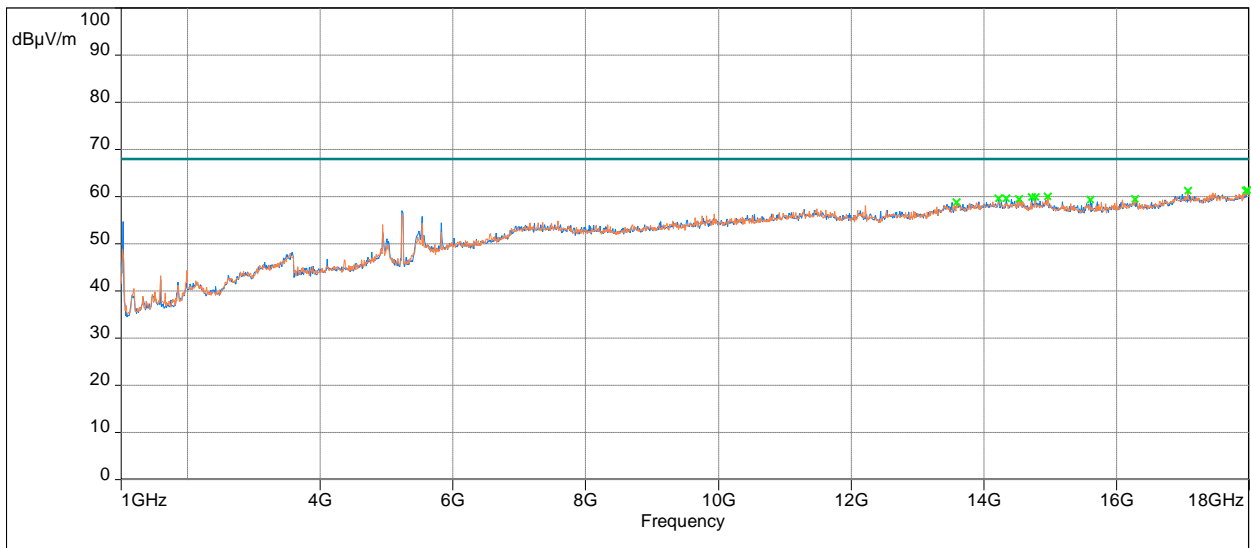

Model: ; Client: ; Comments: ; Test Date: 10/02/2017 13:10

Radiated Spurious Emissions 1000 - 18000 MHz, Avg Scan vs Avg Limit

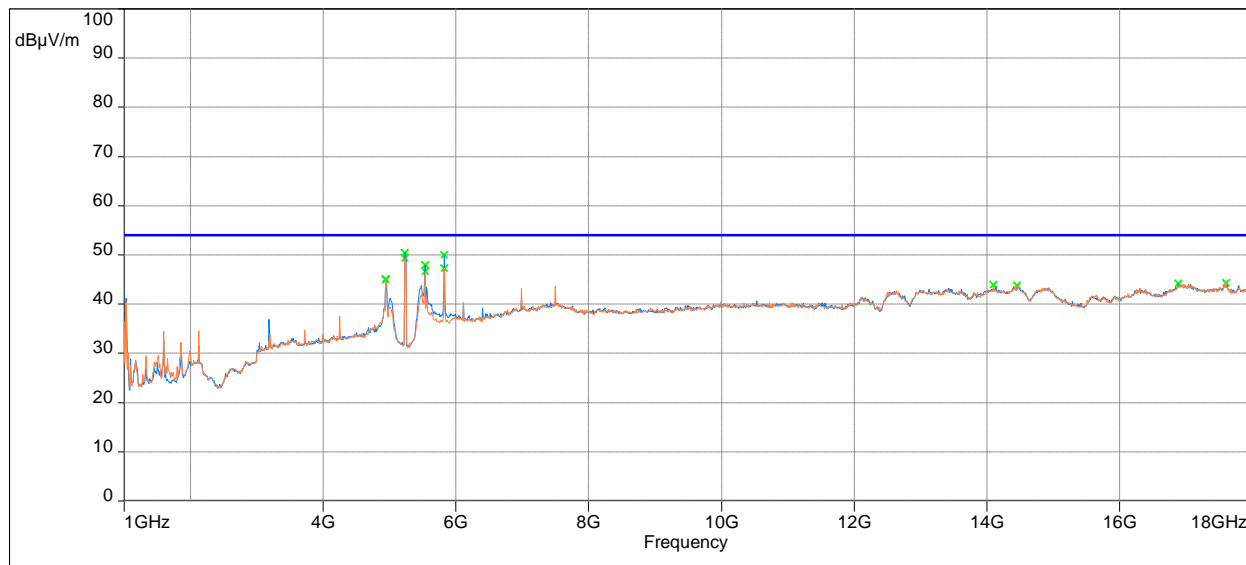
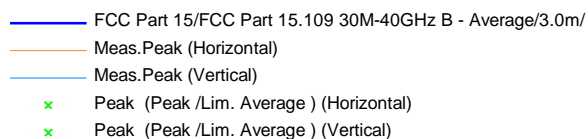

Model: ; Client: ; Comments: ; Test Date: 10/02/2017 13:04

- Emission at 5539MHz and 5821MHz peak is not in restricted band (15.205). Therefore the limit of 15.209 does not apply to this particular frequency. Compliance for this frequency outside the restricted band is shown in report number 103224477MPK-002A; section 4.4.

Note: Radiated emission measurements were performed up to 40GHz. No Emissions were identified when scanned from 18-40 GHz

**Test Results: 15.209 Radiated Spurious Emissions Low Channel,
Tx at 802.11n 40MHz 2422MHz, and 802.11n 40MHz 5190MHz**

Radiated Spurious Emissions - 30 MHz to 1000 MHz

- FCC Part 15/FCC Part 15.205/15.209, 30MHz-1GHz - QPeak/10.0m/
- Meas.Peak (Horizontal)
- Meas.Peak (Vertical)
- × Peak (Peak /Lim. QPeak) (Horizontal)
- × Peak (Peak /Lim. QPeak) (Vertical)

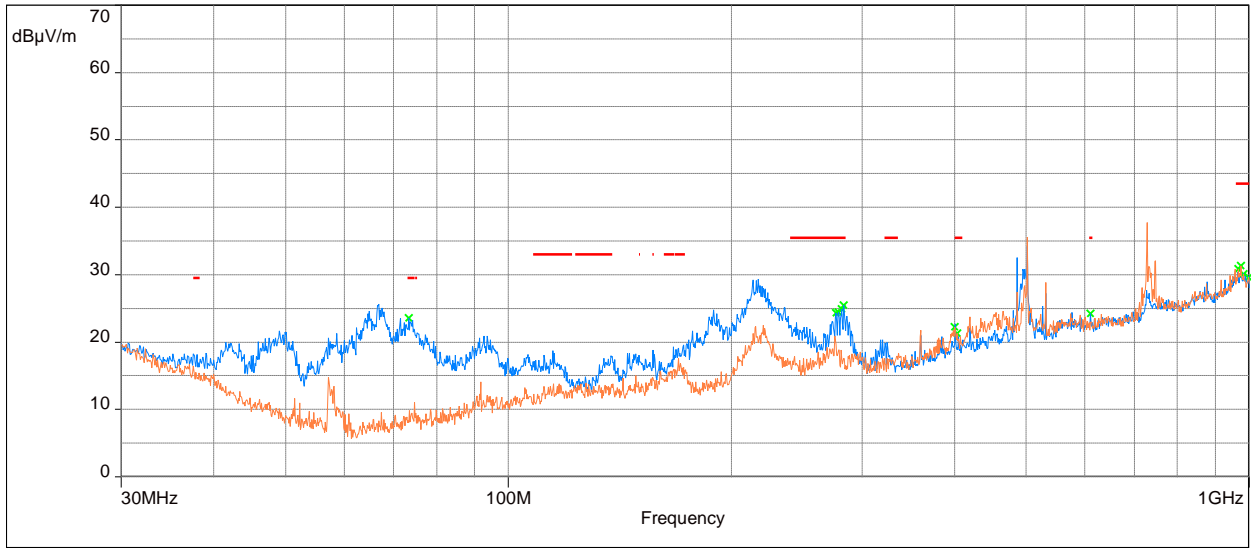

Model: ; Client: ; Comments: ; Test Date: 09/28/2017 10:39

Radiated Spurious Emissions 1000 - 18000 MHz, Peak Scan vs Peak Limit

- FCC Part 15/15.407 UNII Peak 1GHz - 40GHz B - Peak/3.0m/
- Meas.Peak (Horizontal)
- Meas.Peak (Vertical)
- × Peak (Peak /Lim. Peak) (Horizontal)
- × Peak (Peak /Lim. Peak) (Vertical)

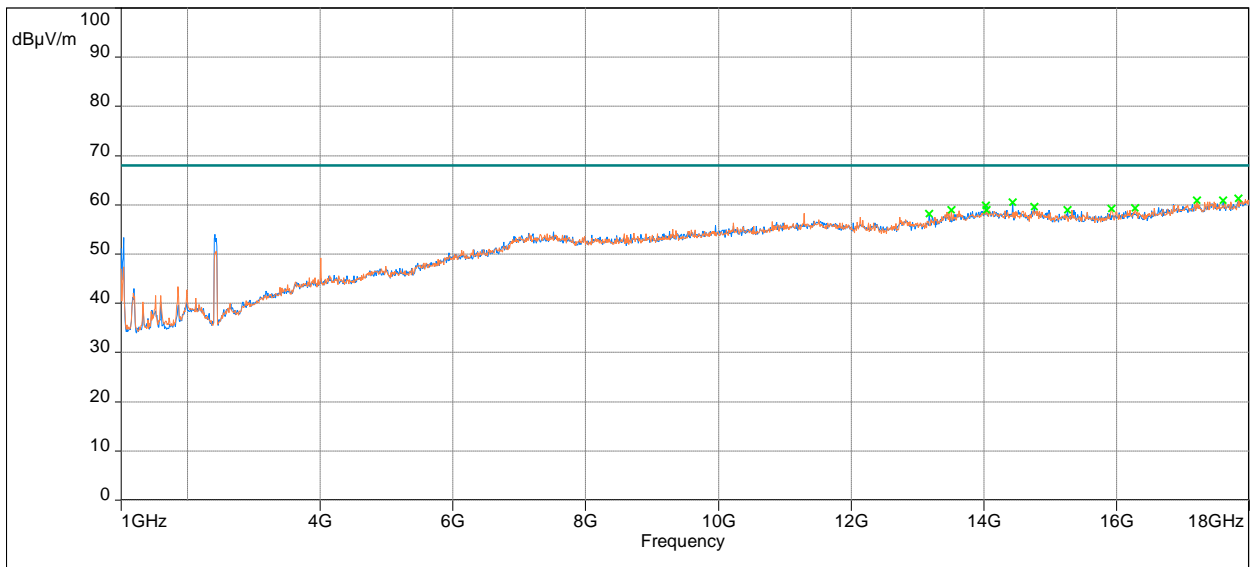

Model: ; Client: ; Comments: ; Test Date: 10/06/2017 10:00

Radiated Spurious Emissions 1000 - 18000 MHz, Avg Scan vs Avg Limit

- FCC Part 15/FCC Part 15.109 30M-40GHz B - Average/3.0m/
- Meas.Peak (Horizontal)
- Meas.Peak (Vertical)
- × Peak (Peak /Lim. Average) (Horizontal)
- × Peak (Peak /Lim. Average) (Vertical)

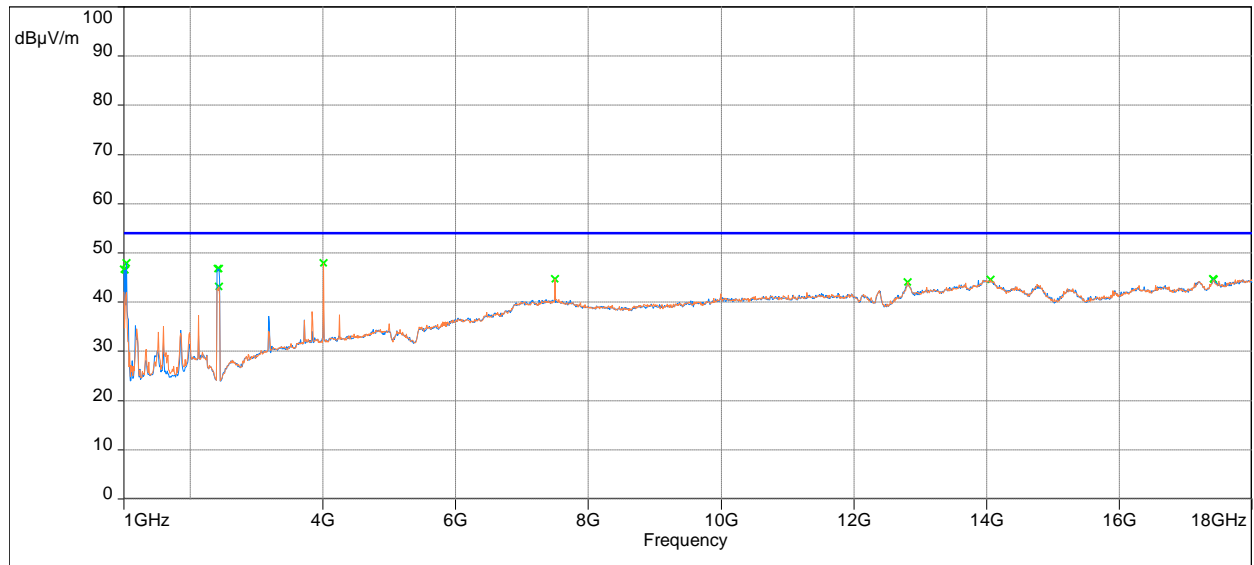

Model: ; Client: ; Comments: ; Test Date: 10/06/2017 09:47

Note: Radiated emission measurements were performed up to 40GHz. No Emissions were identified when scanned from 18-40 GHz

**Test Results: 15.209 Radiated Spurious Emissions High Channel,
Tx at 802.11n 40MHz 2452MHz, and 802.11n 40MHz 5230MHz**

Radiated Spurious Emissions - 30 MHz to 1000 MHz

- FCC Part 15/FCC Part 15.205/15.209, 30MHz-1GHz - QPeak/10.0m/
- Meas.Peak (Horizontal)
- Meas.Peak (Vertical)
- × Peak (Peak /Lim. QPeak) (Horizontal)
- × Peak (Peak /Lim. QPeak) (Vertical)

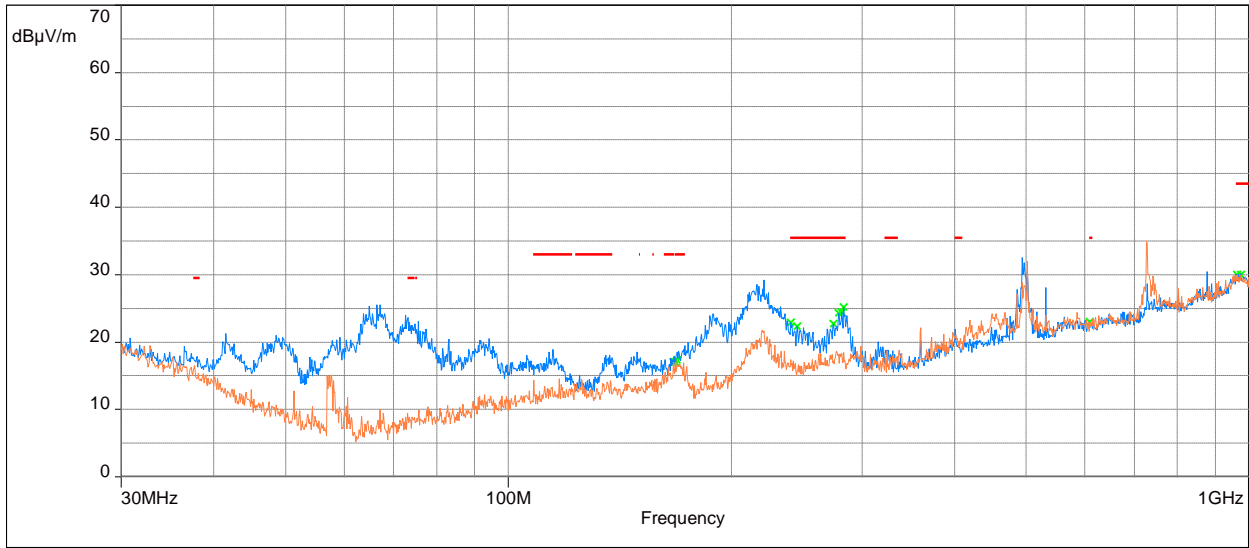

Model: ; Client: ; Comments: ; Test Date: 09/28/2017 10:50

Radiated Spurious Emissions 1000 - 18000 MHz, Peak Scan vs Peak Limit

- FCC Part 15/15.407 UNII Peak 1GHz - 40GHz B - Peak/3.0m/
- Meas.Peak (Horizontal)
- Meas.Peak (Vertical)
- × Peak (Peak /Lim. Peak) (Horizontal)
- × Peak (Peak /Lim. Peak) (Vertical)

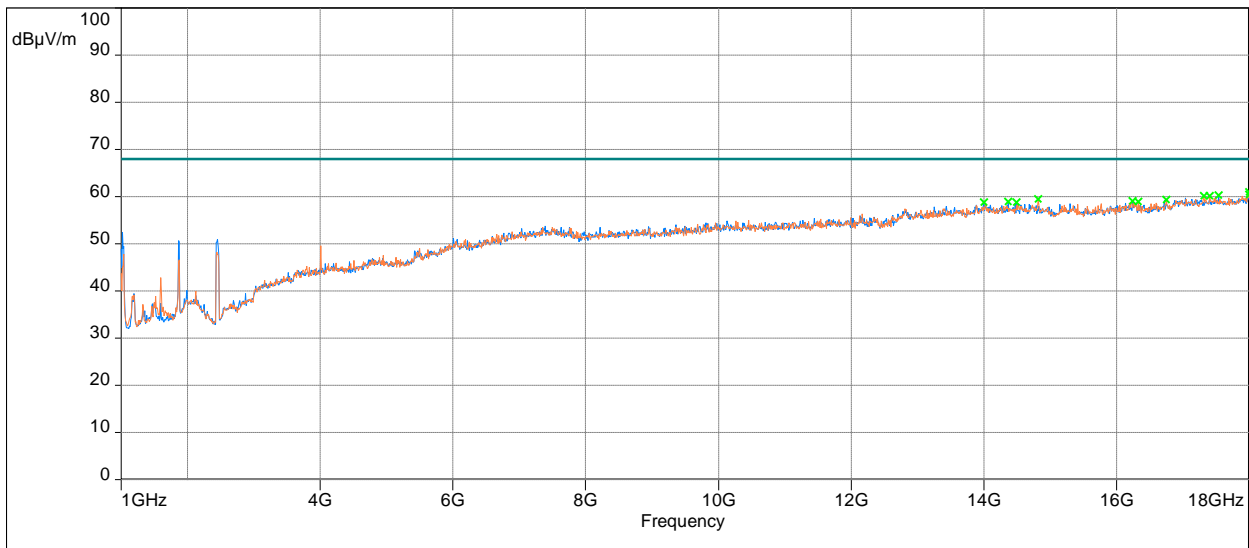

Model: ; Client: ; Comments: ; Test Date: 10/06/2017 10:23

Radiated Spurious Emissions 1000 - 18000 MHz, Avg Scan vs Avg Limit

- FCC Part 15/FCC Part 15.109 30M-40GHz B - Average/3.0m/
- Meas.Peak (Horizontal)
- Meas.Peak (Vertical)
- × Peak (Peak /Lim. Average) (Horizontal)
- × Peak (Peak /Lim. Average) (Vertical)

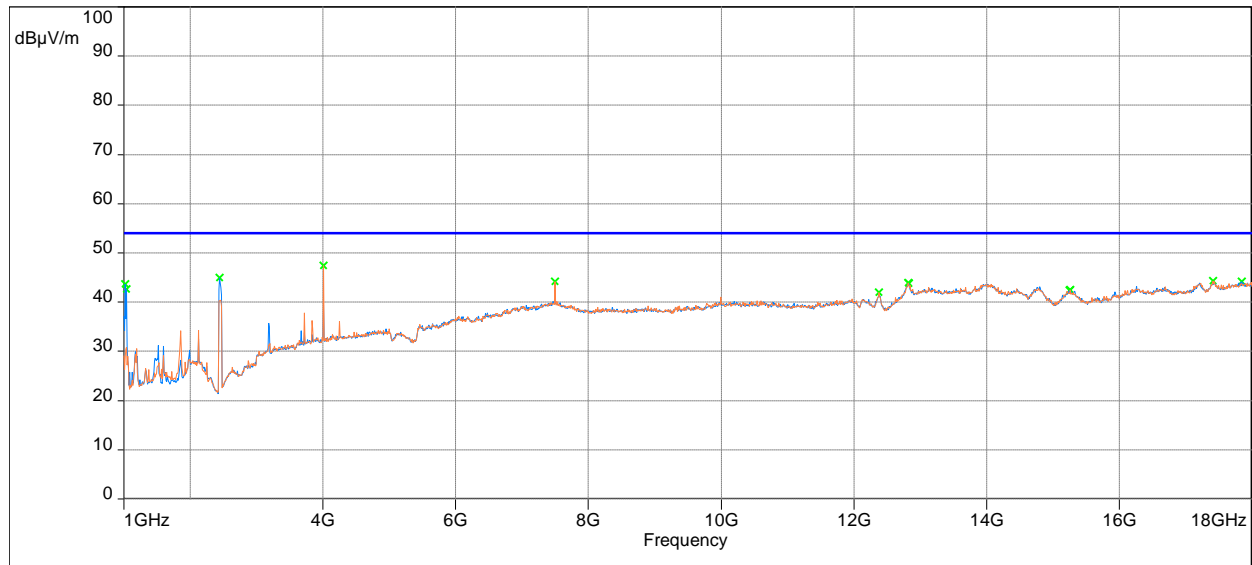

Model: ; Client: ; Comments: ; Test Date: 10/06/2017 10:14

Note: Radiated emission measurements were performed up to 40GHz. No Emissions were identified when scanned from 18-40 GHz

**Test Results: 15.209 Radiated Spurious Emission,
Tx at 802.11n 40MHz 2437MHz, and 802.11ac 80MHz 5210MHz**
Radiated Spurious Emissions - 30 MHz to 1000 MHz

- FCC Part 15/FCC Part 15.205/15.209, 30MHz-1GHz - QPeak/10.0m/
- Meas.Peak (Horizontal)
- Meas.Peak (Vertical)
- × Peak (Peak /Lim. QPeak) (Horizontal)
- × Peak (Peak /Lim. QPeak) (Vertical)

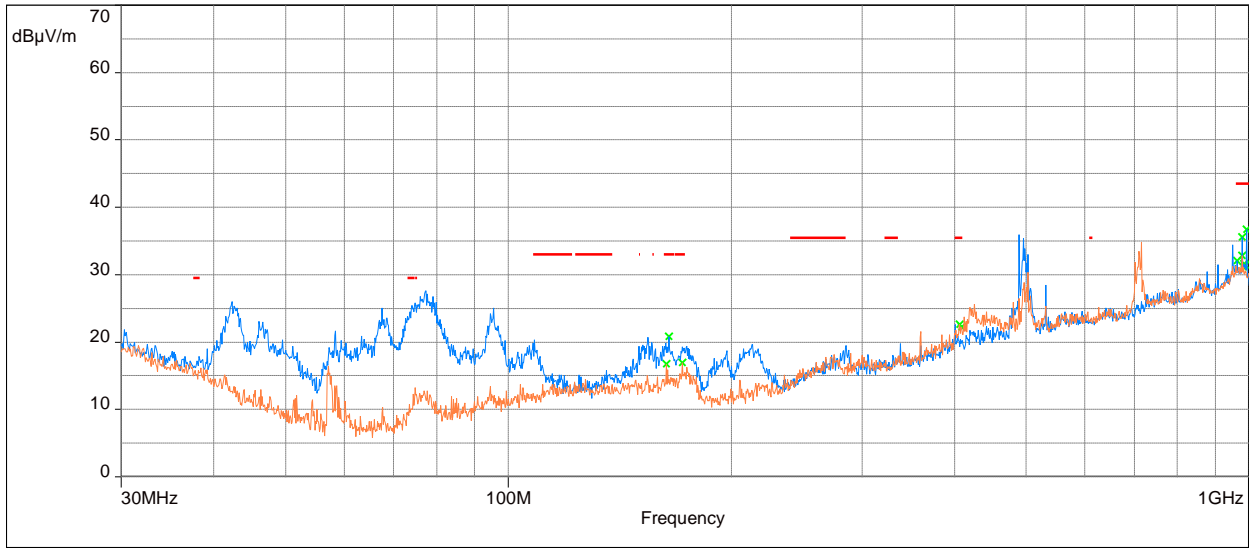

Model: ; Client: ; Comments: ; Test Date: 10/09/2017 10:19

Radiated Spurious Emissions 1000 - 18000 MHz, Peak Scan vs Peak Limit

- FCC Part 15/15.407 UNII Peak 1GHz - 40GHz B - Peak/3.0m/
- Meas.Peak (Horizontal)
- Meas.Peak (Vertical)
- × Peak (Peak /Lim. Peak) (Horizontal)
- × Peak (Peak /Lim. Peak) (Vertical)

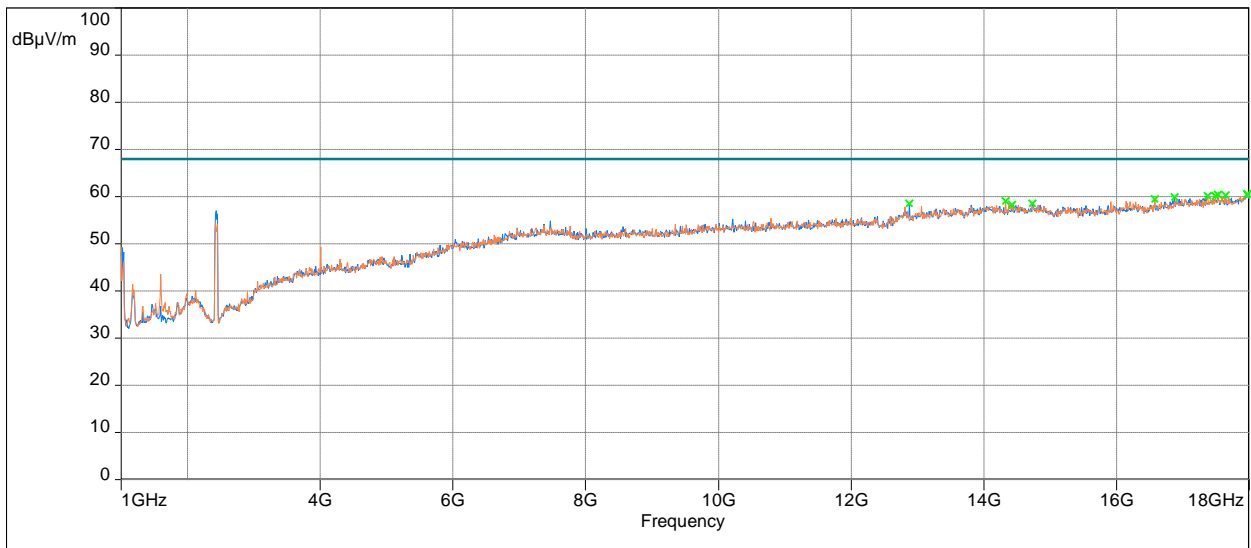

Model: ; Client: ; Comments: ; Test Date: 10/06/2017 10:48

Radiated Spurious Emissions 1000 - 18000 MHz, Avg Scan vs Avg Limit

- FCC Part 15/FCC Part 15.109 30M-40GHz B - Average/3.0m/
- Meas.Peak (Horizontal)
- Meas.Peak (Vertical)
- × Peak (Peak /Lim. Average) (Horizontal)
- × Peak (Peak /Lim. Average) (Vertical)

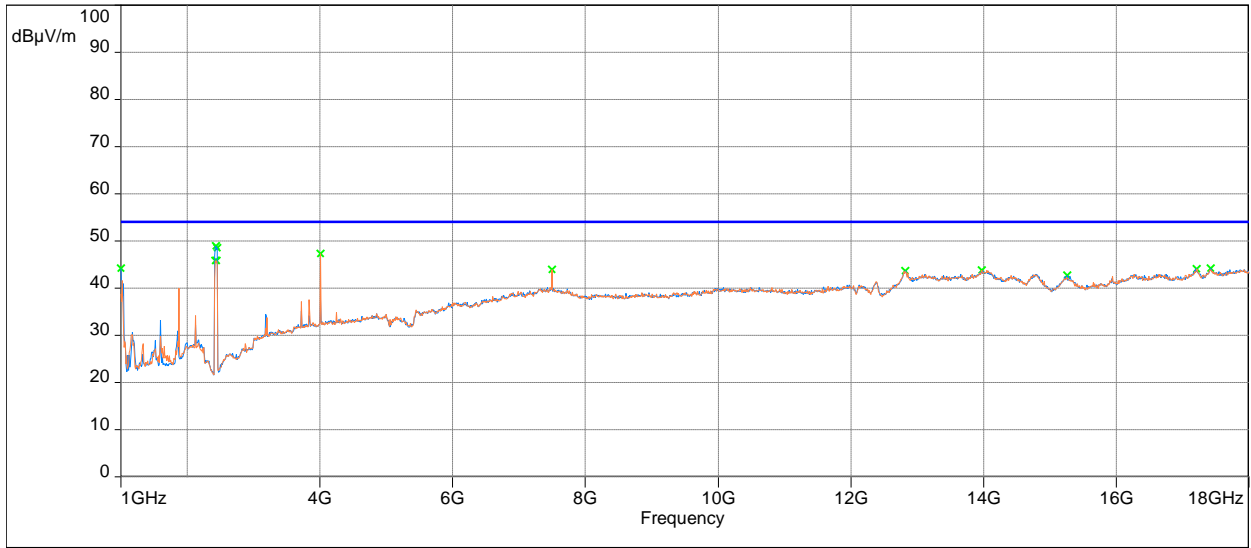

Model: ; Client: ; Comments: ; Test Date: 10/06/2017 10:32

Note: Radiated emission measurements were performed up to 40GHz. No Emissions were identified when scanned from 18-40 GHz

4.5.5 Test setup photographs

The following photographs show the testing configurations used.



4.5.5 Test setup photographs (Continued)

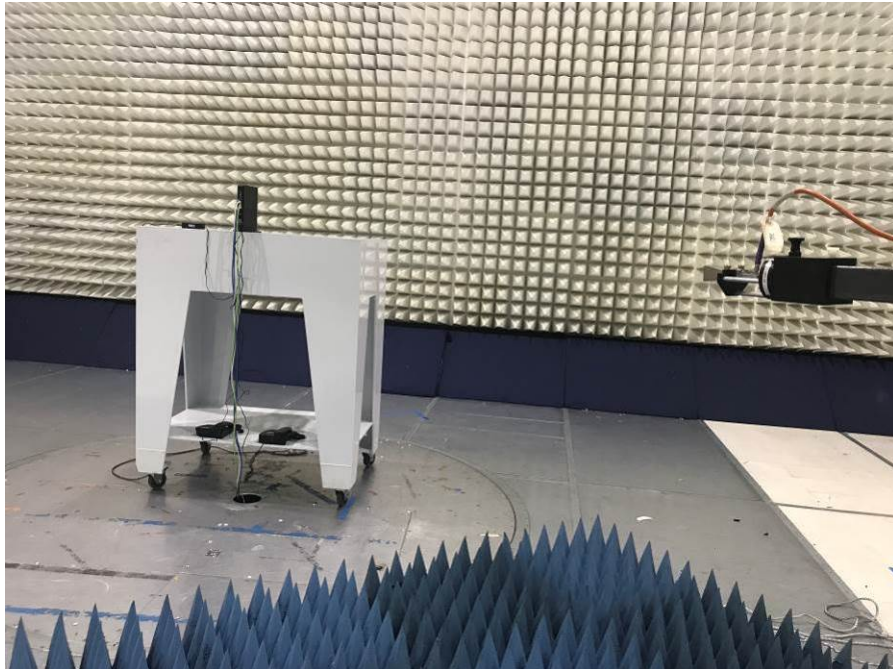
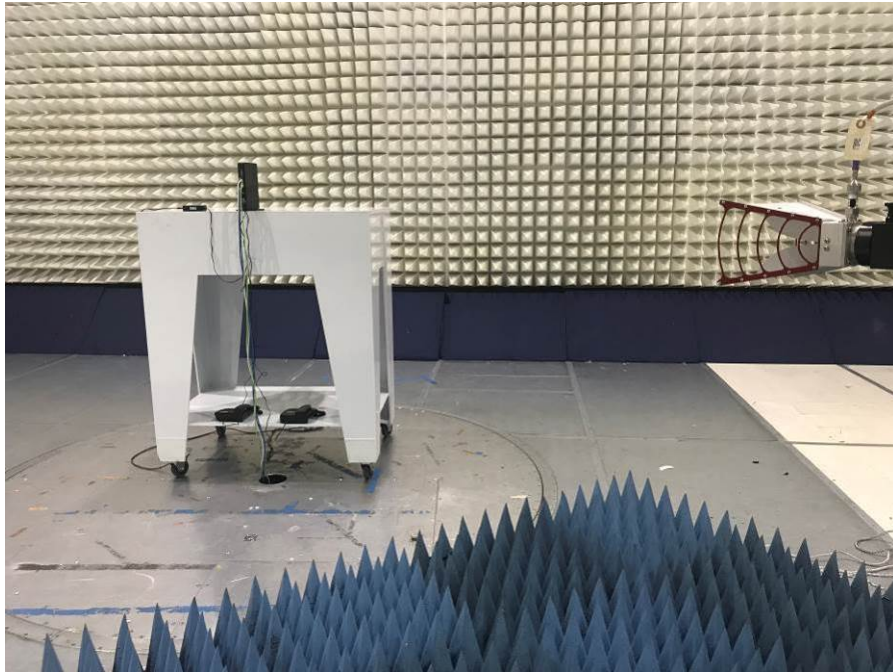

5.0 List of Test Equipment

Measurement equipment used for emission compliance testing utilized the equipment on the following list:

Equipment	Manufacturer	Model/Type	Asset #	Cal Int	Cal Due
Spectrum Analyzer	Rohde and Schwarz	FSU	ITS 00913	12	01/12/18
EMI Receiver	Rohde and Schwarz	ESU	ITS 00961	12	07/10/18
Pyramidal Horn Antenna	EMCO	3160-09	ITS 00571	#	#
Pyramidal Horn Antenna	EMCO	3160-10	ITS 00572	#	#
Horn Antenna	ETS-Lindgren	3117	ITS 00982	12	02/03/18
BI-Log Antenna	Teseq	CBL 6111D	ITS 01058	12	08/11/18
Pre-Amplifier (18-40GHz)	Miteq	TTA1840-35-S-M	ITS 01393	12	04/18/18
Pre-Amplifier (1-18GHz)	Miteq	AMF-4D-001180-24-10P	ITS 00526	12	01/04/18
Pre-Amplifier	Sonoma Instrument	310	ITS 00942	12	01/19/18
Notch Filter	Micro-Tronics	BRM50702	ITS 01166	12	02/08/18
Notch Filter	Micro-Tronics	BRM50703	ITS 01167	12	01/19/18
Notch Filter	Micro-Tronics	BRM50705	ITS 01169	12	01/19/18
RF Cable	TRU Corporation	TRU CORE 300	ITS 01462	12	08/19/18
RF Cable	TRU Corporation	TRU CORE 300	ITS 01465	12	08/19/18
RF Cable	TRU Corporation	TRU CORE 300	ITS 01470	12	08/19/18
Attenuator	Mini Circuits	BW-N3W5+	ITS 01315	12	10/19/17
Attenuator	Narda	FSCM99899	ITS 01583	12	08/31/18
RF Cable	Megaphase	EMC1-K1K1-236	ITS 01538	12	06/13/18
RF Cable	Megaphase	TM40-K1K1-19	ITS 01154	12	01/26/18
Transient Limiter	COM-POWER	LIT-153A	ITS 01452	12	06/19/18
RF Cable	Megaphase	TM40-K1K1-59 RF	ITS 01156	12	01/26/18

No Calibration required

Software used for emission compliance testing utilized the following:

Name	Manufacturer	Version	Template/Profile
BAT-EMC	Nexio	3.16.0.64	Alticelabs, ML.bpp Altice, 10-03.bpp
RS Commander	Rohde Schwarz	1.6.4	Not Applicable (Screen grabber)

6.0 Document History

Revision/ Job Number	Writer Initials	Reviewer Initials	Date	Change
1.0 / G103224477	ML	KV	October 18, 2017	Original document