

TEST REPORT

Product: Smartphone

Model No.: RLTP6067

**Additional Model No.: RLTP60XX(XX can be changed from 00 to 99),
HN-MPX6000, HN-MPX60XX(XX can be changed from 00 to 99)**

Trade Mark: N/A

Report No.: TCT160817E016

Issued Date: Sep. 13, 2016

Issued for:

**ShenZhen Harmony Technology Co., Ltd
Block 2, Jiayuan Industrial Zone, Heping Community high-tech Park, No 2
Fuyuan Road, Fuyong, Bao'an, Shenzhen, China**

Issued By:

**Shenzhen Tongce Testing Lab.
1F, Leinuo Watch Building, Fuyong Town, Baoan Dist, Shenzhen, China
TEL: +86-755-27673339
FAX: +86-755-27673332**

Note: This report shall not be reproduced except in full, without the written approval of Shenzhen Tongce Testing Lab.

This document may be altered or revised by Shenzhen Tongce Testing Lab. personnel only, and shall be noted in the revision section of the document. The test results in the report only apply to the tested sample.

TABLE OF CONTENTS

1. Test Certification..... 3

2. Test Result Summary 4

3. EUT Description 5

4. Genera Information..... 6

 4.1. Test environment and mode..... 6

 4.2. Test Mode..... 7

 4.3. Description of Support Units..... 8

 4.4. Configuration of Tested System 8

 4.5. Measurement Results Explanation Example..... 8

5. Facilities and Accreditations 9

 5.1. Facilities 9

 5.2. Location 9

 5.3. Measurement Uncertainty..... 9

6. Test Results and Measurement Data 10

 6.1. Conducted Output Power Measurement 10

 6.2. Peak to Average Ratio..... 12

 6.3. 99% Occupied Bandwidth and 26dB Bandwidth Measurement 17

 6.4. Band Edge and Conducted Spurious Emission Measurement 22

 6.5. Test Specification..... 22

 6.6. Effective Radiated Power and Effective Isotropic Radiated Power
 Measurement 35

 6.7. Field Strength of Spurious Radiation Measurement 42

 6.8. Frequency Stability Measurement 47

Appendix A: Photographs of Test Setup

Appendix B: Photographs of EUT

1. Test Certification

Product:	Smartphone
Model No.:	RLTP6067
Additional Model No.:	RLTP60XX(XX can be changed from 00 to 99), HN-MPX6000, HN-MPX60XX(XX can be changed from 00 to 99)
Applicant:	ShenZhen Harmony Technology Co.,Ltd
Address:	Block 2, Jiayuan Industrial Zone, Heping Community high-tech Park, No 2 Fuyuan Road, Fuyong, Bao'an, Shenzhen, China
Manufacturer:	ShenZhen Harmony Technology Co.,Ltd
Address:	Block 2, Jiayuan Industrial Zone, Heping Community high-tech Park, No 2 Fuyuan Road, Fuyong, Bao'an, Shenzhen, China
Date of Test:	Aug. 17,2016 –Sep. 12, 2016
Applicable Standards:	FCC CFR Title 47 Part 2 FCC 47 CFR PART 22 FCC 47 CFR PART 24 FCC 47 CFR PART 27

The above equipment has been tested by Shenzhen Tongce Testing Lab. and found compliance with the requirements set forth in the technical standards mentioned above. The results of testing in this report apply only to the product/system, which was tested. Other similar equipment will not necessarily produce the same results due to production tolerance and measurement uncertainties.

Tested By:



Beryl Zhao

Date:

Sep. 12, 2016

Reviewed By:



Joe Zhou

Date:

Sep. 13, 2016

Approved By:



Tomsin

Date:

Sep. 13, 2016

2. Test Result Summary

Requirement	CFR 47 Section	Result
Conducted Output Power	§22.913; §2.1046 §24.232; §27.50(d)	PASS
Peak-to-Average Ratio	§2.1046; §24.232(d) §27.50(d)	PASS
Effective Radiated Power	§2.1046; §22.913(a) §24.232; §27.50(d)	PASS
Equivalent Isotropic Radiated Power	§2.1046; §22.913(a) §24.232; §27.50(d)	PASS
Occupied Bandwidth	§2.1049	PASS
Band Edge	§2.1051 §22.917(a) §24.238(a) § 27.53(g)	PASS
Conducted Spurious Emission	§2.1051; §22.917 §24.238; § 27.53(h)	PASS
Field Strength of Spurious Radiation	§2.1053; §22.917(a) §24.238; § 27.53(g)	PASS
Frequency Stability for Temperature & Voltage	§2.1055; §22.355 §24.235; §27.54	PASS

Note:

1. PASS: Test item meets the requirement.
2. Fail: Test item does not meet the requirement.
3. N/A: Test case does not apply to the test object.
4. The test result judgment is decided by the limit of test standard.

3. EUT Description

Product Name:	Smartphone
Model :	RLTP6067
Additional Model:	RLTP60XX(XX can be changed from 00 to 99), HN-MPX6000, HN-MPX60XX(XX can be changed from 00 to 99)
Trade Mark:	N/A
Hardware Version:	AL_x5s_MB_V10
Software Version:	x5s_a_x60_20160804_0114
Tx Frequency:	GSM850: 824.2 MHz ~ 848.8 MHz GSM1900: 1850.2 MHz ~ 1909.8MHz WCDMA Band IV: 1712.4 MHz ~ 1752.6 MHz
Rx Frequency:	GSM850: 869.2 MHz ~ 893.8 MHz GSM1900: 1930.2 MHz ~ 1989.8 MHz WCDMA Band IV: 2112.4 MHz ~ 2152.6 MHz
Maximum Output Power to Antenna:	GSM850 : 32.57dBm GSM1900 : 30.67 dBm WCDMA Band IV : 23.57 dBm
99% Occupied Bandwidth:	GSM850: 247KGXM GSM1900: 246KGXM WCDMA Band IV RMC 12.2Kbps: 4M29F9W
Type of Modulation:	GSM: GMSK GPRS: GMSK WCDMA/HSDPA/HSUPA: QPSK
Antenna Type:	PIFA Antenna
Antenna Gain:	GSM 850: -0.4dbi GSM 1900: 0.2dbi WCDMA Band IV: 0.1dbi
Power Supply:	Adapter Information: MODEL: XRN-AC01 INPUT: AC100-240V~50/60Hz 0.1A OUTPUT: DC5V ± 0.5A , 1000mA ± 50mA

4. Genera Information

4.1. Test environment and mode

Operating Environment:	
Temperature:	24.0 °C
Humidity:	54 % RH
Atmospheric Pressure:	1010 mbar
Test Mode:	
Operation mode:	Keep the EUT in continuous transmitting with modulation
<p>The sample was placed 0.8m above the ground plane of 3m chamber. Measurements in both horizontal and vertical polarities were performed. During the test, each emission was maximized by: having the EUT continuously working, investigated all operating modes, rotated about all 3 axis (X, Y & Z) and considered typical configuration to obtain worst position, manipulating interconnecting cables, rotating the turntable, varying antenna height from 1m to 4m in both horizontal and vertical polarizations. The emissions worst-case are shown in Test Results of the following pages.</p>	

Description Operation Frequency

GSM 850		PCS1900	
Channel:	Frequency (MHz)	Channel:	Frequency (MHz)
128	824.20	512	1850.20
129	824.40	513	1850.40
....
189	836.40	660	1879.80
190	836.60	661	1880.00
191	836.80	662	1880.20
...
250	848.60	809	1909.60
251	848.80	810	1909.80

WCDMA Band IV		WCDMA Band V		WCDMA Band II	
Channel:	Frequency (MHz)	Channel:	Frequency (MHz)	Channel:	Frequency (MHz)
1312	1712.4	4132	826.40	9262	1852.40
....	4133	826.60	9263	1852.60
....
....	4182	836.40	9399	1879.80
1413	1732.6	4183	836.60	9400	1880.00
....	4184	836.80	9401	1880.20
....
1513	1752.6	4233	846.60	9538	1907.60

4.2. Test Mode

Antenna port conducted and radiated test items were performed according to KDB 971168 D01 Power Meas. License Digital Systems v02r02 with maximum output power. Radiated measurements were performed with rotating EUT in different three orthogonal test planes to find the maximum emission.

Radiated emissions were investigated as following frequency range:

1. 30 MHz to 9000 MHz for GSM850.
2. 30 MHz to 19000 MHz for PCS1900.

All modes and data rates and positions were investigated.

Test modes are chosen to be reported as the worst case configuration below:

Test Mode		
Band	Radiated TCs	Conducted TCs
GSM 850	GSM Link GPRS class 8 Link	GSM Link GPRS class 8 Link
PCS 1900	GSM Link GPRS class 8 Link	GSM Link GPRS class 8 Link
WCDMA Band IV	RMC 12.2Kbps Link	RMC 12.2Kbps Link

Note: The maximum power levels are chosen to test as the worst case configuration as follows:

GSM multi-slot class 8 mode for GMSK modulation,

GPRS multi-slot class 8 mode for GMSK modulation, Only these modes were used for all tests. In addition to above worst-case test, below investigating on all data rates, and all modes are compliance with each FCC test case which has specific test limits. For spurious emissions at antenna port, the EUT was investigated the band edges on low and high channels, and the unwanted spurious emissions on middle channel for all modes, the results are PASS, then only the worst-results were reported in the test report. The Radiated Spurious emissions for GSM/GPRS modes were investigated on the middle channel and the PASS results were not worst than those data tested from the highest power channels.

4.3. Description of Support Units

The EUT has been tested as an independent unit together with other necessary accessories or support units. The following support units or accessories were used to form a representative test configuration during the tests.

Equipment	Model No.	Serial No.	FCC ID	Trade Name

Note:

1. All the equipment/cables were placed in the worst-case configuration to maximize the emission during the test.
2. Grounding was established in accordance with the manufacturer's requirements and conditions for the intended use.

4.4. Configuration of Tested System

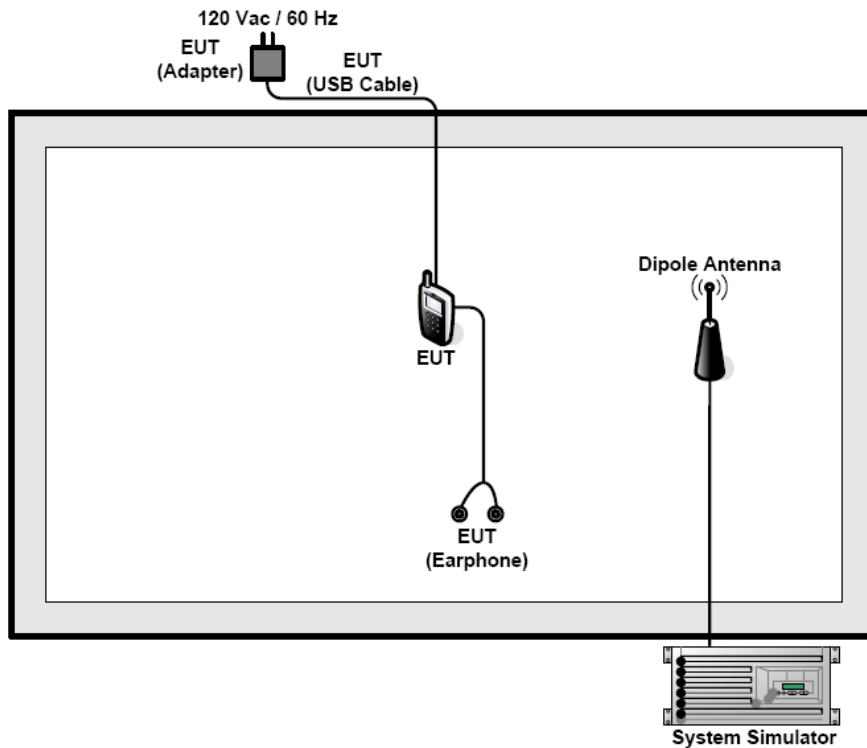

4.5. Measurement Results Explanation Example

For all conducted test items:

The offset level is set in the spectrum analyzer to compensate the RF cable loss and attenuator factor between RF conducted output port and spectrum analyzer. With the offset compensation, the spectrum analyzer reading level will be exactly the RF output level. The spectrum analyzer offset is derived from RF cable loss and attenuator factor.
 $Offset = RF\ cable\ loss + attenuator\ factor.$

5. Facilities and Accreditations

5.1. Facilities

The test facility is recognized, certified, or accredited by the following organizations:

- FCC - Registration No.: 572331

Shenzhen Tongce Testing Lab.

The 3m Semi-anechoic chamber has been registered and fully described in a report with the (FCC) Federal Communications Commission. The acceptance letter from the FCC is maintained in our files.

- IC - Registration No.: 10668A-1

The 3m Semi-anechoic chamber of Shenzhen TCT Testing Technology Co., Ltd. has been registered by Certification and Engineering Bureau of Industry Canada for radio equipment testing

- CNAS - Registration No.: CNAS L6165

Shenzhen TCT Testing Technology Co., Ltd. is accredited to ISO/IEC 17025:2005 General Requirements for the Competence of Testing and Calibration laboratories for the competence of testing. The Registration No. is CNAS L6165.

5.2. Location

Shenzhen Tongce Testing Lab.

Address: 1F, Leinuo Watch Building, Fuyong Town, Baoan Dist, Shenzhen, China
Tel: 86-755-36638142

5.3. Measurement Uncertainty

The reported uncertainty of measurement $y \pm U$, where expanded uncertainty U is based on a standard uncertainty multiplied by a coverage factor of $k=2$, providing a level of confidence of approximately 95 %.

No.	Item	MU
1	Conducted Emission	$\pm 2.56\text{dB}$
2	RF power, conducted	$\pm 0.12\text{dB}$
3	Spurious emissions, conducted	$\pm 0.11\text{dB}$
4	All emissions, radiated(<1G)	$\pm 3.92\text{dB}$
5	All emissions, radiated(>1G)	$\pm 4.28\text{dB}$
6	Temperature	$\pm 0.1^\circ\text{C}$
7	Humidity	$\pm 1.0\%$

6. Test Results and Measurement Data

6.1. Conducted Output Power Measurement

6.1.1. Test Specification

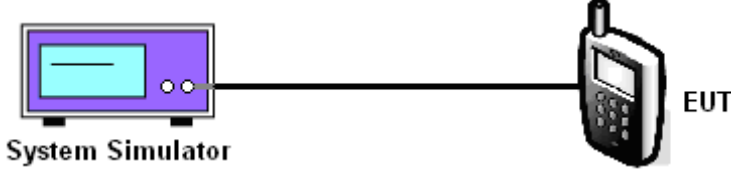
Test Requirement:	FCC part 22.913(a) and FCC part 24.232, FCC part 27.50(d);
Test Method:	FCC part 2.1046
Limits:	GSM 850: 7W PCS 1900: 2W WCDMA Band IV: 1W
Test Setup:	 <p>The diagram illustrates the test setup. On the left is a purple 'System Simulator' with a screen and two ports. A black cable connects one of these ports to the back of a silver mobile phone labeled 'EUT' on the right.</p>
Test Procedure:	<ol style="list-style-type: none"> 1. The transmitter output port was connected to the system simulator. 2. Set EUT at maximum power through system simulator. 3. Select lowest, middle, and highest channels for each band and different modulation. 4. Measure the maximum burst average power for GSM and maximum average power for other modulation signal.
Test Result:	PASS

6.1.2. Test Instruments

Equipment	Manufacturer	Model	Serial Number	Calibration Due
System simulator	R&S	CMU200	111382	Aug. 11, 2017

Note: The calibration interval of the above test instruments is 12 months and the calibrations are traceable to international system unit (SI).

6.1.3. Test data

Conducted Power Measurement Results:

Conducted Power (*Unit: dBm)						
Band	GSM850			PCS 1900		
Channel	128	190	251	512	661	810
Frequency(MHz)	824.2	836.6	848.8	1850.2	1880.0	1909.8
GSM	32.15	32.36	32.57	30.01	30.28	30.67
GPRS class8	31.91	32.15	32.38	29.63	29.81	30.15
GPRS class10	31.67	31.92	31.76	29.25	29.53	29.84
GPRS class11	30.08	30.63	30.49	28.71	28.22	28.47
GPRS class12	29.83	29.87	29.89	27.36	27.49	27.76

Conducted Power (*Unit: dBm)			
Band	WCDMA Band IV		
Channel	1312	1413	1513
Frequency(MHz)	1712.4	1732.6	1752.6
RMC 12.2K	23.52	23.47	23.36
RMC 64K	23.27	23.41	23.12
RMC 144K	23.16	23.21	22.86
RMC 384K	23.04	22.86	22.32
HSDPA Subtest-1	22.68	22.63	22.15
HSDPA Subtest-2	22.31	22.47	21.86
HSDPA Subtest-3	22.05	22.15	21.52
HSDPA Subtest-4	21.98	22.02	21.07
HSUPA Subtest-1	21.46	21.78	21.65
HSUPA Subtest-2	21.23	21.35	21.39
HSUPA Subtest-3	20.95	21.09	20.12
HSUPA Subtest-4	20.67	20.86	20.64
HSUPA Subtest-5	20.24	20.67	20.24

Note: Maximum Burst Average Power for GSM.

6.2. Peak to Average Ratio

6.2.1. Test Specification

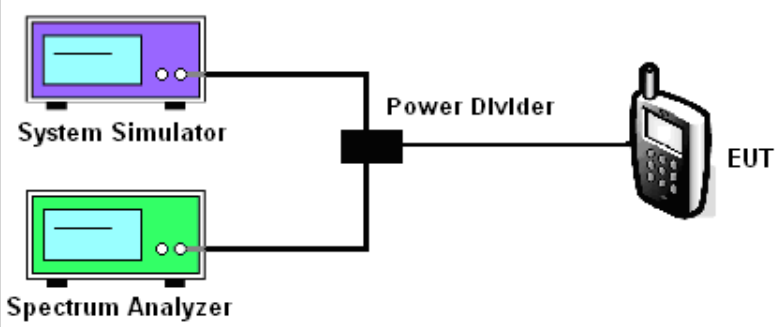
Test Requirement:	FCC part 24.232(d) ; FCC part 22.913; FCC part 27.50(d);
Test Method:	FCC part 24.232(d)
Limit:	The peak-to-average ratio (PAR) of the transmission may not exceed 13 dB.
Test Setup:	 <p>The diagram illustrates the test setup. On the left, there are two computer monitors: a purple one labeled 'System Simulator' and a green one labeled 'Spectrum Analyzer'. Both are connected to a central black box labeled 'Power Divider'. From the 'Power Divider', a single line extends to the right, connecting to a mobile phone icon labeled 'EUT'.</p>
Test Procedure:	<ol style="list-style-type: none"> 1. The testing follows FCC KDB 971168 v02r02 Section 5.7.1. 2. The EUT was connected to spectrum analyzer and system simulator via a power divider. 3. Set EUT to transmit at maximum output power. 4. For GSM/EGPRS operating modes, signal gating is implemented on the spectrum analyzer by triggering from the system simulator. 5. Set the CCDF (Complementary Cumulative Distribution Function) option of the spectrum analyzer. Record the maximum PAPR level associated with a probability of 0.1%.
Test Result:	PASS

6.2.2. Test Instruments

Equipment	Manufacturer	Model	Serial Number	Calibration Due
System simulator	R&S	CMU200	111382	Aug. 11, 2017
Spectrum Analyzer	Agilent	N9020A	MY49100060	Aug. 12, 2017

Note: The calibration interval of the above test instruments is 12 months and the calibrations are traceable to international system unit (SI).

6.2.3. Test Data

Mode	GSM850 (GSM)			WCDMA Band V (RMC 12.2Kbps)		
	128	190	251	512	661	810
Frequency (MHz)	824.2	836.6	848.8	1850.2	1880.0	1909.8
Peak-to-Average Ratio (dB)	9.00	9.20	8.99	8.75	9.59	9.84

Mode	WCDMA Band IV (RMC 12.2Kbps)		
	1312	1413	1513
Frequency (MHz)	1712.4	1732.6	1752.6
Peak-to-Average Ratio (dB)	2.97	3.08	2.92

Note: Maximum Burst Average Power for GSM.

Test plots as follows:

GSM 850

Peak-to-Average Ratio on Channel 128

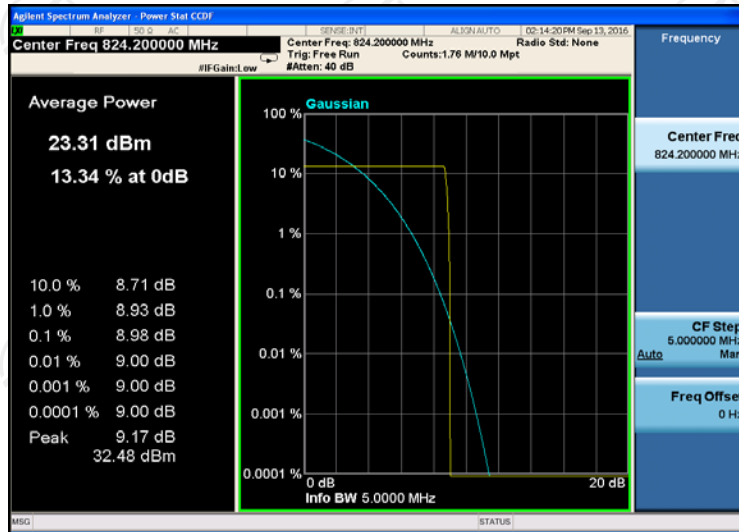

Peak-to-Average Ratio on Channel 190

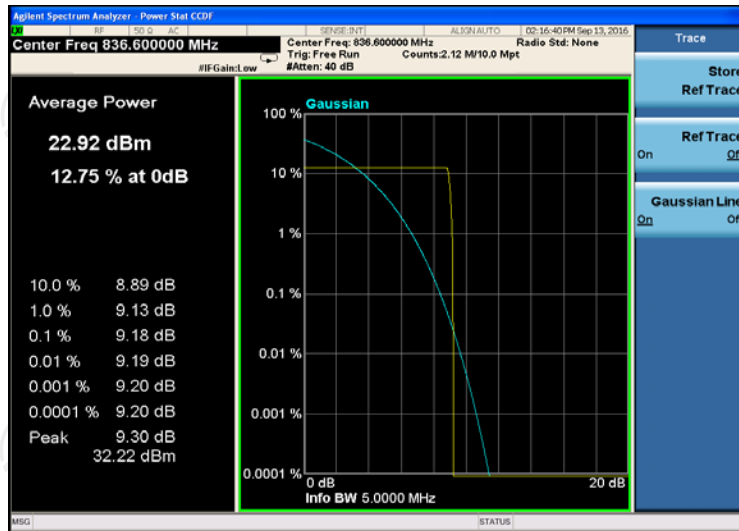

Peak-to-Average Ratio on Channel 251

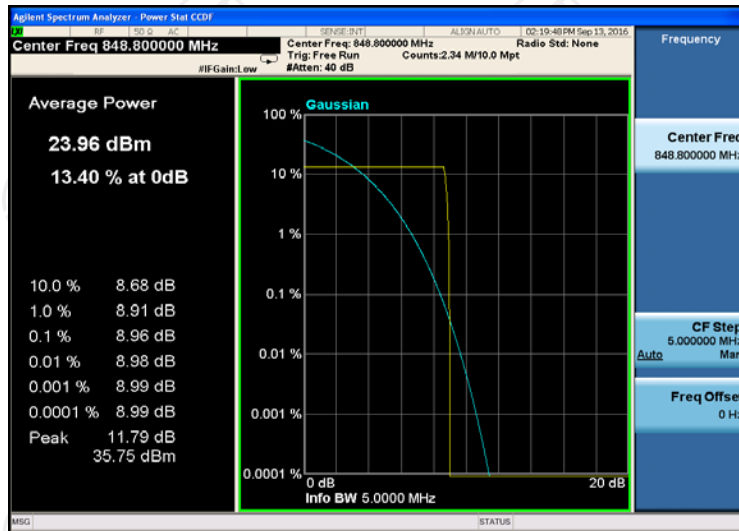

GSM 1900

Peak-to-Average Ratio on Channel 512

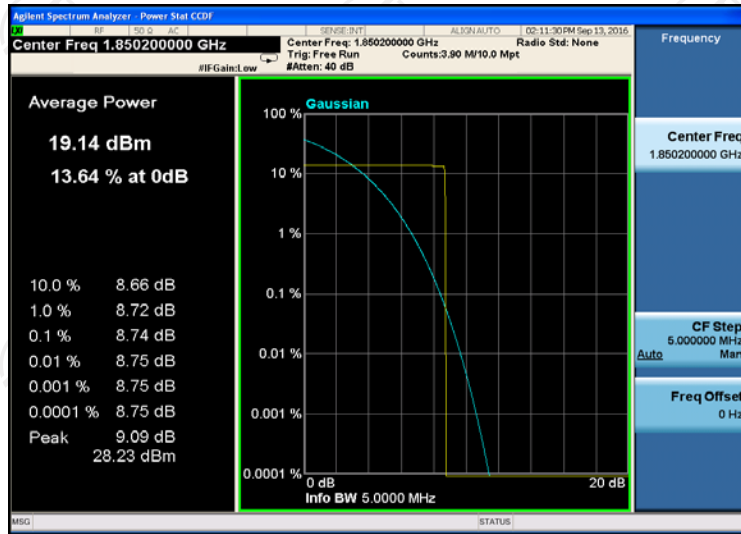

Peak-to-Average Ratio on Channel 661

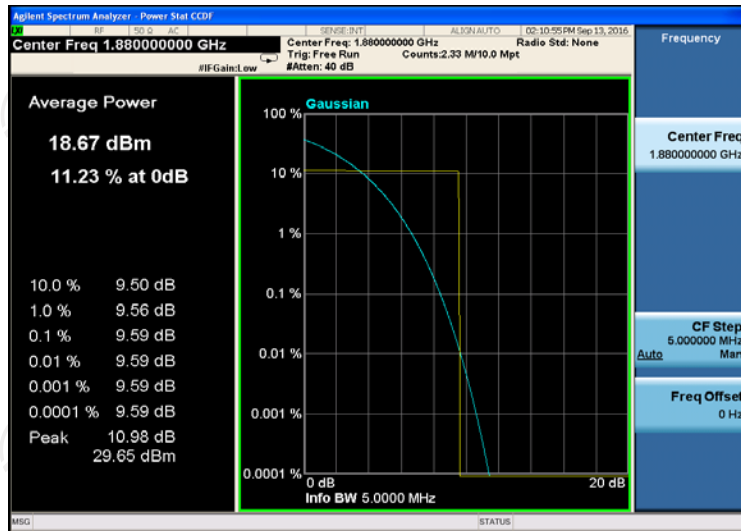

Peak-to-Average Ratio on Channel 810

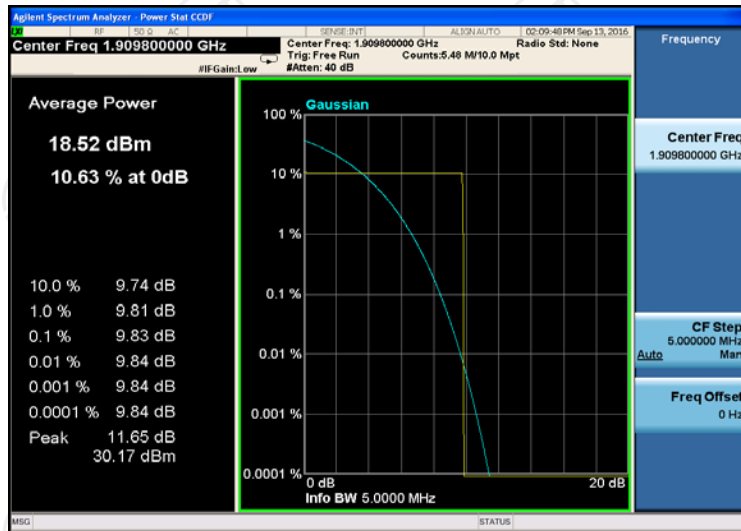

WCDMA Band IV 12.2Kbps

Peak-to-Average Ratio on Channel 1312

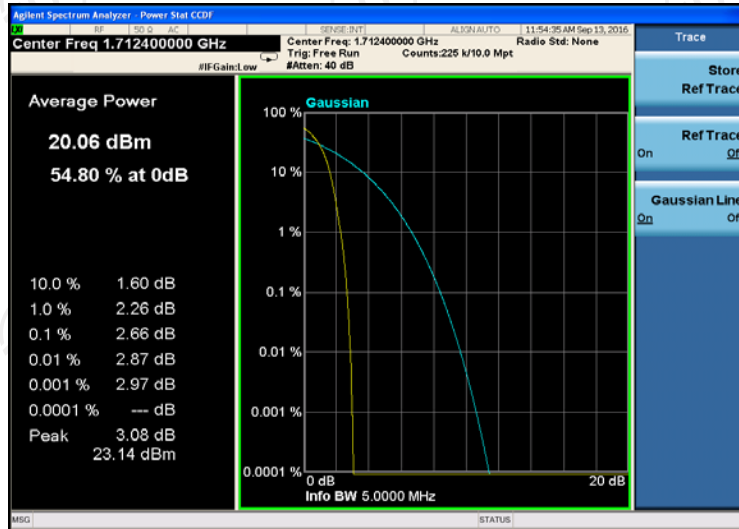

Peak-to-Average Ratio on Channel 1413

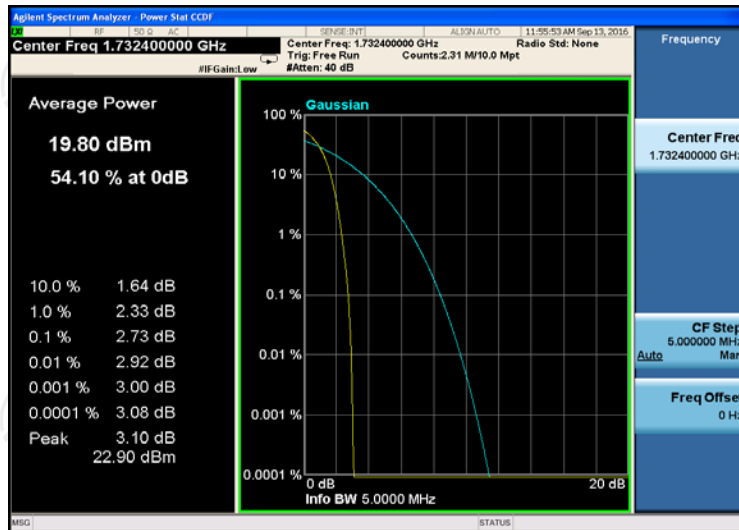

Peak-to-Average Ratio on Channel 1513

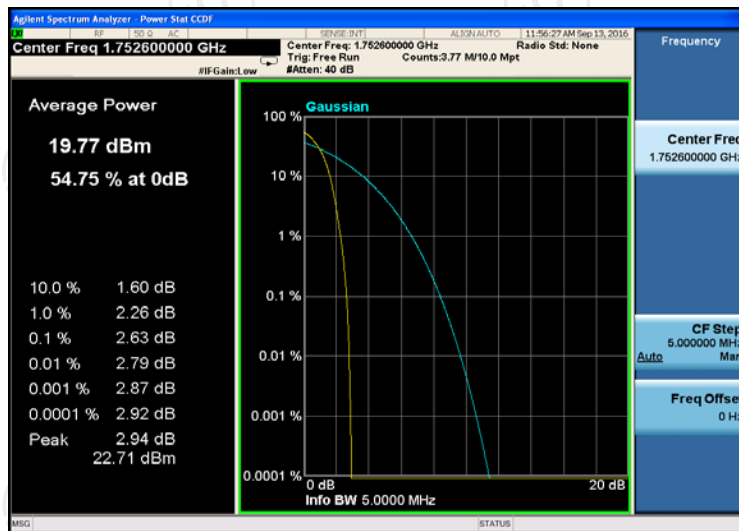

6.3. 99% Occupied Bandwidth and 26dB Bandwidth Measurement

6.3.1. Test Specification

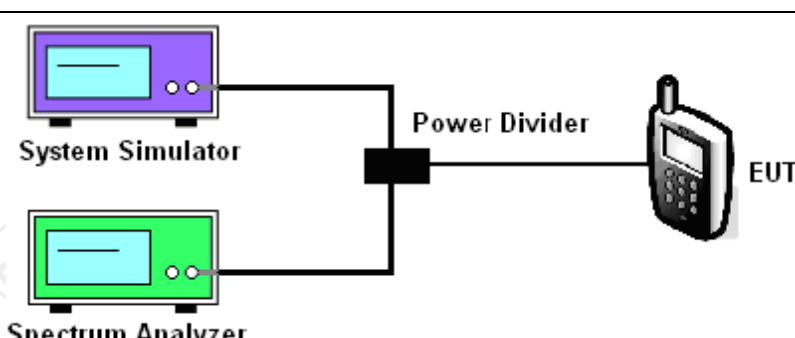
Test Requirement:	FCC part 2.1049
Test Method:	FCC part 2.1049
Limit:	N/A
Test Setup:	 <p>The diagram illustrates the test setup. On the left, there are two computer monitors: the top one is labeled 'System Simulator' and the bottom one is labeled 'Spectrum Analyzer'. Both are connected to a central 'Power Divider' block. From the Power Divider, a cable leads to a mobile phone icon labeled 'EUT' (Equipment Under Test).</p>
Test Procedure:	<ol style="list-style-type: none"> 1. The testing follows FCC KDB 971168 v02r02 Section 4.2. 2. The EUT was connected to the spectrum analyzer and system simulator via a power divider. 3. The RF output of the EUT was connected to the spectrum analyzer by RF cable and attenuator. The path loss was compensated to the results for each measurement. 4. The 99% occupied bandwidth were measured, set RBW= 1% of span, VBW= 3*RBW, sample detector, trace maximum hold. 5. The 26dB bandwidth were measured, set RBW= 1% of EBW, VBW= 3*RBW, peak detector, trace maximum hold.
Test Result:	PASS

6.3.2. Test Instruments

Equipment	Manufacturer	Model	Serial Number	Calibration Due
System simulator	R&S	CMU200	111382	Aug. 11, 2017
Spectrum Analyzer	Agilent	N9020A	MY49100060	Aug. 12, 2017

Note: The calibration interval of the above test instruments is 12 months and the calibrations are traceable to international system unit (SI).

6.3.3. Test data

Cellular Band						
Mode	GSM850 (GSM)			GSM 1900 (GSM)		
Channel	128	190	251	512	661	810
Frequency (MHz)	824.2	836.6	848.8	1850.2	1880.0	1908.8
99% OBW (kHz)	245.19	245.19	246.79	243.59	243.59	246.44
26dB BW (kHz)	325.32	318.91	317.31	323.72	320.51	315.71

Mode	WCDMA Band IV (RMC 12.2Kbps)		
Channel	1312	1413	1513
Frequency (MHz)	1712.4	1732.6	1752.6
99% OBW (kHz)	4294.87	4230.77	4208
26dB BW (kHz)	5048.08	4903.85	5592.95

Test plots as follows:

Band:	GSM 850	Test Mode:	GSM Link (GMSK)
-------	---------	------------	-----------------

26dB&99% Occupied Bandwidth Plot on Channel 128

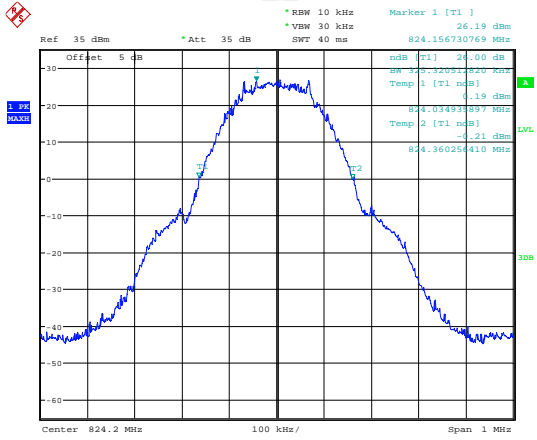

Date: 29.AUG.2016 13:54:26

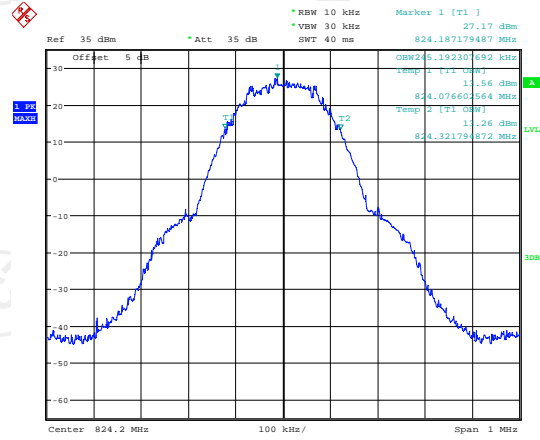

Date: 29.AUG.2016 13:53:26

26dB&99% Occupied Bandwidth Plot on Channel 190

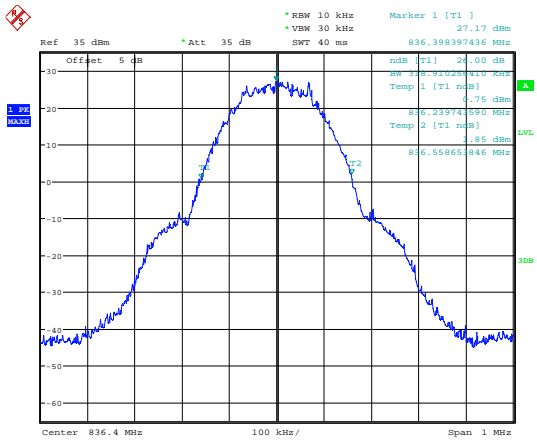

Date: 29.AUG.2016 13:56:28

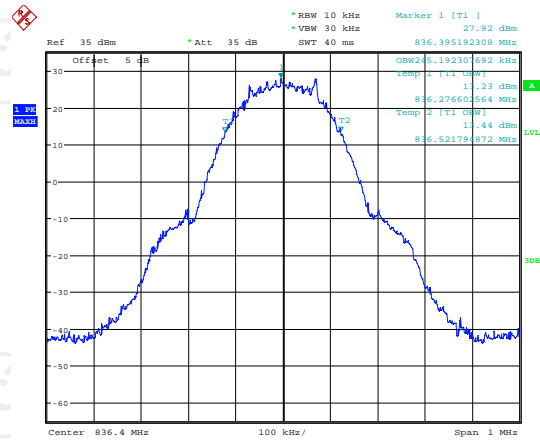

Date: 29.AUG.2016 13:57:44

26dB&99% Occupied Bandwidth Plot on Channel 251

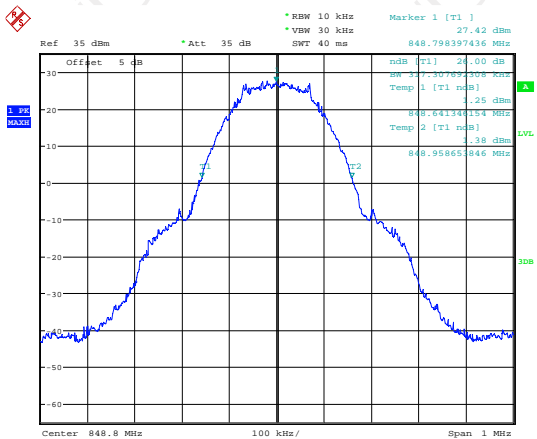

Date: 29.AUG.2016 14:00:41

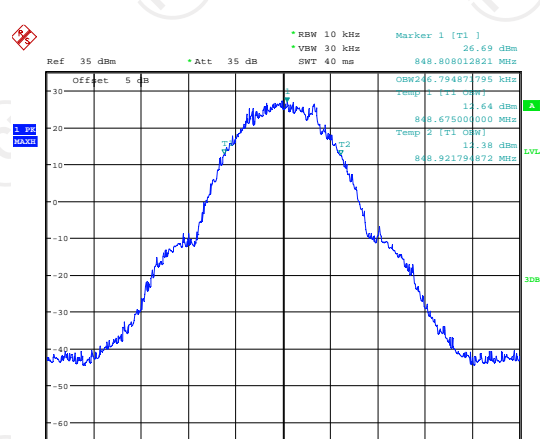

Date: 29.AUG.2016 13:58:46

Band: GSM 1900 **Test Mode: GSM Link (GMSK)**

26dB&99% Occupied Bandwidth Plot on Channel 512

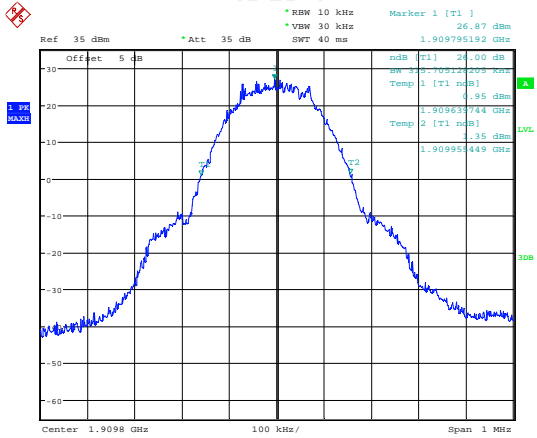

Date: 29.AUG.2016 13:47:22

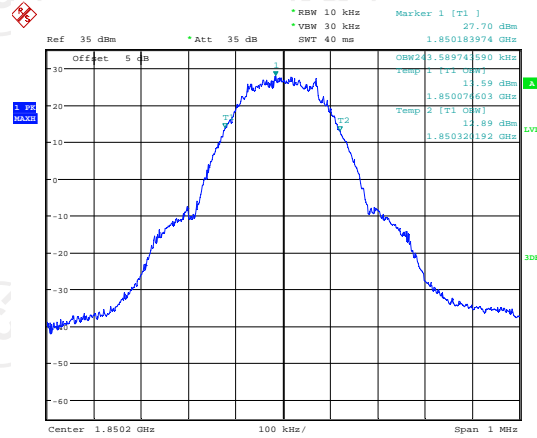

Date: 29.AUG.2016 13:45:02

26dB&99% Occupied Bandwidth Plot on Channel 661

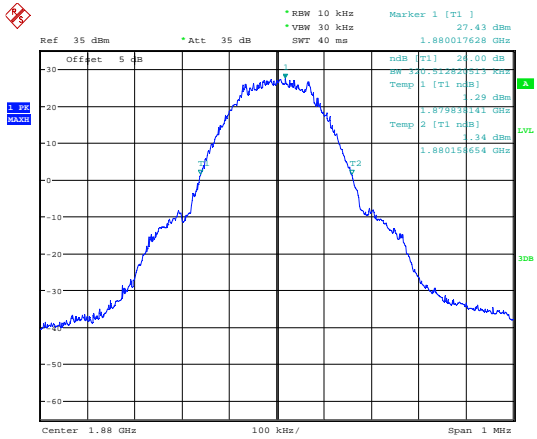

Date: 29.AUG.2016 15:37:47

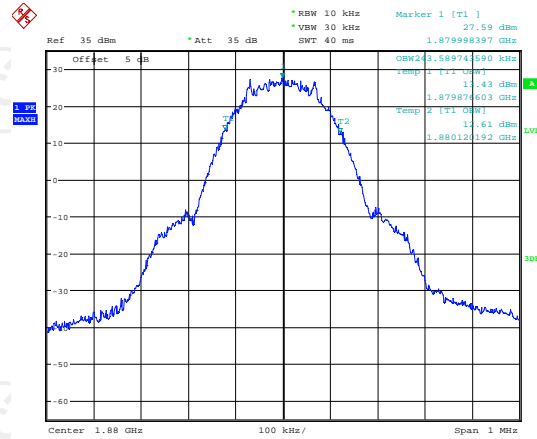

Date: 29.AUG.2016 15:42:03

26dB&99% Occupied Bandwidth Plot on Channel 810

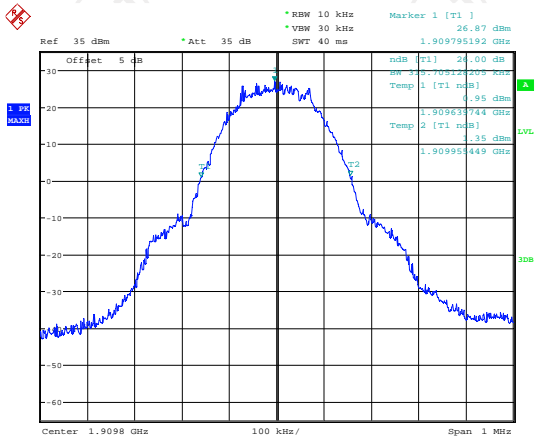

Date: 29.AUG.2016 13:47:22



Band:	WCDMA Band IV	Test Mode:	RMC 12.2Kbps Link (QPSK)
-------	---------------	------------	--------------------------

26dB&99% Occupied Bandwidth Plot on Channel 1312

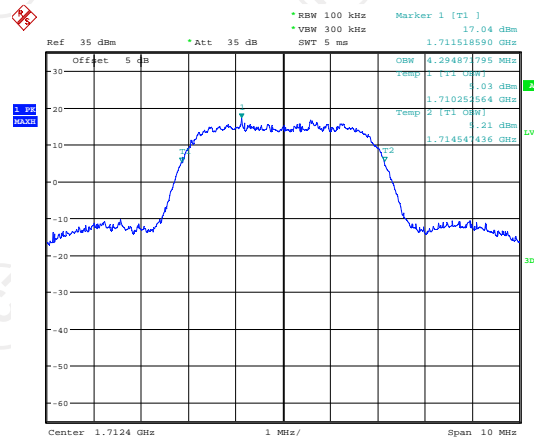
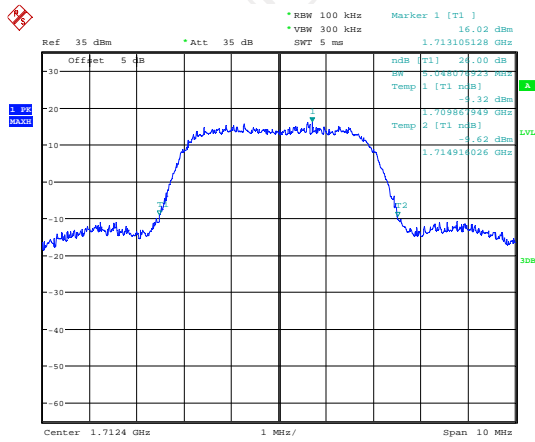

Date: 29.AUG.2016 16:53:10

Date: 29.AUG.2016 16:52:29

26dB&99% Occupied Bandwidth Plot on Channel 1413

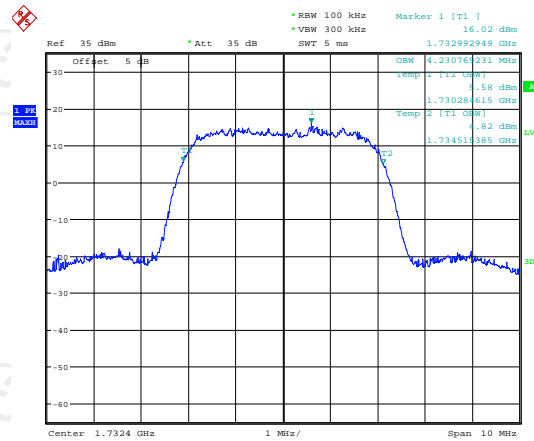
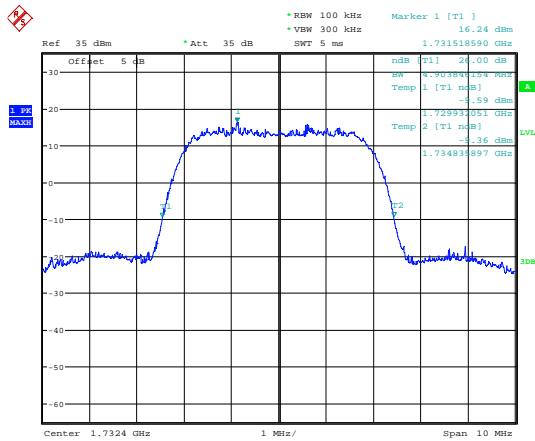

Date: 29.AUG.2016 16:54:26

Date: 29.AUG.2016 16:54:49

26dB&99% Occupied Bandwidth Plot on Channel 1513

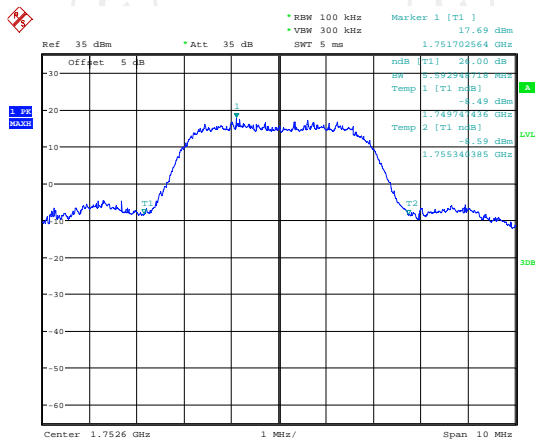

Date: 29.AUG.2016 17:10:42

6.4. Band Edge and Conducted Spurious Emission Measurement

6.5. Test Specification

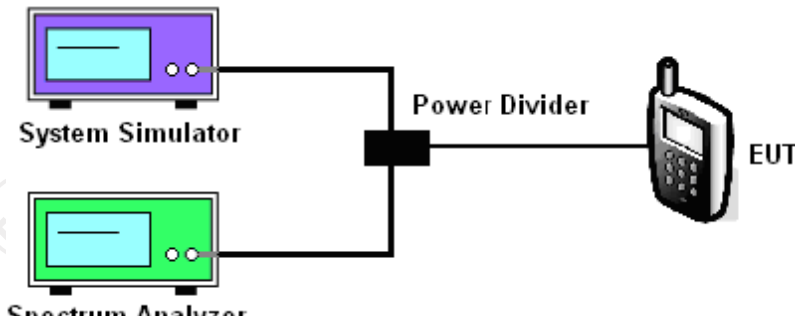
Test Requirement:	FCC part22.917(a) ;FCC part24.238(a); FCC part24.238(a)
Test Method:	FCC part2.1051
Limit:	-13dBm
Test Setup:	 <p>The diagram illustrates the test setup. On the left, there are two computer monitors representing the 'System Simulator' (top) and 'Spectrum Analyzer' (bottom). Both are connected to a central 'Power Divider' block. From the Power Divider, a single line connects to a mobile phone icon labeled 'EUT' (Equipment Under Test).</p>
Test Procedure:	<ol style="list-style-type: none"> 1. The testing follows FCC KDB 971168 v02r02 Section 6.0. 2. The EUT was connected to the spectrum analyzer and system simulator via a power divider. 3. The RF output of EUT was connected to the spectrum analyzer by an RF cable and attenuator. The path loss was compensated to the results for each measurement. 4. The band edges of low and high channels for the highest RF powers were measured. 5. The conducted spurious emission for the whole frequency range was taken. 6. The RF fundamental frequency should be excluded against the limit line in the operating frequency band. 7. The limit line is derived from $43 + 10\log(P)$ dB below the transmitter power $P(\text{Watts}) = P(W) - [43 + 10\log(P)] (\text{dB}) = [30 + 10\log(P)] (\text{dBm}) - [43 + 10\log(P)] (\text{dB}) = -13\text{dBm}.$
Test Result:	PASS

6.5.1. Test Instruments

Equipment	Manufacturer	Model	Serial Number	Calibration Due
System simulator	R&S	CMU200	111382	Aug. 11, 2017
Spectrum Analyzer	Agilent	N9020A	MY49100060	Aug. 12, 2017

Note: The calibration interval of the above test instruments is 12 months and the calibrations are traceable to international system unit (SI).

6.5.2. Test data

Test plots as follows:

Band:	GSM 850	Test Mode:	GSM Link (GMSK)
-------	---------	------------	-----------------

Lower Band Edge Plot on Channel 128

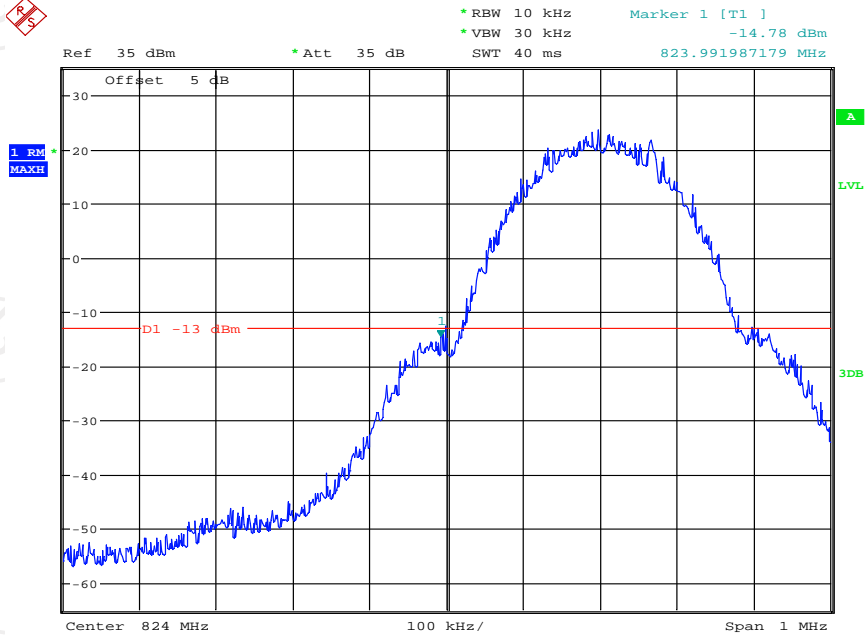

Date: 29.AUG.2016 16:02:23

Higher Band Edge Plot on Channel 251

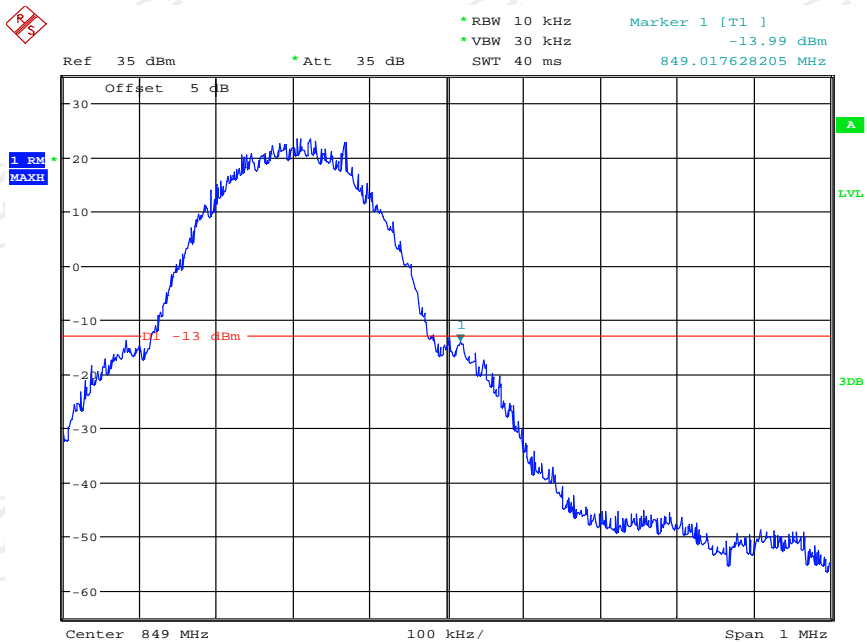

Date: 29.AUG.2016 16:04:30

Band:	GSM 1900	Test Mode:	GSM Link (GMSK)
-------	----------	------------	-----------------

Lower Band Edge Plot on Channel 512



Higher Band Edge Plot on Channel 810

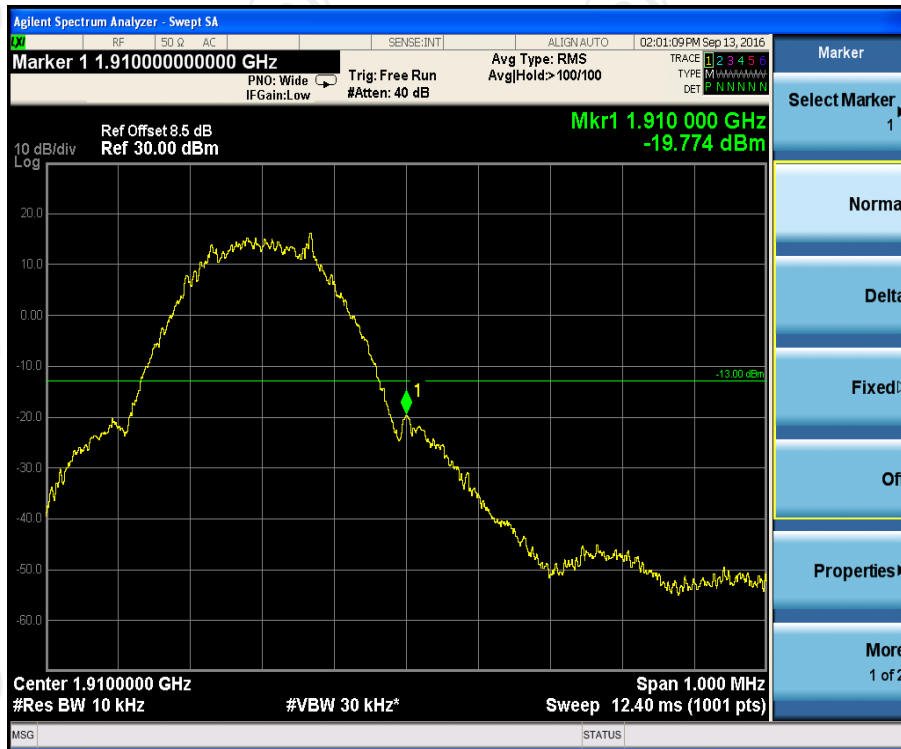

Band:	WCDMA Band IV	Test Mode:	RMC 12.2Kbps Link (QPSK)
-------	---------------	------------	--------------------------

Lower Band Edge Plot on Channel 1312

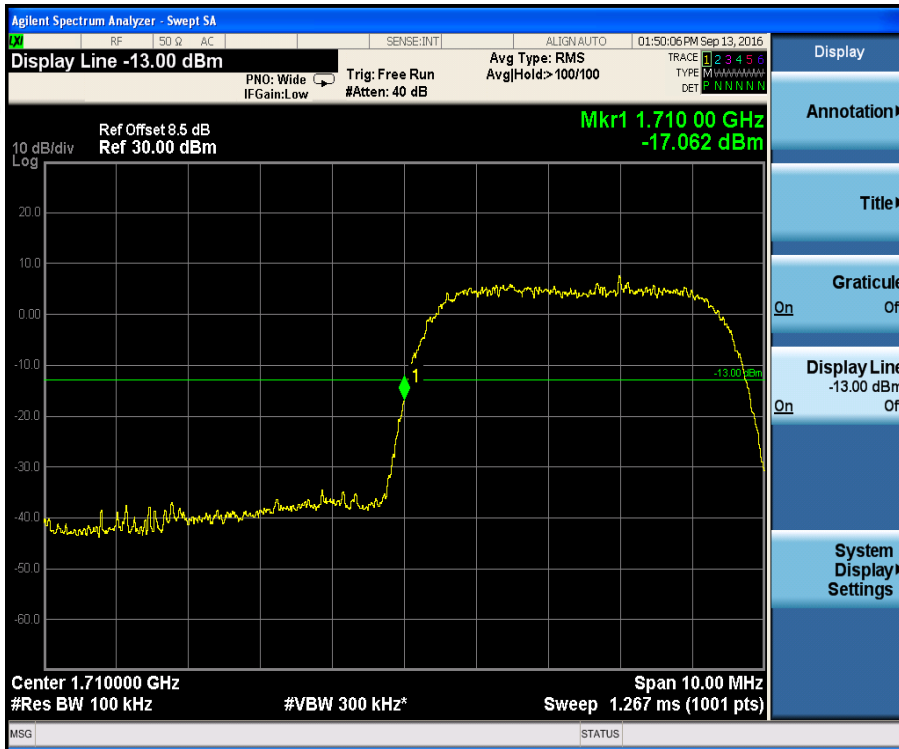

Higher Band Edge Plot on Channel 1513



Band: GSM 850 Test Mode: GSM Link (GMSK)

Conducted Spurious Emission on Channel 128

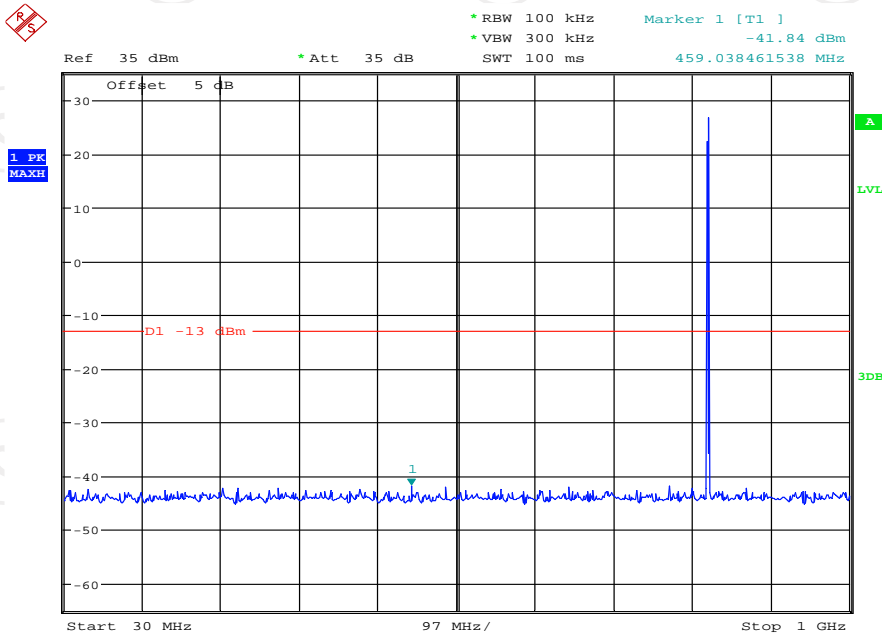

Date: 29.AUG.2016 16:18:47

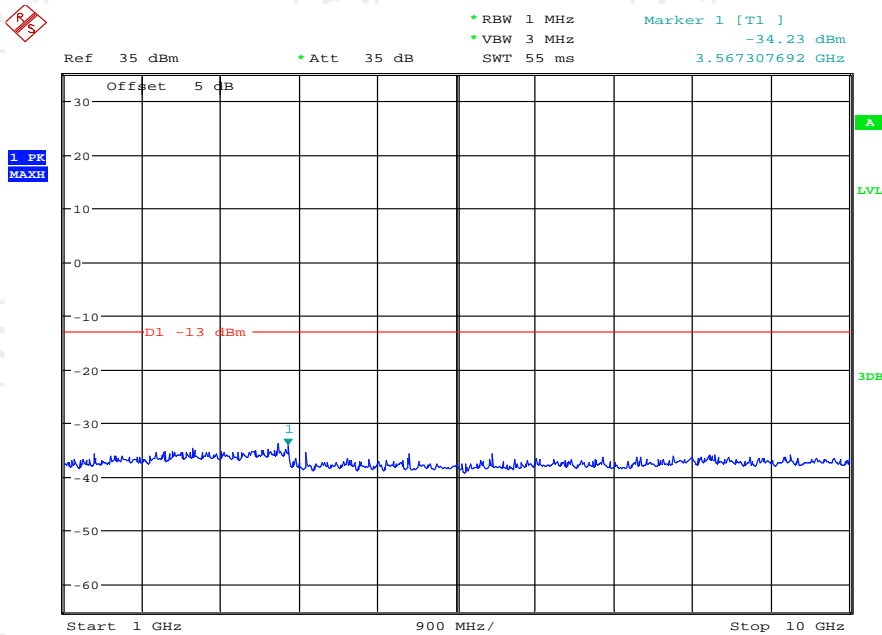

Date: 29.AUG.2016 16:20:10

Conducted Spurious Emission on Channel 190

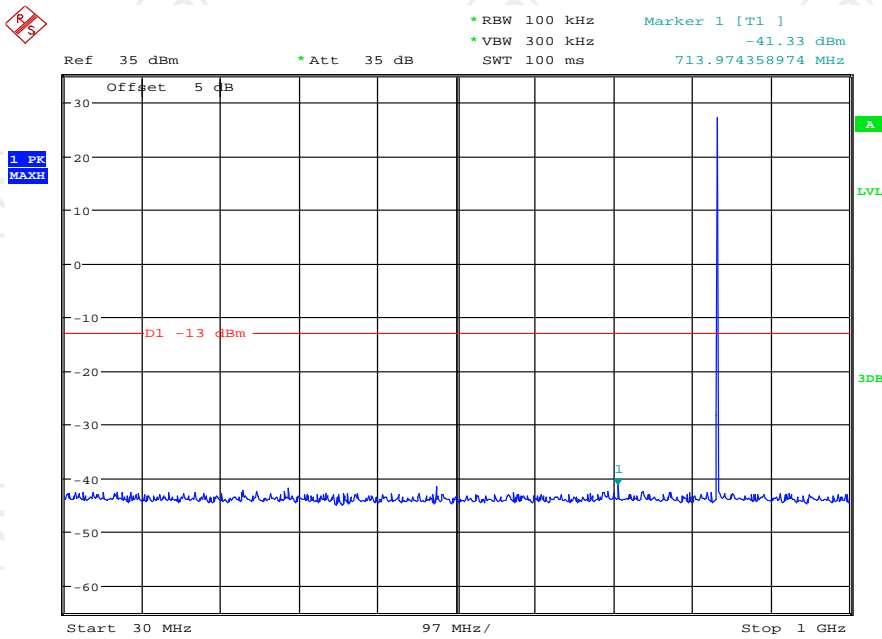

Date: 29.AUG.2016 16:17:57

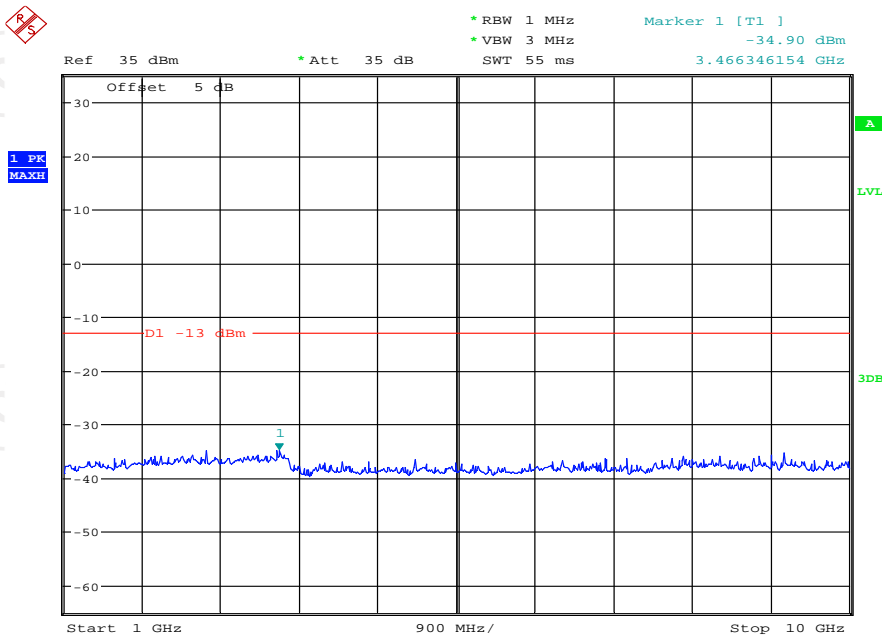

Date: 29.AUG.2016 16:16:47

Conducted Spurious Emission on Channel 251

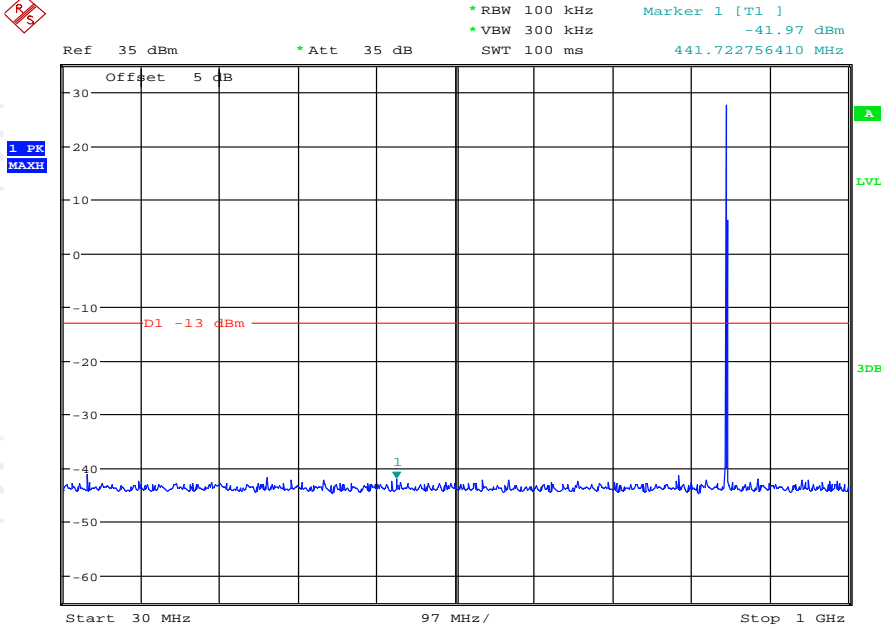

Date: 29.AUG.2016 16:15:24

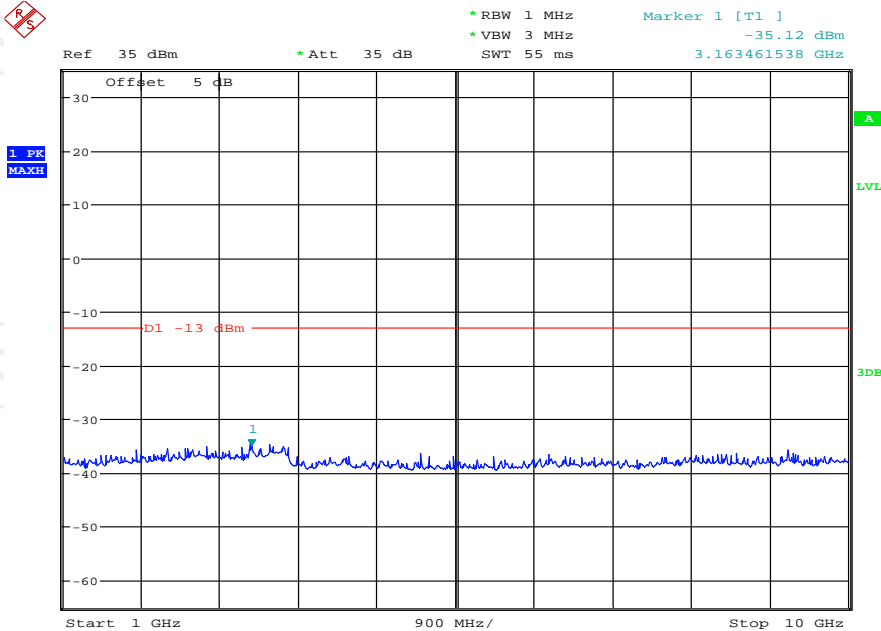

Date: 29.AUG.2016 16:15:53

Band: GSM 1900 Test Mode: GSM Link (GMSK)

Conducted Spurious Emission on Channel 512

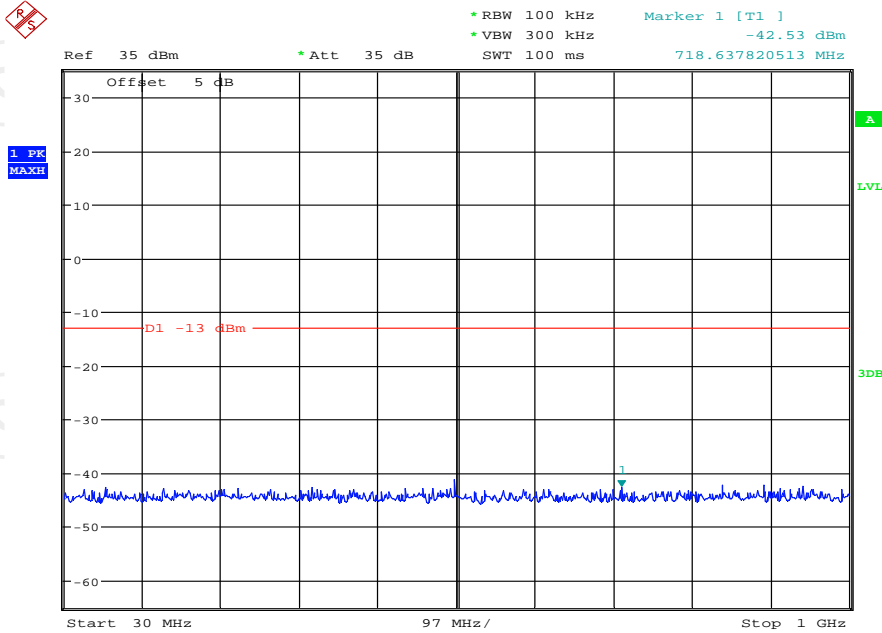

Date: 29.AUG.2016 16:28:23

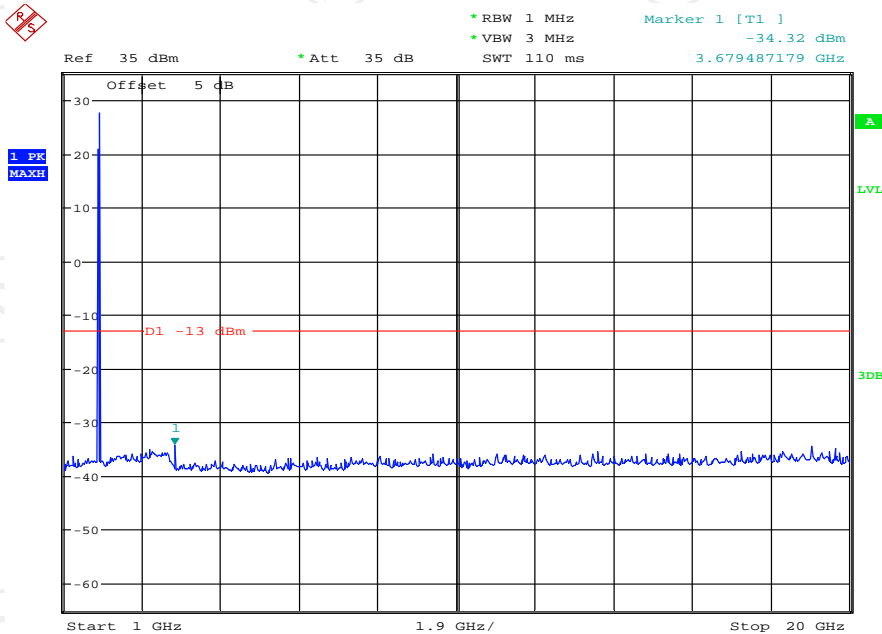

Date: 29.AUG.2016 16:28:49

Conducted Spurious Emission on Channel 661

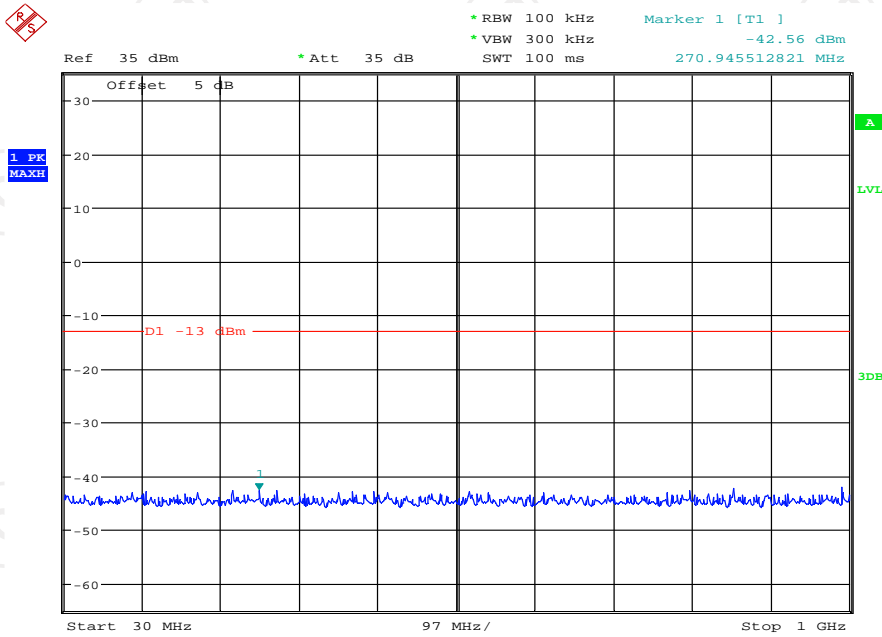

Date: 29.AUG.2016 16:27:53

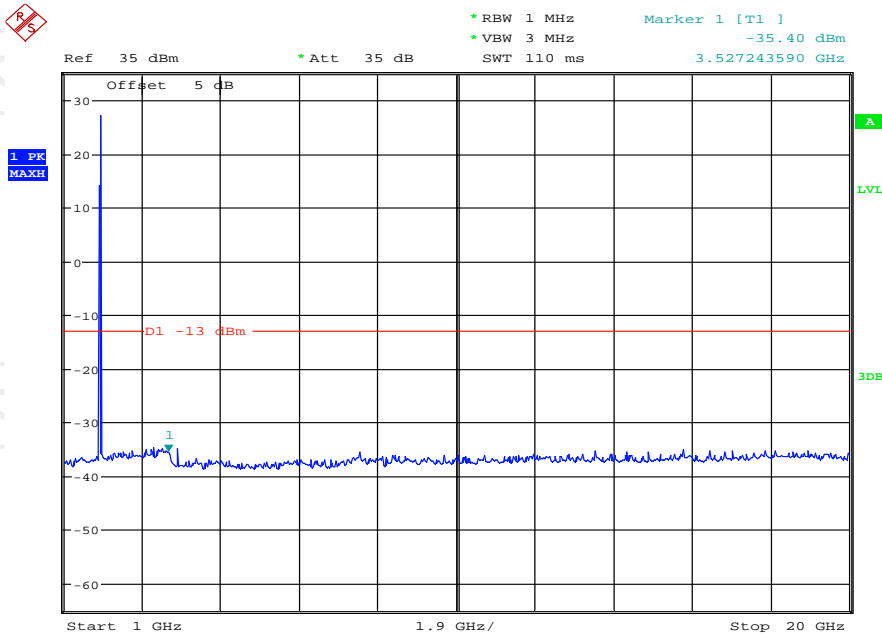

Date: 29.AUG.2016 16:27:32

Conducted Spurious Emission on Channel 810

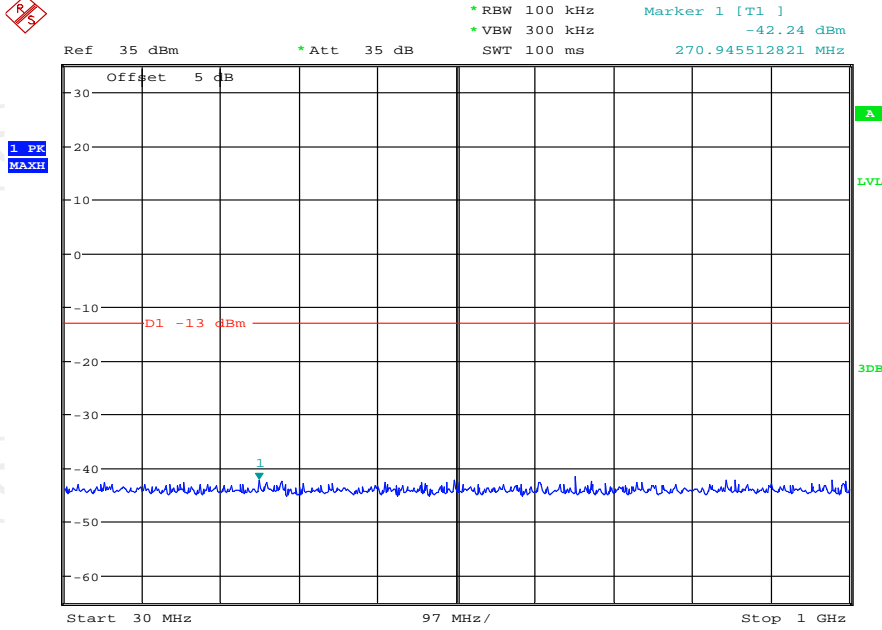

Date: 29.AUG.2016 16:25:23

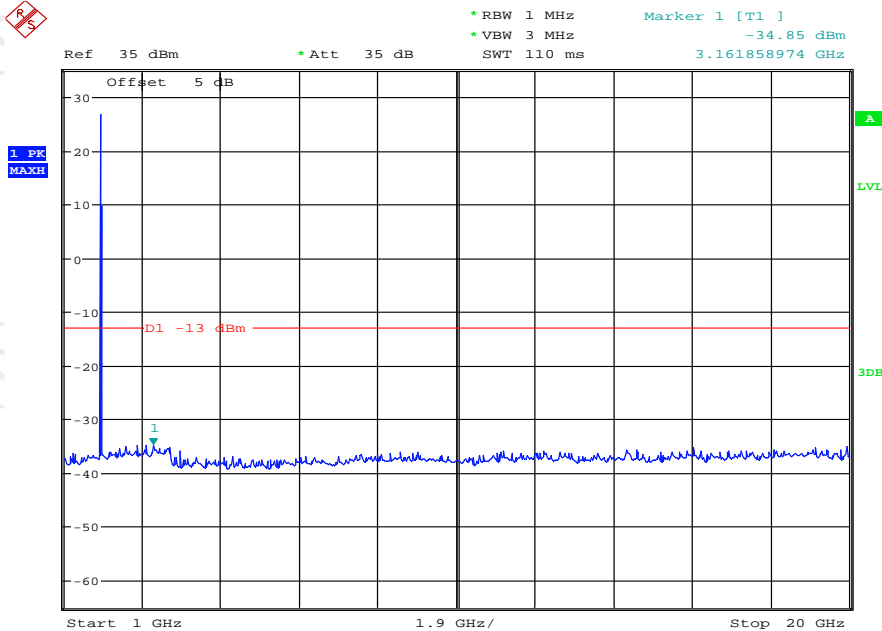

Date: 29.AUG.2016 16:26:08

Band:	WCDMA Band IV	Test Mode:	RMC 12.2Kbps Link (QPSK)
-------	---------------	------------	--------------------------

Conducted Spurious Emission on Channel 1312

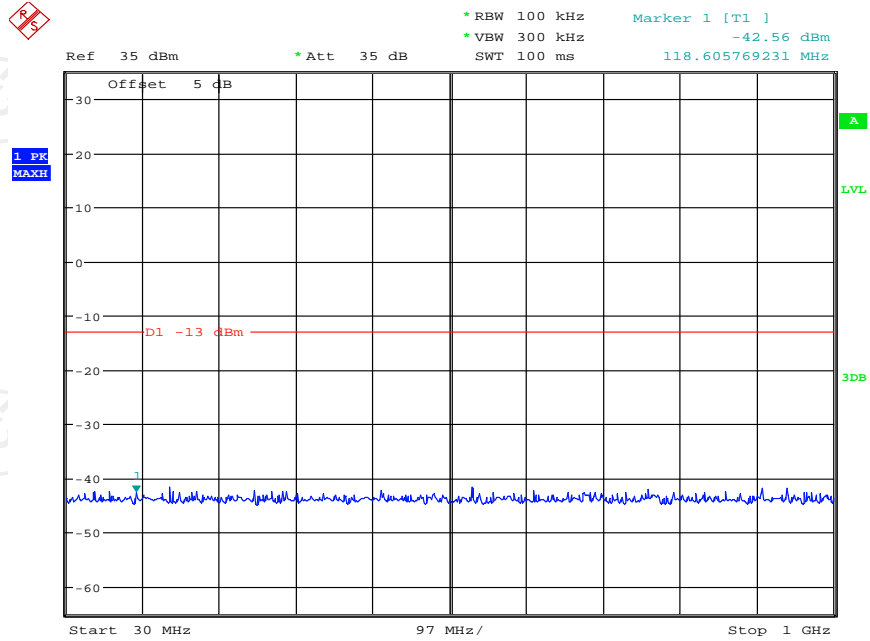

Date: 29.AUG.2016 18:30:24

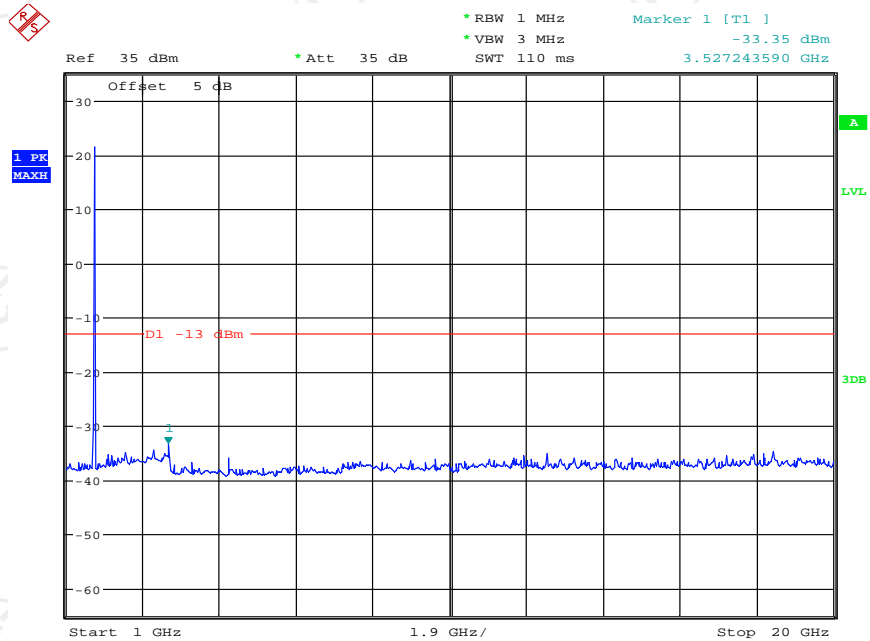

Date: 29.AUG.2016 18:31:03

Conducted Spurious Emission on Channel 1413

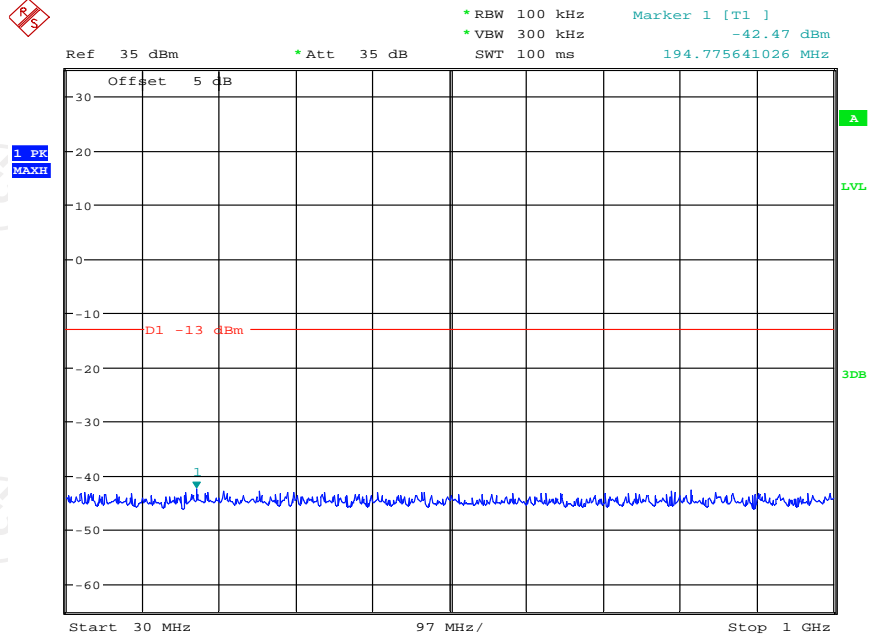

Date: 29.AUG.2016 18:32:43

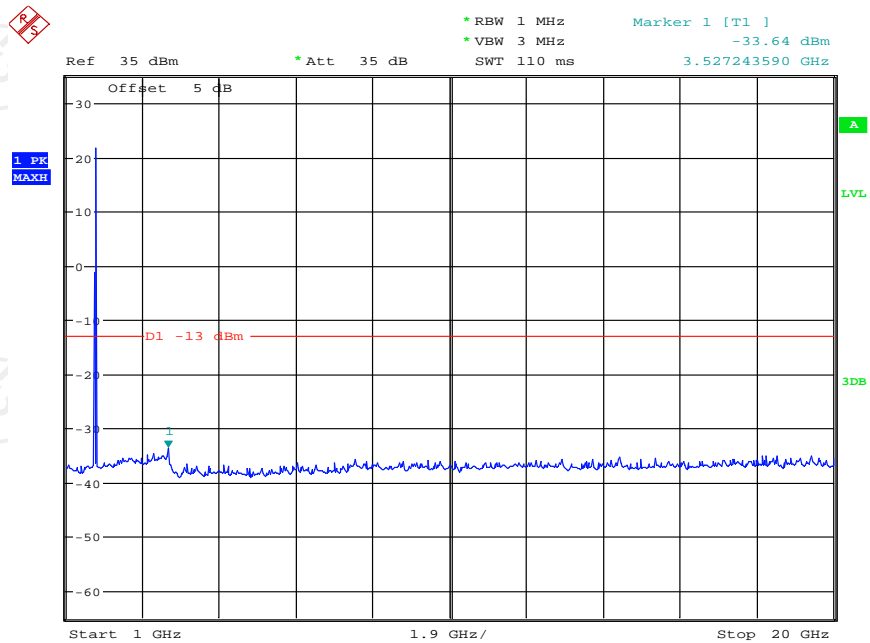

Date: 29.AUG.2016 18:32:19

Conducted Spurious Emission on Channel 1513

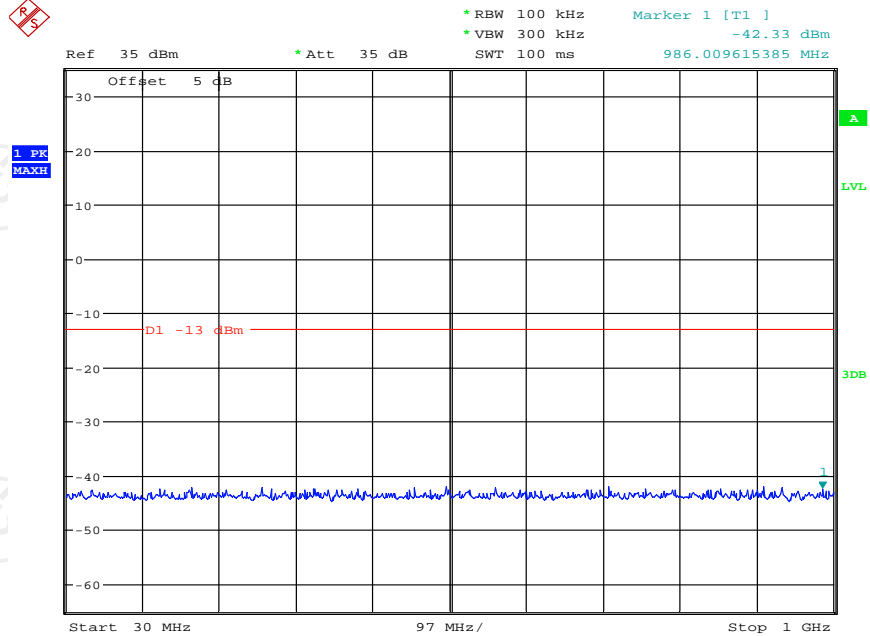

Date: 29.AUG.2016 18:33:41

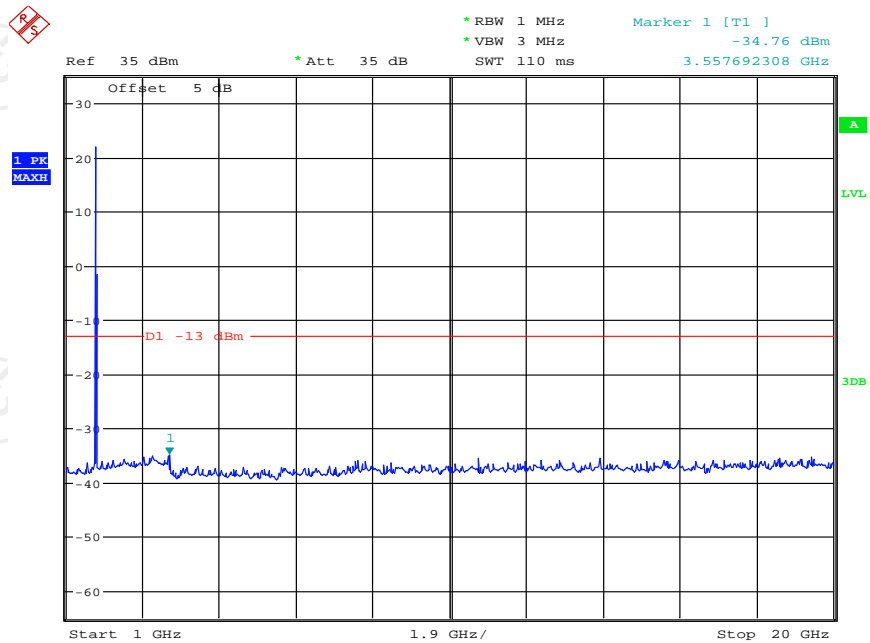

Date: 29.AUG.2016 18:34:07

6.6. Effective Radiated Power and Effective Isotropic Radiated Power Measurement

6.6.1. Test Specification

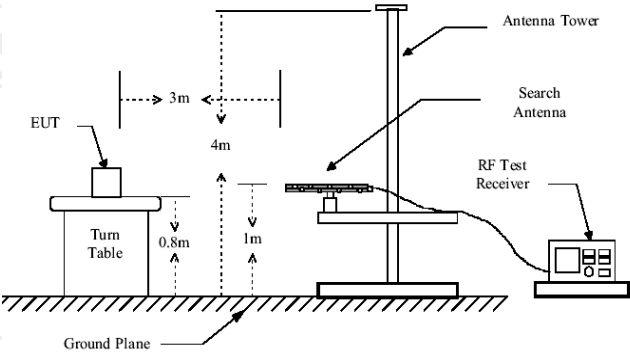
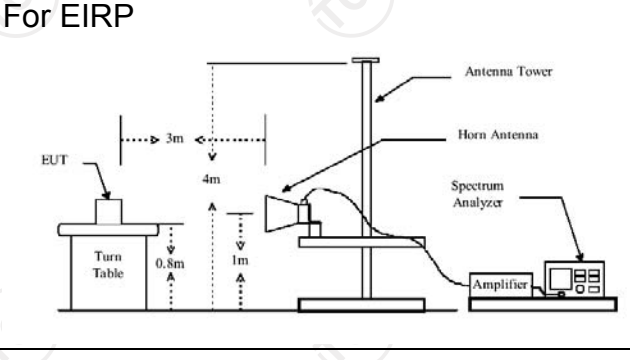
Test Requirement:	FCC part 22.913(a); FCC part 24.232(b); FCC part 27.50(d)																								
Test Method:	FCC part 2.1046																								
Receiver Setup:	<table border="1"> <thead> <tr> <th></th> <th>GSM/GPRS/GPRS</th> <th>WCDMA/HSPA</th> </tr> </thead> <tbody> <tr> <td>SPAN</td> <td>500kHz</td> <td>10MHz</td> </tr> <tr> <td>RBW</td> <td>10kHz</td> <td>100kHz</td> </tr> <tr> <td>VBW</td> <td>30kHz</td> <td>300kHz</td> </tr> <tr> <td>Detector</td> <td>RMS</td> <td>RMS</td> </tr> <tr> <td>Trace</td> <td>Average</td> <td>Average</td> </tr> <tr> <td>Average Type</td> <td>Power</td> <td>Power</td> </tr> <tr> <td>Sweep Count</td> <td>100</td> <td>100</td> </tr> </tbody> </table>		GSM/GPRS/GPRS	WCDMA/HSPA	SPAN	500kHz	10MHz	RBW	10kHz	100kHz	VBW	30kHz	300kHz	Detector	RMS	RMS	Trace	Average	Average	Average Type	Power	Power	Sweep Count	100	100
	GSM/GPRS/GPRS	WCDMA/HSPA																							
SPAN	500kHz	10MHz																							
RBW	10kHz	100kHz																							
VBW	30kHz	300kHz																							
Detector	RMS	RMS																							
Trace	Average	Average																							
Average Type	Power	Power																							
Sweep Count	100	100																							
Limit:	GSM850: 7W ERP; PCS1900: 2W EIRP; WCDMA Band IV: 1W EIRP																								
Test setup:	<p>For ERP</p>  <p>For EIRP</p> 																								
Test Procedure:	<ol style="list-style-type: none"> The testing follows FCC KDB 971168 v02r02 Section 5.2.1. (for CDMA/WCDMA), Section 5.2.2.2 (for GSM/GPRS/GPRS) and ANSI / TIA-603-D-2010 Section 2.2.17. The EUT was placed on a non-conductive rotating platform 0.8 meters high in a semi-anechoic 																								

	<p>chamber. The radiated emission at the fundamental frequency was measured at 3 m with a test antenna and a spectrum analyzer with RMS detector per section 5. of KDB 971168 D01.</p> <p>3. During the measurement, the system simulator parameters were set to force the EUT transmitting at maximum output power. The maximum emission was recorded from analyzer power level (LVL) from the 360 degrees rotation of the turntable and the test antenna raised and lowered over a range from 1 to 4 meters in both horizontally and vertically polarized orientations.</p> <p>4. Effective Isotropic Radiated Power (EIRP) was measured by substitution method according to TIA/EIA-603-D. The EUT was replaced by dipole antenna (substitution antenna) at the same location, and then a known power from S.G. was applied into the dipole antenna through a Tx cable, and then recorded the maximum Analyzer reading through raised and lowered the test antenna. The correction factor (in dB) = S.G. - Tx Cable loss + Substitution antenna gain - Analyzer reading. Then the EUT's EIRP was calculated with the correction factor, $EIRP = LVL + \text{Correction factor}$ and $ERP = EIRP - 2.15$.</p>
Test results:	PASS

6.6.2. Test Instruments

Radiated Emission Test Site (966)				
Name of Equipment	Manufacturer	Model	Serial Number	Calibration Due
ESPI Test Receiver	ROHDE&SCHWARZ	ESVD	100008	Aug. 11, 2017
Spectrum Analyzer	ROHDE&SCHWARZ	FSEM	848597/001	Aug. 11, 2017
Broadband Antenna	Schwarzbeck	VULB9163	351	Aug. 13, 2017
Broadband Antenna	Schwarzbeck	VULB9163	340	Aug. 13, 2017
Horn Antenna	Schwarzbeck	BBHA 9120D	631	Aug. 13, 2017
Horn Antenna	Schwarzbeck	BBHA 9120D	629	Aug. 13, 2017
Coax cable	TCT	N/A	N/A	Aug. 11, 2017
Coax cable	TCT	N/A	N/A	Aug. 11, 2017
Coax cable	TCT	N/A	N/A	Aug. 11, 2017
Coax cable	TCT	N/A	N/A	Aug. 11, 2017
EMI Test Software	Shurple Technology	EZ-EMC	N/A	N/A

Note: The calibration interval of the above test instruments is 12 months and the calibrations are traceable to international system unit (SI).

6.6.3. Test Data

Test Result of ERP

GSM850 (GSM) Radiated Power ERP				
Horizontal Polarization				
Frequency (MHz)	LVL (dBm)	Correction Factor (dB)	ERP (dBm)	ERP (W)
824.20	11.85	21.66	31.36	1.37
836.60	12.23	21.54	31.62	1.45
848.80	12.12	21.46	31.43	1.39
Vertical Polarization				
Frequency (MHz)	LVL (dBm)	Correction Factor (dB)	ERP (dBm)	ERP (W)
824.20	11.34	21.66	30.85	1.22
836.60	11.57	21.54	30.96	1.25
848.80	11.36	21.46	30.67	1.17

* ERP = LVL (dBm) + Correction Factor (dB) – 2.15

GSM850 (GPRS class 8) Radiated Power ERP				
Horizontal Polarization				
Frequency (MHz)	LVL (dBm)	Correction Factor (dB)	ERP (dBm)	ERP (W)
824.20	10.72	21.66	30.23	1.05
836.60	10.94	21.54	30.33	1.08
848.80	11.05	21.46	30.36	1.09
Vertical Polarization				
Frequency (MHz)	LVL (dBm)	Correction Factor (dB)	ERP (dBm)	ERP (W)
824.20	10.56	21.66	30.07	1.02
836.60	10.29	21.54	29.68	0.93
848.80	10.42	21.46	29.73	0.94

* ERP = LVL (dBm) + Correction Factor (dB) – 2.15

WCDMA Band V (RMC 12.2Kbps) Radiated Power ERP				
Horizontal Polarization				
Frequency (MHz)	LVL (dBm)	Correction Factor (dB)	ERP (dBm)	ERP (W)
826.40	3.37	21.62	22.84	0.19
836.60	3.15	21.57	22.57	0.18
846.60	3.25	21.44	22.54	0.18
Vertical Polarization				
Frequency (MHz)	LVL (dBm)	Correction Factor (dB)	ERP (dBm)	ERP (W)
826.40	2.18	21.62	21.65	0.15
836.60	2.35	21.57	21.77	0.15
846.60	2.09	21.44	21.38	0.14

* ERP = LVL (dBm) + Correction Factor (dB) - 2.15
Correction Factor = S.G. Power - Cable loss + Antenna Gain - SPA. Reading

Test Result of EIRP

GSM1900 (GSM) Radiated Power EIRP				
Horizontal Polarization				
Frequency (MHz)	LVL (dBm)	Correction Factor (dB)	EIRP (dBm)	EIRP (W)
1850.20	7.49	21.66	29.15	0.82
1880.00	7.86	21.54	29.40	0.87
1909.80	7.63	21.46	29.09	0.81
Vertical Polarization				
Frequency (MHz)	LVL (dBm)	Correction Factor (dB)	EIRP (dBm)	EIRP (W)
1850.20	6.42	21.66	28.08	0.64
1880.00	6.51	21.54	28.05	0.64
1909.80	7.28	21.46	28.74	0.75

EIRP = LVL (dBm) + Correction Factor (dB)

GSM1900 (GPRS class 8) Radiated Power EIRP				
Horizontal Polarization				
Frequency (MHz)	LVL (dBm)	Correction Factor (dB)	EIRP (dBm)	EIRP (W)
1850.20	7.49	21.66	29.15	0.82
1880.00	7.87	21.54	29.41	0.87
1909.80	7.78	21.46	29.24	0.84
Vertical Polarization				
Frequency (MHz)	LVL (dBm)	Correction Factor (dB)	EIRP (dBm)	EIRP (W)
1850.20	5.73	21.66	27.39	0.55
1880.00	5.45	21.54	26.99	0.50
1909.80	5.61	21.46	27.07	0.51

* EIRP = LVL (dBm) + Correction Factor (dB)

WCDMA Band IV (RMC 12.2Kbps) Radiated Power EIRP				
Horizontal Polarization				
Frequency (MHz)	LVL (dBm)	Correction Factor (dB)	EIRP (dBm)	EIRP (W)
1712.4	4.23	18.33	22.56	0.18
1732.6	4.37	18.15	22.52	0.18
1752.6	4.61	18.24	22.85	0.19
Vertical Polarization				
Frequency (MHz)	LVL (dBm)	Correction Factor (dB)	EIRP (dBm)	EIRP (W)
1712.4	3.83	18.33	22.16	0.16
1732.6	4.16	18.15	22.31	0.17
1752.6	4.08	18.24	22.32	0.17

* EIRP = LVL (dBm) + Correction Factor (dB)

Correction Factor= S.G. Power - Cable loss + Antenna Gain- SPA. Reading

6.7. Field Strength of Spurious Radiation Measurement

6.7.1. Test Specification

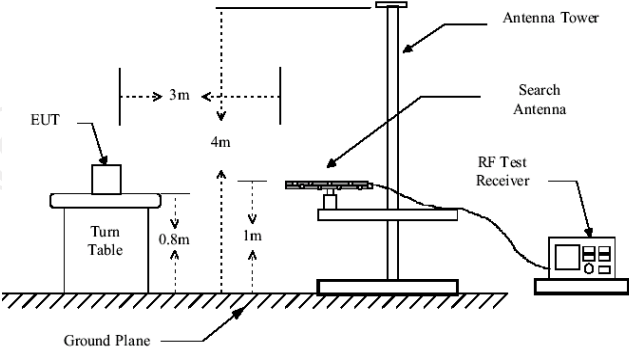
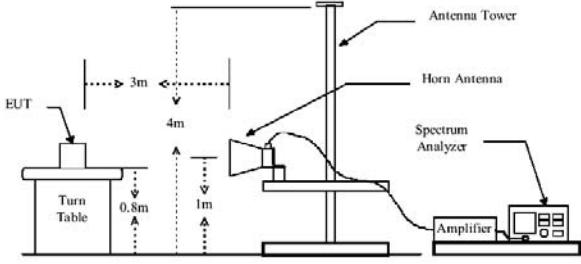
Test Requirement:	FCC part 22.917(a) ;FCC part 24.238(a); FCC part 27.53(g)
Test Method:	FCC part 2.1053
Limit:	30MHz~20GHz -13dBm
Test setup:	<p>For 30MHz~1GHz</p>  <p>For 1GHz ~20GHz</p> 
Test Procedure:	<ol style="list-style-type: none"> 1. The testing follows FCC KDB 971168 v02r02 Section 5.8 and ANSI / TIA-603-D-2010 Section 2.2.12. 2. The EUT was placed on a rotatable wooden table 0.8 meters above the ground. 3. The EUT was set 3 meters from the receiving antenna, which was mounted on the antenna tower. 4. The table was rotated 360 degrees to determine the position of the highest spurious emission. 5. The height of the receiving antenna is varied between one meter and four meters to search for the maximum spurious emission for both horizontal and vertical polarizations. 6. Make the measurement with the spectrum analyzer's RBW = 1MHz, VBW = 3MHz, taking record of maximum spurious emission. 7. A horn antenna was substituted in place of the EUT and was driven by a signal generator. 8. Tune the output power of signal generator to the

	<p>same emission level with EUT maximum spurious emission.</p> <p>9. Taking the record of output power at antenna port.</p> <p>10. Repeat step 7 to step 8 for another polarization.</p> <p>11. EIRP (dBm) = S.G. Power – Tx Cable Loss + Tx Antenna Gain</p> <p>12. ERP (dBm) = EIRP - 2.15</p> <p>13. The RF fundamental frequency should be excluded against the limit line in the operating frequency band.</p> <p>14. The limit line is derived from 43 + 10log(P) dB below the transmitter power P(Watts)</p> <p>= P(W) - [43 + 10log(P)] (dB)</p> <p>= [30 + 10log(P)] (dBm) - [43 + 10log(P)] (dB)</p> <p>= -13dBm.</p>
Test results:	PASS

6.7.2. Test Instruments

Radiated Emission Test Site (966)				
Name of Equipment	Manufacturer	Model	Serial Number	Calibration Due
ESPI Test Receiver	ROHDE&SCHWARZ	ESVD	100008	Aug. 11, 2017
Spectrum Analyzer	ROHDE&SCHWARZ	FSEM	848597/001	Aug. 11, 2017
Pre-Amplifier	HP	8447D	2727A05017	Aug. 11, 2017
Pre-Amplifier	EM Electronics Corporation CO.,LTD	EM30265	07032613	Aug. 11, 2017
Broadband Antenna	Schwarzbeck	VULB9163	351	Aug. 13, 2017
Broadband Antenna	Schwarzbeck	VULB9163	340	Aug. 13, 2017
Horn Antenna	Schwarzbeck	BBHA 9120D	631	Aug. 13, 2017
Horn Antenna	Schwarzbeck	BBHA 9120D	629	Aug. 13, 2017
Coax cable	TCT	N/A	N/A	Aug. 11, 2017
Coax cable	TCT	N/A	N/A	Aug. 11, 2017
EMI Test Software	Shurple Technology	EZ-EMC	N/A	N/A
Signal Generator	Maconi	2022D	N/A	Aug. 12, 2017

Note: The calibration interval of the above test instruments is 12 months and the calibrations are traceable to international system unit (SI).

6.7.3. Test Data

Band	GSM850		Test channel:	Lowest
Test mode:	GSM Link (GMSK)		Temperature :	25°C
			Relative Humidity:	56%
Note:	Spurious emissions within 30-1000MHz were found more than 20dB below limit line.			
Frequency (MHz)	Spurious Emission		Limit (dBm)	Result
	Polarization	Level (dBm)		
1648.40	Vertical	-39.68	-13.00	PASS
2472.60	V	-42.73		
3296.80	V	-49.52		
1648.40	Horizontal	-44.36		
2472.60	H	-38.47		
3296.80	H	-50.03		
Test mode:	GSM850		Test channel:	Middle
Test mode:	GSM Link (GMSK)		Temperature :	25°C
			Relative Humidity:	56%
Note:	Spurious emissions within 30-1000MHz were found more than 20dB below limit line.			
Frequency (MHz)	Spurious Emission		Limit (dBm)	Result
	Polarization	Level (dBm)		
1673.20	Vertical	-41.53	-13.00	PASS
2509.80	V	-42.31		
3346.40	V	-50.97		
1673.20	Horizontal	-42.24		
2509.80	H	-40.36		
3346.40	H	-51.68		
Test mode:	GSM850		Test channel:	Highest
Test mode:	GSM Link (GMSK)		Temperature :	25°C
			Relative Humidity:	56%
Note:	Spurious emissions within 30-1000MHz were found more than 20dB below limit line.			
Frequency (MHz)	Spurious Emission		Limit (dBm)	Result
	Polarization	Level (dBm)		
1697.60	Vertical	-41.93	-13.00	PASS
2546.40	V	-40.25		
3395.20	V	-55.18		
1697.60	Horizontal	-46.39		
2546.40	H	-42.17		
3395.20	H	-53.62		

Band	GSM 1900		Test channel:	Lowest
Test mode:	GSM Link (GMSK)		Temperature :	25°C
			Relative Humidity:	56%
Note:	Spurious emissions within 30-1000MHz were found more than 20dB below limit line.			
Frequency (MHz)	Spurious Emission		Limit (dBm)	Result
	Polarization	Level (dBm)		
3700.40	Vertical	-51.43	-13.00	PASS
5550.60	V	-46.52		
7400.80	V	-51.97		
3700.40	Horizontal	-49.35		
5550.60	H	-51.23		
7400.80	H	-49.04		
Test mode:	GSM 1900		Test channel:	Middle
Test mode:	GSM Link (GMSK)		Temperature :	25°C
			Relative Humidity:	56%
Note:	Spurious emissions within 30-1000MHz were found more than 20dB below limit line.			
Frequency (MHz)	Spurious Emission		Limit (dBm)	Result
	Polarization	Level (dBm)		
3760.00	Vertical	-48.01	-13.00	PASS
5640.00	V	-52.85		
7520.00	V	-48.62		
3760.00	Horizontal	-46.43		
5640.00	H	-51.96		
7520.00	H	-52.35		
Test mode:	GSM 1900		Test channel:	Highest
Test mode:	GSM Link (GMSK)		Temperature :	25°C
			Relative Humidity:	56%
Note:	Spurious emissions within 30-1000MHz were found more than 20dB below limit line.			
Frequency (MHz)	Spurious Emission		Limit (dBm)	Result
	Polarization	Level (dBm)		
3819.60	Vertical	-47.35	-13.00	PASS
5729.40	V	-51.76		
7639.20	V	-53.18		
3819.60	Horizontal	-49.42		
5729.40	H	-51.83		
7639.20	H	-53.72		

Band	WCDMA Band IV		Test channel:	Lowest
Test mode:	RMC 12.2Kbps Link (QPSK)		Temperature :	23~24°C
			Relative Humidity:	46~48%
Note:	Spurious emissions within 30-1000MHz were found more than 20dB below limit line.			
Frequency (MHz)	Spurious Emission		Limit (dBm)	Result
	Polarization	Level (dBm)		
2452.3	Vertical	--	-13.00	PASS
3424.8	V	-52.56		
5137.2	V	-54.78		
2452.3	Horizontal	--		
3424.8	H	-53.43		
5137.2	H	-51.82		
Test mode:	WCDMA Band IV		Test channel:	Middle
Test mode:	RMC 12.2Kbps Link (QPSK)		Temperature :	23~24°C
			Relative Humidity:	46~48%
Note:	Spurious emissions within 30-1000MHz were found more than 20dB below limit line.			
Frequency (MHz)	Spurious Emission		Limit (dBm)	Result
	Polarization	Level (dBm)		
2641.3	Vertical	-53.57	-13.00	PASS
3465.2	V	-50.49		
5197.8	V	-54.68		
2641.3	Horizontal	-51.53		
3465.2	H	-56.08		
5197.8	H	-53.25		
Test mode:	WCDMA Band IV		Test channel:	Highest
Test mode:	RMC 12.2Kbps Link (QPSK)		Temperature :	23~24°C
			Relative Humidity:	46~48%
Note:	Spurious emissions within 30-1000MHz were found more than 20dB below limit line.			
Frequency (MHz)	Spurious Emission		Limit (dBm)	Result
	Polarization	Level (dBm)		
3102.2	Vertical	-51.36	-13.00	PASS
3505.2	V	-52.85		
5257.8	V	-49.07		
3102.2	Horizontal	-53.62		
3505.2	H	-51.48		
5257.8	H	-55.65		

6.8. Frequency Stability Measurement

6.8.1. Test Specification

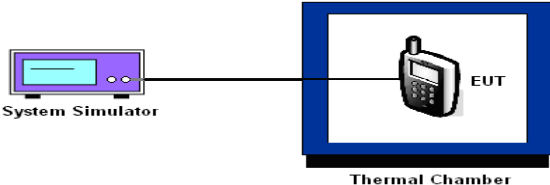
Test Requirement:	FCC Part 2.1055 ; FCC Part 22.355 ; FCC Part 24.235 FCC Part 27.54
Test Method:	FCC Part 2.1055(a)(1)(b)
Limit:	±2.5 ppm
Test Setup:	 <p>The diagram illustrates the test setup. On the left, a 'System Simulator' is connected via a cable to an 'EUT' (Equipment Under Test) which is placed inside a 'Thermal Chamber'.</p>
Test Procedure:	<p>Test Procedures for Temperature Variation</p> <ol style="list-style-type: none"> 1. The testing follows FCC KDB 971168 v02r02 Section 9.0. 2. The EUT was set up in the thermal chamber and connected with the system simulator. 3. With power OFF, the temperature was decreased to -30°C and the EUT was stabilized before testing. Power was applied and the maximum change in frequency was recorded within one minute. 4. With power OFF, the temperature was raised in 10°C steps up to 50°C. The EUT was stabilized at each step for at least half an hour. Power was applied and the maximum frequency change was recorded within one minute. <p>Test Procedures for Voltage Variation</p> <ol style="list-style-type: none"> 1. The testing follows FCC KDB 971168 v02r02 Section 9.0. 2. The EUT was placed in a temperature chamber at 25±5° C and connected with the system simulator. 3. The power supply voltage to the EUT was varied from BEP to 115% of the nominal value measured at the input to the EUT. 4. The variation in frequency was measured for the worst case.
Test Result:	PASS

6.8.2. Test Instruments

Equipment	Manufacturer	Model	Serial Number	Calibration Due
System simulator	R&S	CMU200	111382	Aug. 11, 2017
Spectrum Analyzer	Agilent	N9020A	MY49100060	Aug. 12, 2017
Thermal chamber	JQ	JQ-2000	N/A	Aug. 12, 2017

Note: The calibration interval of the above test instruments is 12 months and the calibrations are traceable to

international system unit (SI).

6.8.3. Test Data

Test Result of Temperature Variation

Band :	GSM 850	Channel:	189
Limit (ppm) :	2.5ppm	Frequency:	836.6
Temperature (°C)	GSM Deviation (ppm)	GPRS Class8 Deviation (ppm)	Result
50	+0.013	+0.007	PASS
40	+0.011	+0.013	
30	+0.013	+0.009	
20	+0.010	+0.012	
10	+0.013	+0.011	
0	+0.010	+0.014	
-10	+0.007	+0.009	
-20	+0.009	+0.012	
-30	+0.014	+0.013	

Band :	GSM 1900	Channel:	661
Limit (ppm) :	2.5ppm	Frequency:	1880
Temperature (°C)	GSM Deviation (ppm)	GPRS Class8 Deviation (ppm)	Result
50	+0.024	+0.018	PASS
40	+0.022	+0.023	
30	+0.023	+0.016	
20	+0.017	+0.018	
10	+0.021	+0.023	
0	+0.022	+0.021	
-10	+0.018	+0.06	
-20	+0.021	+0.019	
-30	+0.022	+0.022	

Note: The frequency fundamental emissions stay within the authorized frequency block based on the frequency deviation measured is small.

Band :	WCDMA Band IV	Channel:	1413
Limit (ppm) :	2.5ppm	Frequency:	1732.6
Temperature (°C)	RMC 12.2Kbps Deviation (ppm)		Result
50	-0.015		PASS
40	-0.016		
30	-0.018		
20	-0.013		
10	-0.007		
0	-0.014		
-10	-0.013		
-20	-0.016		
-30	-0.015		

Note: The frequency fundamental emissions stay within the authorized frequency block based on the frequency deviation measured is small.

Test Result of Voltage Variation

Band & Channel	Mode	Voltage (Volt)	Deviation (ppm)	Limit (ppm)	Result
GSM 850 CH189	GSM	4.2	+0.016	2.5	PASS
		3.8	+0.008		
		BEP	+0.013		
	GPRS class 8	4.2	+0.024		
		3.8	+0.026		
		BEP	+0.033		
GSM 1900 CH661	GSM	4.2	+0.021	(Note 3.)	
		3.8	+0.025		
		BEP	+0.019		
	GPRS class 8	4.2	+0.021		
		3.8	+0.023		
		BEP	+0.026		
WCDMA Band IV CH1413	RMC 12.2Kbps	4.2	-0.004	2.5	
		3.8	-0.011		
		BEP	-0.013		

Note:

1. Normal Voltage = 3.8V.
2. Battery End Point (BEP) = 3.40 V.
3. The frequency fundamental emissions stay within the authorized frequency block based on the frequency deviation measured is small.

*******END OF REPORT*******

Appendix A: Photographs of Test Setup

Radiated Emission

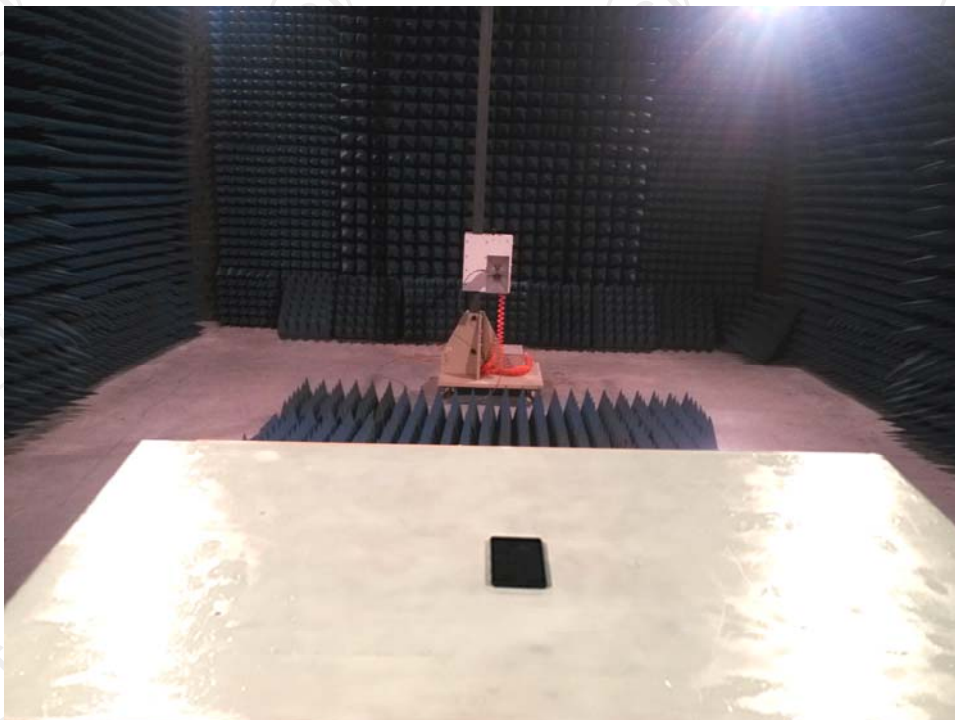
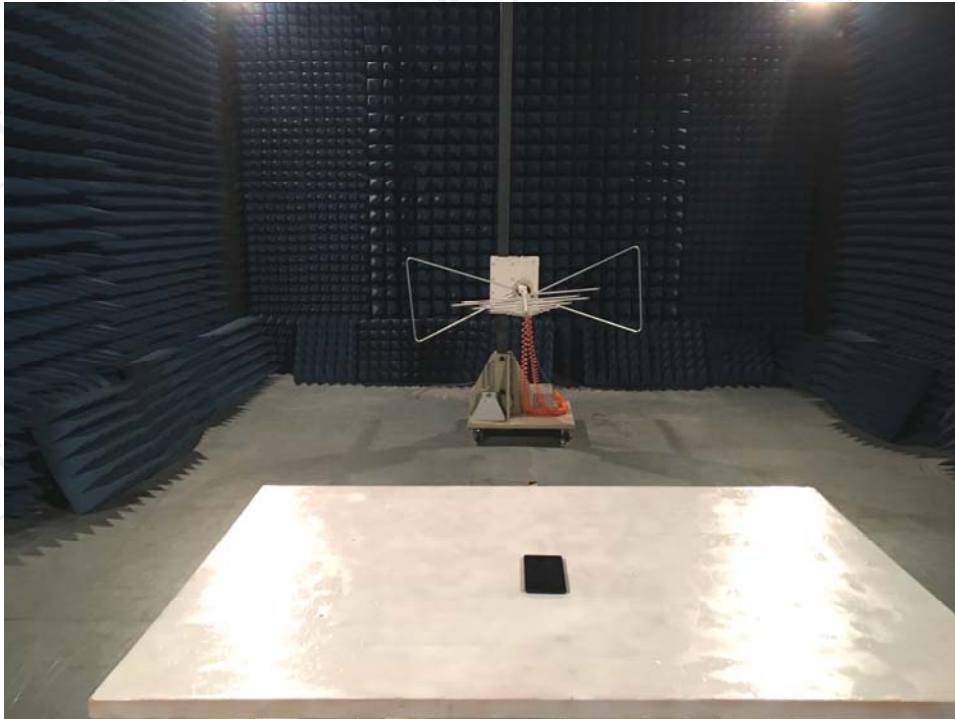

Appendix B: Photographs of EUT

Refer to test report TCT160817E010