

# TEST REPORT

**FCC ID: 2ACJAPLT8990**

**Product: TABLET PC**

**Model No.: PLT8990**

**Additional Model: N/A**

**Trade Mark: N/A**

**Report No.: TCT151022E009**

**Issued Date: Nov. 04, 2015**

Issued for:

**ShenZhen Harmony Technology Co., Ltd**  
**Block 2, Jiayuan Industrial Zone, Heping Community high-tech Park, No 2**  
**Fuyuan Road, Fuyong, Bao'an, Shenzhen, China**

Issued By:

**Shenzhen Tongce Testing Lab.**  
**1F, Leinuo Watch Building, Fuyong Town, Baoan Dist, Shenzhen, China**

**TEL: +86-755-27673339**

**FAX: +86-755-27673332**

**Note:** This report shall not be reproduced except in full, without the written approval of Shenzhen Tongce Testing Lab.

This document may be altered or revised by Shenzhen Tongce Testing Lab. personnel only, and shall be noted in the revision section of the document. The test results in the report only apply to the tested sample.

**TABLE OF CONTENTS**

1. Test Certification..... 3

2. Test Result Summary ..... 4

3. EUT Description ..... 5

4. General Information ..... 6

    4.1. Test environment and mode..... 6

    4.2. Description of Support Units..... 6

5. Facilities and Accreditations ..... 7

    5.1. Facilities ..... 7

    5.2. Location ..... 7

    5.3. Measurement Uncertainty..... 7

6. Test Results and Measurement Data ..... 8

    6.1. Antenna requirement ..... 8

    6.2. Conducted Emission..... 9

    6.3. Conducted Output Power ..... 13

    6.4. 20dB Occupancy Bandwidth ..... 18

    6.5. Carrier Frequencies Separation ..... 23

    6.6. Hopping Channel Number ..... 28

    6.7. Dwell Time..... 31

    6.8. Pseudorandom Frequency Hopping Sequence..... 34

    6.9. Conducted Band Edge Measurement ..... 35

    6.10. Conducted Spurious Emission Measurement..... 39

    6.11. Radiated Spurious Emission Measurement ..... 43

**Appendix A: Photographs of Test Setup**

**Appendix B: Photographs of EUT**

## 1. Test Certification

<b>Product:</b>	TABLET PC
<b>Model No.:</b>	PLT8990
<b>Additional Model:</b>	N/A
<b>Applicant:</b>	ShenZhen Harmony Technology Co.,Ltd
<b>Address:</b>	Block 2, Jiayuan Industrial Zone, Heping Community high-tech Park, No 2 Fuyuan Road, Fuyong, Bao'an, Shenzhen, China
<b>Manufacturer:</b>	ShenZhen Harmony Technology Co.,Ltd
<b>Address:</b>	Block 2, Jiayuan Industrial Zone, Heping Community high-tech Park, No 2 Fuyuan Road, Fuyong, Bao'an, Shenzhen, China
<b>Date of Test:</b>	Oct. 22 –Nov. 03, 2015
<b>Applicable Standards:</b>	FCC CFR Title 47 Part 15 Subpart C Section 15.247

The above equipment has been tested by Shenzhen Tongce Testing Lab. and found compliance with the requirements set forth in the technical standards mentioned above. The results of testing in this report apply only to the product/system, which was tested. Other similar equipment will not necessarily produce the same results due to production tolerance and measurement uncertainties.

Tested By:



Beryl Zhao

Date:

Nov. 03, 2015

Reviewed By:



Joe Zhou

Date:

Nov. 04, 2015

Approved By:



Tomsin

Date:

Nov. 04, 2015

## 2. Test Result Summary

Requirement	CFR 47 Section	Result
Antenna Requirement	§15.203/§15.247 (c)	PASS
AC Power Line Conducted Emission	§15.207	PASS
Conducted Peak Output Power	§15.247 (b)(1)	PASS
20dB Occupied Bandwidth	§15.247 (a)(1)	PASS
Carrier Frequencies Separation	§15.247 (a)(1)	PASS
Hopping Channel Number	§15.247 (a)(1)	PASS
Dwell Time	§15.247 (a)(1)	PASS
Radiated Emission	§15.205/§15.209	PASS
Band Edge	§15.247(d)	PASS

**Note:**

1. PASS: Test item meets the requirement.
2. Fail: Test item does not meet the requirement.
3. N/A: Test case does not apply to the test object.
4. The test result judgment is decided by the limit of test standard.
5. All test are according to ANSI C63.4-2014 and ANSI C63.10-2013

### 3. EUT Description

<b>Product Name:</b>	TABLET PC
<b>Model :</b>	PLT8990
<b>Additional Model:</b>	N/A
<b>Trade Mark:</b>	N/A
<b>Operation Frequency:</b>	2402MHz~2480MHz
<b>Transfer Rate:</b>	1/2/3 Mbits/s
<b>Number of Channel:</b>	79
<b>Modulation Type:</b>	GFSK, $\pi/4$ -DQPSK, 8DPSK
<b>Modulation Technology:</b>	FHSS
<b>Antenna Type:</b>	Internal Antenna
<b>Antenna Gain:</b>	2dBi
<b>Power Supply:</b>	Adapter Information: MODEL: HJ-050200U INPUT: AC100-240V~ 50/60Hz 0.6A Max OUTPUT: 5V, 2A

#### Operation Frequency each of channel for GFSK, $\pi/4$ -DQPSK, 8DPSK

Channel	Frequency	Channel	Frequency	Channel	Frequency	Channel	Frequency
0	2402MHz	20	2422MHz	40	2442MHz	60	2462MHz
1	2403MHz	21	2423MHz	41	2443MHz	61	2463MHz
...	...	...	...	...	...	...	...
10	2412MHz	30	2432MHz	50	2452MHz	70	2472MHz
11	2413MHz	31	2433MHz	51	2453MHz	71	2473MHz
...	...	...	...	...	...	...	...
18	2420MHz	38	2440MHz	58	2460MHz	78	2480MHz
19	2421MHz	39	2441MHz	59	2461MHz		-

Remark: Channel 0, 39 &78 have been tested for GFSK,  $\pi/4$ -DQPSK, 8DPSK modulation mode.

## 4. Genera Information

### 4.1. Test environment and mode

Operating Environment:	
Temperature:	25.0 °C
Humidity:	56 % RH
Atmospheric Pressure:	1010 mbar
Test Mode:	
Engineering mode:	Keep the EUT in continuous transmitting by select channel and modulations
<p>The sample was placed 0.8m above the ground plane of 3m chamber. Measurements in both horizontal and vertical polarities were performed. During the test, each emission was maximized by: having the EUT continuously working, investigated all operating modes, rotated about all 3 axis (X, Y &amp; Z) and considered typical configuration to obtain worst position, manipulating interconnecting cables, rotating the turntable, varying antenna height from 1m to 4m in both horizontal and vertical polarizations. The emissions worst-case are shown in Test Results of the following pages.</p>	

### 4.2. Description of Support Units

The EUT has been tested as an independent unit together with other necessary accessories or support units. The following support units or accessories were used to form a representative test configuration during the tests.

Equipment	Model No.	Serial No.	FCC ID	Trade Name
/	/	/	/	/

**Note:**

1. All the equipment/cables were placed in the worst-case configuration to maximize the emission during the test.
2. Grounding was established in accordance with the manufacturer's requirements and conditions for the intended use.
3. For conducted measurements (Output Power, 20dB Occupied Bandwidth, Carrier Frequencies Separation, Hopping Channel Number, Dwell Time, Spurious Emissions), the antenna of EUT is connected to the test equipment via temporary antenna connector, the antenna connector is soldered on the antenna port of EUT, and the temporary antenna connector is listed in the Test Instruments.

## 5. Facilities and Accreditations

### 5.1. Facilities

The test facility is recognized, certified, or accredited by the following organizations:

- FCC - Registration No.: 572331

Shenzhen Tongce Testing Lab

The 3m Semi-anechoic chamber has been registered and fully described in a report with the (FCC) Federal Communications Commission. The acceptance letter from the FCC is maintained in our files.

- IC - Registration No.: 10668A-1

The 3m Semi-anechoic chamber of Shenzhen TCT Testing Technology Co., Ltd. has been registered by Certification and Engineering Bureau of Industry Canada for radio equipment testing

- CNAS - Registration No.: CNAS L6165

Shenzhen TCT Testing Technology Co., Ltd. is accredited to ISO/IEC 17025:2005 General Requirements for the Competence of Testing and Calibration laboratories for the competence of testing. The Registration No. is CNAS L6165.

### 5.2. Location

Shenzhen Tongce Testing Lab

Address: 1F, Leinuo Watch Building, Fuyong Town, Baoan Dist, Shenzhen, China

Tel: 86-755-36638142

### 5.3. Measurement Uncertainty

The reported uncertainty of measurement  $y \pm U$ , where expanded uncertainty  $U$  is based on a standard uncertainty multiplied by a coverage factor of  $k=2$ , providing a level of confidence of approximately 95 %.

No.	Item	MU
1	Conducted Emission	$\pm 2.56\text{dB}$
2	RF power, conducted	$\pm 0.12\text{dB}$
3	Spurious emissions, conducted	$\pm 0.11\text{dB}$
4	All emissions, radiated(<1G)	$\pm 3.92\text{dB}$
5	All emissions, radiated(>1G)	$\pm 4.28\text{dB}$
6	Temperature	$\pm 0.1^\circ\text{C}$
7	Humidity	$\pm 1.0\%$

## 6. Test Results and Measurement Data

### 6.1. Antenna requirement

<b>Standard requirement:</b>	FCC Part15 C Section 15.203 /247(c)
<p>15.203 requirement: An intentional radiator shall be designed to ensure that no antenna other than that furnished by the responsible party shall be used with the device. The use of a permanently attached antenna or of an antenna that uses a unique coupling to the intentional radiator, the manufacturer may design the unit so that a broken antenna can be replaced by the user, but the use of a standard antenna jack or electrical connector is prohibited.</p> <p>15.247(c) (1)(i) requirement: (i) Systems operating in the 2400-2483.5 MHz band that is used exclusively for fixed. Point-to-point operations may employ transmitting antennas with directional gain greater than 6dBi provided the maximum conducted output power of the intentional radiator is reduced by 1 dB for every 3 dB that the directional gain of the antenna exceeds 6dBi.</p>	
<b>E.U.T Antenna:</b>	
<p>The Bluetooth antenna is an internal antenna which permanently attached, and the best case gain of the antenna is 2dBi.</p>	
	



## 6.2. Conducted Emission

### 6.2.1. Test Specification

<b>Test Requirement:</b>	FCC Part15 C Section 15.207														
<b>Test Method:</b>	ANSI C63.4:2014														
<b>Frequency Range:</b>	150 kHz to 30 MHz														
<b>Receiver setup:</b>	RBW=9 kHz, VBW=30 kHz, Sweep time=auto														
<b>Limits:</b>	<table border="1"> <thead> <tr> <th rowspan="2">Frequency range (MHz)</th> <th colspan="2">Limit (dBuV)</th> </tr> <tr> <th>Quasi-peak</th> <th>Average</th> </tr> </thead> <tbody> <tr> <td>0.15-0.5</td> <td>66 to 56*</td> <td>56 to 46*</td> </tr> <tr> <td>0.5-5</td> <td>56</td> <td>46</td> </tr> <tr> <td>5-30</td> <td>60</td> <td>50</td> </tr> </tbody> </table>	Frequency range (MHz)	Limit (dBuV)		Quasi-peak	Average	0.15-0.5	66 to 56*	56 to 46*	0.5-5	56	46	5-30	60	50
Frequency range (MHz)	Limit (dBuV)														
	Quasi-peak	Average													
0.15-0.5	66 to 56*	56 to 46*													
0.5-5	56	46													
5-30	60	50													
<b>Test Setup:</b>	<p><i>Remark</i> E.U.T: Equipment Under Test LISN: Line Impedance Stabilization Network Test table height=0.8m</p>														
<b>Test Mode:</b>	Reference to item 4.1														
<b>Test Procedure:</b>	<ol style="list-style-type: none"> <li>1. The E.U.T and simulators are connected to the main power through a line impedance stabilization network (L.I.S.N.). This provides a 50ohm/50uH coupling impedance for the measuring equipment.</li> <li>2. The peripheral devices are also connected to the main power through a LISN that provides a 50ohm/50uH coupling impedance with 50ohm termination. (Please refer to the block diagram of the test setup and photographs).</li> <li>3. Both sides of A.C. line are checked for maximum conducted interference. In order to find the maximum emission, the relative positions of equipment and all of the interface cables must be changed according to ANSI C63.4: 2014 on conducted measurement.</li> </ol>														
<b>Test Result:</b>	PASS														

**6.2.2. Test Instruments**

Conducted Emission Shielding Room Test Site (843)				
Equipment	Manufacturer	Model	Serial Number	Calibration Due
EMI Test Receiver	R&S	ESCS30	100139	Sep. 11, 2016
LISN	Schwarzbeck	NSLK 8126	8126453	Sep. 16, 2016
Coax cable	TCT	CE-05	N/A	Sep. 11, 2016
EMI Test Software	Shurple Technology	EZ-EMC	N/A	N/A

**Note:** The calibration interval of the above test instruments is 12 months and the calibrations are traceable to international system unit (SI).

**6.2.3. Test data**

Please refer to following diagram for individual

**Conducted Emission on Line Terminal of the power line (150 kHz to 30MHz)**

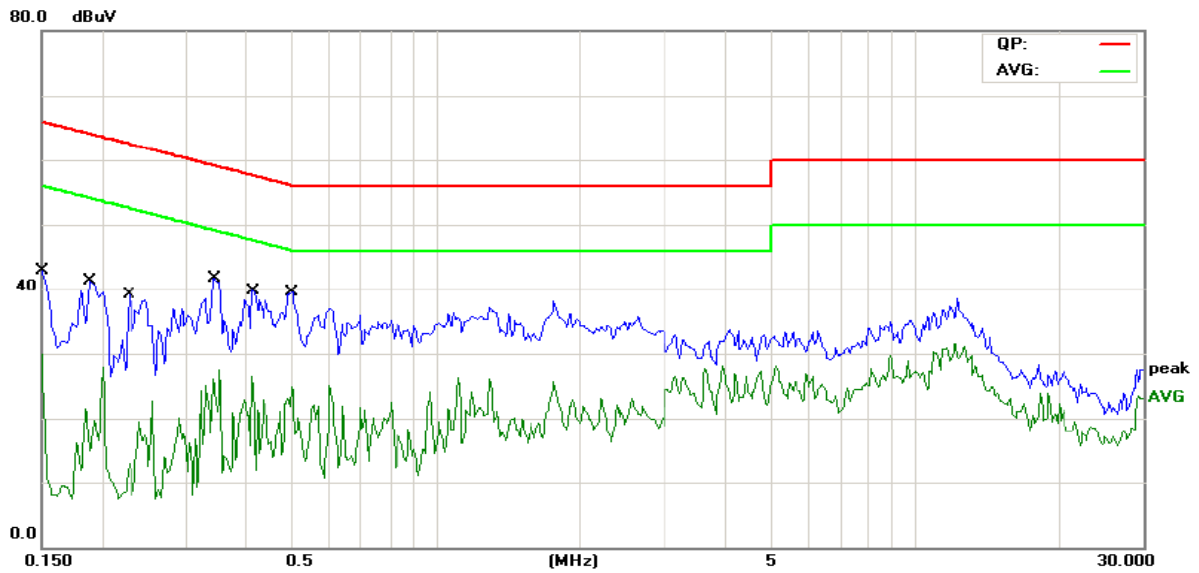

Site Chamber #2 Phase: **L1** Temperature: 23 (C)  
Limit: FCC Part 15B Class B Conduction(QP) Power: AC 120V/60Hz Humidity: 54 %

No.	Mk.	Freq. MHz	Reading Level dBuV	Correct Factor dB	Measure- ment dBuV	Limit dBuV	Over dB	Detector	Comment
1		0.1500	31.10	11.49	42.59	65.99	-23.40	QP	
2		0.1500	13.26	11.49	24.75	55.99	-31.24	AVG	
3		0.1891	25.55	11.47	37.02	64.07	-27.05	QP	
4		0.1891	6.46	11.47	17.93	54.07	-36.14	AVG	
5		0.2281	21.23	11.45	32.68	62.52	-29.84	QP	
6		0.2281	3.06	11.45	14.51	52.52	-38.01	AVG	
7		0.3465	26.80	11.39	38.19	59.04	-20.85	QP	
8		0.3465	12.95	11.39	24.34	49.04	-24.70	AVG	
9		0.4170	24.47	11.34	35.81	57.51	-21.70	QP	
10		0.4170	10.04	11.34	21.38	47.51	-26.13	AVG	
11	*	0.5016	24.94	11.30	36.24	56.00	-19.76	QP	
12		0.5016	11.61	11.30	22.91	46.00	-23.09	AVG	

**Note:**

- Freq. = Emission frequency in MHz
- Reading level (dBuV) = Receiver reading
- Corr. Factor (dB) = Antenna factor + Cable loss
- Measurement (dBuV) = Reading level (dBuV) + Corr. Factor (dB)
- Limit (dBuV) = Limit stated in standard
- Margin (dB) = Measurement (dBuV) – Limits (dBuV)
- Q.P. =Quasi-Peak
- AVG =average
- \* is meaning the worst frequency has been tested in the frequency range 150 kHz to 30MHz

## Conducted Emission on Neutral Terminal of the power line (150 kHz to 30MHz)

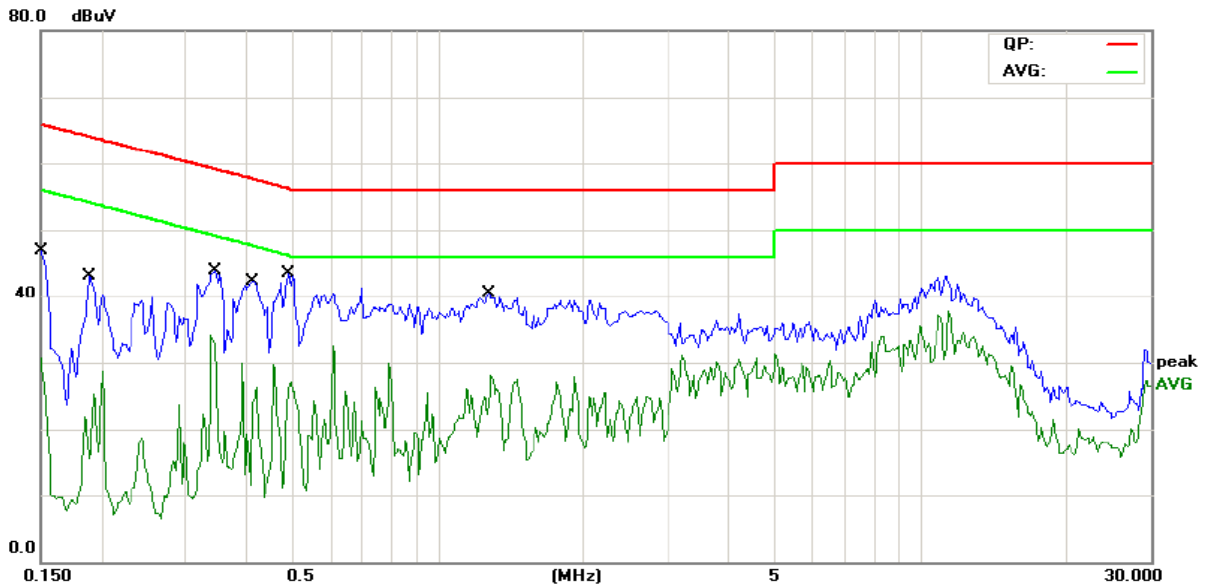

Site Chamber #2 Phase: **N** Temperature: 23 (C)  
 Limit: FCC Part 15B Class B Conduction(QP) Power: AC 120V/60Hz Humidity: 54 %

No.	Mk.	Freq. MHz	Reading Level dBμV	Correct Factor dB	Measure- ment dBμV	Limit dBμV	Over dB	Detector	Comment
1		0.1500	32.40	11.52	43.92	65.99	-22.07	QP	
2		0.1500	14.17	11.52	25.69	55.99	-30.30	AVG	
3		0.1891	27.02	11.49	38.51	64.07	-25.56	QP	
4		0.1891	7.74	11.49	19.23	54.07	-34.84	AVG	
5		0.3453	29.24	11.41	40.65	59.07	-18.42	QP	
6		0.3453	13.14	11.41	24.55	49.07	-24.52	AVG	
7		0.4117	27.41	11.35	38.76	57.61	-18.85	QP	
8		0.4117	10.46	11.35	21.81	47.61	-25.80	AVG	
9	*	0.4898	28.41	11.31	39.72	56.17	-16.45	QP	
10		0.4898	10.87	11.31	22.18	46.17	-23.99	AVG	
11		1.2711	23.39	11.32	34.71	56.00	-21.29	QP	
12		1.2711	8.44	11.32	19.76	46.00	-26.24	AVG	

### Note1:

Freq. = Emission frequency in MHz

Reading level (dBμV) = Receiver reading

Corr. Factor (dB) = Antenna factor + Cable loss

Measurement (dBμV) = Reading level (dBμV) + Corr. Factor (dB)

Limit (dBμV) = Limit stated in standard

Margin (dB) = Measurement (dBμV) – Limits (dBμV)

Q.P. =Quasi-Peak AVG =average

\* is meaning the worst frequency has been tested in the frequency range 150 kHz to 30MHz.

**Note2:** Measurements were conducted in all three channels (high, middle, low) and three modulation (GFSK, Pi/4 DQPSK, 8DPSK), and the worst case Mode (Highest channel and GFSK) was submitted only.

### 6.3. Conducted Output Power

#### 6.3.1. Test Specification

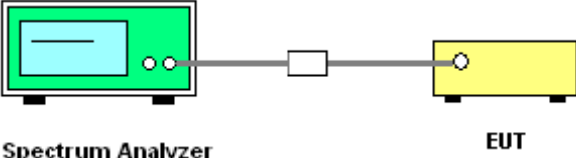
<b>Test Requirement:</b>	FCC Part15 C Section 15.247 (b)(3)
<b>Test Method:</b>	ANSI C63.10:2013 and DA00-705
<b>Limit:</b>	Section 15.247 (b) The maximum peak conducted output power of the intentional radiator shall not exceed the following: (1) For frequency hopping systems operating in the 2400-2483.5 MHz band employing at least 75 non-overlapping hopping channels, and all frequency hopping systems in the 5725-5850 MHz band: 1 watt. For all other frequency hopping systems in the 2400-2483.5 MHz band 0.125 watts.
<b>Test Setup:</b>	 <p style="text-align: center;">Spectrum Analyzer                      EUT</p>
<b>Test Mode:</b>	Transmitting mode with modulation
<b>Test Procedure:</b>	Use the following spectrum analyzer settings: Span = approximately 5 times the 20 dB bandwidth, centered on a hopping channel RBW > the 20 dB bandwidth of the emission being measured VBW ≥ RBW Sweep = auto Detector function = peak Trace = max hold Allow the trace to stabilize. Use the marker-to-peak function to set the marker to the peak of the emission.
<b>Test Result:</b>	PASS

#### 6.3.2. Test Instruments

Equipment	Manufacturer	Model	Serial Number	Calibration Due
Spectrum Analyzer	Agilent	N9020A	MY49100060	Sep. 12, 2016
RF Cable	TCT	RE-06	N/A	Sep. 12, 2016
Antenna Connector	TCT	RFC-01	N/A	Sep. 12, 2016

**Note:** The calibration interval of the above test instruments is 12 months and the calibrations are traceable to international system unit (SI).

**6.3.3. Test Data**

GFSK mode			
Test channel	Peak Output Power (dBm)	Limit (dBm)	Result
Lowest	7.461	21.00	PASS
Middle	6.979	21.00	PASS
Highest	6.506	21.00	PASS

Pi/4DQPSK mode			
Test channel	Peak Output Power (dBm)	Limit (dBm)	Result
Lowest	8.473	21.00	PASS
Middle	8.099	21.00	PASS
Highest	7.211	21.00	PASS

8DPSK mode			
Test channel	Peak Output Power (dBm)	Limit (dBm)	Result
Lowest	8.655	21.00	PASS
Middle	8.300	21.00	PASS
Highest	7.530	21.00	PASS

Test plots as follows:

Lowest channel

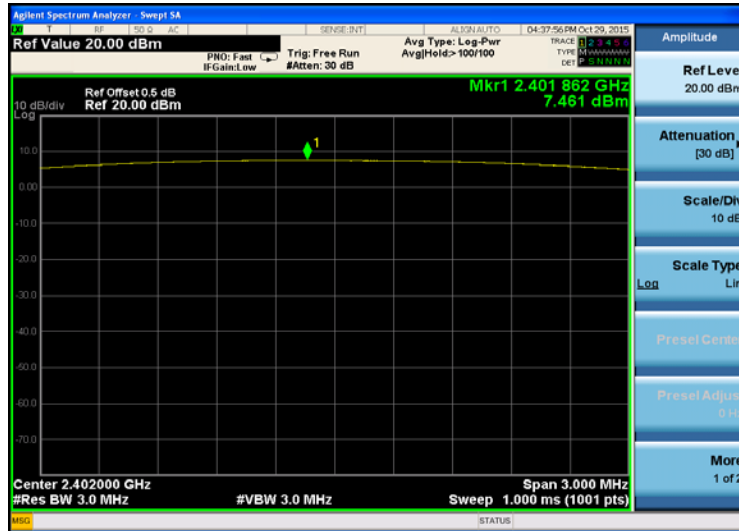

Middle channel

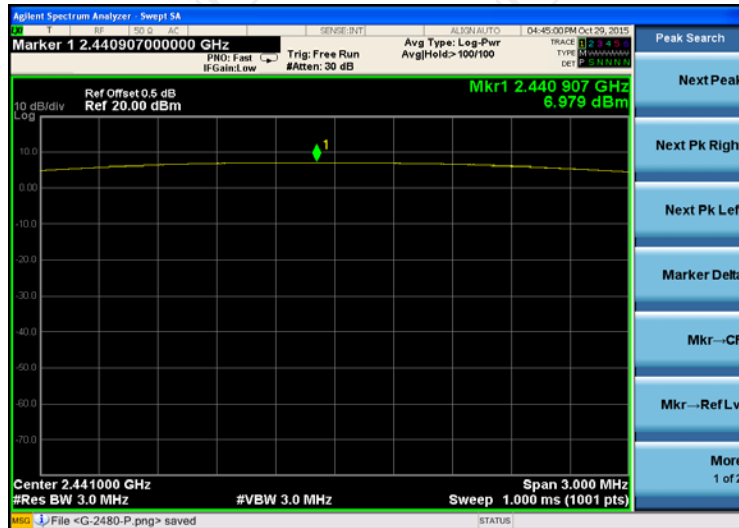

Highest channel

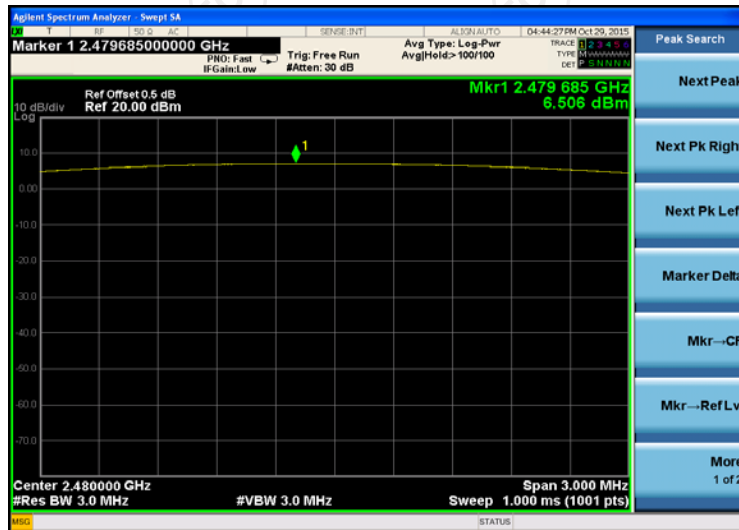

### Lowest channel

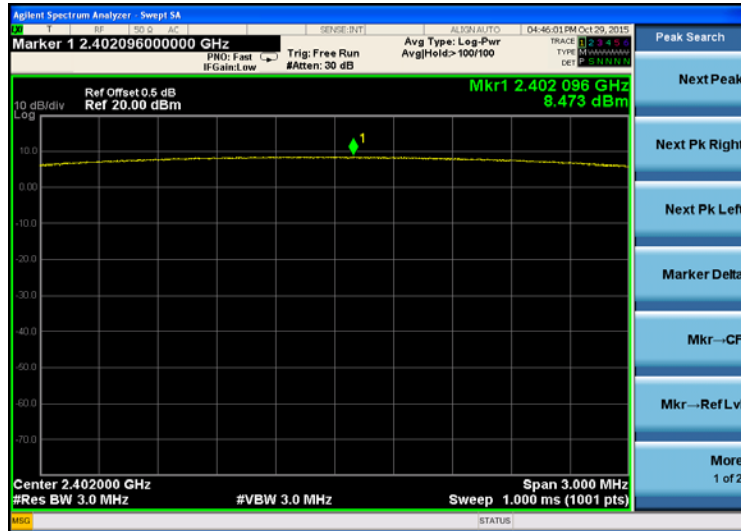

### Middle channel

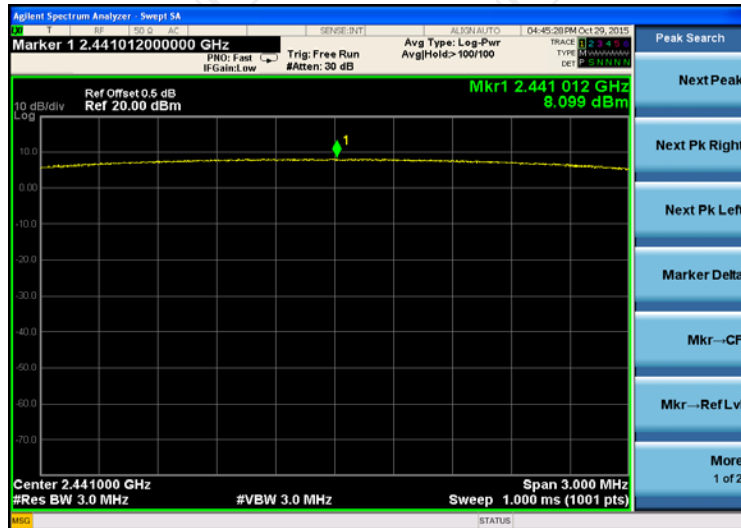

### Highest channel

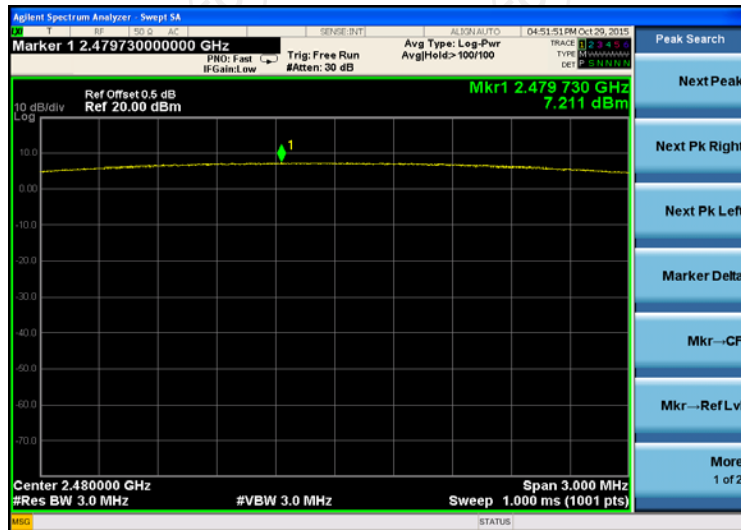



### Lowest channel

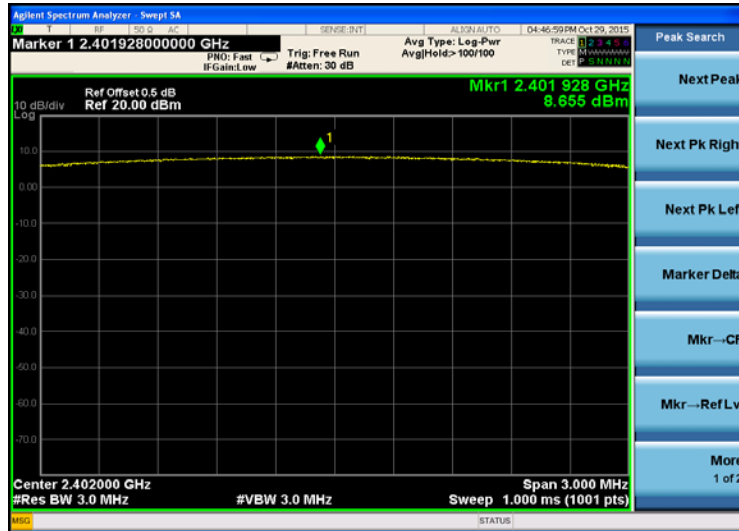

### Middle channel

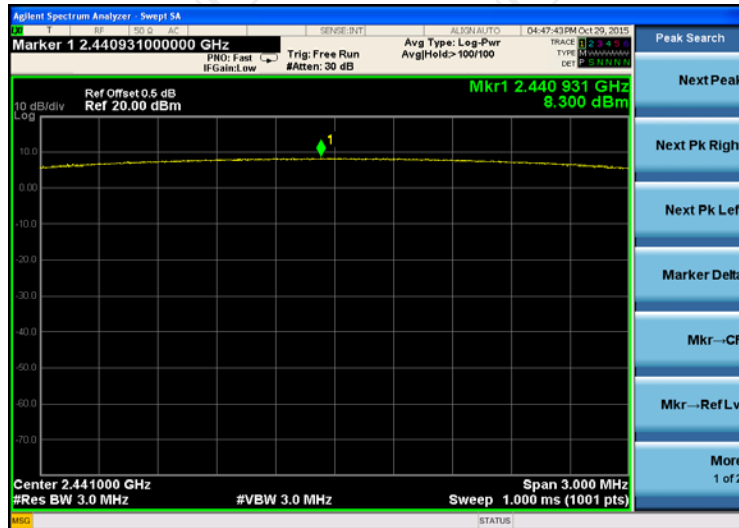

### Highest channel

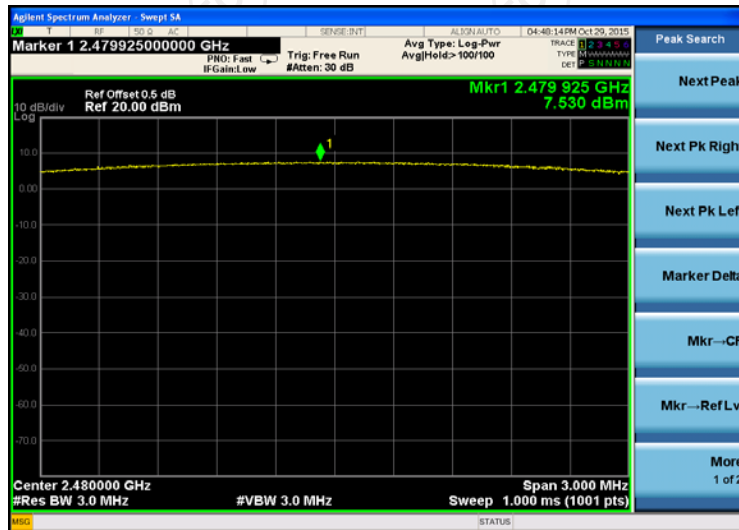

## 6.4. 20dB Occupy Bandwidth

### 6.4.1. Test Specification

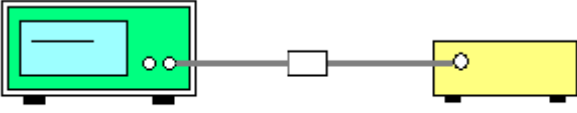
<b>Test Requirement:</b>	FCC Part15 C Section 15.247 (a)(1)
<b>Test Method:</b>	ANSI C63.10:2013 and DA00-705
<b>Limit:</b>	N/A
<b>Test Setup:</b>	 <p style="text-align: center;">Spectrum Analyzer                      EUT</p>
<b>Test Mode:</b>	Transmitting mode with modulation
<b>Test Procedure:</b>	<ol style="list-style-type: none"> <li>1. The testing follows FCC Public Notice DA 00-705 Measurement Guidelines.</li> <li>2. The RF output of EUT was connected to the spectrum analyzer by RF cable and attenuator. The path loss was compensated to the results for each measurement.</li> <li>3. Set to the maximum power setting and enable the EUT transmit continuously.</li> <li>4. Use the following spectrum analyzer settings for 20dB Bandwidth measurement. Span = approximately 2 to 3 times the 20 dB bandwidth, centered on a hopping channel; RBW<math>\geq</math>1% of the 20 dB bandwidth; VBW<math>\geq</math>RBW; Sweep = auto; Detector function = peak; Trace = max hold.</li> <li>5. Measure and record the results in the test report.</li> </ol>
<b>Test Result:</b>	PASS

### 6.4.2. Test Instruments

RF Test Room				
Equipment	Manufacturer	Model	Serial Number	Calibration Due
Spectrum Analyzer	Agilent	N9020A	MY49100060	Sep. 12, 2016
RF cable	TCT	RE-06	N/A	Sep. 12, 2016
Antenna Connector	TCT	RFC-01	N/A	Sep. 12, 2016

**Note:** The calibration interval of the above test instruments is 12 months and the calibrations are traceable to international system unit (SI).

**6.4.3. Test data**

Test channel	20dB Occupy Bandwidth (kHz)			Conclusion
	GFSK	$\pi/4$ -DQPSK	8DPSK	
Lowest	921.9	1226	1262	PASS
Middle	899.6	1208	1261	PASS
Highest	903.3	1218	1210	PASS

Test plots as follows:



Lowest channel



Middle channel

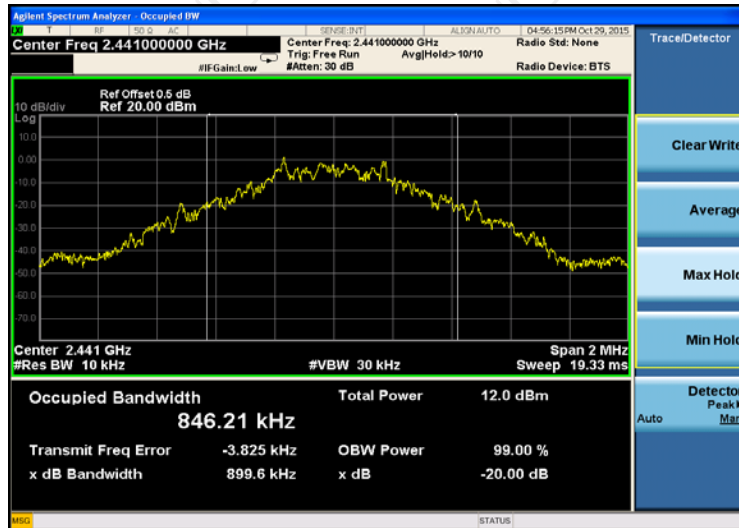

Highest channel

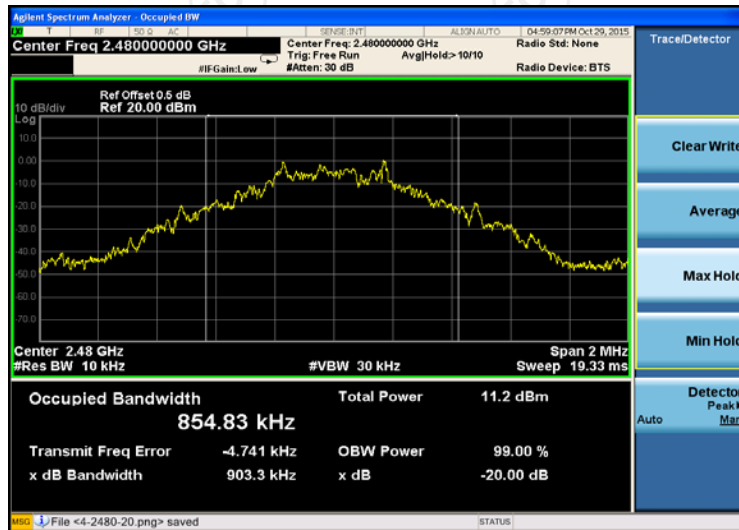

### Lowest channel

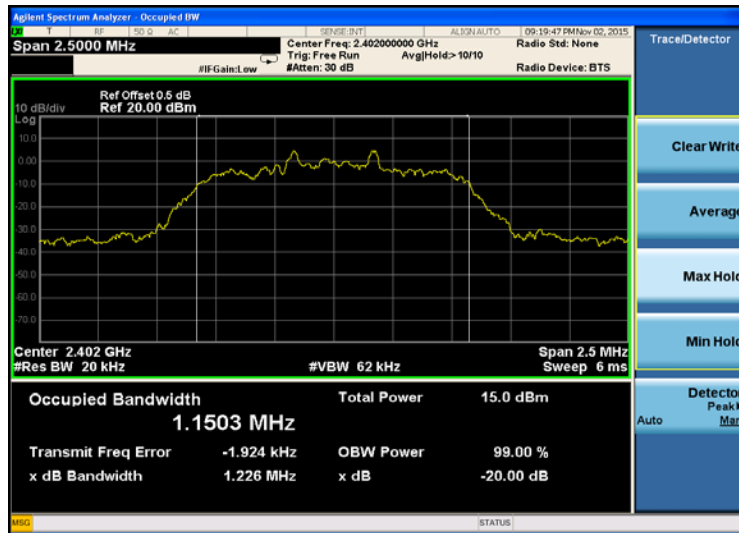

### Middle channel

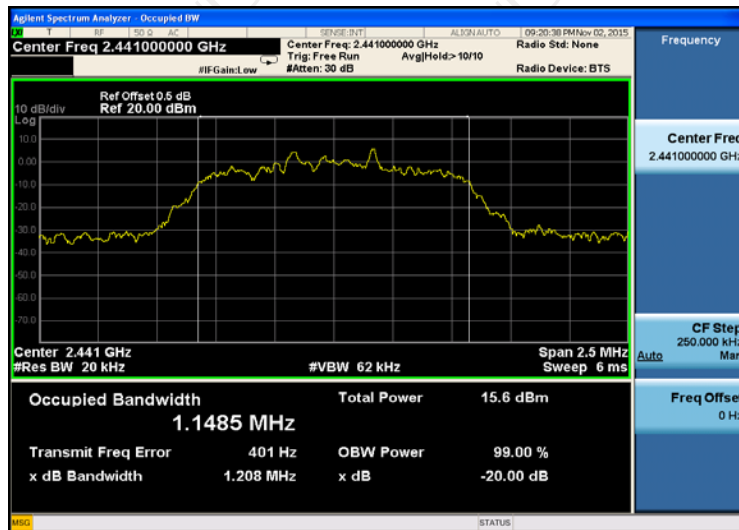

### Highest channel

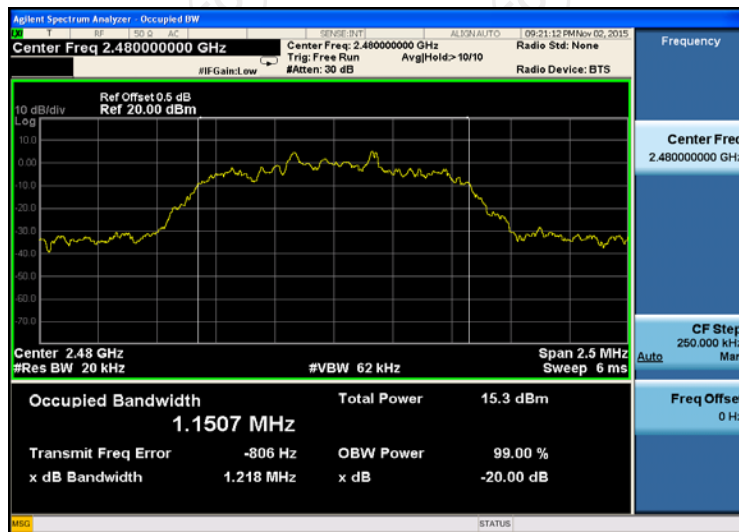

### Lowest channel

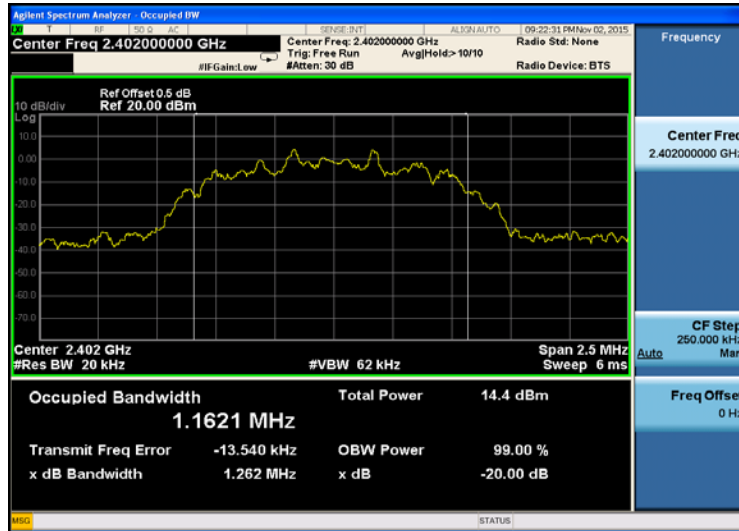

### Middle channel

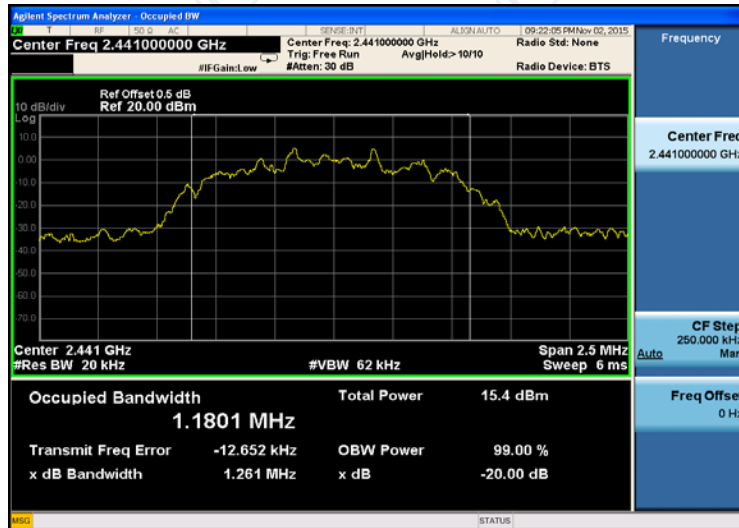

### Highest channel

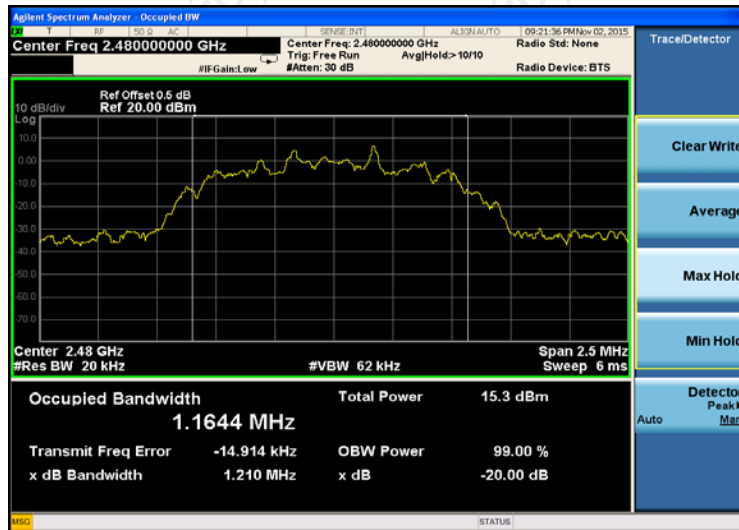

## 6.5. Carrier Frequencies Separation

### 6.5.1. Test Specification

<b>Test Requirement:</b>	FCC Part15 C Section 15.247 (a)(1)
<b>Test Method:</b>	ANSI C63.10:2013 and DA00-705
<b>Limit:</b>	Frequency hopping systems operating in the 2400-2483.5 MHz band may have hopping channel carrier frequencies that are separated by 25 kHz or two-thirds of the 20 dB bandwidth of the hopping channel, whichever is greater.
<b>Test Setup:</b>	 <p style="text-align: center;">Spectrum Analyzer                      EUT</p>
<b>Test Mode:</b>	Hopping mode
<b>Test Procedure:</b>	<ol style="list-style-type: none"> <li>1. The testing follows FCC Public Notice DA 00-705 Measurement Guidelines.</li> <li>2. The RF output of EUT was connected to the spectrum analyzer by RF cable and attenuator. The path loss was compensated to the results for each measurement.</li> <li>3. Set to the maximum power setting and enable the EUT transmit continuously.</li> <li>4. Enable the EUT hopping function.</li> <li>5. Use the following spectrum analyzer settings: Span = wide enough to capture the peaks of two adjacent channels; RBW ≥ 1% of the span; VBW ≥ RBW; Sweep = auto; Detector function = peak; Trace = max hold.</li> <li>6. Measure and record the results in the test report.</li> </ol>
<b>Test Result:</b>	PASS

### 6.5.2. Test Instruments

RF Test Room				
Equipment	Manufacturer	Model	Serial Number	Calibration Due
Spectrum Analyzer	Agilent	N9020A	MY49100060	Sep. 12, 2016
RF cable	TCT	RE-06	N/A	Sep. 12, 2016
Antenna Connector	TCT	RFC-01	N/A	Sep. 12, 2016

**Note:** The calibration interval of the above test instruments is 12 months and the calibrations are traceable to international system unit (SI).

**6.5.3. Test data**

GFSK mode			
Test channel	Carrier Frequencies Separation (kHz)	Limit (kHz)	Result
Lowest	1002.5	614.6	PASS
Middle	1002.5	614.6	PASS
Highest	1002.5	614.6	PASS

Pi/4 DQPSK mode			
Test channel	Carrier Frequencies Separation (kHz)	Limit (kHz)	Result
Lowest	1002.5	817.33	PASS
Middle	1007.5	817.33	PASS
Highest	1002.5	817.33	PASS

8DPSK mode			
Test channel	Carrier Frequencies Separation (kHz)	Limit (kHz)	Result
Lowest	997.5	841.33	PASS
Middle	1000.0	841.33	PASS
Highest	1000.0	841.33	PASS

**Note: According to section 6.4**

Mode	20dB bandwidth (kHz) (worse case)	Limit (kHz) (Carrier Frequencies Separation)
GFSK	921.9	614.6
$\pi/4$ -DQPSK	1226	817.33
8DPSK	1262	841.33

Test plots as follows:



Lowest channel



Middle channel



Highest channel

