

# TEST REPORT

**FCC ID: 2ACJAPLT11XX**

**Product: TABLET PC**

**Model No.: PLT1150, PLT11XX**  
(“XX” can be replaced by digital from “00” to “99”)

**Trade mark: N/A**

**Report No.: TCT160329E015**

**Issued Date: Apr. 08, 2016**

Issued for:

**ShenZhen Harmony Technology Co., Ltd**  
**Block 2, Jiayuan Industrial Zone, Heping Community high-tech Park, No 2**  
**Fuyuan Road, Fuyong, Bao'an, Shenzhen, China**

Issued By:

**Shenzhen Tongce Testing Lab**  
**1F, Leinuo Watch Building, Fuyong Town, Baoan Dist, Shenzhen, China**  
**TEL: +86-755-27673339**  
**FAX: +86-755-27673332**

**Note:** This report shall not be reproduced except in full, without the written approval of Shenzhen Tongce Testing Lab. This document may be altered or revised by Shenzhen Tongce Testing Lab personnel only, and shall be noted in the revision section of the document. The test results in the report only apply to the tested sample.

**TABLE OF CONTENTS**

1. Test Certification .....	3
2. Test Result Summary .....	4
3. EUT Description.....	5
4. Test Methodology .....	6
4.1. Decision of Final Test Mode .....	6
4.2. EUT System Operation.....	6
5. Setup of Equipment under Test .....	7
5.1. Description of Support Units.....	7
5.2. Configuration of System Under Test .....	8
6. Facilities and Accreditations .....	9
6.1. Facilities.....	9
6.2. Location .....	9
6.3. Measurement Uncertainty.....	9
7. Emission Test .....	10
7.1. Conducted Emission at Mains Terminals .....	10
7.2. Radiated Emission.....	14

**Appendix A: Photographs of 15B Test Setup**

**Appendix B: Photographs of EUT**

## 1. Test Certification

<b>Product:</b>	TABLET PC
<b>Model No.:</b>	PLT1150, PLT11XX ("XX" can be replaced by digital from "00" to "99")
<b>Applicant:</b>	ShenZhen Harmony Technology Co., Ltd
<b>Address:</b>	Block 2, Jiayuan Industrial Zone, Heping Community high-tech Park, No 2 Fuyuan Road, Fuyong, Bao'an, Shenzhen, China
<b>Manufacturer:</b>	ShenZhen Harmony Technology Co., Ltd
<b>Address:</b>	Block 2, Jiayuan Industrial Zone, Heping Community high-tech Park, No 2 Fuyuan Road, Fuyong, Bao'an, Shenzhen, China
<b>Test Voltage:</b>	AC 120 V/ 60 Hz, DC 5V(PC Input AC 120 V/ 60 Hz)
<b>Date of Test:</b>	Apr. 05, 2016-Apr. 07, 2016
<b>Applicable Standards:</b>	47 CFR FCC Part 15 Subpart B: 2016 ANSI C63.4: 2014

The above equipment has been tested by Shenzhen Tongce Testing Lab and found compliance with the requirements set forth in the technical standards mentioned above. The results of testing in this report apply only to the product/system, which was tested. Other similar equipment will not necessarily produce the same results due to production tolerance and measurement uncertainties.

**Tested By:**   
**Derek Cai**

**Date:** Apr. 07, 2016

**Check By:**   
**Joe Zhou**

**Date:** Apr. 08, 2016

**Approved By:**   
**Tomsin**

**Date:** Apr. 08, 2016

## 2. Test Result Summary

Emission		
Test Method	Item	Result
FCC 47 CFR Part 15 Subpart B	Conducted Emission at Mains Terminals	Pass
	Radiated Emission	Pass

**Note:**

1. Pass: Test item meets the requirement.
2. Fail: Test item does not meet the requirement.
3. N/A: Test case does not apply to the test object.
4. The test result judgment is decided by the limit of test standard.
5. The information of measurement uncertainty is available upon the customer's request.

### 3. EUT Description

<b>Product Name:</b>	TABLET PC
<b>Model No.:</b>	PLT1150, PLT11XX (“XX” can be replaced by digital from “00” to “99”)
<b>Product Parameter:</b>	Input: DC 3.7 V from battery & DC 5V from PC/adapter
<b>Highest Frequency:</b>	1.2 GHz
<b>AC Line(PC):</b>	<input type="checkbox"/> Shielded <input checked="" type="checkbox"/> Unshielded, <input checked="" type="checkbox"/> Detachable <input type="checkbox"/> Un-detachable <input type="checkbox"/> Not applicable <input checked="" type="checkbox"/> Length: 1.2 m
<b>AC Line(Monitor):</b>	<input type="checkbox"/> Shielded <input checked="" type="checkbox"/> Unshielded, <input checked="" type="checkbox"/> Detachable <input type="checkbox"/> Un-detachable <input type="checkbox"/> Not applicable <input checked="" type="checkbox"/> Length: 1.2 m
<b>AC Line(Printer):</b>	<input type="checkbox"/> Shielded <input checked="" type="checkbox"/> Unshielded, <input checked="" type="checkbox"/> Detachable <input type="checkbox"/> Un-detachable <input type="checkbox"/> Not applicable <input checked="" type="checkbox"/> Length: 1.2 m
<b>USB Line (PC to EUT):</b>	<input type="checkbox"/> Shielded <input checked="" type="checkbox"/> Unshielded, <input checked="" type="checkbox"/> Detachable <input type="checkbox"/> Un-detachable <input type="checkbox"/> Not applicable <input checked="" type="checkbox"/> Length: 0.8 m
<b>USB Line (PC to Printer):</b>	<input type="checkbox"/> Shielded <input checked="" type="checkbox"/> Unshielded, <input checked="" type="checkbox"/> Detachable <input type="checkbox"/> Un-detachable <input type="checkbox"/> Not applicable <input checked="" type="checkbox"/> Length: 1.0 m
<b>USB Line (Mouse):</b>	<input type="checkbox"/> Shielded <input checked="" type="checkbox"/> Unshielded, <input checked="" type="checkbox"/> Detachable <input type="checkbox"/> Un-detachable <input type="checkbox"/> Not applicable <input checked="" type="checkbox"/> Length: 1.5 m
<b>USB Line (Keyboard):</b>	<input type="checkbox"/> Shielded <input checked="" type="checkbox"/> Unshielded, <input checked="" type="checkbox"/> Detachable <input type="checkbox"/> Un-detachable <input type="checkbox"/> Not applicable <input checked="" type="checkbox"/> Length: 1.5 m
<b>VGA Line</b>	<input type="checkbox"/> Shielded <input checked="" type="checkbox"/> Unshielded, <input checked="" type="checkbox"/> Detachable <input type="checkbox"/> Un-detachable <input type="checkbox"/> Not applicable <input checked="" type="checkbox"/> Length: 1.2 m

## 4. Test Methodology

### 4.1. Decision of Final Test Mode

The EUT was tested together with the thereafter additional components, and a configuration, which produced the worst emission levels, was selected and recorded in this report.

The following test mode(s) were assessed:

Test Mode
Mode 1: Charging and Data Transmitting
Mode 2: Charging and Camera recording
Mode 3: Charging and Memory Playing
Mode 4: Charging and SD Playing
Mode 5: Charging and HDMI Mode

The following test mode was found to produce the highest emission level.

The Worst Test Mode		
Emission	Conducted Emission	Mode 1: Charging and Data Transmitting
	Radiated Emission	Mode 1: Charging and Data Transmitting

### 4.2. EUT System Operation

1. Set up EUT with the support equipments.
2. Make sure the EUT work normally during the test.

## 5. Setup of Equipment under Test

### 5.1. Description of Support Units

The EUT has been tested as an independent unit together with other necessary accessories or support units. The following support units or accessories were used to form a representative test configuration during the tests.

Equipment	Model No.	Serial No.	FCC ID	Trade Name
SD Card	SDSDU-016G	/	DOC	SanDisk
PC	BM6620	D1PFCG008HP	DOC	ASUS
Monitor	VX239	VX239H	DOC	ASUS
Keyboard	PK1100UE	04G104180039DP	DOC	ASUS
Printer	L11121E	FE2-2902	DOC	CANON
Mouse	MOBTUO	04G125610170DP	DOC	ASUS
Earphone	H257P	/	DOC	Edifier

**Note:**

1. All the equipment/cables were placed in the worst-case configuration to maximize the emission during the test.
2. Grounding was established in accordance with the manufacturer's requirements and conditions for the intended use.

## 5.2. Configuration of System Under Test

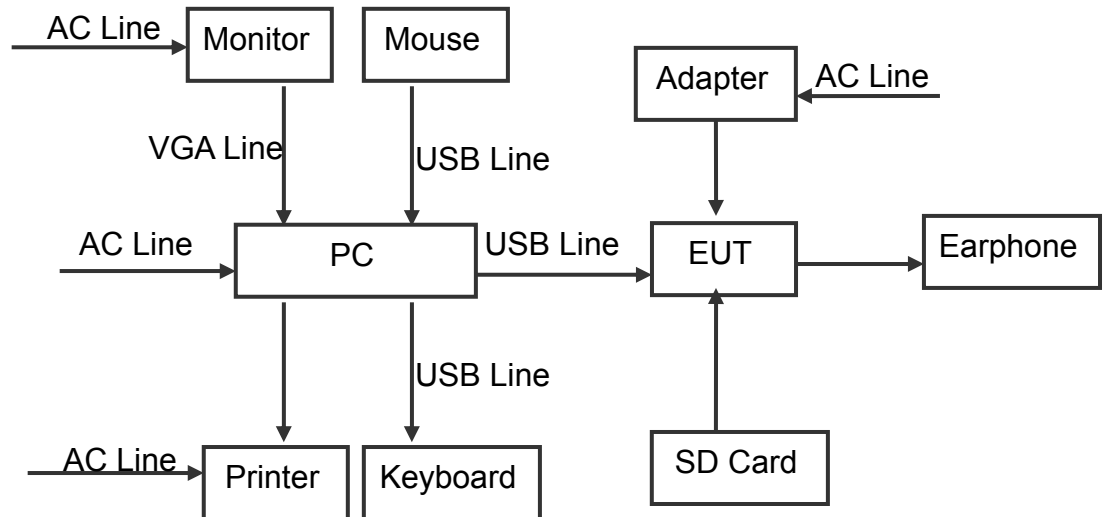

Mode 1

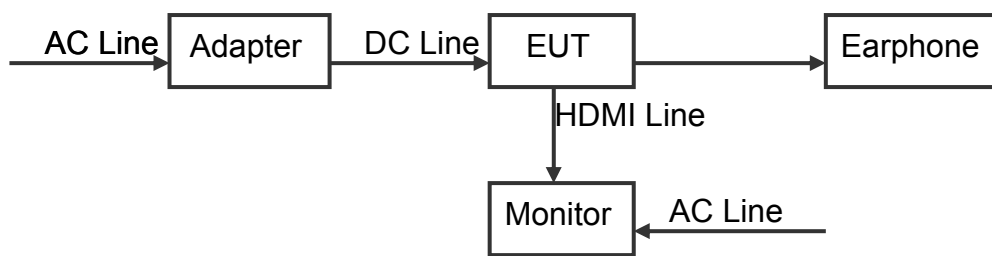

Mode 5



Mode 2/3/4

**(EUT: TABLET PC)**



## 6. Facilities and Accreditations

### 6.1. Facilities

The test facility is recognized, certified, or accredited by the following organizations:

- FCC - Registration No.: 572331

Shenzhen Tongce Testing Lab

The 3m Semi-anechoic chamber has been registered and fully described in a report with the (FCC) Federal Communications Commission. The acceptance letter from the FCC is maintained in our files.

- IC - Registration No.: 10668A-1

The 3m Semi-anechoic chamber of Shenzhen TCT Testing Technology Co., Ltd. has been registered by Certification and Engineering Bureau of Industry Canada for radio equipment testing

- CNAS - Registration No.: CNAS L6165

Shenzhen TCT Testing Technology Co., Ltd. is accredited to ISO/IEC 17025:2005 General Requirements for the Competence of Testing and Calibration laboratories for the competence of testing. The Registration No. is CNAS L6165.

### 6.2. Location

Shenzhen Tongce Testing Lab

Address: 1F, Leinuo Watch Building, Fuyong Town, Baoan Dist, Shenzhen, China

Tel: 86-755-36638142

### 6.3. Measurement Uncertainty

The reported uncertainty of measurement  $y \pm U$ , where expanded uncertainty  $U$  is based on a standard uncertainty multiplied by a coverage factor of  $k=2$ , providing a level of confidence of approximately 95 %.

No.	Item	MU
1	Conducted Emission	$\pm 2.56\text{dB}$
2	RF power, conducted	$\pm 0.12\text{dB}$
3	Spurious emissions, conducted	$\pm 0.11\text{dB}$
4	All emissions, radiated(<1G)	$\pm 3.92\text{dB}$
5	All emissions, radiated(>1G)	$\pm 4.28\text{dB}$
6	Temperature	$\pm 0.1^\circ\text{C}$
7	Humidity	$\pm 1.0\%$

## 7. Emission Test

### 7.1. Conducted Emission at Mains Terminals

#### 7.1.1. Test Specification

<b>Test Requirement:</b>	FCC 47 CFR Part 15 Subpart B
<b>Test Method:</b>	ANSI C63.4:2014
<b>Frequency Range:</b>	150 kHz to 30 MHz

#### 7.1.2. Limits

Frequency (MHz)	Class B dB(uV)	
	Quasi-peak	Average
0.15 - 0.5	66 – 56 <sup>a</sup>	56 – 46 <sup>a</sup>
0.50 - 5.0	56	46
5.0 - 30.0	60	50

a. Decreases with the logarithm of the frequency

#### 7.1.3. Test Instruments

Conducted Emission Shielding Room Test Site (843)				
Equipment	Manufacturer	Model	Serial Number	Calibration Due
EMI Test Receiver	R&S	ESCS30	100139	Sep. 11, 2016
LISN	Schwarzbeck	NSLK 8126	8126453	Sep. 16, 2016
LISN	AFJ	LS16C	16010947251	Sep. 11, 2016
Coax cable	TCT	CE-05	N/A	Sep. 11, 2016

**Note:** The calibration interval of the above test instruments is 12 months and the calibrations are traceable to international system unit (SI).

#### 7.1.4. Test Method

The AMN was placed 0.8 m from the boundary of the unit under test and bonded to a ground reference plane. This distance was between the closest points of the AMN and the EUT. All other units of the EUT and associated equipment was at least 0.8 m from the AMN. All power was connected to the system through Artificial Mains Network (AMN). Conducted voltage measurements on mains lines were made at the output of the AMN

### 7.1.5. Block Diagram of Test Setup

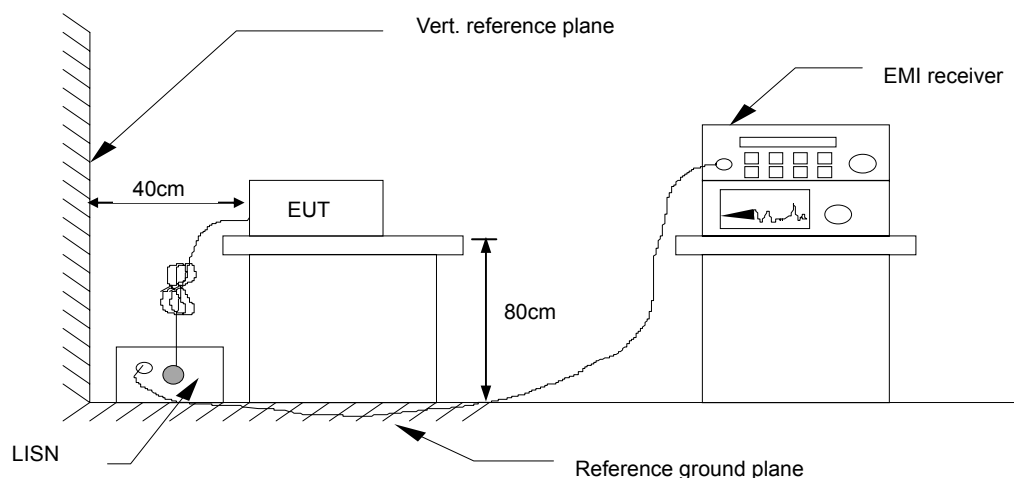

For the actual test configuration, please refer to the related item – Photographs of the Test Configuration.

### 7.1.6. Test Results

<b>Test Environment:</b>	Temp.: 23 °C	Humid.: 54 %	Press.: 96 kPa
<b>Test Mode:</b>	Mode 1		
<b>Test Voltage:</b>	DC 5 V(PC Input AC 120 V/ 60 Hz)		
<b>Test Result:</b>	Pass		

**Note:**

L1 = Live Line / N = Neutral Line

“---” denotes the emission level was or more than 2dB below the Average limit, so no re-check anymore.

Freq. = Emission frequency in MHz

Reading level dB(μV) = Receiver reading

Corr. Factor (dB) = Attenuator factor + Cable loss

Level dB(μV) = Reading level dB(μV) + Corr. Factor (dB)

Limit dB(μV) = Limit stated in standard

Margin (dB) = Level dB(μV) – Limits dB(μV)

Q.P. =Quasi-Peak

AVG=Average

Please refer to following diagram for individual

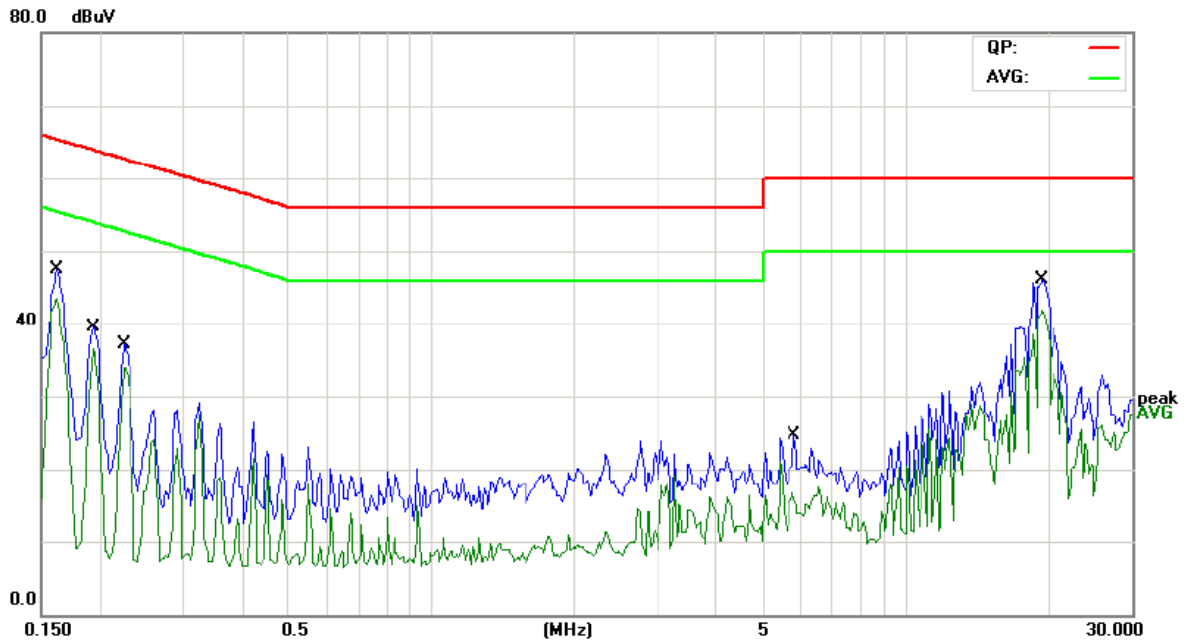

Site Chamber #2 Phase: **L1** Temperature: 23 (C)  
 Limit: FCC Part 15B Class B Conduction(QP) Power: Humidity: 54 %  
 Mode: Charging and Data Transmitting  
 Note: DC 5V(PC Input AC 120V/60Hz)

No.	Mk.	Freq. MHz	Reading Level dBuV	Correct Factor dB	Measure- ment dBuV	Limit dBuV	Over dB	Detector	Comment
1		0.1617	33.90	11.49	45.39	65.37	-19.98	QP	
2	*	0.1617	32.79	11.49	44.28	55.37	-11.09	AVG	
3		0.1930	26.83	11.46	38.29	63.90	-25.61	QP	
4		0.1930	23.96	11.46	35.42	53.90	-18.48	AVG	
5		0.2242	24.14	11.45	35.59	62.66	-27.07	QP	
6		0.2242	22.97	11.45	34.42	52.66	-18.24	AVG	
7		5.8086	10.05	10.73	20.78	60.00	-39.22	QP	
8		5.8086	7.39	10.73	18.12	50.00	-31.88	AVG	
9		19.3828	30.01	10.67	40.68	60.00	-19.32	QP	
10		19.3828	24.72	10.67	35.39	50.00	-14.61	AVG	

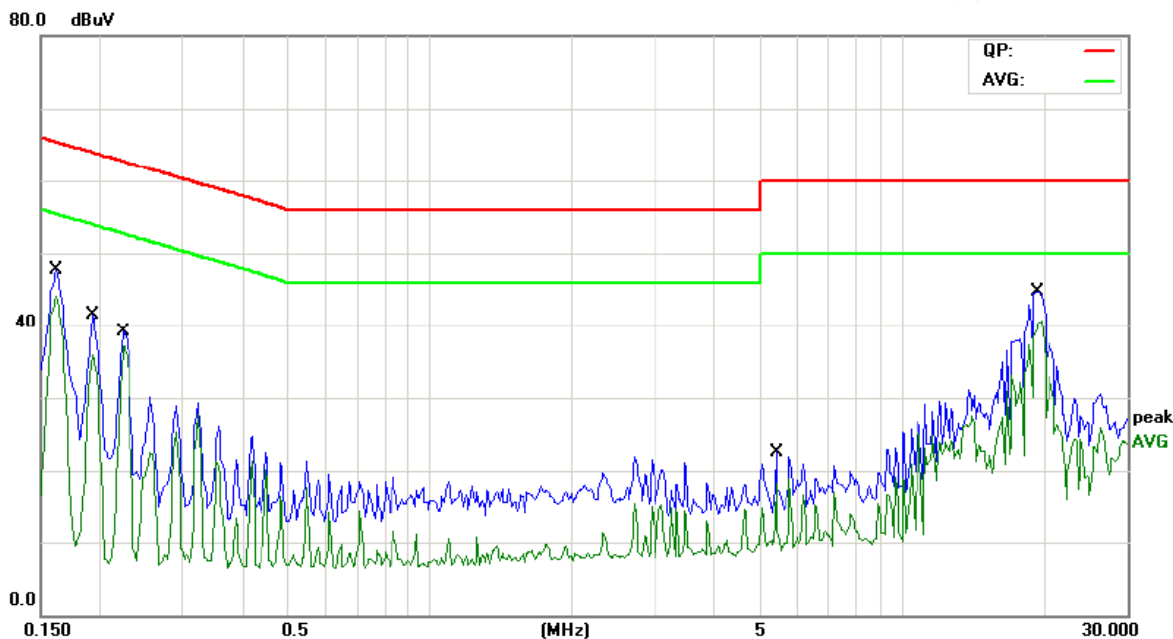

Site Chamber #2 Phase: **N** Temperature: 23 (C)  
 Limit: FCC Part 15B Class B Conduction(QP) Power: Humidity: 54 %  
 Mode: Charging and Data Transmitting  
 Note: DC 5V(PC Input AC 120V/60Hz)

No.	Mk.	Freq. MHz	Reading Level dBuV	Correct Factor dB	Measure- ment dBuV	Limit dBuV	Over dB	Detector	Comment
1		0.1617	34.87	11.49	46.36	65.37	-19.01	QP	
2	*	0.1617	33.58	11.49	45.07	55.37	-10.30	AVG	
3		0.1930	27.03	11.46	38.49	63.90	-25.41	QP	
4		0.1930	24.18	11.46	35.64	53.90	-18.26	AVG	
5		0.2242	26.20	11.45	37.65	62.66	-25.01	QP	
6		0.2242	25.11	11.45	36.56	52.66	-16.10	AVG	
7		5.4180	8.80	10.67	19.47	60.00	-40.53	QP	
8		5.4180	5.16	10.67	15.83	50.00	-34.17	AVG	
9		19.3789	30.23	10.67	40.90	60.00	-19.10	QP	
10		19.3789	24.97	10.67	35.64	50.00	-14.36	AVG	

## 7.2. Radiated Emission

### 7.2.1. Test Specification

<b>Test Requirement:</b>	FCC 47 CFR Part 15 Subpart B
<b>Test Method:</b>	ANSI C63.4:2014
<b>Frequency Range:</b>	30 MHz to 6000 MHz
<b>Measurement Distance:</b>	3 m
<b>Antenna Polarization:</b>	Horizontal & Vertical

### 7.2.2. Limits

Frequency (MHz)	Class B (at 3m)
	dBuV/m
30 ~ 88	40.0
88 ~ 216	43.5
216 ~ 960	46.0
960 ~ 1000	54.0
Above 1000	74.0(Peak) 54.0(Average)

**Note:**

1. The lower limit shall apply at the transition frequencies.
2. Emission level dB( $\mu$ V/m) = 20 log Emission level ( $\mu$ V/m).

### 7.2.3. Test Instruments

Radiated Emission Test Site (966)				
Name of Equipment	Manufacturer	Model	Serial Number	Calibration Due
EMI Test Receiver	R&S	ESVD	100008	Sep. 11, 2016
Spectrum Analyzer	R&S	FSEM	848597-001	Sep. 11, 2016
Amplifier	HP	8447D	2727A05017	Sep. 11, 2016
Amplifier	EM	EM30265	07032613	Sep. 11, 2016
Broadband Antenna	Schwarzbeck	VULB9163	340	Sep. 13, 2016
Horn Antenna	Schwarzbeck	BBHA 9120D	631	Sep. 13, 2016
Antenna Mater	CCS	CC-A-4M	N/A	Sep.15 , 2016

Coax cable	TCT	RE-low-01	N/A	Sep. 11, 2016
Coax cable	TCT	RE-high-02	N/A	Sep. 11, 2016
Coax cable	TCT	RE-low-03	N/A	Sep. 11, 2016
Coax cable	TCT	RE-high-04	N/A	Sep. 11, 2016

**Note:** The calibration interval of the above test instruments is 12 months and the calibrations are traceable to international system unit (SI).

### 7.2.4. Test Method

For the radiated emission test above 1GHz:

Place the measurement antenna away from each area of the EUT determined to be a source of emissions at the specified measurement distance, while keeping the measurement antenna aimed at the source of emissions at each frequency of significant emissions, with polarization oriented for maximum response. The measurement antenna may have to be higher or lower than the EUT, depending on the radiation pattern of the emission and staying aimed at the emission source for receiving the maximum signal. The final measurement antenna elevation shall be that which maximizes the emissions. The measurement antenna elevation for maximum emissions shall be restricted to a range of heights of from 1 m to 4 m above the ground or reference ground plane.

Measurements were made in a 3-meter semi-anechoic chamber or Open Area Test Site that complies to CISPR 16. Preliminary (peak) measurements were performed at an antenna to EUT separation distance of 3 meter. The EUT was rotated 360° about its azimuth with the receive antenna located at various heights in horizontal and vertical polarities. Final measurements (quasi-peak) were then performed by rotating the EUT 360° and adjusting the receive antenna height from 1 to 4 m. All frequencies were investigated in both horizontal and vertical antenna polarity, where applicable. Block Diagram of Test Setup.

### 7.2.5. Block Diagram of Test Setup

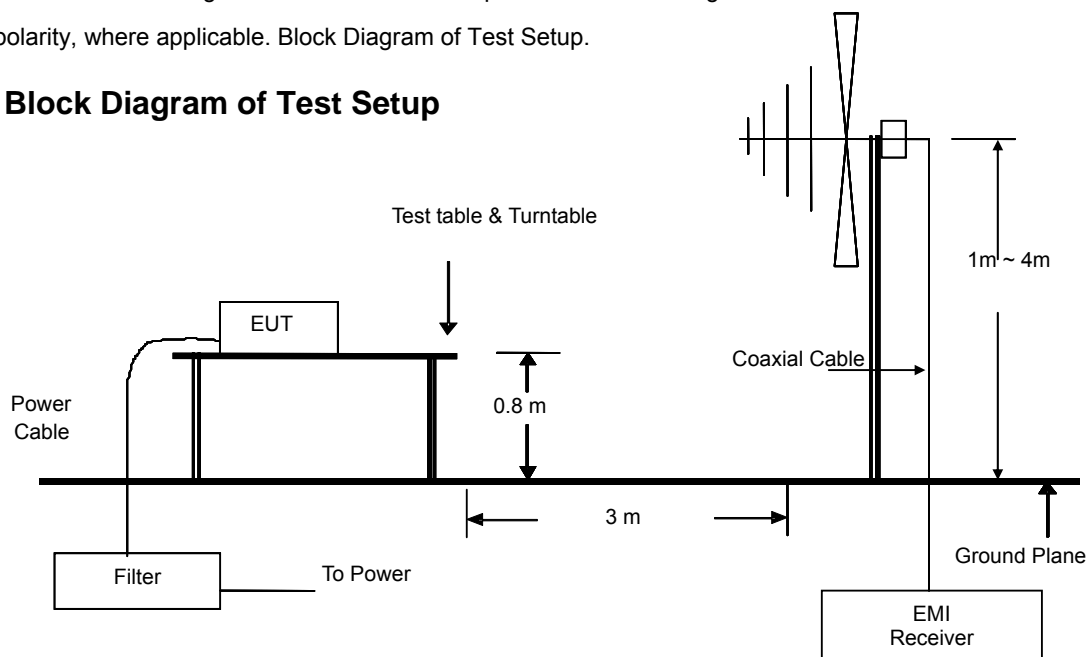

(30MHz to 1GHz)

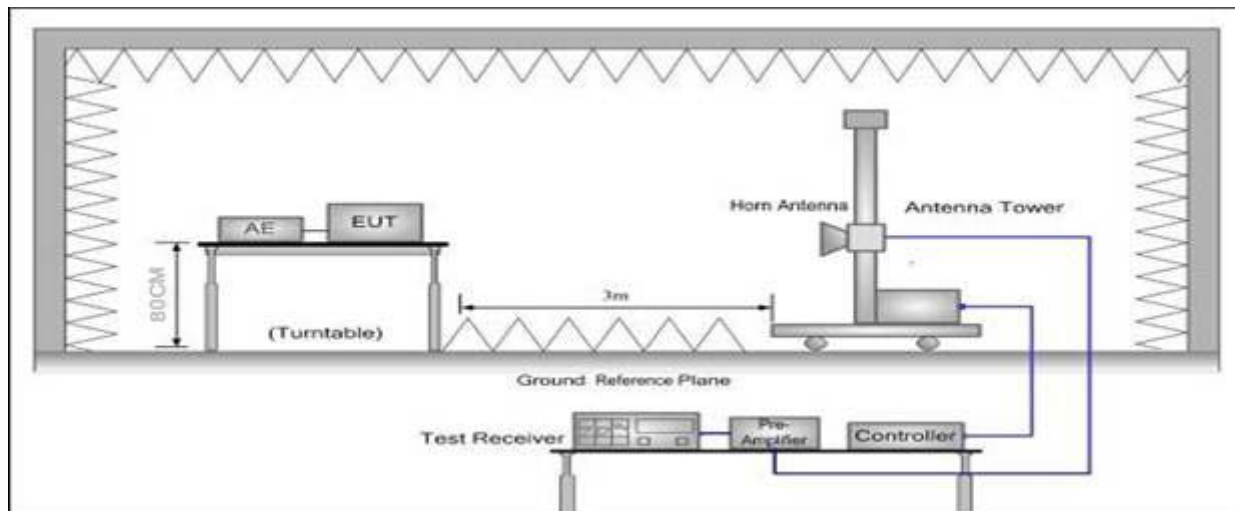

**(Above 1GHz)**

For the actual test configuration, please refer to the related item – Photographs of the Test Configuration

**7.2.6. Test Results**

<b>Test Environment:</b>	Temp.: 25 °C	Humid.: 54 %	Press.: 96 kPa
<b>Test Mode:</b>	Mode 1		
<b>Test Voltage:</b>	DC 5 V(PC Input AC 120 V/ 60 Hz)		
<b>Test Result:</b>	Pass		

**Note:**

- Freq. = Emission frequency in MHz
- Reading level dB(μV) = Receiver reading
- Corr. Factor (dB) = Antenna factor + Cable loss
- Measurement dB(μV/m) = Reading level dB(μV) + Corr. Factor (dB)
- Limit dB(μV/m) = Limit stated in standard
- Margin (dB) = Measurement dB(μV/m) – Limits dB(μV/m)
- Q.P. =Quasi-Peak



Please refer to following diagram for individual

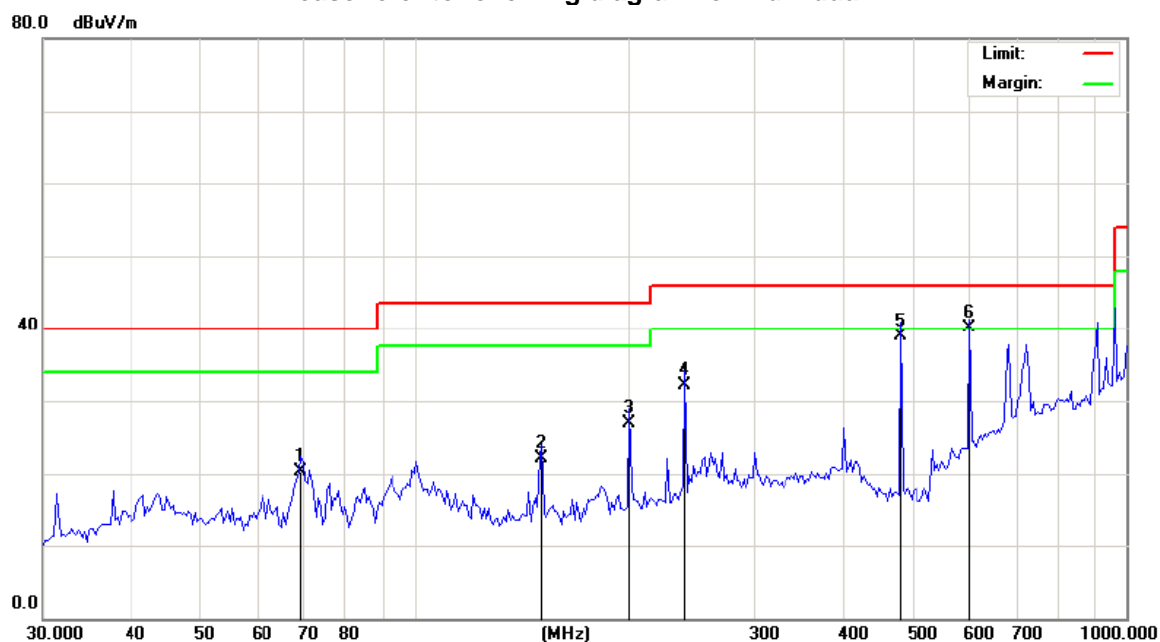

Site: Polarization: **Horizontal** Temperature: 25  
 Limit: FCC Part 15B Class B RE\_3 m Power: Humidity: 54 %  
 Mode: Charging and Data Transmtting  
 Note: DC 5V(PC Input AC 120V/60Hz)

No.	Mk.	Freq. MHz	Reading Level dBuV	Correct Factor dB	Measure- ment dBuV/m	Limit dBuV/m	Over dB	Antenna Height cm	Table Degree	Comment
1		69.2296	36.60	-16.22	20.38	40.00	-19.62	QP	0	
2		151.0252	37.10	-15.07	22.03	43.50	-21.47	QP	0	
3		200.0432	38.50	-11.67	26.83	43.50	-16.67	QP	0	
4		240.1442	42.40	-10.31	32.09	46.00	-13.91	QP	0	
5		481.5110	42.50	-3.56	38.94	46.00	-7.06	QP	0	
6	*	602.9287	41.90	-1.87	40.03	46.00	-5.97	QP	0	

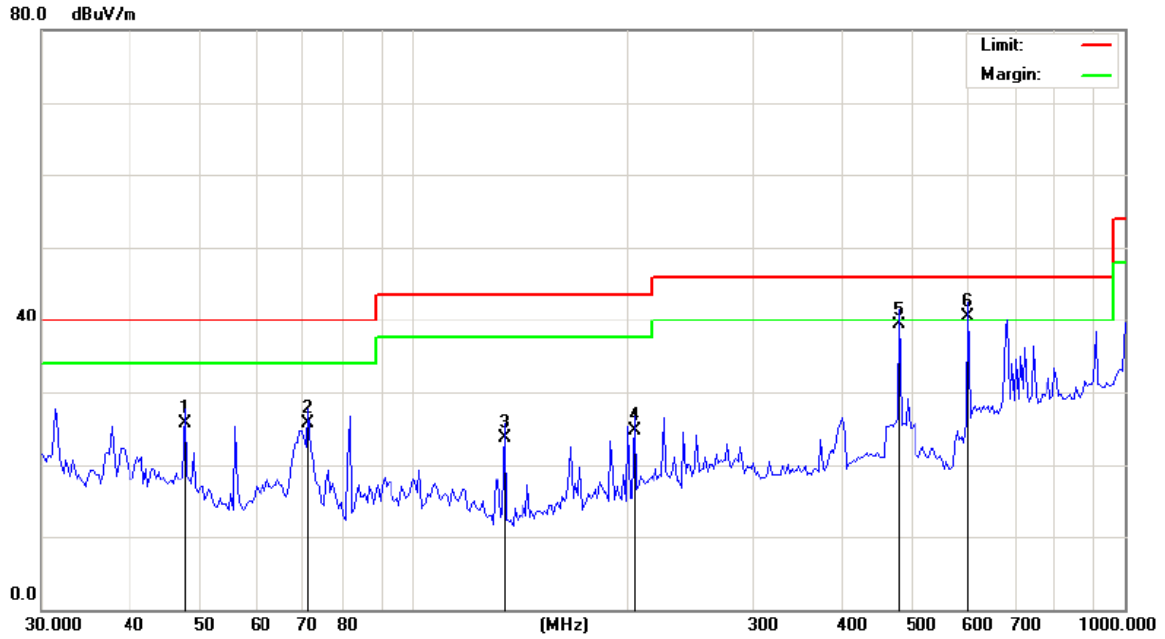

Site: Polarization: **Vertical** Temperature: 25  
 Limit: FCC Part 15B Class B RE\_3 m Power: Humidity: 54 %  
 Mode: Charging and Data Transmtting  
 Note: DC 5V(PC Input AC 120V/60Hz)

No.	Mk.	Freq. MHz	Reading Level dBuV	Correct Factor dB	Measure- ment dBuV/m	Limit dBuV/m	Over dB	Antenna Height cm	Table Degree degree	Comment
1		47.7028	37.80	-12.13	25.67	40.00	-14.33	QP	0	
2		71.2031	42.20	-16.47	25.73	40.00	-14.27	QP	0	
3		134.0192	38.90	-15.17	23.73	43.50	-19.77	QP	0	
4		204.3052	36.30	-11.53	24.77	43.50	-18.73	QP	0	
5		481.5110	42.90	-3.56	39.34	46.00	-6.66	QP	0	
6	*	602.9287	42.30	-1.87	40.43	46.00	-5.57	QP	0	

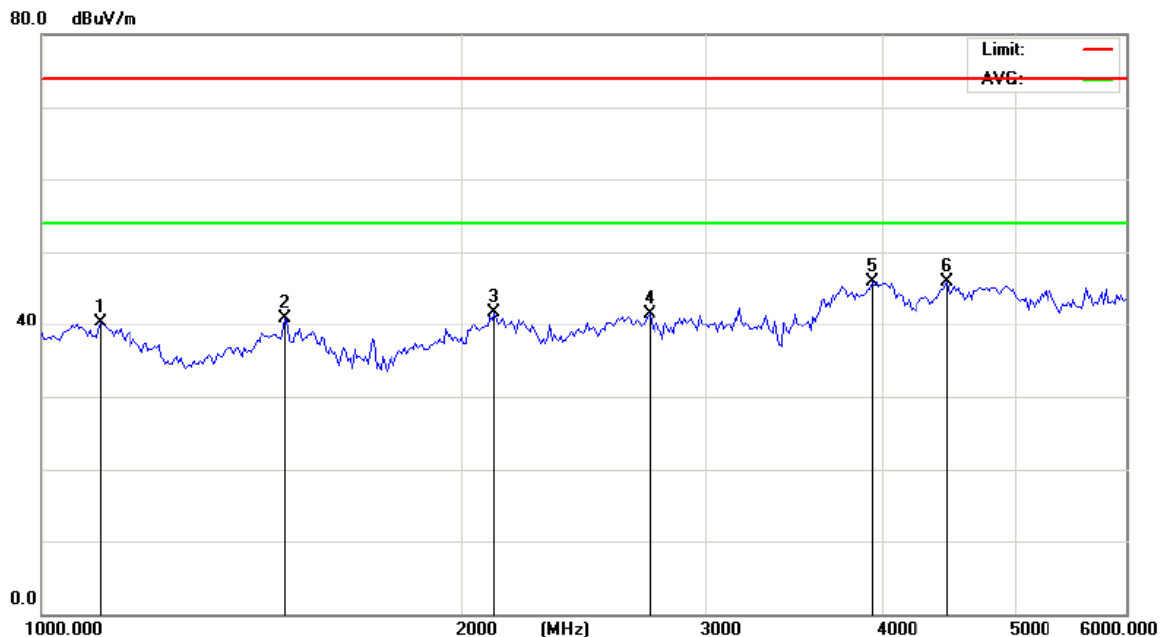

Site: Polarization: **Horizontal** Temperature: 23  
 Limit: FCC Part 15B Class B Above 1GHz RE(PK) Power: Humidity: 54 %  
 Mode: Charging and Data Transmitting  
 Note: DC 5V(PC Input AC 120V/60Hz)

No.	Mk.	Freq.	Reading Level	Correct Factor	Measurement	Limit	Over	Antenna Height	Table Degree	
		MHz	dBuV	dB	dBuV/m	dBuV/m	dB	cm	degree	Comment
1		1101.804	40.26	0.00	40.26	74.00	-33.74	peak	0	
2		1495.048	40.81	0.00	40.81	74.00	-33.19	peak	0	
3		2110.375	41.75	0.00	41.75	74.00	-32.25	peak	0	
4		2732.990	41.43	0.00	41.43	74.00	-32.57	peak	0	
5	*	3941.840	45.95	0.00	45.95	74.00	-28.05	peak	0	
6		4469.703	45.88	0.00	45.88	74.00	-28.12	peak	0	

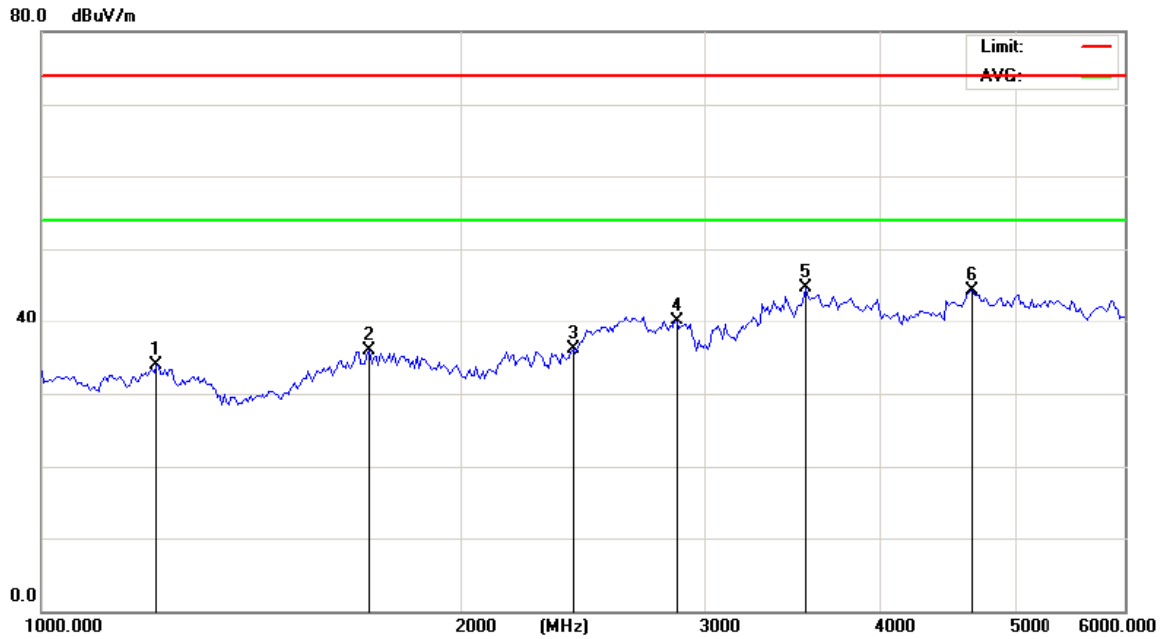

Site: Polarization: **Vertical** Temperature: 23  
 Limit: FCC Part 15B Class B Above 1GHz RE(PK) Power: Humidity: 54 %  
 Mode: Charging and Data Transmitting  
 Note: DC 5V(PC Input AC 120V/60Hz)

No. Mk.	Freq. MHz	Reading Level dBuV	Correct Factor dB	Measurement dBuV/m	Limit dBuV/m	Over dB	Detector	Antenna Height cm	Table Degree	Comment
1	1209.621	33.87	0.00	33.87	74.00	-40.13	peak		0	
2	1719.779	35.96	0.00	35.96	74.00	-38.04	peak		0	
3	2410.229	36.18	0.00	36.18	74.00	-37.82	peak		0	
4	2863.588	40.15	0.00	40.15	74.00	-33.85	peak		0	
5 *	3539.291	44.69	0.00	44.69	74.00	-29.31	peak		0	
6	4666.505	44.25	0.00	44.25	74.00	-29.75	peak		0	

\*\*\*\*\***END OF REPORT**\*\*\*\*\*

**Appendix B: Photographs of 15B Test Setup**  
Radiated Emission

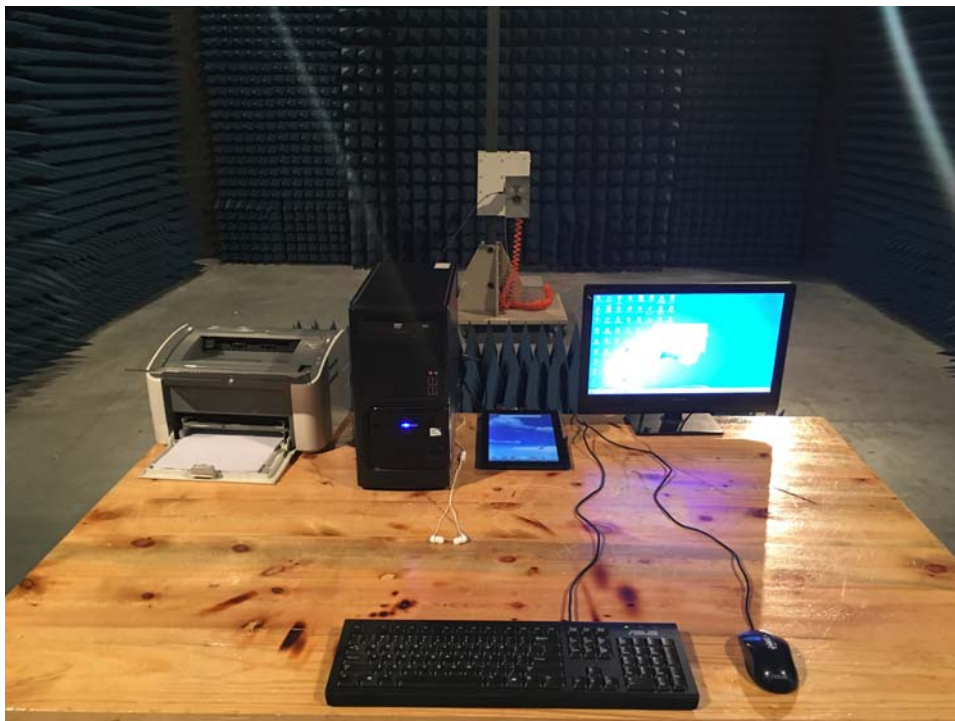
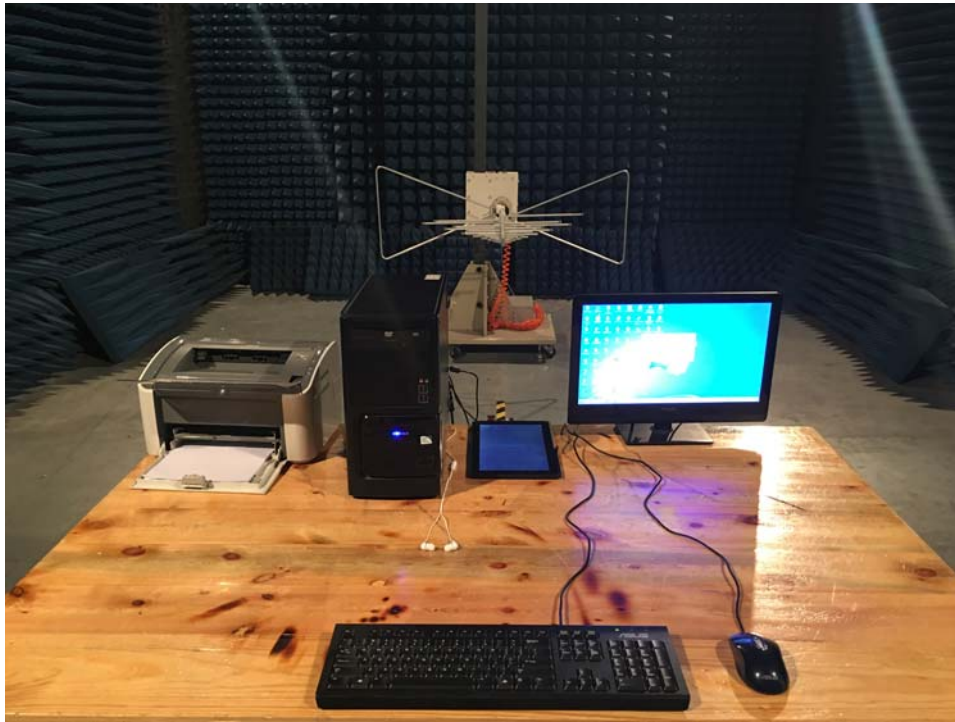



Conducted Emission



## Appendix C: Photographs of EUT

Refer to test report TCT160329E016