

FCC/IC - TEST REPORT

Report Number : **68.950.20.0527.01** Date of Issue: September 03, 2020

Model : PI5R

Product Type : In-ear True Wireless Headphone

Applicant : B&W Group Ltd.

Address : Dale Road Worthing United Kingdom BN11 2BH

Factory : Charter Media (Dongguan) Co., Ltd.

Address : Dabandi Industrial Zone, Daning District, Humen Town,
523930 Dongguan City, Guangdong Province,
PEOPLE'S REPUBLIC OF CHINA

Test Result : **Positive** **Negative**

Total pages including
Appendices : 47

TÜV SÜD Certification and Testing (China) Co., Ltd. Shenzhen Branch is a subcontractor to TÜV SÜD Product Service GmbH according to the principles outlined in ISO 17025.

TÜV SÜD Certification and Testing (China) Co., Ltd. Shenzhen Branch reports apply only to the specific samples tested under stated test conditions. Construction of the actual test samples has been documented. It is the manufacturer's responsibility to assure that additional production units of this model are manufactured with identical electrical and mechanical components. The manufacturer/importer is responsible to the Competent Authorities in Europe for any modifications made to the production units which result in non-compliance to the relevant regulations. TÜV SÜD Certification and Testing (China) Co., Ltd. Shenzhen Branch shall have no liability for any deductions, inferences or generalizations drawn by the client or others from TÜV SÜD Certification and Testing (China) Co., Ltd. Shenzhen Branch issued reports.

This report is the confidential property of the client. As a mutual protection to our clients, the public and ourselves, extracts from the test report shall not be reproduced except in full without our written approval.



1 Table of Contents

1	Table of Contents	2
2	Details about the Test Laboratory.....	3
3	Description of the Equipment Under Test.....	4
4	Summary of Test Standards.....	5
5	Summary of Test Results.....	6
6	General Remarks	7
7	Test Setups	8
8	Systems test configuration.....	9
9	Technical Requirement	10
9.1	Conducted peak output power.....	10
9.2	Power spectral density.....	14
9.3	6 dB Bandwidth and 99% Occupied Bandwidth	18
9.4	Spurious RF conducted emissions	25
9.5	Band edge	32
9.6	Spurious radiated emissions for transmitter	35
10	Test Equipment List.....	46
11	System Measurement Uncertainty	47



2 Details about the Test Laboratory

Details about the Test Laboratory

Test Site 1

Company name: TÜV SÜD Certification and Testing (China) Co., Ltd. Shenzhen Branch
Building 12 & 13, Zhiheng Wisdomland Business Park, Nantou Checkpoint
Road 2, Nanshan District
Shenzhen 518052
P.R. China

Telephone: 86 755 8828 6998

Fax: 86 755 8288 5299

FCC Registration No.: 514049

No.:

ISED#: 10320A

3 Description of the Equipment Under Test

Product:	In-ear True Wireless Headphone
Model no/HVIN.:	PI5R
FVIN:	V1.0.x
FCC ID:	2ACIX-PI5R
IC:	11946B-PI5R
Options and accessories:	Type-C Cable, Charging Case
Rating:	Earbud: 3.7VDC, 55mAh, 0.204Wh (Supplied by Built Li-ion battery)
RF Transmission Frequency:	2402MHz-2480MHz
No. of Operated Channel:	40
Modulation:	GFSK
Antenna Type:	Mono pole antenna
Antenna Gain:	1.0dBi
Description of the EUT:	The Equipment Under Test (EUT) is an In-ear True Wireless Headphone support Bluetooth function.



4 Summary of Test Standards

Test Standards	
FCC Part 15 Subpart C 10-1-2019 Edition	PART 15 - RADIO FREQUENCY DEVICES Subpart C - Intentional Radiators
RSS-Gen Issue 5, Amendment 1, March 2019	General Requirements for the Certification of Radio Apparatus
RSS-247 Issue 2 February 2017	Digital Transmission Systems (DTSS), Frequency Hopping Systems (FHSS) and License-Exempt Local Area Network (LE-LAN) Devices

All the test methods were according to KDB558074 D01 v05r02 DTS Measurement Guidance and ANSI C63.10 (2013).

5 Summary of Test Results

Technical Requirements							
FCC Part 15 Subpart C/ RSS-247 Issue 2/RSS-Gen Issue 5							
Test Condition			Pages	Test Site	Test Result		
					Pass	Fail	N/A
§15.207	Conducted emission AC power port	RSS-GEN 8.8	--	--	<input type="checkbox"/>	<input type="checkbox"/>	<input checked="" type="checkbox"/>
§15.247 (b) (1)	Conducted peak output power	RSS-247 Clause 5.4(b)	10	Site 1	<input checked="" type="checkbox"/>	<input type="checkbox"/>	<input type="checkbox"/>
§15.247(a)(1)	20dB bandwidth	RSS-247 Clause 5.2(b)	---	---	<input type="checkbox"/>	<input type="checkbox"/>	<input checked="" type="checkbox"/>
§15.247(a)(1)	Carrier frequency separation	RSS-247 Clause 5.2(a)	---	---	<input type="checkbox"/>	<input type="checkbox"/>	<input checked="" type="checkbox"/>
§15.247(a)(1)(iii)	Number of hopping frequencies	RSS-247 Clause 5.1(a) & RSS-Gen 6.7	---	---	<input type="checkbox"/>	<input type="checkbox"/>	<input checked="" type="checkbox"/>
§15.247(a)(1)(iii)	Dwell Time	RSS-247 Clause 5.1(b)	---	---	<input type="checkbox"/>	<input type="checkbox"/>	<input checked="" type="checkbox"/>
§15.247(a)(2)	6dB bandwidth and 99% Occupied Bandwidth	RSS-247 Clause 5.1(d)	14	Site 1	<input checked="" type="checkbox"/>	<input type="checkbox"/>	<input type="checkbox"/>
§15.247(e)	Power spectral density	RSS-247 Clause 5.1(d)	18	Site 1	<input checked="" type="checkbox"/>	<input type="checkbox"/>	<input type="checkbox"/>
§15.247(d)	Spurious RF conducted emissions	RSS-247 Clause 5.5	25	Site 1	<input checked="" type="checkbox"/>	<input type="checkbox"/>	<input type="checkbox"/>
§15.247(d)	Band edge	RSS-247 Clause 5.5	32	Site 1	<input checked="" type="checkbox"/>	<input type="checkbox"/>	<input type="checkbox"/>
§15.247(d) & §15.209 & §15.205	Spurious radiated emissions for transmitter	RSS-247 Clause 5.5 & RSS-GEN 6.13 RSS-GEN 8.9 RSS-GEN 8.10	35	Site 1	<input checked="" type="checkbox"/>	<input type="checkbox"/>	<input type="checkbox"/>
§15.203	Antenna requirement	RSS-GEN 6.8	See note 2		<input checked="" type="checkbox"/>	<input type="checkbox"/>	<input type="checkbox"/>

Note 1: N/A=Not Applicable.

Note 2: The EUT uses a Mono pole antenna, which gain is 1.0dBi. In accordance to §15.203 and RSS-GEN 6.8, it is considered sufficiently to comply with the provisions of this section.

6 General Remarks

Remarks

This submittal(s) (test report) is intended for FCC ID: 2ACIX-PI5R, IC: 11946B-PI5R complies with Section 15.205, 15.209, 15.247 of the FCC Part 15, Subpart C and RSS-247 issue 2 and RSS-Gen issue 5 rules.

PI5 is a Bluetooth Headset with Bluetooth 5.0, BLE supports 1MHz bandwidth and 2MHz bandwidth. The TX and RX range is 2402MHz-2480MHz.

Note: The report is for BLE only

SUMMARY:

All tests according to the regulations cited on page 5 were

- Performed

- **Not** Performed

The Equipment under Test

- **Fulfills** the general approval requirements.

- **Does not** fulfill the general approval requirements.

Sample Received Date: August 3, 2020

Testing Start Date: August 3, 2020

Testing End Date: August 31, 2020

- TÜV SÜD Certification and Testing (China) Co., Ltd. Shenzhen Branch -

Reviewed by:

Prepared by:

Tested by:



John Zhi
EMC Project Manager



Mark Chen
EMC Project Engineer



Tree Zhan
EMC Test Engineer

7 Test Setups

Below 1GHz

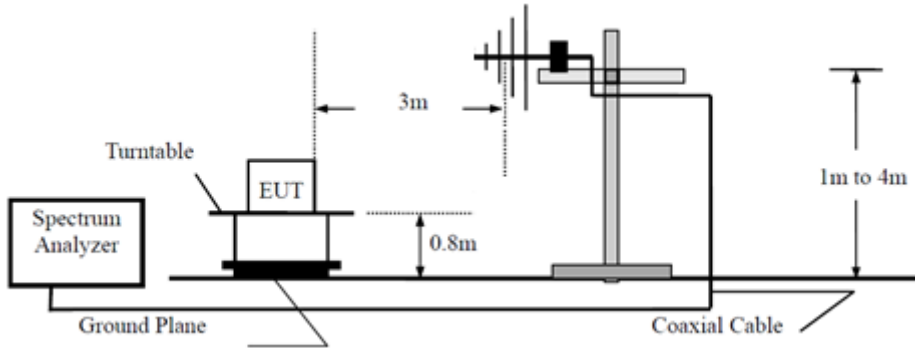

Above 1GHz

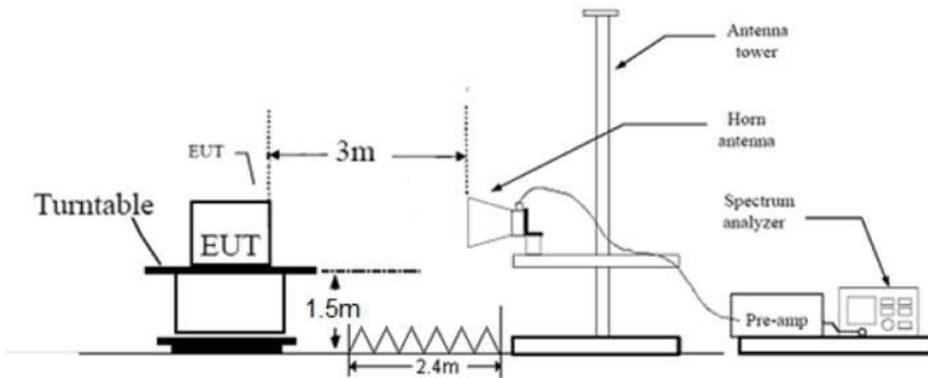

Conducted RF test setups

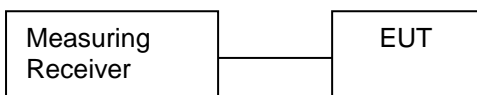

8 Systems test configuration

Auxiliary Equipment Used during Test:

DESCRIPTION	MANUFACTURER	MODEL NO.(SHIELD)	S/N(LENGTH)
Notebook	Lenovo	X220	---
--	---	---	

Test software: Bluetooth 3 Test Tool, which used to control the EUT in continues transmitting mode.

The system was configured to channel 0, 19, and 39 for the test.

9 Technical Requirement

9.1 Conducted peak output power

Test Method

1. Use the following spectrum analyzer settings:
RBW > the 6dB bandwidth of the emission being measured, VBW \geq 3RBW, Span \geq 3RBW
Sweep = auto, Detector function = peak, Trace = max hold.
2. Add a correction factor to the display.
3. Allow the trace to stabilize. Use the marker-to-peak function to set the marker to the peak of the emission. The indicated level is the peak output power.

Limits

Conducted peak output power:

Frequency Range MHz	Limit W	Limit dBm
2400-2483.5	≤ 1	≤ 30

For e.i.r.p

Frequency Range MHz	Limit W	Limit dBm
2400-2483.5	≤ 4	≤ 36

Test result as below table 1MHz Bandwidth

Frequency MHz	Conducted Peak Output Power dBm	E.I.R.P dBm	Result
Low channel 2402MHz	3.6	4.6	Pass
Middle channel 2440MHz	3.47	4.47	Pass
High channel 2480MHz	3.53	4.53	Pass

Test result as below table 2MHz Bandwidth

Frequency MHz	Conducted Peak Output Power dBm	E.I.R.P dBm	Result
Low channel 2402MHz	3.54	4.54	Pass
Middle channel 2440MHz	3.52	4.52	Pass
High channel 2480MHz	3.63	4.63	Pass

1MHz bandwidth Low channel 2402MHz

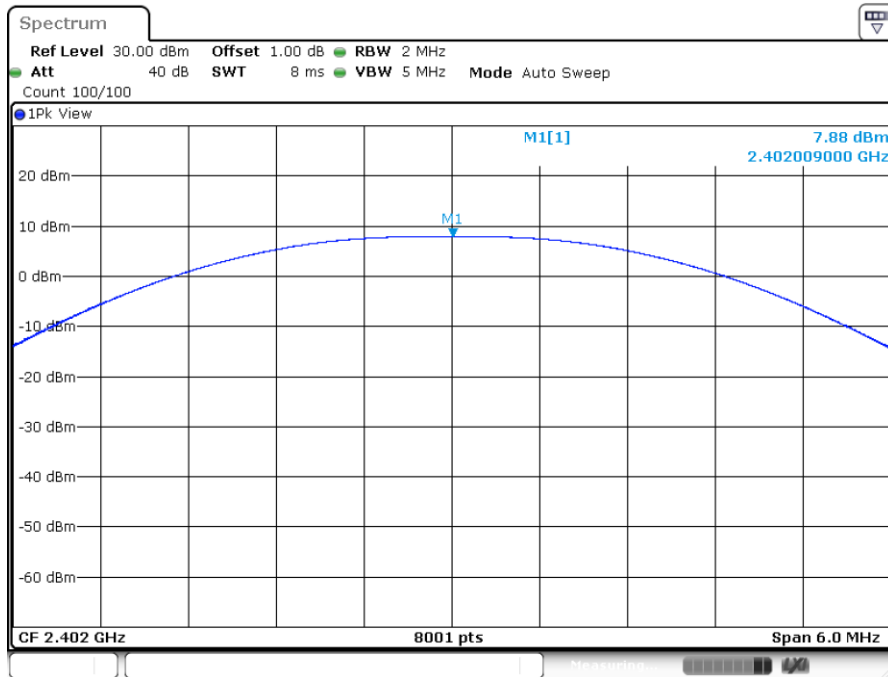

Date: 19.AUG.2020 13:14:08

Middle channel 2440MHz

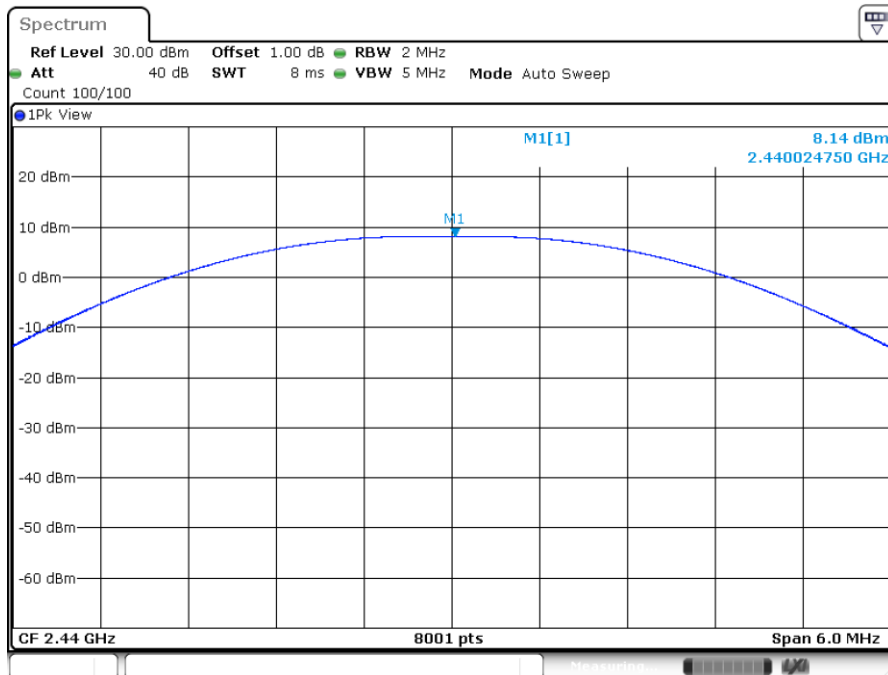

Date: 19.AUG.2020 13:14:28

High channel 2480MHz

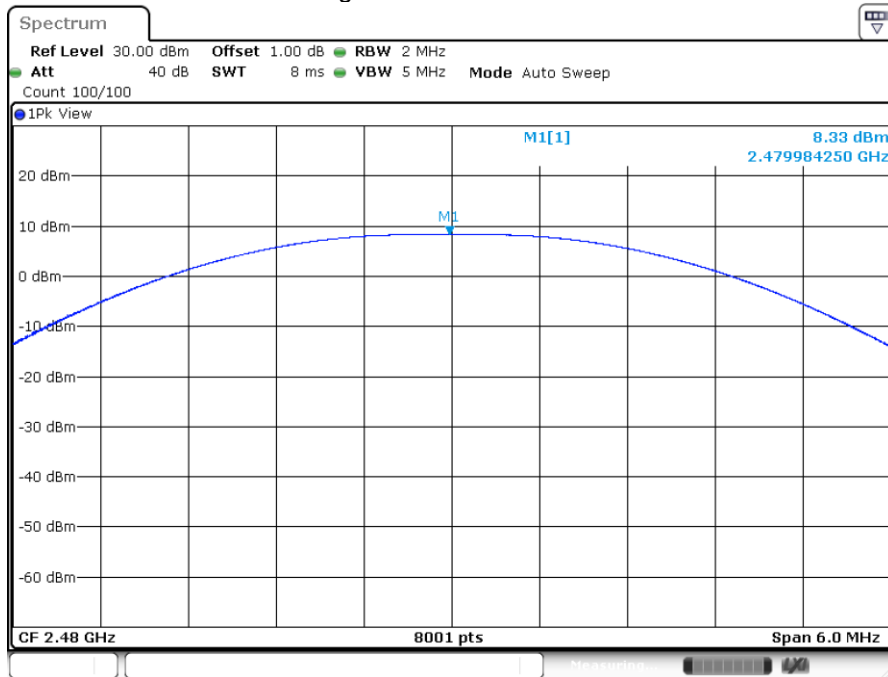

Date: 19.AUG.2020 13:14:43

2MHz bandwidth Low channel 2402MHz

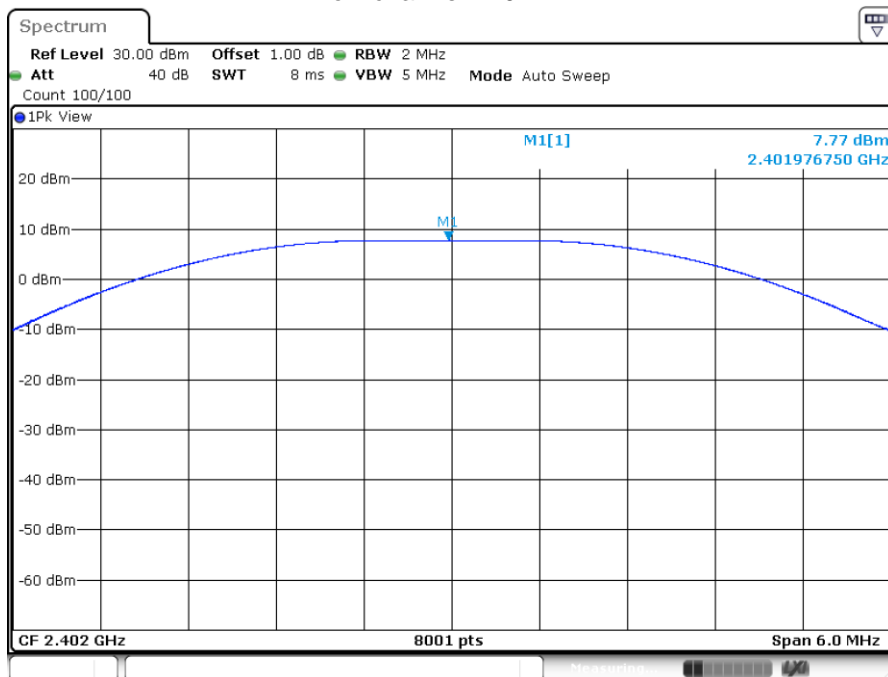

Date: 19.AUG.2020 11:07:56

Middle channel 2440MHz

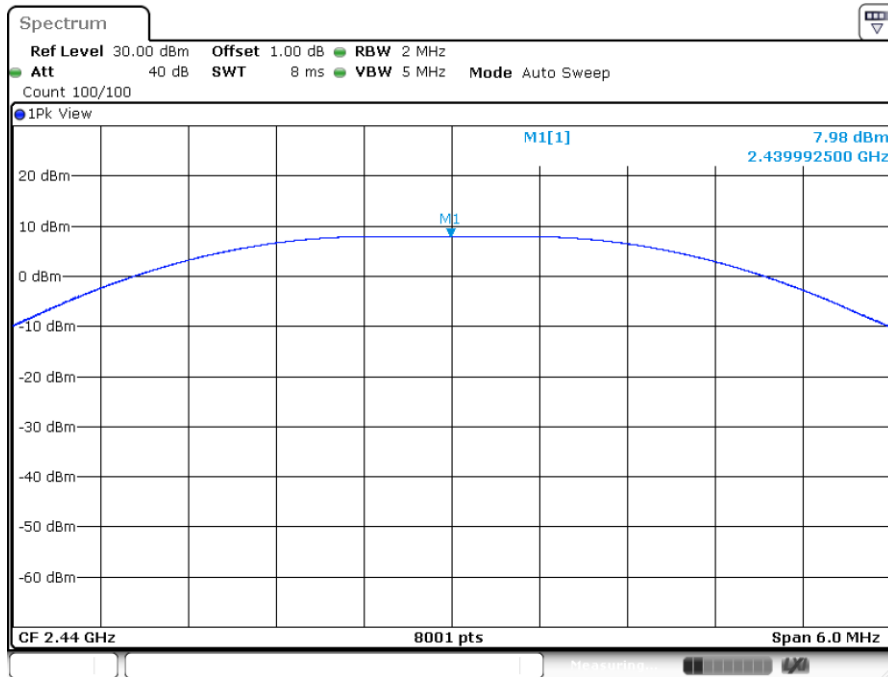

Date: 19.AUG.2020 11:09:50

High channel 2480MHz

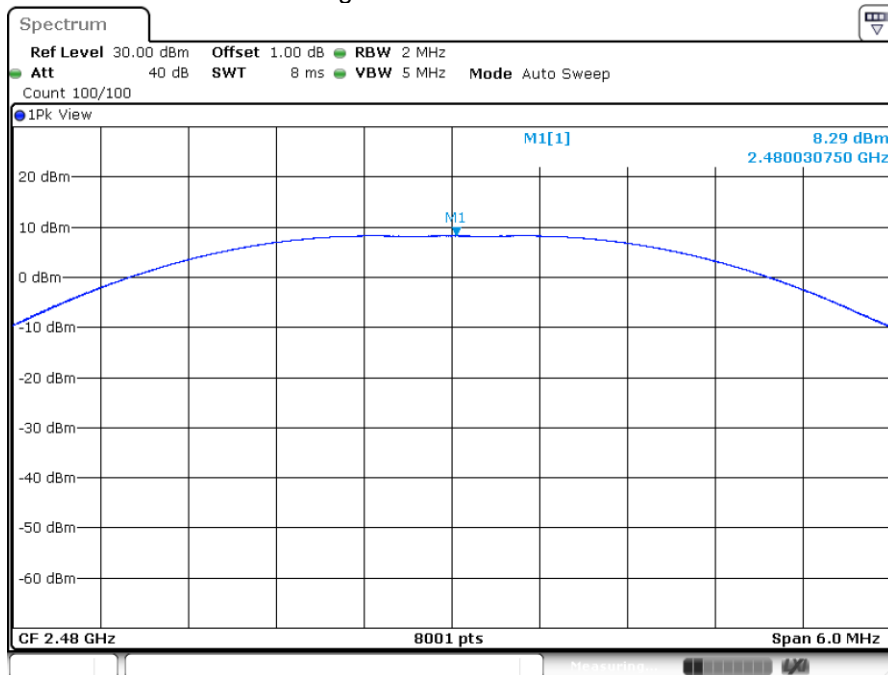

Date: 19.AUG.2020 11:11:15



9.2 Power spectral density

Test Method

This procedure shall be used if maximum peak conducted output power was used to demonstrate compliance:

1. Set analyzer center frequency to DTS channel center frequency. RBW=3kHz, VBW≥3RBW, Span=1.5 times DTS bandwidth, Detector=Peak, Sweep=auto, Trace= max hold.
2. Allow trace to fully stabilize, use the peak marker function to determine the maximum amplitude level within the RBW.
3. Repeat above procedures until other frequencies measured were completed.

Limit

Limit [dBm/3KHz]

≤8dBm/3KHz

1MHz Bandwidth

Test result

Frequency MHz	Power spectral density dBm/3KHz	Result
Top channel 2402MHz	-1.42	Pass
Middle channel 2440MHz	-1.26	Pass
Bottom channel 2480MHz	-0.93	Pass

2MHz Bandwidth

Test result

Frequency MHz	Power spectral density dBm/3KHz	Result
Top channel 2402MHz	-2.55	Pass
Middle channel 2440MHz	-2.37	Pass
Bottom channel 2480MHz	-2.2	Pass

1MHz Bandwidth Low channel 2402MHz

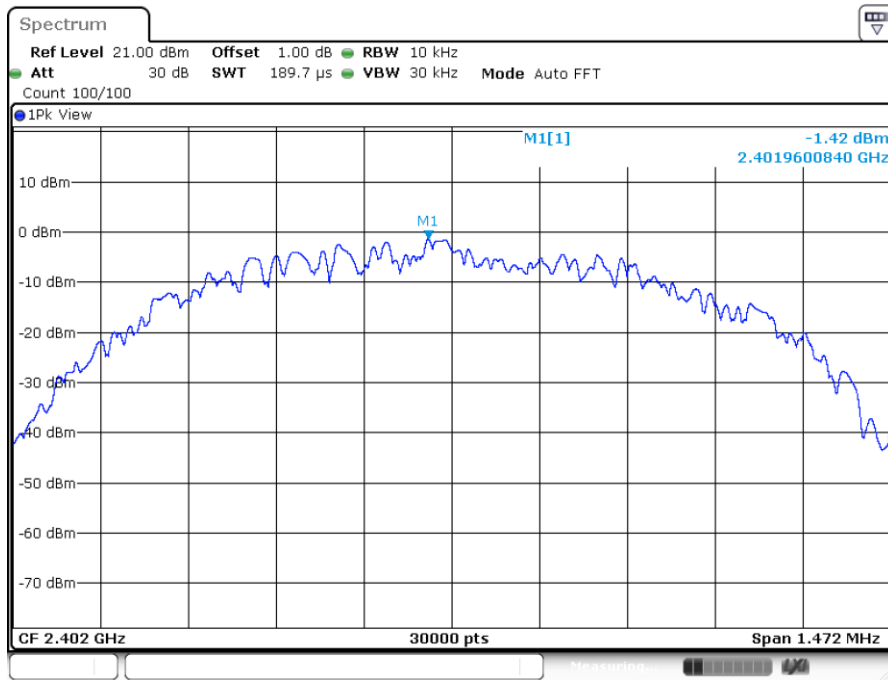

Date: 20.AUG.2020 16:05:10

Middle channel 2440MHz

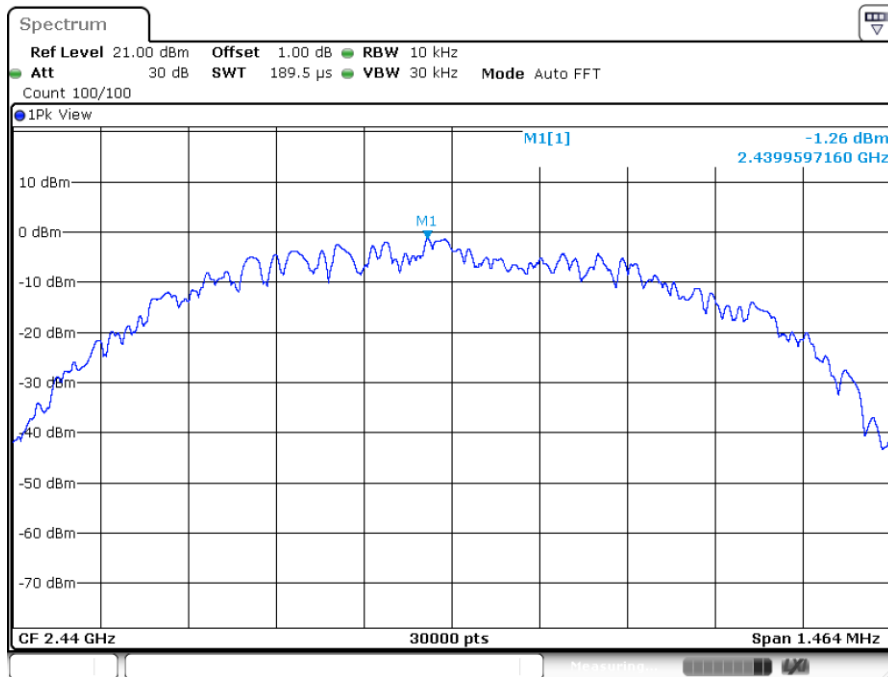

Date: 20.AUG.2020 16:05:45

High channel 2480MHz

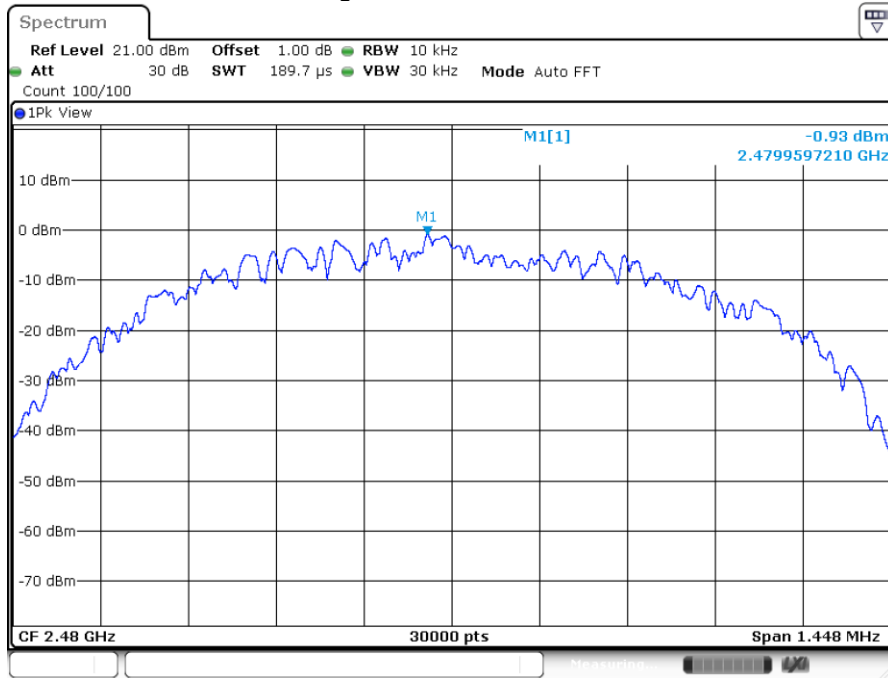

Date: 20.AUG.2020 16:06:09

2MHz Bandwidth Low channel 2402MHz

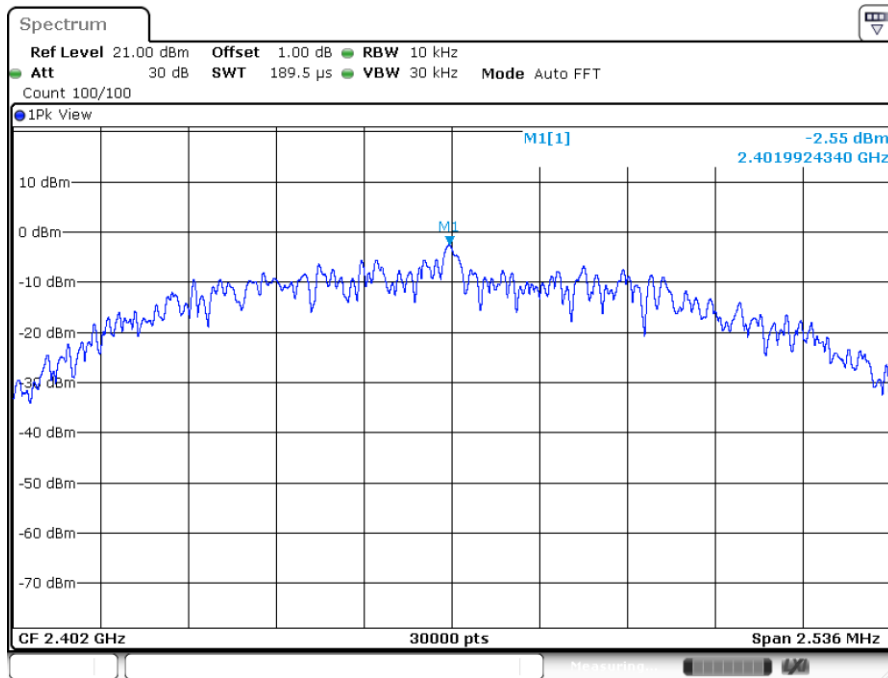

Date: 20.AUG.2020 16:06:55

Middle channel 2440MHz

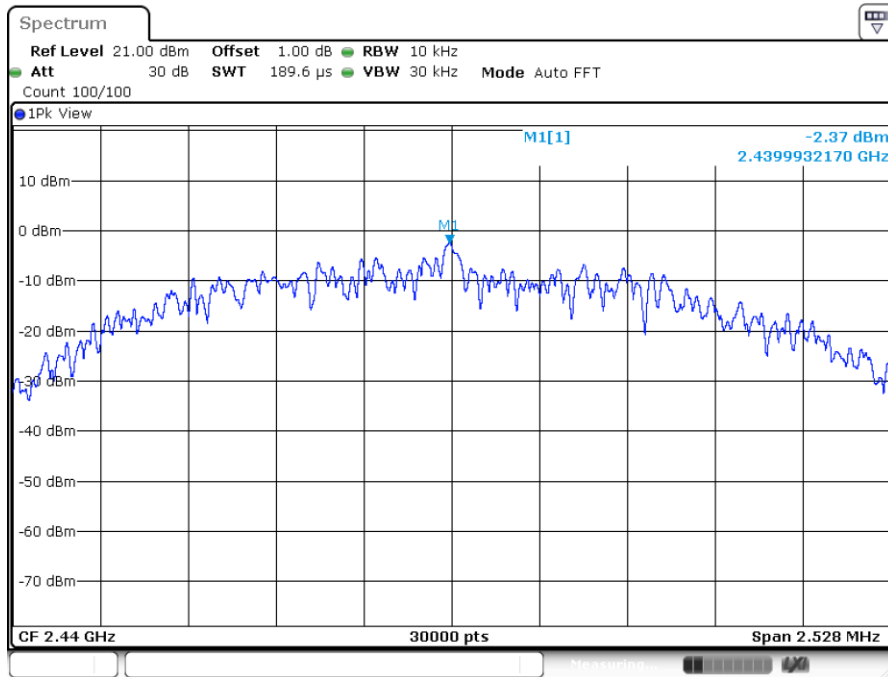

Date: 20.AUG.2020 16:07:23

High channel 2480MHz

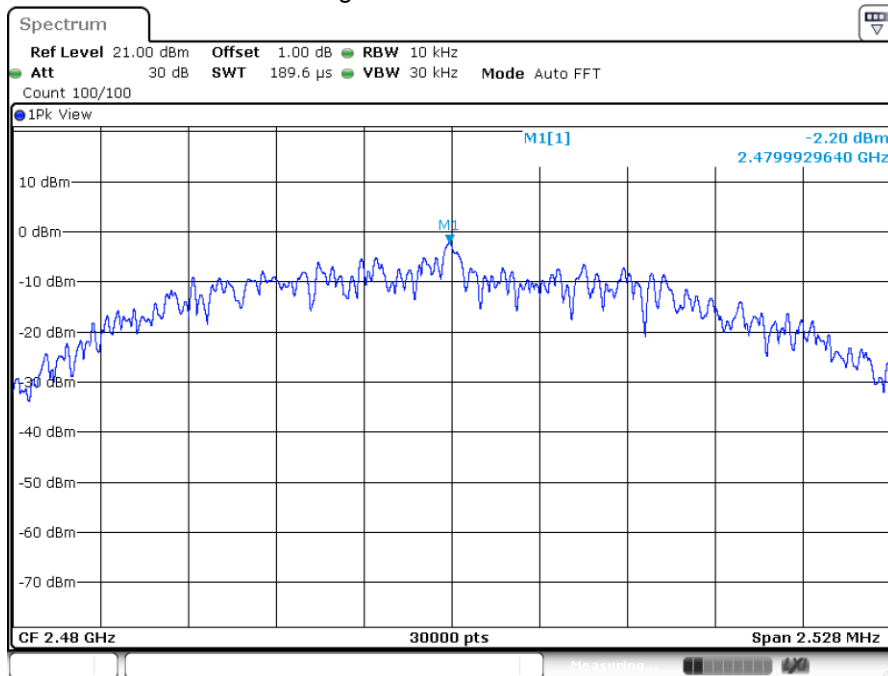

Date: 20.AUG.2020 16:07:40

9.3 6 dB Bandwidth and 99% Occupied Bandwidth

Test Method

1. Use the following spectrum analyzer settings:
RBW=100K, VBW \geq 3RBW, Sweep = auto, Detector function = peak, Trace = max hold
2. Use the automatic bandwidth measurement capability of an instrument, may be employed using the X dB bandwidth mode with X set to 6 dB, care shall be taken so that the bandwidth measurement is not influenced by any intermediate power nulls in the fundamental emission that might be \geq 6 dB.
3. Allow the trace to stabilize, record the X dB Bandwidth value.

Limit

Limit [kHz]

≥500

1MHz Bandwidth

Test result

Frequency MHz	6dB bandwidth kHz	99% bandwidth kHz	Result
Bottom channel 2402MHz	736	1039	Pass
Middle channel 2440MHz	732	1039	Pass
Top channel 2480MHz	724	1039	Pass

2MHz Bandwidth

Test result

Frequency MHz	6dB bandwidth kHz	99% bandwidth kHz	Result
Bottom channel 2402MHz	1268	2058	Pass
Middle channel 2440MHz	1264	2058	Pass
Top channel 2480MHz	1264	2058	Pass

1MHz Bandwidth

BLE_Ant1_2402_0~Reference



Date: 18 AUG 2020 11:35:26

BLE_Ant1_2402_30~1000

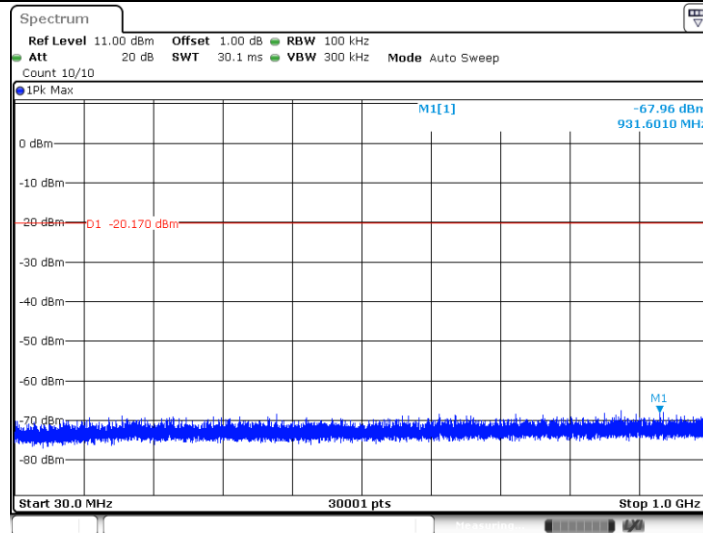

Date: 18 AUG 2020 11:35:32

BLE_Ant1_2402_1000~26500

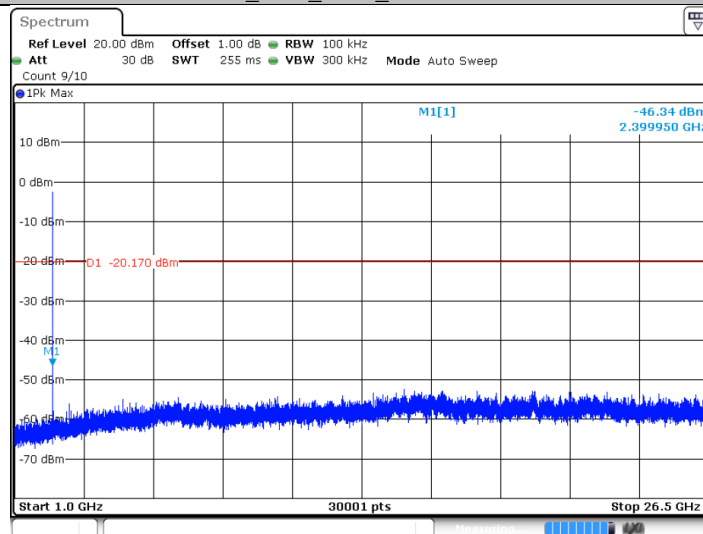

Date: 18 AUG 2020 11:35:40

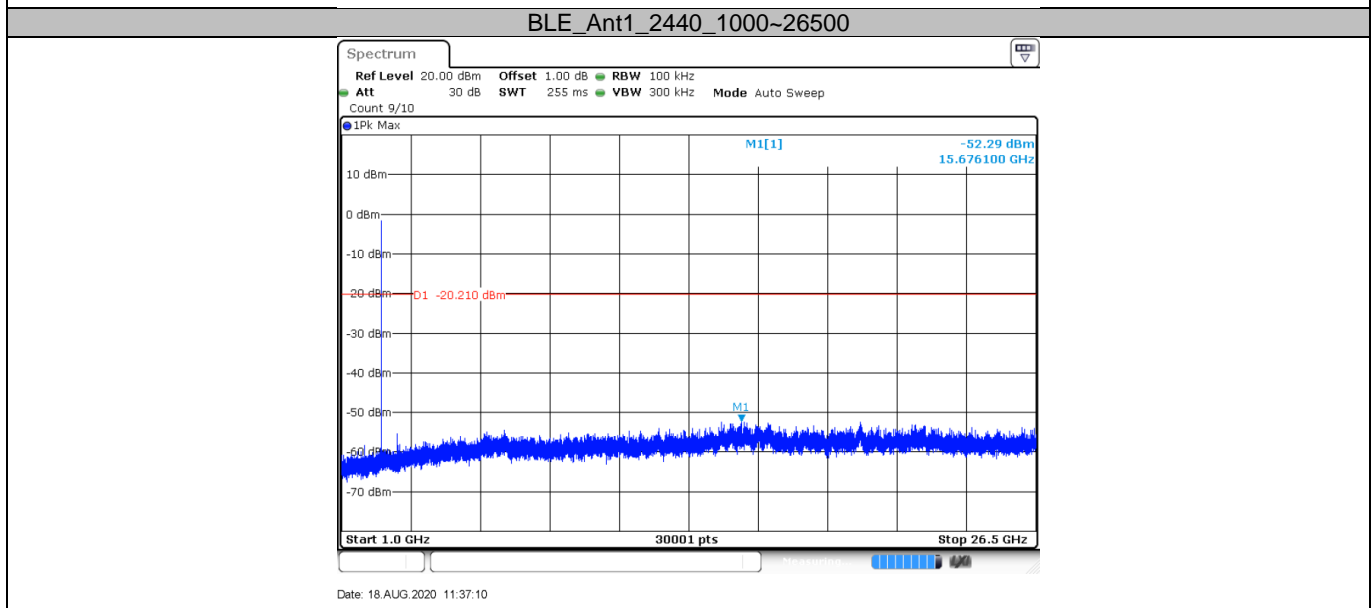
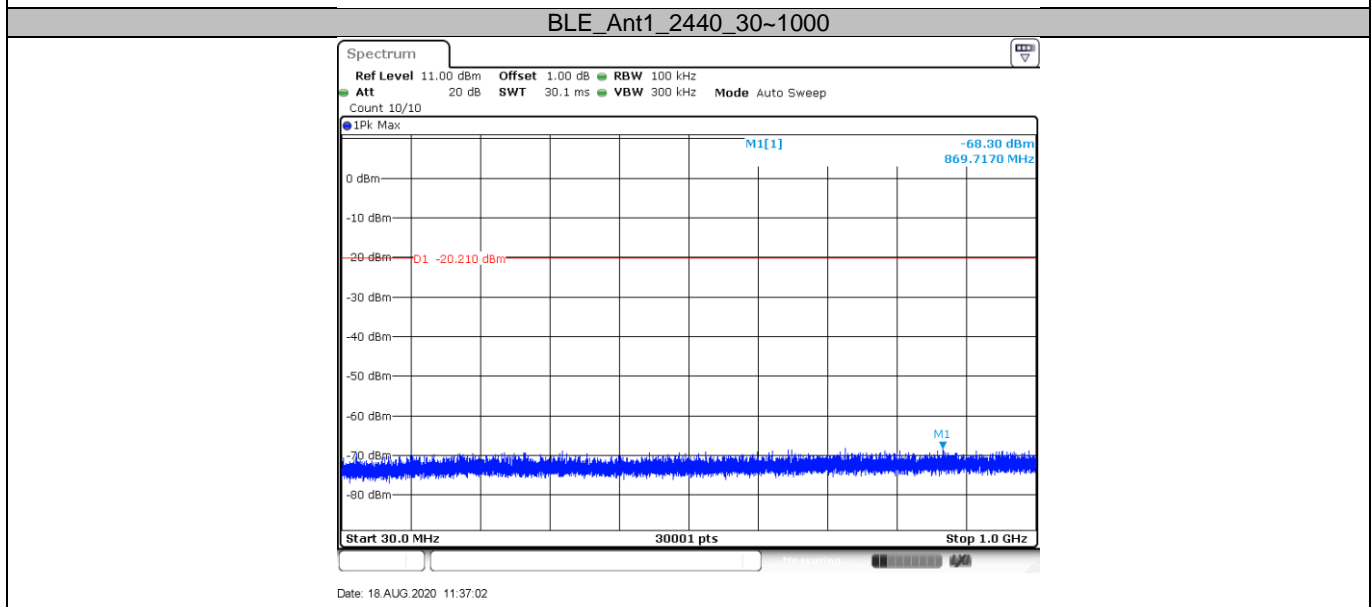
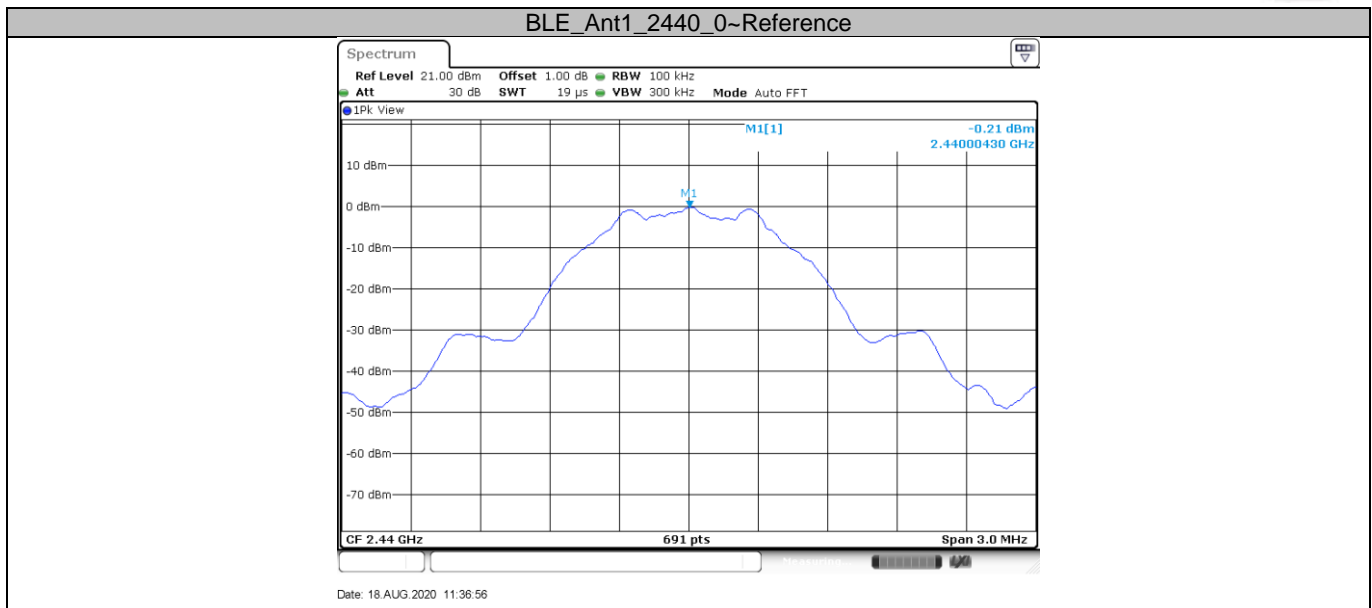

BLE_Ant1_2480_0~Reference



Date: 18 AUG 2020 11:38:48

BLE Ant1_2480_30~1000

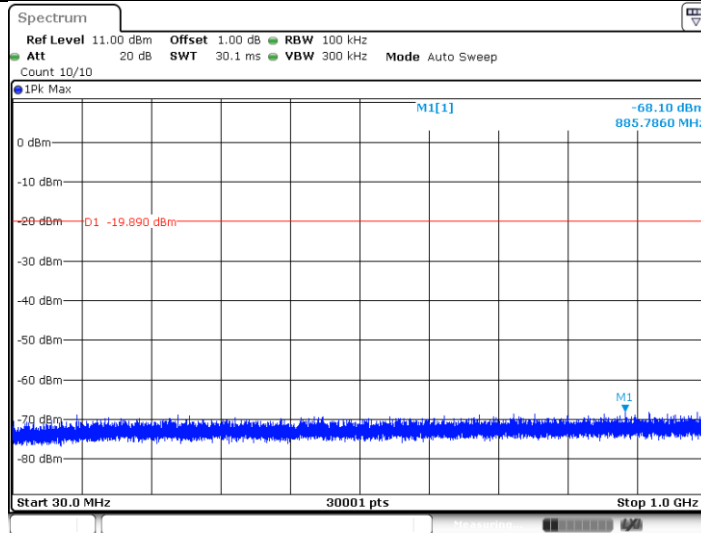

Date: 18 AUG 2020 11:38:54

BLE Ant1_2480_1000~26500

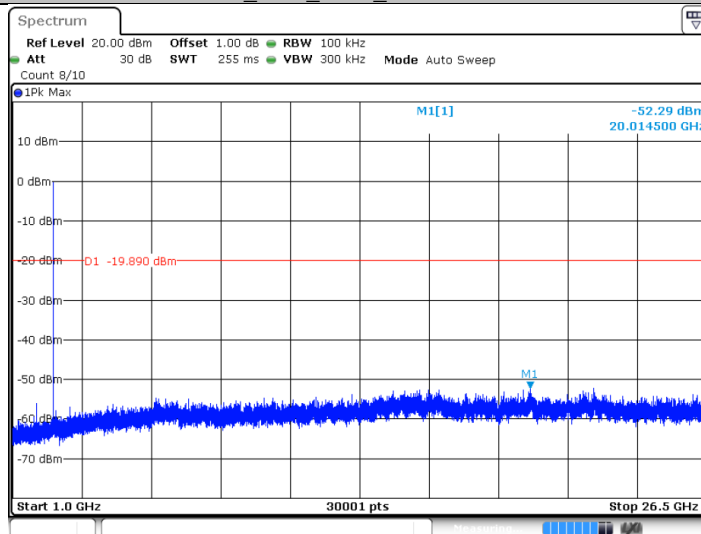

Date: 18 AUG 2020 11:39:02

2MHz Bandwidth

BLE_Ant1_2402_0~Reference

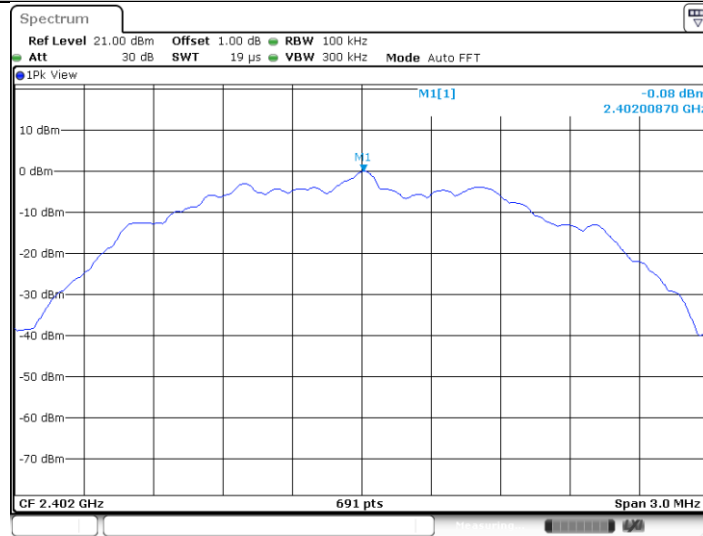

Date: 18 AUG 2020 11:52:04

BLE_Ant1_2402_30~1000

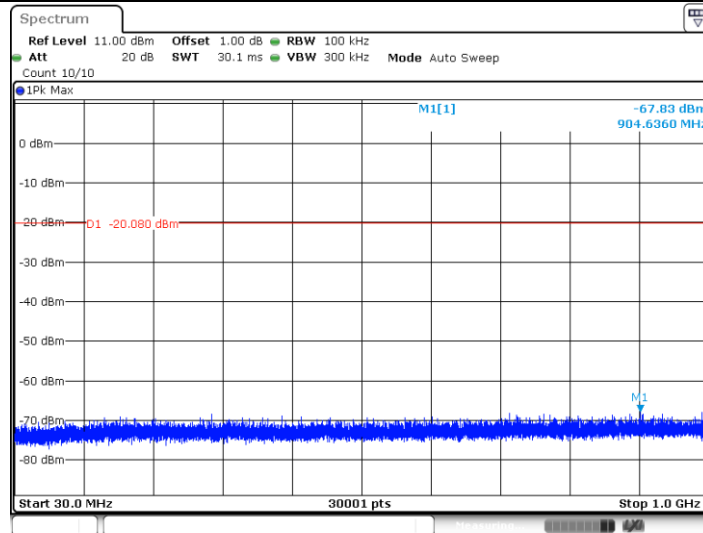

Date: 18 AUG 2020 11:52:10

BLE_Ant1_2402_1000~26500

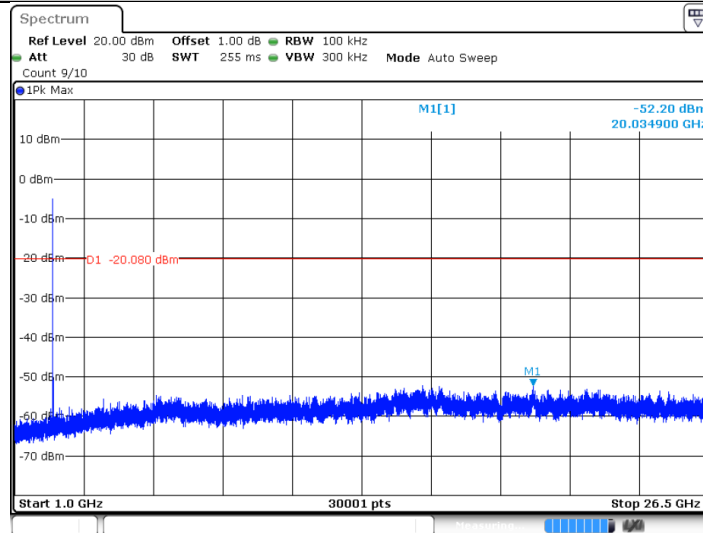

Date: 18 AUG 2020 11:52:18

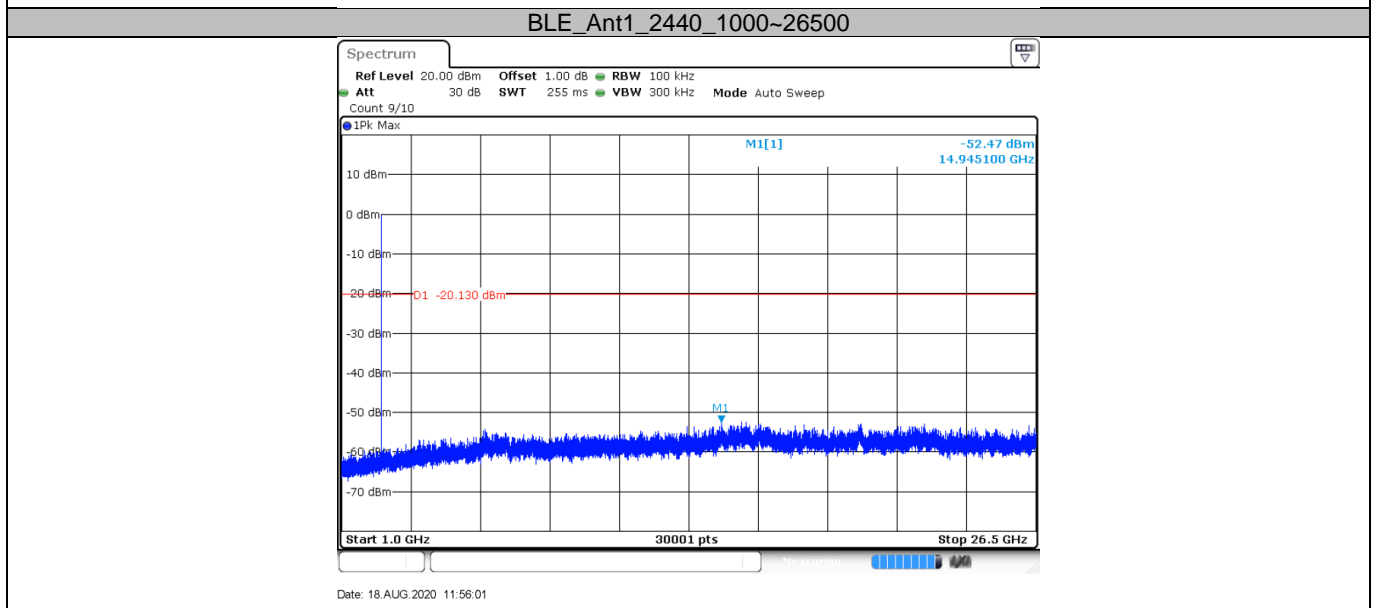
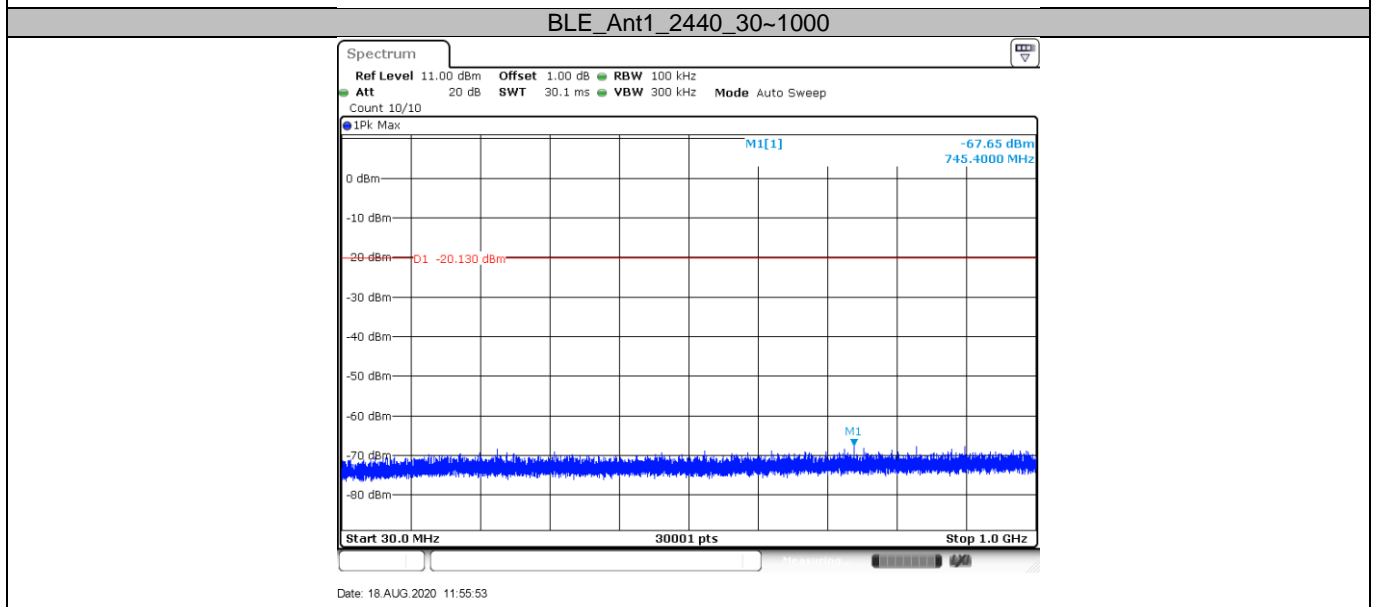
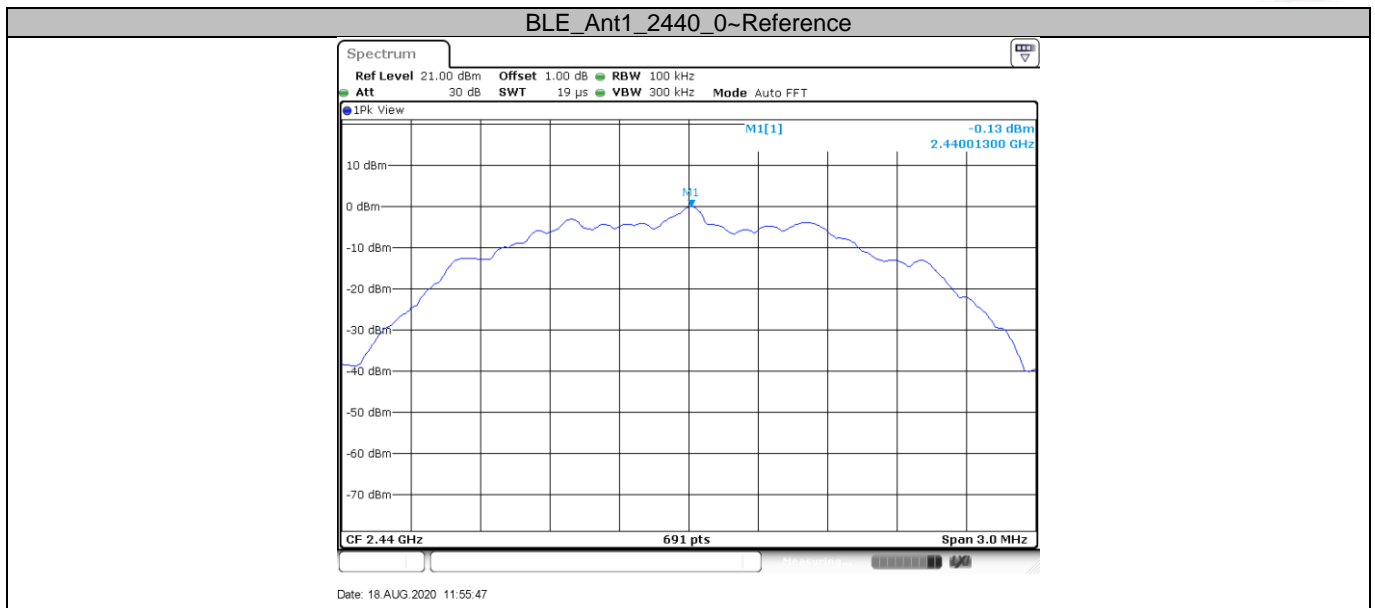

BLE_Ant1_2480_0~Reference

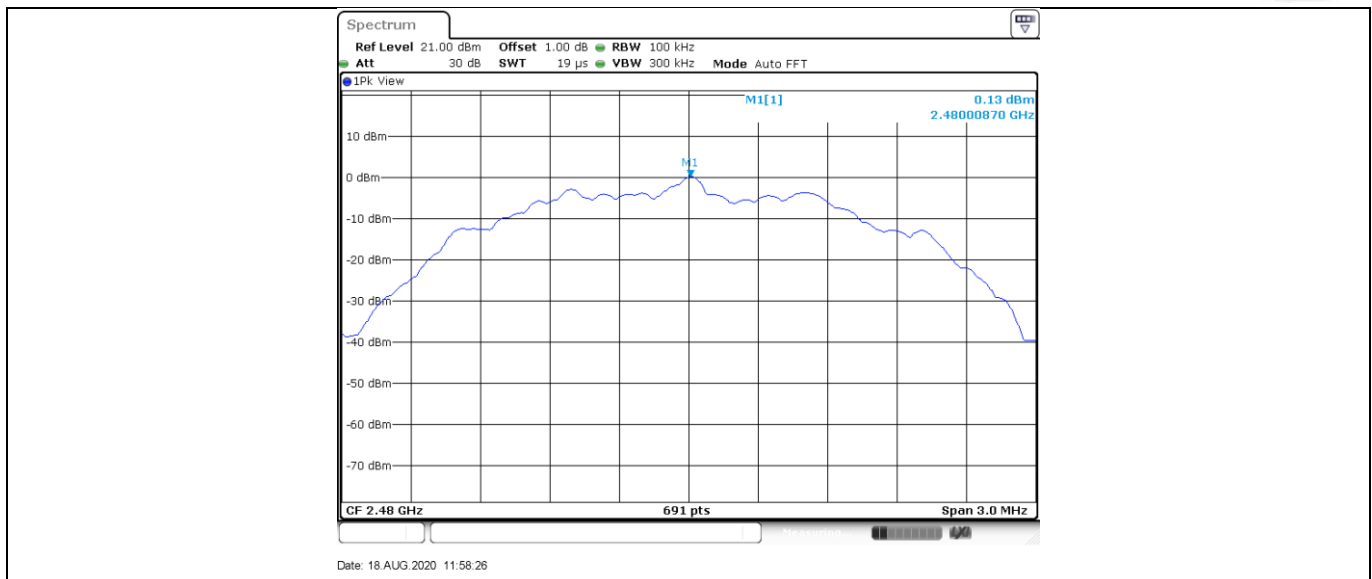

BLE_Ant1_2480_30~1000

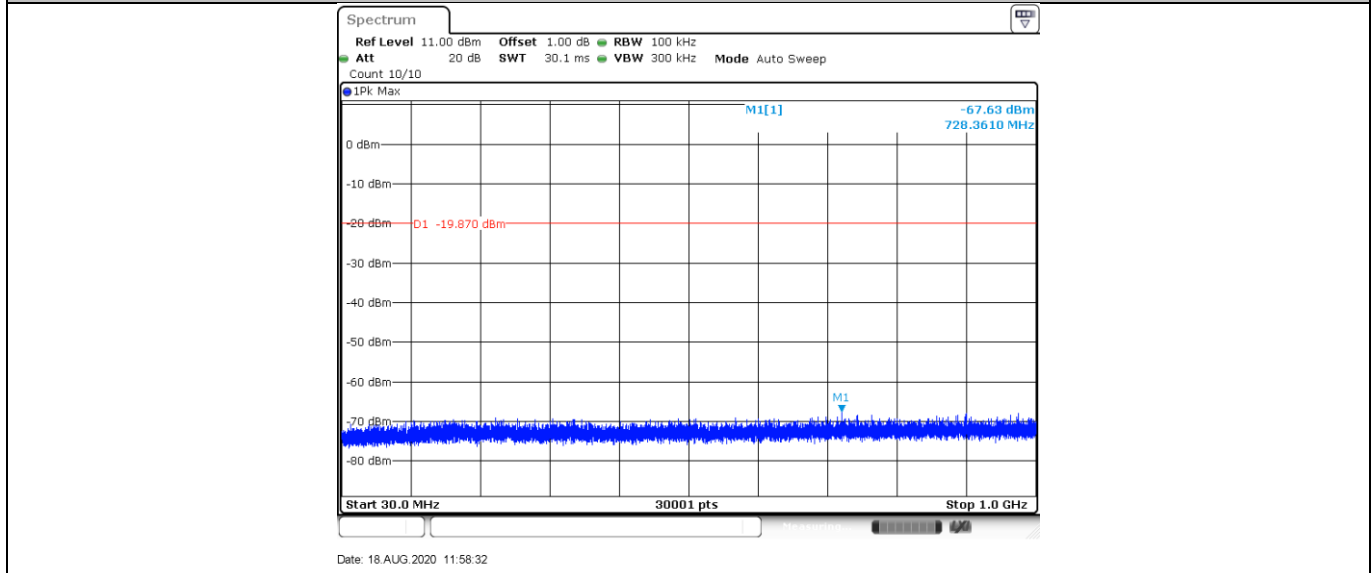

BLE_Ant1_2480_1000~26500

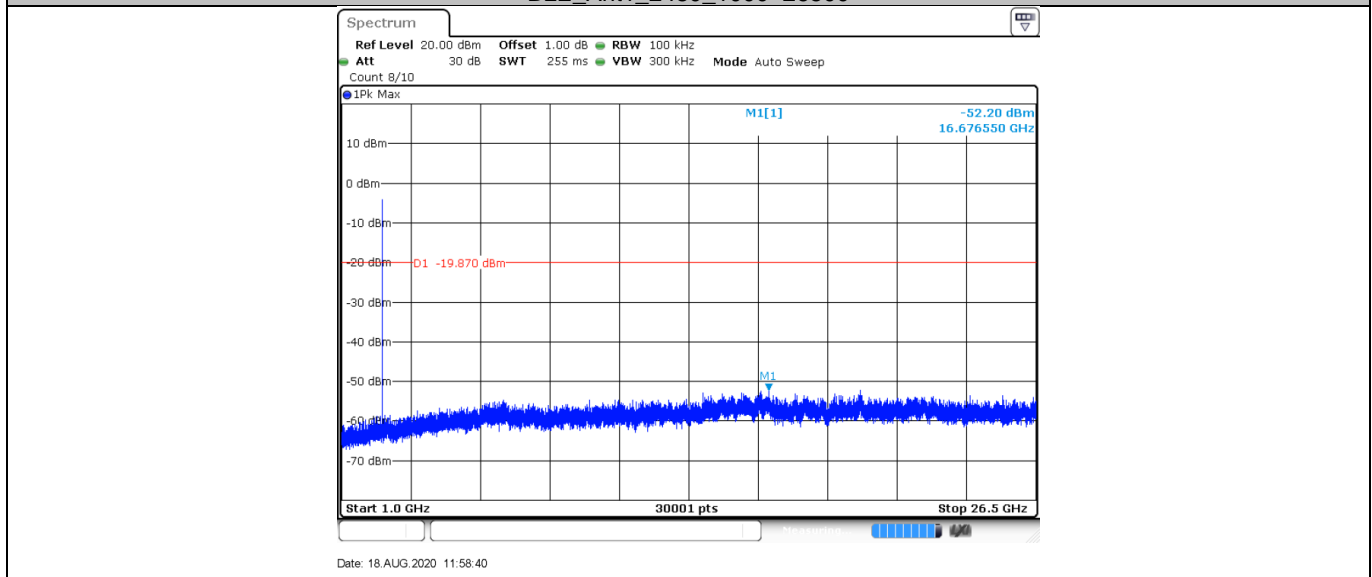

9.4 Spurious RF conducted emissions

Test Method

1. Establish a reference level by using the following procedure:
 - a. Set RBW=100 kHz. VBW \geq 3RBW. Detector =peak, Sweep time = auto couple, Trace mode = max hold.
 - b. Allow trace to fully stabilize, use the peak marker function to determine the maximum PSD level.
2. Use the maximum PSD level to establish the reference level.
 - a. Set the center frequency and span to encompass frequency range to be measured.
 - b. Use the peak marker function to determine the maximum amplitude level. Ensure that the amplitude of all unwanted emissions outside of the authorized frequency band (excluding restricted frequency bands) are attenuated by at least the minimum requirements, report the three highest emissions relative to the limit.
3. Repeat above procedures until other frequencies measured were completed.

Limit

Frequency Range MHz	Limit (dBc)
30-25000	-20

Spurious RF conducted emissions

1MHz Bandwidth
2402MHz

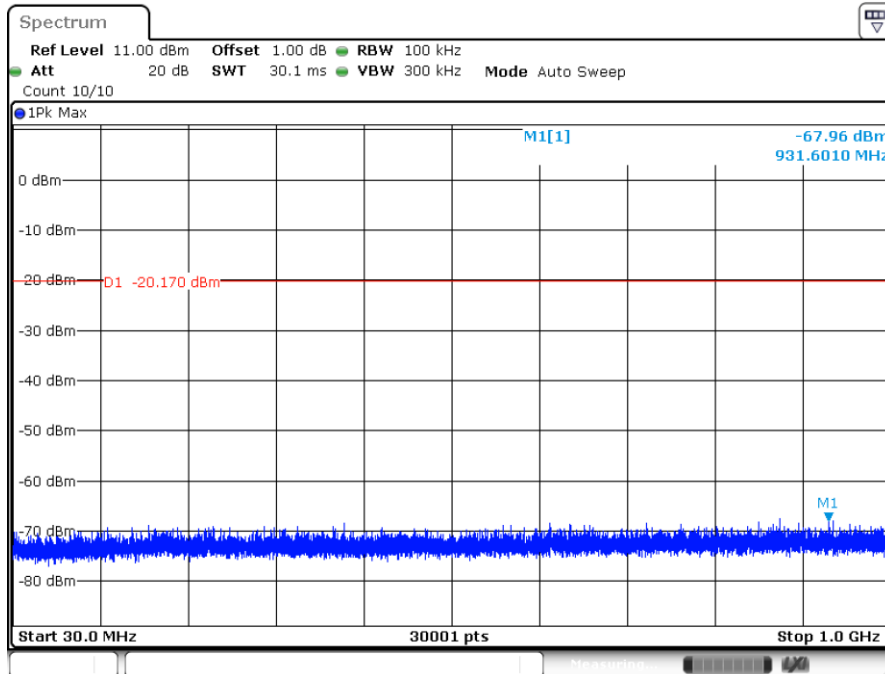

Date: 18.AUG.2020 11:35:32

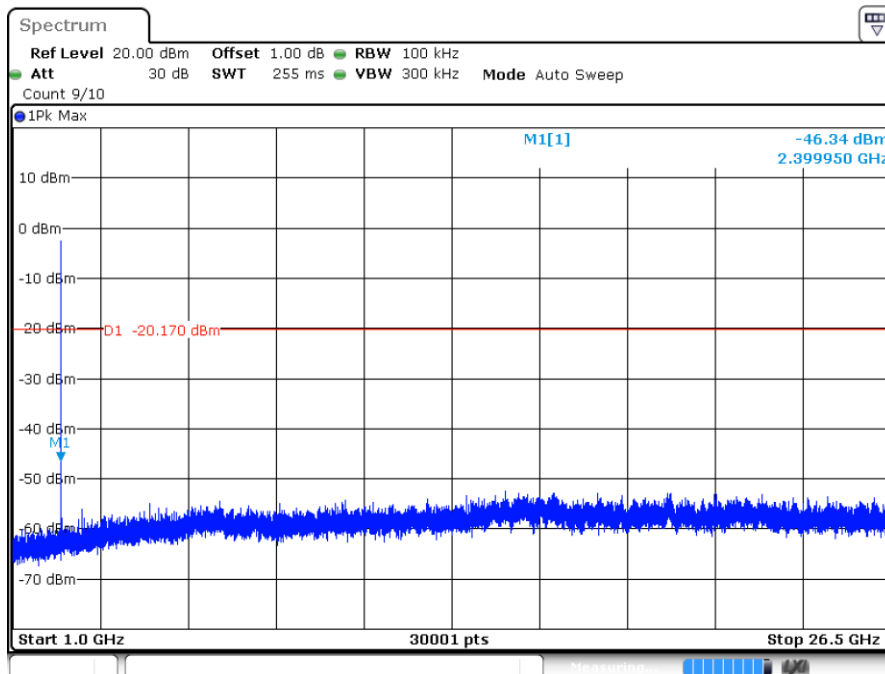

Date: 18.AUG.2020 11:35:40

2440MHz

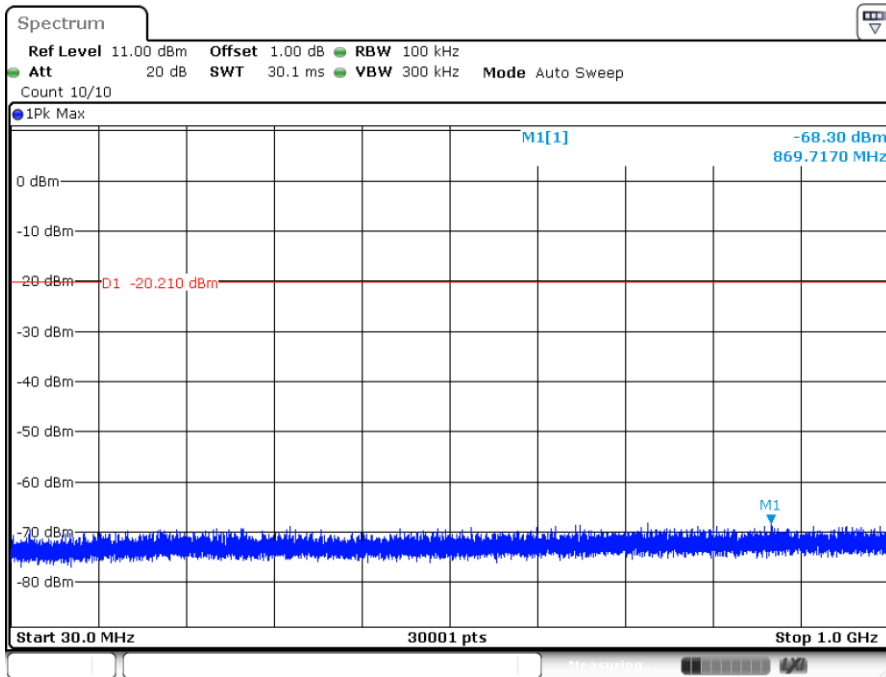

Date: 18.AUG.2020 11:37:02

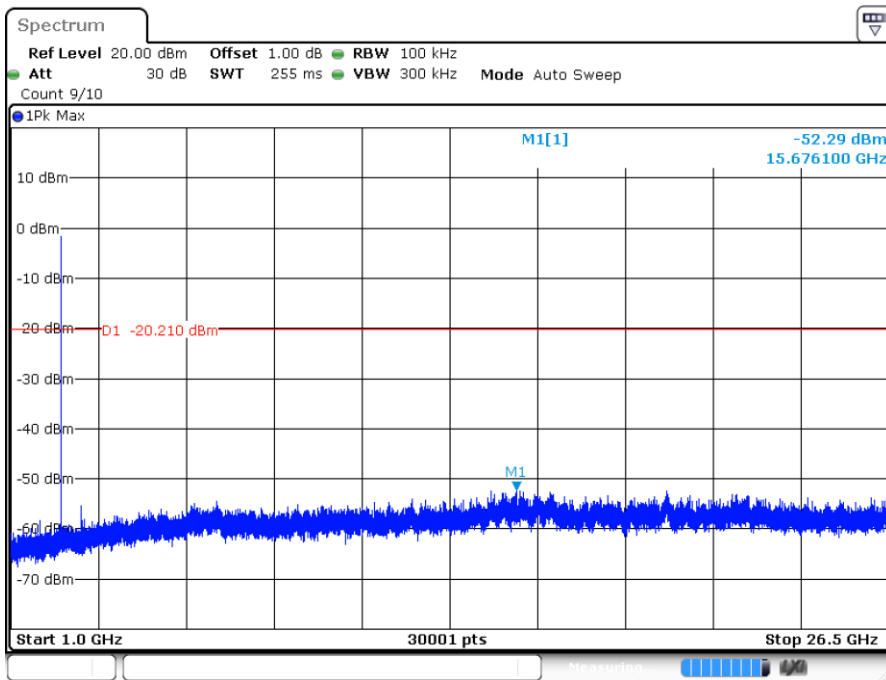

Date: 18.AUG.2020 11:37:10



2480MHz

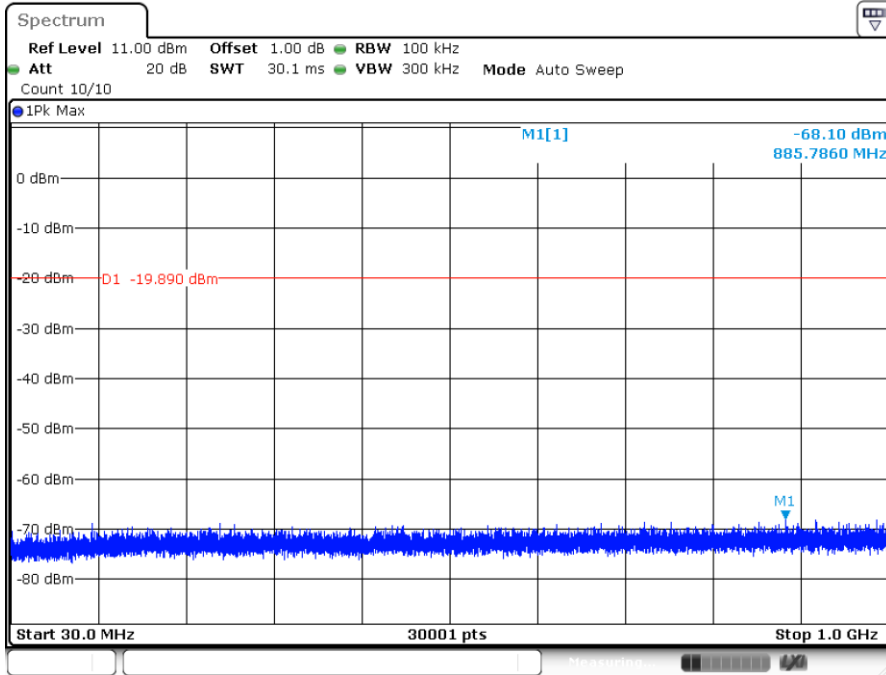

Date: 18.AUG.2020 11:38:54

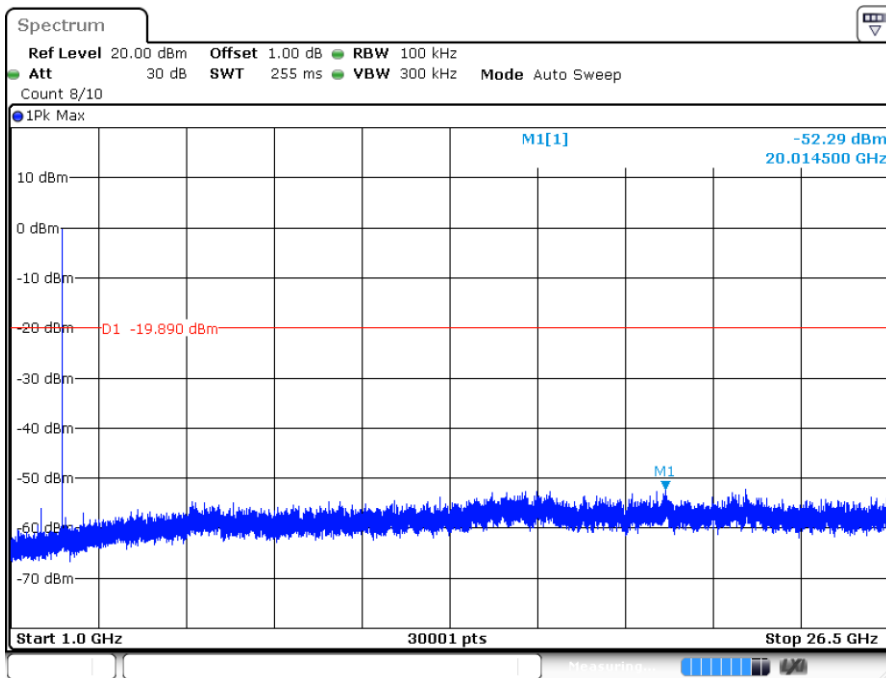

Date: 18.AUG.2020 11:39:02

2MHz Bandwidth 2402MHz

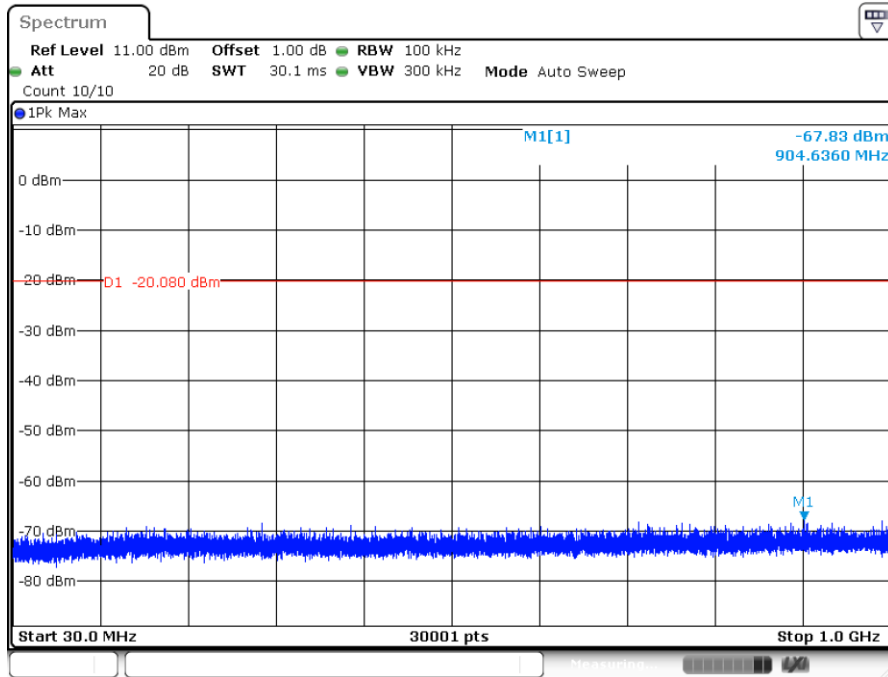

Date: 18.AUG.2020 11:52:10

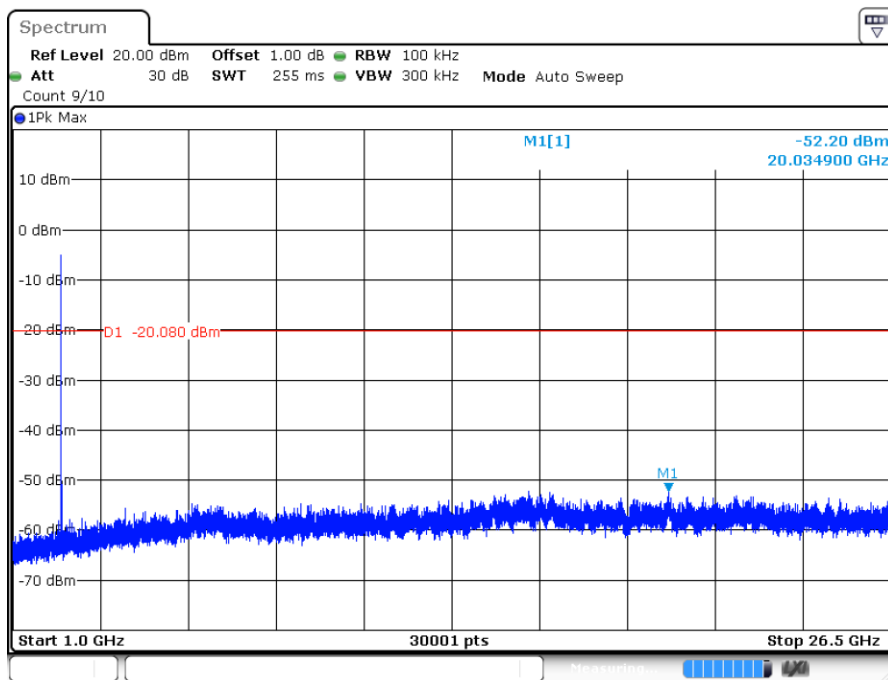

Date: 18.AUG.2020 11:52:18

2440MHz

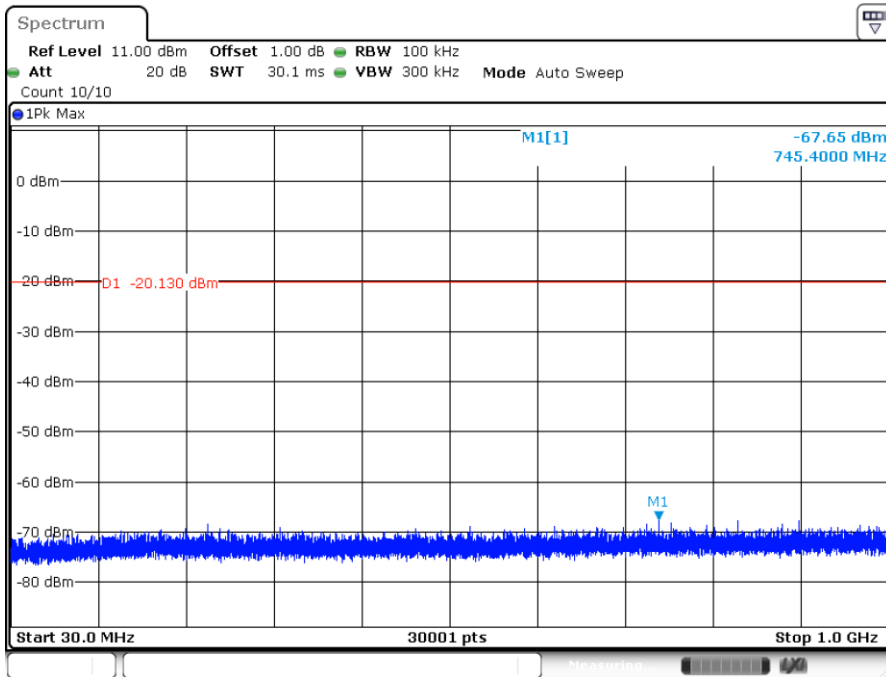

Date: 18.AUG.2020 11:55:53

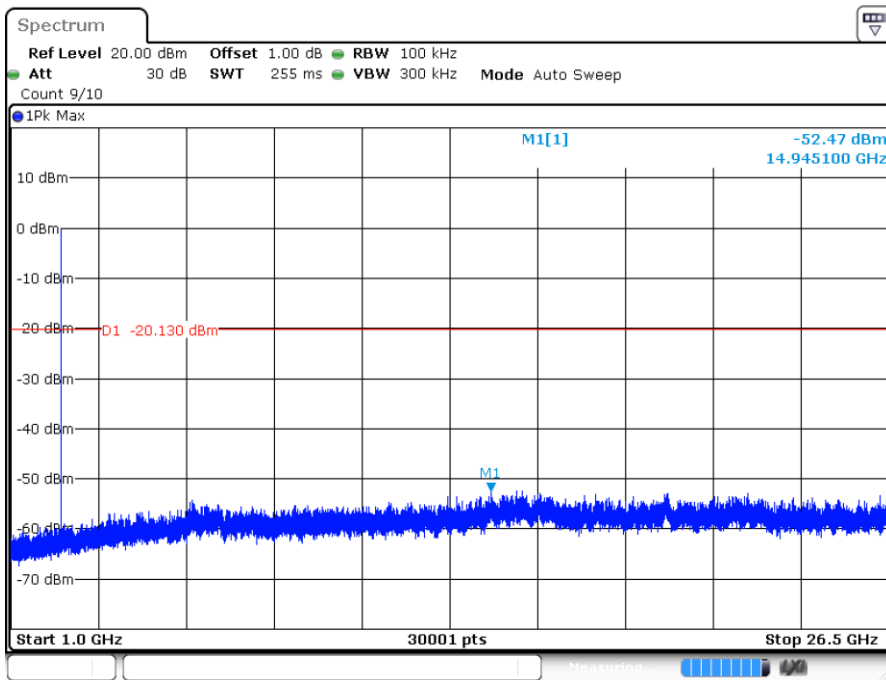

Date: 18.AUG.2020 11:56:01

2480MHz

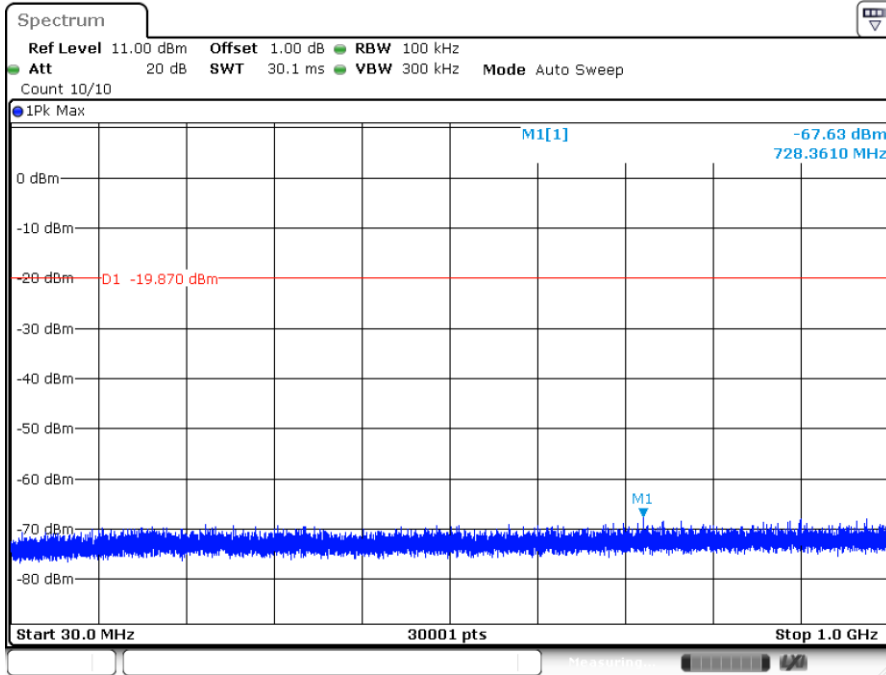

Date: 18.AUG.2020 11:58:32

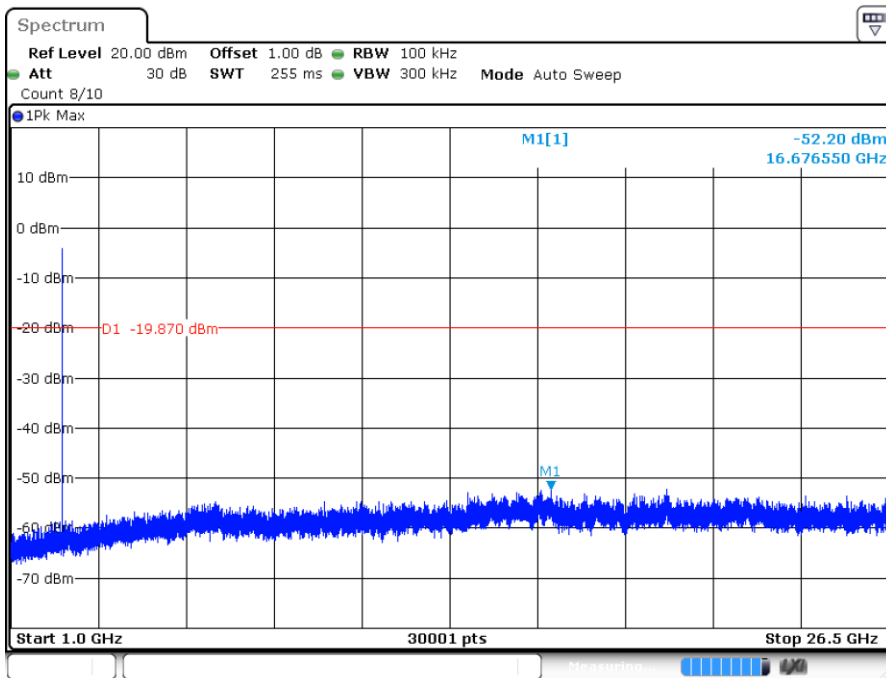

Date: 18.AUG.2020 11:58:40



9.5 Band edge

Test Method

- 1 Use the following spectrum analyzer settings:
Span = wide enough to capture the peak level of the in-band emission and all spurious
RBW = 100 kHz, VBW \geq RBW, Sweep = auto, Detector function = peak, Trace = max hold.
- 2 Allow the trace to stabilize, use the peak and delta measurement to record the result.
- 3 The level displayed must comply with the limit specified in this Section.

Limit

Frequency Range MHz	Limit (dBc)
30-25000	-20

Band edge testing

**1MHz Bandwidth
2402MHz**

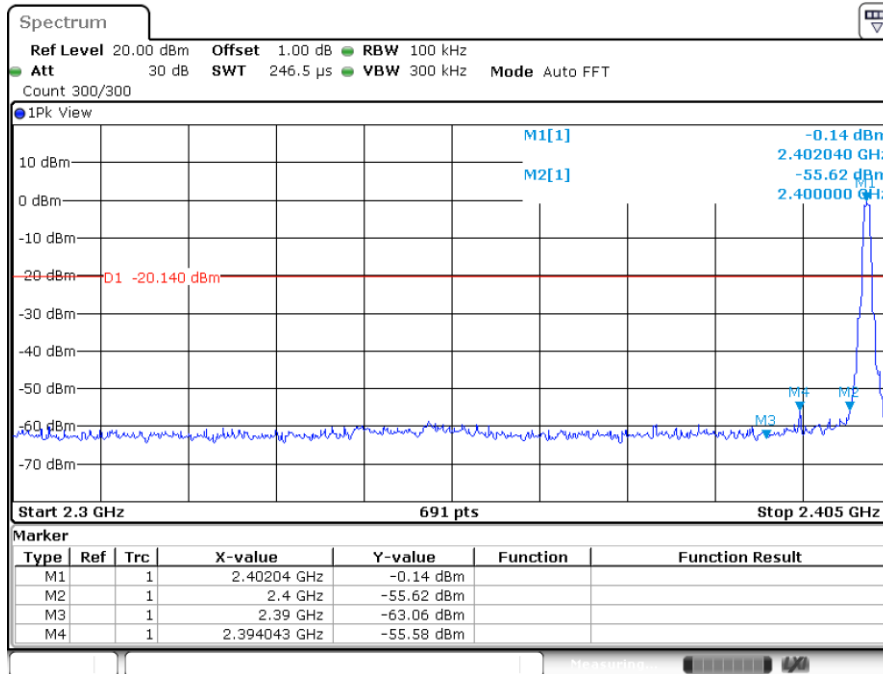

Date: 18.AUG.2020 11:35:20

2480MHz

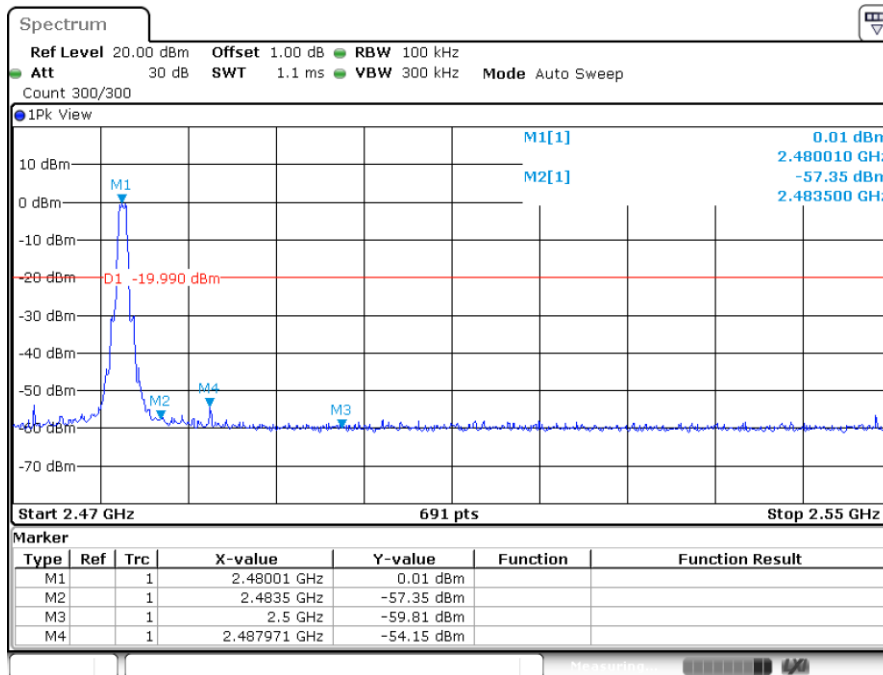

Date: 18.AUG.2020 11:38:43

2MHz Bandwidth 2402MHz

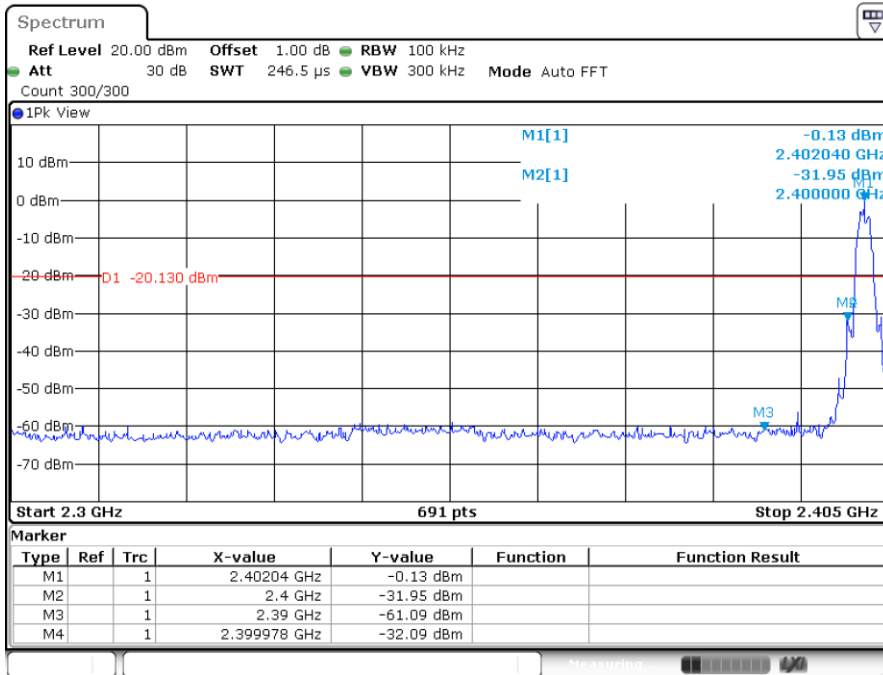

Date: 18.AUG.2020 11:51:58

2480MHz

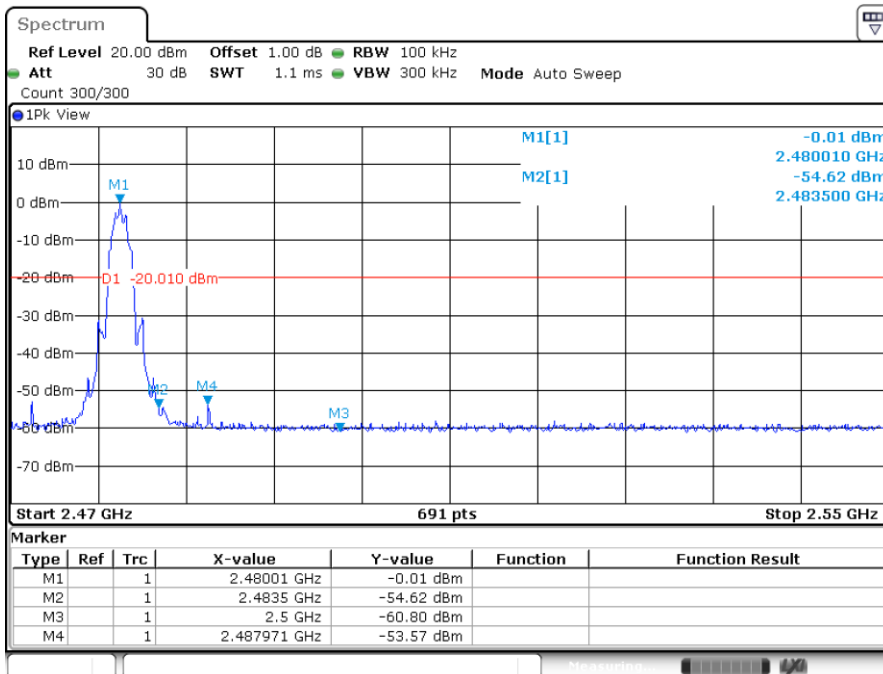

Date: 18.AUG.2020 11:58:20

9.6 Spurious radiated emissions for transmitter

Test Method

- 1: The EUT was placed on a turn table which is 1.5m above ground plane for above 1GHz and 0.8m above ground for below 1GHz at 3 meter chamber room for test. The table was rotated 360 degrees to determine the position of the highest radiation.
- 2: The EUT was set 3 meters away from the interference – receiving antenna, which was mounted on the top of a variable – height antenna tower.
- 3: The height of antenna is varied from one meter to four meters above the ground to determine the maximum value of the field strength. Both horizontal and vertical polarizations of the antenna are set to make the measurement.
- 4: For each suspected emission, the EUT was arranged to its worst case and then the antenna was tuned to heights from 1 meter to 4 meters and the rotatable table was turned from 0 degrees to 360 degrees to find the maximum reading.
- 5: Use the following spectrum analyzer settings According to C63.10:

For Below 1GHz

Use the following spectrum analyzer settings:

Span = wide enough to capture the peak level of the in-band emission and all spurious
 RBW = 100 KHz to 120KHz, VBW ≥ RBW for peak measurement, Sweep = auto, Detector function = peak, Trace = max hold.

For Peak unwanted emissions Above 1GHz:

Span = wide enough to capture the peak level of the in-band emission and all spurious
 RBW = 1MHz, VBW ≥ RBW for peak measurement, Sweep = auto, Detector function = peak, Trace = max hold.

Procedures for average unwanted emissions measurements above 1000 MHz

- a) RBW = 1 MHz.
- b) $VBW \geq [3 \times RBW]$.
- c) Detector = RMS (power averaging), if $[\text{span} / (\# \text{ of points in sweep})] \leq RBW / 2$.
 Satisfying this condition can require increasing the number of points in the sweep or reducing the span. If the condition is not satisfied, then the detector mode shall be set to peak.
- d) Averaging type = power (i.e., rms) (As an alternative, the detector and averaging type may be set for linear voltage averaging. Some instruments require linear display mode to use linear voltage averaging. Log or dB averaging shall not be used.)
- e) Sweep time = auto.
- f) Perform a trace average of at least 100 traces if the transmission is continuous. If the transmission is not continuous, then the number of traces shall be increased by a factor of $1 / D$, where D is the duty cycle. For example, with 50% duty cycle, at least 200 traces shall be averaged. (If a specific emission is demonstrated to be continuous—i.e., 100% duty cycle—then rather than turning ON and OFF with the transmit cycle, at least 100 traces shall be averaged.)
- g) If tests are performed with the EUT transmitting at a duty cycle less than 98%, then a correction factor shall be added to the measurement results prior to comparing with the emission limit, to compute the emission level that would have been measured had the test been performed at 100% duty cycle. The correction factor is computed as follows:
 - 1) If power averaging (rms) mode was used in the preceding step e), then the correction factor is $[10 \log (1 / D)]$, where D is the duty cycle. For example, if the transmit duty cycle was 50%, then 3 dB shall be added to the measured emission levels.

2) If linear voltage averaging mode was used in the preceding step e), then the correction factor is $[20 \log (1 / D)]$, where D is the duty cycle. For example, if the transmit duty cycle was 50%, then 6 dB shall be added to the measured emission levels.

3) If a specific emission is demonstrated to be continuous (100% duty cycle) rather than turning ON and OFF with the transmit cycle, then no duty cycle correction is required for that emission.

Limit

The radio emission outside the operating frequency band shall be at least 20 dB below that in the 100 kHz bandwidth within the band that contains the highest level of the desired power. Radiated emissions which fall in the restricted bands, as defined in section 15.205, must comply with the radiated emission limits specified in section 15.209.

In any 100 kHz bandwidth outside the frequency band in which the spread spectrum or digitally modulated device is operating, the RF power that is produced shall be at least 20 dB below that in the 100 kHz bandwidth within the band that contains the highest level of the desired power, based on either an RF conducted or a radiated measurement, provided that the transmitter demonstrates compliance with the peak conducted power limits. If the transmitter complies with the conducted power limits based on the use of root-mean-square averaging over a time interval, as permitted under section 5.4(d), the attenuation required shall be 30 dB instead of 20 dB. Attenuation below the general field strength limits specified in RSS-Gen is not required.

Frequency MHz	Field Strength uV/m	Field Strength dBµV/m	Detector
30-88	100	40	QP
88-216	150	43.5	QP
216-960	200	46	QP
960-1000	500	54	QP
Above 1000	500	54	AV
Above 1000	5000	74	PK

Spurious radiated emissions for transmitter

According to C63.10, if the peak (or quasi-peak) measured value complies with the average limit, it is unnecessary to perform an average measurement, so AV emission value did not show in below table if the peak value complies with average limit.

Transmitting spurious emission test result as below:

EUT: In-ear True Wireless Headphone
 M/N: PI5R
 Operating Condition: (Tx 2402MHz, lowest Channel), Below 1GHz(GFSK)

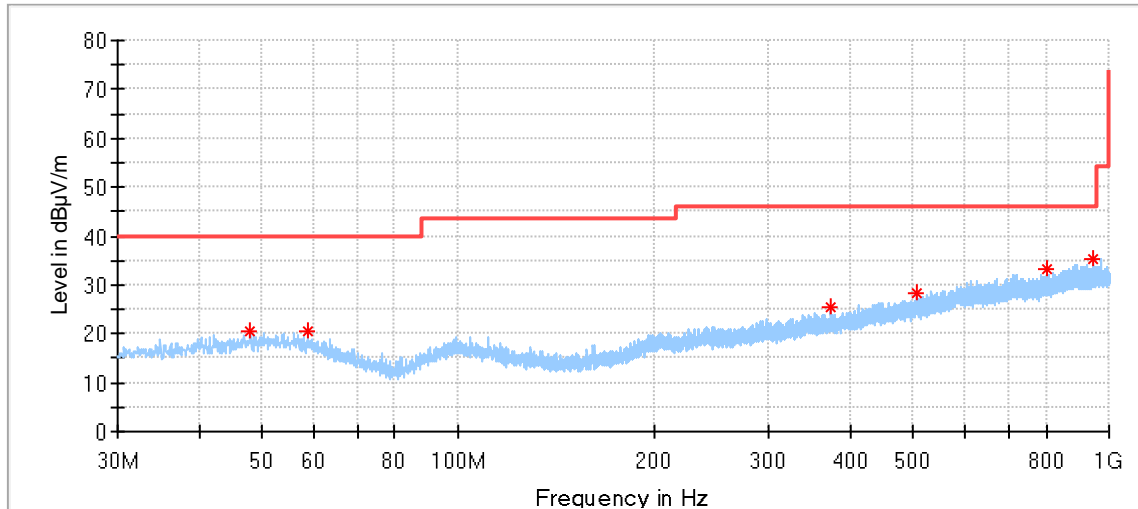

Critical_Freqs

Frequency (MHz)	MaxPeak (dBµV/m)	Limit (dBµV/m)	Margin (dB)	Height (cm)	Pol	Azimuth (deg)	Corr. (dB/m)
47.945000	20.57	40.00	19.43	150.0	H	352.0	14.6
58.830556	20.34	40.00	19.66	150.0	H	303.0	13.8
373.649444	25.62	46.00	20.38	150.0	H	271.0	16.9
506.970556	28.45	46.00	17.55	150.0	H	145.0	19.6
802.120000	33.04	46.00	12.96	150.0	H	108.0	23.5
945.248889	35.12	46.00	10.88	150.0	H	1.0	25.2

EUT: In-ear True Wireless Headphone
 M/N: PI5R
 Operating Condition: (Tx 2402MHz, lowest Channel), Below 1GHz (GFSK)

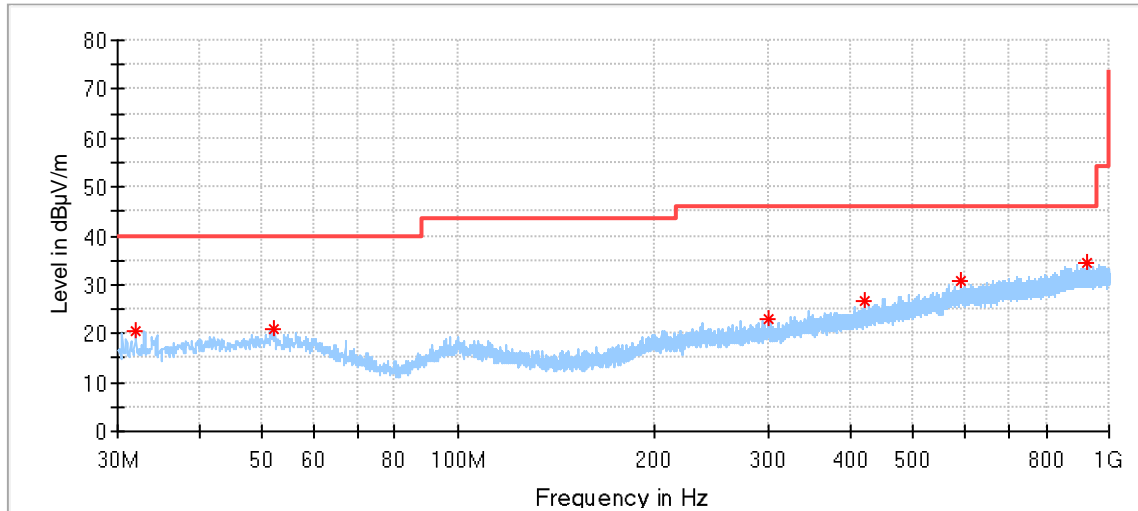

Critical_Freqs

Frequency (MHz)	MaxPeak (dBµV/m)	Limit (dBµV/m)	Margin (dB)	Height (cm)	Pol	Azimuth (deg)	Corr. (dB/m)
31.993889	20.35	40.00	19.65	150.0	V	272.0	11.7
52.310000	20.81	40.00	19.19	150.0	V	231.0	14.6
300.145000	23.05	46.00	22.95	150.0	V	27.0	15.0
421.341111	26.48	46.00	19.52	150.0	V	359.0	17.9
592.007222	30.80	46.00	15.20	150.0	V	272.0	21.4
926.657222	34.56	46.00	11.44	150.0	V	6.0	25.1

EUT: In-ear True Wireless Headphone
 M/N: PI5R
 Operating Condition: (Tx 2402MHz, lowest Channel), 1GHz-18GHz(GFSK)

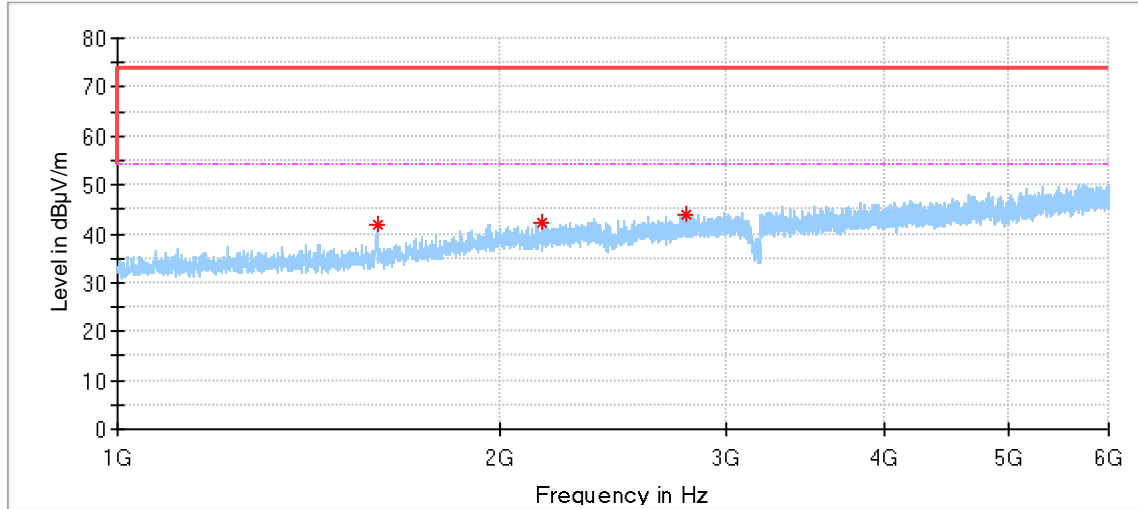

Critical Freqs

Frequency (MHz)	MaxPeak (dBµV/m)	Limit (dBµV/m)	Margin (dB)	Height (cm)	Pol	Azimuth (deg)	Corr. (dB/m)
1599.000000	41.73	74.00	32.27	150.0	H	310.0	-7.3
2158.000000	42.36	74.00	31.64	150.0	H	77.0	-3.9
2793.500000	43.90	74.00	30.10	150.0	H	163.0	-2.0

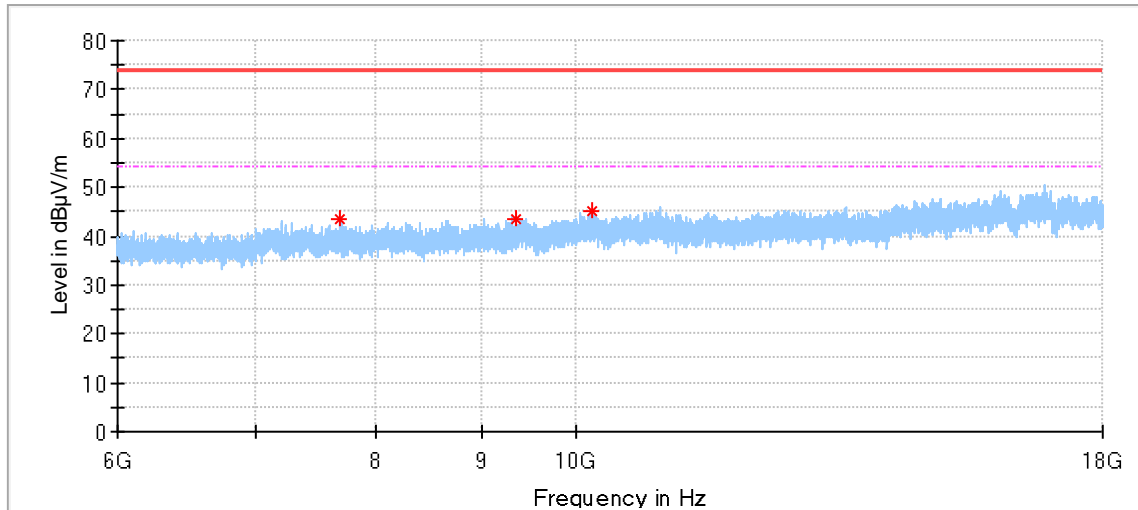

Critical Freqs

Frequency (MHz)	MaxPeak (dBµV/m)	Limit (dBµV/m)	Margin (dB)	Height (cm)	Pol	Azimuth (deg)	Corr. (dB/m)
7693.000000	43.60	74.00	30.40	150.0	H	193.0	5.6
9346.500000	43.50	74.00	30.50	150.0	H	239.0	7.0
10181.000000	45.23	74.00	28.77	150.0	H	285.0	9.0

EUT: In-ear True Wireless Headphone
 M/N: PI5R
 Operating Condition: (Tx 2402MHz, lowest Channel), 1GHz-18GHz (GFSK)

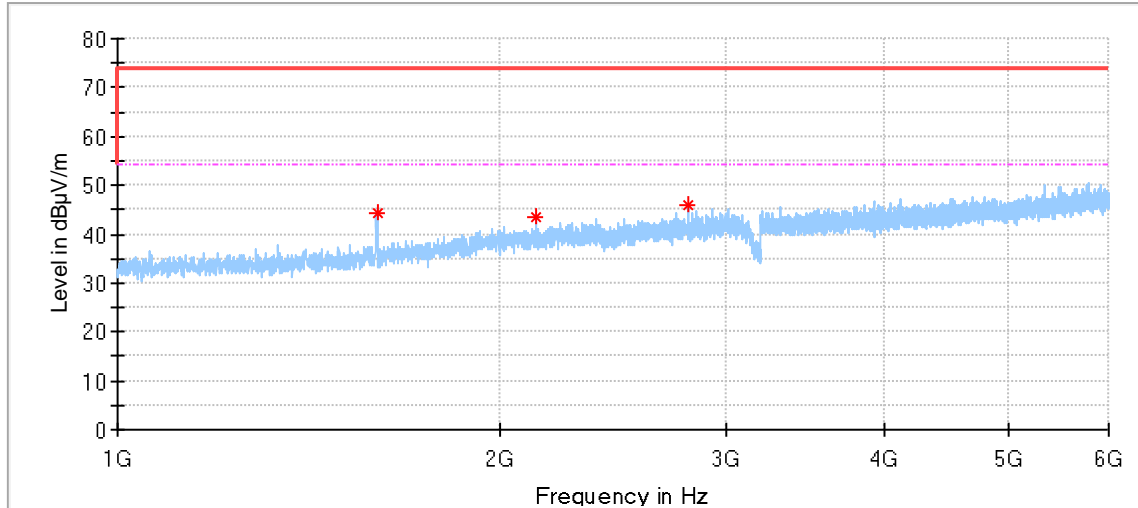

Critical Freqs

Frequency (MHz)	MaxPeak (dBµV/m)	Limit (dBµV/m)	Margin (dB)	Height (cm)	Pol	Azimuth (deg)	Corr. (dB/m)
1599.500000	44.43	74.00	29.57	150.0	V	7.0	-7.3
2134.000000	43.64	74.00	30.36	150.0	V	183.0	-3.9
2806.500000	45.80	74.00	28.20	150.0	V	322.0	-2.0

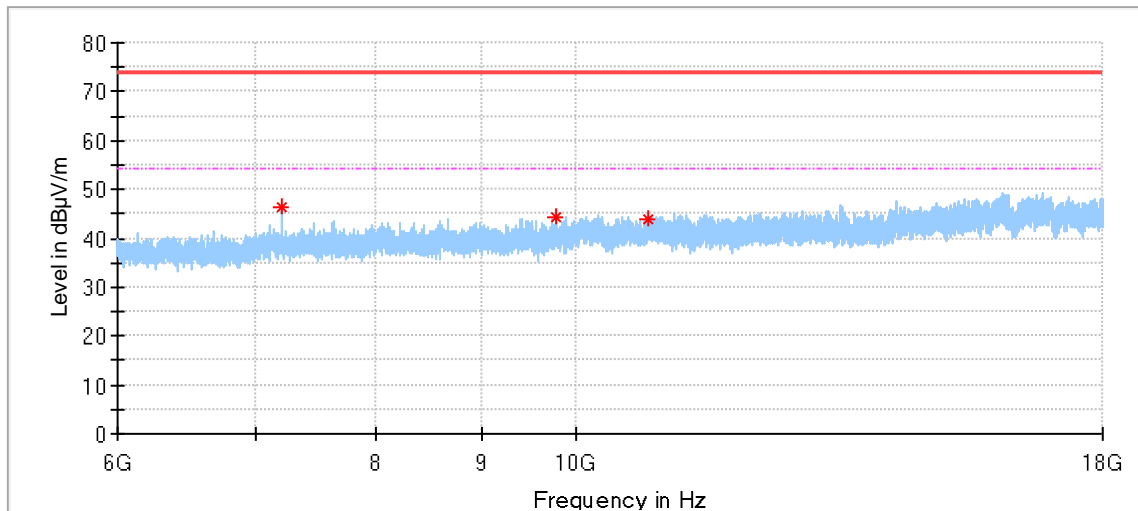

Critical Freqs

Frequency (MHz)	MaxPeak (dBµV/m)	Limit (dBµV/m)	Margin (dB)	Height (cm)	Pol	Azimuth (deg)	Corr. (dB/m)
7206.000000	46.56	74.00	27.44	150.0	V	188.0	5.1
9774.000000	44.16	74.00	29.84	150.0	V	48.0	7.8
10833.500000	44.06	74.00	29.94	150.0	V	0.0	8.4

EUT: In-ear True Wireless Headphone
 M/N: PI5R
 Operating Condition: (Tx 2440MHz, Middle Channel), 1GHz-18GHz(GFSK)

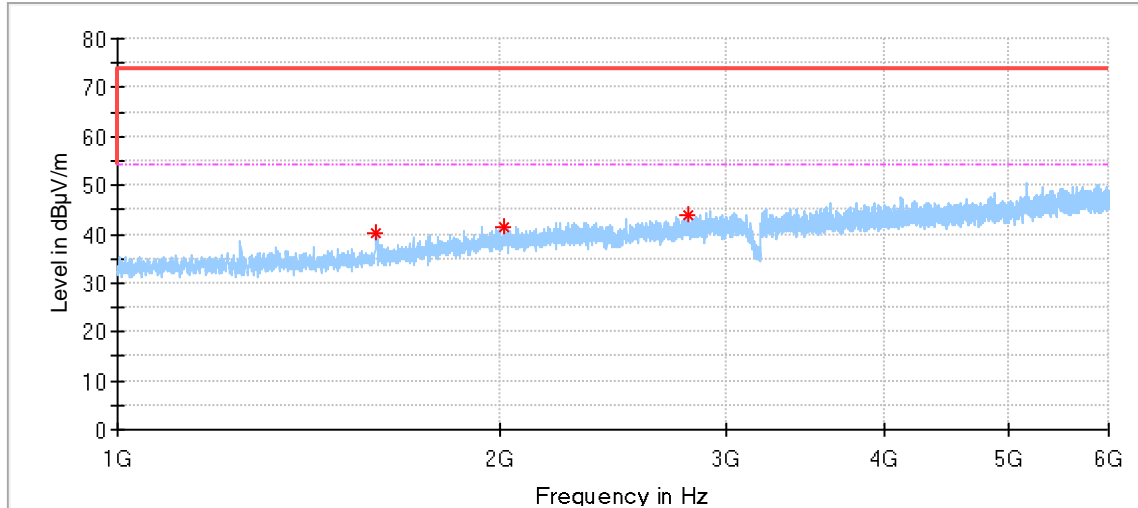

Critical Freqs

Frequency (MHz)	MaxPeak (dBµV/m)	Limit (dBµV/m)	Margin (dB)	Height (cm)	Pol	Azimuth (deg)	Corr. (dB/m)
1594.500000	40.36	74.00	33.64	150.0	H	298.0	-7.3
2014.500000	41.45	74.00	32.55	150.0	H	34.0	-4.2
2808.500000	43.85	74.00	30.15	150.0	H	81.0	-2.0

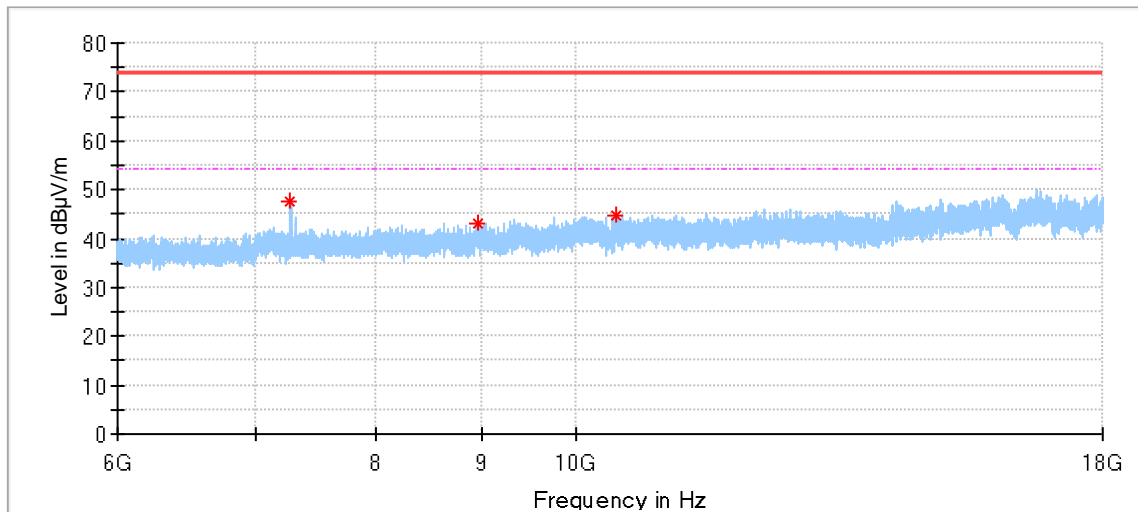

Critical Freqs

Frequency (MHz)	MaxPeak (dBµV/m)	Limit (dBµV/m)	Margin (dB)	Height (cm)	Pol	Azimuth (deg)	Corr. (dB/m)
7278.000000	47.43	74.00	26.57	150.0	H	261.0	5.3
8968.500000	42.91	74.00	31.09	150.0	H	0.0	6.6
10470.000000	44.61	74.00	29.39	150.0	H	0.0	8.6

EUT: In-ear True Wireless Headphone
 M/N: PI5R
 Operating Condition: (Tx 2440MHz, Middle Channel), 1GHz-18GHz(GFSK)

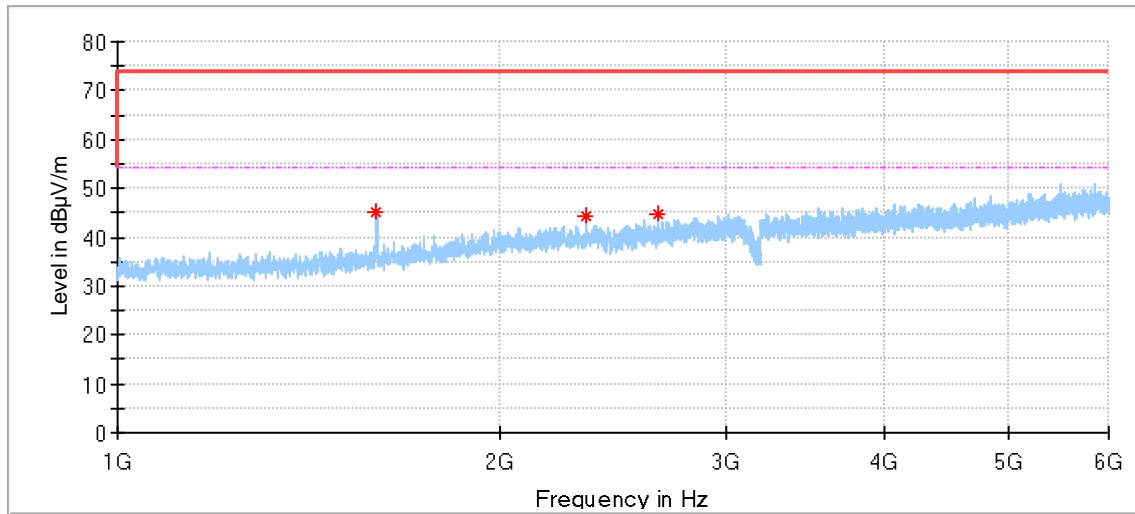

Critical_Freqs

Frequency (MHz)	MaxPeak (dBµV/m)	Limit (dBµV/m)	Margin (dB)	Height (cm)	Pol	Azimuth (deg)	Corr. (dB/m)
1596.500000	44.96	74.00	29.04	150.0	V	201.0	-7.3
2331.500000	44.21	74.00	29.79	150.0	V	287.0	-3.2
2658.000000	44.74	74.00	29.26	150.0	V	170.0	-2.4

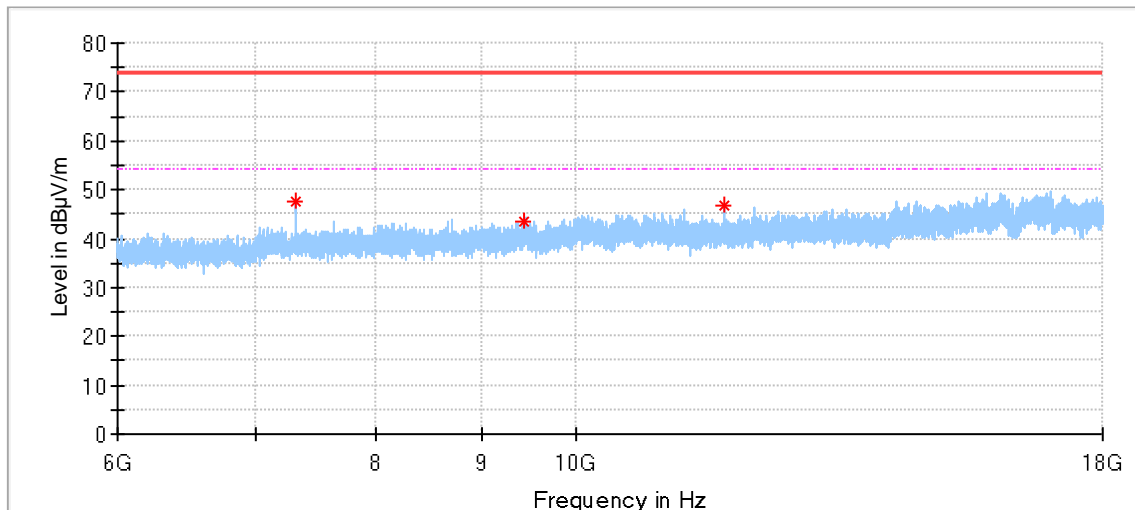

Critical_Freqs

Frequency (MHz)	MaxPeak (dBµV/m)	Limit (dBµV/m)	Margin (dB)	Height (cm)	Pol	Azimuth (deg)	Corr. (dB/m)
7319.000000	47.40	74.00	26.60	150.0	V	191.0	5.3
9446.500000	43.46	74.00	30.54	150.0	V	0.0	7.5
11802.000000	46.85	74.00	27.15	150.0	V	53.0	8.5

EUT: In-ear True Wireless Headphone
 M/N: PI5R
 Operating Condition: (Tx 2480MHz, High Channel), 1GHz-18GHz(GFSK)

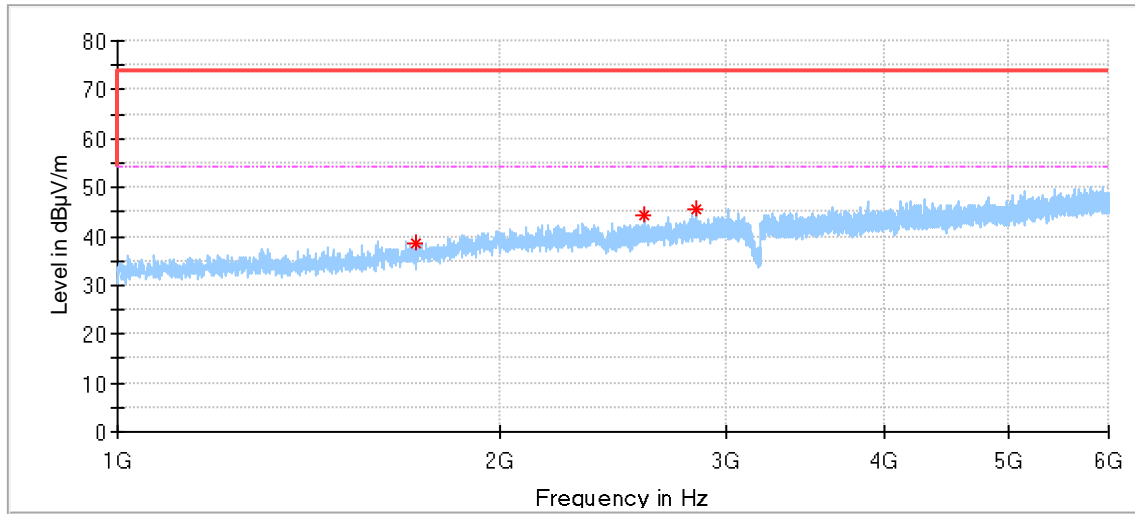

Critical_Freqs

Frequency (MHz)	MaxPeak (dBµV/m)	Limit (dBµV/m)	Margin (dB)	Height (cm)	Pol	Azimuth (deg)	Corr. (dB/m)
1712.500000	38.67	74.00	35.33	150.0	H	30.0	-6.3
2595.500000	44.20	74.00	29.80	150.0	H	9.0	-2.6
2848.000000	45.45	74.00	28.55	150.0	H	170.0	-1.9

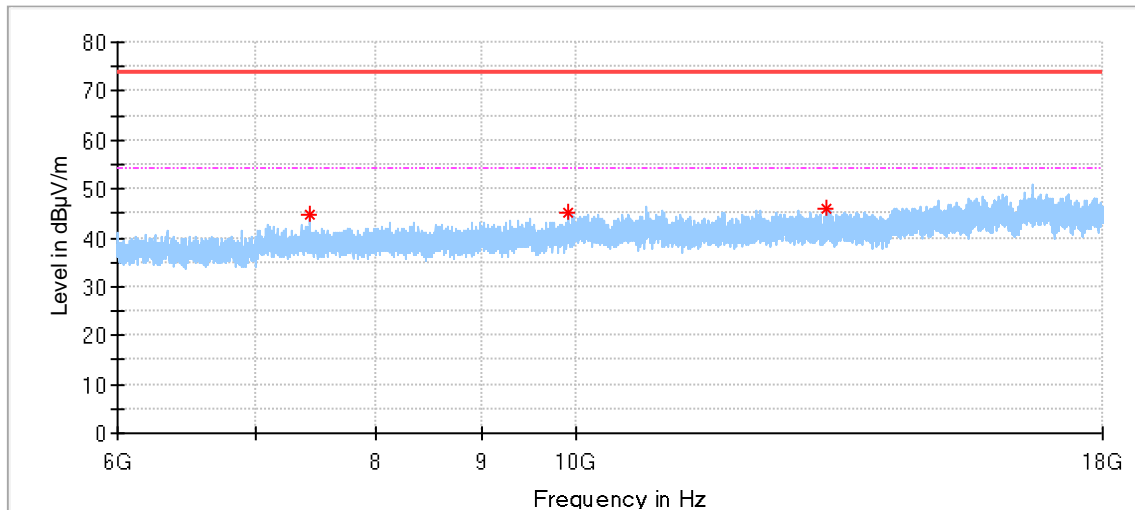

Critical_Freqs

Frequency (MHz)	MaxPeak (dBµV/m)	Limit (dBµV/m)	Margin (dB)	Height (cm)	Pol	Azimuth (deg)	Corr. (dB/m)
7439.500000	44.82	74.00	29.18	150.0	H	234.0	5.5
9919.500000	45.05	74.00	28.95	150.0	H	0.0	8.1
13221.500000	46.07	74.00	27.93	150.0	H	165.0	9.3

EUT: In-ear True Wireless Headphone
 M/N: PI5R
 Operating Condition: (Tx 2480MHz, High Channel), 1GHz-18GHz(GFSK)

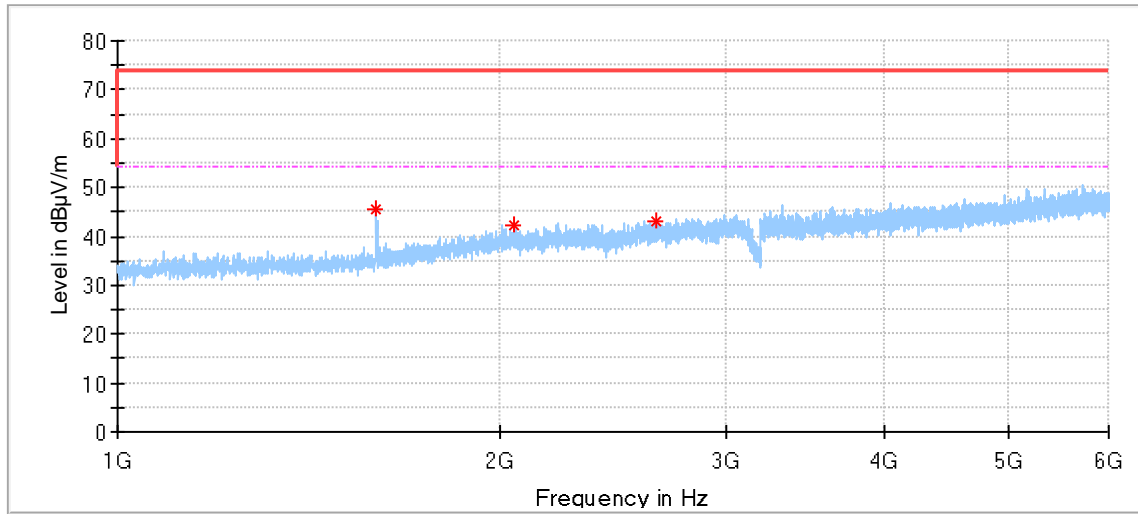

Critical_Freqs

Frequency (MHz)	MaxPeak (dBµV/m)	Limit (dBµV/m)	Margin (dB)	Height (cm)	Pol	Azimuth (deg)	Corr. (dB/m)
1596.500000	45.43	74.00	28.57	150.0	V	34.0	-7.3
2048.000000	42.12	74.00	31.88	150.0	V	356.0	-4.1
2645.500000	43.24	74.00	30.76	150.0	V	183.0	-2.5

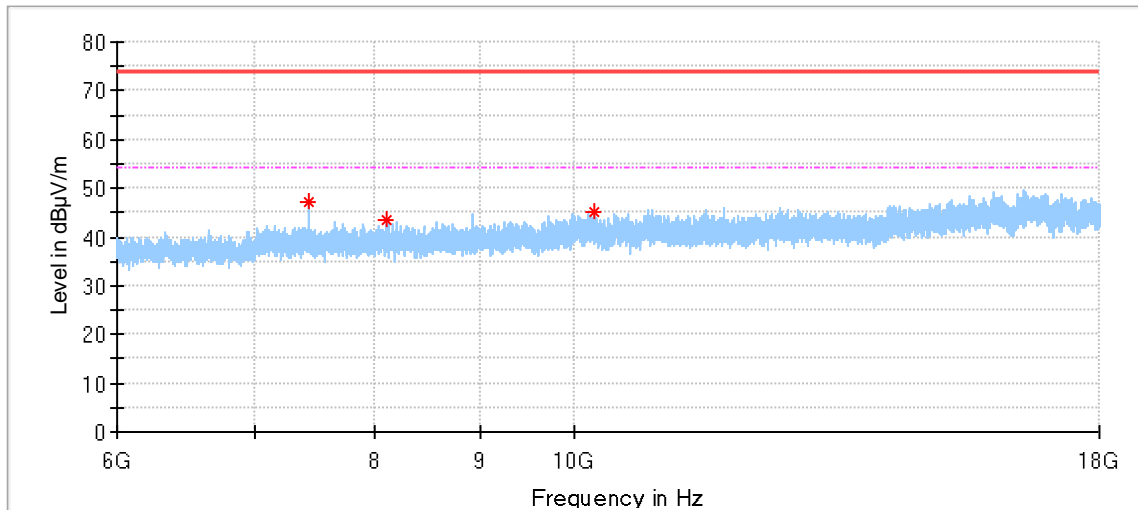

Critical_Freqs

Frequency (MHz)	MaxPeak (dBµV/m)	Limit (dBµV/m)	Margin (dB)	Height (cm)	Pol	Azimuth (deg)	Corr. (dB/m)
7440.500000	47.33	74.00	26.67	150.0	V	172.0	5.5
8119.500000	43.57	74.00	30.43	150.0	V	0.0	6.4
10224.500000	45.03	74.00	28.97	150.0	V	0.0	9.0

Remark:

- (1) Data of measurement within frequency range 18-26GHz are the noise floor or attenuated more than 20dB below the permissible limits or the field strength is too small to be measured, so test data does not present in this report.
- (2) Level=Reading Level + Correction Factor
Above 1GHz: Corrector factor = Antenna Factor + Cable Loss- Amplifier Gain
Below 1GHz: Corrector factor = Antenna Factor + Cable Loss
(The Reading Level is recorded by software which is not shown in the sheet)

10 Test Equipment List

List of Test Instruments

Radiated Emission Test

Description	Manufacturer	Model no.	Equipment ID	Serial no.	cal interval (year)	cal. due date
EMI Test Receiver	Rohde & Schwarz	ESR 26	68-4-74-14-002	101269	1	2021-6-29
Trilog Super Broadband Test Antenna	Schwarzbeck	VULB 9162	68-4-80-19-003	284	1	2021-2-24
Wave Guide Antenna	ETS	3117	68-4-80-19-001	00218954	1	2021-6-15
Pre-amplifier	Rohde & Schwarz	SCU 18F	68-4-29-19-001	100745	1	2020-12-14
Pre-amplifier	Rohde & Schwarz	SCU 08F2	68-4-29-19-004	08400018	1	2020-12-14
Sideband Horn Antenna	Q-PAR	QWH-SL-18-40-K-SG	68-4-80-14-008	12827	1	2021-8-5
Pre-amplifier	Rohde & Schwarz	SCU 40A	68-4-29-14-002	100432	1	2021-7-30
3m Semi-anechoic chamber	TDK	9X6X6	68-4-90-19-006	----	3	2022-12-29
Test software	Rohde & Schwarz	EMC32	68-4-90-19-006-A01	Version10.35.0 2	N/A	N/A

RF Conducted Test

Description	Manufacturer	Model no.	Equipment ID	Serial no.	cal interval (year)	cal. due date
Signal Analyzer	Rohde & Schwarz	FSV40	68-4-74-14-004	101030	1	2021-6-21



11 System Measurement Uncertainty

For a 95% confidence level, the measurement expanded uncertainties for defined systems, in accordance with the recommendations of ISO 17025 were:

System Measurement Uncertainty	
Test Items	Extended Uncertainty
Radiated Spurious Emission 30MHz-1000MHz	Horizontal: 4.70dB; Vertical: 4.67dB;
Radiated Spurious Emission 1000MHz-18000MHz	Horizontal: 4.65dB; Vertical: 4.63dB;
Conducted RF test with TS 8997	RF Power Conducted: 1.16dB Frequency test involved: 0.6×10 ⁻⁷ or 1%