

FCC/IC - TEST REPORT

Report Number : **68.950.20.0520.01** Date of Issue: September 03, 2020

Model : PI5L

Product Type : In-ear True Wireless Headphone

Applicant : B&W Group Ltd.

Address : Dale Road Worthing United Kingdom BN11 2BH

Factory : Charter Media (Dongguan) Co., Ltd.

Address : Dabandi Industrial Zone, Daning District, Humen Town,
523930 Dongguan City, Guangdong Province,
PEOPLE'S REPUBLIC OF CHINA

Test Result : **Positive** **Negative**

Total pages including Appendices : 64

TÜV SÜD CERTIFICATION AND TESTING (CHINA) CO., LTD. SHENZHEN BRANCH is a subcontractor to TÜV SÜD Product Service GmbH according to the principles outlined in ISO 17025. TÜV SÜD CERTIFICATION AND TESTING (CHINA) CO., LTD. SHENZHEN BRANCH reports apply only to the specific samples tested under stated test conditions. Construction of the actual test samples has been documented. It is the manufacturer's responsibility to assure that additional production units of this model are manufactured with identical electrical and mechanical components. The manufacturer/importer is responsible to the Competent Authorities in Europe for any modifications made to the production units which result in non-compliance to the relevant regulations TÜV SÜD CERTIFICATION AND TESTING (CHINA) CO., LTD. SHENZHEN BRANCH shall have no liability for any deductions, inferences or generalizations drawn by the client or others from TÜV SÜD CERTIFICATION AND TESTING (CHINA) CO., LTD. SHENZHEN BRANCH issued reports. This report is the confidential property of the client. As a mutual protection to our clients, the public and ourselves, extracts from the test report shall not be reproduced except in full without our written approval.



1 Table of Contents

1	Table of Contents	2
2	Details about the Test Laboratory	3
3	Description of the Equipment Under Test	4
4	Summary of Test Standards	5
5	Summary of Test Results	6
6	General Remarks.....	7
7	Test Setups.....	8
8	Systems test configuration	9
9	Technical Requirement	10
9.1	Conducted peak output power and e.i.r.p.	10
9.2	20 dB bandwidth and 99% Occupied Bandwidth.....	17
9.3	Carrier Frequency Separation.....	27
9.4	Number of hopping frequencies	30
9.5	Dwell Time	32
9.6	Spurious RF conducted emissions.....	37
9.7	Band edge testing	48
9.8	Spurious radiated emissions for transmitter	53
10	Test Equipment List.....	63
11	System Measurement Uncertainty	64



2 Details about the Test Laboratory

Details about the Test Laboratory

Test Site 1

Company name: TÜV SÜD Certification and Testing (China) Co., Ltd. Shenzhen Branch
Building 12 & 13, Zhiheng Wisdomland Business Park, Nantou Checkpoint
Road 2, Nanshan District
Shenzhen 518052
P.R. China

Telephone: 86 755 8828 6998
Fax: 86 755 8288 5299

FCC Registration No.: 514049
ISED#: 10320A

3 Description of the Equipment Under Test

Product:	In-ear True Wireless Headphone
Model no/HVIN/PMN:	PI5L
FVIN:	V1.0.x
FCC ID	2ACIX-PI5L
IC:	11946B-PI5L
Options and accessories:	Type-C Cable, Charging Case
Rating:	Earbud: 3.7VDC, 55mAh, 0.204Wh (Supplied by Built Li-ion battery)
RF Transmission Frequency:	2402MHz-2480MHz
No. of Operated Channel:	79
Modulation:	GFSK, $\pi/4$ -DQPSK, 8-DPSK
Antenna Type:	Mono pole antenna
Antenna Gain:	1.0dBi
Description of the EUT:	The Equipment Under Test (EUT) is an In-ear True Wireless Headphone support Bluetooth function.



4 Summary of Test Standards

Test Standards	
FCC Part 15 Subpart C 10-1-2019 Edition	PART 15 - RADIO FREQUENCY DEVICES Subpart C - Intentional Radiators
RSS-Gen Issue 5, Amendment 1, March 2019	General Requirements for the Certification of Radio Apparatus
RSS-247 Issue 2 February 2017	Digital Transmission Systems (DTSS), Frequency Hopping Systems (FHSS) and License-Exempt Local Area Network (LE-LAN) Devices

All the test methods were according to Public Notice DA 00-705 -Frequency Hopper Spread Spectrum Test Procedure, KDB558074 D01 v05r02 and ANSI C63.10-2013.

5 Summary of Test Results

Technical Requirements					
FCC Part 15 Subpart C/ RSS-247 Issue 2/RSS-Gen Issue 5					
Test Condition			Pages	Test Result	Test Site
§15.207	RSS-GEN 8.8	Conducted emission AC power port	--	N/A	--
§15.247(b)(1)	RSS-247 Clause 5.4(b)	Conducted peak output power and e.i.r.p.	10	Pass	Site 1
§15.247(e)	RSS-247 Clause 5.2(b)	Power spectral density*	--	N/A	--
§15.247(a)(2)	RSS-247 Clause 5.2(a)	6dB bandwidth	--	N/A	--
§15.247(a)(1)	RSS-247 Clause 5.1(a) & RSS-Gen 6.7	20dB bandwidth and 99% Occupied Bandwidth	17	Pass	Site 1
§15.247(a)(1)	RSS-247 Clause 5.1(b)	Carrier frequency separation	27	Pass	Site 1
§15.247(a)(1)(iii)	RSS-247 Clause 5.1(d)	Number of hopping frequencies	30	Pass	Site 1
§15.247(a)(1)(iii)	RSS-247 Clause 5.1(d)	Dwell Time	32	Pass	Site 1
§15.247(d)	RSS-247 Clause 5.5	Spurious RF conducted emissions	37	Pass	Site 1
§15.247(d)	RSS-247 Clause 5.5	Band edge	48	Pass	Site 1
§15.247(d) & §15.209 & §15.205	RSS-247 Clause 5.5 & RSS-GEN 6.13 RSS-GEN 8.9 RSS-GEN 8.10	Spurious radiated emissions for transmitter and receiver	53	Pass	Site 1
§15.203	RSS-GEN 6.8	Antenna requirement	See note 2	Pass	--

Note 1: N/A=Not Applicable.

Note 2: The EUT uses Mono pole antenna, which gain is 1.0dBi. In accordance to §15.203 and RSS-GEN 6.8, it is considered sufficiently to comply with the provisions of this section.



6 General Remarks

Remarks

This submittal(s) (test report) is intended for FCC ID: 2ACIX-PI5L, IC: 11946B-PI5L complies with Section 15.205, 15.209, 15.247 of the FCC Part 15, Subpart and RSS-247 issue 2 and RSS-Gen issue 5 rules.

Note: The report is for BDR+EDR only.

SUMMARY:

All tests according to the regulations cited on page 6 were

- Performed

- **Not** Performed

The Equipment Under Test

- **Fulfills** the general approval requirements.

- **Does not** fulfill the general approval requirements.

Sample Received Date: August 3, 2020

Testing Start Date: August 3, 2020

Testing End Date: August 31, 2020

Reviewed by:

Prepared by:

Tested by:

John Zhi
EMC Project Manager

Mark Chen
EMC Project Engineer

Tree Zhan
EMC Test Engineer

7 Test Setups

7.1 Radiated test setups

Below 1GHz

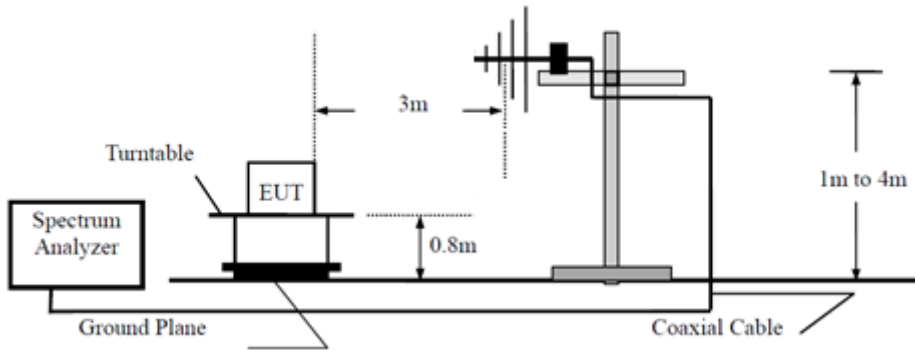

Above 1GHz

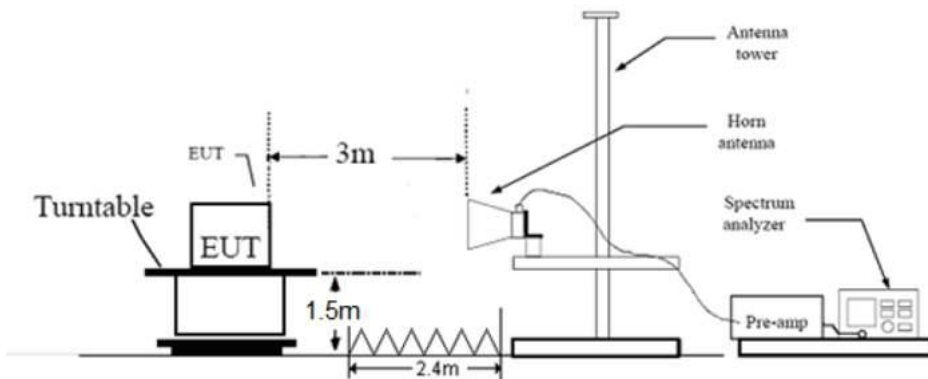

7.2 Conducted RF test setups

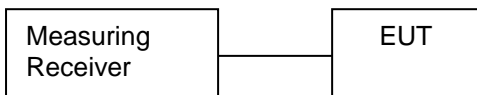

8 Systems test configuration

Auxiliary Equipment Used during Test:

DESCRIPTION	MANUFACTURER	MODEL NO.	S/N
Notebook	Lenovo	X220	---

Test software: Bluetooth 3 Test Tool, which used to control the EUT in continues transmitting mode

The system was configured to hopping mode and non-hopping mode.

Hopping mode: typical working mode (normal hopping status)

Non-hopping mode: The system was configured to operate at a signal channel transmitting. The test software allows the configuration and operation at the worst-case duty and the highest transmit power.

9 Technical Requirement

9.1 Conducted peak output power and e.i.r.p.

Test Method

1. Use the following spectrum analyzer settings:
Span = approximately 5 times the 20dB bandwidth, centered on a hopping channel
RBW > the 20dB bandwidth of the emission being measured, VBW ≥ RBW,
Sweep = auto, Detector function = peak, Trace = max hold
2. Add a correction factor to the display.
3. Allow the trace to stabilize. Use the marker-to-peak function to set the marker to the peak of the emission. The indicated level is the peak output power

Limits

Conducted Peak Output Power:

Frequency Range MHz	Limit W	Limit dBm
2400-2483.5	≤1	≤30

For e.i.r.p.:

Frequency Range MHz	Limit W	Limit dBm
2400-2483.5	≤4	≤36

Conducted peak output power

Bluetooth Mode GFSK modulation Test Result

Frequency MHz	Conducted Peak Output Power dBm	e.i.r.p. dBm	Result
Low channel 2402MHz	7.73	8.73	Pass
Middle channel 2441MHz	7.84	8.84	Pass
High channel 2480MHz	8.19	9.19	Pass

Low channel 2402MHz

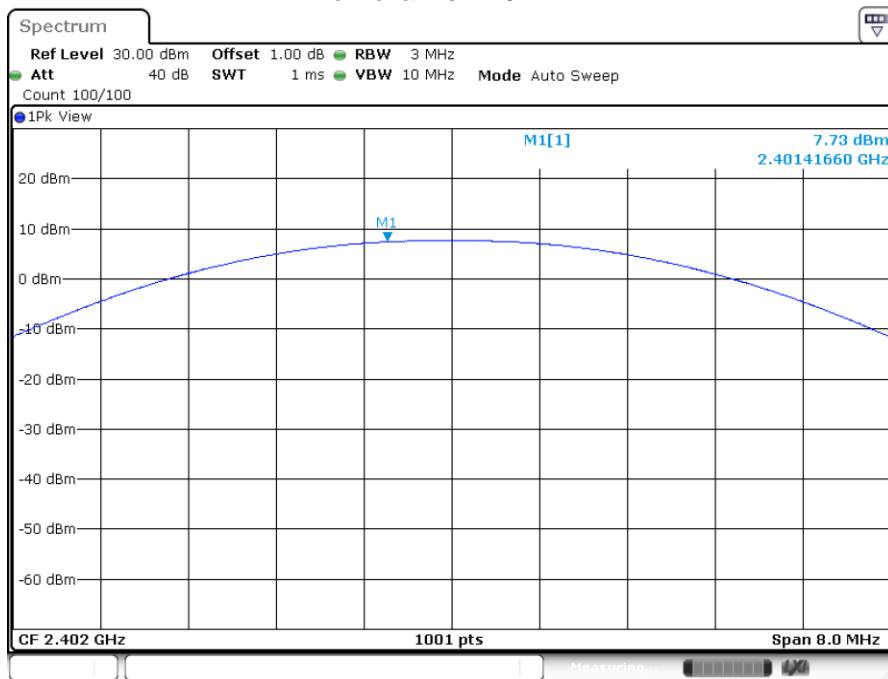

Date: 18.AUG.2020 18:26:51

Middle channel 2441MHz

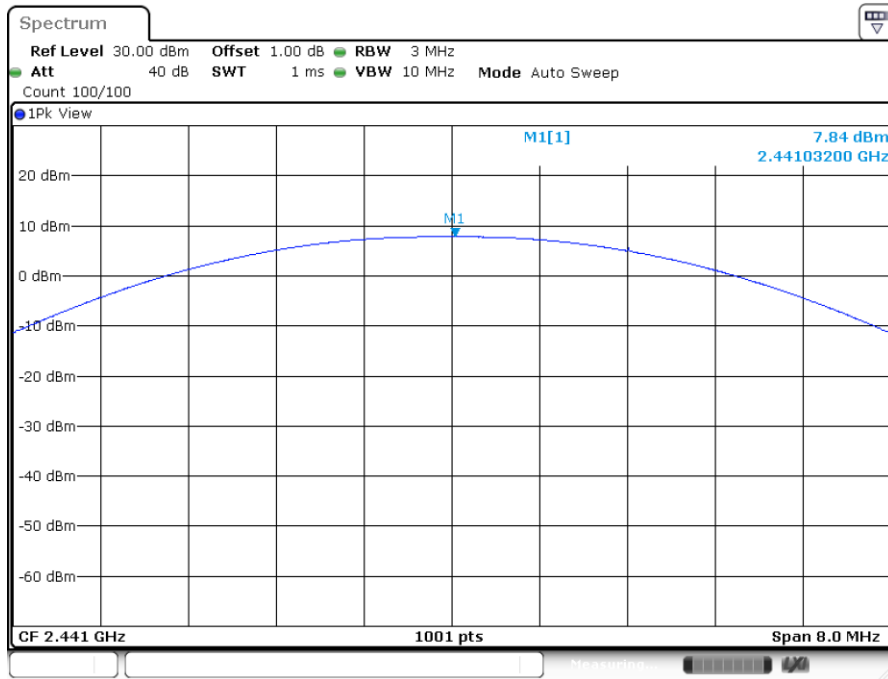

Date: 18.AUG.2020 18:30:33

High channel 2480MHz

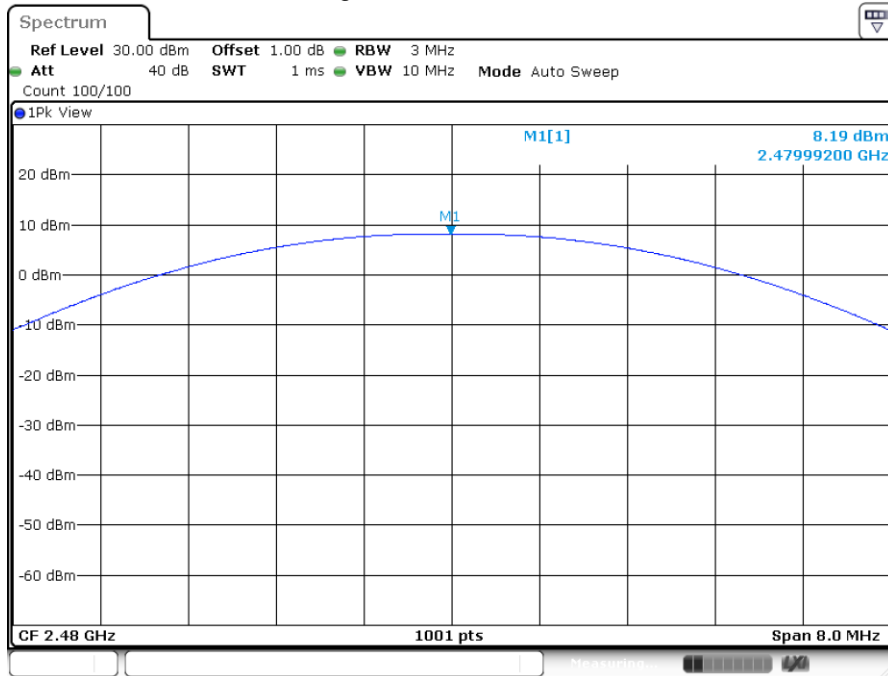

Date: 18.AUG.2020 18:39:10

Bluetooth Mode $\pi/4$ -DQPSK modulation Test Result

Frequency MHz	Conducted Peak Output Power dBm	e.i.r.p. dBm	Result
Low channel 2402MHz	7.97	8.97	Pass
Middle channel 2441MHz	7.82	8.82	Pass
High channel 2480MHz	8.26	9.26	Pass

Low channel 2402MHz

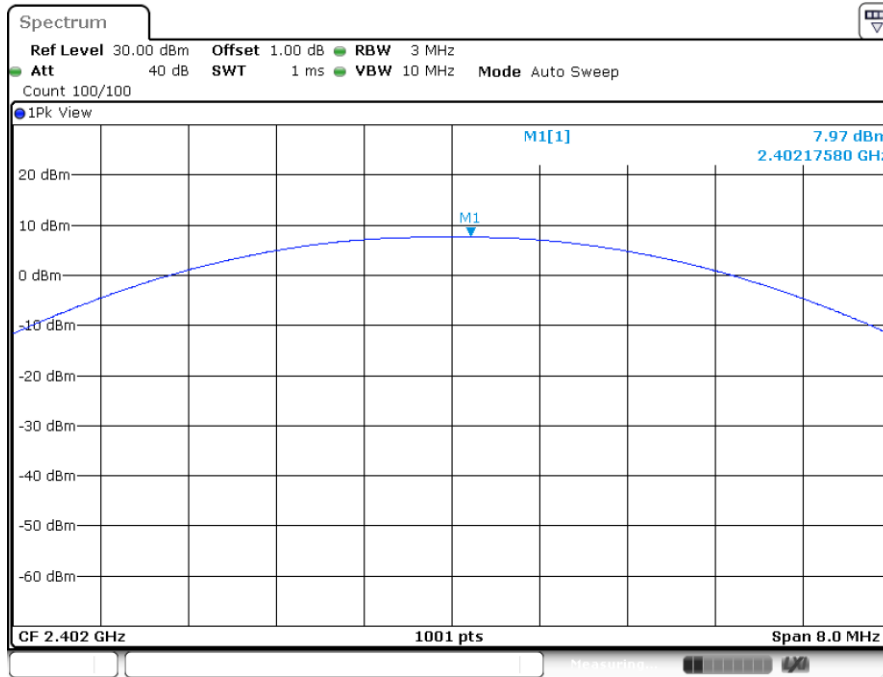

Date: 18.AUG.2020 18:40:24

Middle channel 2441MHz

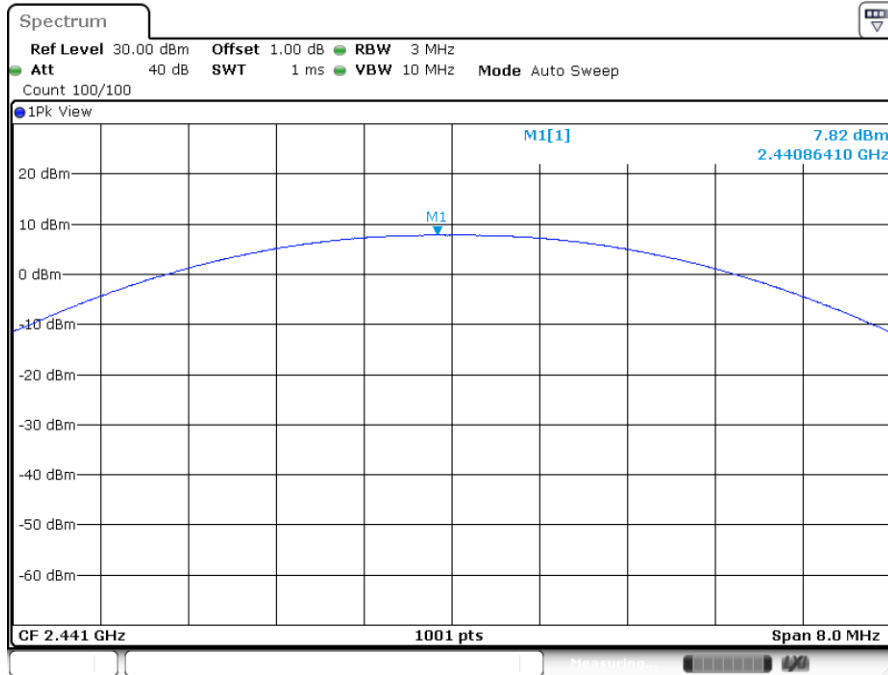

Date: 18.AUG.2020 18:40:41

High channel 2480MHz

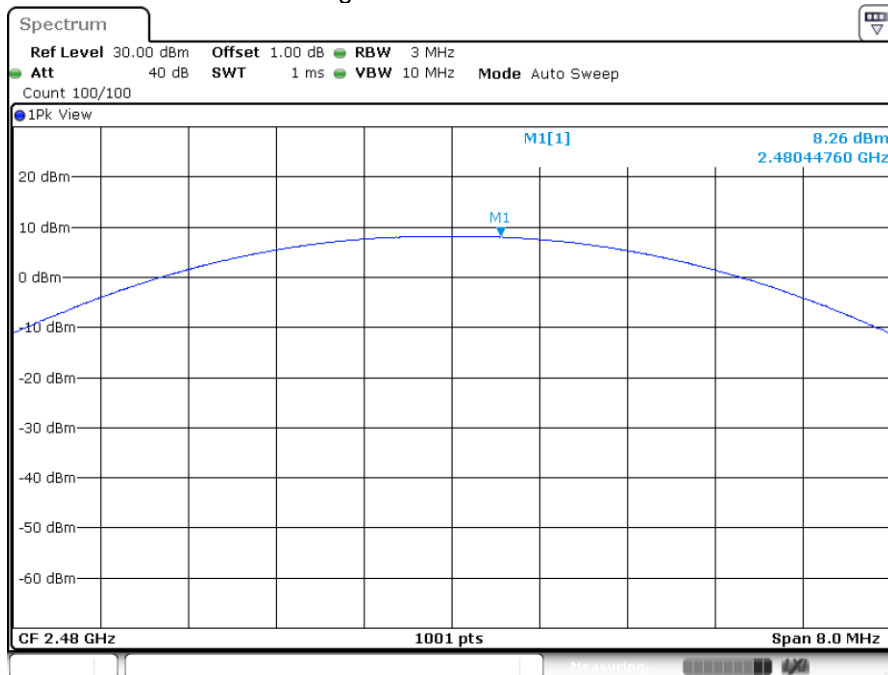

Date: 18.AUG.2020 18:41:03



Bluetooth Mode 8DPSK modulation Test Result

Frequency MHz	Conducted Peak Output Power dBm	e.i.r.p. dBm	Result
Low channel 2402MHz	7.78	8.78	Pass
Middle channel 2441MHz	7.89	8.89	Pass
High channel 2480MHz	8.31	9.31	Pass

Low channel 2402MHz

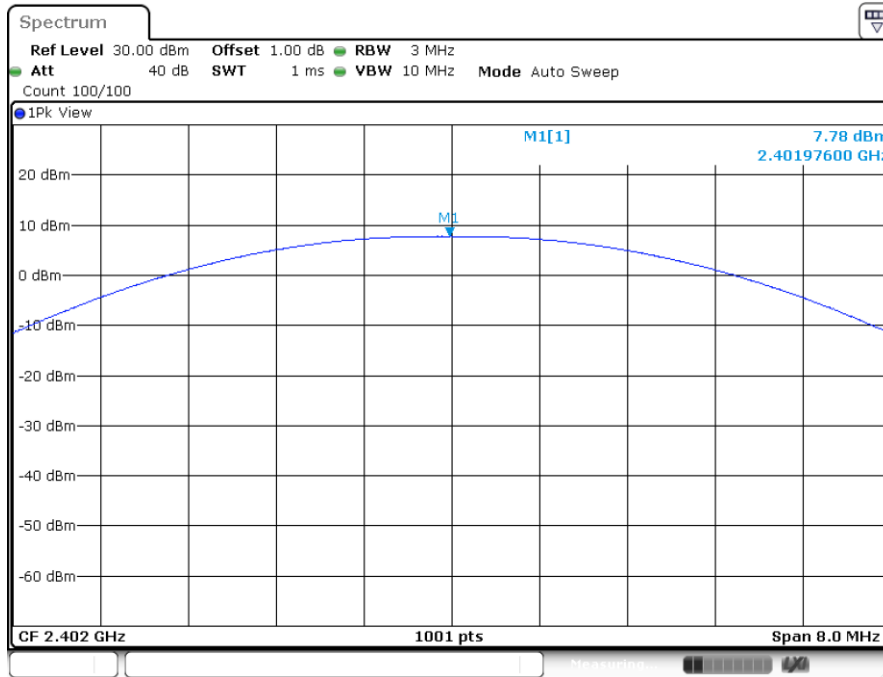

Date: 18.AUG.2020 18:42:29

Middle channel 2441MHz

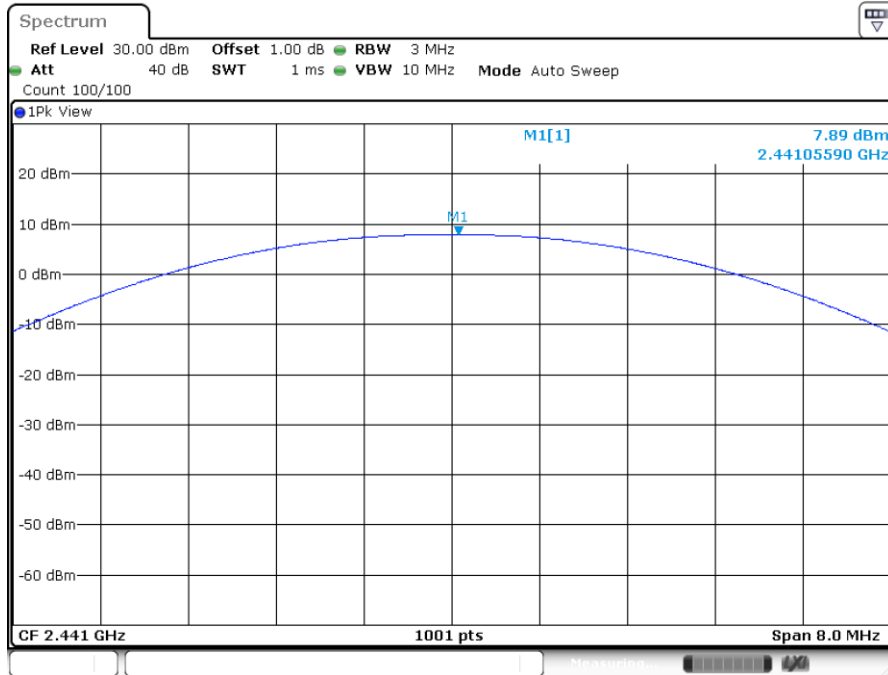

Date: 18.AUG.2020 18:42:51

High channel 2480MHz

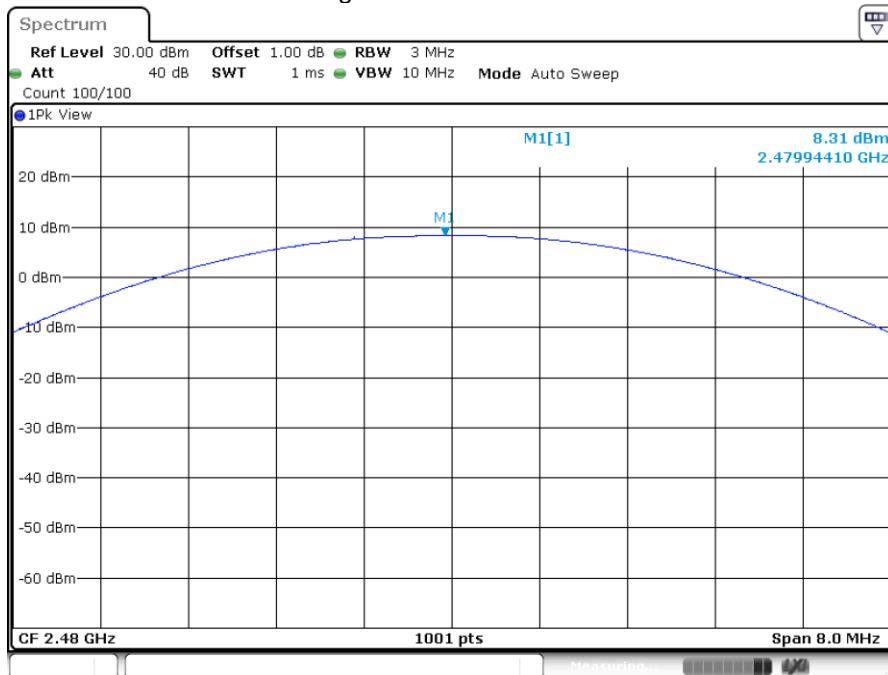

Date: 18.AUG.2020 18:43:00



9.2 20 dB bandwidth and 99% Occupied Bandwidth

Test Method

1. Check the calibration of the measuring instrument using either an internal calibrator or a known signal from an external generator.
2. Position the EUT without connection to measurement instrument. Turn on the EUT and connect it to measurement instrument. Then set it to any one convenient frequency within its operating range. Set a reference level on the measuring instrument equal to the highest peak value.
3. Measure the frequency difference of two frequencies that were attenuated 20 dB from the reference level. Record the frequency difference as the emission bandwidth.
4. Repeat above procedures until all frequencies measured were complete.

Limit

Limit [kHz]

N/A

20 dB bandwidth and 99% Occupied Bandwidth

Bluetooth Mode GFSK Modulation test result

Frequency MHz	20 dB Bandwidth kHz	99% Bandwidth kHz	Limit kHz	Result
2402	1119	869	--	Pass
2441	1116	866	--	Pass
2480	1116	866	--	Pass

Low channel 2402MHz

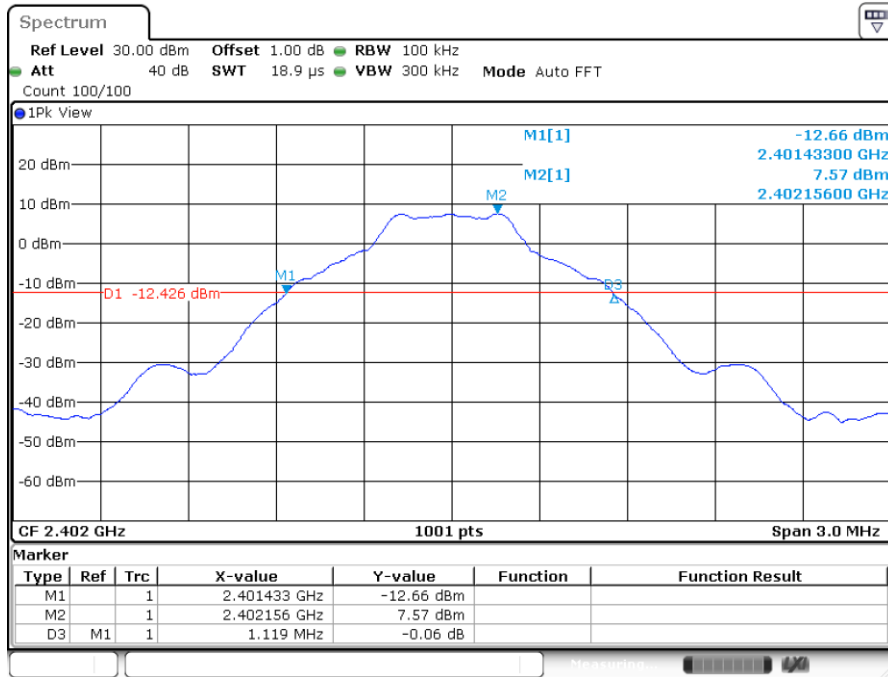

Date: 18.AUG.2020 17:34:16



Date: 18.AUG.2020 17:34:27

Middle channel 2441MHz

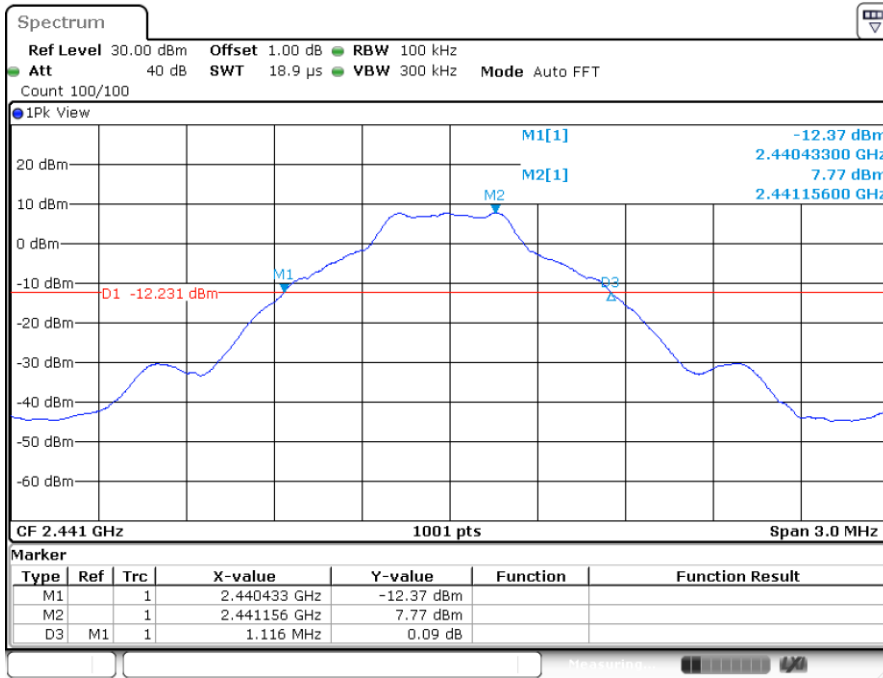

Date: 18.AUG.2020 17:35:45

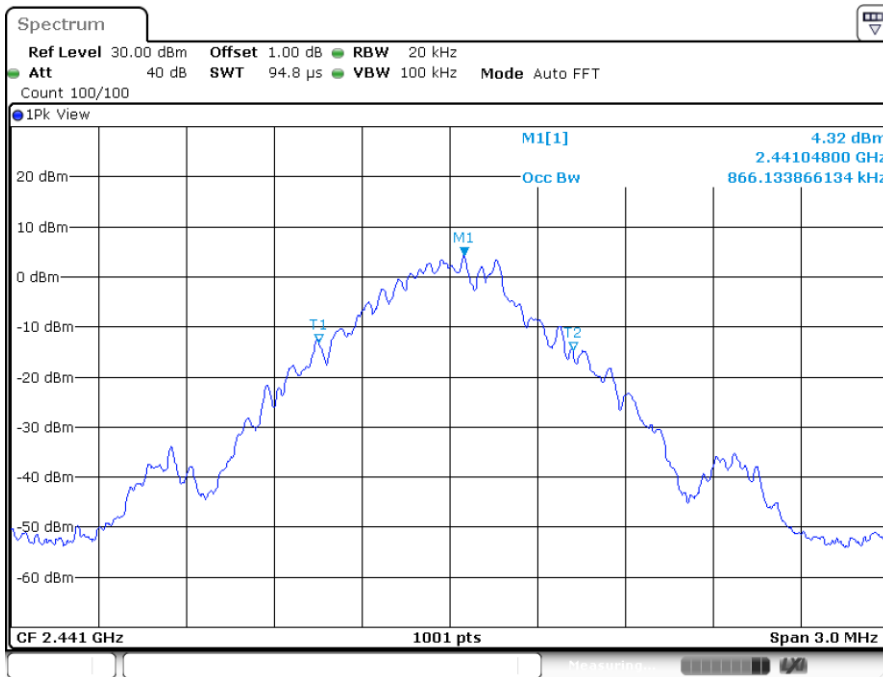

Date: 18.AUG.2020 17:35:55

High channel 2480MHz

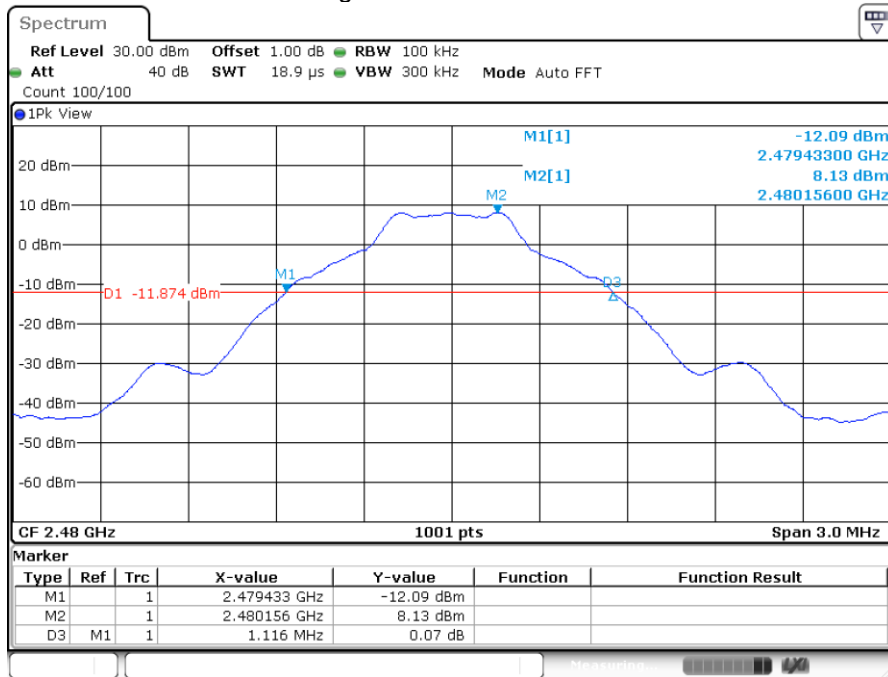

Date: 18.AUG.2020 17:37:39

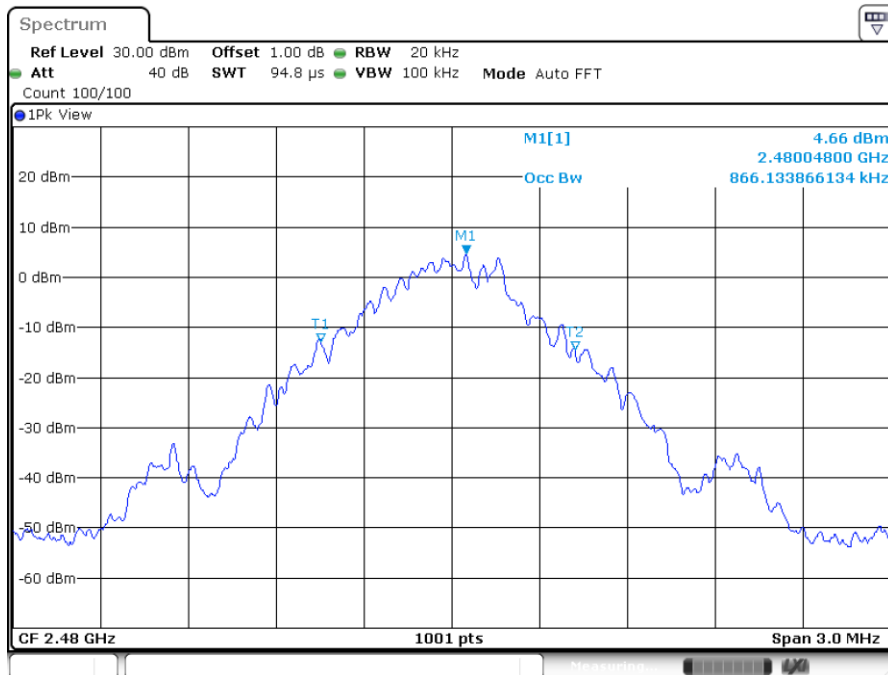

Date: 18.AUG.2020 17:37:50

20 dB bandwidth and 99% Occupied Bandwidth

Bluetooth Mode $\pi/4$ -DQPSK Modulation test result

Frequency MHz	20 dB Bandwidth kHz	99% Bandwidth kHz	Limit kHz	Result
2402	1113	809	--	Pass
2441	1110	803	--	Pass
2480	1113	803	--	Pass

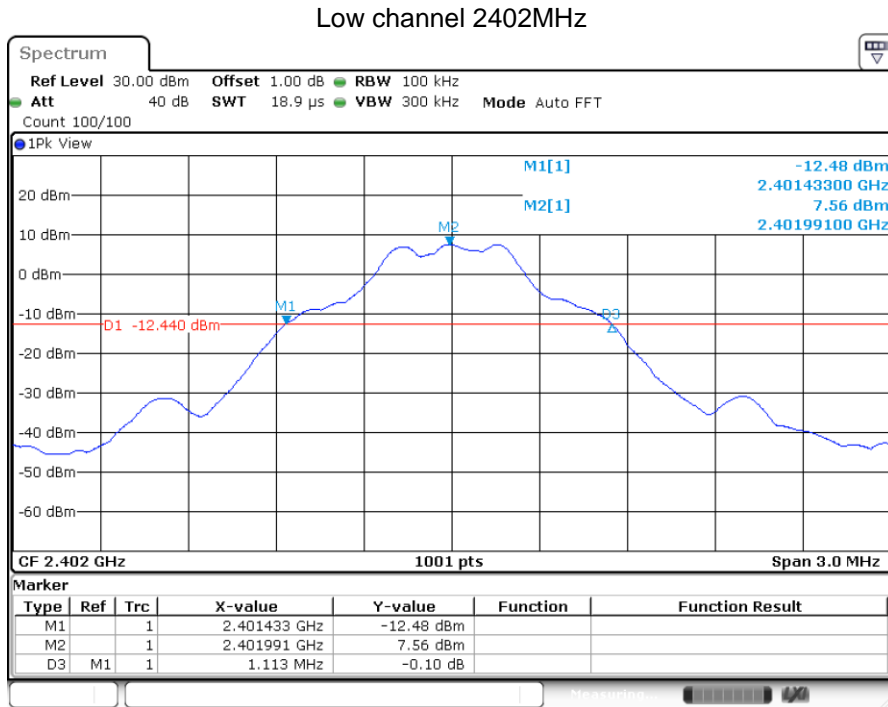

Date: 18.AUG.2020 17:39:40

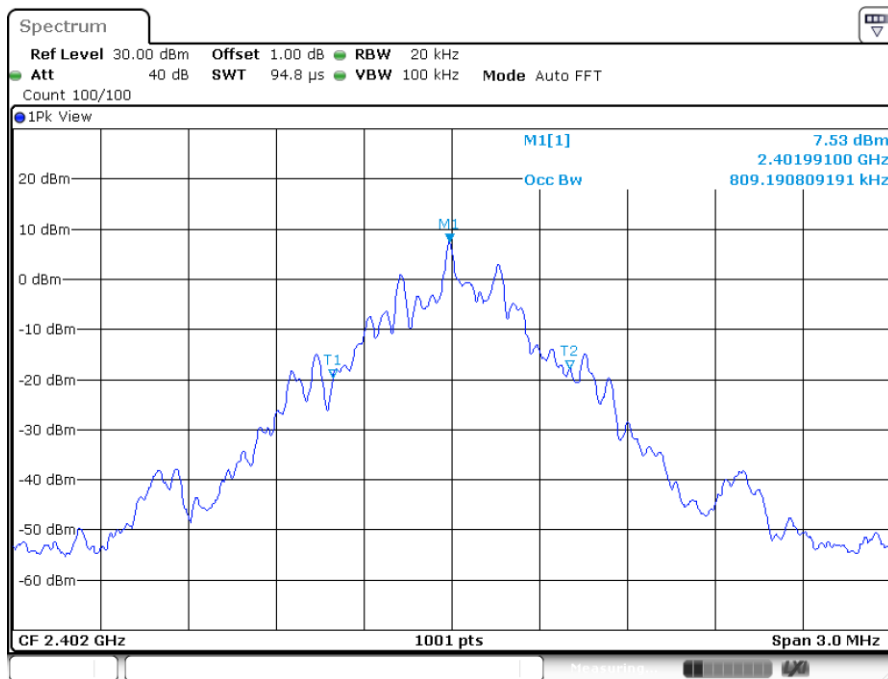

Date: 18.AUG.2020 17:39:50

Middle channel 2441MHz

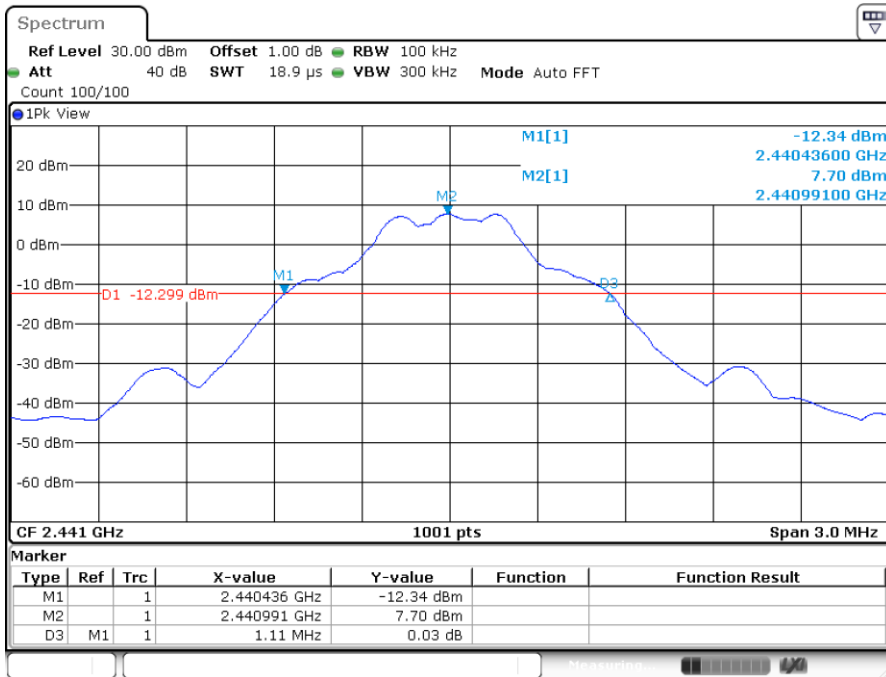

Date: 18.AUG.2020 17:42:01

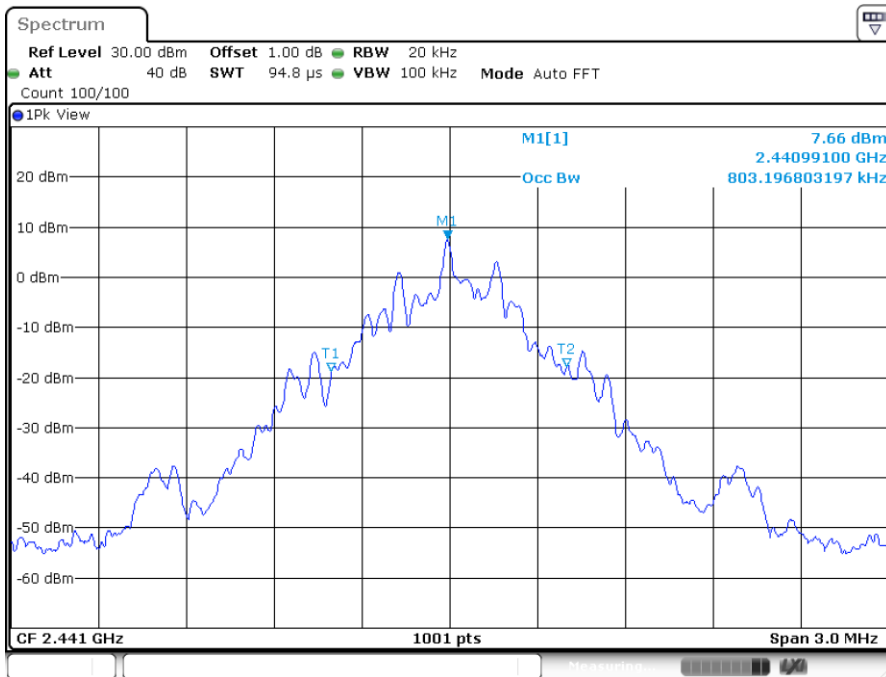

Date: 18.AUG.2020 17:42:11

High channel 2480MHz

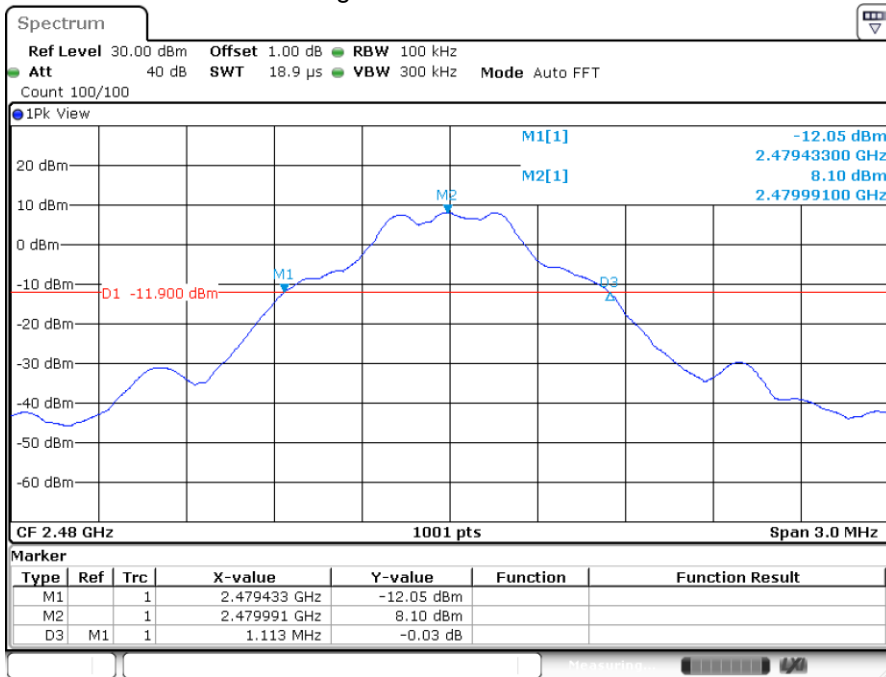

Date: 18.AUG.2020 17:45:40

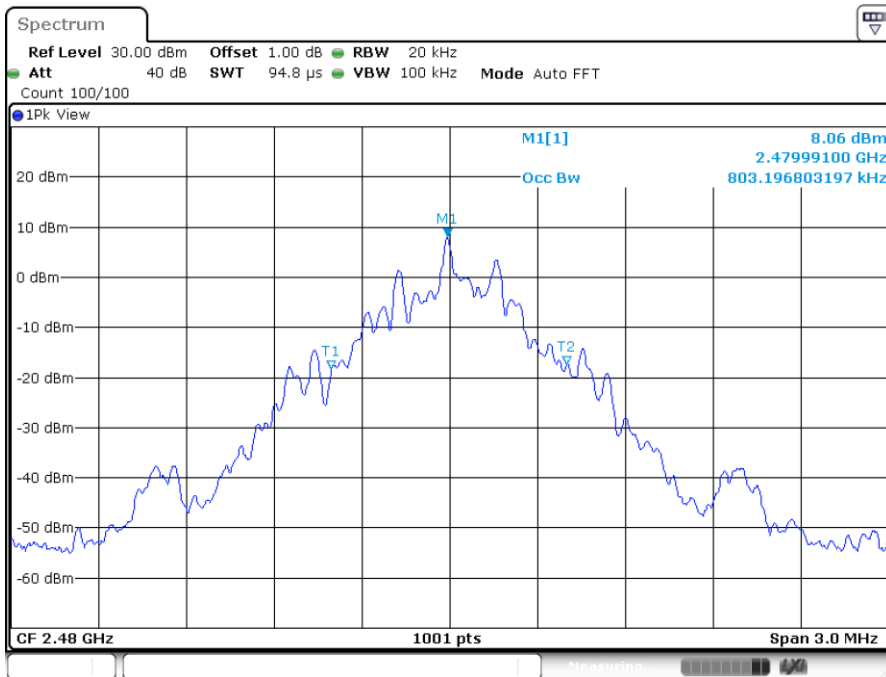

Date: 18.AUG.2020 17:45:51

20 dB bandwidth and 99% Occupied Bandwidth

Bluetooth Mode 8DPSK Modulation test result

Frequency MHz	20 dB Bandwidth kHz	99% Bandwidth kHz	Limit kHz	Result
2402	1107	782	--	Pass
2441	1104	773	--	Pass
2480	1104	773	--	Pass

Low channel 2402MHz

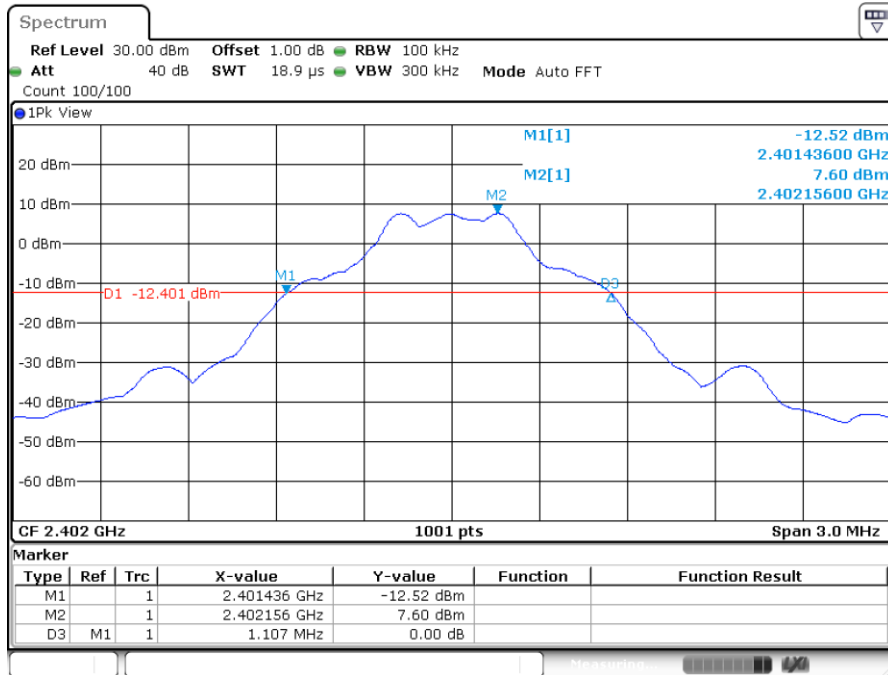

Date: 18.AUG.2020 17:48:30



Date: 18.AUG.2020 17:48:40

Middle channel 2441MHz

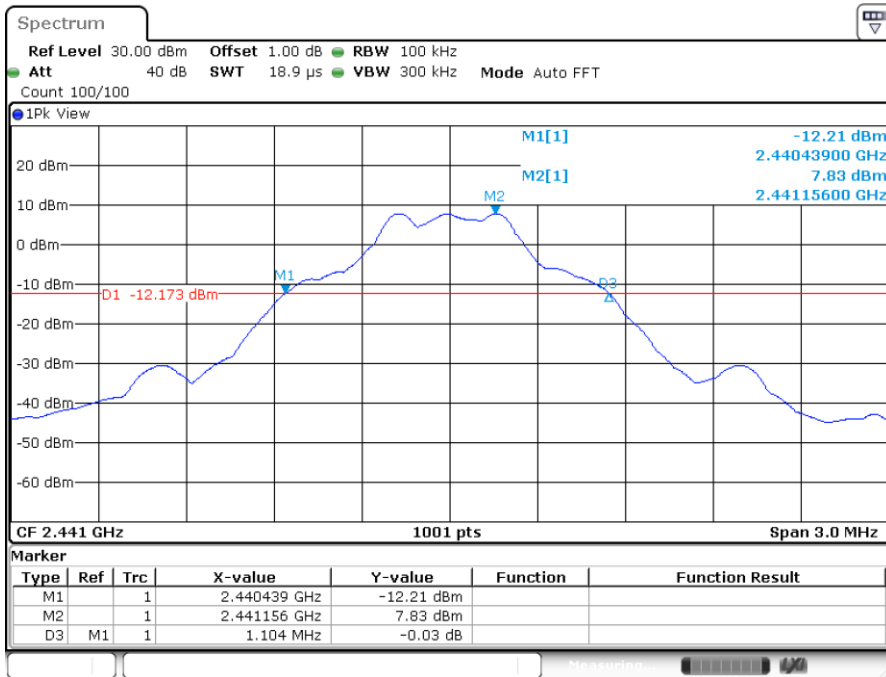

Date: 18.AUG.2020 17:50:55

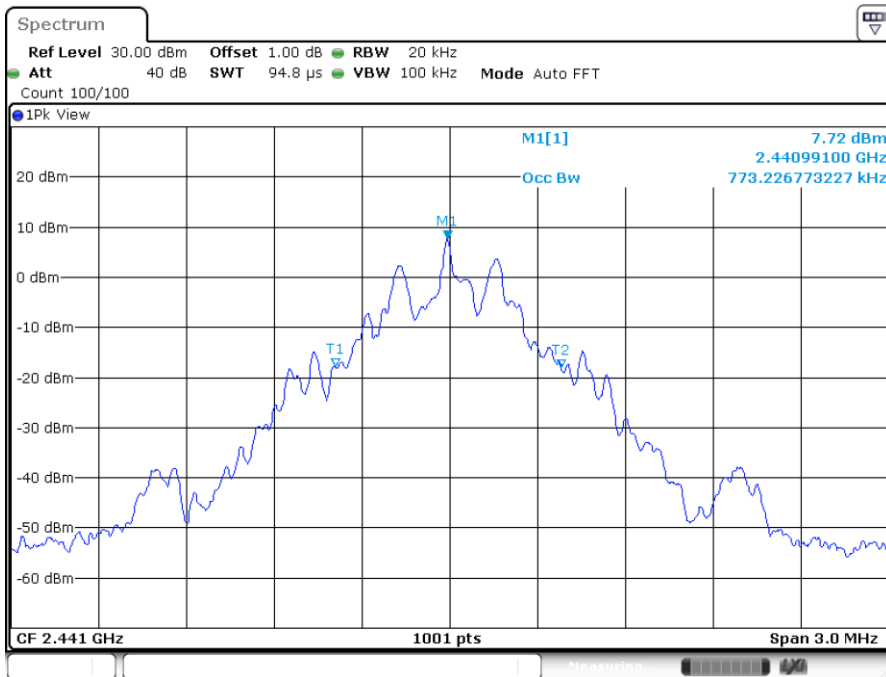

Date: 18.AUG.2020 17:51:06

High channel 2480MHz

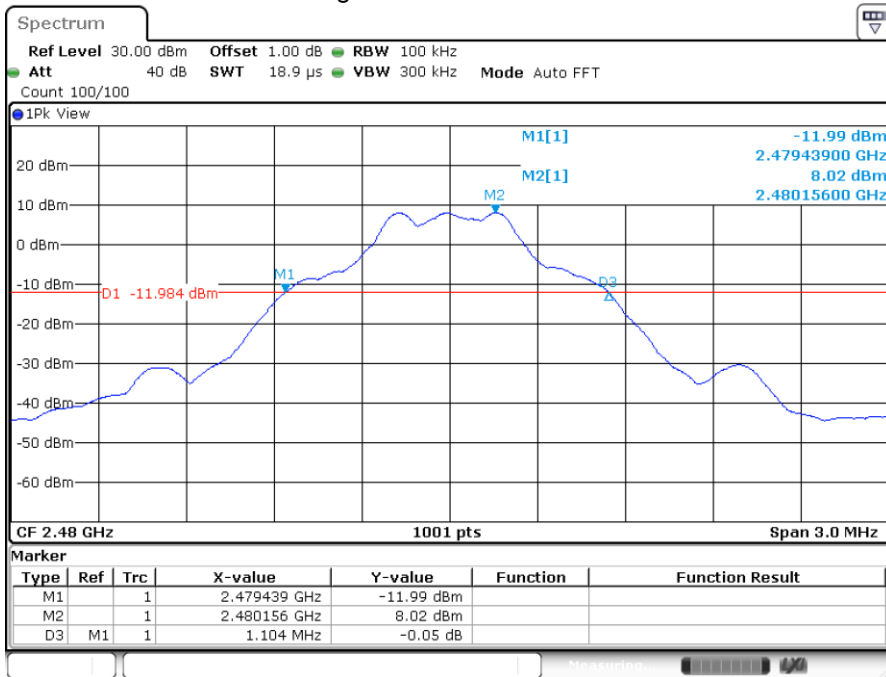

Date: 18.AUG.2020 17:53:55

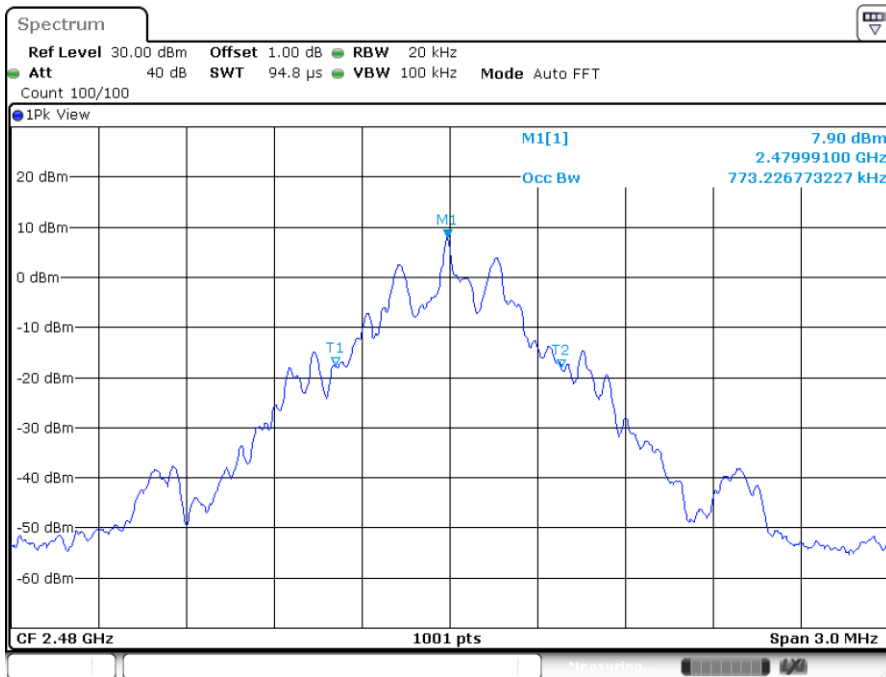

Date: 18.AUG.2020 17:54:05



9.3 Carrier Frequency Separation

Test Method

1. Use the following spectrum analyzer settings:
Span = wide enough to capture the peaks of two adjacent channels, RBW \geq 1% of the span, VBW) \geq RBW, Sweep = auto, Detector function = peak
2. By using the Max-Hold function record the separation of two adjacent channels.
3. Measure the frequency difference of these two adjacent channels by spectrum analyzer marker function.
4. Repeat above procedures until all frequencies measured were complete.

Limit

Limit
kHz

≥25KHz or 2/3 of the 20 dB bandwidth which is greater

GFSK Modulation Limit

Test Mode	2/3 of 20 dB Bandwidth kHz
DH5	744
2DH5	740
3DH5	736

Carrier Frequency Separation

Test result: The measurement was performed with the typical configuration (normal hopping status), here GFSK modulation mode was used to show compliance.

GFSK Modulation test result

Test Mode	Carrier Frequency Separation kHz	Result
DH5	1000	Pass
2DH5	838	Pass
3DH5	1003	Pass

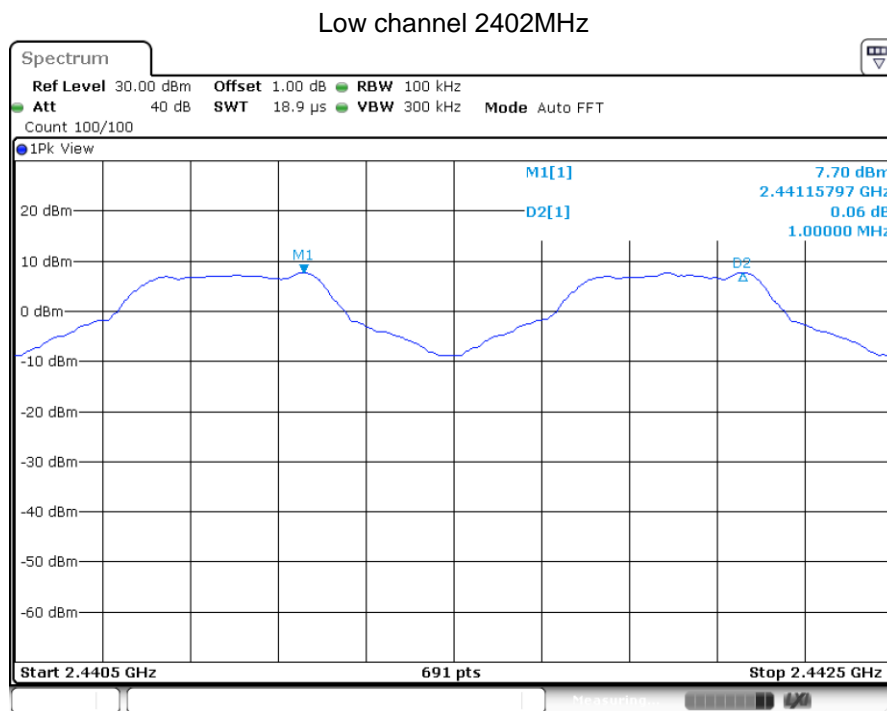

Date: 18.AUG.2020 17:57:03

Middle channel 2441MHz

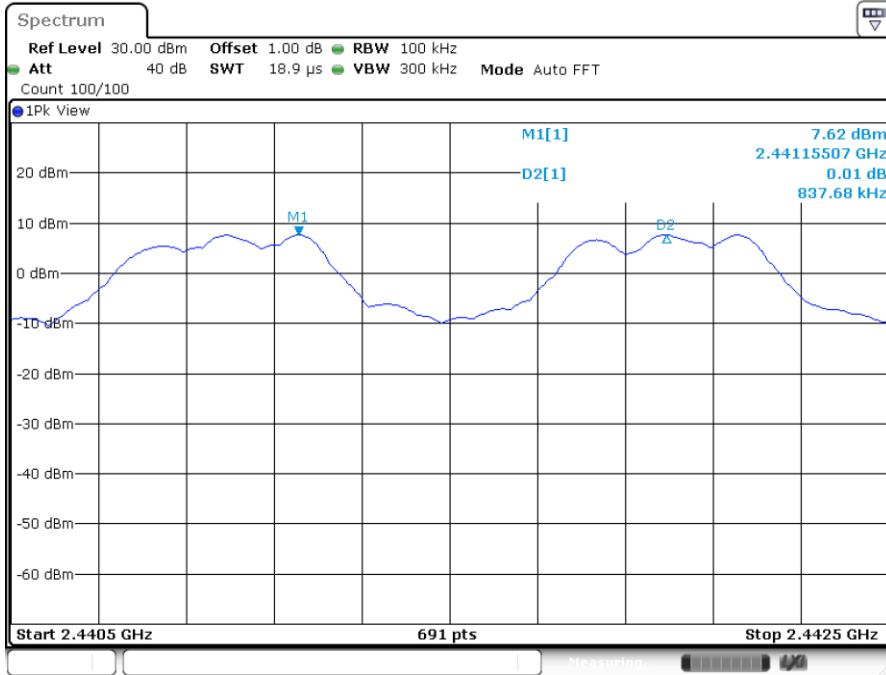

Date: 18.AUG.2020 18:11:32

High channel 2480MHz

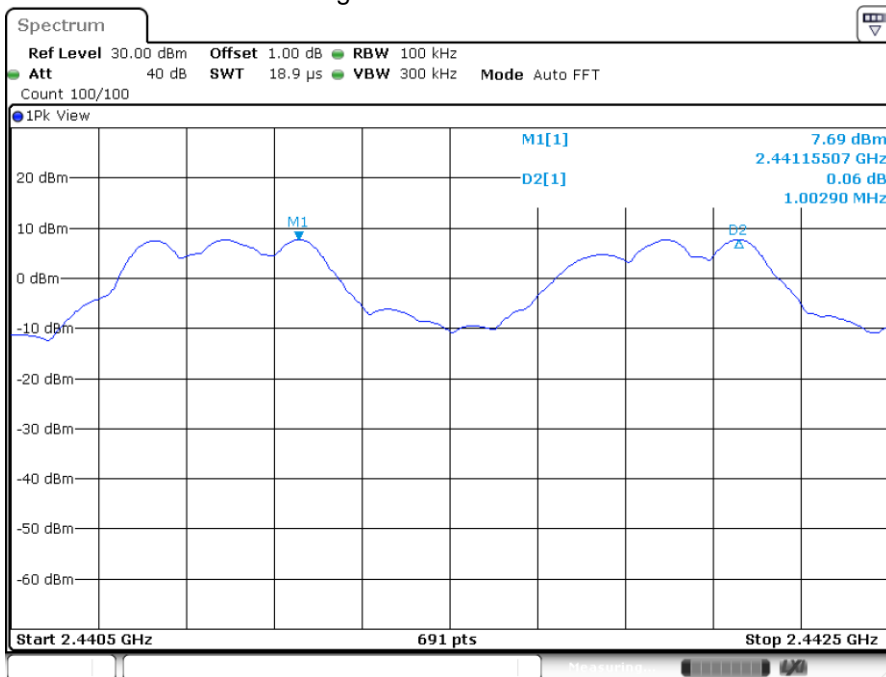

Date: 18.AUG.2020 18:20:26

9.4 Number of hopping frequencies

Test Method

1. Use the following spectrum analyzer settings:
Span = wide enough to capture the peaks of two adjacent channels, $RBW \geq 1\%$ of the span, $VBW \geq RBW$, Sweep = auto, Detector function = peak
2. Set the spectrum analyzer on Max-Hold Mode, and then keep the EUT in hopping mode.
3. Record all the signals from each channel until each one has been recorded.
4. Repeat above procedures until all frequencies measured were complete.

Limit

**Limit
number**

≥ 15

Number of hopping frequencies

Test result: The measurement was performed with the typical configuration (normal hopping status), and the total hopping channels is constant for the all modulation mode according with the Bluetooth Core Specification. Here GFSK modulation mode was used to show compliance.

Number of hopping frequencies	Result
79	Pass

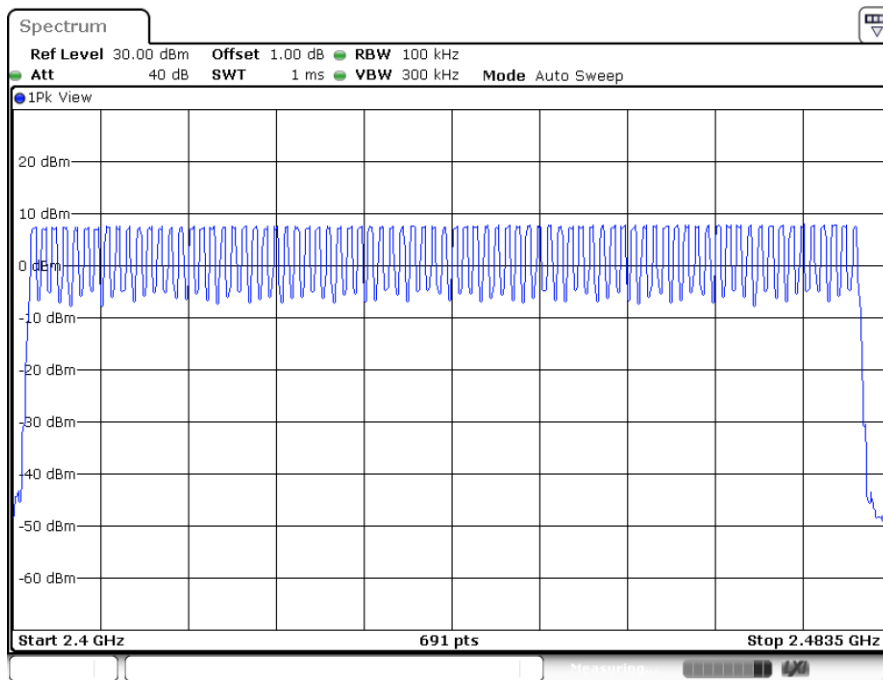

Date: 18.AUG.2020 17:58:55

9.5 Dwell Time

Test Method

1. Connect EUT antenna terminal to the spectrum analyzer with a low loss cable.
Equipment mode: Spectrum analyzer
2. RBW: 1MHz; VBW: 1MHz; SPAN: Zero Span
3. Adjust the center frequency of spectrum analyzer on any frequency be measured.
4. Measure the Dwell Time by spectrum analyzer Marker function.
5. Repeat above procedures until all frequencies measured were complete.

Limit

The average time of occupancy on any frequency shall not be greater than 0.4 seconds within a period of 0.4 seconds multiplied by the number of hopping channels employed.

Dwell Time

Dwell time

The maximum dwell time shall be 0.4 s.

According to the Bluetooth Core Specification, the worse result (DH5 mode) was reported to show compliance.

The Dwell Time = Burst Width * Total Hops. The detailed calculations are showed as follows:
 The duration for dwell time calculation: 0.4 [s] * hopping number = 0.4 [s] * 79 [ch] = 31.6 [s*ch];

Test Result

TestMode	Channel	BurstWidth	TotalHops	Result	Limit	Verdict
DH5	Hop	2.87	110	0.316	<=0.4	PASS
2DH5	Hop	2.88	110	0.317	<=0.4	PASS
3DH5	Hop	2.88	110	0.317	<=0.4	PASS

GFSK Modulation

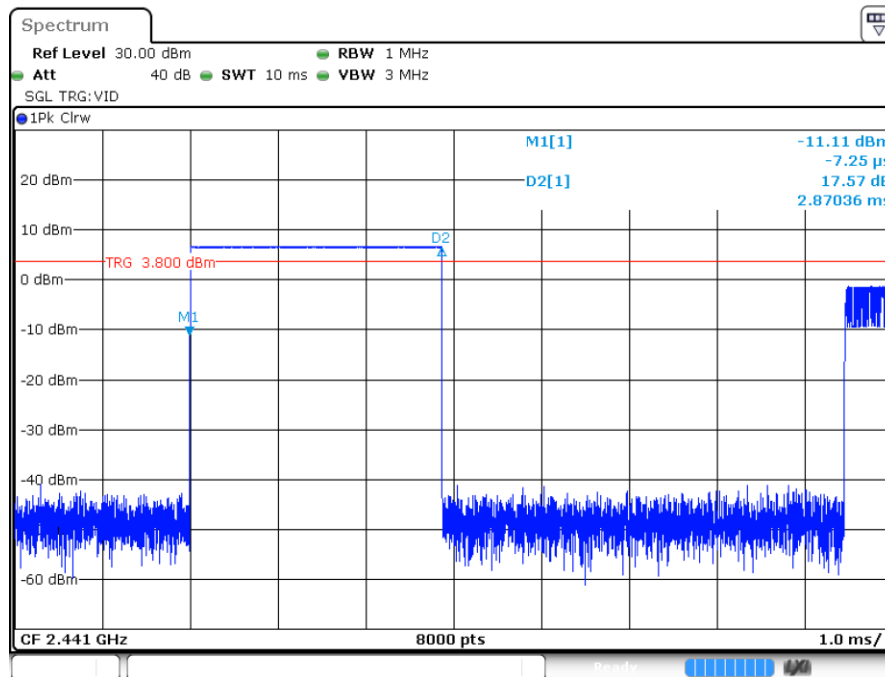

Date: 18.AUG.2020 17:59:07

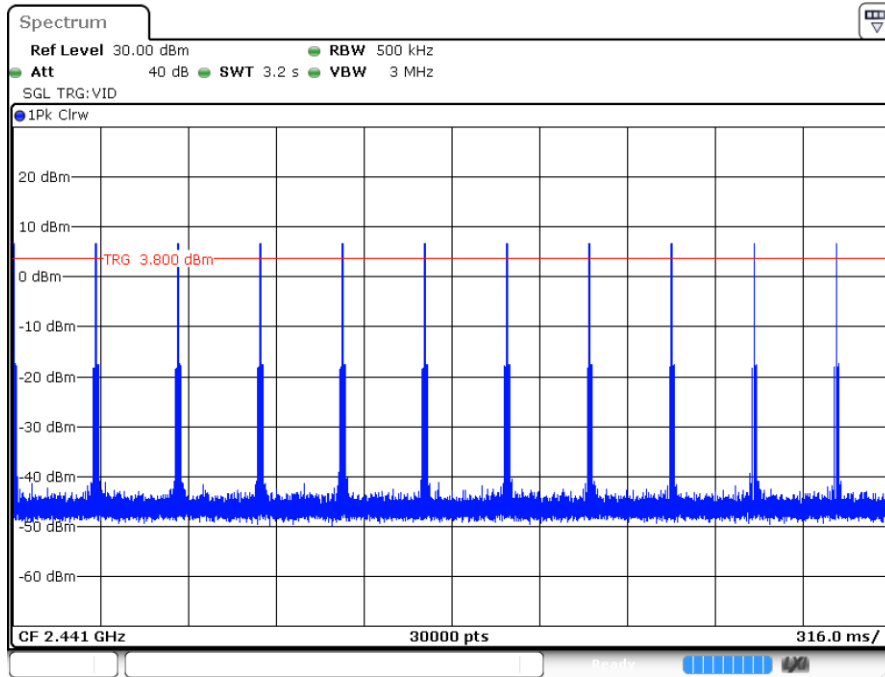

Date: 18.AUG.2020 17:59:12

DH5

$\pi/4$ -DQPSK Modulation

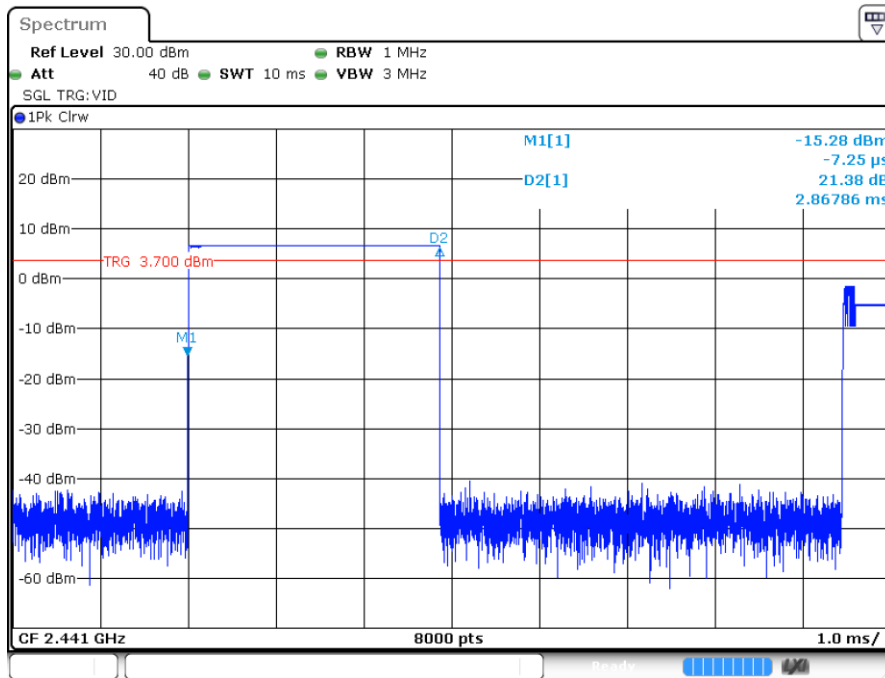

Date: 18.AUG.2020 18:12:49

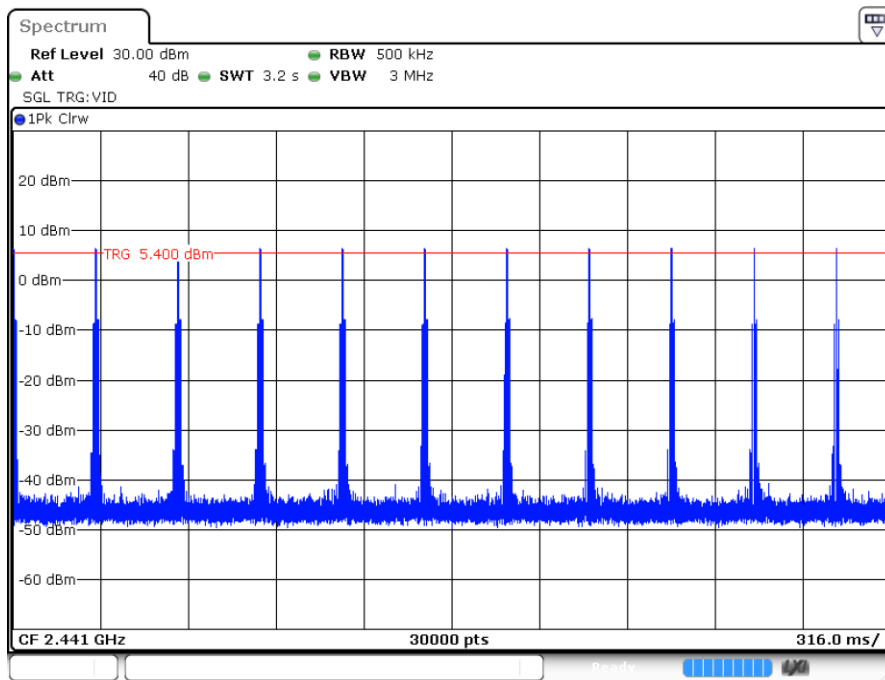

Date: 23.AUG.2020 15:33:07

2DH5

8-DPSK Modulation

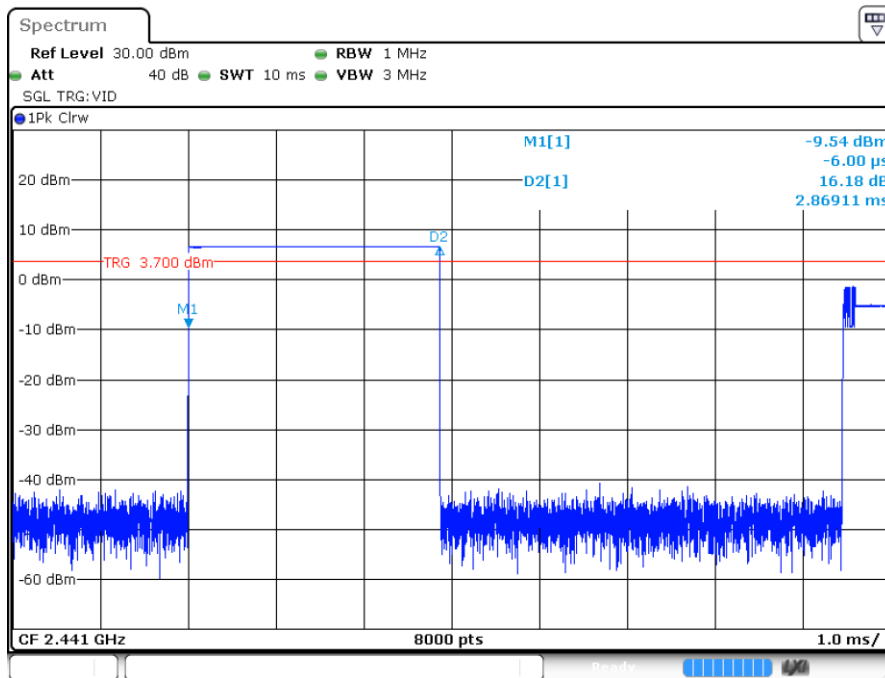

Date: 18.AUG.2020 18:21:10

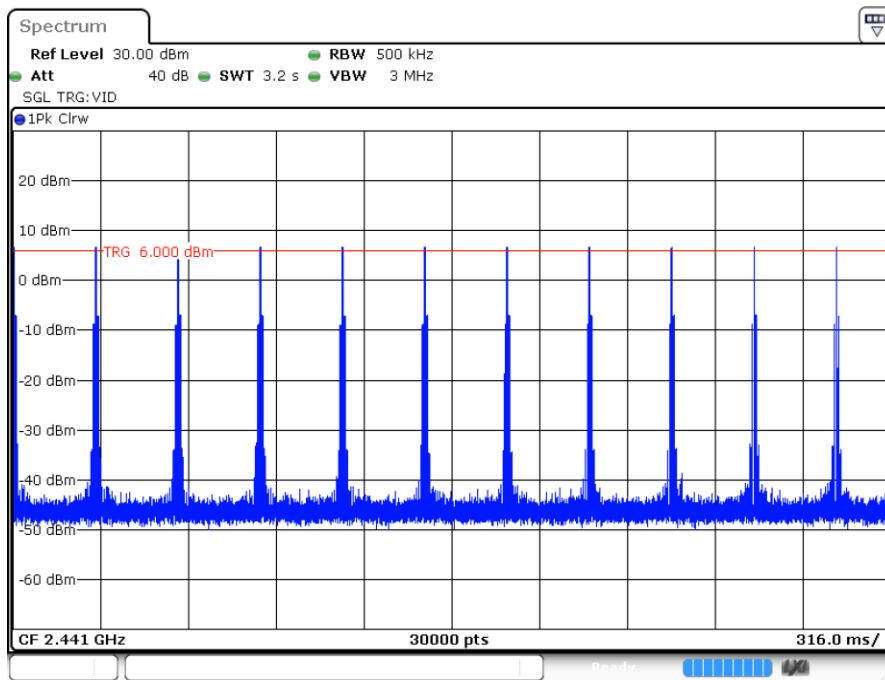

Date: 23.AUG.2020 15:37:18

3DH5

9.6 Spurious RF conducted emissions

Test Method

1. Use the following spectrum analyzer settings:
Span = wide enough to capture the peak level of the in-band emission and all spurious emissions (e.g., harmonics) from the lowest frequency generated in the EUT up through the 10th harmonic. Typically, several plots are required to cover this entire span.
RBW = 100 kHz, VBW ≥ RBW, Sweep = auto, Detector function = peak, Trace = max hold
2. Allow the trace to stabilize. Set the marker on the peak of any spurious emission recorded.
3. The level displayed must comply with the limit specified in this Section. Submit these plots.
4. Repeat above procedures until all frequencies measured were complete.

Limit

Frequency Range MHz	Limit (dBc)
30-25000	-20



Spurious RF conducted emissions

TestMode	Antenna	Channel(MHz)	FreqRange(MHz)	RefLevel(MHz)	Result(dBm)	Limit(dBm)	Verdict
DH5	Ant1	2402	Reference	7.64	7.64	---	PASS
			30~1000	30~1000	-67.85	<=-12.36	PASS
			1000~26500	1000~26500	-42.04	<=-12.36	PASS
		2441	Reference	7.71	7.71	---	PASS
			30~1000	30~1000	-68.23	<=-12.29	PASS
			1000~26500	1000~26500	-41.57	<=-12.29	PASS
		2480	Reference	8.17	8.17	---	PASS
			30~1000	30~1000	-67.49	<=-11.83	PASS
			1000~26500	1000~26500	-41.15	<=-11.83	PASS
2DH5	Ant1	2402	Reference	7.62	7.62	---	PASS
			30~1000	30~1000	-67.33	<=-12.38	PASS
			1000~26500	1000~26500	-41.96	<=-12.38	PASS
		2441	Reference	7.64	7.64	---	PASS
			30~1000	30~1000	-68.54	<=-12.36	PASS
			1000~26500	1000~26500	-41.35	<=-12.36	PASS
		2480	Reference	8.14	8.14	---	PASS
			30~1000	30~1000	-68.13	<=-11.86	PASS
			1000~26500	1000~26500	-41.1	<=-11.86	PASS
3DH5	Ant1	2402	Reference	7.67	7.67	---	PASS
			30~1000	30~1000	-61	<=-12.33	PASS
			1000~26500	1000~26500	-41.84	<=-12.33	PASS
		2441	Reference	7.77	7.77	---	PASS
			30~1000	30~1000	-63.76	<=-12.23	PASS
			1000~26500	1000~26500	-41.63	<=-12.23	PASS
		2480	Reference	8.06	8.06	---	PASS
			30~1000	30~1000	-68.14	<=-11.94	PASS
			1000~26500	1000~26500	-41.29	<=-11.94	PASS

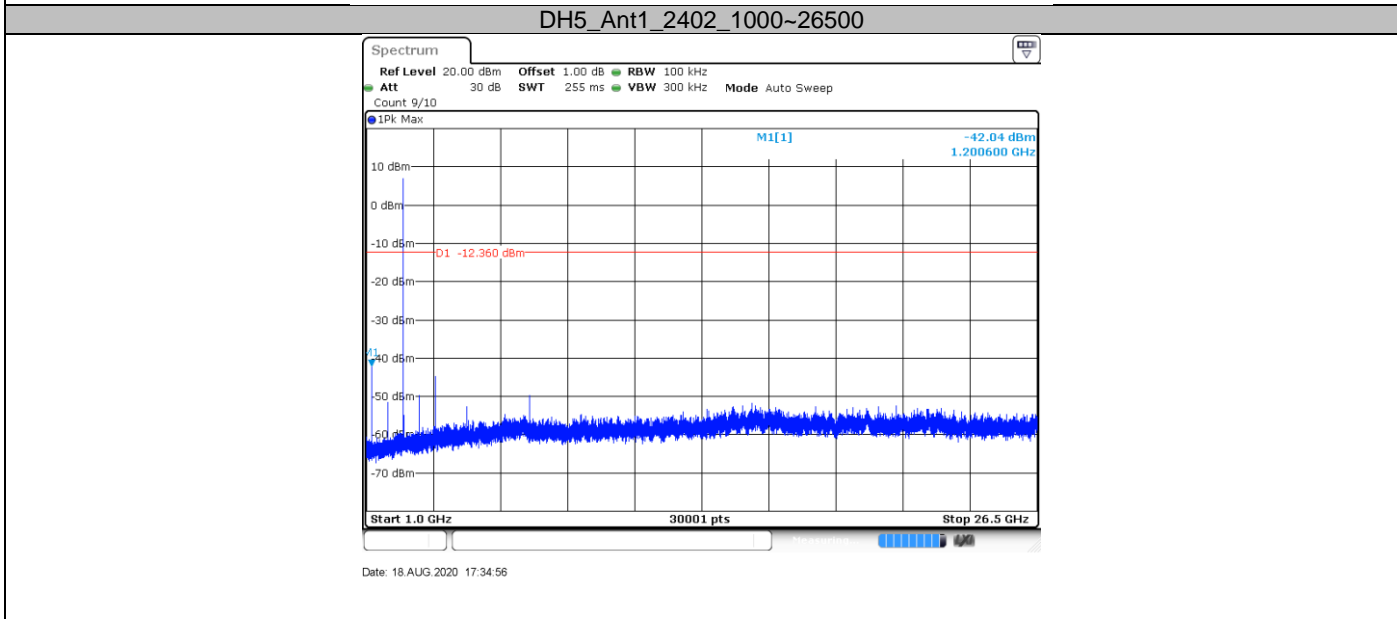
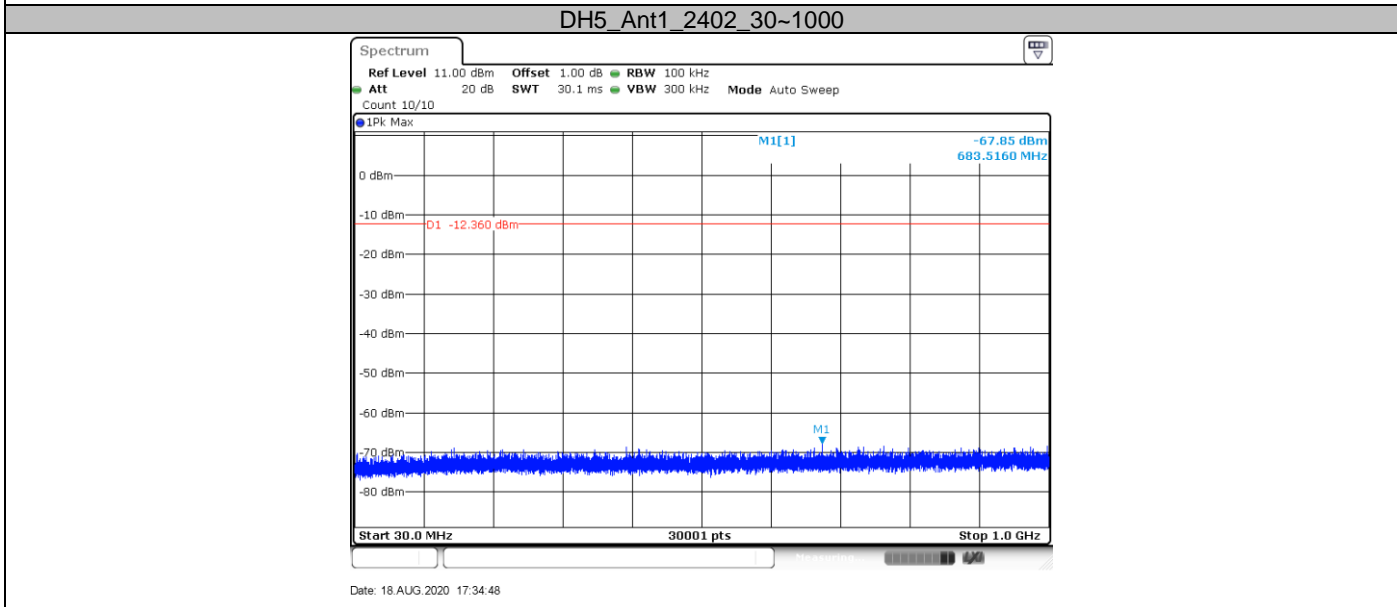
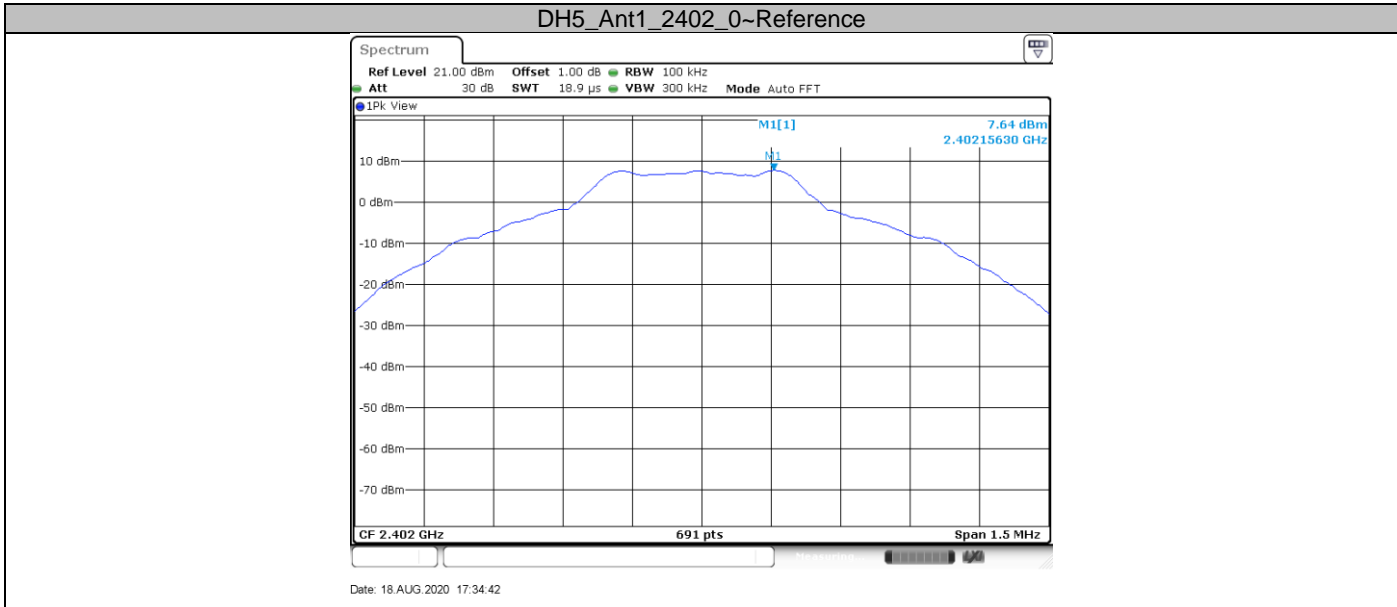

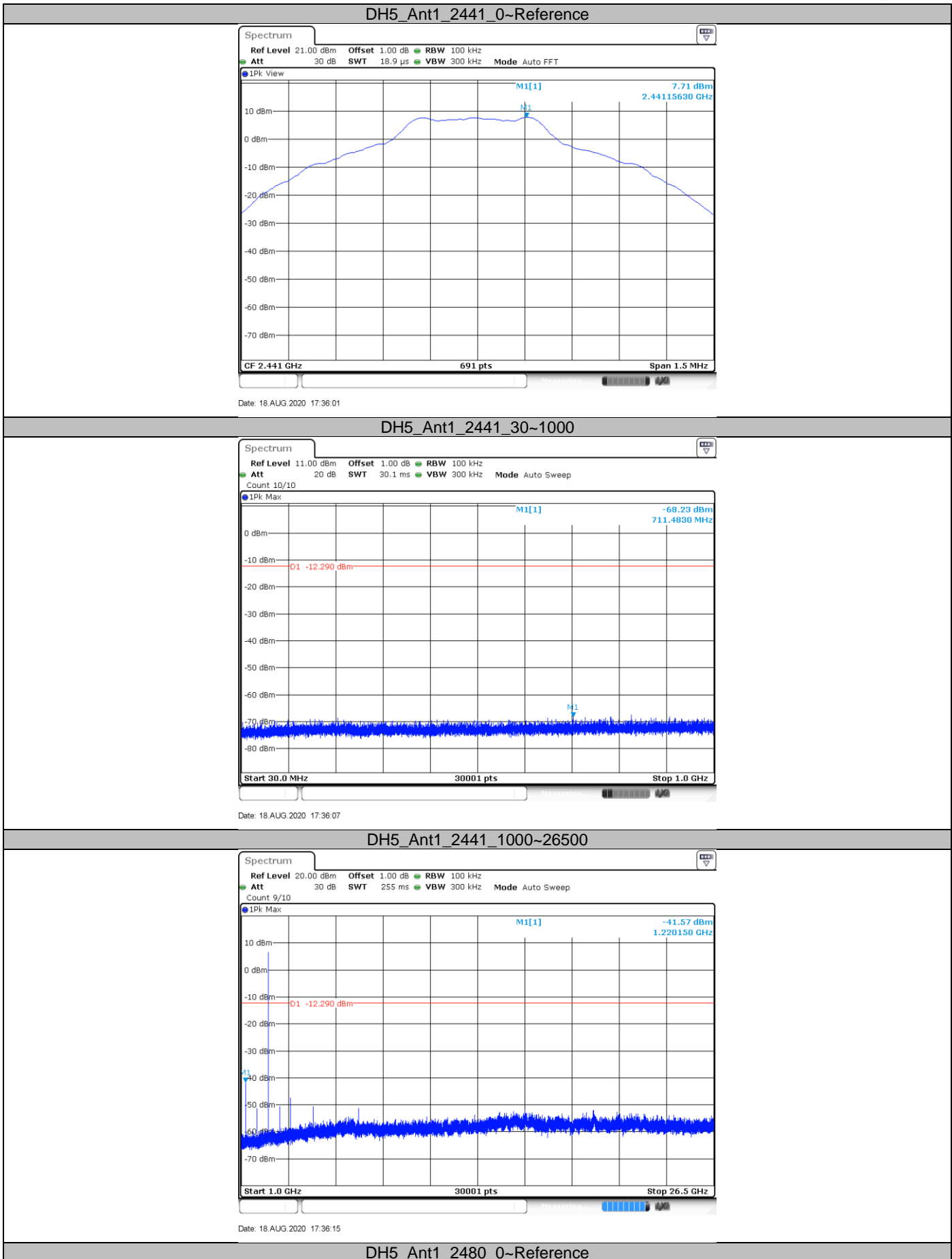

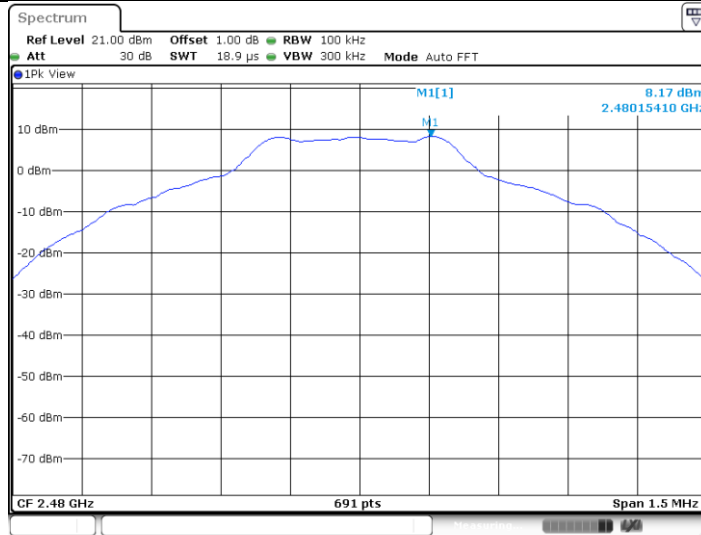

Date: 18 AUG 2020 17:38:05

DH5_Ant1_2480_30~1000

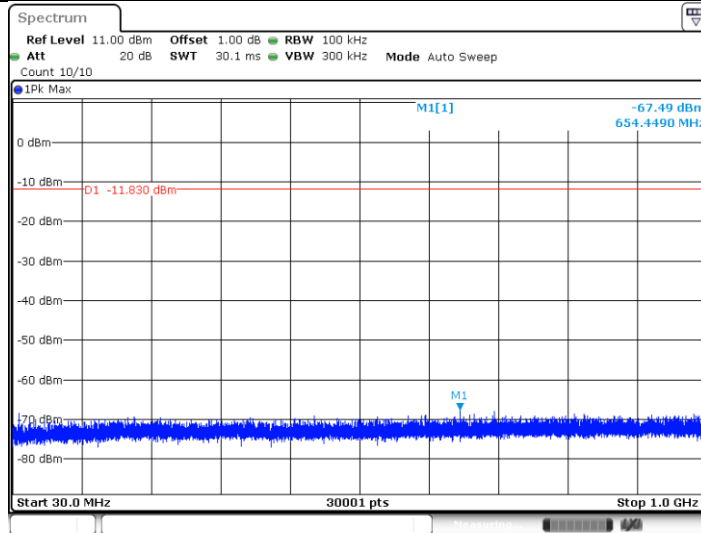

Date: 18 AUG 2020 17:38:11

DH5_Ant1_2480_1000~26500

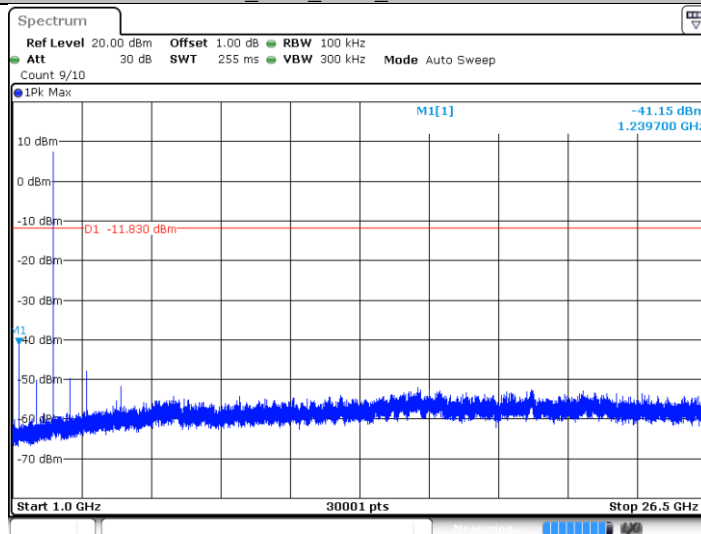

Date: 18 AUG 2020 17:38:18

2DH5_Ant1_2402_0~Reference

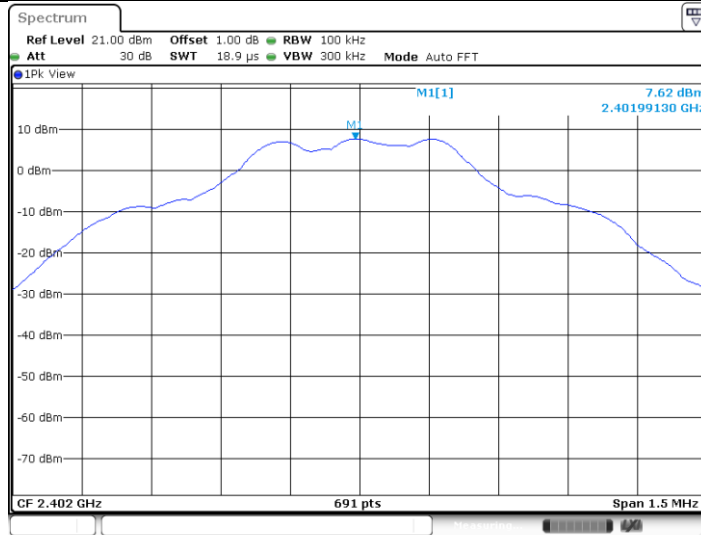

Date: 18 AUG 2020 17:40:05

2DH5_Ant1_2402_30~1000

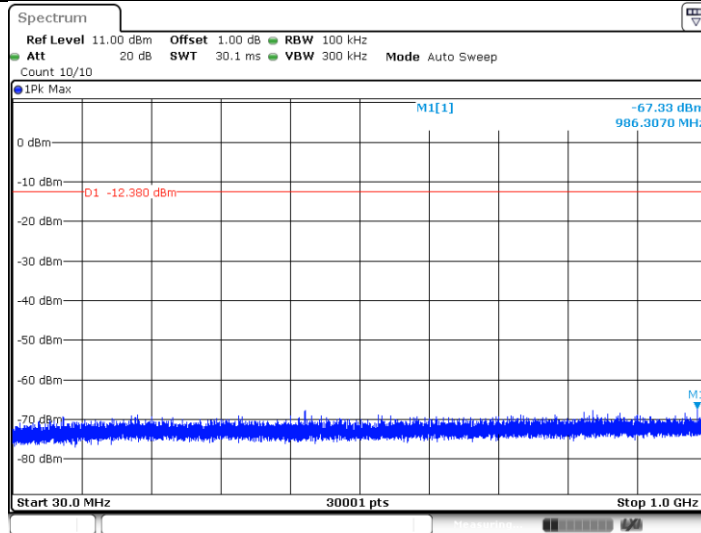

Date: 18 AUG 2020 17:40:11

2DH5_Ant1_2402_1000~26500

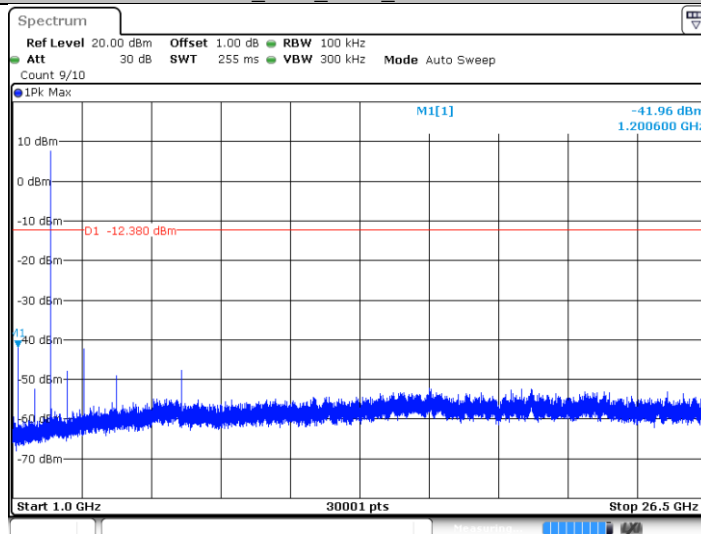

Date: 18 AUG 2020 17:40:19

2DH5_Ant1_2441_0~Reference

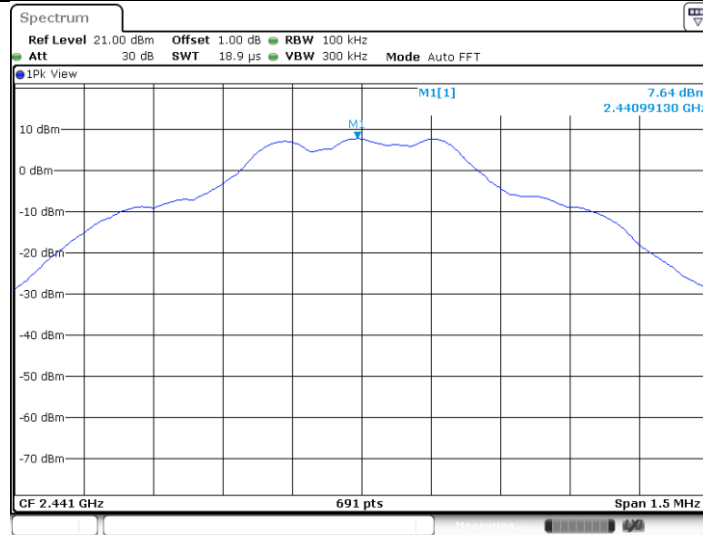

Date: 18 AUG 2020 17:42:17

2DH5_Ant1_2441_30~1000

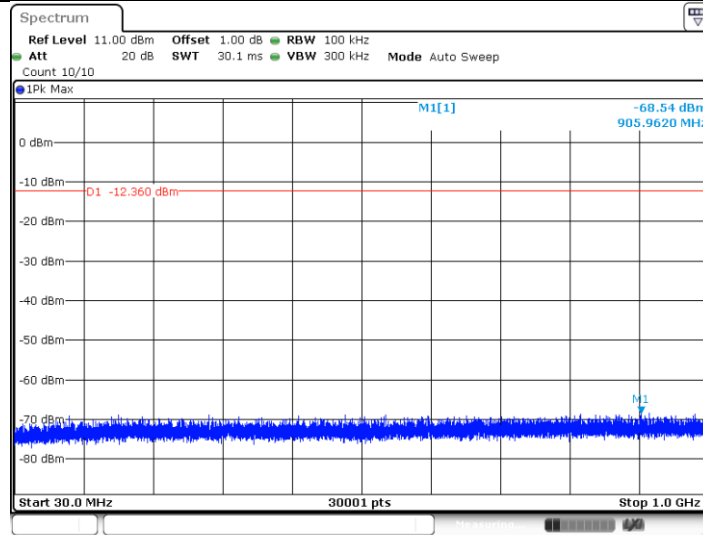

Date: 18 AUG 2020 17:42:23

2DH5_Ant1_2441_1000~26500

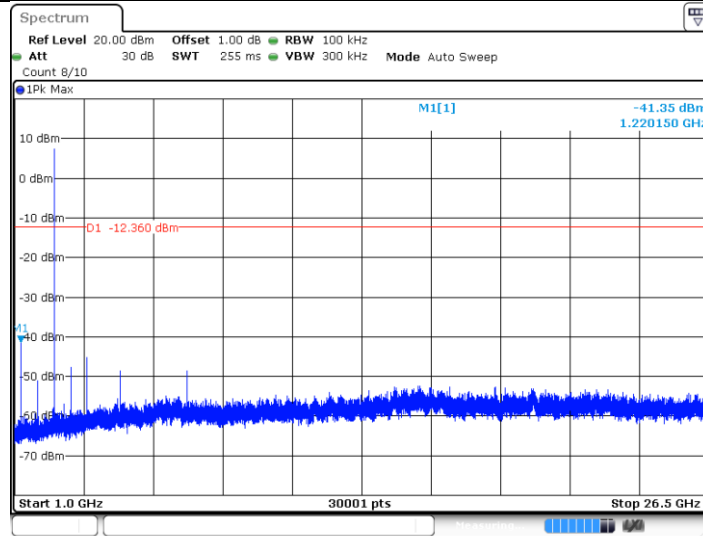

Date: 18 AUG 2020 17:42:31

2DH5_Ant1_2480_0~Reference

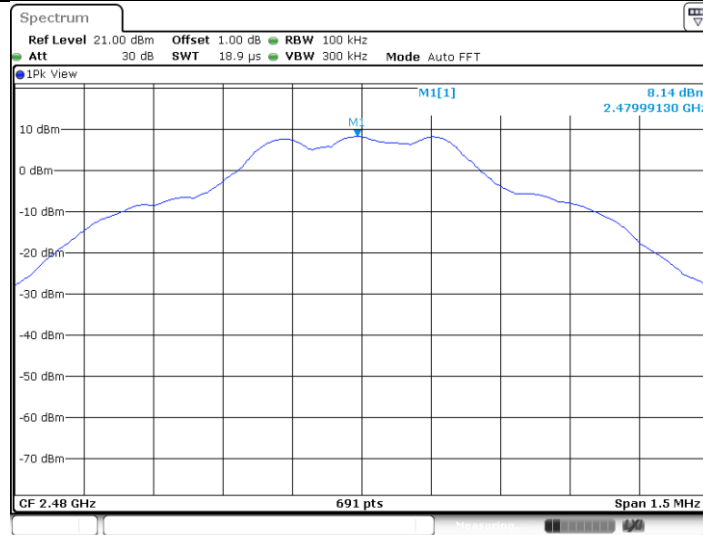

Date: 18 AUG 2020 17:46:06

2DH5_Ant1_2480_30~1000

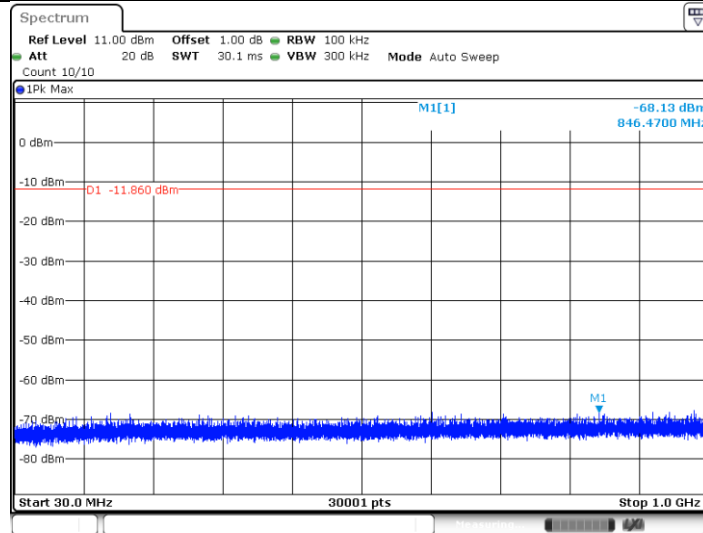

Date: 18 AUG 2020 17:46:12

2DH5_Ant1_2480_1000~26500

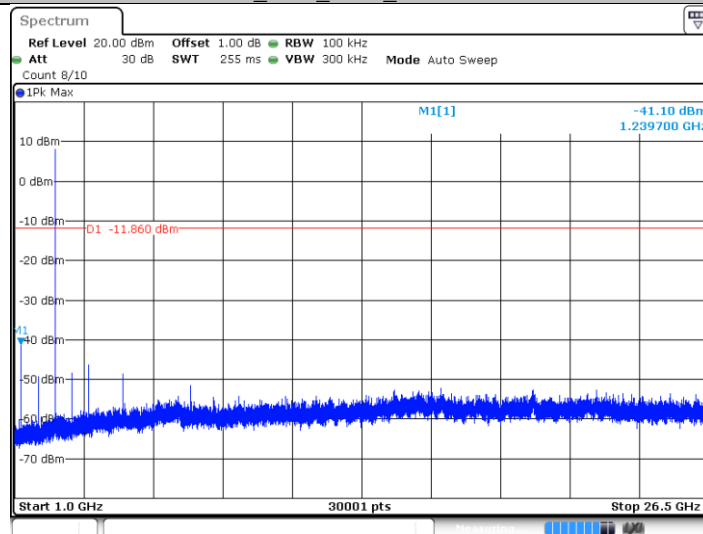

Date: 18 AUG 2020 17:46:20

3DH5_Ant1_2402_0~Reference

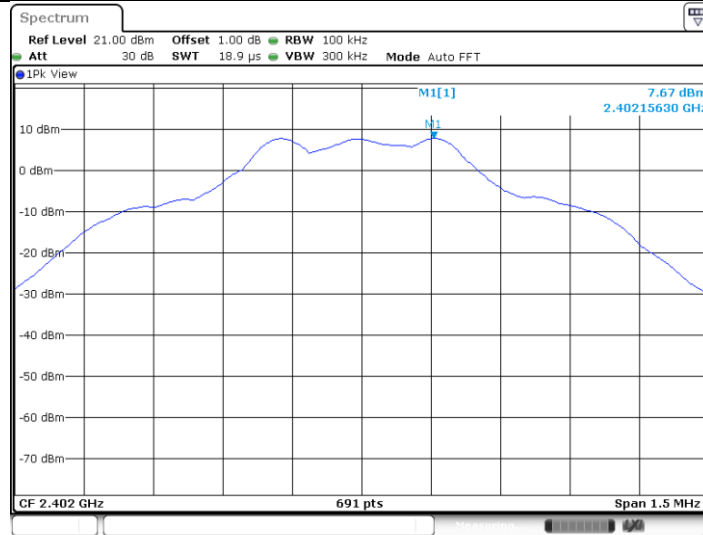

Date: 18 AUG 2020 17:48:55

3DH5_Ant1_2402_30~1000

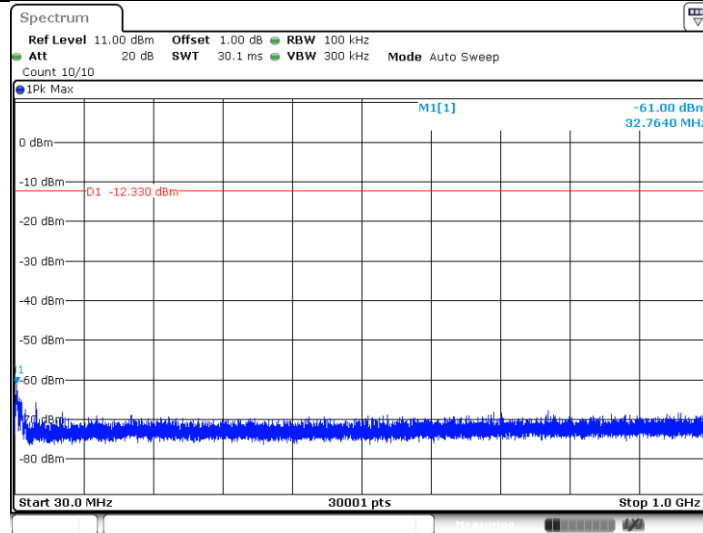

Date: 18 AUG 2020 17:49:01

3DH5_Ant1_2402_1000~26500

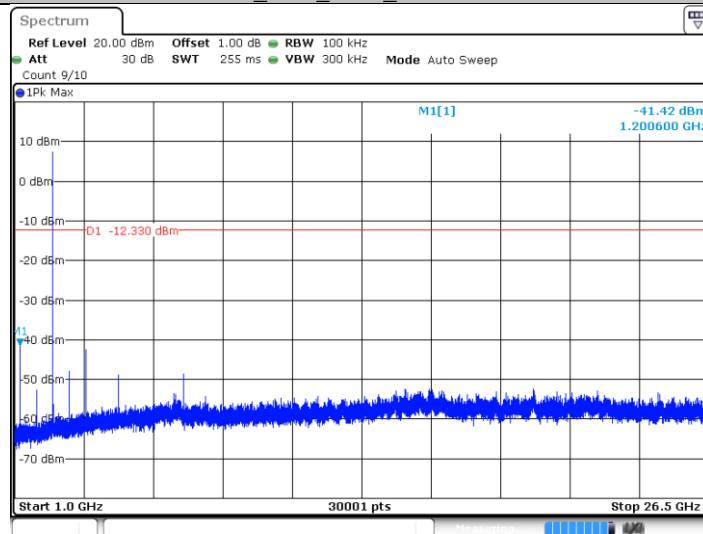

Date: 18 AUG 2020 17:49:09

3DH5_Ant1_2441_0~Reference

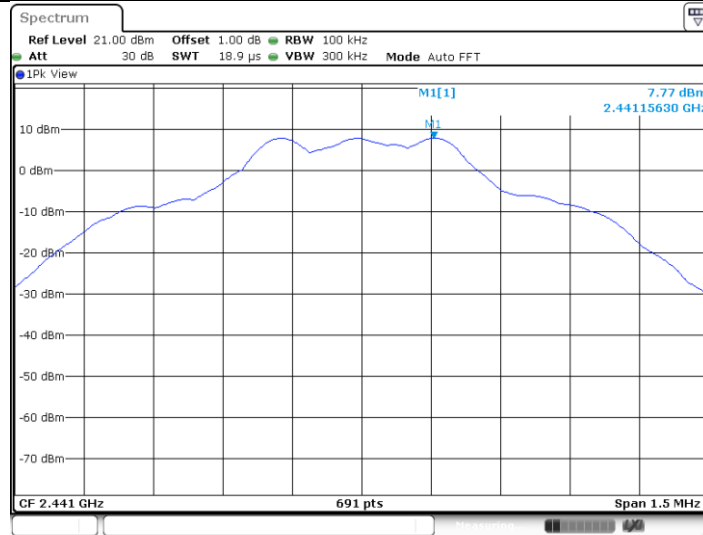

Date: 18 AUG 2020 17:51:11

3DH5_Ant1_2441_30~1000

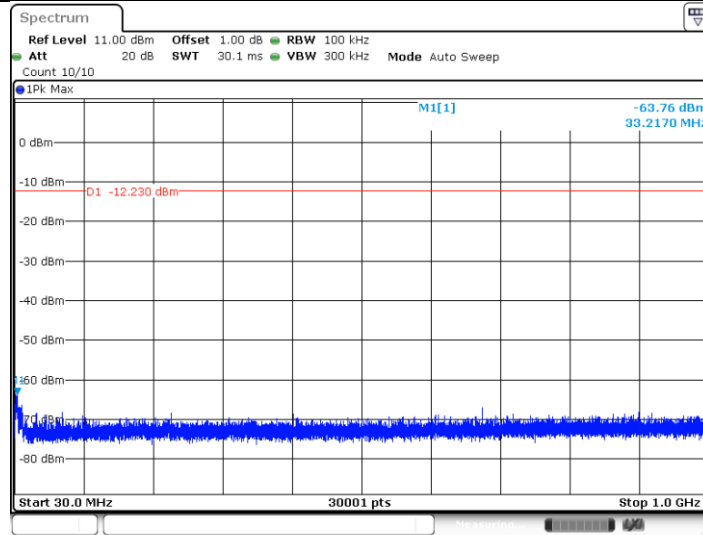

Date: 18 AUG 2020 17:51:17

3DH5_Ant1_2441_1000~26500

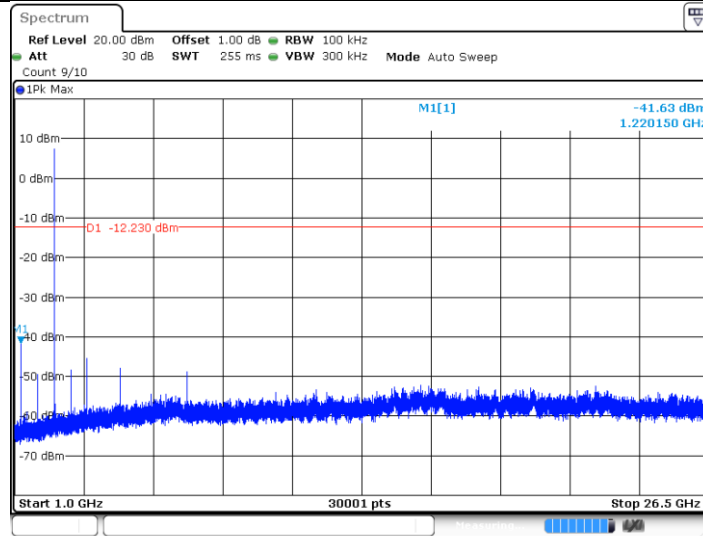

Date: 18 AUG 2020 17:51:25

3DH5_Ant1_2480_0~Reference

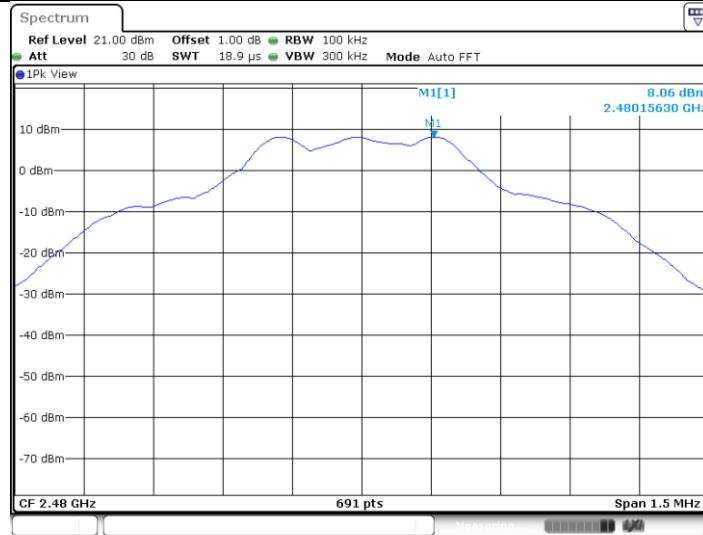

Date: 18 AUG 2020 17:54:20

3DH5_Ant1_2480_30~1000

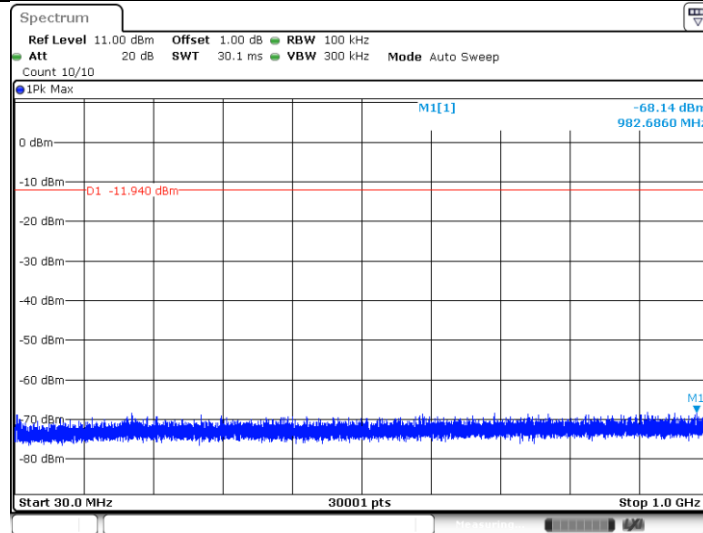

Date: 18 AUG 2020 17:54:26

3DH5_Ant1_2480_1000~26500

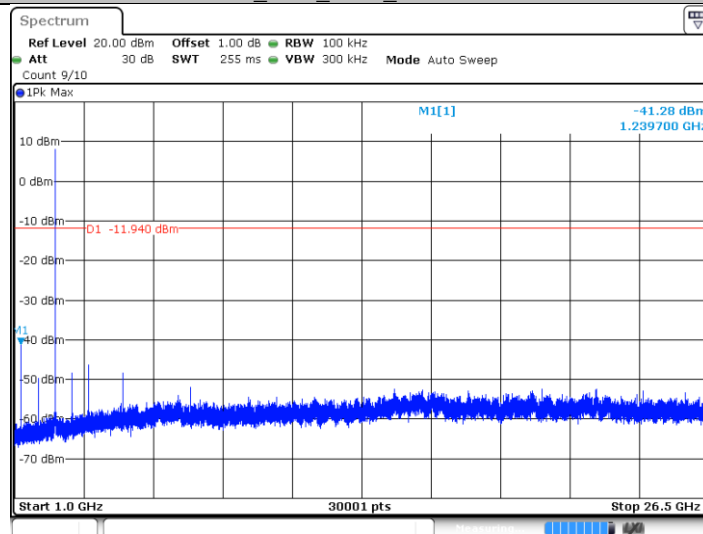

Date: 18 AUG 2020 17:54:34

9.7 Band edge testing

Test Method

- 1 Use the following spectrum analyzer settings:
Span = wide enough to capture the peak level of the in-band emission and all spurious
RBW = 100 kHz, VBW \geq RBW, Sweep = auto, Detector function = peak, Trace = max hold
- 2 Allow the trace to stabilize, use the peak and delta measurement to record the result.
- 3 The level displayed must comply with the limit specified in this Section. .
- 4 Repeat the test at the hopping off and hopping on mode, submit all the plots.

Limit:

In any 100 kHz bandwidth outside the frequency band in which the spread spectrum or digitally modulated device is operating, the RF power that is produced shall be at least 20 dB below that in the 100 kHz bandwidth within the band that contains the highest level of the desired power, based on either an RF conducted or a radiated measurement, provided that the transmitter demonstrates compliance with the peak conducted power limits.

GFSK mode: Hopping off

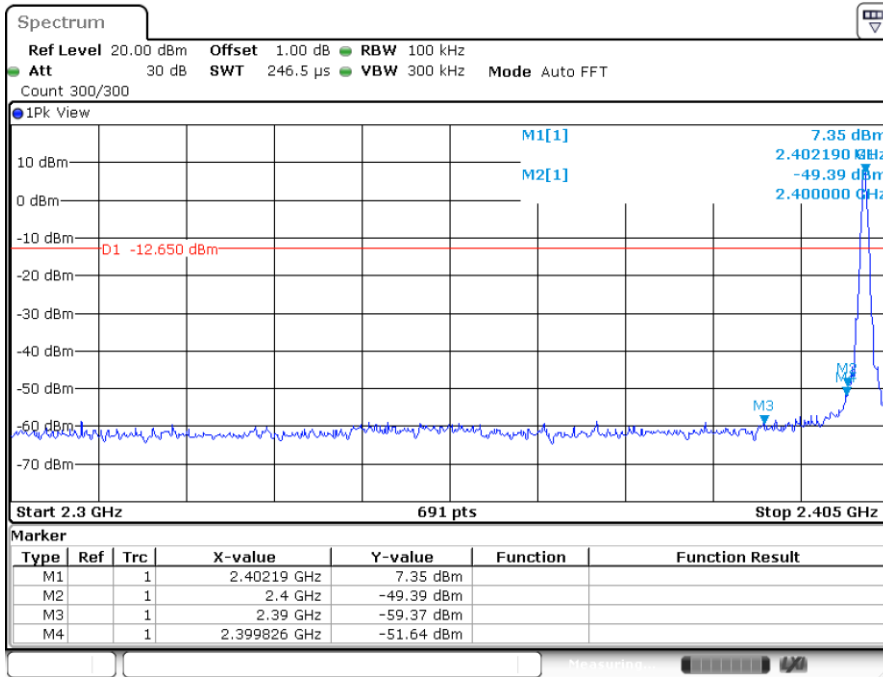

Date: 18.AUG.2020 17:34:36

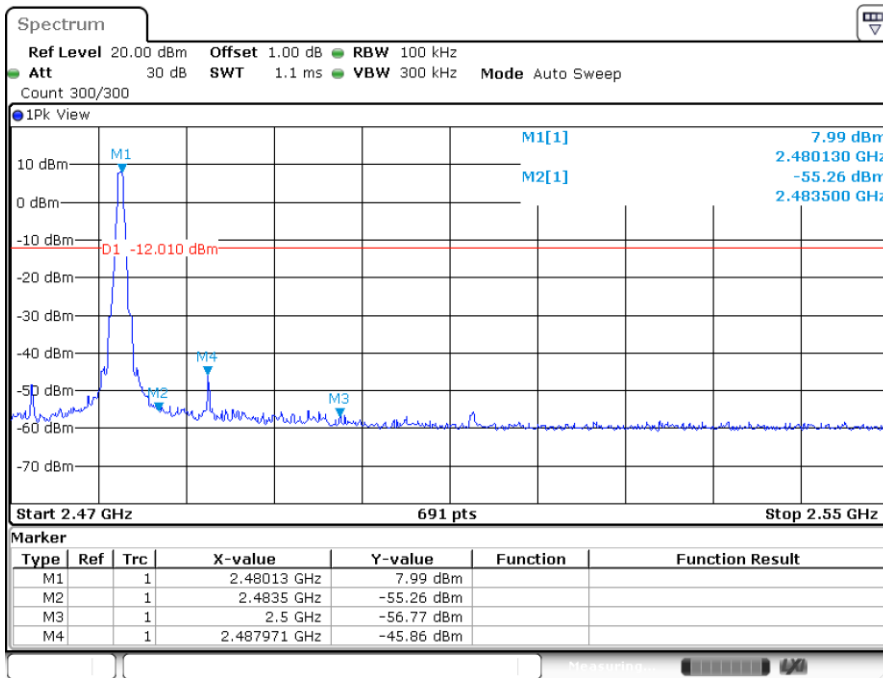

Date: 18.AUG.2020 17:37:59

GFSK mode: Hopping on

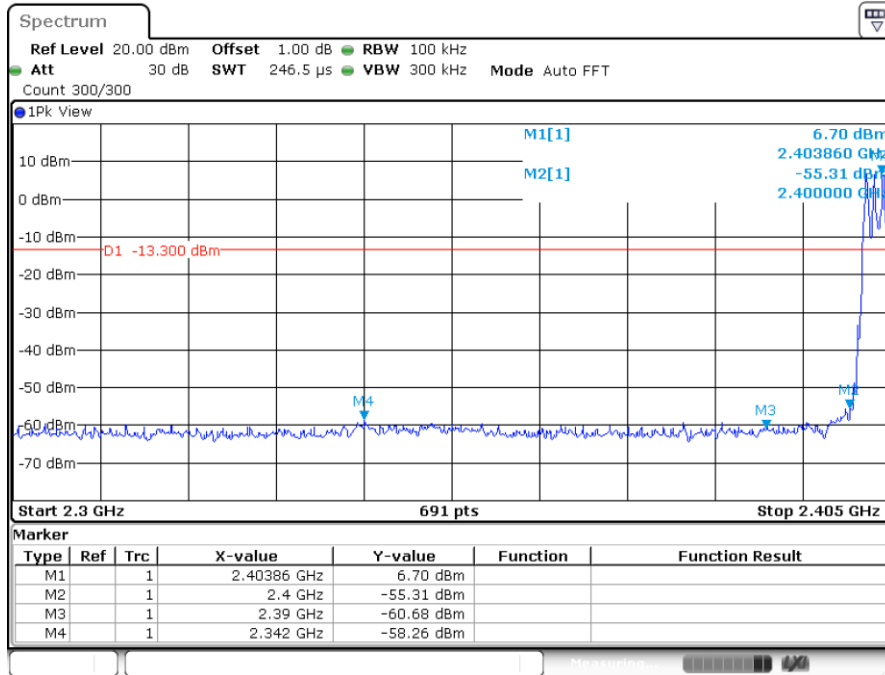

Date: 18.AUG.2020 17:55:29

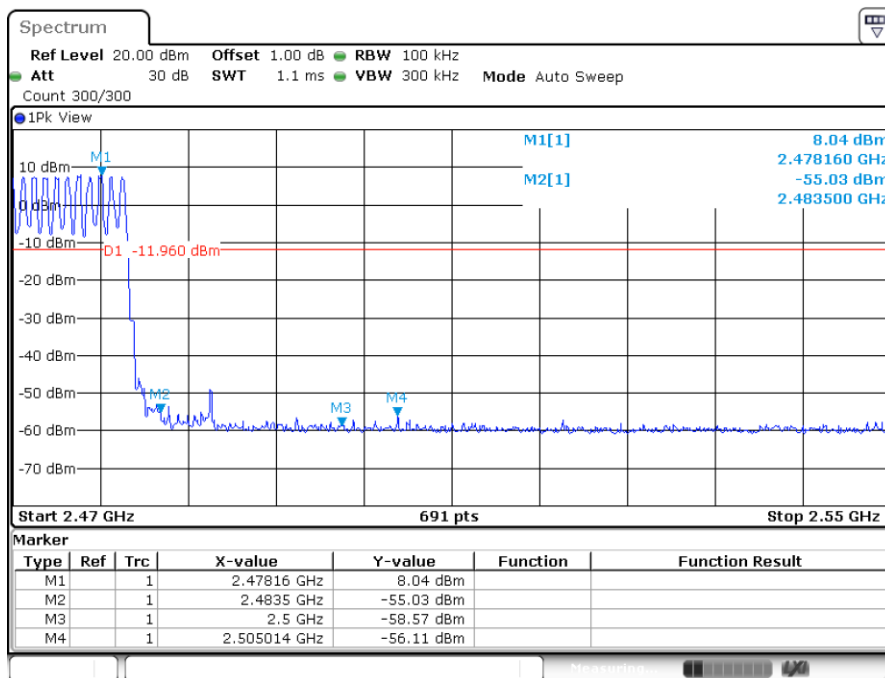

Date: 18.AUG.2020 18:06:01

8DPSK mode: Hopping off

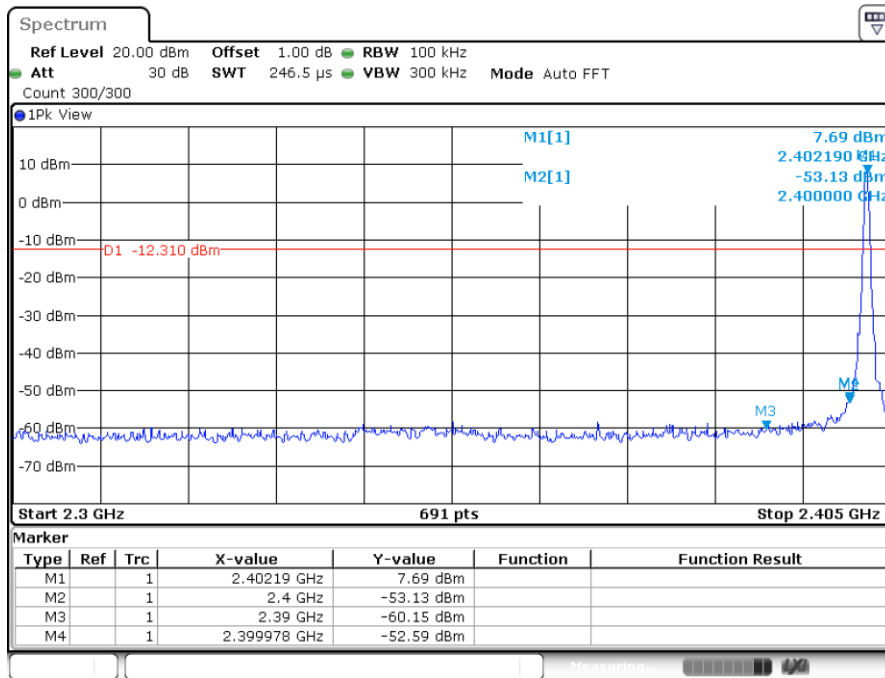

Date: 18.AUG.2020 17:48:49

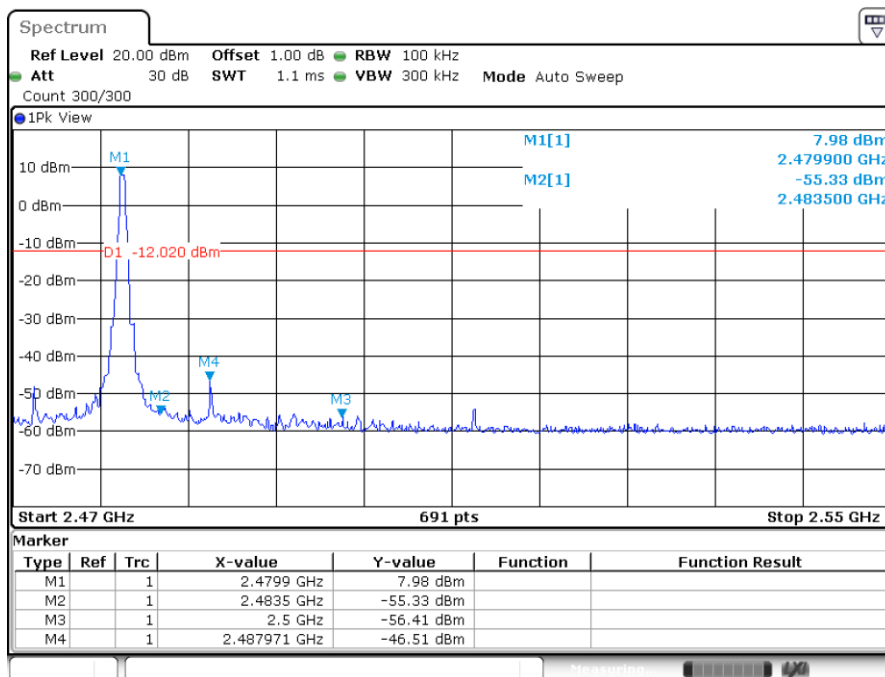

Date: 18.AUG.2020 17:54:14

8DPSK mode: Hopping on

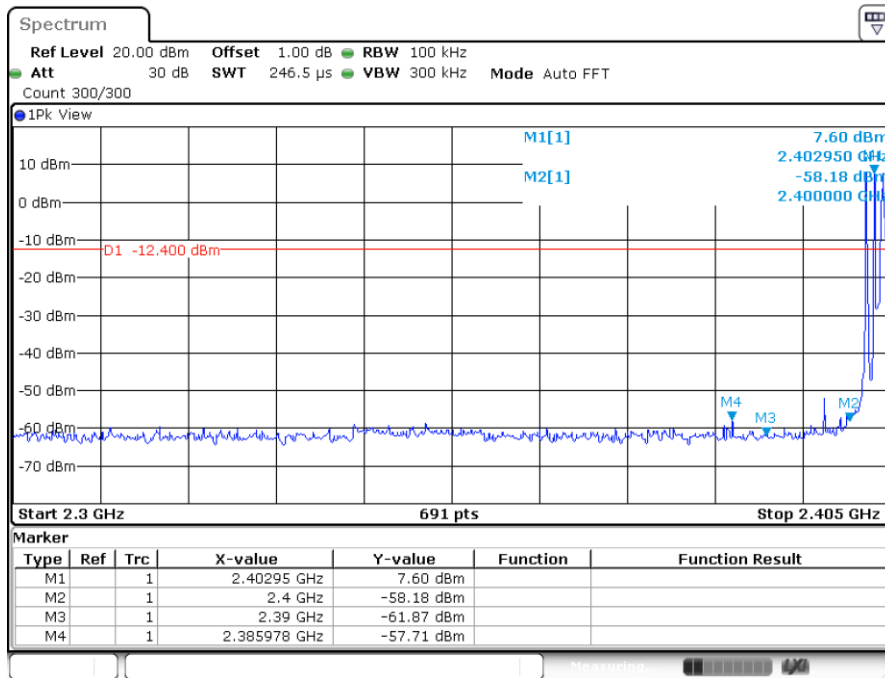

Date: 18.AUG.2020 18:19:45

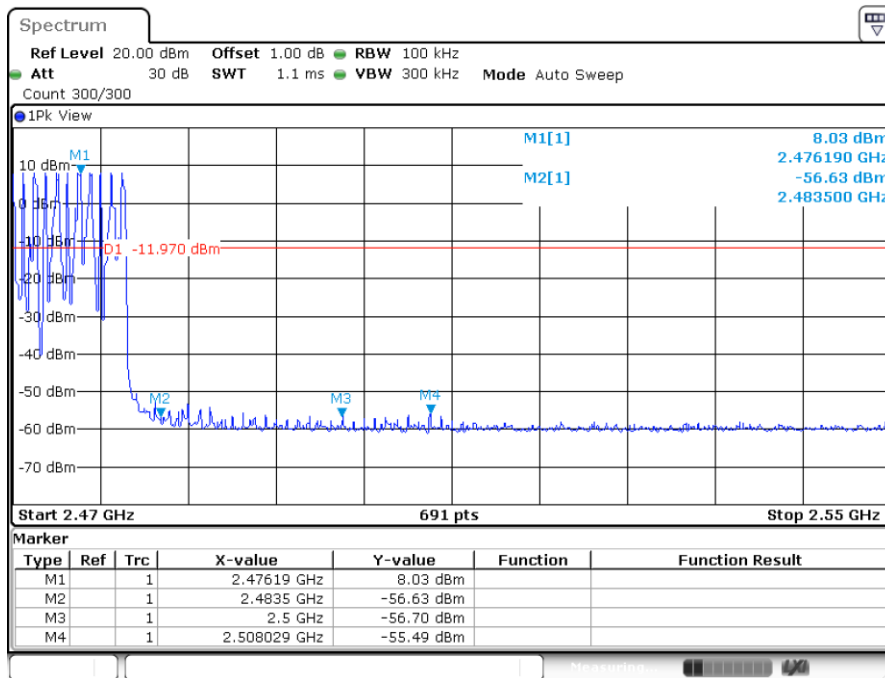

Date: 18.AUG.2020 18:24:28

9.8 Spurious radiated emissions for transmitter

Test Method

- 1: The EUT was placed on a turn table which is 1.5m above ground plane for above 1GHz and 0.8m above ground for below 1GHz at 3 meter chamber room for test. The table was rotated 360 degrees to determine the position of the highest radiation.
- 2: The EUT was set 3 meters away from the interference – receiving antenna, which was mounted on the top of a variable – height antenna tower.
- 3: The height of antenna is varied from one meter to four meters above the ground to determine the maximum value of the field strength. Both horizontal and vertical polarizations of the antenna are set to make the measurement.
- 4: For each suspected emission, the EUT was arranged to its worst case and then the antenna was tuned to heights from 1 meter to 4 meters and the rotatable table was turned from 0 degrees to 360 degrees to find the maximum reading.
- 5: Use the following spectrum analyzer settings According to C63.10:

For Below 1GHz

Use the following spectrum analyzer settings:

Span = wide enough to capture the peak level of the in-band emission and all spurious
RBW = 100 KHz to 120KHz, VBW \geq RBW for peak measurement, Sweep = auto,
Detector function = peak, Trace = max hold.

For Peak unwanted emissions Above 1GHz:

Span = wide enough to capture the peak level of the in-band emission and all spurious
RBW = 1MHz, VBW \geq RBW for peak measurement, Sweep = auto,
Detector function = peak, Trace = max hold.

Procedures for average unwanted emissions measurements above 1000 MHz:

Span = wide enough to capture the peak level of the in-band emission and all spurious
RBW = 1MHz, VBW=10Hz, Sweep = auto, Detector function = peak, Trace = max hold.
If the dwell time per channel of the hopping signal is less than 100 ms, then the reading obtained with the 10 Hz VBW may be further adjusted by a “duty cycle correction factor”, derived from $20\log(\text{dwell time}/100 \text{ ms})$, in an effort to demonstrate compliance with the 15.209 limit.

If the emission is pulsed, modify the unit for continuous operation; use the settings shown above, then correct the reading by subtracting the peak-average correction factor, derived from the appropriate duty cycle calculation.

The setting method can refer to DA00-705.

Limit

The radio emission outside the operating frequency band shall be at least 20 dB below that in the 100 kHz bandwidth within the band that contains the highest level of the desired power. Radiated emissions which fall in the restricted bands, as defined in section 15.205, must comply with the radiated emission limits specified in section 15.209.

In any 100 kHz bandwidth outside the frequency band in which the spread spectrum or digitally modulated device is operating, the RF power that is produced shall be at least 20 dB below that in the 100 kHz bandwidth within the band that contains the highest level of the desired power, based on either an RF conducted or a radiated measurement, provided that the transmitter demonstrates compliance with the peak conducted power limits. If the transmitter complies with the conducted power limits based on the use of root-mean-square averaging over a time interval, as permitted under section 5.4(d), the attenuation required shall be 30 dB instead of 20 dB. Attenuation below the general field strength limits specified in RSS-Gen is not required.

Frequency MHz	Field Strength uV/m	Field Strength dBµV/m	Detector
30-88	100	40	QP
88-216	150	43.5	QP
216-960	200	46	QP
960-1000	500	54	QP
Above 1000	500	54	AV
Above 1000	5000	74	PK

Spurious radiated emissions for transmitter

According to C63.10, if the peak (or quasi-peak) measured value complies with the average limit, it is unnecessary to perform an average measurement, so AV emission value did not show in below table if the peak value complies with average limit.

The only worse case (which is subject to the maximum EIRP, GFSK mode) test result is listed in the report.

Transmitting spurious emission test result as below:

EUT: In-ear True Wireless Headphone
 M/N: PI5L
 Operating Condition: Tx 2402MHz, lowest Channel

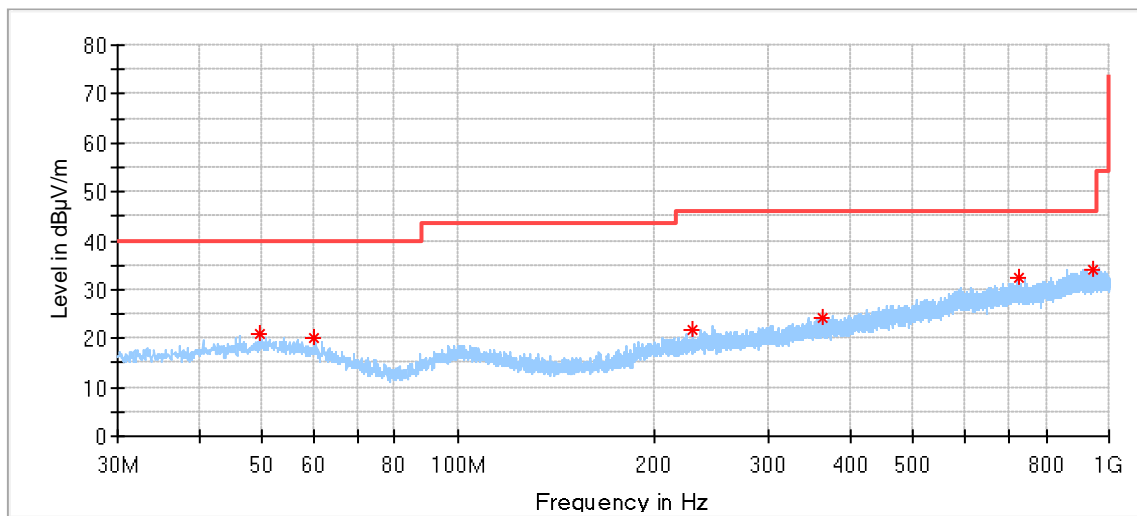

Critical Freqs

Frequency (MHz)	MaxPeak (dBµV/m)	Limit (dBµV/m)	Margin (dB)	Height (cm)	Pol	Azimuth (deg)	Corr. (dB/m)
49.561667	21.09	40.00	18.91	150.0	H	280.0	14.8
60.231667	20.04	40.00	19.96	150.0	H	84.0	13.5
229.873889	21.70	46.00	24.30	150.0	H	313.0	13.4
362.386667	24.36	46.00	21.64	150.0	H	150.0	16.6
724.520000	32.54	46.00	13.46	150.0	H	127.0	22.5
945.141111	34.24	46.00	11.76	150.0	H	188.0	25.2

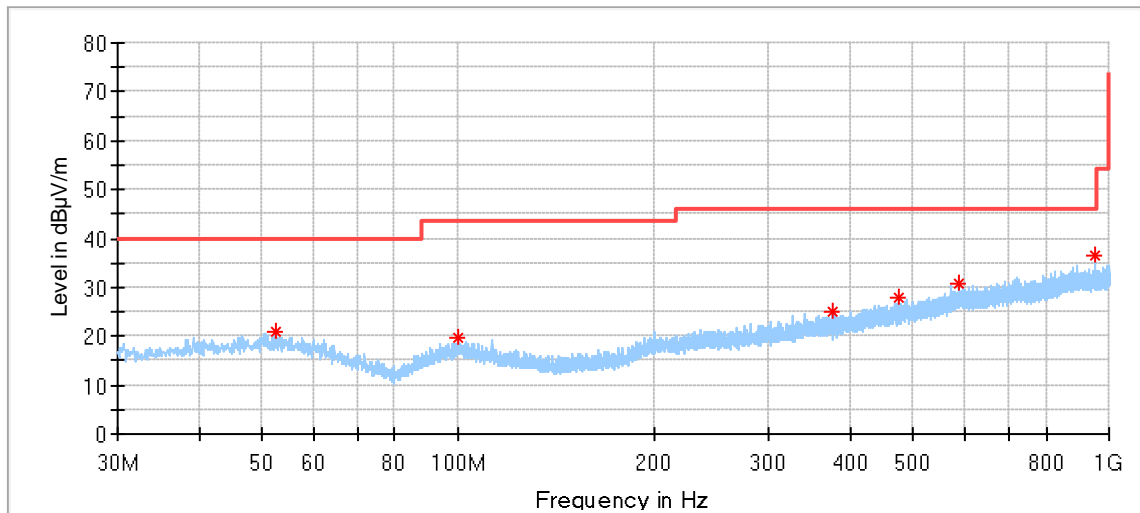

Critical Freqs

Frequency (MHz)	MaxPeak (dBµV/m)	Limit (dBµV/m)	Margin (dB)	Height (cm)	Pol	Azimuth (deg)	Corr. (dB/m)
52.417778	20.85	40.00	19.15	150.0	V	175.0	14.5
100.055556	19.57	43.50	23.93	150.0	V	15.0	13.0
375.697222	25.18	46.00	20.82	150.0	V	242.0	16.9
476.577222	27.87	46.00	18.13	150.0	V	355.0	19.0
586.295000	30.66	46.00	15.34	150.0	V	208.0	21.2
948.590000	36.56	46.00	9.44	150.0	V	114.0	25.2

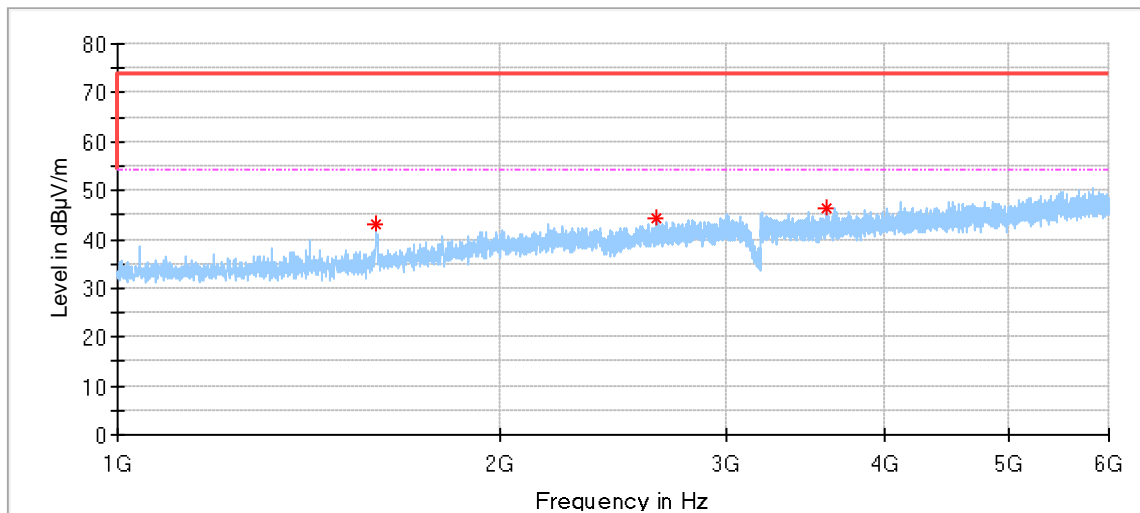

Critical Freqs

Frequency (MHz)	MaxPeak (dBµV/m)	Limit (dBµV/m)	Margin (dB)	Height (cm)	Pol	Azimuth (deg)	Corr. (dB/m)
1595.500000	42.93	74.00	31.07	150.0	H	306.0	-7.3
2646.000000	44.20	74.00	29.80	150.0	H	51.0	-2.5
3606.000000	46.49	74.00	27.51	150.0	H	275.0	0.0

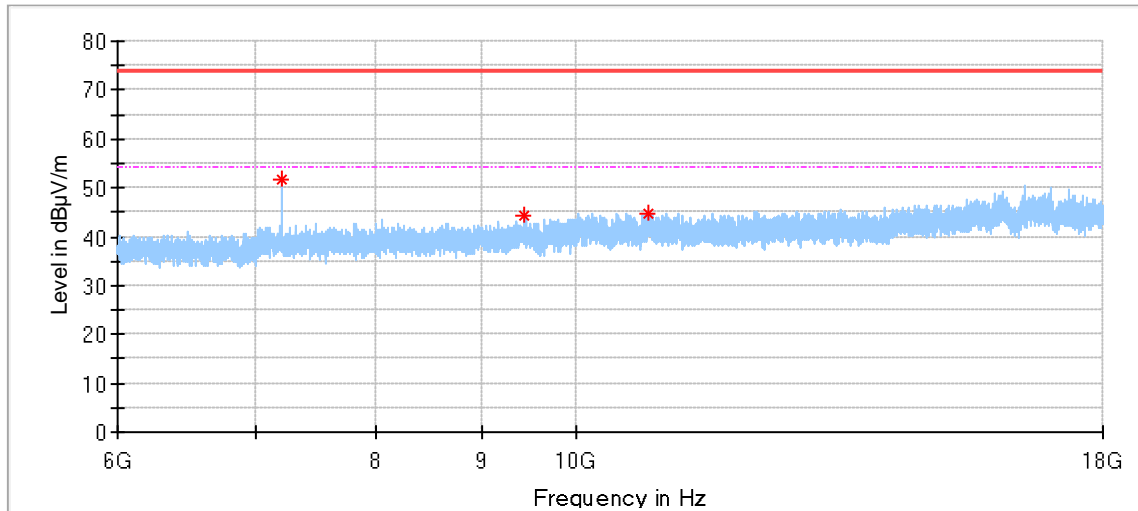

Critical_Freqs

Frequency (MHz)	MaxPeak (dBµV/m)	Limit (dBµV/m)	Margin (dB)	Height (cm)	Pol	Azimuth (deg)	Corr. (dB/m)
7205.500000	51.61	74.00	22.39	150.0	H	74.0	5.1
9434.500000	44.27	74.00	29.73	150.0	H	4.0	7.4
10844.500000	44.81	74.00	29.19	150.0	H	189.0	8.4

Final Result

Frequency (MHz)	Average (dBµV/m)	Limit (dBµV/m)	Margin (dB)	Height (cm)	Pol	Azimuth (deg)	Corr. (dB/m)
7205.500000	50.32	74.00	23.68	150.0	H	74.0	5.1

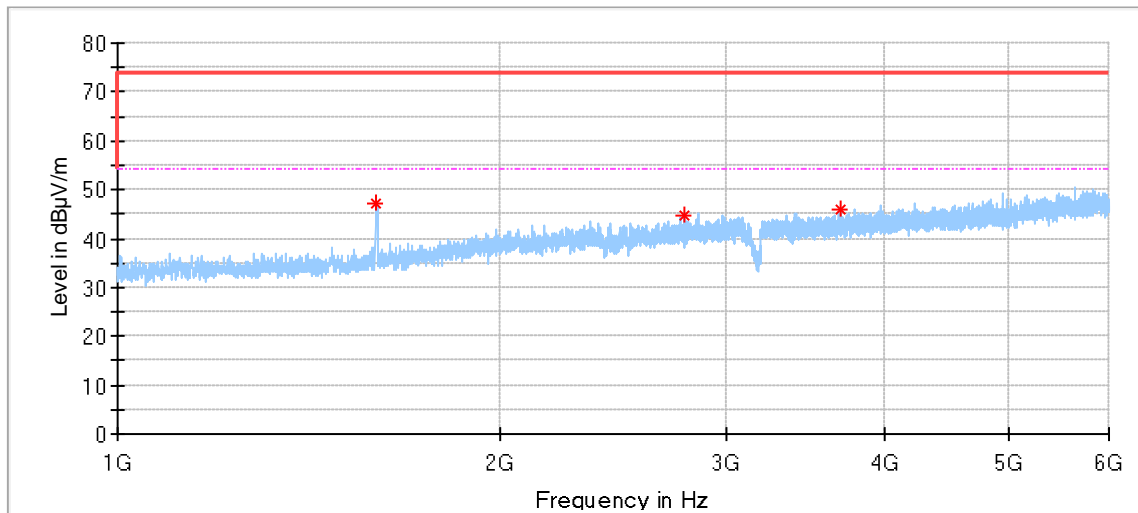

Critical_Freqs

Frequency (MHz)	MaxPeak (dBµV/m)	Limit (dBµV/m)	Margin (dB)	Height (cm)	Pol	Azimuth (deg)	Corr. (dB/m)
1594.000000	47.34	74.00	26.66	150.0	V	312.0	-7.4
2788.500000	44.81	74.00	29.19	150.0	V	235.0	-2.1
3691.000000	45.95	74.00	28.05	150.0	V	103.0	0.3

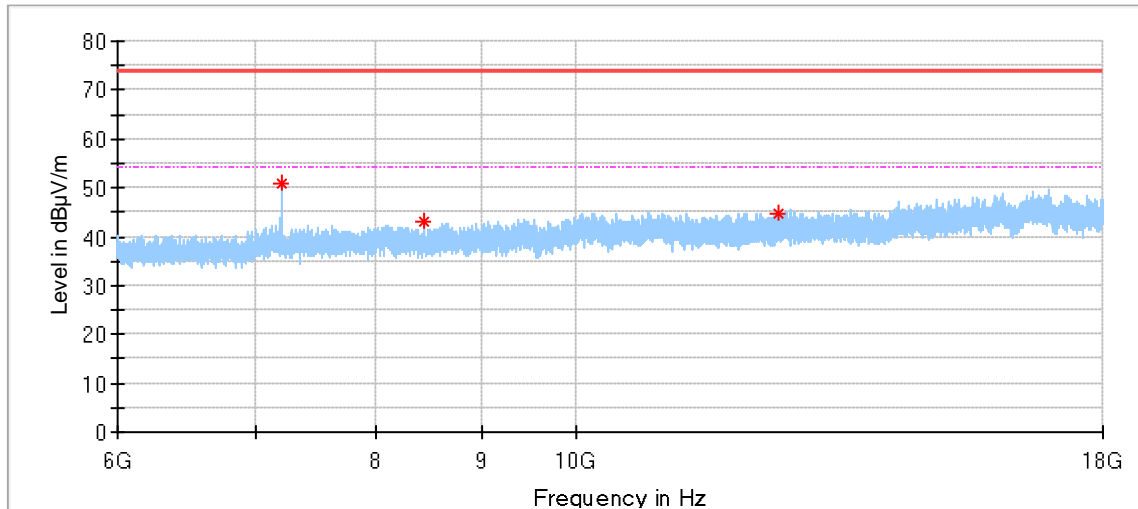

Critical Freqs

Frequency (MHz)	MaxPeak (dBµV/m)	Limit (dBµV/m)	Margin (dB)	Height (cm)	Pol	Azimuth (deg)	Corr. (dB/m)
7205.500000	51.04	74.00	22.96	150.0	V	266.0	5.1
8439.500000	43.14	74.00	30.86	150.0	V	0.0	6.0
12534.500000	44.72	74.00	29.28	150.0	V	174.0	9.2

Final Result

Frequency (MHz)	Average (dBµV/m)	Limit (dBµV/m)	Margin (dB)	Height (cm)	Pol	Azimuth (deg)	Corr. (dB/m)
7205.500000	50.82	74.00	23.18	150.0	V	266.0	5.1

EUT: In-ear True Wireless Headphone
 M/N: PI5L
 Operating Condition: Tx 2441MHz, Middle Channel

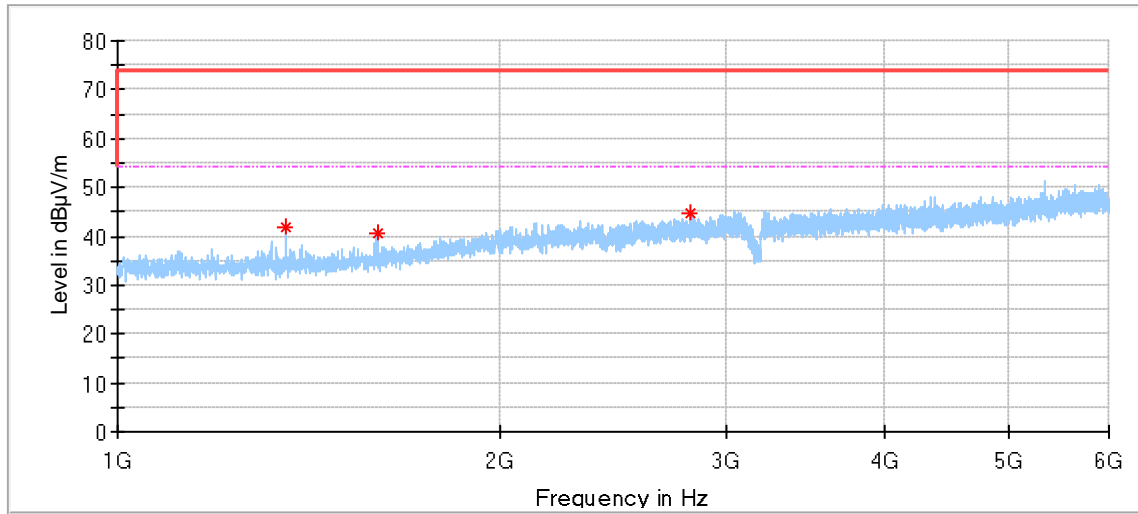

Critical_Freqs

Frequency (MHz)	MaxPeak (dBµV/m)	Limit (dBµV/m)	Margin (dB)	Height (cm)	Pol	Azimuth (deg)	Corr. (dB/m)
1356.000000	41.71	74.00	32.29	150.0	H	233.0	-8.7
1598.500000	40.72	74.00	33.28	150.0	H	69.0	-7.3
2816.500000	44.89	74.00	29.11	150.0	H	179.0	-2.0

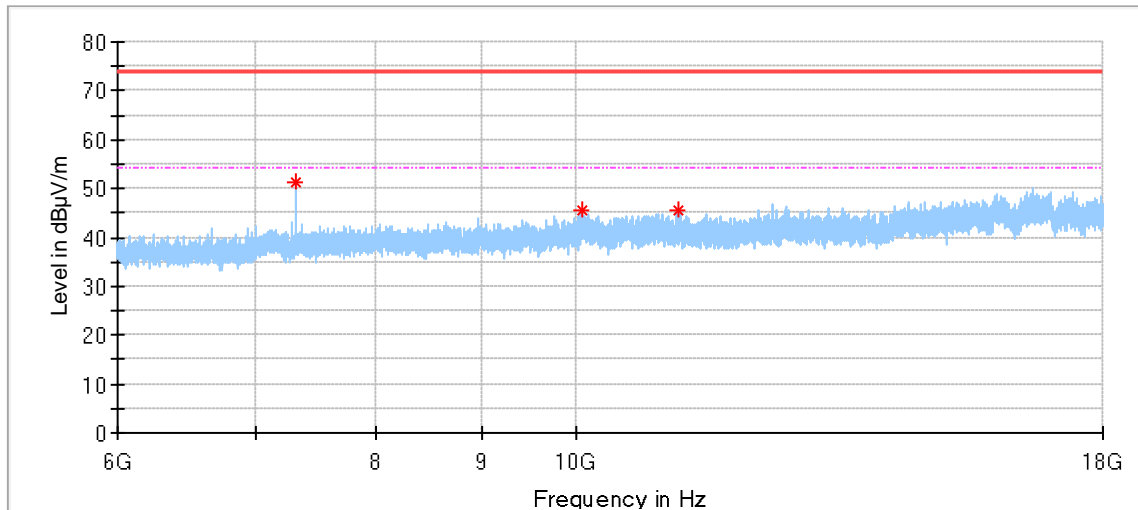

Critical_Freqs

Frequency (MHz)	MaxPeak (dBµV/m)	Limit (dBµV/m)	Margin (dB)	Height (cm)	Pol	Azimuth (deg)	Corr. (dB/m)
7322.500000	51.20	74.00	22.80	150.0	H	146.0	5.3
10071.500000	45.53	74.00	28.47	150.0	H	356.0	9.3
11208.500000	45.51	74.00	28.49	150.0	H	193.0	8.5

Final_Result

Frequency (MHz)	Average (dBµV/m)	Limit (dBµV/m)	Margin (dB)	Height (cm)	Pol	Azimuth (deg)	Corr. (dB/m)
7322.500000	50.94	74.00	23.06	150.0	H	146.0	5.3

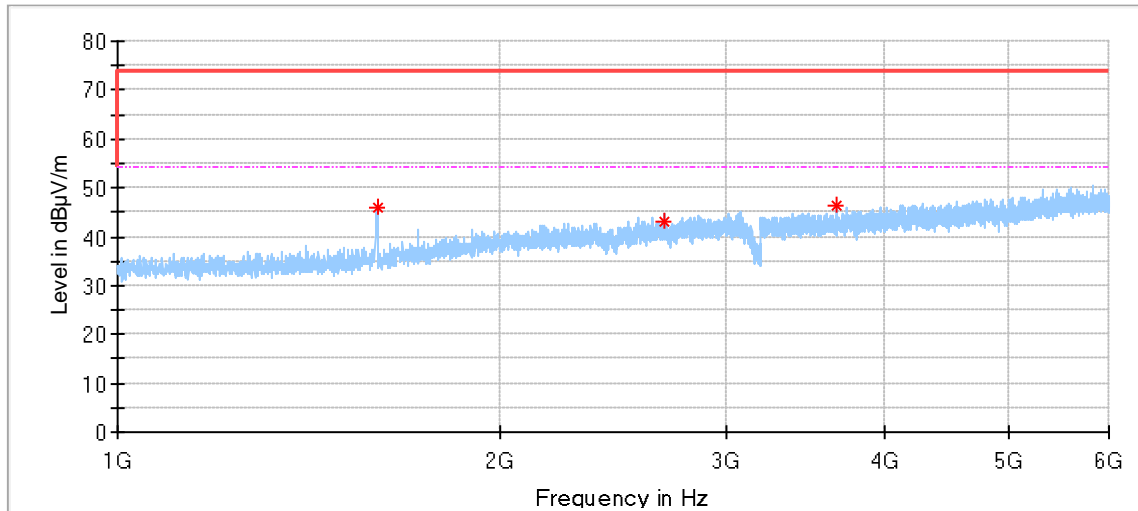

Critical Freqs

Frequency (MHz)	MaxPeak (dBµV/m)	Limit (dBµV/m)	Margin (dB)	Height (cm)	Pol	Azimuth (deg)	Corr. (dB/m)
1598.500000	45.78	74.00	28.22	150.0	V	181.0	-7.3
2683.500000	43.26	74.00	30.74	150.0	V	356.0	-2.3
3669.000000	46.32	74.00	27.68	150.0	V	351.0	0.2

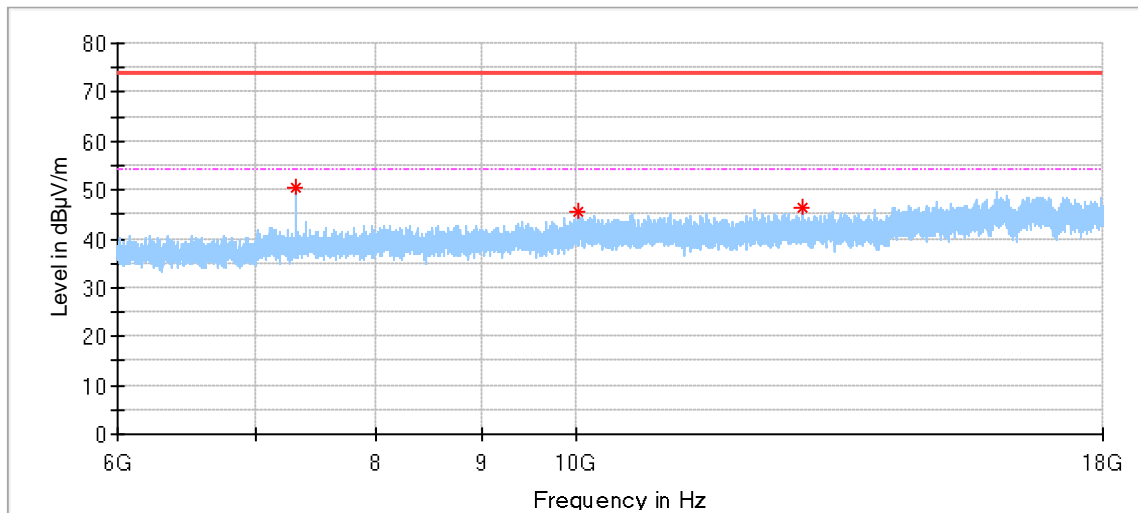

Critical Freqs

Frequency (MHz)	MaxPeak (dBµV/m)	Limit (dBµV/m)	Margin (dB)	Height (cm)	Pol	Azimuth (deg)	Corr. (dB/m)
7323.500000	50.60	74.00	23.40	150.0	V	163.0	5.3
10038.000000	45.72	74.00	28.28	150.0	V	279.0	9.1
12889.000000	46.19	74.00	27.81	150.0	V	24.0	9.1

EUT: In-ear True Wireless Headphone
 M/N: PI5L
 Operating Condition: Tx 2480MHz, High Channel)

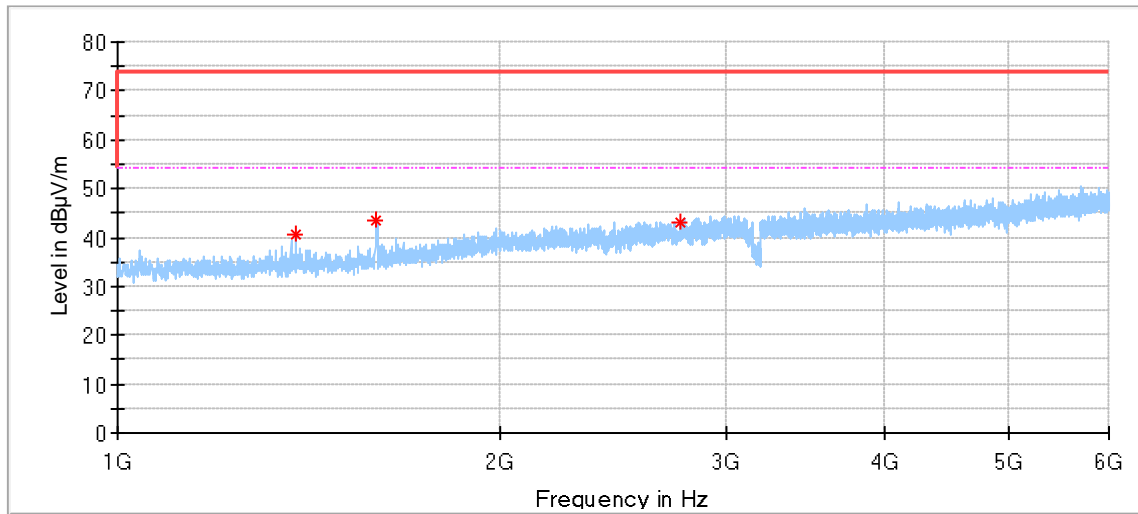

Critical Freqs

Frequency (MHz)	MaxPeak (dBµV/m)	Limit (dBµV/m)	Margin (dB)	Height (cm)	Pol	Azimuth (deg)	Corr. (dB/m)
1381.000000	40.69	74.00	33.31	150.0	H	228.0	-8.6
1595.000000	43.36	74.00	30.64	150.0	H	47.0	-7.3
2767.000000	43.20	74.00	30.80	150.0	H	72.0	-2.1

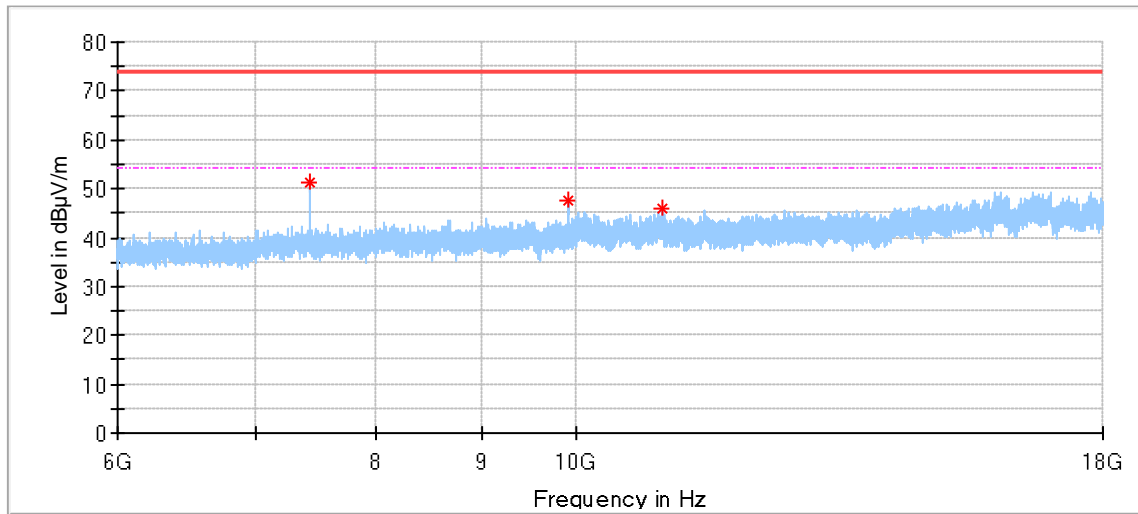

Critical Freqs

Frequency (MHz)	MaxPeak (dBµV/m)	Limit (dBµV/m)	Margin (dB)	Height (cm)	Pol	Azimuth (deg)	Corr. (dB/m)
7440.500000	51.19	74.00	22.81	150.0	H	140.0	5.5
9920.000000	47.67	74.00	26.33	150.0	H	71.0	8.1
11002.500000	45.77	74.00	28.23	150.0	H	48.0	8.4

Final Result

Frequency (MHz)	Average (dBµV/m)	Limit (dBµV/m)	Margin (dB)	Height (cm)	Pol	Azimuth (deg)	Corr. (dB/m)
7440.500000	50.46	74.00	23.54	150.0	H	140.0	5.5

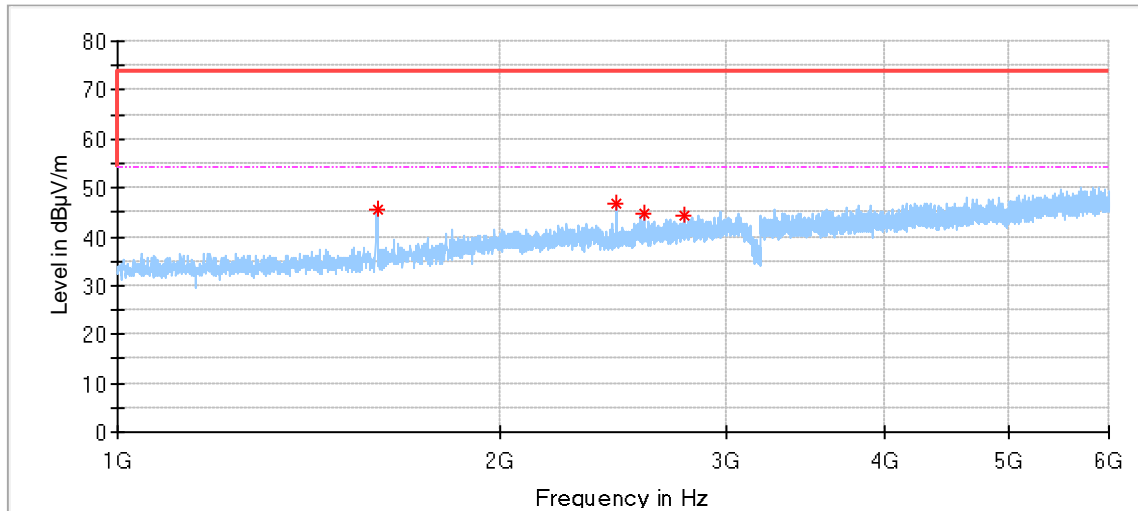

Critical Freqs

Frequency (MHz)	MaxPeak (dBµV/m)	Limit (dBµV/m)	Margin (dB)	Height (cm)	Pol	Azimuth (deg)	Corr. (dB/m)
1600.000000	45.71	74.00	28.29	150.0	V	179.0	-7.3
2462.500000	46.83	74.00	27.17	150.0	V	349.0	-2.9
2588.000000	44.52	74.00	29.48	150.0	V	23.0	-2.6
2789.500000	44.28	74.00	29.72	150.0	V	304.0	-2.1

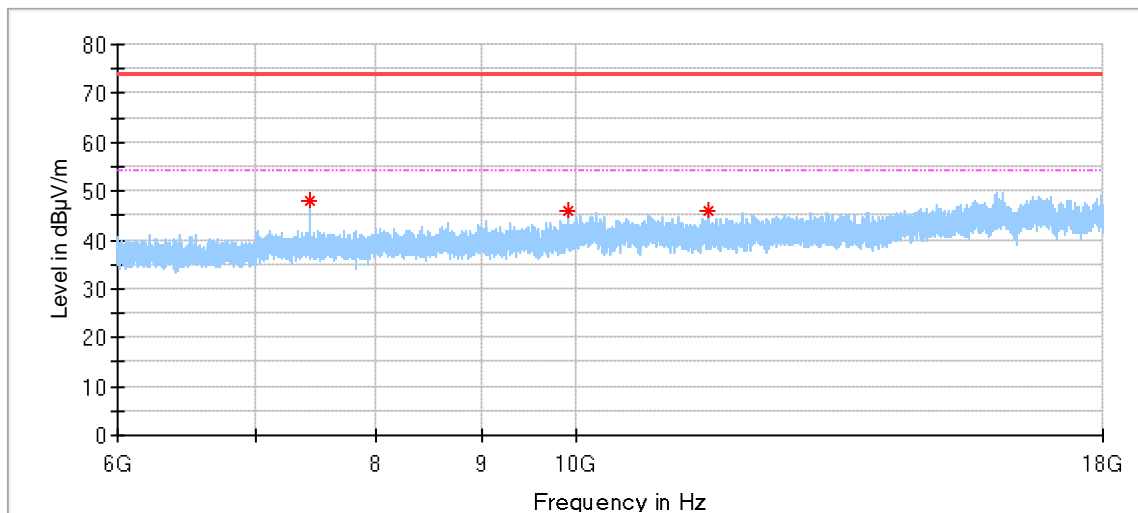

Critical Freqs

Frequency (MHz)	MaxPeak (dBµV/m)	Limit (dBµV/m)	Margin (dB)	Height (cm)	Pol	Azimuth (deg)	Corr. (dB/m)
7440.000000	48.08	74.00	25.92	150.0	V	148.0	5.5
9919.500000	46.05	74.00	27.95	150.0	V	356.0	8.1
11594.500000	45.79	74.00	28.21	150.0	V	266.0	8.2

Remark:

- (1) Data of measurement within frequency range 18-26GHz are the noise floor or attenuated more than 20dB below the permissible limits or the field strength is too small to be measured, so test data does not present in this report.
- (2) Level=Reading Level + Correction Factor
 Above 1GHz: Corrector factor = Antenna Factor + Cable Loss- Amplifier Gain
 Below 1GHz: Corrector factor = Antenna Factor + Cable Loss
 (The Reading Level is recorded by software which is not shown in the sheet)

10 Test Equipment List

List of Test Instruments

Radiated Emission Test

Description	Manufacturer	Model no.	Equipment ID	Serial no.	Calibration interval (year)	cal. due date
EMI Test Receiver	Rohde & Schwarz	ESR 26	68-4-74-14-002	101269	1	2021-6-29
Trilog Super Broadband Test Antenna	Schwarzbeck	VULB 9162	68-4-80-19-003	284	1	2021-2-24
Wave Guide Antenna	ETS	3117	68-4-80-19-001	00218954	1	2021-6-15
Pre-amplifier	Rohde & Schwarz	SCU 18F	68-4-29-19-001	100745	1	2020-12-14
Pre-amplifier	Rohde & Schwarz	SCU 08F2	68-4-29-19-004	08400018	1	2020-12-14
Sideband Horn Antenna	Q-PAR	QWH-SL-18-40-K-SG	68-4-80-14-008	12827	1	2021-8-5
Pre-amplifier	Rohde & Schwarz	SCU 40A	68-4-29-14-002	100432	1	2021-7-30
3m Semi-anechoic chamber	TDK	9X6X6	68-4-90-19-006	----	3	2022-12-29
Test software	Rohde & Schwarz	EMC32	68-4-90-19-006-A01	Version10.3 5.02	N/A	N/A

RF Conducted Test

Description	Manufacturer	Model no.	Equipment ID	Serial no.	Calibration interval (year)	cal. due date
Signal Analyzer	Rohde & Schwarz	FSV40	68-4-74-14-004	101030	1	2021-6-21



11 System Measurement Uncertainty

For a 95% confidence level, the measurement expanded uncertainties for defined systems, in accordance with the recommendations of ISO 17025 were:

System Measurement Uncertainty	
Test Items	Extended Uncertainty
Radiated Spurious Emission 30MHz-1000MHz	Horizontal: 4.70dB; Vertical: 4.67dB;
Radiated Spurious Emission 1000MHz-18000MHz	Horizontal: 4.65dB; Vertical: 4.63dB;
Conducted RF test with TS 8997	RF Power Conducted: 1.16dB Frequency test involved: 0.6×10 ⁻⁷ or 1%