

TEST REPORT

For

Bluetooth Low Energy Wireless Module

In conformity with

FCC CFR 47 Part15 Subpart C
RSS-247 Issue 1
RSS-Gen Issue 5

Model : MK71251-01 / MK71251-02

FCC ID : 2ACIJ71251
IC Cert. No. : 20971-K71251

Report No. : ERY1512P25R4

Issue Date : 25 Dec. 2015

Prepared for

LAPIS Semiconductor Co., Ltd.
2-4-8 Shinyokohama, Kouhoku-ku, Yokohama 222-8575 Japan
Telephone: +81 - (0)45 - 476 - 9295

Prepared by

SGS RF Technologies Inc.
3-5-23, Kitayamata, Tsuzuki-ku, Yokohama 224-0021, Japan
Telephone: +81+(0)45- 550-3520
FAX: +81 - (0)45 - 592-7506

This document is issued by the Company subject to its General Conditions of Service printed overleaf, available on request or accessible at www.sgs.com/terms_and_conditions.htm and, for electronic format documents, subject to Terms and Conditions for Electronic Documents at www.sgs.com/terms_e-document.htm. Attention is drawn to the limitation of liability, indemnification and jurisdiction issues defined therein. Any holder of this document is advised that information contained hereon reflects the Company's findings at the time of its intervention only and within the limits of Client's instructions, if any. The Company's sole responsibility is to its Client and this document does not exonerate parties to a transaction from exercising all their rights and obligations under the transaction documents. This document cannot be reproduced except in full, without prior written approval of the Company. Any unauthorized alteration, forgery or falsification of the content or appearance of this document is unlawful and offenders may be prosecuted to the fullest extent of the law.

SGS RF Technologies Inc. is managed to ISO17025 and has the necessary knowledge and test facilities for testing according to the referenced standards. The test results in this report apply only to the sample(s) tested.

Table of contents

1	General information.....	4
1.1	Product description	4
1.2	Test(s) performed/ Summary of test result	4
1.3	Test facility	5
1.4	Measurement uncertainty.....	5
1.5	Summary of test results.....	6
1.6	Setup of equipment under test (EUT).....	6
1.6.1	Test configuration of EUT.....	6
1.6.2	Operating condition:	6
1.6.3	Setup diagram of tested system.....	7
1.7	Equipment modifications.....	7
1.8	Deviation from the standard	7
2	Test procedure and test data	8
2.1	Occupied Bandwidth (99%).....	8
2.2	6dB Bandwidth	10
2.3	Peak Output Power	12
2.4	Conducted Spurious Emissions.....	14
2.5	Power Spectral density.....	18
2.6	Radiated emissions	20
2.7	AC power line conducted emissions.....	26
3	Test setup photographs.....	34
3.1	Radiated emissions	34
3.2	AC power line conducted emissions.....	34
4	List of utilized test equipment / calibration	35

History

Report No.	Date	Revisions	Issued By
ERY1512P25R4	25 Dec. 2015	Initial Issue	T.Kato

1 General information

1.1 Product description

Test item : Bluetooth Low Energy Wireless Module
Manufacturer : LAPIS Semiconductor Co., Ltd.
Address : 2-4-8 Shinyokohama, Kouhoku-ku, Yokohama 222-8575 Japan
Model : MK71251-01
FCC ID : 2ACIJ71251
IC Cert. No. : 20971-K71251
Serial number : PAT001, ANT001
Hardware version : BLE-4.1.3.0
Software version : BLE-4.1.1.3
Operating frequency : 2402 - 2480 MHz
Modulation : GFSK
Antenna Gain : +1.7 dBi
Receipt date of EUT : 07 Dec. 2015
Nominal power source voltages : 3.0 Vdc

Family model : MK71521-02
(Difference is an internal ROM. The operating frequency is same.)

1.2 Test(s) performed/ Summary of test result

Test specification(s) : FCC CFR 47 Part 15 Subpart C (01 Oct. 2014)
Test method(s) : ANSI C63.10: 2013
Test(s) started : 07 Dec. 2015
Test(s) completed : 08 Dec. 2014
Purpose of test(s) : Certification

Summary of test result : Complied

Note: The above judgment is only based on the measurement data and it does not include the measurement uncertainty. Accordingly, the statement below is applied to the test result.

The EUT complies with the limit required in the standard in case that the margin is not less than the measurement uncertainty in the Laboratory.

Compliance of the EUT is more probable than non-compliance is case that the margin is less than the measurement uncertainty in the Laboratory.

Test engineer

: 
T. Kato
EMC testing Department

Reviewer

: 
K. Onishi
Manager
EMC testing Department

1.3 Test facility

The Federal Communications Commission has reviewed the technical characteristics of the test facilities at SGS RF Technologies Inc., located in 472, Nippa-cho, Kohoku-ku, Yokohama, 223-0057, Japan, and has found these test facilities to be in compliance with the requirements of 47 CFR Part 15, section 2.948, per October 1, 2014.

The description of the test facilities has been filed under registration number 319924 at the Office of the Federal Communications Commission. The facility has been added to the list of laboratories performing these test services for the public on a fee basis.

The list of all public test facilities is available on the Internet at <http://www.fcc.gov>.

Registered by Industry Canada (IC): The registered facility number is as follows;

Test site No. 1 (Semi-Anechoic chamber 3m): 6974A-1

Accredited by **National Voluntary Laboratory Accreditation Program (NVLAP)** for the emission tests stated in the scope of the certificate under Certificate Number 200780-0

This report must not be used by the client to claim product certification, approval, or endorsement by NVLAP, NIST, or any agency of the Federal Government.

1.4 Measurement uncertainty

The treatment of uncertainty is based on the general matters on the definition of uncertainty in “Guide to the expression of uncertainty in measurement (GUM)” published by ISO. The Lab’s uncertainty is determined by referring UKAS Publication LAB34: 2002 “The Expression of Uncertainty in EMC Testing” and CISPR16-4-2: 2011 “Uncertainty in EMC Measurements”.

The uncertainty of the measurement result in the level of confidence of approximately 95% ($k=2$) is as follows;

Conducted emission: ± 3.4 dB (10 kHz - 30 MHz)

Radiated emission (9 kHz - 30 MHz): ± 3.3 dB

Radiated emission (30 MHz - 200 MHz): ± 4.8 dB

Radiated emission (200 MHz - 1000 MHz): ± 6.1 dB

1.5 Summary of test results

Requirement	Section in FCC	Section in IC	Result	Section in this report
Occupied Bandwidth (99 %)	2.1049	RSS-Gen 6.6	Complied	2.1
6 dB Bandwidth	15.247 (a) (2)	RSS-247 5.2(1)	Complied	2.2
Conducted Output Power	15.247 (b) (3)	RSS-247 5.4(4)	Complied	2.3
Conducted Spurious Emission	15.247 (d)	RSS-247 5.5	Complied	2.4
Power Spectral Density	15.247 (e)	RSS-247 5.2(2)	Complied	2.5
Radiated Emissions	15.247(d), 15.205 (a)	RSS-Gen 8.9 / 8.10	Complied	2.6
AC power line conducted emissions	15.207	RSS-Gen 8.8	Complied	2.7
Receiver Radiated Emissions	-	RSS-Gen 7.1.2	Complied	2.8

1.6 Setup of equipment under test (EUT)

1.6.1 Test configuration of EUT

Equipment(s) under test

No.	Item	Manufacture	Model No.	Serial No.
A1	Bluetooth Module (for Conducted test)	LAPIS Semiconductor	MK71251-01	ANT001
A2	Bluetooth Module (for Radiated test)	LAPIS Semiconductor	MK71251-01	PAT001

Support Equipment(s)

No.	Item	Manufacture	Model No.	Serial No.
B	USB Conversion Board	-	-	-
C	AC adaptor	UNIFIVE	US303320	D02-0136115
	-	-	-	-

Connected cable(s)

No.	Item	Identification (Manu.etc.)	Cable Shielded	Ferrite Core	Length [m]
1	DC cable for AC adaptor	-	No	No	1.0

1.6.2 Operating condition:

- Tx (2402MHz): The EUT is in normal transmission mode in 2402 MHz.
- Tx (2440MHz): The EUT is in normal transmission mode in 2440 MHz.
- Tx (2480MHz): The EUT is in normal transmission mode in 2480 MHz.
- Rx (2402MHz): The EUT is in normal receiving mode in 2402 MHz.
- Rx (2440MHz): The EUT is in normal receiving mode in 2440 MHz.
- Rx (2480MHz): The EUT is in normal receiving mode in 2480 MHz.

1.6.3 Setup diagram of tested system

[Configuration A]

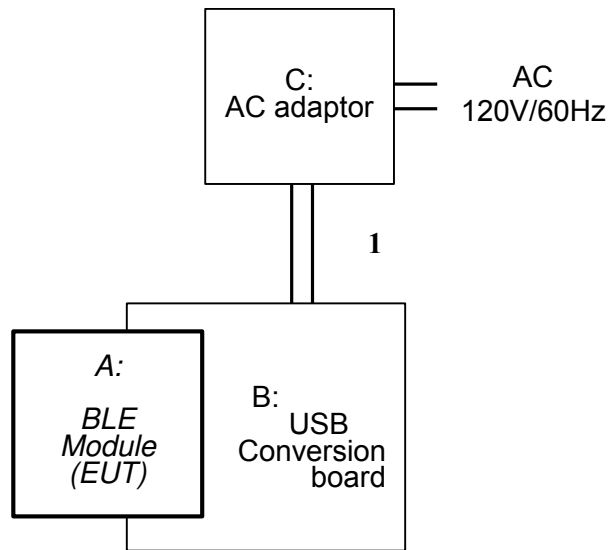

[Configuration B]

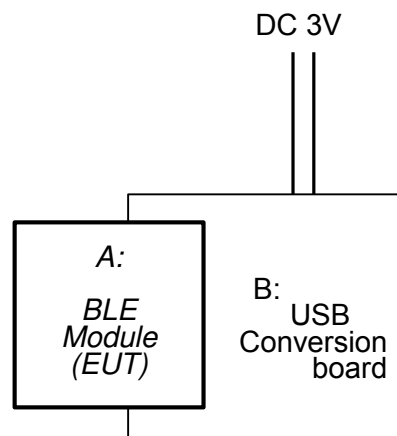

1.7 Equipment modifications

No modifications have been made to the equipment in order to achieve compliance with the applicable standards described in clause 1.2.

1.8 Deviation from the standard

No deviations from the standards described in clause 1.2.

2 Test procedure and test data

2.1 Occupied Bandwidth (99%)

Test setup

Test setup is the following drawing. The antenna port of EUT was connected to the spectrum analyzer.

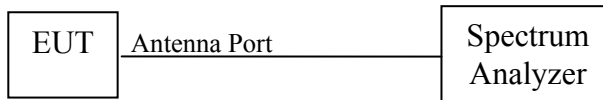

Test procedure

Spectrum analyzer is set as below according to ANSI C63.10 clause 6.9

- RBW : 1 to 5 % of OBW
- VBW > 3 x RBW
- Span : OBW x 1.5 to 5
- Trace : Max hold

Limitation

There are no limitations.
 The measurement value is used for the emission designator.

Test equipment used (refer to List of utilized test equipment)

TR06	CL31				
------	------	--	--	--	--

Test results

Tested sample: AI

Configuration: A

Transmission Frequency [MHz]	Occupied Bandwidth [MHz]
2402	1.098
2440	1.098
2480	1.068

[Chart]

Tx (2440 MHz)

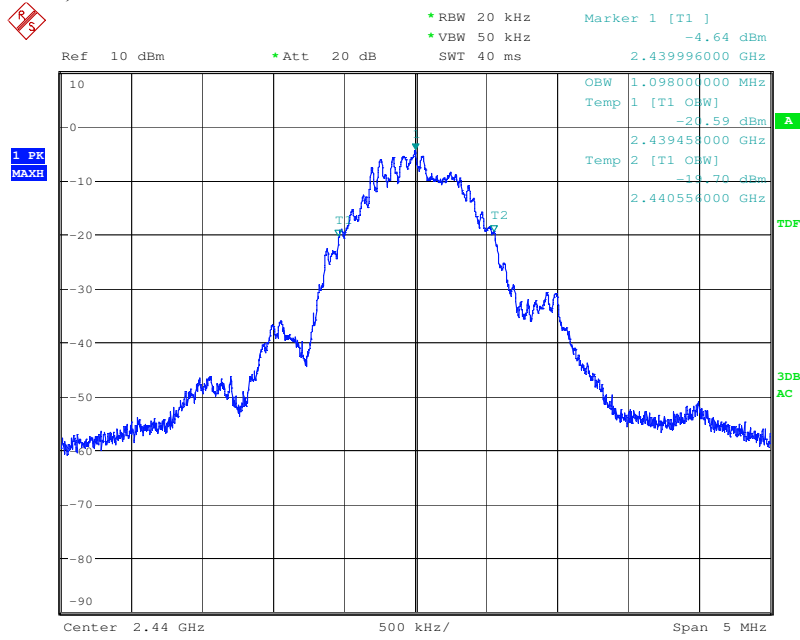

Tested Date: 08 Dec. 2015
 Humidity: 36 %

Temperature: 18 degC
 Atmos. Press: 1028 hPa

2.2 6dB Bandwidth

Test setup

Test setup is the following drawing. The antenna port of EUT was connected to the spectrum analyzer.

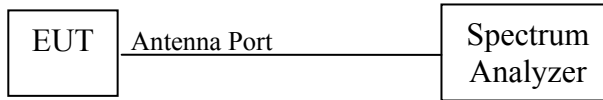

Test procedure

Spectrum analyzer is set as below according to ANSI C63.10 clause 11.8

- RBW = 100 kHz
- VBW : 300 kHz
- Detector : Peak
- Trace : Max hold

Applicable rule and limitation

15.247 (a) (2) Systems using digital modulation techniques may operate in the 902–928 MHz, 2400–2483.5 MHz, and 5725–5850 MHz bands. The minimum 6 dB bandwidth shall be at least 500 kHz.

Test equipment used (refer to List of utilized test equipment)

TR06	CL31				
------	------	--	--	--	--

Test results - Complied with requirement

Test Data

Tested sample: A1

Configuration: A

Transmission Frequency [MHz]	6 dB Bandwidth [kHz]
2402	700
2440	704
2480	696

[Chart]

Tx 2440 MHz

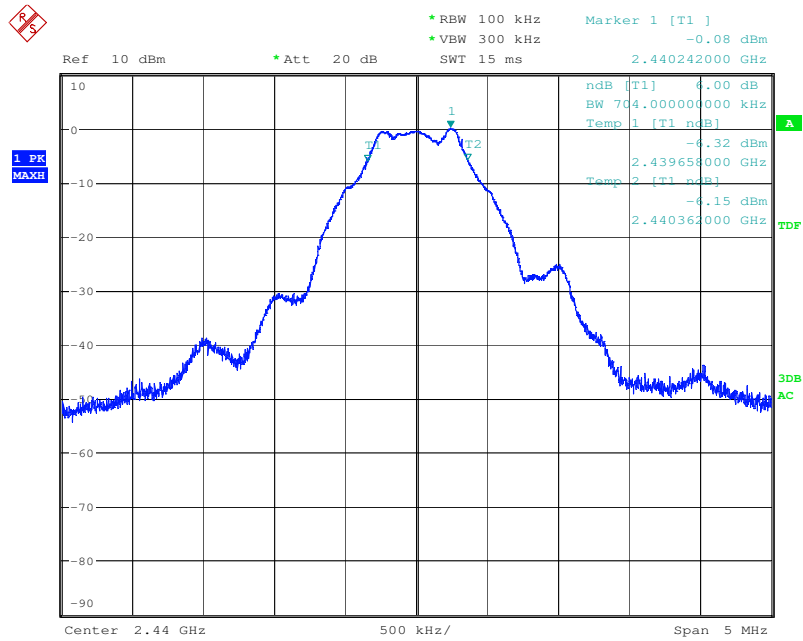

Tested Date: 08 Dec. 2015
 Humidity: 36 %

Temperature: 18 degC
 Atmos. Press: 1028 hPa

2.3 Peak Output Power

Test setup

Test setup is the following drawing. The antenna port of EUT was connected to the spectrum analyzer.

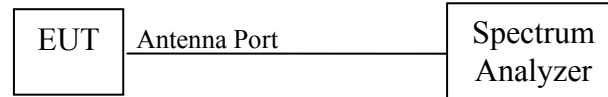

Test procedure

Spectrum analyzer is set as below according to ANSI C63.10 clause 11.9

- RBW > 6dB BW
- Span > 3 x RBW
- Trace : Max hold
- VBW > 3 x RBW
- Detector : Peak

Applicable rule and limitation

15.247(b) (3) For systems using digital modulation in the 902–928 MHz, 2400–2483.5MHz, and 5725–5850 MHz bands: 1 Watt (30 dBm).

Test equipment used (refer to List of utilized test equipment)

TR06	CL31				
------	------	--	--	--	--

Test results - Complied with requirement

Test Data

Tested sample: A1

Configuration: A

Transmission Frequency [MHz]	Output Power [dBm]
2402	0.31
2440	0.77
2480	0.75

[Chart]

Tx 2440 MHz

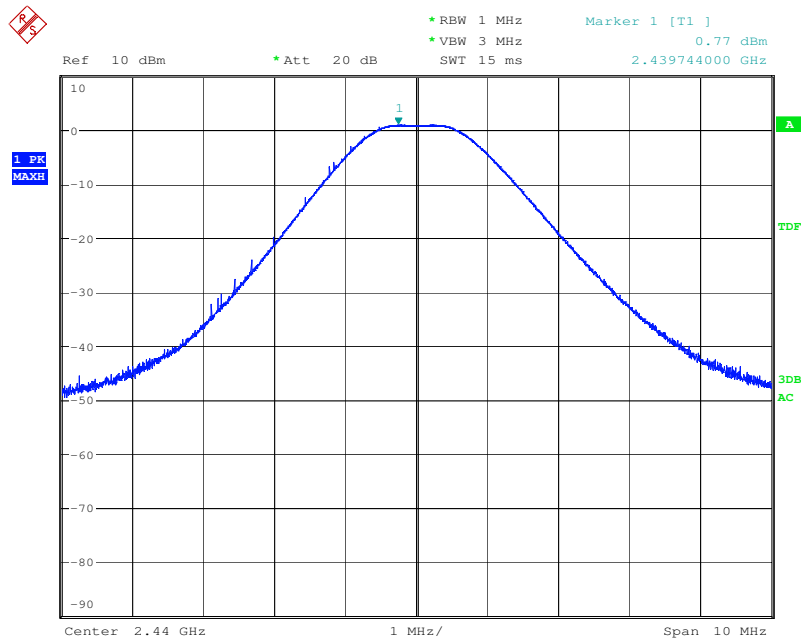

Tested Date: 08 Dec. 2015
 Humidity: 36 %

Temperature: 18 degC
 Atmos. Press: 1028 hPa

2.4 Conducted Spurious Emissions

Test setup

Test setup is the following drawing. The antenna port of EUT was connected to the spectrum analyzer.

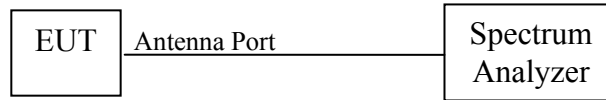

Test procedure

Spectrum analyzer is set as below according to ANSI C63.10 clause 7.8.8

- RBW : 100 kHz
- VBW : 300 kHz
- Detector : Peak
- Trace : Max hold

Limitation

15.247(d) In any 100 kHz bandwidth outside the frequency band in which the spread spectrum or digitally modulated intentional radiator is operating, the radio frequency power that is produced by the intentional radiator shall be at least 20 dB below that in the 100 kHz bandwidth within the band that contains the highest level of the desired power, based on either an RF conducted or a radiated measurement, provided the transmitter demonstrates compliance with the peak conducted power limits.

Test equipment used (refer to List of utilized test equipment)

TR06	CL31				
------	------	--	--	--	--

Test results - Complied with requirement

Test Data

Tested sample: AI
 Configuration: A

Operating mode: Tx (2402 MHz)

Frequency [MHz]	Spurious level [dBm]	Carrier level [dBm]	20dB below [dBm]
4804.5	-39.70	-0.56	-20.56
9607.1	-55.74	-0.56	-20.56

Operating mode: Tx (2440 MHz)

Frequency [MHz]	Spurious level [dBm]	Carrier level [dBm]	20dB below [dBm]
4880.5	-40.81	-0.16	-20.16
9761.1	-56.93	-0.16	-20.16

Operating mode: Tx (2480 MHz)

Frequency [MHz]	Spurious level [dBm]	Carrier level [dBm]	20dB below [dBm]
4960.6	-41.08	-0.25	-20.25
9920.9	-57.37	-0.25	-20.25

[Chart]

Tx 2440 MHz

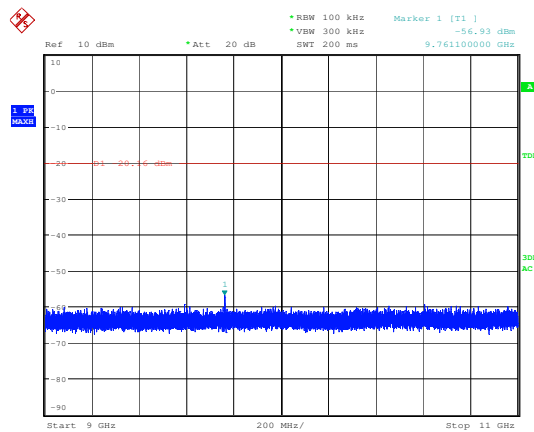
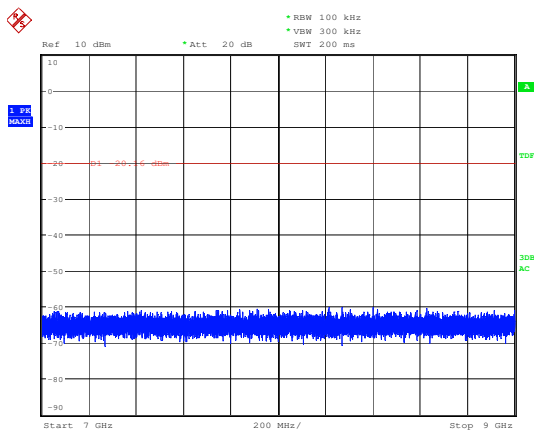
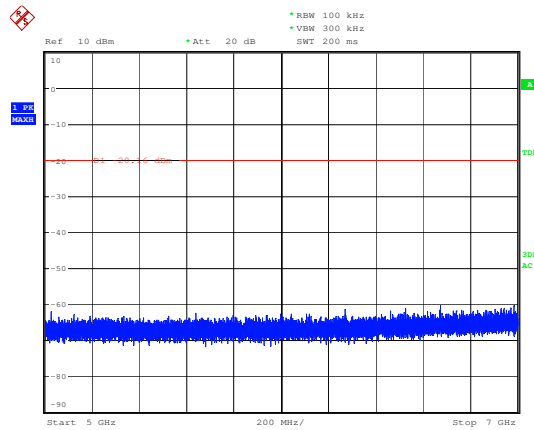
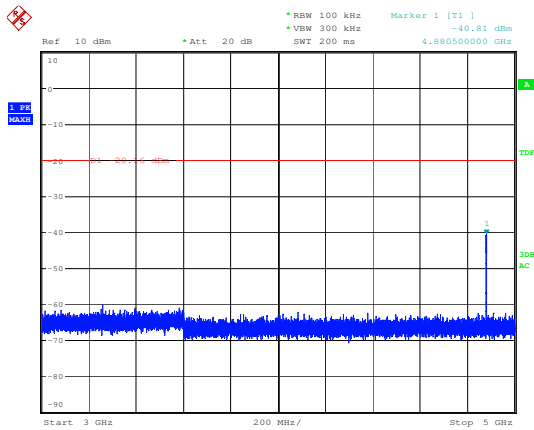
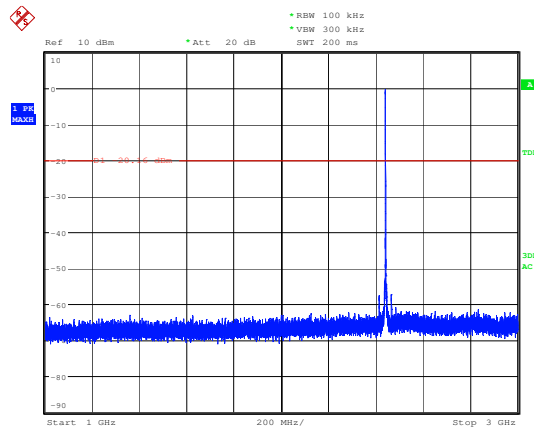
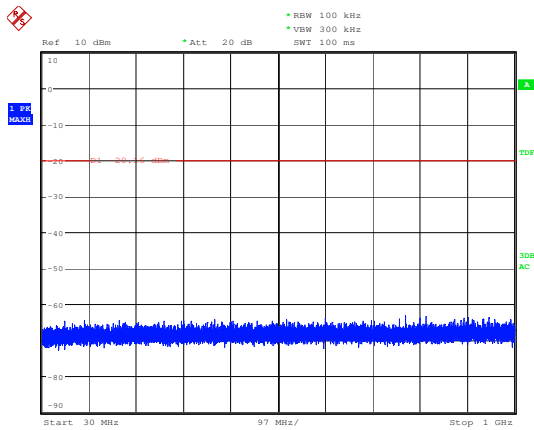

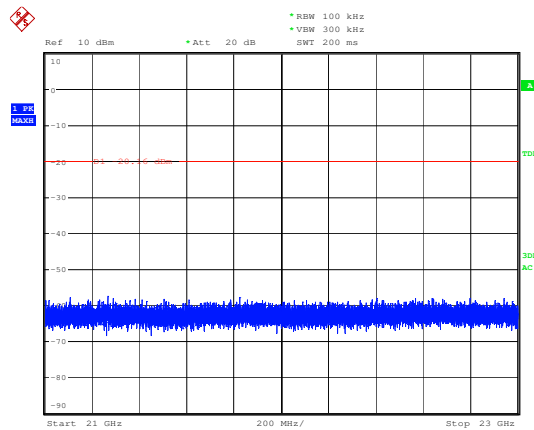
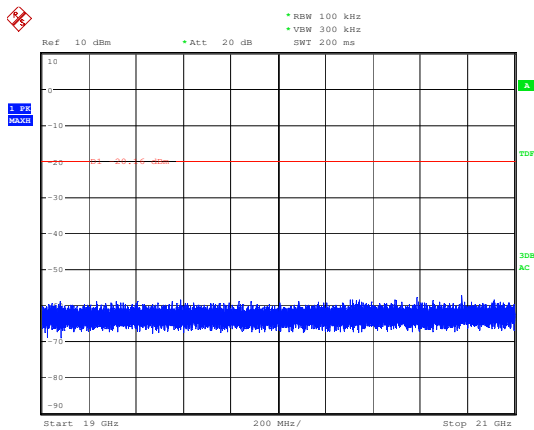
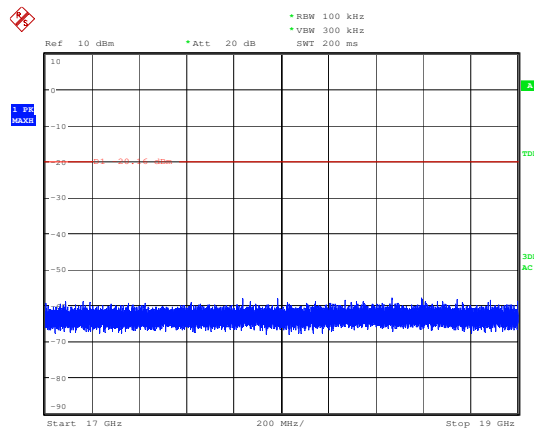
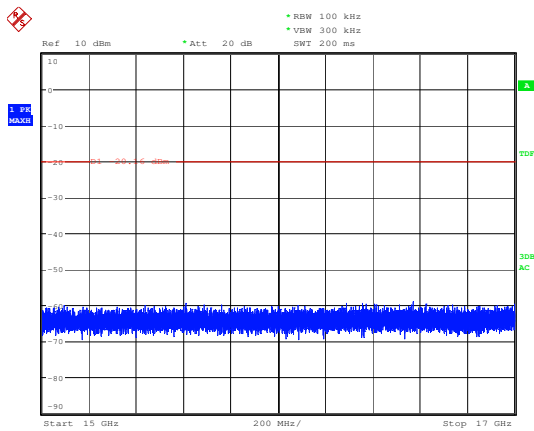
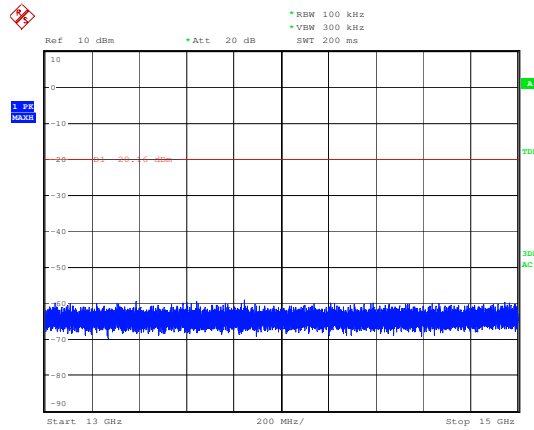
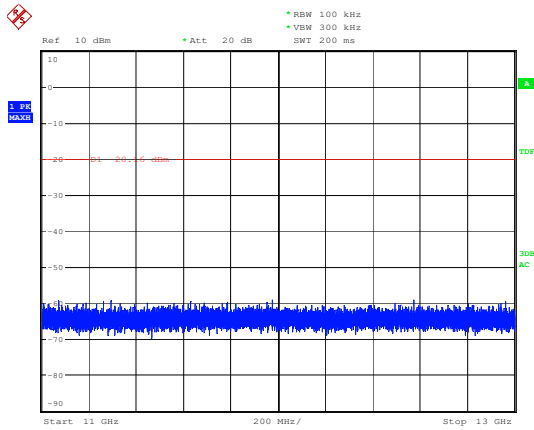

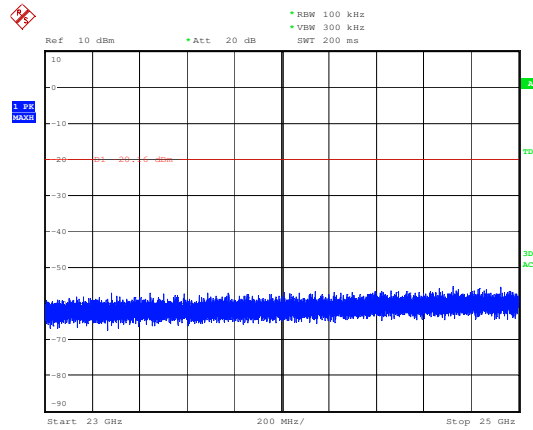

Tested Date: 08 Dec. 2015
 Humidity: 36 %

Temperature: 18 degC
 Atmos. Press: 1028 hPa

2.5 Power Spectral density

Test setup

Test setup is the following drawing. The antenna port of EUT was connected to the spectrum analyzer.



Test procedure

Spectrum analyzer is set as below according to ANSI C63.10 clause 11.10

- RBW : 3 kHz
- Span > 1.5 x 6dB BW
- Trace : Max hold
- VBW : 10 kHz
- Detector : Peak

Limitation

15.247(e) For digitally modulated systems, the power spectral density conducted from the intentional radiator to the antenna shall not be greater than 8 dBm in any 3 kHz band during any time interval of continuous transmission.

Test equipment used (refer to List of utilized test equipment)

TR06	CL31				
------	------	--	--	--	--

Test results - Complied with requirement

Test Data

Tested sample: A1

Configuration: A

Transmission Frequency [MHz]	Spectral Density [dBm]
2402	-13.50
2440	-13.12
2480	-12.80

[Chart]

Tx 2440 MHz

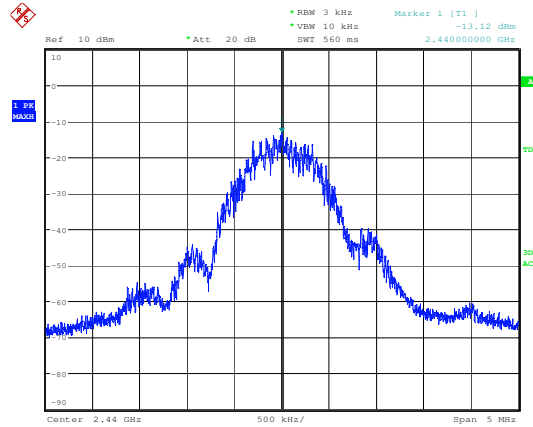

Tested Date: 08 Dec. 2015
 Humidity: 36 %

Temperature: 18 degC
 Atmos. Press: 1028 hPa

2.6 Radiated emissions (for restricted frequency band)

Test setup

Test setup was implemented according to the method of ANSI C63.10 clause 6 .

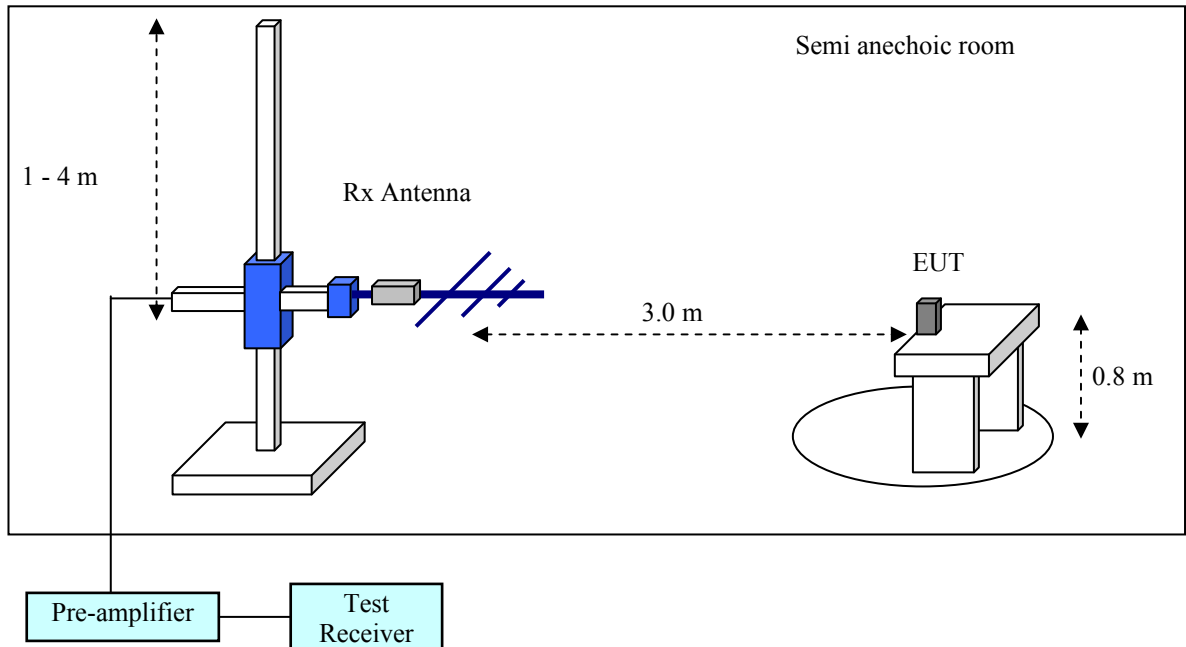

Test procedure

Measurement procedures were implemented according to the method of ANSI C63.10 clauses 6. The test receiver is set as below

[below 1000 MHz]
 RBW: 120 kHz, Detector: QP

[above 1000 MHz]
 RBW: 1 MHz, Detector: Ave/PK

Applicable rule and limitation

FCC 15.205 restricted bands of operation

Except as shown in paragraph 15.205 (d) of this section, only spurious emissions are permitted in any of the frequency bands listed below:

MHz	MHz	MHz	GHz
0.090 - 0.110	16.42 - 16.423	399.9 - 410	4.5 - 5.15
0.490 - 0.510	16.69475 - 16.69525	608 - 614	5.35 - 5.46
2.1735 - 2.1905	16.80425 - 16.80475	960 - 1240	7.25 - 7.75
4.125 - 4.128	25.5 - 25.67	1300 - 1427	8.025 - 8.5
4.17725 - 4.17775	37.5 - 38.25	1435 - 1626.5	9.0 - 9.2
4.20725 - 4.20775	73 - 74.6	1645.5 - 1646.5	9.3 - 9.5
6.215 - 6.218	74.8 - 75.2	1660 - 1710	10.6 - 12.7
6.26775 - 6.26825	108 - 121.94	1718.8 - 1722.2	13.25 - 13.4
6.31175 - 6.31225	123 - 138	2200 - 2300	14.47 - 14.5
8.291 - 8.294	149.9 - 150.05	2310 - 2390	15.35 - 16.2
8.362 - 8.366	156.52475 - 156.52525	2483.5 - 2500	17.7 - 21.4
8.37625 - 8.38675	156.7 - 156.9	2690 - 2900	22.01 - 23.12
8.41425 - 8.41475	162.0125 - 167.17	3260 - 3267	23.6 - 24.0
12.29 - 12.293	167.72 - 173.2	3332 - 3339	31.2 - 31.8
12.51975 - 12.52025	240 - 285	3345.8 - 3358	36.43 - 36.5
12.57675 - 12.57725	322 - 335.4	3600 - 4400	38.6 -

The field strength of emissions appearing within these frequency bands shall not exceed the limits shown in FCC 15.209. At frequencies equal to or less than 1000 MHz, compliance with the limits in FCC 15.209 shall be demonstrated using measurement instrumentation employing a CISPR quasi-peak detector. Above 1000 MHz, compliance with the emission limits in Section 15.209 shall be demonstrated based on the average value of the measured emissions.

FCC 15.209 Field strength limits

Frequency [MHz]	Field Strength [μ V/m]	Measurement Distance [m]	Field Strength [dB μ V/m]
30 – 88	100	3	40.0
88 – 216	150	3	43.5
216 – 960	200	3	46.0
Above 960	500	3	53.9

In the emission table above, the tighter limit applies at the band edges.

The emission limits shown in the above table are based on measurements employing a quasi-peak detector.

Test results - Complied with requirement

Test equipment used (refer to List of utilized test equipment)

AC01(EM)	CL11	TR06	PR15	BA10	CL30	CL31
PR12	DH01					

Test software used

EMI1 Ver. 2.9

Calculation method

The Correction Factor and Result are calculated as followings.

$$\text{Correction Factor [dB/m]} = \text{Ant. Factor [dB/m]} + \text{Loss [dB]} - \text{Gain [dB]}$$

$$\text{Result [dB}\mu\text{V/m]} = \text{Reading [dB}\mu\text{V]} + \text{Correction Factor [dB/m]}$$

Test Data

Tested sample: A2

Configuration: B

Operating mode: Tx (2402 MHz)

[Emission level] X-plane

No.	Frequency [MHz]	Reading PK [dB μ V]	Reading Ave [dB μ V]	C.Factor [dB]	Result PK [dB μ V/m]	Result Ave [dB μ V/m]	Limit PK [dB μ V/m]	Limit Ave [dB μ V/m]	Margin PK [dB]	Margin Ave [dB]	Ant.
1	4804.000	47.8	41.2	2.7	50.5	43.9	73.9	53.9	23.4	10.0	Hori.
2	4804.000	43.9	33.4	2.7	46.6	36.1	73.9	53.9	27.3	17.8	Vert.

[Emission level] Y-plane

No.	Frequency [MHz]	Reading PK [dB μ V]	Reading Ave [dB μ V]	C.Factor [dB]	Result PK [dB μ V/m]	Result Ave [dB μ V/m]	Limit PK [dB μ V/m]	Limit Ave [dB μ V/m]	Margin PK [dB]	Margin Ave [dB]	Ant.
1	4804.000	48.4	42.4	2.7	51.1	45.1	73.9	53.9	22.8	8.8	Hori.
2	4804.000	45.8	38.3	2.7	48.5	41.0	73.9	53.9	25.4	12.9	Vert.

[Emission level] Z-plane

No.	Frequency [MHz]	Reading PK [dB μ V]	Reading Ave [dB μ V]	C.Factor [dB]	Result PK [dB μ V/m]	Result Ave [dB μ V/m]	Limit PK [dB μ V/m]	Limit Ave [dB μ V/m]	Margin PK [dB]	Margin Ave [dB]	Ant.
1	4804.000	44.4	34.5	2.7	47.1	37.2	73.9	53.9	26.8	16.7	Hori.
2	4804.000	45.8	38.3	2.7	48.5	41.0	73.9	53.9	25.4	12.9	Vert.

All other emissions are under the noise floor.

Operating mode: Tx (2440 MHz)

[Emission level] X-plane

No.	Frequency [MHz]	Reading PK [dBμV]	Reading Ave [dBμV]	C.Factor [dB]	Result PK [dBμV/m]	Result Ave [dBμV/m]	Limit PK [dBμV/m]	Limit Ave [dBμV/m]	Margin PK [dB]	Margin Ave [dB]	Ant.
1	4880.000	47.8	40.9	2.9	50.7	43.8	73.9	53.9	23.2	10.1	Hori.
2	4880.000	44.8	34.0	2.9	47.7	36.9	73.9	53.9	26.2	17.0	Vert.

[Emission level] Y-plane

No.	Frequency [MHz]	Reading PK [dBμV]	Reading Ave [dBμV]	C.Factor [dB]	Result PK [dBμV/m]	Result Ave [dBμV/m]	Limit PK [dBμV/m]	Limit Ave [dBμV/m]	Margin PK [dB]	Margin Ave [dB]	Ant.
1	4880.000	47.2	40.7	2.9	50.1	43.6	73.9	53.9	23.8	10.3	Hori.
2	4880.000	46.0	38.2	2.9	48.9	41.1	73.9	53.9	25.0	12.8	Vert.

[Emission level] Z-plane

No.	Frequency [MHz]	Reading PK [dBμV]	Reading Ave [dBμV]	C.Factor [dB]	Result PK [dBμV/m]	Result Ave [dBμV/m]	Limit PK [dBμV/m]	Limit Ave [dBμV/m]	Margin PK [dB]	Margin Ave [dB]	Ant.
1	4880.000	44.7	35.8	2.9	47.6	38.7	73.9	53.9	26.3	15.2	Hori.
2	4880.000	50.0	44.2	2.9	52.9	47.1	73.9	53.9	21.0	6.8	Vert.

All other emissions are under the noise floor.

Operating mode: Tx (2480 MHz)

[Emission level] X-plane

No.	Frequency [MHz]	Reading PK [dBμV]	Reading Ave [dBμV]	C.Factor [dB]	Result PK [dBμV/m]	Result Ave [dBμV/m]	Limit PK [dBμV/m]	Limit Ave [dBμV/m]	Margin PK [dB]	Margin Ave [dB]	Ant.
1	4960.000	48.5	42.9	3.3	51.8	46.2	73.9	53.9	22.1	7.7	Hori.
2	4960.000	43.4	33.9	3.3	46.7	37.2	73.9	53.9	27.2	16.7	Vert.

[Emission level] Y-plane

No.	Frequency [MHz]	Reading PK [dBμV]	Reading Ave [dBμV]	C.Factor [dB]	Result PK [dBμV/m]	Result Ave [dBμV/m]	Limit PK [dBμV/m]	Limit Ave [dBμV/m]	Margin PK [dB]	Margin Ave [dB]	Ant.
1	4960.000	46.4	39.7	3.3	49.7	43.0	73.9	53.9	24.2	10.9	Hori.
2	4960.000	46.1	39.4	3.3	49.4	42.7	73.9	53.9	24.5	11.2	Vert.

[Emission level] Z-plane

No.	Frequency [MHz]	Reading PK [dBμV]	Reading Ave [dBμV]	C.Factor [dB]	Result PK [dBμV/m]	Result Ave [dBμV/m]	Limit PK [dBμV/m]	Limit Ave [dBμV/m]	Margin PK [dB]	Margin Ave [dB]	Ant.
1	4960.000	43.7	33.9	3.3	47.0	37.2	73.9	53.9	26.9	16.7	Hori.
2	4960.000	47.4	41.2	3.3	50.7	44.5	73.9	53.9	23.2	9.4	Vert.

All other emissions are under the noise floor.

[Result (Band edge)]

Operating mode: Tx (2402 MHz)

[Emission level] X-plane

No.	Frequency [MHz]	Reading PK [dBμV]	Reading Ave [dBμV]	C.Factor [dB]	Result PK [dBμV/m]	Result Ave [dBμV/m]	Limit PK [dBμV/m]	Limit Ave [dBμV/m]	Margin PK [dB]	Margin Ave [dB]	Ant.
1	2376.000	47.8	40.4	-4.5	43.3	35.9	73.9	53.9	30.6	18.0	Hori.

[Emission level] Y-plane

No.	Frequency [MHz]	Reading PK [dBμV]	Reading Ave [dBμV]	C.Factor [dB]	Result PK [dBμV/m]	Result Ave [dBμV/m]	Limit PK [dBμV/m]	Limit Ave [dBμV/m]	Margin PK [dB]	Margin Ave [dB]	Ant.
1	2376.000	47.2	37.2	-4.5	42.7	32.7	73.9	53.9	31.2	21.2	Hori.

[Emission level] Z-plane

No.	Frequency [MHz]	Reading PK [dBμV]	Reading Ave [dBμV]	C.Factor [dB]	Result PK [dBμV/m]	Result Ave [dBμV/m]	Limit PK [dBμV/m]	Limit Ave [dBμV/m]	Margin PK [dB]	Margin Ave [dB]	Ant.
1	2376.000	47.5	40.2	-4.5	43.0	35.7	73.9	53.9	30.9	18.2	Vert.

Operating mode: Tx (2480 MHz)

[Emission level] X-plane

No.	Frequency [MHz]	Reading PK [dBμV]	Reading Ave [dBμV]	C.Factor [dB]	Result PK [dBμV/m]	Result Ave [dBμV/m]	Limit PK [dBμV/m]	Limit Ave [dBμV/m]	Margin PK [dB]	Margin Ave [dB]	Ant.
1	2483.500	55.2	42.0	-3.5	51.7	38.5	73.9	53.9	22.2	15.4	Hori.

[Emission level] Y-plane

No.	Frequency [MHz]	Reading PK [dBμV]	Reading Ave [dBμV]	C.Factor [dB]	Result PK [dBμV/m]	Result Ave [dBμV/m]	Limit PK [dBμV/m]	Limit Ave [dBμV/m]	Margin PK [dB]	Margin Ave [dB]	Ant.
1	2483.500	55.5	42.4	-3.5	52.0	38.9	73.9	53.9	21.9	15.0	Hori.

[Emission level] Z-plane

No.	Frequency [MHz]	Reading PK [dBμV]	Reading Ave [dBμV]	C.Factor [dB]	Result PK [dBμV/m]	Result Ave [dBμV/m]	Limit PK [dBμV/m]	Limit Ave [dBμV/m]	Margin PK [dB]	Margin Ave [dB]	Ant.
1	2483.500	55.2	42.3	-3.5	51.7	38.8	73.9	53.9	22.2	15.1	Vert.

[Chart (Band edge)]

Tx 2402 MHz (X-plane)

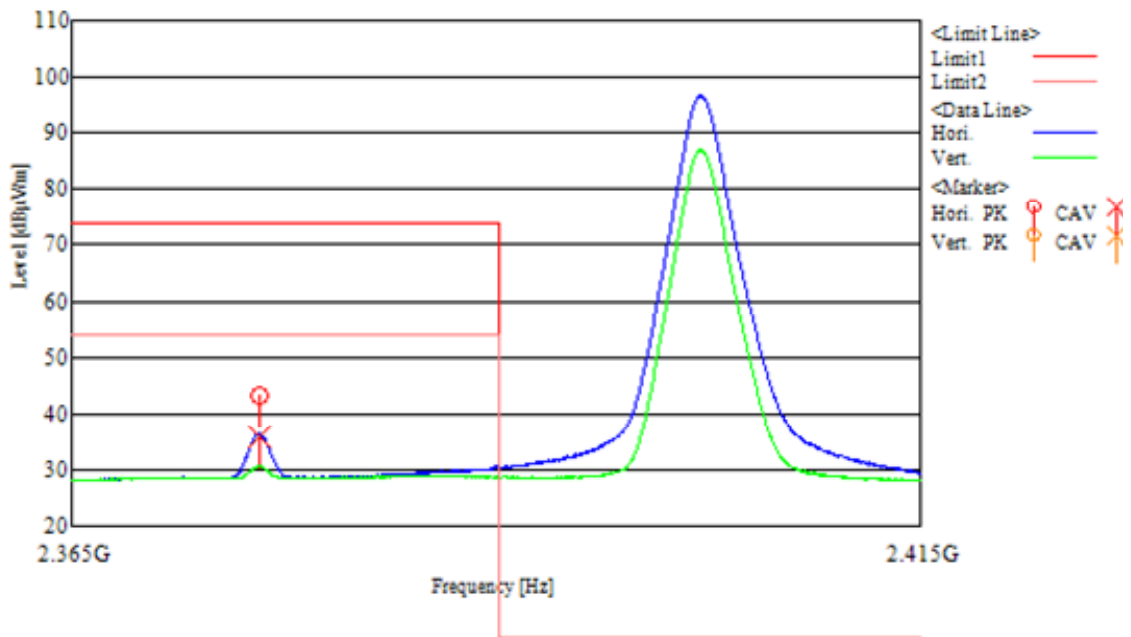

Tx 2480 MHz (Y-plane)

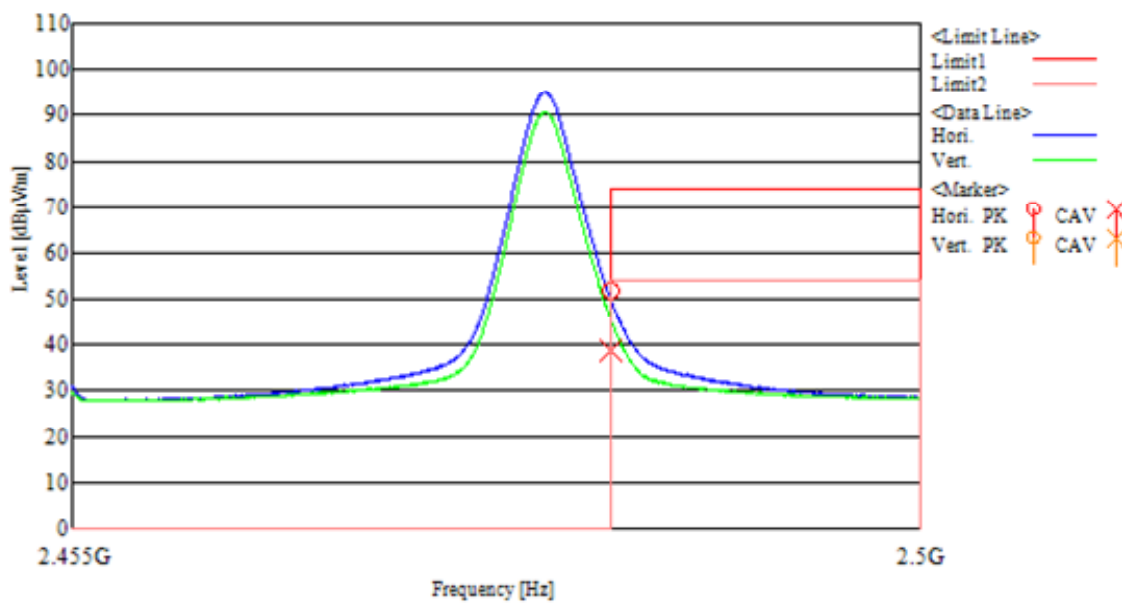

[30 - 1000 MHz testing]

Tested Date: 08 Dec. 2015
 Humidity: 36 %

Temperature: 18 degC
 Atmos. Press: 1028 hPa

[above 1000 MHz testing]

Tested Date: 07 Dec. 2015
 Humidity: 36 %

Temperature: 17 degC
 Atmos. Press: 1027 hPa

2.7 AC power line conducted emissions

Test setup

Test setup was implemented according to the method of ANSI C63.10 clause 6.2 .

Test procedure

Measurement procedures were implemented according to the method of ANSI C63.10 clause 6.2.

Applicable rule and limitation

FCC 15.207 AC power line conducted emissions limits

Frequency of Emission [MHz]	Conducted emissions Limit [dB μ V]	
	Quasi-peak	Average
0.15 - 0.5	66 to 56 *	56 to 46 *
0.5 - 5	56	46
5 - 30	60	50

* Decreases with the logarithm of the frequency. The lower limit applies at the band edges.

Test equipment used (refer to List of utilized test equipment)

TR09	CL18	LN05
------	------	------

Test software used

EMI1 Ver. 2.9

Calculation method

The Correction Factor and Result are calculated as followings.

$$\begin{aligned} \text{Correction Factor [dB]} &= \text{ISN Factor [dB]} + \text{Loss [dB]} \\ \text{Result [dB}\mu\text{V]} &= \text{Reading [dB}\mu\text{V]} + \text{Correction Factor [dB]} \end{aligned}$$

Test results - Complied with requirement

Test Data

Tested sample: A2

Configuration: A

Operating mode: Tx (2402 MHz)

[Emission level]

No.	Frequency [MHz]	Reading		C.F. [dB]	Result		Limit		Phase	Pass/Fail
		QP [dB μ V]	AV [dB μ V]		QP [dB μ V]	AV [dB μ V]	QP [dB μ V]	AV [dB μ V]		
1	0.15000	30.7	10.4	10.2	40.9	20.6	66.0	56.0	Va	Pass
2	0.15259	30.2	10.1	10.2	40.4	20.3	65.9	55.9	Va	Pass
3	0.17811	26.8	7.9	10.1	36.9	18.0	64.6	54.6	Va	Pass
4	0.15000	30.6	11.2	10.2	40.8	21.4	66.0	56.0	Vb	Pass
5	0.16480	28.4	10.1	10.2	38.6	20.3	65.2	55.2	Vb	Pass
6	0.23175	21.4	10.3	10.1	31.5	20.4	62.4	52.4	Vb	Pass

Operating mode: Tx (2440 MHz)

[Emission level]

No.	Frequency [MHz]	Reading		C.F. [dB]	Result		Limit		Phase	Pass/Fail
		QP [dB μ V]	AV [dB μ V]		QP [dB μ V]	AV [dB μ V]	QP [dB μ V]	AV [dB μ V]		
1	0.15000	30.8	10.5	10.2	41.0	20.7	66.0	56.0	Va	Pass
2	0.17996	26.7	8.2	10.1	36.8	18.3	64.5	54.5	Va	Pass
3	0.44890	12.3	5.7	10.0	22.3	15.7	56.9	46.9	Va	Pass
4	0.15000	30.5	11.2	10.2	40.7	21.4	66.0	56.0	Vb	Pass
5	0.15888	29.2	10.5	10.2	39.4	20.7	65.5	55.5	Vb	Pass
6	0.16628	28.2	9.9	10.2	38.4	20.1	65.1	55.1	Vb	Pass

Operating mode: Tx (2480 MHz)

[Emission level]

No.	Frequency [MHz]	Reading		C.F. [dB]	Result		Limit		Phase	Pass/Fail
		QP [dB μ V]	AV [dB μ V]		QP [dB μ V]	AV [dB μ V]	QP [dB μ V]	AV [dB μ V]		
1	0.15000	30.7	10.3	10.2	40.9	20.5	66.0	56.0	Va	Pass
2	0.16073	29.0	9.2	10.2	39.2	19.4	65.4	55.4	Va	Pass
3	0.16591	28.3	8.8	10.2	38.5	19.0	65.2	55.2	Va	Pass
4	0.15000	30.5	11.1	10.2	40.7	21.3	66.0	56.0	Vb	Pass
5	0.15148	30.3	11.0	10.2	40.5	21.2	65.9	55.9	Vb	Pass
6	0.15666	29.5	10.6	10.2	39.7	20.8	65.6	55.6	Vb	Pass

Operating mode: Rx (2402 MHz)

[Emission level]

No.	Frequency [MHz]	Reading		C.F. [dB]	Result		Limit		Phase	Pass/Fail
		QP [dB μ V]	AV [dB μ V]		QP [dB μ V]	AV [dB μ V]	QP [dB μ V]	AV [dB μ V]		
1	0.15000	30.5	10.2	10.2	40.7	20.4	66.0	56.0	Va	Pass
2	0.16961	27.7	8.3	10.2	37.9	18.5	65.0	55.0	Va	Pass
3	0.44927	12.5	4.9	10.0	22.5	14.9	56.9	46.9	Va	Pass
4	0.15000	30.3	10.9	10.2	40.5	21.1	66.0	56.0	Vb	Pass
5	0.16147	28.6	10.0	10.2	38.8	20.2	65.4	55.4	Vb	Pass
6	0.16850	27.9	9.7	10.2	38.1	19.9	65.0	55.0	Vb	Pass

Operating mode: Rx (2440 MHz)

[Emission level]

No.	Frequency [MHz]	Reading		C.F. [dB]	Result		Limit		Phase	Pass/Fail
		QP [dB μ V]	AV [dB μ V]		QP [dB μ V]	AV [dB μ V]	QP [dB μ V]	AV [dB μ V]		
1	0.15000	30.5	10.2	10.2	40.7	20.4	66.0	56.0	Va	Pass
2	0.15481	29.8	9.7	10.2	40.0	19.9	65.7	55.7	Va	Pass
3	0.15777	29.3	9.3	10.2	39.5	19.5	65.6	55.6	Va	Pass
4	0.15000	30.4	11.0	10.2	40.6	21.2	66.0	56.0	Vb	Pass
5	0.15814	29.2	10.3	10.2	39.4	20.5	65.6	55.6	Vb	Pass
6	0.19624	25.1	9.9	10.1	35.2	20.0	63.8	53.8	Vb	Pass

Operating mode: Rx (2480 MHz)

[Emission level]

No.	Frequency [MHz]	Reading		C.F. [dB]	Result		Limit		Phase	Pass/Fail
		QP [dB μ V]	AV [dB μ V]		QP [dB μ V]	AV [dB μ V]	QP [dB μ V]	AV [dB μ V]		
1	0.15148	30.3	10.0	10.2	40.5	20.2	65.9	55.9	Va	Pass
2	0.16258	28.5	8.8	10.2	38.7	19.0	65.3	55.3	Va	Pass
3	0.16924	27.7	8.3	10.2	37.9	18.5	65.0	55.0	Va	Pass
4	0.15000	30.3	11.0	10.2	40.5	21.2	66.0	56.0	Vb	Pass
5	0.15888	28.9	10.2	10.2	39.1	20.4	65.5	55.5	Vb	Pass
6	0.16406	28.4	9.9	10.2	38.6	20.1	65.3	55.3	Vb	Pass

[Chart]

Operating mode: Tx (2440 MHz)

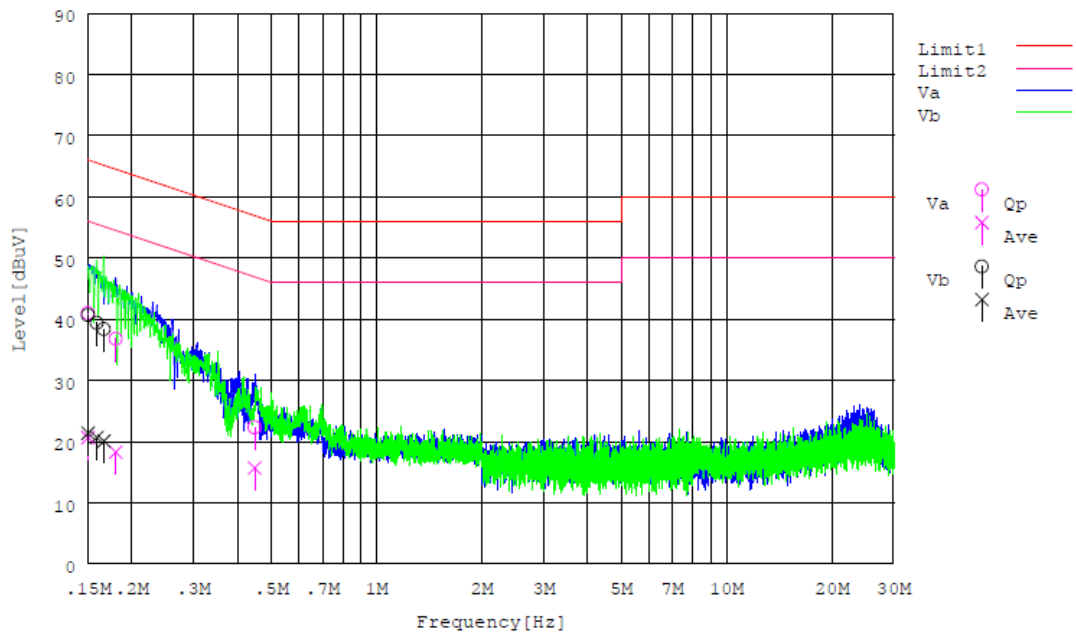

Tested Date: 07 Dec. 2015
 Humidity: 44 %

Temperature: 17 degC
 Atmos. Press: 1028 hPa

2.8 Receiver radiated emissions

Test setup

Test setup was implemented according to the method of ANSI C63.4 clause 8.3 .

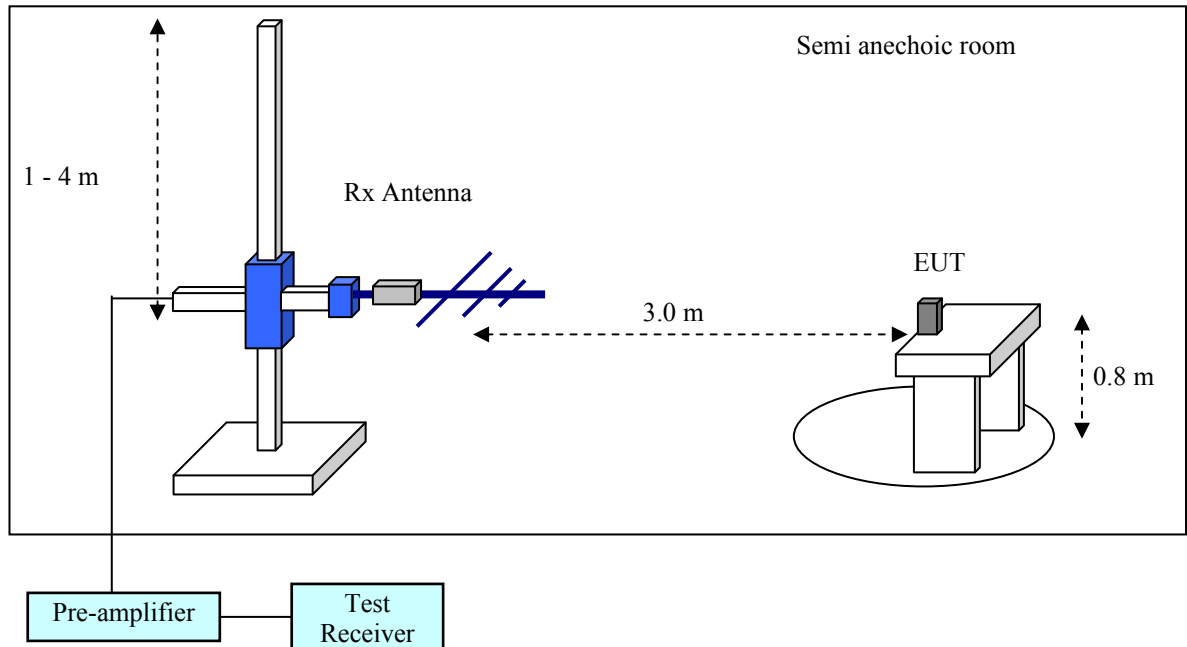

Test procedure

Measurement procedures were implemented according to the method of ANSI C63.4 clauses 8.3.
 The test receiver is set as below

[below 1000 MHz]
 RBW: 120 kHz, Detector: QP

[above 1000 MHz]
 RBW: 1 MHz, Detector: Ave/PK

Applicable rule and limitation

RSS-Gen 7.1.2 Field strength limits

Frequency [MHz]	Field Strength [$\mu\text{V/m}$]	Measurement Distance [m]	Field Strength [$\text{dB}\mu\text{V/m}$]
30 – 88	100	3	40.0
88 – 216	150	3	43.5
216 – 960	200	3	46.0
Above 960	500	3	53.9

In the emission table above, the tighter limit applies at the band edges.

The emission limits shown in the above table are based on measurements employing a quasi-peak detector.

Test results - Complied with requirement

Test equipment used (refer to List of utilized test equipment)

AC01(EM)	CL11	TR06	PR15	BA10	CL30	CL31
PR12	DH01					

Test software used

EMI1 Ver. 2.9

Calculation method

The Correction Factor and Result are calculated as followings.

$$\text{Correction Factor [dB/m]} = \text{Ant. Factor [dB/m]} + \text{Loss [dB]} - \text{Gain [dB]}$$

$$\text{Result [dB}\mu\text{V/m]} = \text{Reading [dB}\mu\text{V]} + \text{Correction Factor [dB/m]}$$

Test Data

Tested sample: A2

Configuration: B

Operating mode: Rx (2402 MHz)

[Emission level] X-plane

No.	Frequency [MHz]	Reading PK [dB μ V]	Reading Ave [dB μ V]	C.Factor [dB]	Result PK [dB μ V/m]	Result Ave [dB μ V/m]	Limit PK [dB μ V/m]	Limit Ave [dB μ V/m]	Margin PK [dB]	Margin Ave [dB]	Ant.
1	2133.186	50.2	45.3	-4.9	45.3	40.4	73.9	53.9	28.6	13.5	Hori.
2	2399.833	45.9	37.3	-4.3	41.6	33.0	73.9	53.9	32.3	20.9	Hori.
3	2133.187	47.5	38.6	-4.9	42.6	33.7	73.9	53.9	31.3	20.2	Vert.

[Emission level] Y-plane

No.	Frequency [MHz]	Reading PK [dB μ V]	Reading Ave [dB μ V]	C.Factor [dB]	Result PK [dB μ V/m]	Result Ave [dB μ V/m]	Limit PK [dB μ V/m]	Limit Ave [dB μ V/m]	Margin PK [dB]	Margin Ave [dB]	Ant.
1	2133.185	50.1	44.8	-4.9	45.2	39.9	73.9	53.9	28.7	14.0	Hori.
2	2133.187	47.2	39.2	-4.9	42.3	34.3	73.9	53.9	31.6	19.6	Vert.
3											

[Emission level] Z-plane

No.	Frequency [MHz]	Reading PK [dB μ V]	Reading Ave [dB μ V]	C.Factor [dB]	Result PK [dB μ V/m]	Result Ave [dB μ V/m]	Limit PK [dB μ V/m]	Limit Ave [dB μ V/m]	Margin PK [dB]	Margin Ave [dB]	Ant.
1	2133.184	48.1	41.7	-4.9	43.2	36.8	73.9	53.9	30.7	17.1	Hori.
2	2133.185	50.2	45.0	-4.9	45.3	40.1	73.9	53.9	28.6	13.8	Vert.
3	2399.835	46.1	38.4	-4.3	41.8	34.1	73.9	53.9	32.1	19.8	Vert.

All other emissions are under the noise floor.

Operating mode: Rx (2440 MHz)

[Emission level] X-plane

No.	Frequency [MHz]	Reading PK [dB μ V]	Reading Ave [dB μ V]	C.Factor [dB]	Result PK [dB μ V/m]	Result Ave [dB μ V/m]	Limit PK [dB μ V/m]	Limit Ave [dB μ V/m]	Margin PK [dB]	Margin Ave [dB]	Ant.
1	2166.964	51.6	47.6	-5.1	46.5	42.5	73.9	53.9	27.4	11.4	Hori.
2	2437.835	46.0	36.2	-3.9	42.1	32.3	73.9	53.9	31.8	21.6	Hori.
3	2166.963	47.8	40.1	-5.1	42.7	35.0	73.9	53.9	31.2	18.9	Vert.

[Emission level] Y-plane

No.	Frequency [MHz]	Reading PK [dB μ V]	Reading Ave [dB μ V]	C.Factor [dB]	Result PK [dB μ V/m]	Result Ave [dB μ V/m]	Limit PK [dB μ V/m]	Limit Ave [dB μ V/m]	Margin PK [dB]	Margin Ave [dB]	Ant.
1	2166.963	51.0	46.4	-5.1	45.9	41.3	73.9	53.9	28.0	12.6	Hori.
2	2166.964	48.3	40.8	-5.1	43.2	35.7	73.9	53.9	30.7	18.2	Vert.
3											

[Emission level] Z-plane

No.	Frequency [MHz]	Reading PK [dB μ V]	Reading Ave [dB μ V]	C.Factor [dB]	Result PK [dB μ V/m]	Result Ave [dB μ V/m]	Limit PK [dB μ V/m]	Limit Ave [dB μ V/m]	Margin PK [dB]	Margin Ave [dB]	Ant.
1	2166.963	48.7	43.0	-5.1	43.6	37.9	73.9	53.9	30.3	16.0	Hori.
2	2437.837	45.4	34.1	-3.9	41.5	30.2	73.9	53.9	32.4	23.7	Hori.
3	2166.964	51.6	47.7	-5.1	46.5	42.6	73.9	53.9	27.4	11.3	Vert.
4	2437.833	46.3	36.4	-3.9	42.4	32.5	73.9	53.9	31.5	21.4	Vert.

All other emissions are under the noise floor.

Operating mode: Rx (2480 MHz)

[Emission level] X-plane

No.	Frequency [MHz]	Reading PK [dB μ V]	Reading Ave [dB μ V]	C.Factor [dB]	Result PK [dB μ V/m]	Result Ave [dB μ V/m]	Limit PK [dB μ V/m]	Limit Ave [dB μ V/m]	Margin PK [dB]	Margin Ave [dB]	Ant.
1	2202.521	51.2	47.7	-5.2	46.0	42.5	73.9	53.9	27.9	11.4	Hori.
2	2477.834	46.0	36.5	-3.5	42.5	33.0	73.9	53.9	31.4	20.9	Hori.
3	2202.519	46.2	39.0	-5.2	41.0	33.8	73.9	53.9	32.9	20.1	Vert.

[Emission level] Y-plane

No.	Frequency [MHz]	Reading PK [dB μ V]	Reading Ave [dB μ V]	C.Factor [dB]	Result PK [dB μ V/m]	Result Ave [dB μ V/m]	Limit PK [dB μ V/m]	Limit Ave [dB μ V/m]	Margin PK [dB]	Margin Ave [dB]	Ant.
1	2202.519	51.4	47.7	-5.2	46.2	42.5	73.9	53.9	27.7	11.4	Hori.
2	2477.833	46.2	36.0	-3.5	42.7	32.5	73.9	53.9	31.2	21.4	Hori.
3	2202.520	48.5	43.3	-5.2	43.3	38.1	73.9	53.9	30.6	15.8	Vert.

[Emission level] Z-plane

No.	Frequency [MHz]	Reading PK [dB μ V]	Reading Ave [dB μ V]	C.Factor [dB]	Result PK [dB μ V/m]	Result Ave [dB μ V/m]	Limit PK [dB μ V/m]	Limit Ave [dB μ V/m]	Margin PK [dB]	Margin Ave [dB]	Ant.
1	2202.520	48.2	42.7	-5.2	43.0	37.5	73.9	53.9	30.9	16.4	Hori.
2	2202.521	52.2	49.5	-5.2	47.0	44.3	73.9	53.9	26.9	9.6	Vert.
3	2477.836	46.6	37.4	-3.5	43.1	33.9	73.9	53.9	30.8	20.0	Vert.

All other emissions are under the noise floor.

[Chart (worst)]

Tx 2480 MHz (Z-plane)

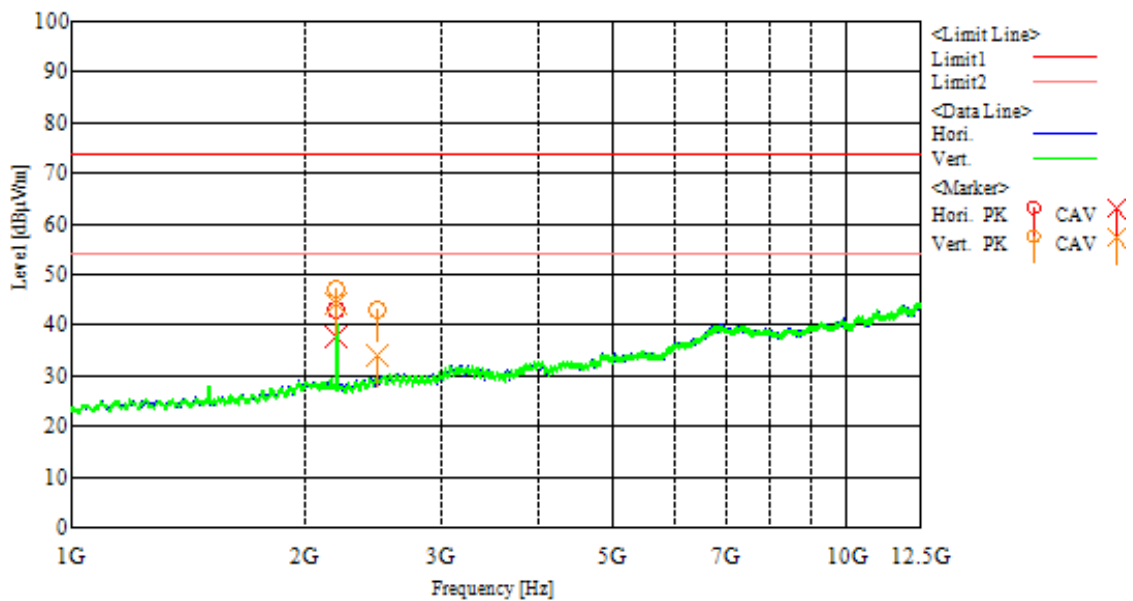
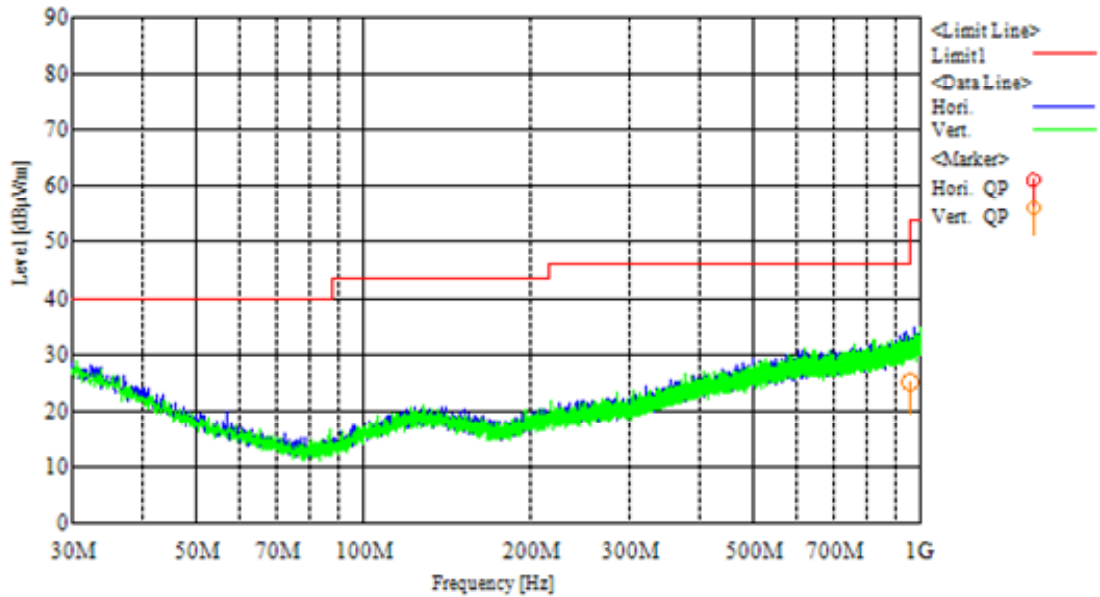

[30 - 1000 MHz testing]

Tested Date:	08 Dec. 2015	Temperature:	18 degC
Humidity:	36 %	Atmos. Press:	1028 hPa

[above 1000 MHz testing]

Tested Date:	07 Dec. 2015	Temperature:	17 degC
Humidity:	36 %	Atmos. Press:	1027 hPa

4 List of utilized test equipment / calibration

RFT ID No.	Kind of Equipment and Precision	Manufacturer	Model No.	Serial Number	Calibration Date	Calibrated until
AC01(EM)	Anechoic Chamber (1st test room)	JSE	203397C	-	2015/4/18	2016/4/30
AC01(EG)	Anechoic Chamber (1st test room)	JSE	203397C	-	2015/11/3	2016/11/30
BA10	Biological Antenna	TESEQ	CBL6111D	32342	2015/6/12	2016/6/30
CH01	Conical Horn Antenna (12-18GHz)	ETS-Lindgren	3163-05	00126641	2014/7/3	2016/7/31
CL11	RF Cable for RE	RFT	-	-	2015/3/13	2016/3/31
CL18	RF Cable for CE	RFT	-	-	2015/5/1	2016/5/31
CL29	RF Cable 2 m	SUHNER	SUCOFLEX104PE	94709	2015/8/25	2016/8/31
CL30	RF Cable 5 m	SUHNER	SUCOFLEX104PE	MY3599	2015/8/25	2016/8/31
CL31	RF Cable 1 m	Junkosha	MWX221	1303S118	2015/11/24	2016/11/30
DH01	DRG Horn Antenna	A.H. Systems	SAS-571	785	2014/1/21	2016/1/31
LN05	LISN	Kyoritsu	KNW-407F	8-1773-2	2015/6/2	2016/6/30
LPF1	Low Pass Filter (1000MHz)	M-City	LPF1000-04	RF0012-01	2015/2/23	2016/2/29
PR12	Pre. Amplifier (1-26G)	Agilent Technologies	8449B	3008A02513	2015/1/26	2016/1/31
PR15	Pre. Amplifier	Anritsu	MH648A	6201156141	2015/6/13	2016/6/30
SH01	Standard Horn Antenna (18-26G)	A.H. Systems	SAS-572	208	2014/7/3	2016/7/31
TR06	Test Receiver (F/W : 3.93 SP2)	Rohde & Schwarz	ESU26	100002	2015/9/28	2016/9/30
TR09	Test Receiver (F/W : 4.43 SP3)	Rohde & Schwarz	ESU8	100386	2015/2/13	2016/2/29

The measuring equipment, which was utilized in performing the tests documented herein, has been calibrated in accordance with the manufacturer's recommendations for utilizing calibration equipment, which is traceable to recognized national standards.