



FCC ID: 2ACIA-TTBT008
Report No.: T180528N06-RP1-2

Page: 1 / 62
Rev.: 00

FCC 47 CFR PART 15 SUBPART C AND ANSI C63.10: 2013

TEST REPORT

For

30W Wall Plate Audio Amplifier with CSR Bluetooth v4.2

Model: A-1430WP

Brand: N/A

Issued for

Ten Tronics Co., Ltd.

No.33, Lane 347, Chung-San S.Road Young-Kang District, Tainan, Taiwan 710

Issued by

Compliance Certification Services Inc.

Tainan Lab.

No.8, Jiucengling, Xinhua Dist., Tainan City 712, Taiwan (R.O.C.)

TEL: 886-6-580-2201

FAX: 886-6-580-2202

Issued Date: October 30, 2018

Note: This report shall not be reproduced except in full, without the written approval of Compliance Certification Services Inc. Ltd. This document may be altered or revised by Compliance Certification Services Inc. personnel only, and shall be noted in the revision section of the document

Unless otherwise stated the results shown in this test report refer only to the sample(s) tested and such sample(s) are retained for 90 days only.
除非另有說明，此報告結果僅對測試之樣品負責，同時此樣品僅保留90天。本報告未經本公司書面許可，不可部分複製。

This document is issued by the Company subject to its General Conditions of Service printed overleaf, available on request or accessible at www.sgs.com/terms_and_conditions.htm and for electronic format documents, subject to Terms and Conditions for Electronic Documents at www.sgs.com/terms_e-document.htm. Attention is drawn to the limitation of liability, indemnification and jurisdiction issues defined therein. Any holder of this document is advised that information contained hereon reflects the Company's findings at the time of its intervention only and within the limits of Client's instructions, if any. The Company's sole responsibility is to its Client and this document does not exonerate parties to a transaction from exercising all their rights and obligations under the transaction documents. This document cannot be reproduced except in full, without prior written approval of the Company. Any unauthorized alteration, forgery or falsification of the content or appearance of this document is unlawful and offenders may be prosecuted to the fullest extent of the law.



Report No.: T180528N06-RP1-2

Page: 2 / 62
Rev.: 00

REVISION HISTORY

Rev.	Issue Date	Revisions	Effect Page	Revised By
00	October 30, 2018	Initial Issue	ALL	Gina Lin

TABLE OF CONTENTS

1. TEST REPORT CERTIFICATION	4
2. TEST RESULT SUMMARY	5
3. EUT DESCRIPTION.....	6
3.1 DESCRIPTION OF EUT & POWER.....	6
4. DESCRIPTION OF TEST MODES.....	7
5. TEST METHODOLOGY.....	8
6. FACILITIES AND ACCREDITATIONS	8
6.1 FACILITIES	8
6.2 EQUIPMENT	8
6.3 LABORATORY ACCREDITATIONS LISTINGS.....	8
6.4 TABLE OF ACCREDITATIONS AND LISTINGS	9
7. CALIBRATION AND UNCERTAINTY	10
7.1 MEASURING INSTRUMENT CALIBRATION	11
7.2 MEASUREMENT UNCERTAINTY	11
8. SETUP OF EQUIPMENT UNDER TEST	12
8.1 SETUP CONFIGURATION OF EUT	12
8.2 SUPPORT EQUIPMENT	13
8.3 EUT OPERATING CONDITION	14
9. APPLICABLE LIMITS AND TEST RESULTS	15
9.1 6dB BANDWIDTH	15
9.2 MAXIMUM PEAK OUTPUT POWER	19
9.3 DUTY CYCLE.....	25
9.4 POWER SPECTRAL DENSITY	30
9.5 CONDUCTED SPURIOUS EMISSION	34
9.6 RADIATED EMISSIONS	39
9.7 POWERLINE CONDUCTED EMISSIONS	53
10. ANTENNA REQUIREMENT	57
10.1 STANDARD APPLICABLE.....	57
10.2 ANTENNA CONNECTED CONSTRUCTION.....	57
APPENDIX I SETUP PHOTOS.....	58

1. TEST REPORT CERTIFICATION

Applicant : Ten Tronics Co., Ltd.
No.33, Lane 347, Chung-San S.Road Young-Kang District,
Tainan, Taiwan 710

Manufacturer : Ten Tronics Co., Ltd.
No.33, Lane 347, Chung-San S.Road Young-Kang District,
Tainan, Taiwan 710

Equipment Under Test : 30W Wall Plate Audio Amplifier with CSR Bluetooth v4.2

Model Number : A-1430WP

Brand Name : N/A

Date of Test : September 25, 2018 ~ October 05, 2018

APPLICABLE STANDARD	
STANDARD	TEST RESULT
FCC Part 15 Subpart C AND ANSI C63.10: 2013	No non-compliance noted

Approved by:



Jeter Wu
Assistant Manager

Reviewed by:

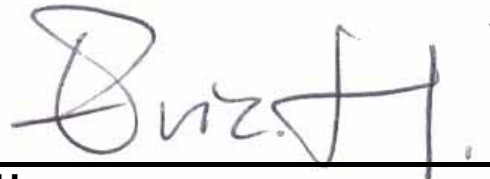

Eric Huang
Section Manager

2. TEST RESULT SUMMARY

FCC Standard Section	Report Section	Test Item	Result
15.247(a)	9.1	6dB BANDWIDTH	Pass
15.247(b)	9.2	MAXIMUM PEAK OUTPUT POWER	Pass
-	9.3	DUTY CYCLE	-
15.247(e)	9.4	POWER SPECTRAL DENSITY	Pass
15.247(d)	9.5	CONDUCTED SPURIOUS EMISSION	Pass
15.205(a)	9.6	RADIATED EMISSIONS	Pass
15.207(a)	9.7	POWERLINE CONDUCTED EMISSIONS	Pass
15.203	10	ANTENNA REQUIREMENT	Pass

3. EUT DESCRIPTION

3.1 DESCRIPTION OF EUT & POWER

Product Name	30W Wall Plate Audio Amplifier with CSR Bluetooth v4.2
Model Number	A-1430WP
Brand Name	N/A
Received Date	May 28, 2018
Operating Frequency Range	DSSS Mode : 2402MHz~2480MHz
Transmit Power	DSSS Mode : 3.80dBm (2.39607mW)
Channel Spacing	DSSS Mode : 2 MHz
Channel Number	DSSS Mode : 40 Channels
Transmit Data Rate	DSSS Mode : 24 Mbps
Type of Modulation	DSSS
Antenna Type	Manufacturer: Ten Tronics Co., Ltd. Type: PCB Antenna Model: TT-ANT01 Gain: -2.00 dBi
Power Source	AC100-240V, 60/50Hz
Firmware Version	V2
Software Version	TT- A-1430WP-6196_20180307

Power Adapter :

No.	Manufacturer	Model No.	Power Input	Power Output
1	CT ADAPTER TECH.	ATS072T-P240	100-240Vac, 50-60Hz, 1.6A	24Vdc, 3A

- REMARK:**
1. The sample selected for test was engineering sample that approximated to production product and was provided by manufacturer.
 2. This submittal(s) (test report) is intended for FCC ID: **2ACIA-A-1430WPBT008** filing to comply with Section 15.207, 15.209 and 15.247 of the FCC Part 15, Subpart C Rules.
 3. For more details, please refer to the user manual.

4. DESCRIPTION OF TEST MODES

The EUT is a 30W Wall Plate Audio Amplifier with CSR Bluetooth v4.2.

The RF Chip is manufactured by CSR

The antenna peak gain -2.00 dBi (highest gain) were chosen for full testing.

DSSS mode

The EUT had been tested under operating condition.

There are three channels have been tested as following:

Channel	Frequency (MHz)
Low	2402
Middle	2442
High	2480

DSSS mode: 1Mbps long data rates (worst case) were chosen for full testing.

5. TEST METHODOLOGY

The tests documented in this report were performed in accordance with ANSI C63.10 and FCC CFR 47 15.207, 15.209 and 15.247 and KdB 558074.

6. FACILITIES AND ACCREDITATIONS

6.1 FACILITIES

All measurement facilities used to collect the measurement data are located at No.8, Jiucengling, Xinhua Dist., Tainan City 712, Taiwan (R.O.C.)

The sites are constructed in conformance with the requirements of ANSI C63.7:1992, ANSI C63.10:2013 and CISPR Publication 22.

6.2 EQUIPMENT

Radiated emissions are measured with one or more of the following types of linearly polarized antennas: tuned dipole, biconical, log periodic, bi-log, and/or ridged waveguide, horn. Spectrum analyzers with preselectors and quasi-peak detectors are used to perform radiated measurements.

Conducted emissions are measured with Line Impedance Stabilization Networks and EMI Test Receivers.

Calibrated wideband preamplifiers, coaxial cables, and coaxial attenuators are also used for making measurements.

All receiving equipment conforms to CISPR Publication 16-1, "Radio Interference Measuring Apparatus and Measurement Methods."

6.3 LABORATORY ACCREDITATIONS LISTINGS

The test facilities used to perform radiated and conducted emissions tests are accredited by Taiwan Accreditation Foundation for the specific scope of accreditation under Lab Code: 1109 to perform Electromagnetic Interference tests according to FCC PART 15 AND CISPR 22 requirements. No part of this report may be used to claim or imply product endorsement by TAF or any agency of the Government. In addition, the test facilities are listed with Federal Communications Commission (registration no: TW1109).

6.4 TABLE OF ACCREDITATIONS AND LISTINGS

Our laboratories are accredited and approved by the following accreditation body according to ISO/IEC 17025.

Taiwan	TAF
---------------	-----

The measuring facility of laboratories has been authorized or registered by the following approval agencies.

Canada	Industry Canada
Germany	TUV NORD
Taiwan	BSMI
USA	FCC

Copies of granted accreditation certificates are available for downloading from our web site, <http://www.ccsrf.com>

6.5 MEASUREMENT EQUIPMENT USED

For §9.7

Chamber 966 Room (Radiation Test)				
Name of Equipment	Manufacturer	Model	Serial Number	Calibration Due
Active Loop Antenna	ETS-LINDREN	6502	8905-2356	07/19/2019
Amplifier	HP	8447F	2443A01671	01/21/2019
Bi-Log Antenna	Sunol	JB1	A070506-2	02/08/2019
Cable	RosnoI+Suhner	SUCOFLEX 104PEA	SN25737 /4PEA	01/26/2019
Double Ridged Guide Horn Antenna	ETS-LINDGREN	3116	00078900	03/19/2019
EMI Test Receiver	R&S	ESCI	100960	10/30/2018
EXA Spectrum Analyzer	KEYSIGHT	N9010A	MY54430216	07/04/2019
Hi-Pass Filter	MICRO-TRONIC S	BRM50702-01	018	01/21/2019
Horn Antenna	Com-Power	AH-118	071032	04/18/2019
Pre-Amplifier	EMCI	EMC012645	980098	01/21/2019

For §9.1~9.6

Chamber 966 Room (Conductor Test)				
Name of Equipment	Manufacturer	Model	Serial Number	Calibration Due
EXA Spectrum Analyzer	KEYSIGHT	N9010A	MY54430216	07/04/2019
Power Meter	Anritsu	ML2487A	6K00003888	05/01/2019
Power Sensor	Anritsu	MA2491A	033265	05/01/2019
SMA Cable + 10dB Attenuator	CCS	SMA + 10dB Att	O6	01/21/2019

For §9.8

Conducted Emission room #1				
Name of Equipment	Manufacturer	Model	Serial Number	Calibration Due
BNC Coaxial Cable	CCS	BNC50	11	01/23/2019
EMI Test Receiver	R&S	ESCS 30	100348	01/30/2019
LISN	SCHWARZBECK	NNLK8130	8130124	11/30/2018
LISN	FCC	FCC-LISN-50-32- 2	08009	05/23/2019
Pulse Limiter	R&S	ESH3-Z2	100116	01/23/2019
Test S/W	e-3 (5.04211j)			

7. CALIBRATION AND UNCERTAINTY

7.1 MEASURING INSTRUMENT CALIBRATION

The measuring equipment utilized to perform the tests documented in this report has been calibrated in accordance with the manufacturer’s recommendations, and is traceable to recognized national standards.

7.2 MEASUREMENT UNCERTAINTY

Where relevant, the following measurement uncertainty levels have been estimated for tests performed on the apparatus:

PARAMETER	UNCERTAINTY
Radiated Emission, 30 to 200 MHz Test Site : OATS-6	±3.21dB
Radiated Emission, 200 to 1000 MHz Test Site : OATS-6	±3.09dB
Radiated Emission, 1 to 8 GHz	± 2.65dB
Radiated Emission, 8 to 18 GHz	± 2.66dB
Radiated Emission, 18 to 26.5 GHz	± 2.65dB
Radiated Emission, 26 to 40 GHz	± 3.03dB
Power Line Conducted Emission	±1.91dB
Band Width	136.49kHz
Peak Output Power MU	±1.34dB
Band Edge MU	±0.30dBuV
Channel Separation MU	361.69Hz
Duty Cycle MU	0.064ms
Frequency Stability MU	0.223kHz

This measurement uncertainty is confidence of approximately 95%, k=2

8. SETUP OF EQUIPMENT UNDER TEST

8.1 SETUP CONFIGURATION OF EUT

EMI

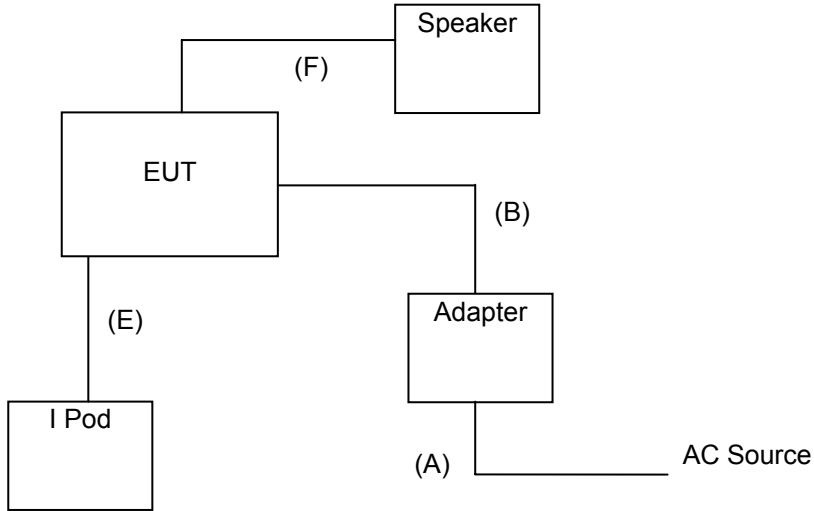

RF

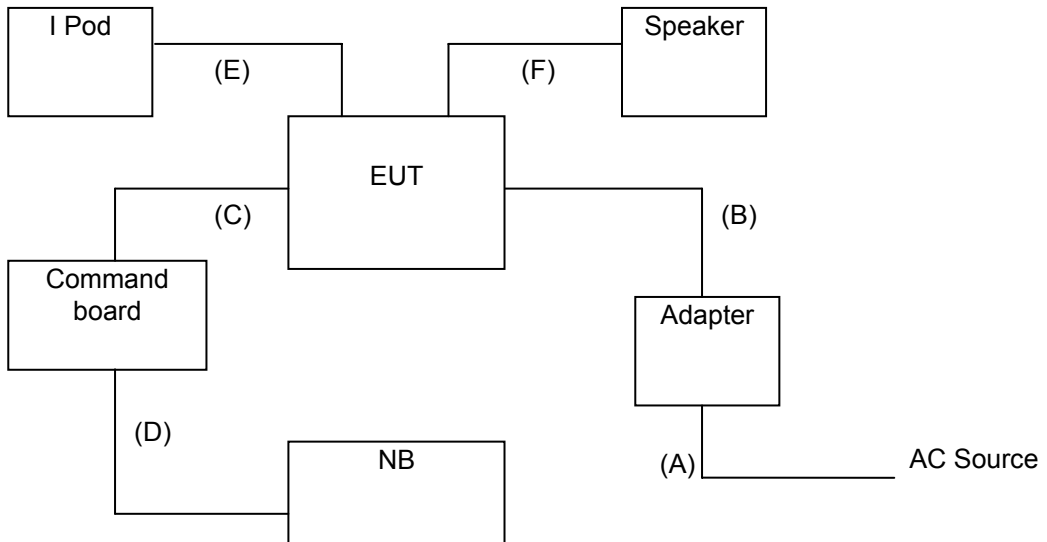

8.2 SUPPORT EQUIPMENT

For EMI test

No.	Product	Manufacturer	Model No.	Certify No.	Signal cable
1	iPod nano	Apple	MA477TA/A	DoC	USB cable, shd, 1.4m
2	Speaker System	ECHO	LA-227	DoC	Audio cable, unshd, 1.6m

No.	Signal cable description	
A	Power	Unshielded, 1.7m 1 pcs.
B	Power	Unshielded, 1.7m 1 pcs.
E	Audio	Unshielded, 1.6m 1 pcs.
F	Audio	Unshielded, 1.0m 1 pcs.

For RF test

No.	Product	Manufacturer	Model No.	Certify No.	Signal cable
1	Note Book	Acer	AS 3830TG	DoC	Power cable, unshd, 1.6m
2	iPod nano	Apple	MA477TA/A	DoC	USB cable, shd, 1.4m
3	Speaker System	ECHO	LA-227	DoC	Audio cable, unshd, 1.6m

No.	Signal cable description	
A	Power	Unshielded, 1.7m 1 pcs.
B	Power	Unshielded, 1.7m 1 pcs.
C	Command	Unshielded, 0.2m 1 pcs.
D	USB	Shielded, 1.0m 1 pcs.
E	Audio	Unshielded, 1.6m 1 pcs.
F	Audio	Unshielded, 1.0m 1 pcs.

Note:

- 1) All the equipment/cables were placed in the worst-case configuration to maximize the emission during the test.
- 2) Grounding was established in accordance with the manufacturer's requirements and conditions for the intended use.
- 3) shd. = shielded; unshd. = unshielded

Report No.: T180528N06-RP1-2

8.3 EUT OPERATING CONDITION

RF Setup

1. Set up all computers like the setup diagram.
2. The “CSR BlueSuite 2.4.8”, “Blue Test 3” software was used for testing.
3. Choose Transport “SPI” and Port “USB SPI (10003)”.

TX Mode:

GFSK(DH1):

CFG PKT > Packet Type : 4 , Packet Type : 27
TXDATA1 > LO Freq : 2402 (2402,2441,2480) , Power : 255,30 (20,10)

GFSK(DH3):

CFG PKT > Packet Type : 11 , Packet Type : 183
TXDATA1 > LO Freq : 2402 (2402,2441,2480) , Power : 255,30 (20,10)

GFSK(DH5):

CFG PKT > Packet Type : 15 , Packet Type : 339
TXDATA1 > LO Freq : 2402 (2402,2441,2480) , Power : 255,30 (20,10)

8-DPSK(3DH1):

CFG PKT > Packet Type : 24 , Packet Type : 83
TXDATA1 > LO Freq : 2402 (2402,2441,2480) , Power : 255,50

8-DPSK(3DH3):

CFG PKT > Packet Type : 27 , Packet Type : 552
TXDATA1 > LO Freq : 2402 (2402,2441,2480) , Power : 255,50

8-DPSK(3DH5):

CFG PKT > Packet Type : 31 , Packet Type : 1021
TXDATA1 > LO Freq : 2402 (2402,2441,2480) , Power : 255,50

GFSK(4.2):

BLE TEST TX > Channel :0 (0,20,39)
Length : 37(0,37)
Bit pattern : 0

RX Mode:

GFSK , 8-DPSK:

RXDATA1

GFSK(4.2):

BLE TEST RX

4. All of the function are under run.
5. Start test.

9. APPLICABLE LIMITS AND TEST RESULTS

9.1 6dB BANDWIDTH

LIMIT

§ 15.207(a) (2) For direct sequence systems, the minimum 6dB bandwidth shall be at least 500kHz

TEST SETUP

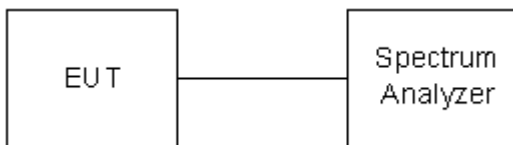

TEST PROCEDURE

- a) Set RBW = 100 kHz.
- b) Set the video bandwidth (VBW) ≥ 3 RBW.
- c) Detector = Peak.
- d) Trace mode = max hold.
- e) Sweep = auto couple.
- f) Allow the trace to stabilize.
- g) Measure the maximum width of the emission that is constrained by the frequencies associated with the two outermost amplitude points (upper and lower frequencies) that are attenuated by 6 dB relative to the maximum level measured in the fundamental emission.

TEST RESULTS

No non-compliance noted.

Model Name	A-1430WP	Test By	Ted Huang
Temp & Humidity	26.4°C, 53%	Test Date	2018/10/05

DSSS mode

Channel	Channel Frequency (MHz)	6dB Bandwidth (kHz)	Minimum Limit (kHz)	Pass / Fail
Low	2402	701.00	500	PASS
Middle	2442	690.00	500	PASS
High	2480	688.00	500	PASS

- NOTE :**
1. At final test to get the worst-case emission at 1Mbps long.
 2. The cable assembly insertion loss of 11.1dB (including 10 dB pad and 1.1 dB cable) was entered as an offset in the spectrum analyzer to allow for direct reading of power.

6dB BANDWIDTH (DSSS MODE)

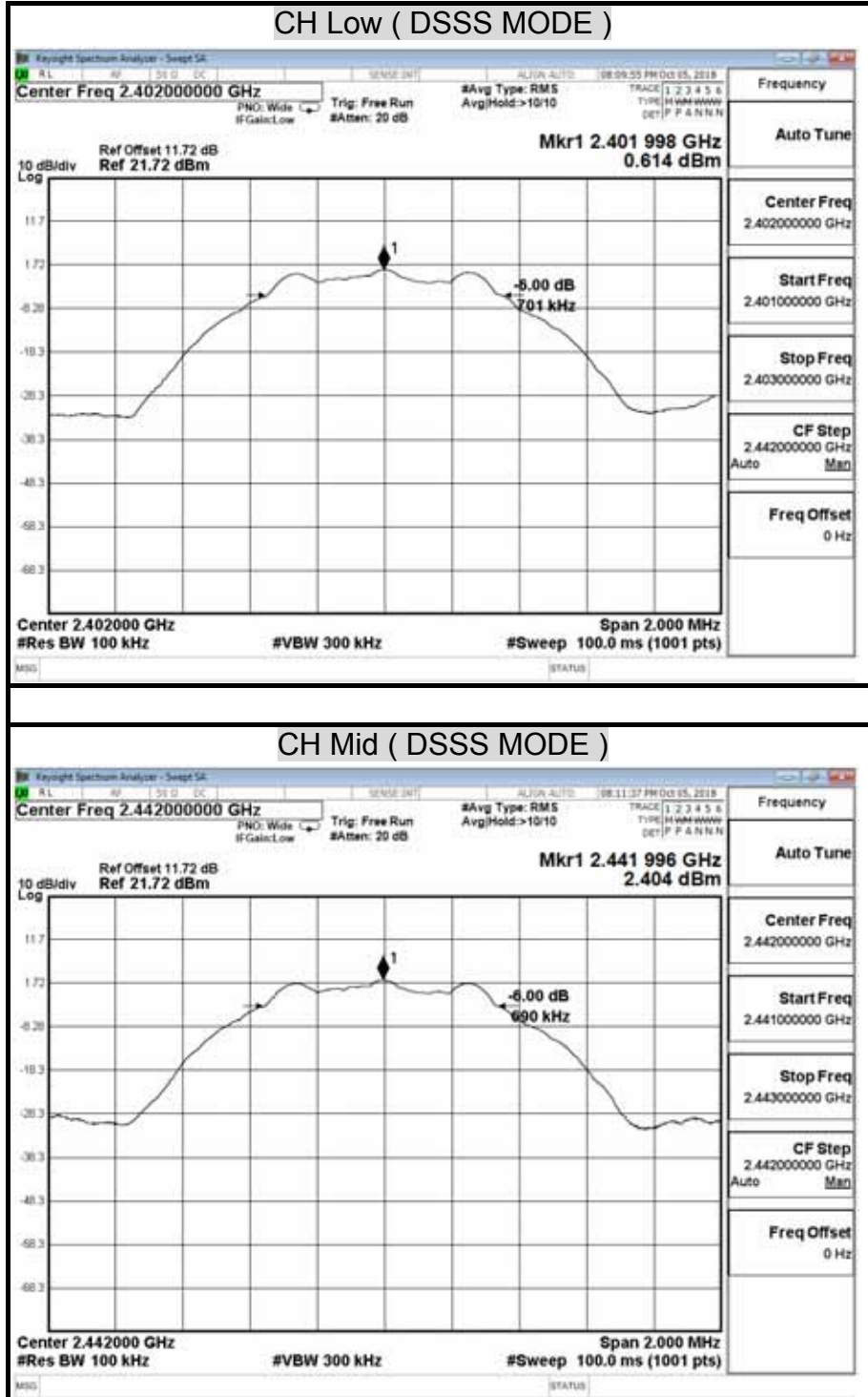

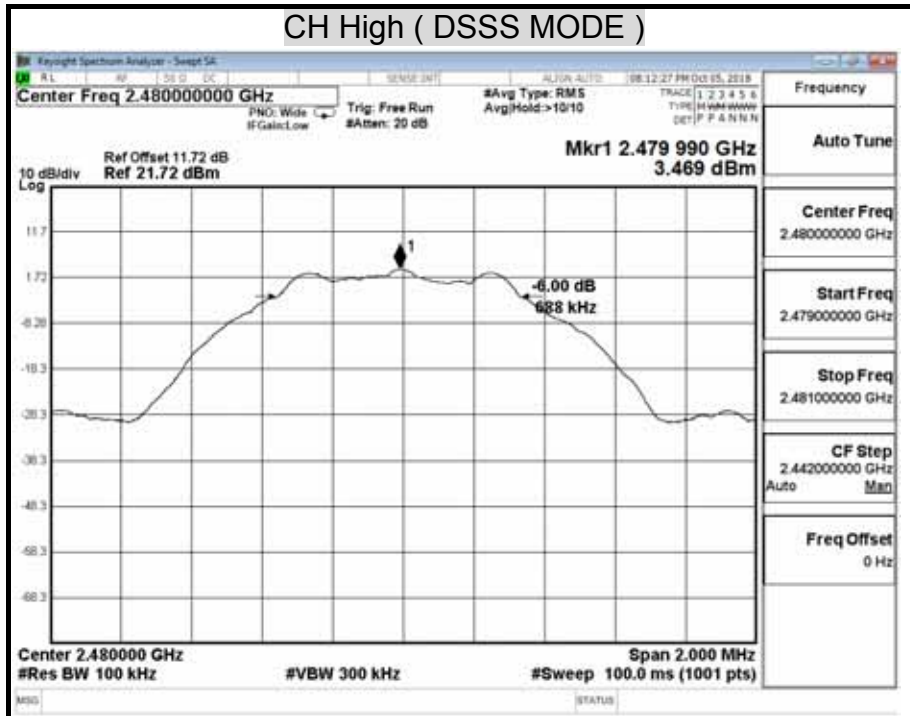

9.2 MAXIMUM PEAK OUTPUT POWER

LIMIT

§ 15.247(b) The maximum peak output power of the intentional radiator shall not exceed the following :

§ 15.247(b) (3) For systems using digital modulation in the 902-928 MHz, 2400-2483.5 MHz, and 5725-5850 MHz bands : 1 watt.

§ 15.247(b) (4) Except as shown in paragraphs (c) of this section , if transmitting antennas of directional gain greater than 6 dBi are used the peak output power from the intentional radiator shall be reduced below the stated values in paragraphs (b)(1) or (b)(2), and (b)(3) of this section , as appropriate, by the amount in dB that the directional gain of the antenna exceeds 6 dBi.

TEST SETUP

For Peak Power

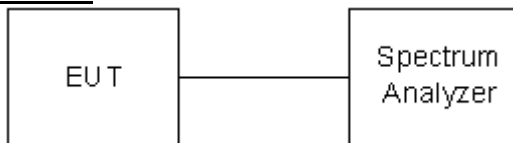

For Average Power



TEST PROCEDURE

The tests were performed in accordance with KdB 558074 9.1.1

9.2.1 Measurement Procedure PK2:

- a) Set the RBW \geq DTS bandwidth.
- b) Set VBW \geq 3 RBW.
- c) Set span \geq 3 x RBW
- d) Sweep time = auto couple.
- e) Detector = peak.
- f) Trace mode = max hold.
- g) Allow trace to fully stabilize.
- h) Use peak marker function to determine the peak amplitude level.

Average Power

Connect the EUT to power meter, set the center frequency of the power meter to the channel center frequency.

TEST RESULTS

No non-compliance noted.

Model Name	A-1430WP	Test By	Ted Huang
Temp & Humidity	26.4°C, 53%	Test Date	2018/10/05

DSSS mode

Channel	Channel Frequency (MHz)	Peak Power (dBm)	Peak Power Limit (dBm)	Pass / Fail
Low	2402	1.03	30.00	PASS
Middle	2442	2.74	30.00	PASS
High	2480	3.80	30.00	PASS

- NOTE :**
1. At final test to get the worst-case emission at 1Mbps long.
 2. The cable assembly insertion loss of 11.1dB (including 10 dB pad and 1.1 dB cable) was entered as an offset in the power meter to allow for direct reading of power.

Average Power Data

Model Name	A-1430WP	Test By	Ted Huang
Temp & Humidity	26.4°C, 53%	Test Date	2018/10/05

DSSS mode

Channel	Channel Frequency (MHz)	Average Power (dBm)
Low	2402	-1.76
Middle	2442	0.38
High	2480	1.49

Report No.: T180528N06-RP1-2

MAXIMUM PEAK OUTPUT POWER (DSSS MODE)

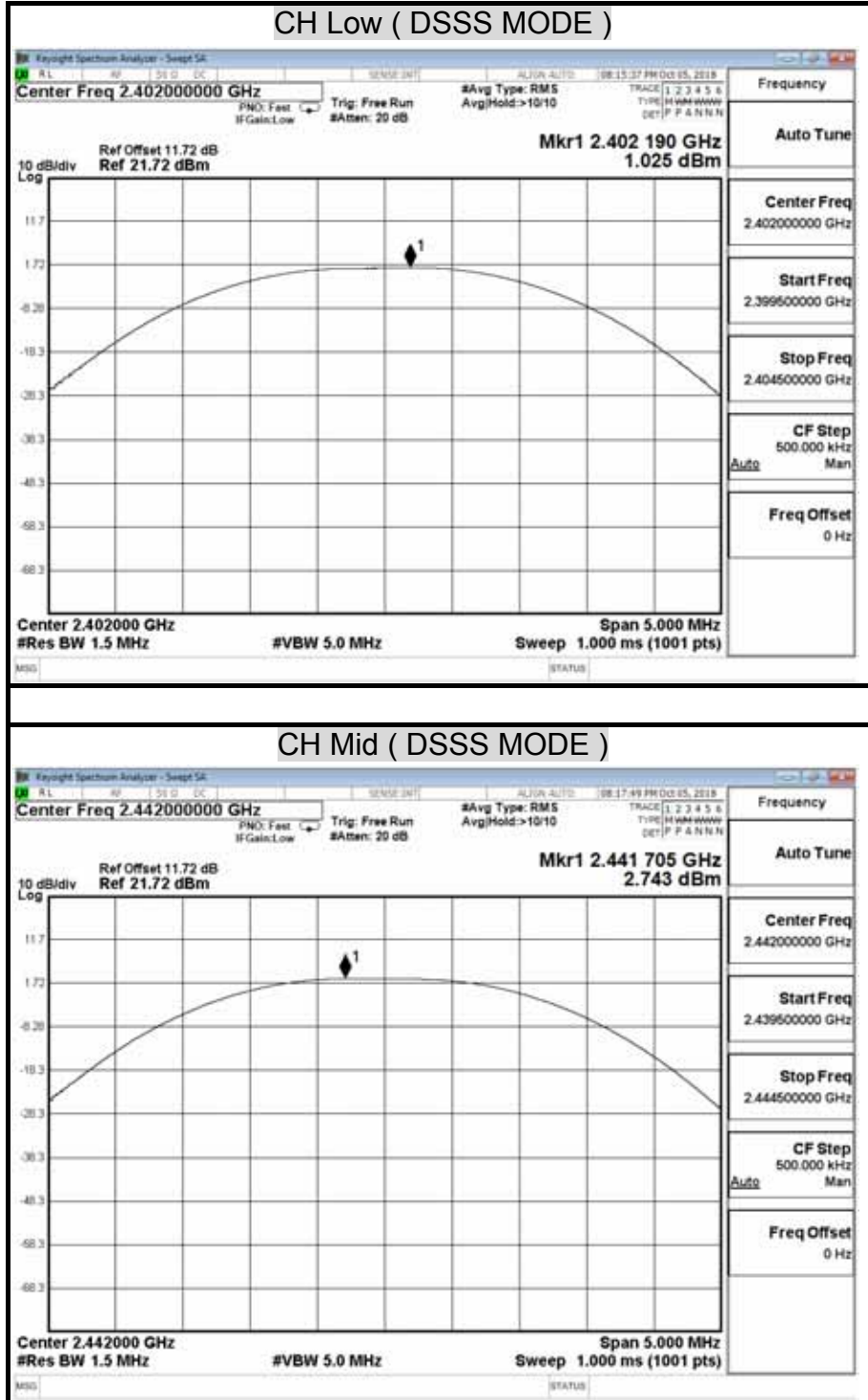

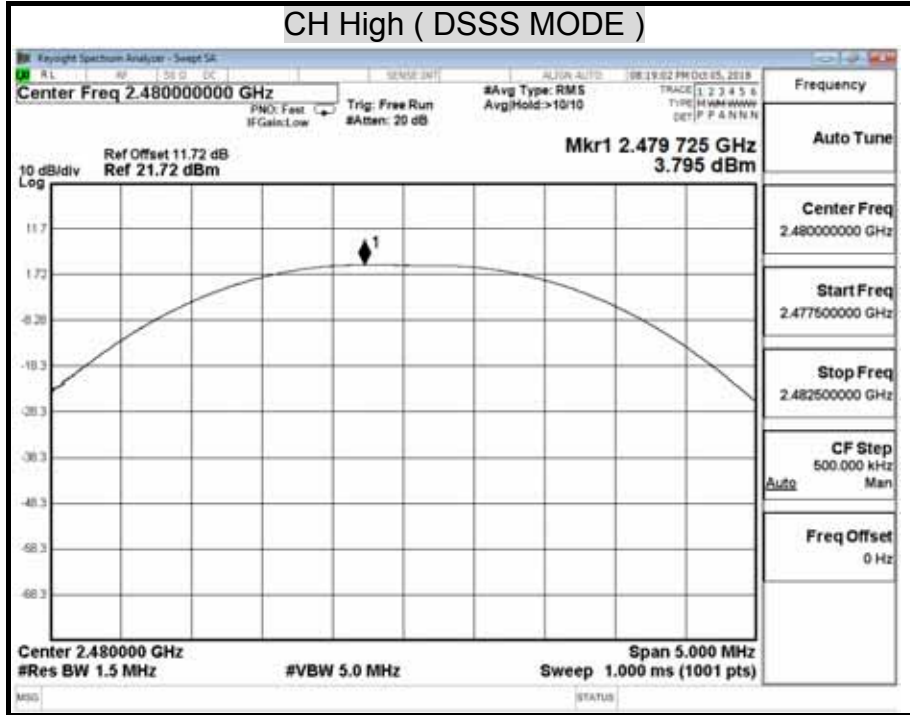

9.3 DUTY CYCLE

LIMIT

Nil (No dedicated limit specified in the Rules)

TEST SETUP

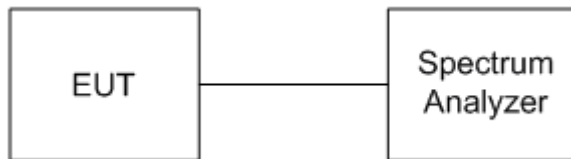

TEST PROCEDURE

1. Place the EUT on the table and set it in transmitting mode.
2. Remove the antenna from the EUT and then connect a low loss RF cable from the antenna port to the spectrum analyzer.
3. The zero-span mode on a spectrum analyzer or EMI receiver if the response time and spacing between bins on the sweep are sufficient to permit accurate measurements of the on and off times of the transmitted signal. Set the center frequency of the instrument to the center frequency of the transmission. Set $RBW \geq OBW$ if possible; otherwise, set RBW to the largest available value. Set $VBW \geq RBW$. Set detector = peak or average. The zero-span measurement method shall not be used unless both RBW and VBW are $> 50/T$ and the number of sweep points across duration T exceeds 100. (For example, if VBW and/or RBW are limited to 3 MHz, then the zero-span method of measuring duty cycle shall not be used if $T \leq 16.7$ microseconds.)

TEST RESULTS

No non-compliance noted.

Model Name	A-1430WP	Test By	Ted Huang
Temp & Humidity	26.4°C, 53%	Test Date	2018/10/05

DSSS Mode

	us	Times	Ton	Total Ton time(ms)
Ton1	425.000	1	425	
Ton2		0	0	
Ton3			0	0.425
Tp				0.65

Ton	0.425
Tp(Ton+Toff)	0.65
Duty Cycle	0.653846154
Duty Factor	1.845244266

Report No.: T180528N06-RP1-2

TEST PLOT

Duty Cycle

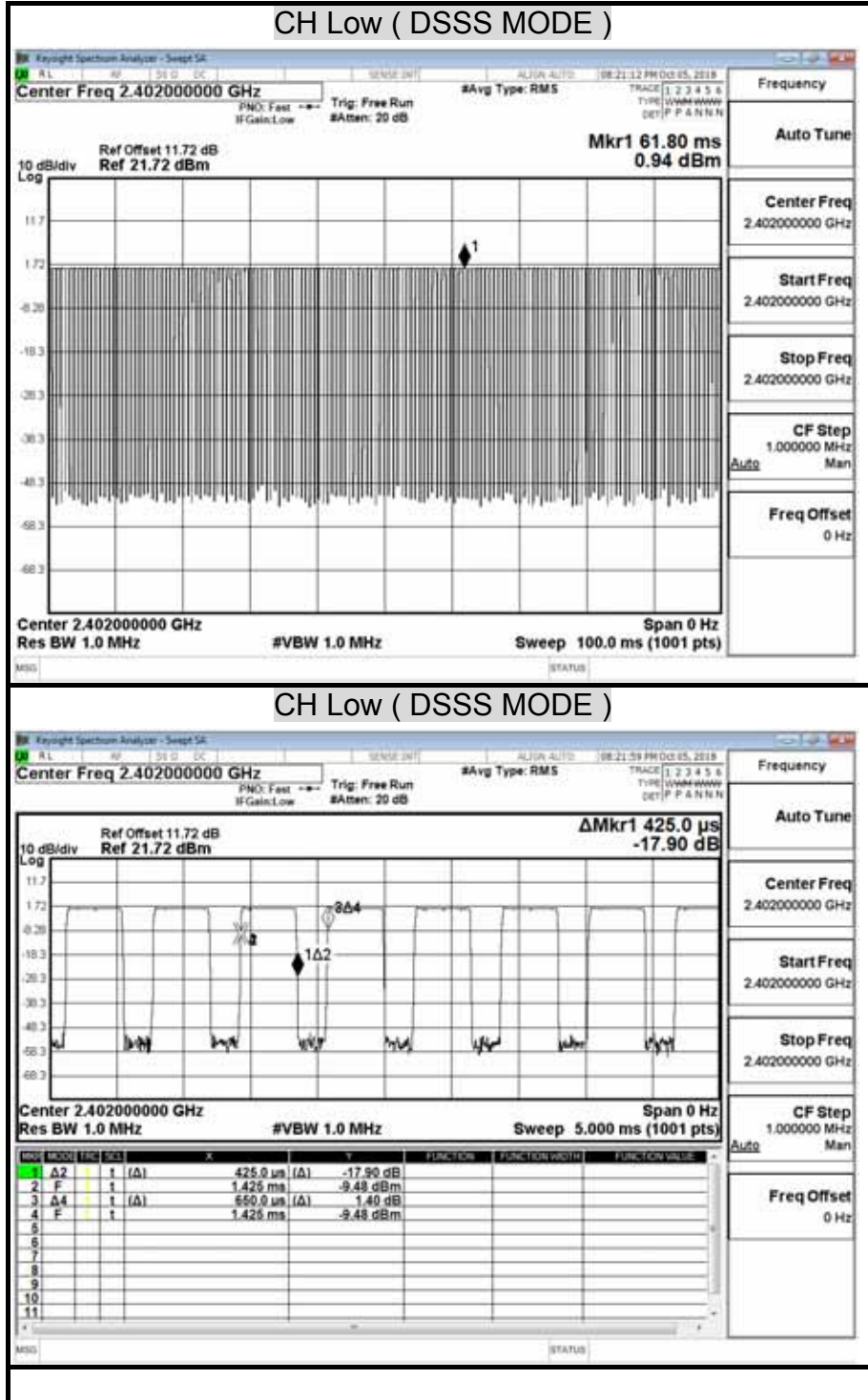

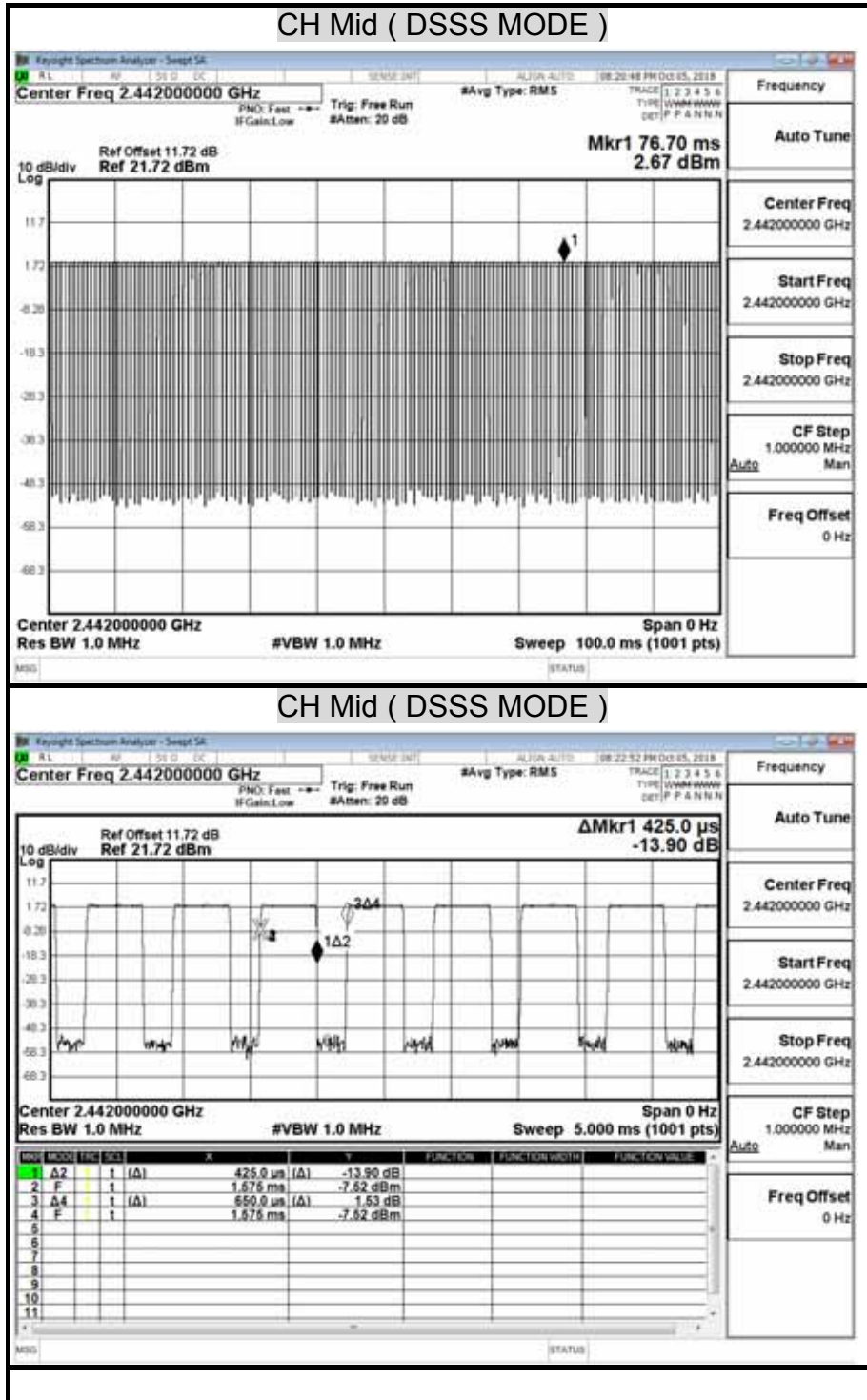

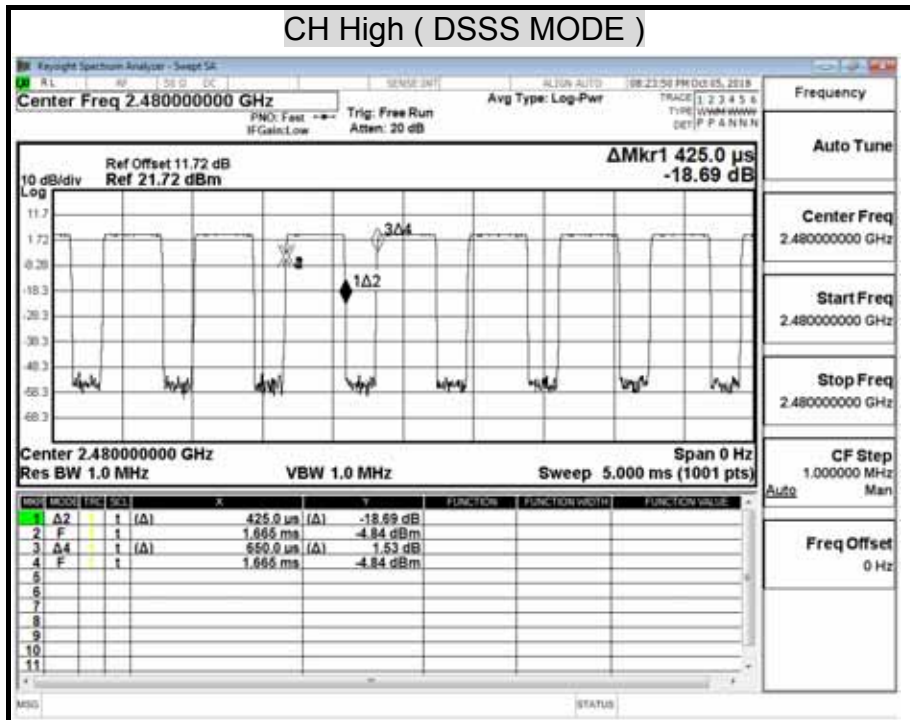
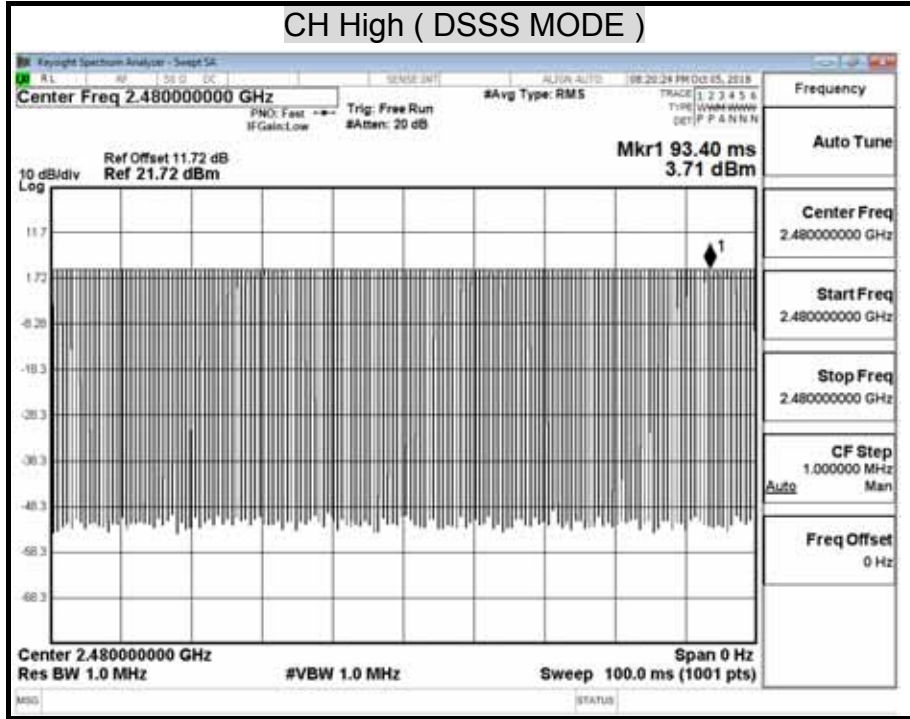

9.4 POWER SPECTRAL DENSITY

LIMIT

§ 15.247(e) For digitally modulated systems, the power spectral density conducted from the intentional radiator to the antenna shall not greater than 8 dBm in any 3 kHz band during any time interval of continuous transmission.

TEST SETUP

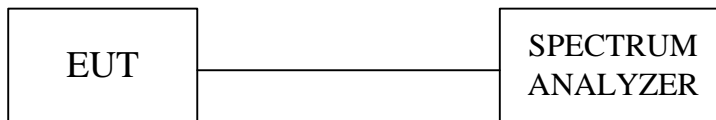

TEST PROCEDURE

The tests were performed in accordance with 558074 D01 15.247 Meas Guidance v05

10.2 Method PKPSD (peak PSD):

1. Set analyzer center frequency to DTS channel center frequency.
2. Set the span to 1.5 times the DTS bandwidth.
3. Set the RBW to: $3 \text{ kHz} \leq \text{RBW} \leq 100 \text{ kHz}$.
4. Set the VBW $\geq 3 \text{ RBW}$.
5. Detector = peak.
6. Sweep time = auto couple.
7. Trace mode = max hold.
8. Allow trace to fully stabilize.
9. Use the peak marker function to determine the maximum amplitude level within the RBW.
10. If measured value exceeds limit, reduce RBW (no less than 3 kHz) and repeat.

Report No.: T180528N06-RP1-2

TEST RESULTS

No non-compliance noted.

Model Name	A-1430WP	Test By	Ted Huang
Temp & Humidity	26.4°C, 53%	Test Date	2018/10/05

DSSS mode

Channel	Frequency (MHz)	PPSD/100kHz (dBm)	PPSD/3kHz (dBm)	Limit (dBm)	Margin (dB)	Result
Low	2402	0.61	-14.61	8.00	-3.84	PASS
Middle	2442	2.40	-12.82	8.00	-2.47	PASS
High	2480	3.47	-11.76	8.00	-1.91	PASS

- NOTE :**
1. At final test to get the worst-case emission at 1Mbps long.
 2. The cable assembly insertion loss of 11.1dB (including 10 dB pad and 1.1 dB cable) was Entered as an offset in the spectrum analyzer to allow for direct reading of power.

POWER SPECTRAL DENSITY (DSSS MODE)

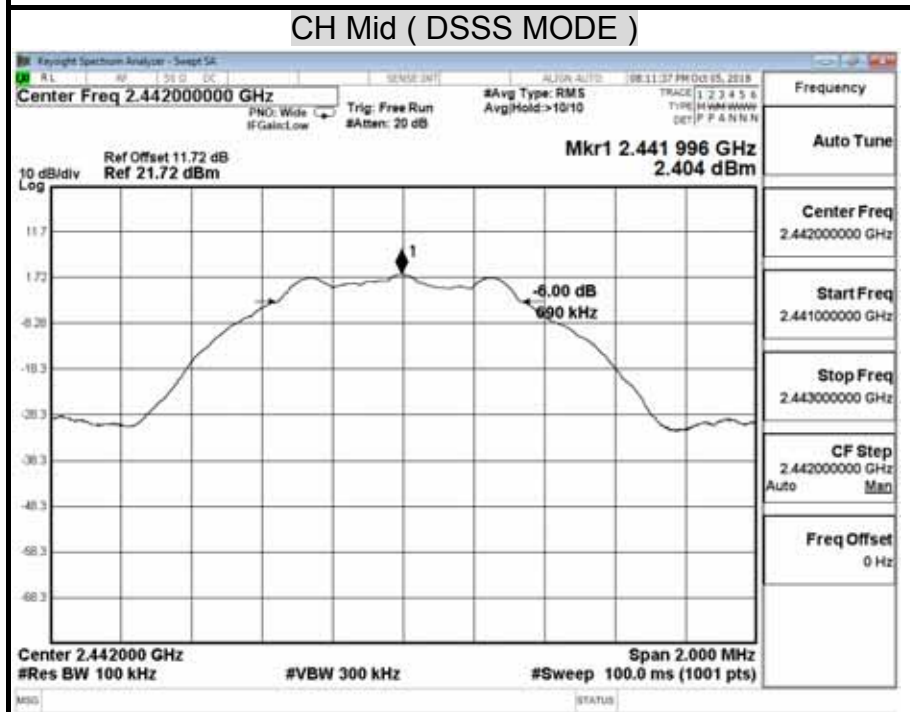
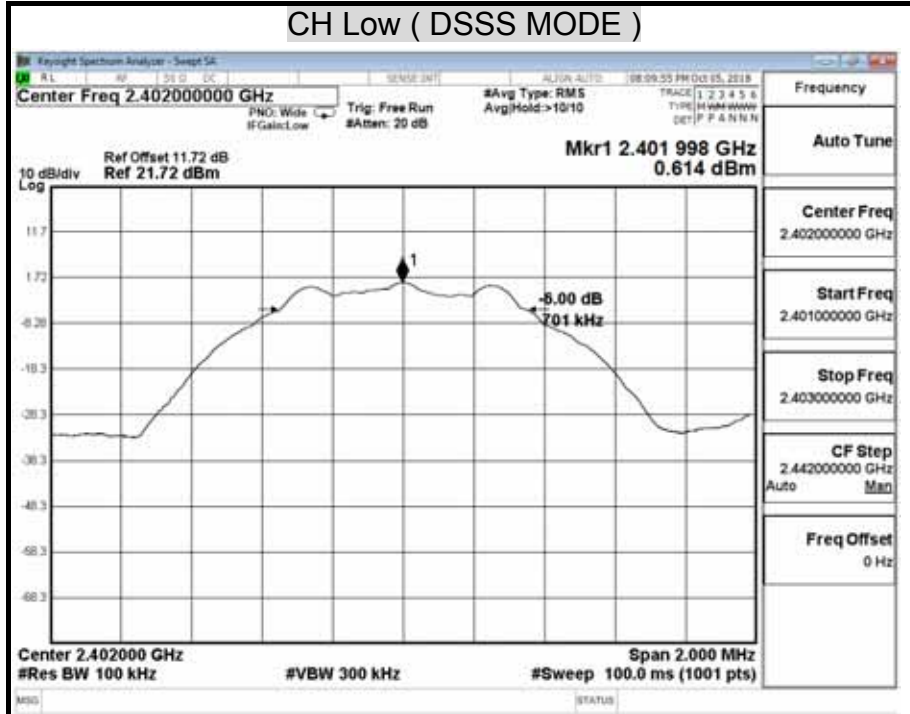

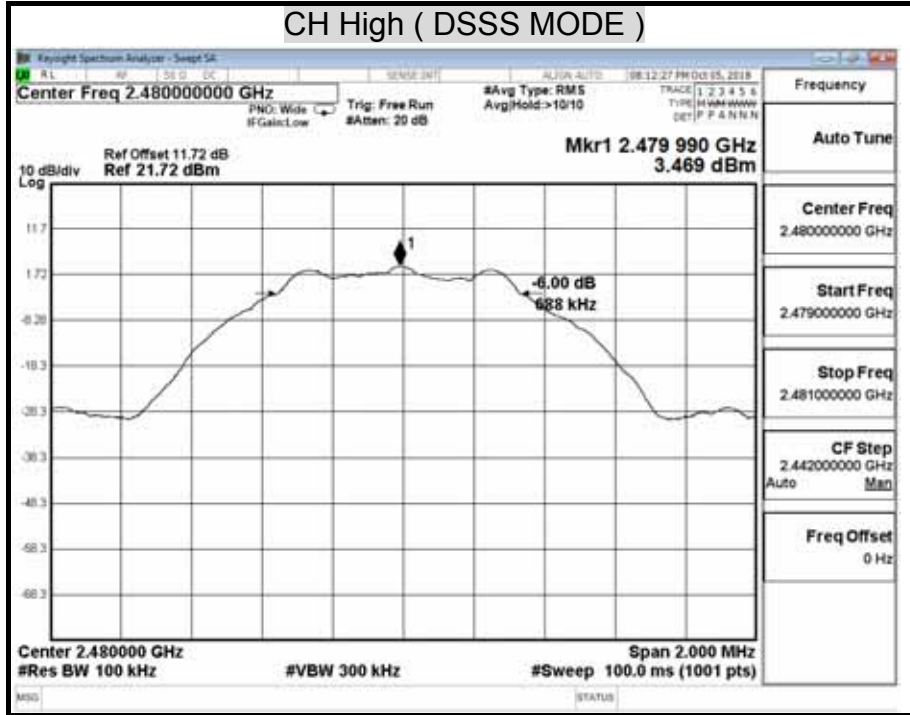

9.5 CONDUCTED SPURIOUS EMISSION

LIMITS

§ 15.247(d) In any 100 kHz bandwidth outside the frequency band in which the spread spectrum intentional radiator is operating, the radio frequency power that is produced by the intentional radiator shall be at least 20 dB below that in the 100 kHz bandwidth within the and that contains the highest level of the desired power, based on either an RF conducted or a radiated measurement. Attenuation below the general limits specified in § 15.209(a) is not required. In addition, radiated emissions which fall in the restricted bands, as defined in § 15.205(a), must also comply with the radiated emission limits specified in § 15.209(a) (see § 15.205(c)).

TEST SETUP

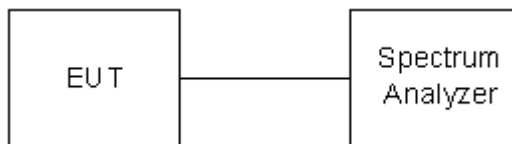

TEST PROCEDURE

The transmitter output is connected to a spectrum analyzer. The resolution bandwidth is set to 1 MHz. The video bandwidth is set to 1 MHz.

The spectrum from 30 MHz to 26 GHz is investigated with the transmitter set to the lowest, middle, and highest channels in the 2.4 GHz band.

TEST RESULTS

No non-compliance noted.

TEST DATA

Model Name	A-1430WP	Test By	Ted Huang
Temp & Humidity	26.4°C, 53%	Test Date	2018/10/05

OUT-OF-BAND SPURIOUS EMISSIONS-CONDUCTED MEASUREMENT
CH Low (DSSS MODE)

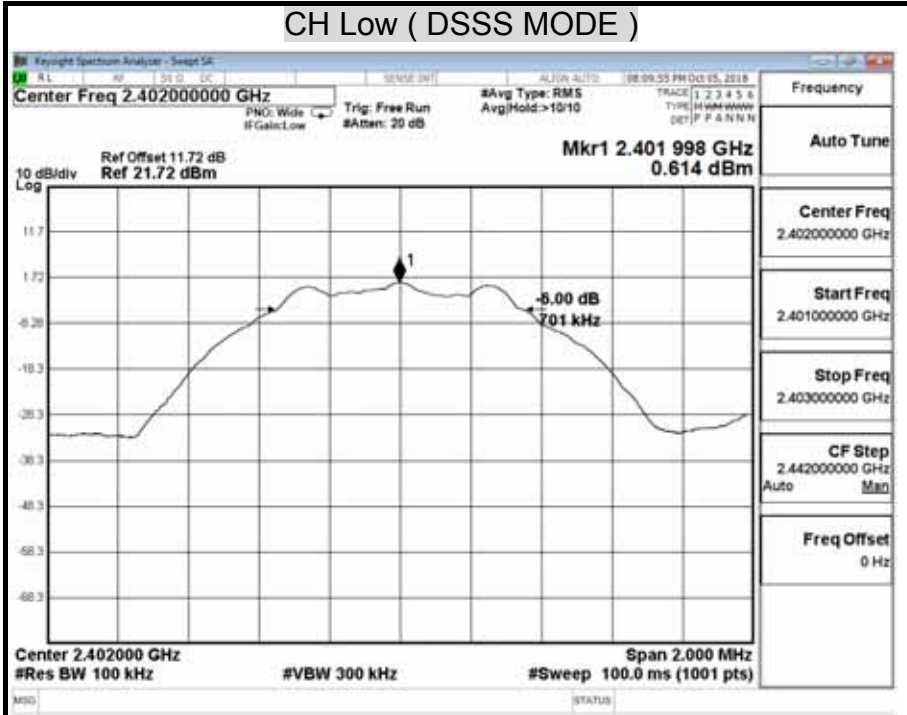

CH Low (DSSS MODE)

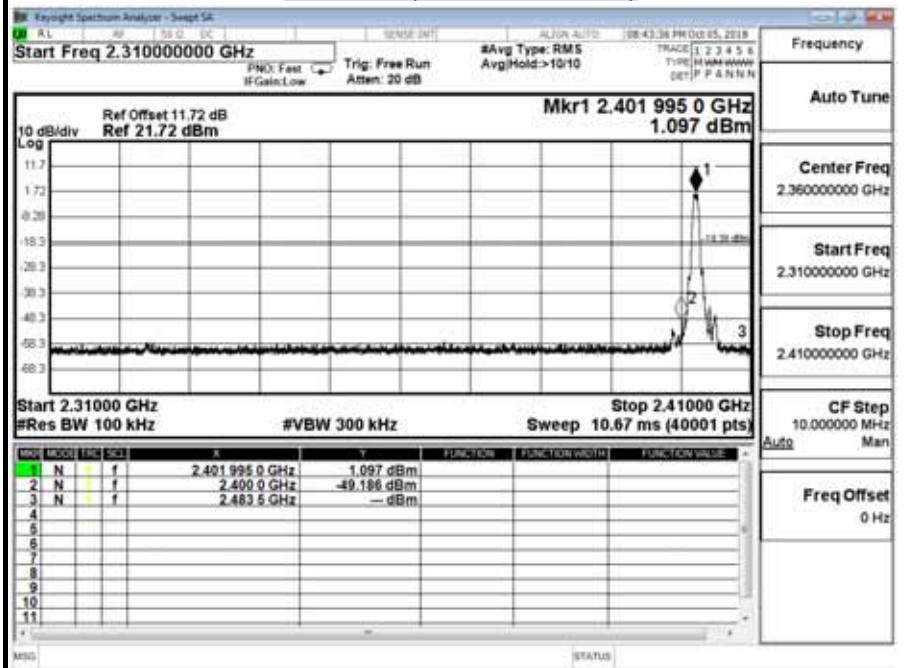

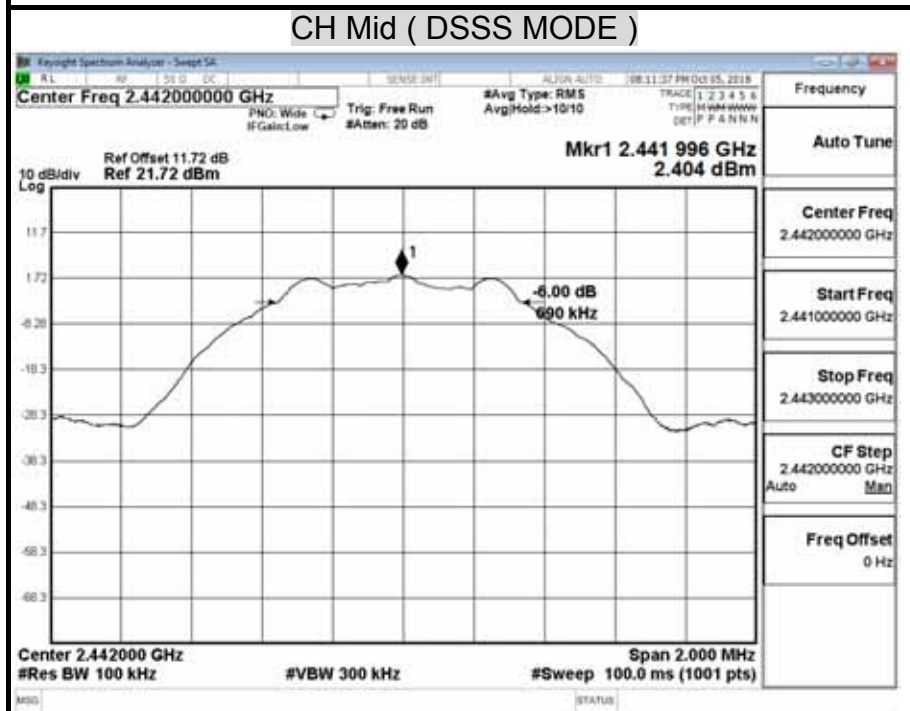
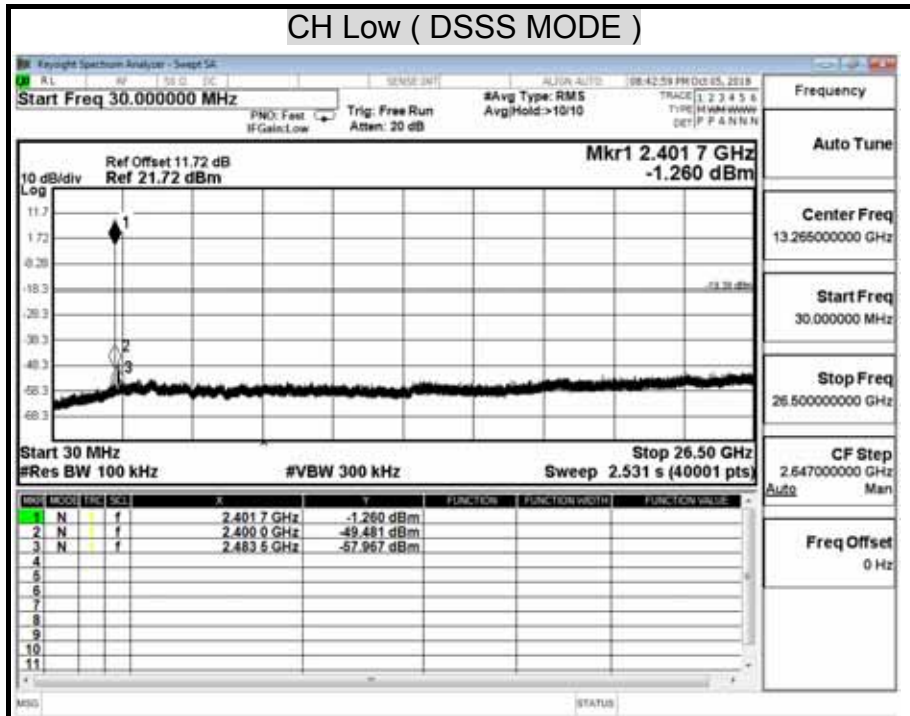

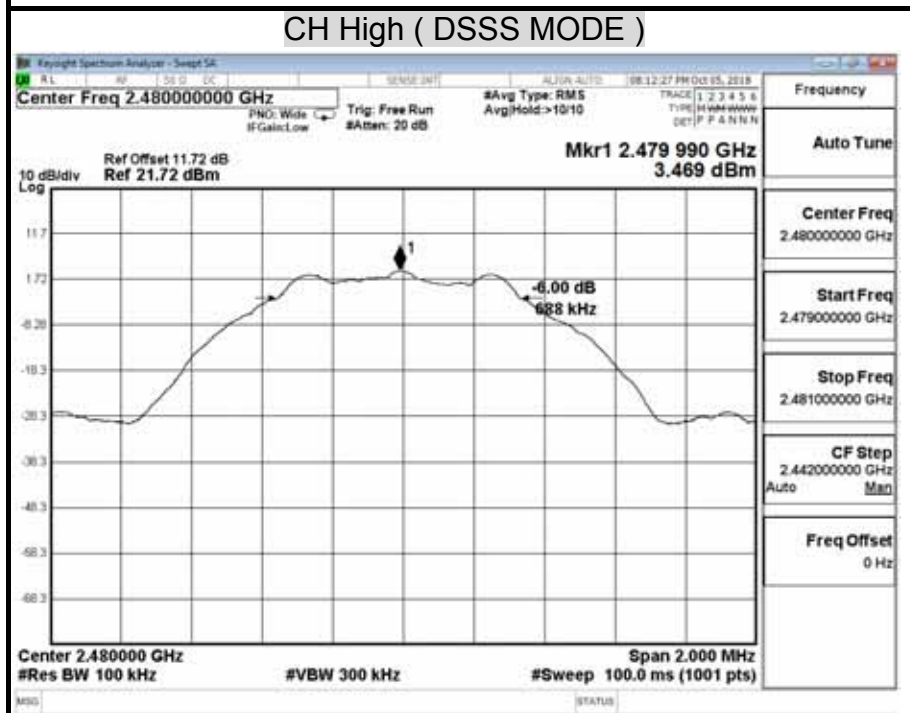
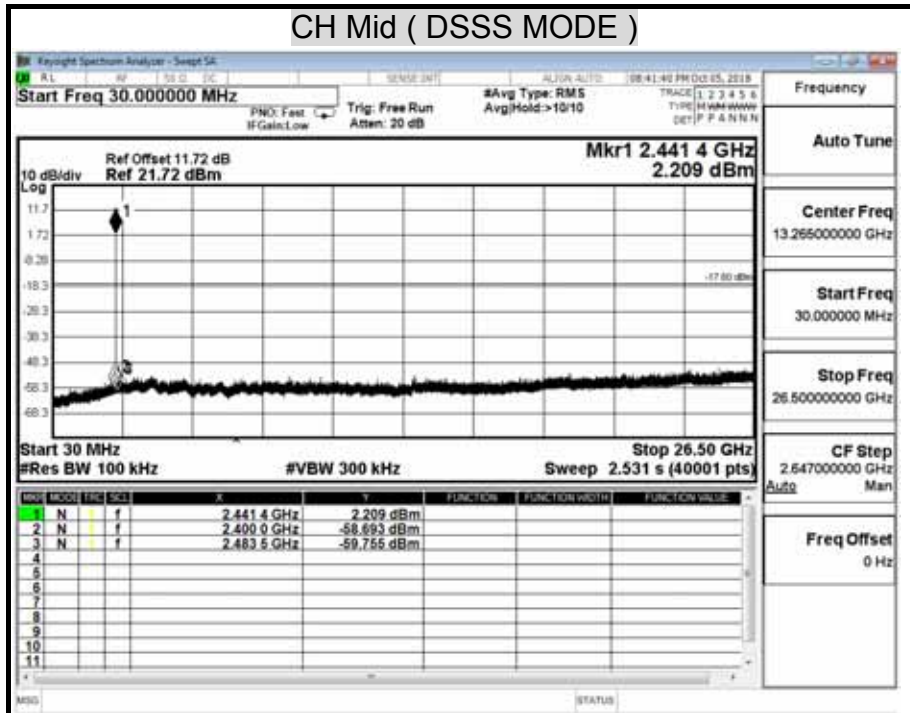

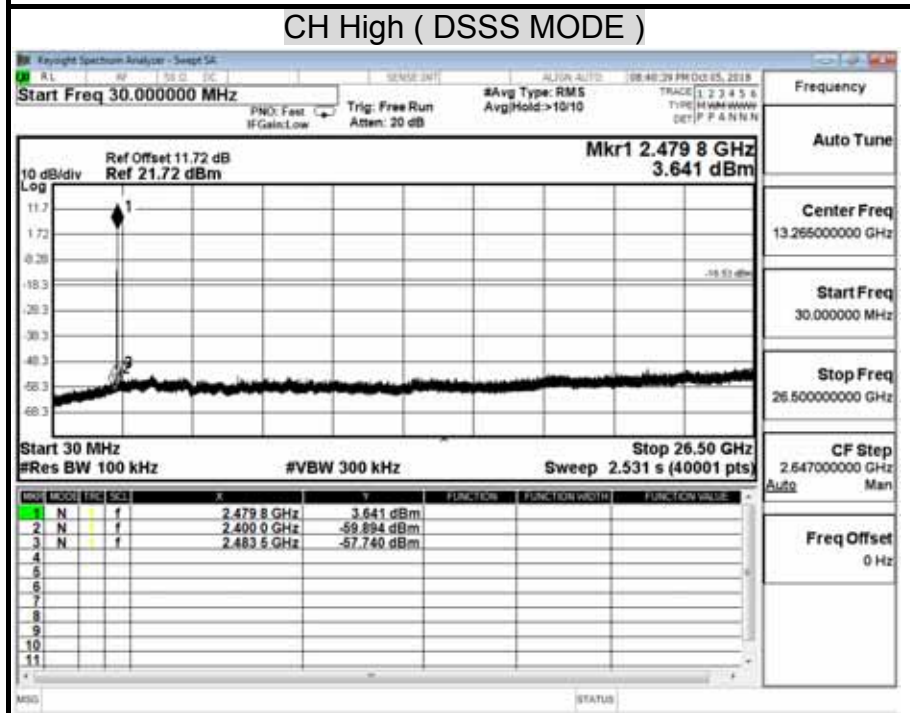
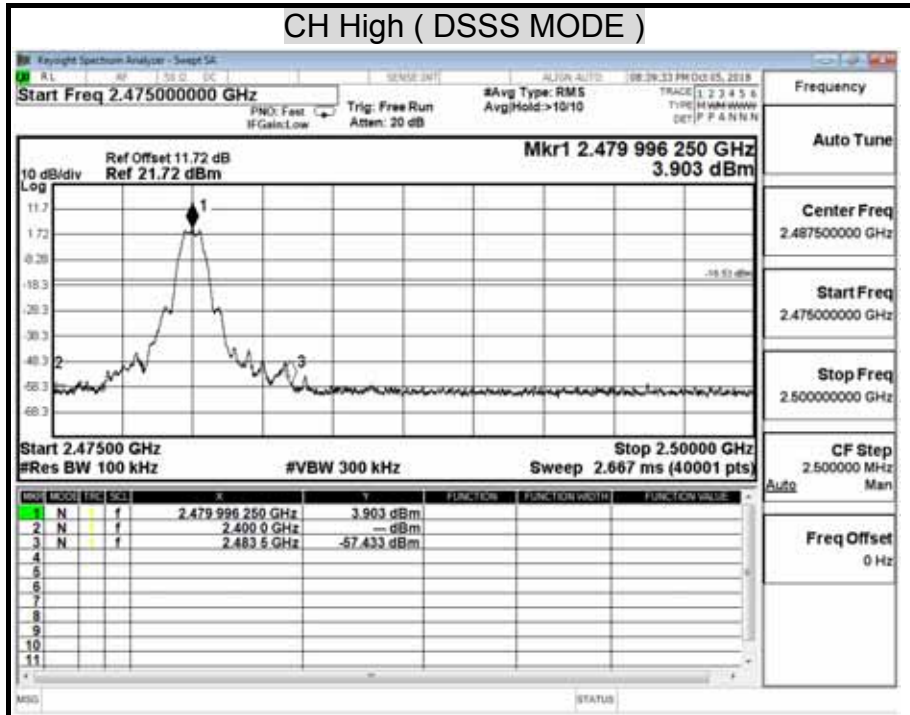

Report No.: T180528N06-RP1-2

9.6 RADIATED EMISSIONS

9.6.1 TRANSMIA-1430WPER RADIATED SUPURIOUS EMSSIONS

LIMITS

§ 15.205 (a) Except as shown in paragraph (d) of this section, only spurious emissions are permitted in any of the frequency bands listed below:

MHz	MHz	MHz	GHz
0.090 - 0.110	16.42 - 16.423	399.9 - 410	4.5 - 5.15
¹ 0.495 - 0.505	16.69475 - 16.69525	608 - 614	5.35 - 5.46
2.1735 - 2.1905	16.80425 - 16.80475	960 - 1240	7.25 - 7.75
4.125 - 4.128	25.5 - 25.67	1300 - 1427	8.025 - 8.5
4.17725 - 4.17775	37.5 - 38.25	1435 - 1626.5	9.0 - 9.2
4.20725 - 4.20775	73 - 74.6	1645.5 - 1646.5	9.3 - 9.5
6.215 - 6.218	74.8 - 75.2	1660 - 1710	10.6 - 12.7
6.26775 - 6.26825	108 - 121.94	1718.8 - 1722.2	13.25 - 13.4
6.31175 - 6.31225	123 - 138	2200 - 2300	14.47 - 14.5
8.291 - 8.294	149.9 - 150.05	2310 - 2390	15.35 - 16.2
8.362 - 8.366	156.52475 - 156.52525	2483.5 - 2500	17.7 - 21.4
8.37625 - 8.38675	156.7 - 156.9	2655 - 2900	22.01 - 23.12
8.41425 - 8.41475	162.0125 - 167.17	3260 - 3267	23.6 - 24.0
12.29 - 12.293	167.72 - 173.2	3332 - 3339	31.2 - 31.8
12.51975 - 12.52025	240 - 285	3345.8 - 3338	36.43 - 36.5
12.57675 - 12.57725	322 - 335.4	3600 - 4400	(²)
13.36 - 13.41			

¹ Until February 1, 1999, this restricted band shall be 0.490-0.510 MHz.

² Above 38.6

§ 15.205 (b) Except as provided in paragraphs (d) and (e), the field strength of emissions appearing within these frequency bands shall not exceed the limits shown in Section 15.209. At frequencies equal to or less than 1000 MHz, compliance with the limits in Section 15.209 shall be demonstrated using measurement instrumentation employing a CISPR quasi-peak detector. Above 1000 MHz, compliance with the emission limits in Section 15.209 shall be demonstrated based on the average value of the measured emissions. The provisions in Section 15.35 apply to these measurements.

Report No.: T180528N06-RP1-2

§ 15.209 (a) Except as provided elsewhere in this Subpart, the emissions from an intentional radiator shall not exceed the field strength levels specified in the following table :

Frequency (MHz)	Field Strength (microvolts/meter)	Measurement Distance (meters)
30 - 88	100 **	3
88 - 216	150 **	3
216 - 960	200 **	3
Above 960	500	3

** Except as provided in paragraph (g), fundamental emissions from intentional radiators operating under this Section shall not be located in the frequency bands 54-72 MHz, 76-88 MHz, 174-216 MHz or 470-806 MHz, However, operation within these frequency bands is permitted under other sections of this Part, e-g, Sections 15.231 and 15.241.

§ 15.209 (b) In the emission table above, the tighter limit applies at the band edges.

Report No.: T180528N06-RP1-2

TEST SETUP

The diagram below shows the test setup that is utilized to make the measurements for emission from below 1GHz.

9kHz ~ 30MHz

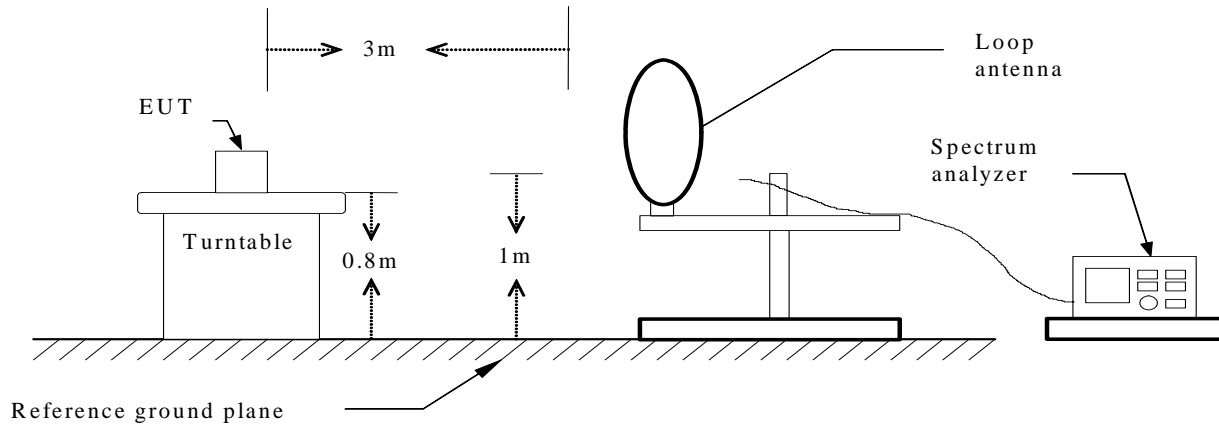

30MHz ~ 1GHz

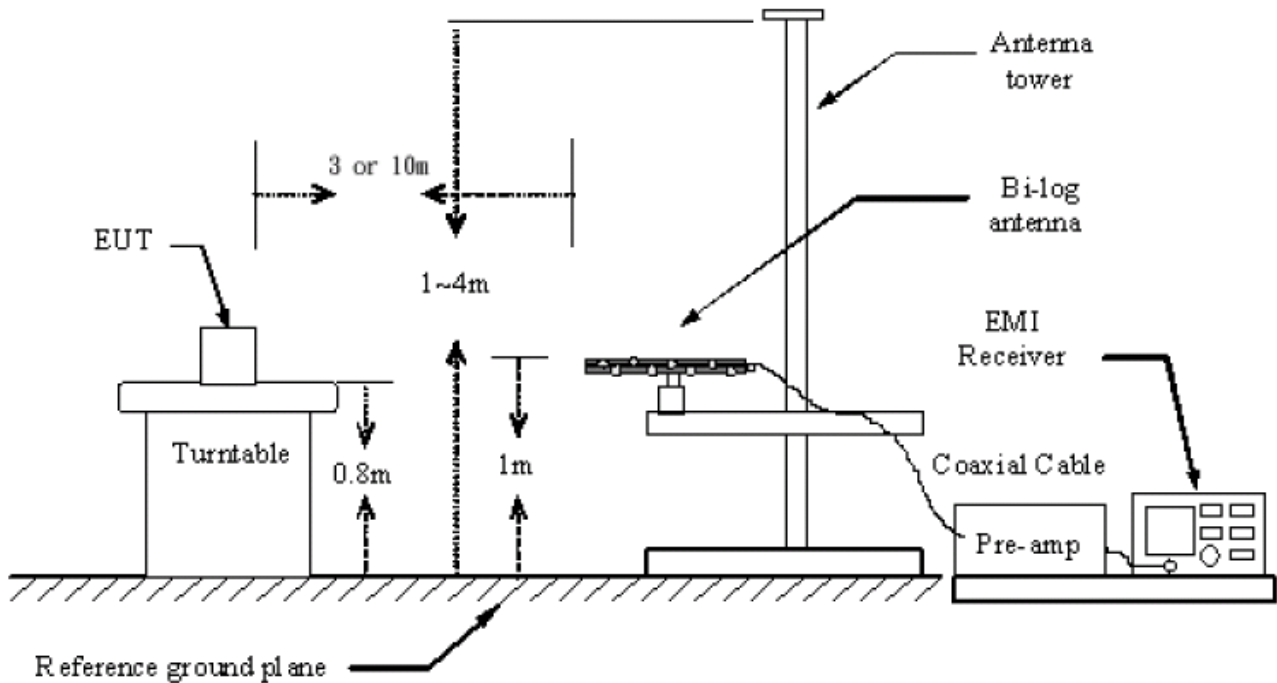

Report No.: T180528N06-RP1-2

The diagram below shows the test setup that is utilized to make the measurements for emission above 1GHz.

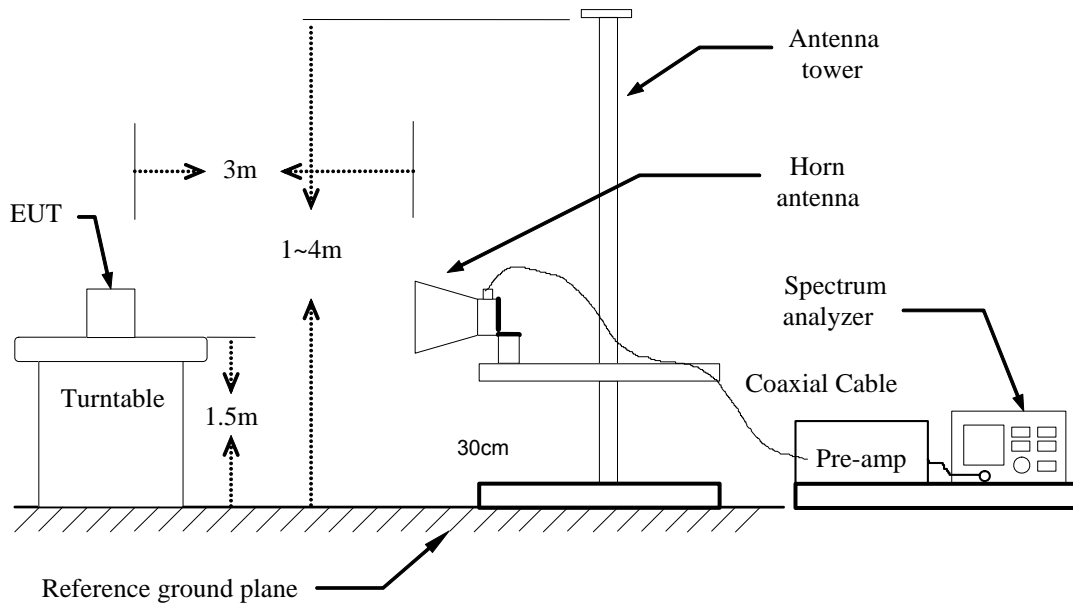

TEST PROCEDURE

- The EUT was placed on the top of a rotating table 0.8/1.5 meters above the ground at a 10 meter open area test site. The table was rotated 360 degrees to determine the position of the highest radiation.
- While measuring the radiated emission below 1GHz, the EUT was set 3 meters away from the interference-receiving antenna, which was mounted on the top of a variable-height antenna tower. While measuring the radiated emission above 1GHz, the EUT was set 3 meters away from the interference-receiving antenna.
- The antenna is a broadband antenna, and its height is varied from one meter to four meters above the ground to determine the maximum value of the field strength. Both horizontal and vertical polarization of the antenna are set to make the measurement.
- For each suspected emission, the EUT was arranged to its worst case and then the antenna was tuned to heights from 1 meter to 4 meters and the table was turned from 0 degrees to 360 degrees to find the maximum reading.
- The test-receiver system was set to Peak Detect Function and Specified Bandwidth with Maximum Hold Mode.
- If the emission level of the EUT in peak mode was 10 dB lower than the limit specified, then testing could be stopped and the peak values of the EUT would be reported. Otherwise the emissions that did not have 10 dB margin would be re-tested one by one using peak, quasi-peak or average method as specified and then reported in a data sheet.
- The tests were performed in accordance with 558074 D01 15.247 Meas Guidance v05

NOTE :

1. The resolution bandwidth and video bandwidth of test receiver/spectrum analyzer is 120 KHz for Peak detection (PK) and Quasi-peak detection (QP) at frequency below 1GHz.
2. The resolution bandwidth and video bandwidth of test receiver/spectrum analyzer is 1 MHz for Peak detection and frequency above 1GHz.
3. The resolution bandwidth of test receiver/spectrum analyzer is 1 MHz and the video bandwidth is 10 Hz for Average detection (AV) at frequency above 1GHz.
4. No emission is found between lowest internal used/generated frequency to 30MHz (9kHz~30MHz)

TEST RESULTS

No non-compliance noted.

Report No.: T180528N06-RP1-2

9.6.2 WORST-CASE RADIATED EMISSION BELOW 1 GHz

Product Name	30W Wall Plate Audio Amplifier with CSR Bluetooth v4.2	Test Date	2018/09/25
Model Name	A-1430WP	Test By	Ted Huang
Test Mode	TX	Temp & Humidity	26.5°C, 62%

Vertical

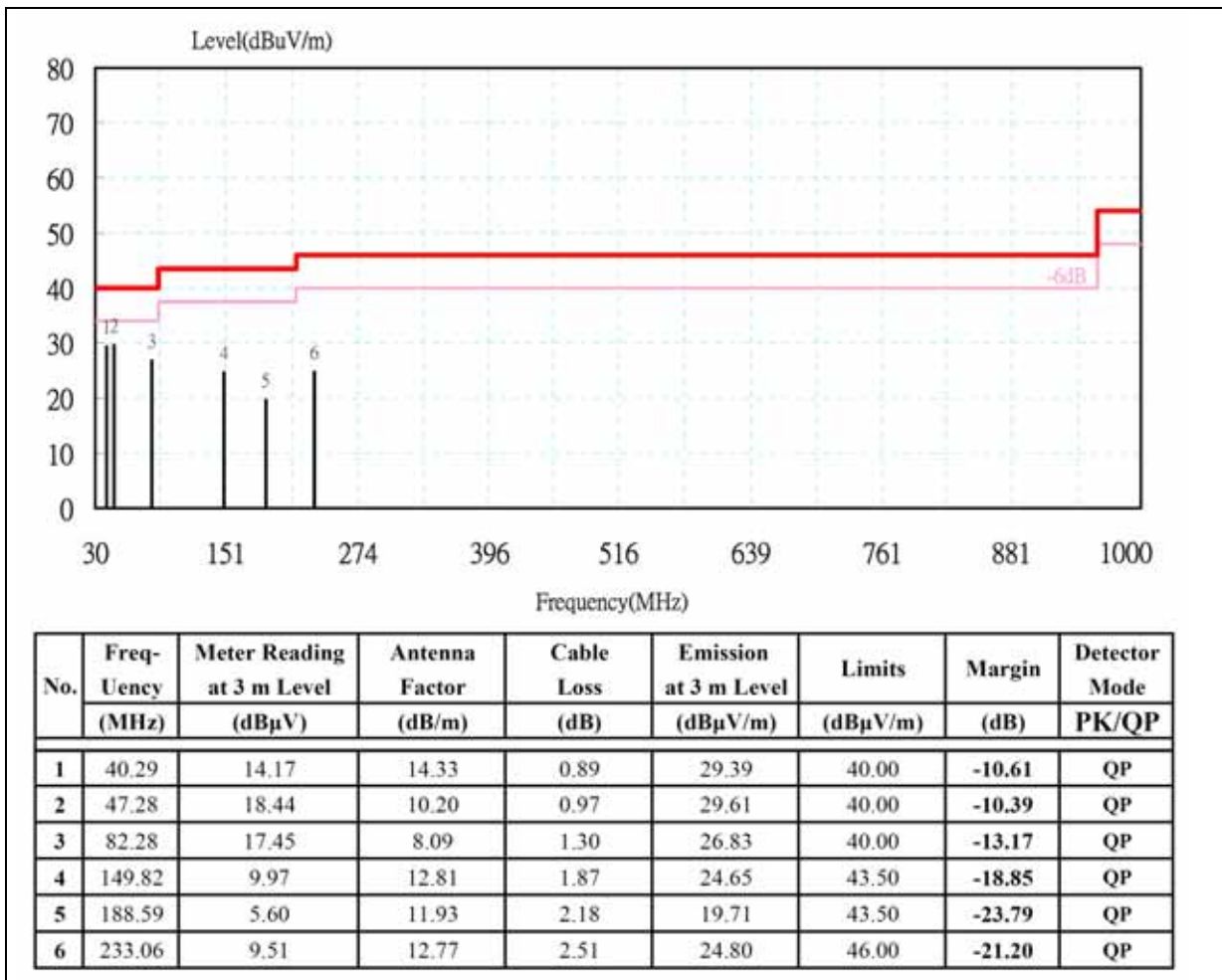

Remark:

1. No emission found between lowest internal used/generated frequency to 30MHz (9kHz~30MHz).
2. Radiated emissions measured were made with an instrument using peak/quasi-peak detector mode.
3. Quasi-peak test would be performed if the peak result were greater than the quasi-peak limit or as required by the applicant.
4. Margin (dB) = Remark result (dBuV/m) – Quasi-peak limit (dBuV/m).

Report No.: T180528N06-RP1-2

Product Name	30W Wall Plate Audio Amplifier with CSR Bluetooth v4.2	Test Date	2018/09/25
Model Name	A-1430WP	Test By	Ted Huang
Test Mode	TX	Temp & Humidity	26.5°C, 62%

Horizontal

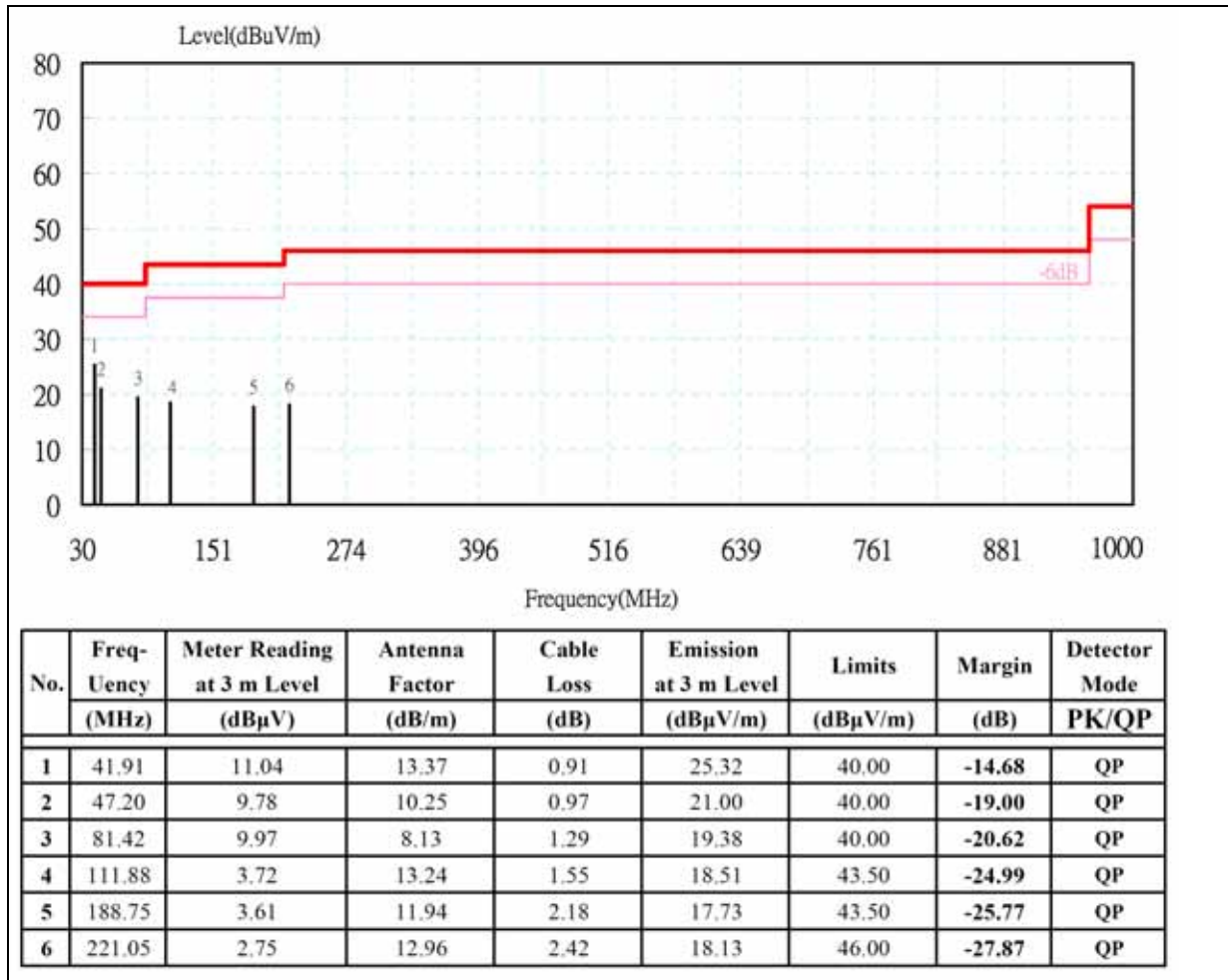

Remark:

1. No emission found between lowest internal used/generated frequency to 30MHz (9kHz~30MHz).
2. Radiated emissions measured were made with an instrument using peak/quasi-peak detector mode.
3. Quasi-peak test would be performed if the peak result were greater than the quasi-peak limit or as required by the applicant.
4. Margin (dB) = Remark result (dBuV/m) – Quasi-peak limit (dBuV/m).

Report No.: T180528N06-RP1-2

9.6.3 TRANSMIA-1430WPER RADIATED EMISSION ABOVE 1 GHz

Product Name	30W Wall Plate Audio Amplifier with CSR Bluetooth v4.2	Test Date	2018/10/05
Model	A-1430WP	Test By	Ted Huang
Test Mode	DSSS TX (CH Low)	TEMP& Humidity	26.4°C, 53%

Horizontal

TX / DSSS mode / CH Low				Measurement Distance at 3m				Horizontal polarity		
Freq.	Reading	AF	Cable Loss	Pre-amp	Filter	Level	Limit	Margin	Mark	
(MHz)	(dBμV)	(dB/m)	(dB)	(dB)	(dB)	(dBμV/m)	(dBμV/m)	(dB)	(P/Q/A)	
* 1176.86	62.57	25.14	2.02	45.28	0.42	44.87	74.00	-29.13	P	
* 1176.86	49.77	25.14	2.02	45.28	0.42	32.07	54.00	-21.93	A	
* 4803.91	61.12	32.91	4.37	44.32	0.22	54.31	74.00	-19.69	P	
* 4803.91	54.92	32.91	4.37	44.32	0.22	48.12	54.00	-5.88	A	
7205.28	58.29	38.70	5.50	44.04	0.27	58.72	74.00	-15.28	P	
7205.28	49.67	38.70	5.50	44.04	0.27	50.11	54.00	-3.89	A	

Product Name	30W Wall Plate Audio Amplifier with CSR Bluetooth v4.2	Test Date	2018/10/05
Model	A-1430WP	Test By	Ted Huang
Test Mode	DSSS TX (CH Low)	TEMP& Humidity	26.4°C, 53%

Vertical

TX / DSSS mode / CH Low				Measurement Distance at 3m				Vertical polarity		
Freq.	Reading	AF	Cable Loss	Pre-amp	Filter	Level	Limit	Margin	Mark	
(MHz)	(dBμV)	(dB/m)	(dB)	(dB)	(dB)	(dBμV/m)	(dBμV/m)	(dB)	(P/Q/A)	
* 1376.80	60.58	25.98	2.21	45.12	0.44	44.09	74.00	-29.91	P	
* 1376.80	48.86	25.98	2.21	45.12	0.44	32.37	54.00	-21.63	A	
* 4804.09	58.73	32.91	4.37	44.32	0.22	51.92	74.00	-22.08	P	
* 4804.09	52.27	32.91	4.37	44.32	0.22	45.46	54.00	-8.54	A	
7205.28	58.51	38.70	5.50	44.04	0.27	58.94	74.00	-15.06	P	
7205.28	49.28	38.70	5.50	44.04	0.27	49.71	54.00	-4.29	A	

REMARK:

1. AF: Antenna Factor, Cable: Cable Loss, Pre-Amp: Preamplifier gain, Filter: 2.4GHz~2.5GHz Filter Insertion Loss
2. Spectrum analyzer setting P(Peak): RBW=1MHz, VBW=1MHz, A(Average): RBW=1MHz, VBW=10Hz
3. The result basic equation calculation is as follow:
 $Level = Reading + AF + Cable - Preamp + Filter - Dist$, $Margin = Level - Limit$
4. The other emission levels were 20dB below the limit
5. The test limit distance is 3M limit.
6. *=Restricted bands of operation

Product Name	30W Wall Plate Audio Amplifier with CSR Bluetooth v4.2	Test Date	2018/10/05
Model	A-1430WP	Test By	Ted Huang
Test Mode	DSSS TX (CH Middle)	TEMP& Humidity	26.4°C, 53%

Horizontal

	TX / DSSS mode / CH Middle				Measurement Distance at 3m				Horizontal polarity	
	Freq.	Reading	AF	Cable Loss	Pre-amp	Filter	Level	Limit	Margin	Mark
	(MHz)	(dBμV)	(dB/m)	(dB)	(dB)	(dB)	(dBμV/m)	(dBμV/m)	(dB)	(P/Q/A)
*	1178.68	62.68	25.15	2.02	45.28	0.42	44.99	74.00	-29.01	P
*	1178.68	49.86	25.15	2.02	45.28	0.42	32.17	54.00	-21.83	A
*	4883.95	61.29	33.15	4.42	44.34	0.23	54.75	74.00	-19.25	P
*	4883.95	54.82	33.15	4.42	44.34	0.23	48.28	54.00	-5.72	A
*	7325.43	58.45	39.11	5.53	43.93	0.27	59.43	74.00	-14.57	P
*	7325.43	52.14	39.11	5.53	43.93	0.27	53.12	54.00	-0.88	A

Product Name	30W Wall Plate Audio Amplifier with CSR Bluetooth v4.2	Test Date	2018/10/05
Model	A-1430WP	Test By	Ted Huang
Test Mode	DSSS TX (CH Middle)	TEMP& Humidity	26.4°C, 53%

Vertical

	TX / DSSS mode / CH Middle				Measurement Distance at 3m				Vertical polarity	
	Freq.	Reading	AF	Cable Loss	Pre-amp	Filter	Level	Limit	Margin	Mark
	(MHz)	(dBμV)	(dB/m)	(dB)	(dB)	(dB)	(dBμV/m)	(dBμV/m)	(dB)	(P/Q/A)
*	1380.35	60.76	26.00	2.21	45.12	0.44	44.29	74.00	-29.71	P
*	1380.35	49.18	26.00	2.21	45.12	0.44	32.71	54.00	-21.29	A
*	4883.59	61.07	33.15	4.42	44.34	0.23	54.53	74.00	-19.47	P
*	4883.59	54.11	33.15	4.42	44.34	0.23	47.56	54.00	-6.44	A
*	7326.08	58.42	39.11	5.53	43.93	0.27	59.40	74.00	-14.60	P
*	7326.08	49.76	39.11	5.53	43.93	0.27	50.74	54.00	-3.26	A

REMARK:

1. AF: Antenna Factor, Cable: Cable Loss, Pre-Amp: Preamplifier gain, Filter: 2.4GHz~2.5GHz Filter Insertion Loss
2. Spectrum analyzer setting P(Peak): RBW=1MHz, VBW=1MHz, A(Average): RBW=1MHz, VBW=10Hz
3. The result basic equation calculation is as follow:
Level = Reading + AF + Cable – Preamp + Filter – Dist, Margin = Level-Limit
4. The other emission levels were 20dB below the limit
5. The test limit distance is 3M limit.
6. *=Restricted bands of operation

Product Name	30W Wall Plate Audio Amplifier with CSR Bluetooth v4.2	Test Date	2018/10/05
Model	A-1430WP	Test By	Ted Huang
Test Mode	DSSS TX (CH High)	TEMP& Humidity	26.4°C, 53%

Horizontal

TX / DSSS mode / CH High				Measurement Distance at 3m				Horizontal polarity	
Freq.	Reading	AF	Cable Loss	Pre-amp	Filter	Level	Limit	Margin	Mark
(MHz)	(dBµV)	(dB/m)	(dB)	(dB)	(dB)	(dBµV/m)	(dBµV/m)	(dB)	(P/Q/A)
* 1178.45	62.68	25.15	2.02	45.28	0.42	44.99	74.00	-29.01	P
* 1178.45	49.88	25.15	2.02	45.28	0.42	32.19	54.00	-21.81	A
* 4959.87	60.44	33.38	4.46	44.36	0.24	54.15	74.00	-19.85	P
* 4959.87	53.90	33.38	4.46	44.36	0.24	47.62	54.00	-6.38	A
* 7439.47	58.56	39.49	5.56	43.83	0.27	60.05	74.00	-13.95	P
* 7439.47	51.47	39.49	5.56	43.83	0.27	52.96	54.00	-1.04	A

Product Name	30W Wall Plate Audio Amplifier with CSR Bluetooth v4.2	Test Date	2018/10/05
Model	A-1430WP	Test By	Ted Huang
Test Mode	DSSS TX (CH High)	TEMP& Humidity	26.4°C, 53%

Vertical

TX / DSSS mode / CH High				Measurement Distance at 3m				Vertical polarity	
Freq.	Reading	AF	Cable Loss	Pre-amp	Filter	Level	Limit	Margin	Mark
(MHz)	(dBµV)	(dB/m)	(dB)	(dB)	(dB)	(dBµV/m)	(dBµV/m)	(dB)	(P/Q/A)
* 1380.85	60.42	26.00	2.21	45.12	0.44	43.96	74.00	-30.04	P
* 1380.85	49.03	26.00	2.21	45.12	0.44	32.57	54.00	-21.43	A
* 4959.76	59.50	33.38	4.46	44.36	0.24	53.21	74.00	-20.79	P
* 4959.76	53.27	33.38	4.46	44.36	0.24	46.98	54.00	-7.02	A
* 7439.27	56.78	39.49	5.56	43.83	0.27	58.27	74.00	-15.73	P
* 7439.27	50.28	39.49	5.56	43.83	0.27	51.77	54.00	-2.23	A

REMARK:

1. AF: Antenna Factor, Cable: Cable Loss, Pre-Amp: Preamplifier gain, Filter: 2.4GHz~2.5GHz Filter Insertion Loss
2. Spectrum analyzer setting P(Peak): RBW=1MHz, VBW=1MHz, A(Average): RBW=1MHz, VBW=10Hz
3. The result basic equation calculation is as follow:
Level = Reading + AF + Cable – Preamp + Filter – Dist, Margin = Level-Limit
4. The other emission levels were 20dB below the limit
5. The test limit distance is 3M limit.
6. *=Restricted bands of operation

Report No.: T180528N06-RP1-2

9.6.4 RESTRICTED BAND EDGES

Detector mode : Peak

Polarity : Horizontal

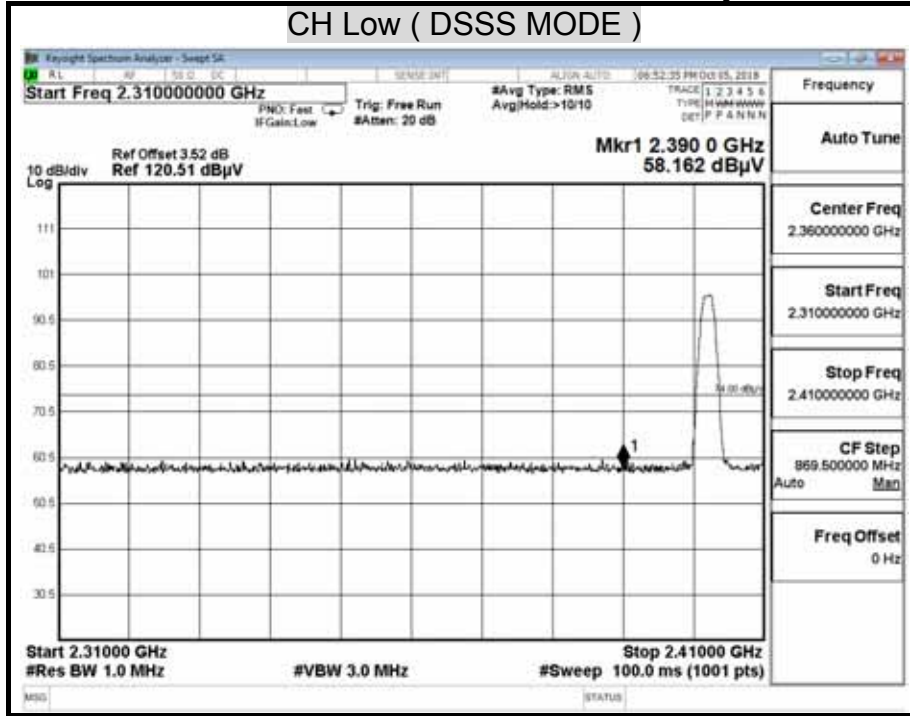

Detector mode : Average

Polarity : Horizontal

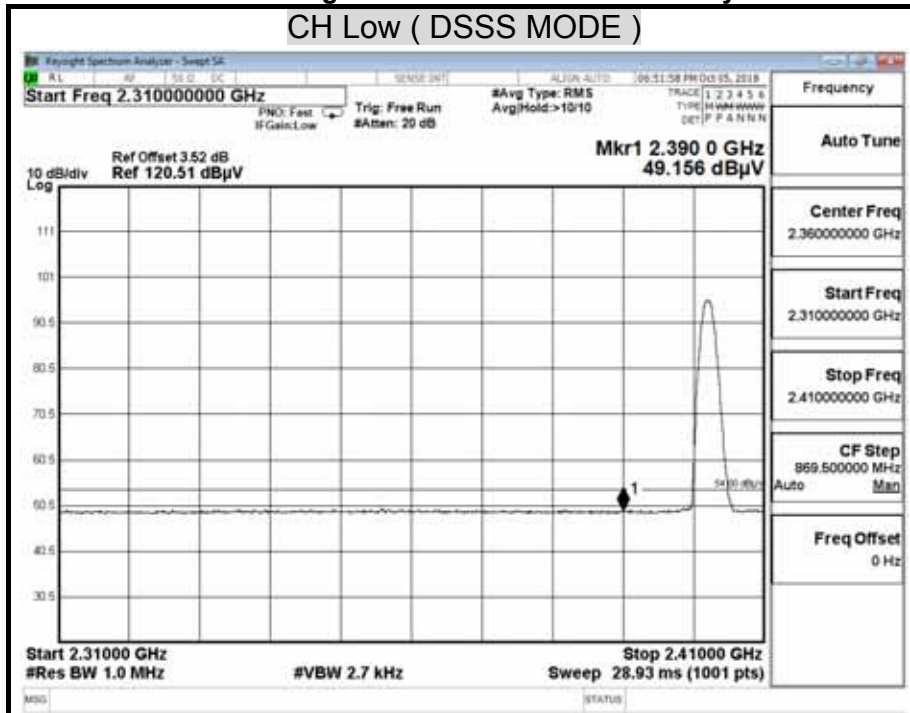

Detector mode : Peak

Polarity : Vertical

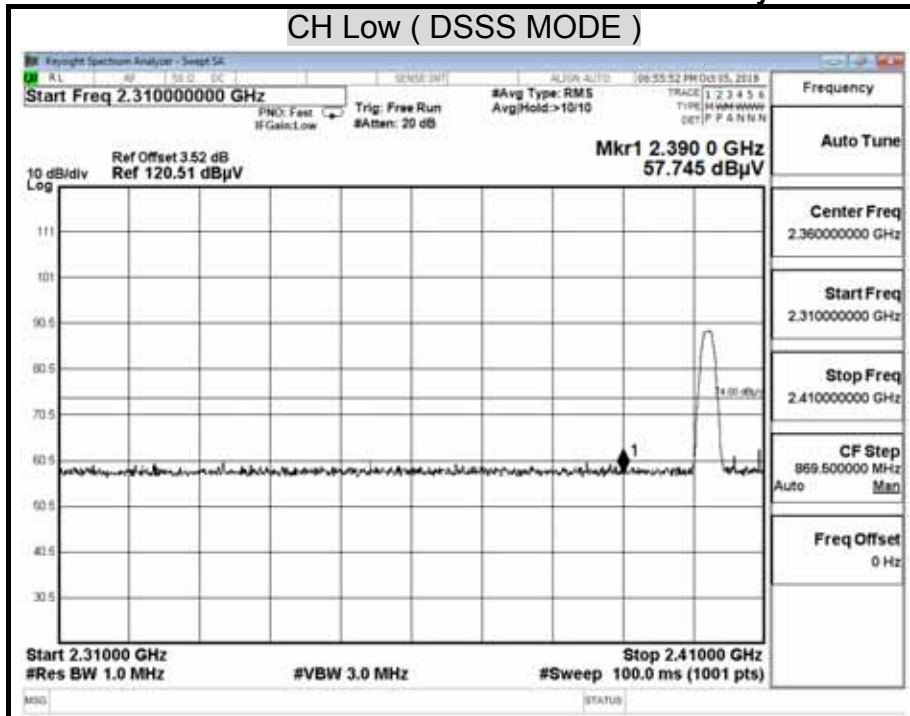

Detector mode : Average

Polarity : Vertical

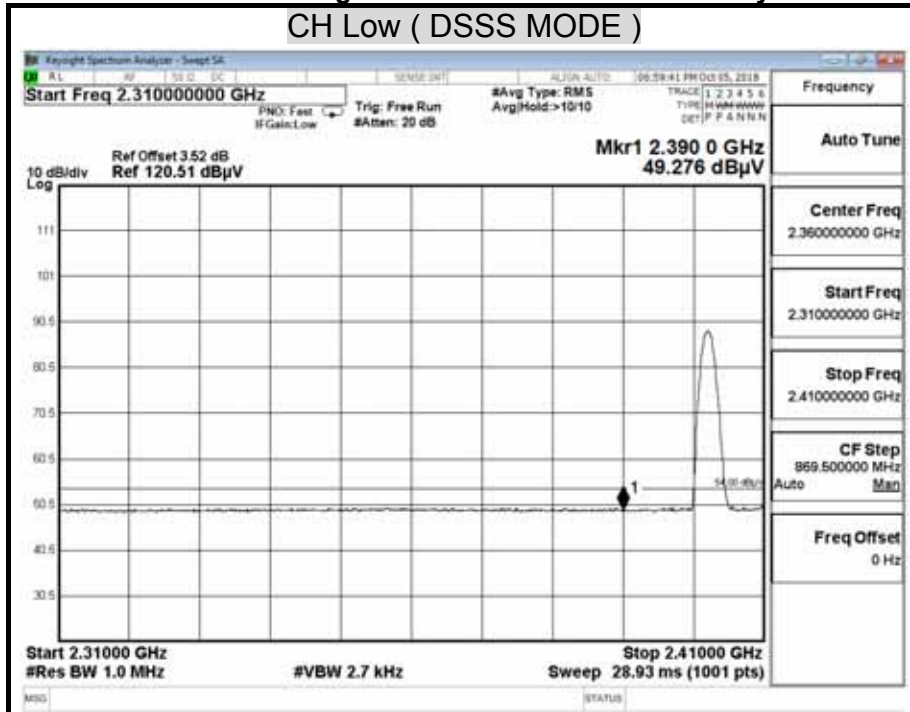

Detector mode : Peak **Polarity : Horizontal**

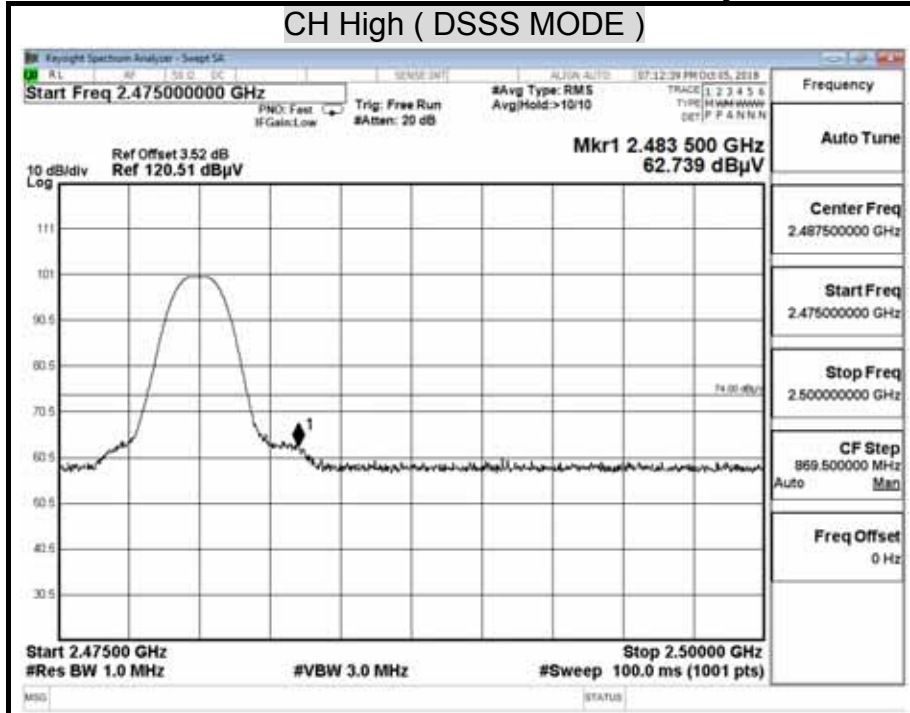

Detector mode : Average **Polarity : Horizontal**

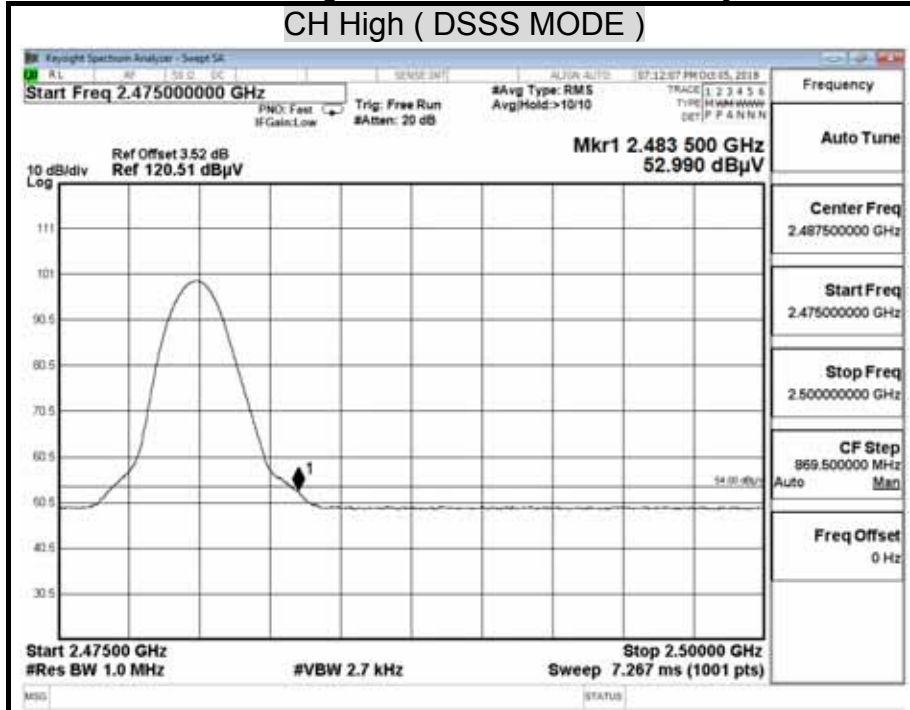

Detector mode : Peak

Polarity : Vertical

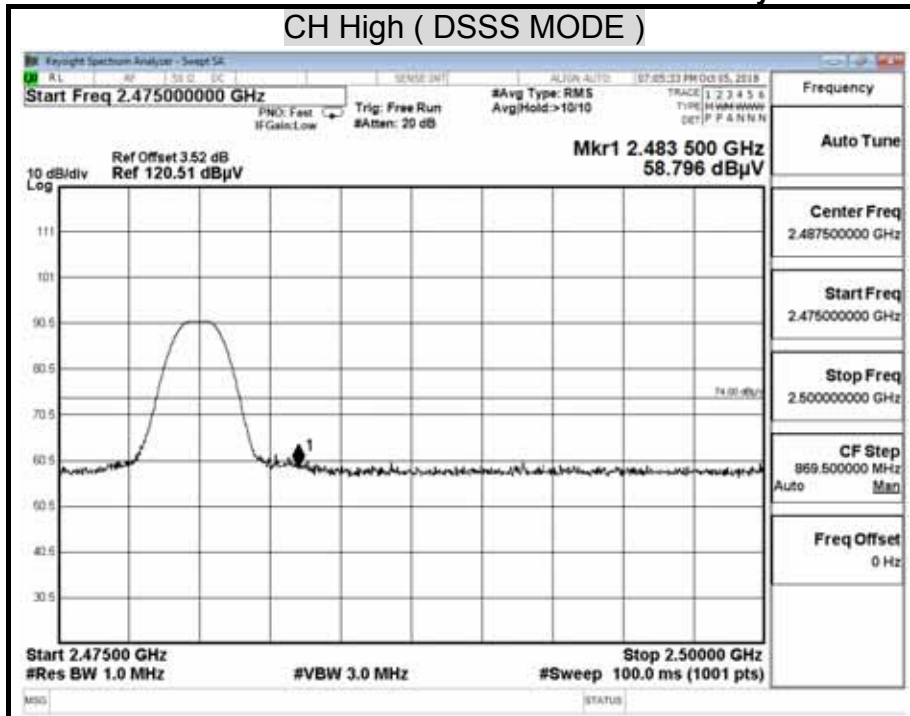

Detector mode : Average

Polarity : Vertical

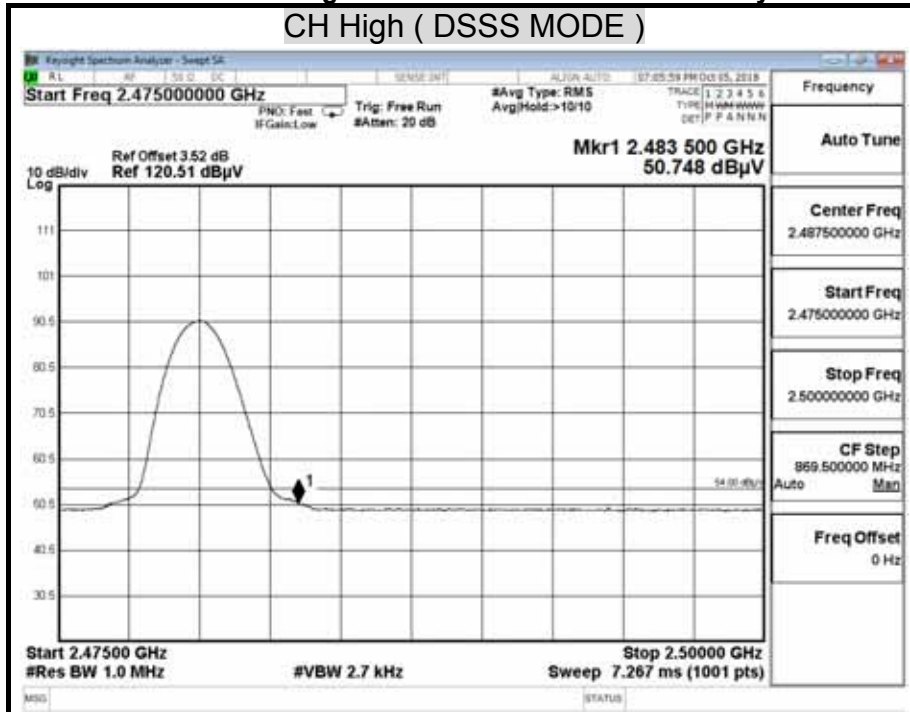

9.7 POWERLINE CONDUCTED EMISSIONS

LIMITS

§ 15.207 (a) Except as shown in paragraph (b) and (c) this section, for an intentional radiator that is designed to be connected to the public utility (AC) power line, the radio frequency voltage that is conducted back onto the AC power line on any frequency or frequencies within the band 150 kHz to 30 MHz shall not exceed the limits in the following table, as measured using a 50 μ H/50 ohms line impedance stabilization network (LISN). Compliance with the provisions of this paragraph shall be based on the measurement of the radio frequency voltage between each power line and ground at the power terminal.

The lower limit applies at the boundary between the frequency ranges.

Frequency of Emission (MHz)	Conducted limit (dB μ v)	
	Quasi-peak	Average
0.15 - 0.5	66 to 56	56 to 46
0.5 - 5	56	46
5 - 30	60	50

Report No.: T180528N06-RP1-2

TEST SETUP

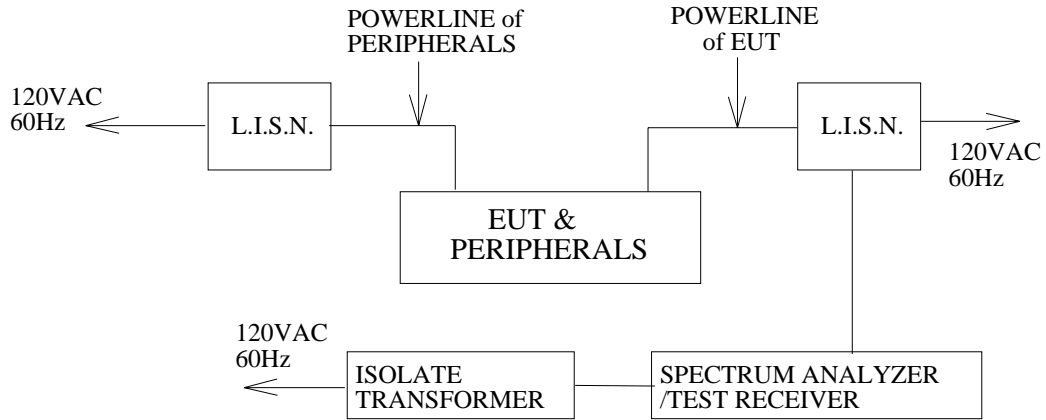

TEST PROCEDURE

The EUT is placed on a non-conducting table 40 cm from the vertical ground plane and 80cm above the horizontal ground plane. The EUT IS CONFIGURED IN ACCORDANCE WITH ANSI C63.10.

The resolution bandwidth is set to 9 kHz for both quasi-peak detection and average detection measurements.

Line conducted data is recorded for both NEUTRAL and LINE.

Report No.: T180528N06-RP1-2

TEST RESULTS

No non-compliance noted.

Model No.	A-1430WP	Test Mode	AUX IN
Environmental Conditions	23.9 , 67% RH	Resolution Bandwidth	9 kHz
Tested by	Andy Yang		

LINE

(The chart below shows the highest readings taken from the final data.)

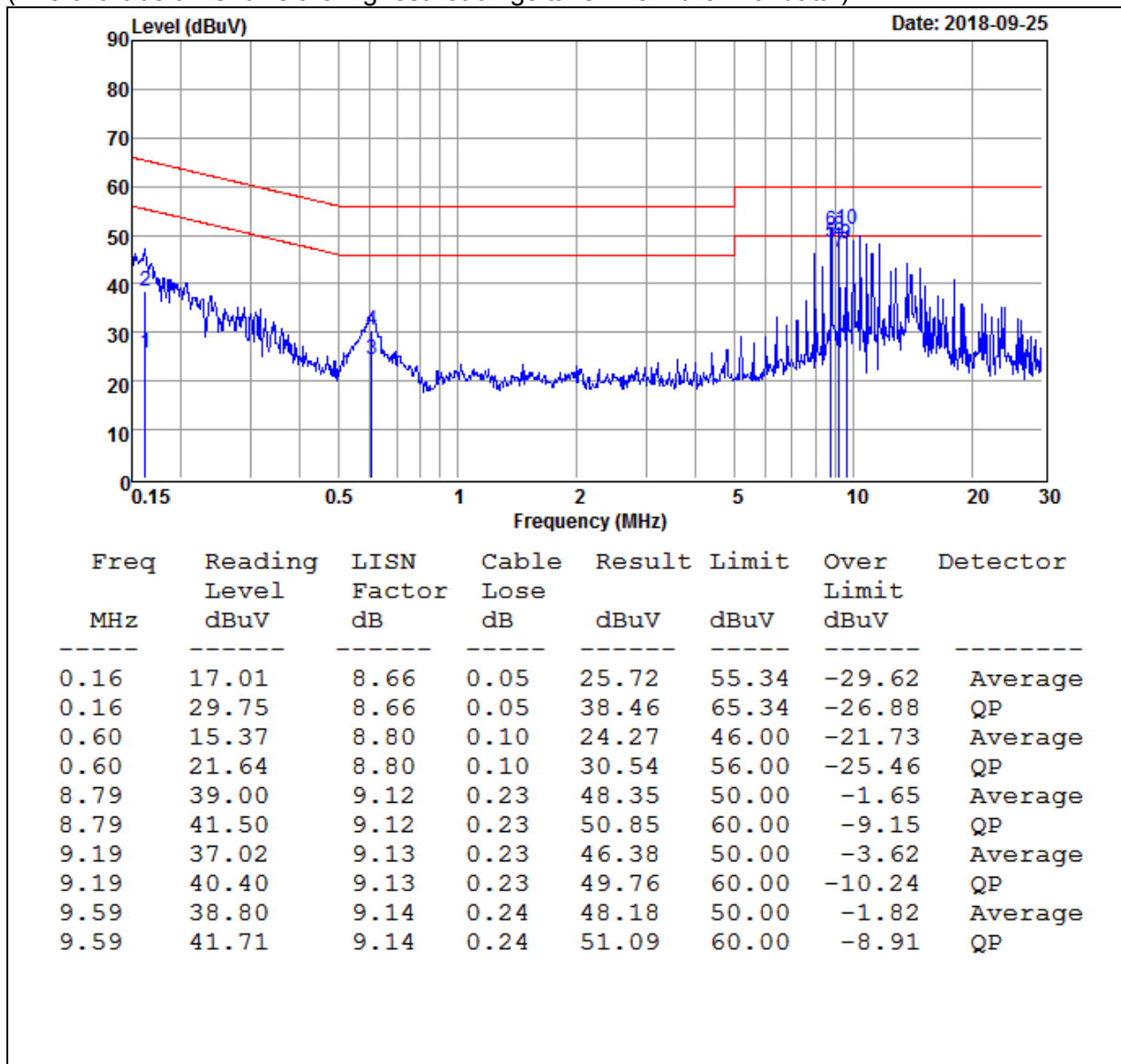

- REMARKS :
- Level (dBuV) = Read Level (dBuV) + LISN Factor (dB) + Cable Loss (dB)
 - Over Limit (dBuV) = Measured Level (dBuV) – Limits (dBuV)

Model No.	A-1430WP	Test Mode	AUX IN
Environmental Conditions	23.9 , 67% RH	Resolution Bandwidth	9 kHz
Tested by	Andy Yang		

NEUTRAL

(The chart below shows the highest readings taken from the final data.)

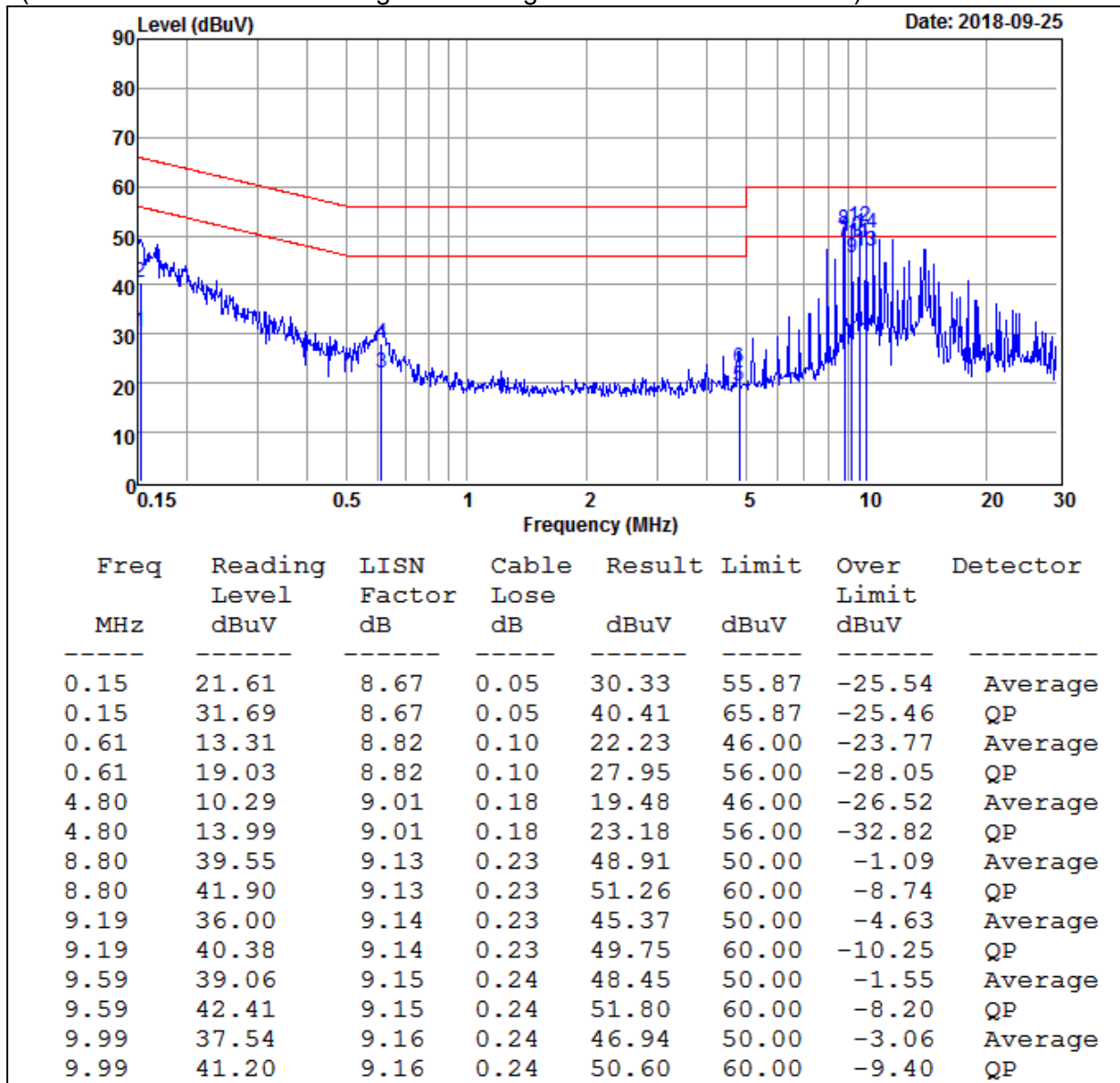

- REMARKS :
- Level (dBUV) = Read Level (dBUV) + LISN Factor (dB) + Cable Loss (dB)
 - Over Limit (dBUV) = Measured Level (dBUV) – Limits (dBUV)

10. ANTENNA REQUIREMENT

10.1 STANDARD APPLICABLE

For intentional device, according to FCC 47 CFR Section 15.203, an intentional radiator shall be designed to ensure that no antenna other than that furnished by the responsible party shall be used with the device.

And according to FCC 47 CFR Section 15.247 (b), if transmitting antennas of directional gain greater than 6dBi are used, the power shall be reduced by the amount in dB that the directional gain of the antenna exceeds 6dBi.

10.2 ANTENNA CONNECTED CONSTRUCTION

Manufacturer: Ten Tronics Co., Ltd.
Type: PCB Antenna
Model: TT-ANT01
Gain: -2.00 dBi

=== END of Report ===