

APPLICATION CERTIFICATION FCC Part 22&24  
On Behalf of  
IMC INTERNATIONAL INC.

5.5inch 3G TABLET  
Model No.: FORCE XT55SP

FCC ID: 2ACI7-XT55SP

Prepared for : IMC INTERNATIONAL INC.  
Address : 28E Jingang, xixiang, Bao an District, Shenzhen,  
Guangdong Province, China  
Prepared by : ACCURATE TECHNOLOGY CO., LTD  
Address : F1, Bldg. A, Changyuan New Material Port, Keyuan  
Rd. Science & Industry Park, Nanshan, Shenzhen,  
Guangdong P.R. China

Tel: (0755) 26503290  
Fax: (0755) 26503396

Report No. : ATE20141096  
Date of Test : June 18-July 07,2014  
Date of Report : July 07,2014

## TABLE OF CONTENTS

Description	Page
Test Report Certification	
<b>1. GENERAL INFORMATION .....</b>	<b>5</b>
1.1. Description of Device (EUT).....	5
1.2. Carrier Frequency of Channels.....	6
1.3. Description of Test Facility .....	6
1.4. Measurement Uncertainty.....	6
<b>2. MEASURING DEVICE AND TEST EQUIPMENT .....</b>	<b>7</b>
<b>3. SYSTEM TEST CONFIGURATION .....</b>	<b>8</b>
3.1. Justification.....	8
3.2. Configuration of Test Setup.....	8
3.3. Block Diagram of Test Setup.....	8
<b>4. TEST PROCEDURES AND RESULTS .....</b>	<b>9</b>
<b>5. POWER LINE CONDUCTED MEASUREMENT .....</b>	<b>10</b>
5.1. Block Diagram of Test Setup.....	10
5.2. Power Line Conducted Emission Measurement Limits.....	10
5.3. Configuration of EUT on Measurement .....	10
5.4. Operating Condition of EUT .....	10
5.5. Test Procedure .....	11
5.6. Power Line Conducted Emission Measurement Results .....	11
<b>6. BANDWIDTH MEASUREMENT .....</b>	<b>15</b>
6.1. Block Diagram of Test Setup.....	15
6.2. Applicable Standard.....	15
6.3. Operating Condition of EUT .....	15
6.4. Test Procedure .....	15
6.5. Test Result .....	16
<b>7. RF OUTPUT POWER.....</b>	<b>23</b>
7.1. Block Diagram of Test Setup.....	23
7.2. The Requirement For FCC Section §2.1046 and §22.913 (a) & §24.232 (C).....	23
7.3. Operating Condition of EUT .....	24
7.4. Test Procedure .....	24
7.5. Test Result .....	25
<b>8. SPURIOUS EMISSIONS AT ANTENNA TERMINALS .....</b>	<b>28</b>
8.1. Block Diagram of Test Setup.....	28
8.2. Applicable Standard.....	28
8.3. EUT Configuration on Measurement .....	28
8.4. Operating Condition of EUT .....	28
8.5. Test Procedure .....	28
8.6. Test Result .....	29
<b>9. BAND EDGE TEST .....</b>	<b>34</b>
9.1. Block Diagram of Test Setup.....	34
9.2. The Requirement For Section § 22.917(a), §24.238(a) .....	34
9.3. Operating Condition of EUT .....	34
9.4. Test Procedure .....	34

9.5. Test Result .....35

**10. RADIATED SPURIOUS EMISSION TEST ..... 38**

10.1. Block Diagram of Test Setup.....38

10.2. Applicable Standard.....38

10.3. Restricted bands of operation .....39

10.4. Configuration of EUT on Measurement .....39

10.5. Operating Condition of EUT .....39

10.6. Test Procedure .....40

10.7. The Field Strength of Radiation Emission Measurement Results .....40

**11. FREQUENCY STABILITY ..... 43**

11.1. Block Diagram of Test Setup.....43

11.2. The Requirement For Section CFR47 § 2.1055 (a), § 2.1055 (d), §22.355, §24.235 .....43

11.3. Operating Condition of EUT .....43

11.4. Test Procedure .....43

11.5. Test Result .....44

**12. ANTENNA REQUIREMENT..... 45**

12.1. The Requirement .....45

12.2. Antenna Construction .....45

## Test Report Certification

Applicant : IMC INTERNATIONAL INC.  
Manufacturer : IMC INTERNATIONAL INC.  
EUT Description : 5.5inch 3G TABLET  
(A) MODEL NO.: FORCE XT55SP  
(B) Trade Name.: /  
(C) POWER SUPPLY: DC 5V (USB Port ) &DC 3.7V (Battery)

Measurement Procedure Used:

**FCC Rules and Regulations Part 22 Subpart H - Public Mobile Services  
Part 24 Subpart E - Personal Communication Services  
TIA 603-D**

The device described above is tested by ACCURATE TECHNOLOGY CO. LTD to determine the maximum emission levels emanating from the device. The maximum emission levels are compared to the FCC Part 22H&24E limits. The measurement results are contained in this test report and ACCURATE TECHNOLOGY CO. LTD is assumed full responsibility for the accuracy and completeness of these measurements. Also, this report shows that the Equipment Under Test (EUT) is to be technically compliant with the FCC requirements.

This report applies to above tested sample only. This report shall not be reproduced in part without written approval of ACCURATE TECHNOLOGY CO. LTD.

Date of Test : Jun 04, 2014-July 07,2014

Prepared by :   
( Eric , Engineer)

Approved & Authorized Signer :   
( Sean Liu, Manager)

## 1. GENERAL INFORMATION

### 1.1. Description of Device (EUT)

EUT	:	5.5inch 3G TABLET
Model Number	:	FORCE XT55SP
Frequency Range	:	GSM 850: 824.2-848.8 MHz 124 Channels GSM 1900 : 1850.2-1909.8 MHz 299 Channels FDD V: 826.4-846.6 MHz 277 Channels FDD II : 1852.4-1907.6 MHz 102 Channels 802.11b/g/n (20MHz): 2412-2462MHz 11 Channels 802.11n (40MHz): 2422-2452MHz 7 Channels Bluetooth 4.0 LE: 2402-2480MHz 40 Channels Bluetooth 2.1: 2402-2480MHz 79 Channels
Modulation	:	GSM GPRS: GMSK FDD: QPSK WLAN: CCK,OFDM BT:GFSK,π/4-DQPSK, 8DPSK
Antenna Gain	:	0.5dBi(BT&WLAN) 1.5dBi(GSM & FDD)
Power Supply Adapter	:	DC 5V (USB Port ) &DC 3.7V (Battery) Model number: UBP-A806-051000 Input: AC 100-240V; 50/60Hz Output: DC 5V/1000mA USB line: Non-shielded, Non-detachable, 1.5m
Applicant	:	IMC INTERNATIONAL INC.
Address	:	28E Jingang, Xixiang, Bao an District Shenzhen,Guangdong Province,China
Manufacturer	:	IMC INTERNATIONAL INC.
Address	:	28E Jingang, Xixiang, Bao an District Shenzhen,Guangdong Province,China
Date of sample received	:	June 18,2014
Date of Test	:	June 18-July 07,2014

## 1.2. Carrier Frequency of Channels

Frequency Range:

Cellular Band: 824-849 MHz (TX), 869-894 MHz (RX)

PCS Band: 1850-1910 MHz (TX), 1930-1990 MHz (RX)

Modulation Mode: GMSK

## 1.3. Description of Test Facility

EMC Lab : Accredited by TUV Rheinland Shenzhen

Listed by FCC

The Registration Number is 752051

Listed by Industry Canada

The Registration Number is 5077A-2

Accredited by China National Accreditation Committee  
for Laboratories

The Certificate Registration Number is L3193

Name of Firm : ACCURATE TECHNOLOGY CO. LTD

Site Location : F1, Bldg. A, Changyuan New Material Port, Keyuan Rd.  
Science & Industry Park, Nanshan, Shenzhen, Guangdong  
P.R. China

## 1.4. Measurement Uncertainty

Conducted Emission Expanded Uncertainty = 2.23dB, k=2

Radiated emission expanded uncertainty = 3.08dB, k=2  
(9kHz-30MHz)

Radiated emission expanded uncertainty = 4.42dB, k=2  
(30MHz-1000MHz)

Radiated emission expanded uncertainty = 4.06dB, k=2  
(Above 1GHz)

## 2. MEASURING DEVICE AND TEST EQUIPMENT

**Table 1: List of Test and Measurement Equipment**

Kind of equipment	Manufacturer	Type	S/N	Calibrated dates	Calibrated until
EMI Test Receiver	Rohde&Schwarz	ESCS30	100307	Jan. 11, 2014	Jan. 10, 2015
EMI Test Receiver	Rohde&Schwarz	ESPI3	101526/003	Jan. 11, 2014	Jan. 10, 2015
Spectrum Analyzer	Agilent	E7405A	MY45115511	Jan. 11, 2014	Jan. 10, 2015
Pre-Amplifier	Rohde&Schwarz	CBLU118354 0-01	3791	Jan. 11, 2014	Jan. 10, 2015
Loop Antenna	Schwarzbeck	FMZB1516	1516131	Jan. 15, 2014	Jan. 14, 2015
Bilog Antenna	Schwarzbeck	VULB9163	9163-323	Jan. 15, 2014	Jan. 14, 2015
Horn Antenna	Schwarzbeck	BBHA9120D	9120D-655	Jan. 15, 2014	Jan. 14, 2015
Horn Antenna	Schwarzbeck	BBHA9170	9170-359	Jan. 15, 2014	Jan. 14, 2015
LISN	Rohde&Schwarz	ESH3-Z5	100305	Jan. 11, 2014	Jan. 10, 2015
LISN	Schwarzbeck	NSLK8126	8126431	Jan. 11, 2014	Jan. 10, 2015
Highpass Filter	Wainwright Instruments	WHKX3.6/18 G-10SS	N/A	Jan. 11, 2014	Jan. 10, 2015
Band Reject Filter	Wainwright Instruments	WRCG2400/2 485-2375/2510 -60/11SS	N/A	Jan. 11, 2014	Jan. 10, 2015
Universal radio communication tester	Rohde&Schwarz	CMU200	100308	Jan. 11, 2014	Jan. 10, 2015

### 3. SYSTEM TEST CONFIGURATION

#### 3.1. Justification

The EUT was configured for testing according to TIA/EIA-603-D.  
The final qualification test was performed with the EUT operating at normal mode.

#### 3.2. Configuration of Test Setup

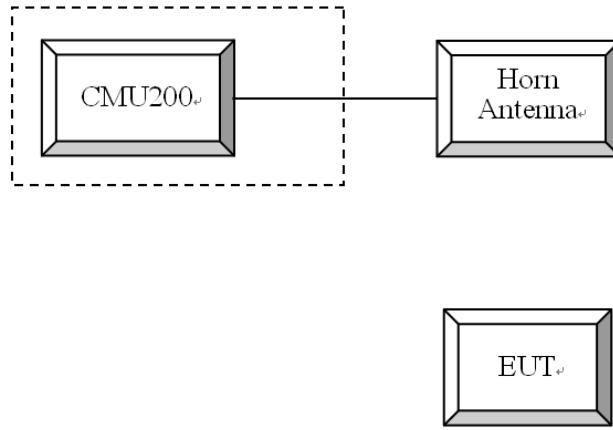

#### 3.3. Block Diagram of Test Setup

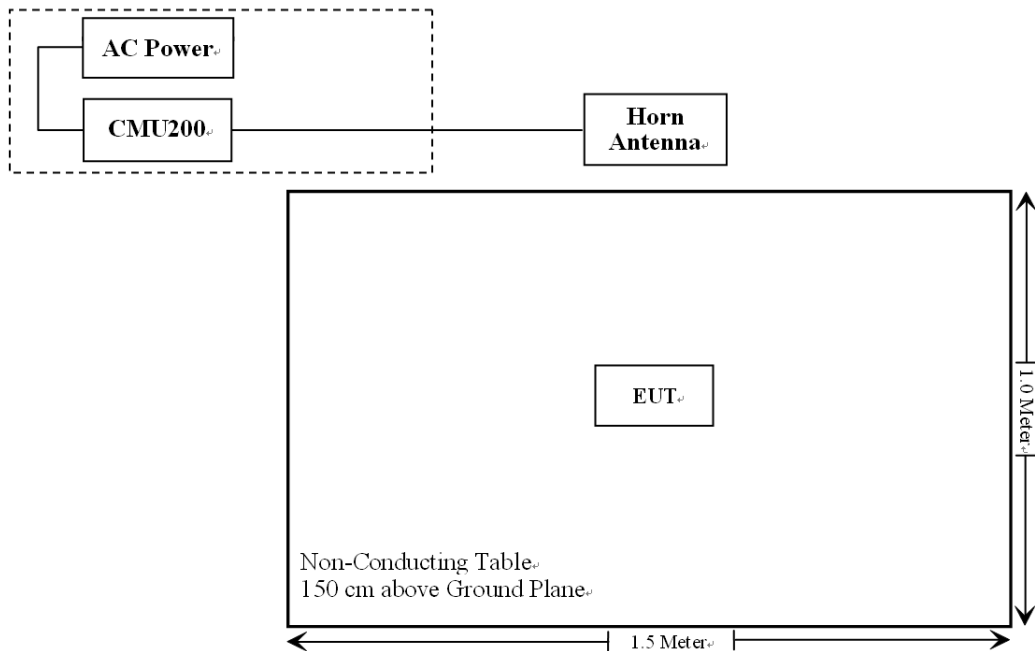



#### 4. TEST PROCEDURES AND RESULTS

<b>FCC Rules</b>	<b>Description of Test</b>	<b>Result</b>
Section 15.207	Power Line Conducted Emission	Compliant
§2.1046; § 22.913 (a); § 24.232 (c)	RF Output Power	Compliant
§ 2.1047	Modulation Characteristics	N/A
§ 2.1049; § 22.905 § 22.917; § 24.238	99% & -26 dB Occupied Bandwidth	Compliant
§ 2.1051, § 22.917 (a); § 24.238 (a)	Spurious Emissions at Antenna Terminal	Compliant
§ 2.1053 § 22.917 (a); § 24.238 (a)	Field Strength of Spurious Radiation	Compliant
§ 22.917 (a); § 24.238 (a)	Out of band emission, Band Edge	Compliant
§ 2.1055 § 22.355; § 24.235	Frequency stability vs. temperature Frequency stability vs. voltage	Compliant

## 5. POWER LINE CONDUCTED MEASUREMENT

### 5.1. Block Diagram of Test Setup

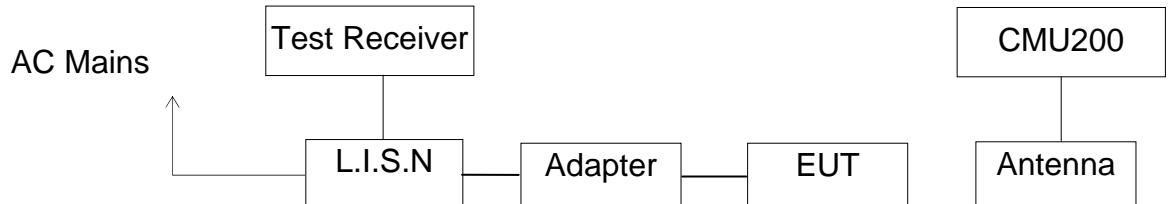

(EUT: 5.5inch 3G TABLET)

### 5.2. Power Line Conducted Emission Measurement Limits

Frequency (MHz)	Limit dB( $\mu$ V)	
	Quasi-peak Level	Average Level
0.15 - 0.50	66.0 – 56.0 *	56.0 – 46.0 *
0.50 - 5.00	56.0	46.0
5.00 - 30.00	60.0	50.0

NOTE1: The lower limit shall apply at the transition frequencies.  
NOTE2: The limit decreases linearly with the logarithm of the frequency in the range 0.15MHz to 0.50MHz.

### 5.3. Configuration of EUT on Measurement

The following equipments are installed on Power Line Conducted Emission Measurement to meet the commission requirement and operating regulations in a manner, which tends to maximize its emission characteristics in a normal application.

### 5.4. Operating Condition of EUT

5.4.1. Setup the EUT and simulator as shown as Section 5.1.

5.4.2. Turn on the power of all equipment.

5.4.3. Let the EUT work in test mode and measure it.

### 5.5. Test Procedure

The EUT is put on the plane 0.8m high above the ground by insulating support and is connected to the power mains through a line impedance stabilization network (L.I.S.N.). This provides a 50ohm coupling impedance for the EUT system. Please refer the block diagram of the test setup and photographs. Both sides of AC lines are checked to find out the maximum conducted emission. In order to find the maximum emission levels, the relative positions of equipment and all of the interface cables shall be changed according to ANSI C63.4: 2009 on Conducted Emission Measurement.

The bandwidth of test receiver (R & S ESCS30) is set at 9kHz.

The frequency range from 150kHz to 30MHz is checked.

### 5.6. Power Line Conducted Emission Measurement Results

**PASS.**

The frequency range from 150kHz to 30MHz is checked.

Test mode : Charging&GSM (Worst case)								
<b>MEASUREMENT RESULT: "RY0625-32_fin"</b>								
6/25/2014 4:51PM								
Frequency MHz	Level dBµV	Transd dB	Limit dBµV	Margin dB	Detector	Line	PE	
0.529205	30.70	10.7	56	25.3	QP	L1	GND	
1.378041	35.30	10.9	56	20.7	QP	L1	GND	
15.033396	26.00	11.4	60	34.0	QP	L1	GND	
<b>MEASUREMENT RESULT: "RY0625-32_fin2"</b>								
6/25/2014 4:51PM								
Frequency MHz	Level dBµV	Transd dB	Limit dBµV	Margin dB	Detector	Line	PE	
0.529205	39.30	10.7	46	6.7	AV	L1	GND	
1.375290	34.10	10.9	46	11.9	AV	L1	GND	
15.033396	22.50	11.4	50	27.5	AV	L1	GND	
<b>MEASUREMENT RESULT: "RY0625-33_fin"</b>								
6/25/2014 4:55PM								
Frequency MHz	Level dBµV	Transd dB	Limit dBµV	Margin dB	Detector	Line	PE	
0.530263	39.50	10.7	56	16.5	QP	N	GND	
1.483774	31.60	10.9	56	24.4	QP	N	GND	
15.184333	30.00	11.4	60	30.0	QP	N	GND	
<b>MEASUREMENT RESULT: "RY0625-33_fin2"</b>								
6/25/2014 4:55PM								
Frequency MHz	Level dBµV	Transd dB	Limit dBµV	Margin dB	Detector	Line	PE	
0.529205	37.90	10.7	46	8.1	AV	N	GND	
1.483774	30.00	10.9	46	16.0	AV	N	GND	
6.154398	23.70	11.2	50	26.3	AV	N	GND	

Emissions attenuated more than 20 dB below the permissible value are not reported.

The spectral diagrams are attached as below.

ACCURATE TECHNOLOGY CO., LTD

**CONDUCTED EMISSION STANDARD FCC PART 15B**

EUT: 5.5inch 3G TABLET M/N:Force XT55SP  
 Manufacturer: IMC  
 Operating Condition: GSM/Charging  
 Test Site: 1#Shielding Room  
 Operator: Ricky  
 Test Specification: L 120V/60Hz  
 Comment:

Report No:ATE20141096

**SCAN TABLE: "V 150K-30MHz fin"**

Short Description: \_SUB\_STD\_VTERM2 1.70  
 Start Stop Step Detector Meas. IF Transducer  
 Frequency Frequency Width Time Bandw.  
 150.0 kHz 30.0 MHz 4.5 kHz QuasiPeak 1.0 s 9 kHz NSLK8126 2008  
 Average

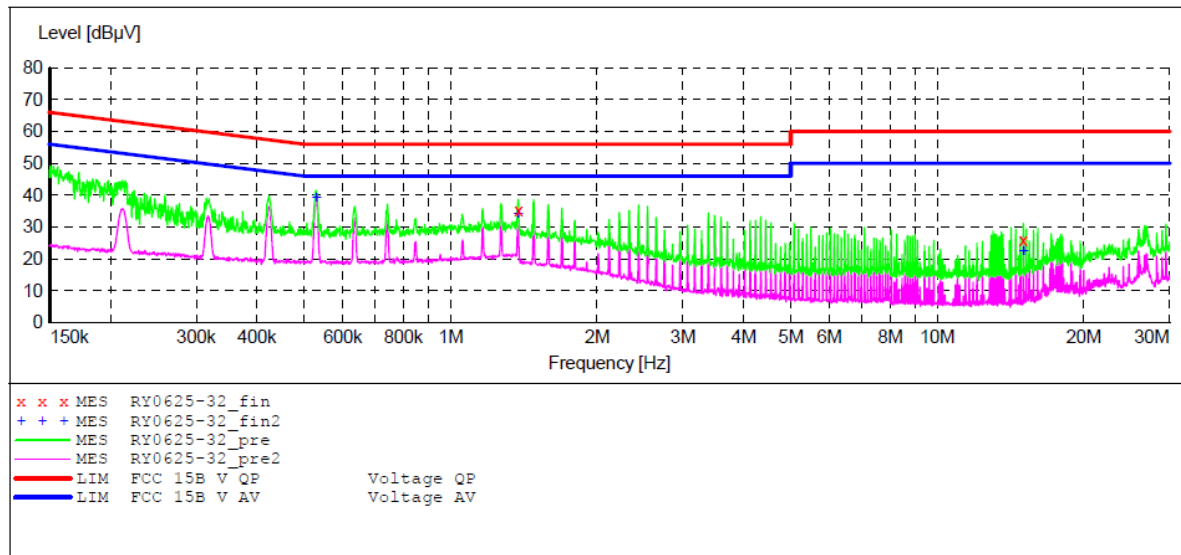

**MEASUREMENT RESULT: "RY0625-32\_fin"**

6/25/2014 4:51PM

Frequency MHz	Level dBµV	Transd dB	Limit dBµV	Margin dB	Detector	Line	PE
0.529205	30.70	10.7	56	25.3	QP	L1	GND
1.378041	35.30	10.9	56	20.7	QP	L1	GND
15.033396	26.00	11.4	60	34.0	QP	L1	GND

**MEASUREMENT RESULT: "RY0625-32\_fin2"**

6/25/2014 4:51PM

Frequency MHz	Level dBµV	Transd dB	Limit dBµV	Margin dB	Detector	Line	PE
0.529205	39.30	10.7	46	6.7	AV	L1	GND
1.375290	34.10	10.9	46	11.9	AV	L1	GND
15.033396	22.50	11.4	50	27.5	AV	L1	GND

ACCURATE TECHNOLOGY CO., LTD

**CONDUCTED EMISSION STANDARD FCC PART 15B**

EUT: 5.5inch 3G TABLET M/N:Force XT55SP  
 Manufacturer: IMC  
 Operating Condition: GSM/Charging  
 Test Site: 1#Shielding Room  
 Operator: Ricky  
 Test Specification: N 120V/60Hz  
 Comment:

Report No:ATE20141096

**SCAN TABLE: "V 150K-30MHZ fin"**

Short Description: \_SUB\_STD\_VTERM2 1.70  
 Start Stop Step Detector Meas. IF Transducer  
 Frequency Frequency Width Time Bandw.  
 150.0 kHz 30.0 MHz 4.5 kHz QuasiPeak 1.0 s 9 kHz NSLK8126 2008  
 Average

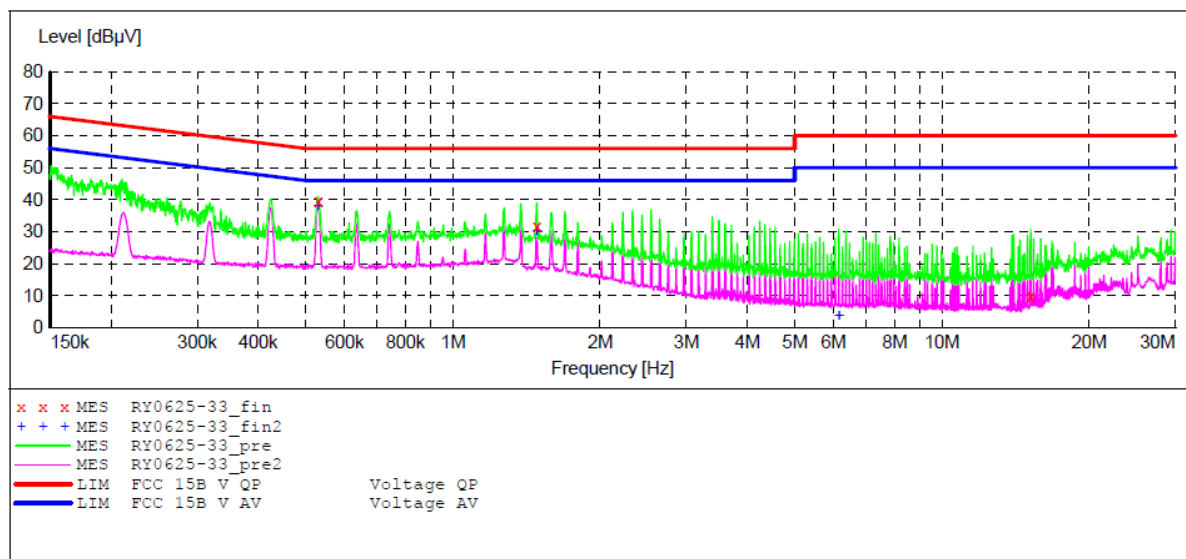

**MEASUREMENT RESULT: "RY0625-33\_fin"**

6/25/2014 4:55PM

Frequency MHz	Level dBµV	Transd dB	Limit dBµV	Margin dB	Detector	Line	PE
0.530263	39.50	10.7	56	16.5	QP	N	GND
1.483774	31.60	10.9	56	24.4	QP	N	GND
15.184333	30.00	11.4	60	30.0	QP	N	GND

**MEASUREMENT RESULT: "RY0625-33\_fin2"**

6/25/2014 4:55PM

Frequency MHz	Level dBµV	Transd dB	Limit dBµV	Margin dB	Detector	Line	PE
0.529205	37.90	10.7	46	8.1	AV	N	GND
1.483774	30.00	10.9	46	16.0	AV	N	GND
6.154398	23.70	11.2	50	26.3	AV	N	GND

## 6. BANDWIDTH MEASUREMENT

### 6.1. Block Diagram of Test Setup

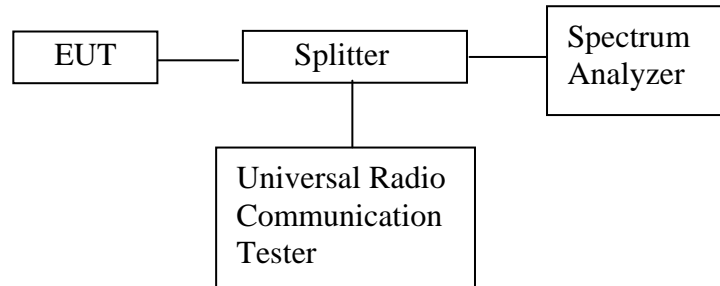

### 6.2. Applicable Standard

FCC § 2.1049, § 22.917, § 22.905 and § 24.238.

### 6.3. Operating Condition of EUT

6.3.1. Setup the EUT and simulator as shown as Section 6.1.

6.3.2. Turn on the power of all equipment.

6.3.3. Let the EUT work in TX modes measure it. The transmit frequency are 824-849MHz and 1850-1910MHz. We select 824.2MHz, 836.6MHz, 848.8MHz and 1850.2MHz, 1880.0MHz, 1909.8MHz TX frequency to transmit.

### 6.4. Test Procedure

99% occupied bandwidth & -26dB occupied bandwidth test:

1. Set resolution bandwidth (RBW) = 5 kHz.
2. Set the video bandwidth (VBW)  $\geq 3 \times$  RBW.
3. Detector = Peak.
4. Trace mode = max hold.
5. Sweep = auto couple.
6. Allow the trace to stabilize.
7. Measurements are to be performed with the EUT set to the low, middle and high channel of each frequency band.

### 6.5. Test Result

Cellular Band (Part 22H)			
Channel	Frequency (MHz)	99% Occupied Bandwidth (kHz)	-26dB occupied bandwidth (kHz)
128	824.2	245.19	313.30
190	836.6	248.40	310.10
251	848.8	242.79	313.30

PCS Band (Part 24E)			
Channel	Frequency (MHz)	99% Occupied Bandwidth (kHz)	-26dB occupied bandwidth (kHz)
512	1850.2	242.79	314.10
661	1880.0	244.39	317.30
810	1909.8	247.60	310.90

The spectrum analyzer plots are attached as below.

#### Cellular Band (Part 22H)

99% Occupied Bandwidth, Low Channel

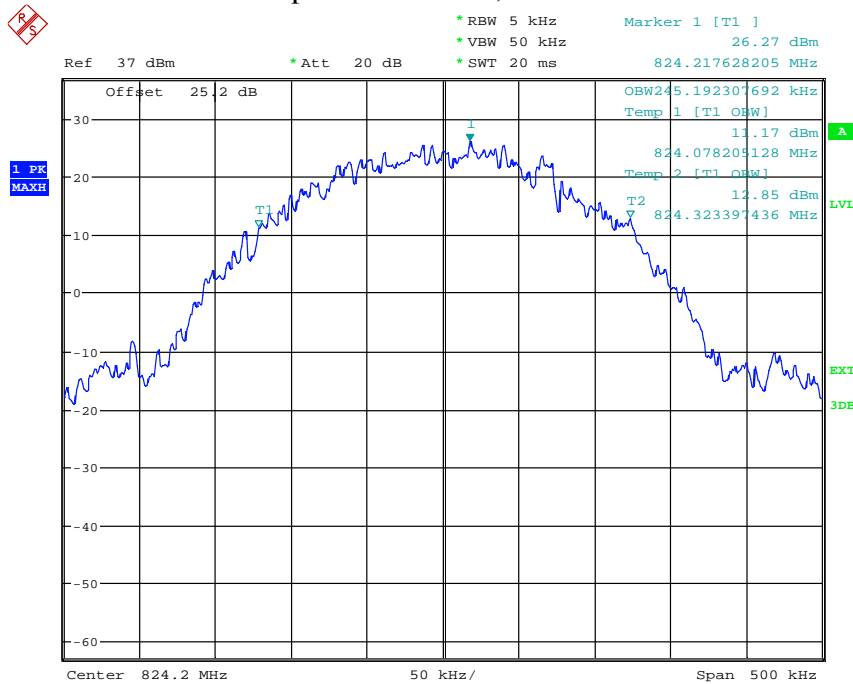



### 26 dB Occupied Bandwidth, Low Channel

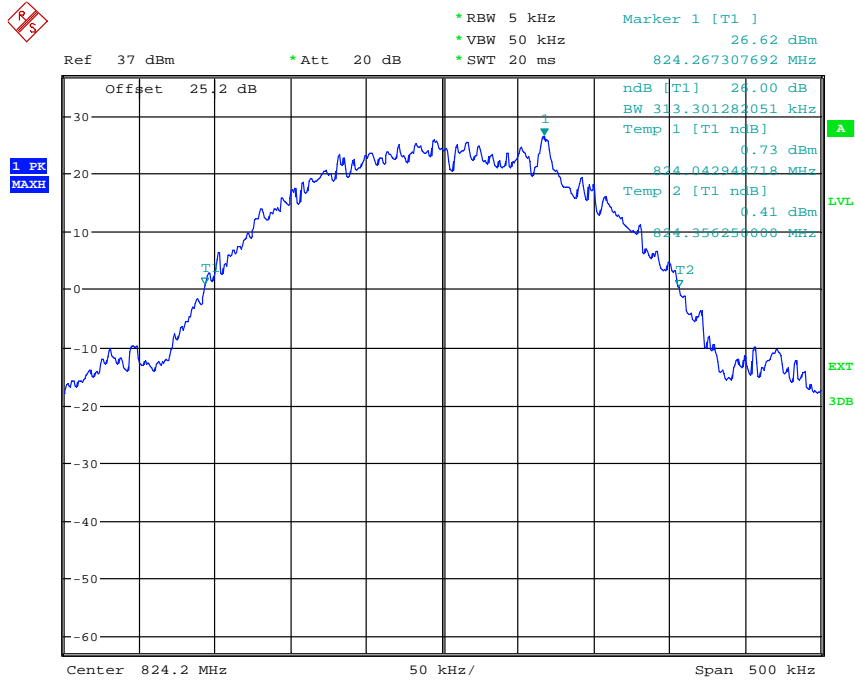

### 99% Occupied Bandwidth, Middle Channel

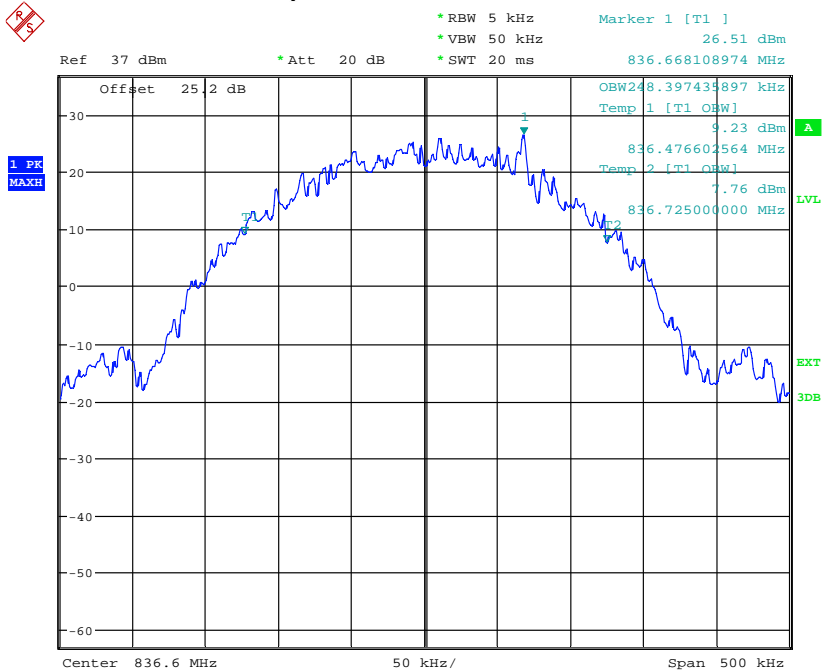

### 26 dB Occupied Bandwidth, Middle Channel

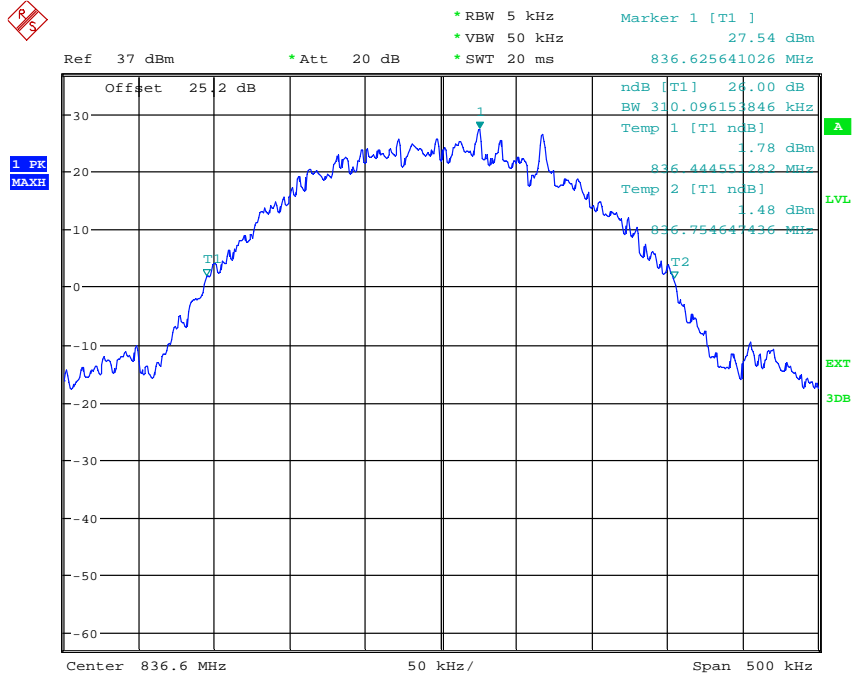

### 99% Occupied Bandwidth, High Channel

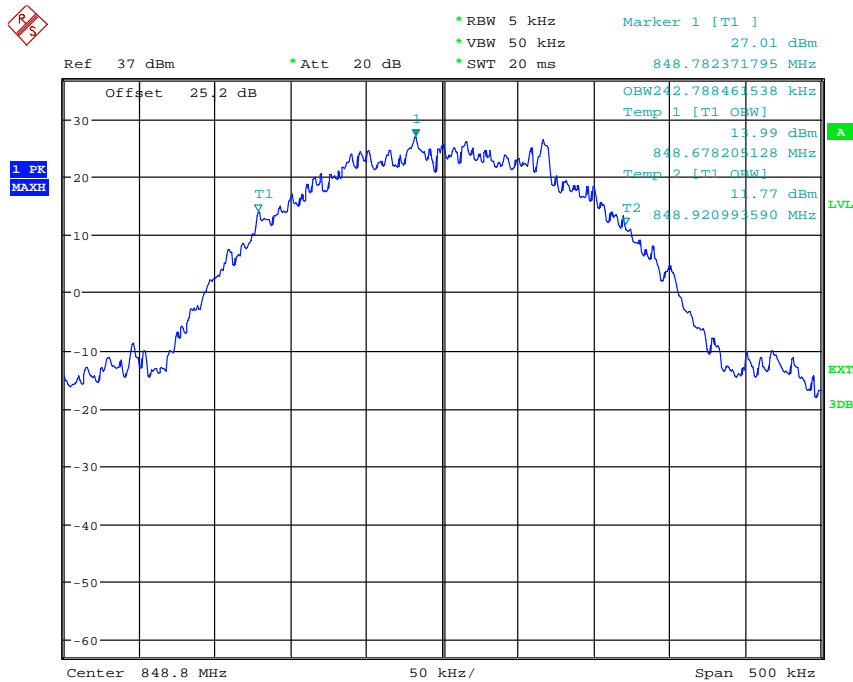

### 26 dB Occupied Bandwidth, High Channel

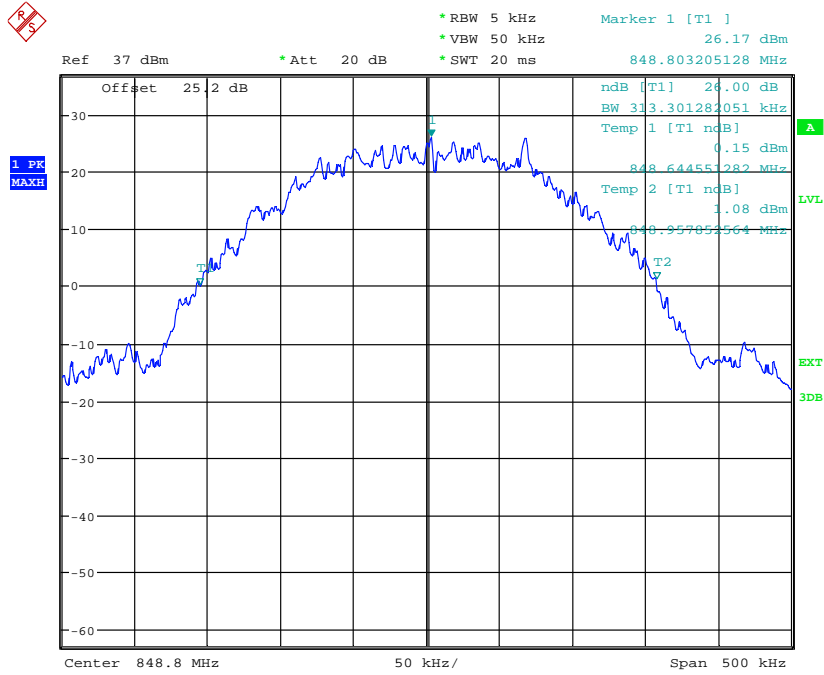

### PCS Band (Part 24E)

### 99% Occupied Bandwidth, Low Channel

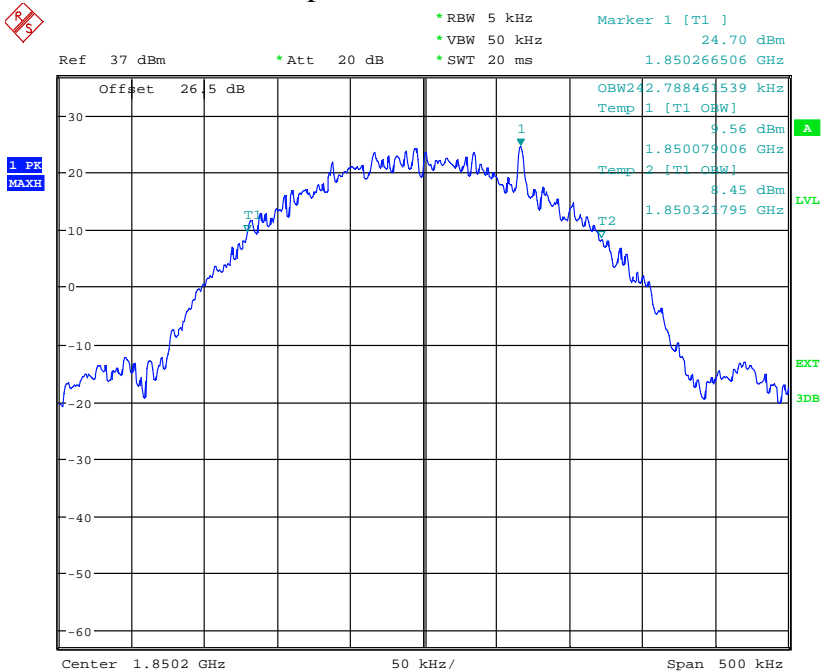

### 26 dB Occupied Bandwidth, Low Channel

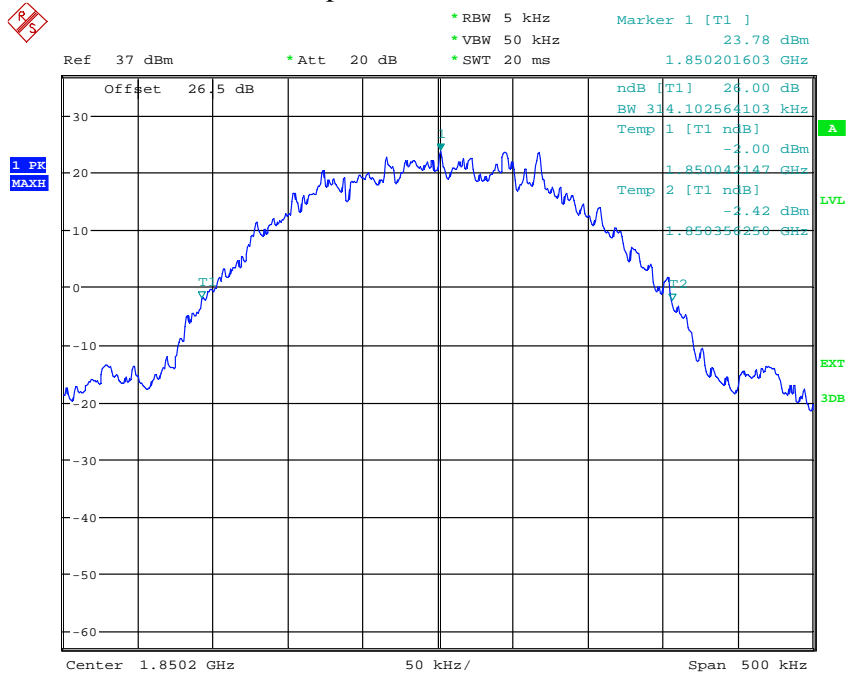

### 99% Occupied Bandwidth, Middle Channel

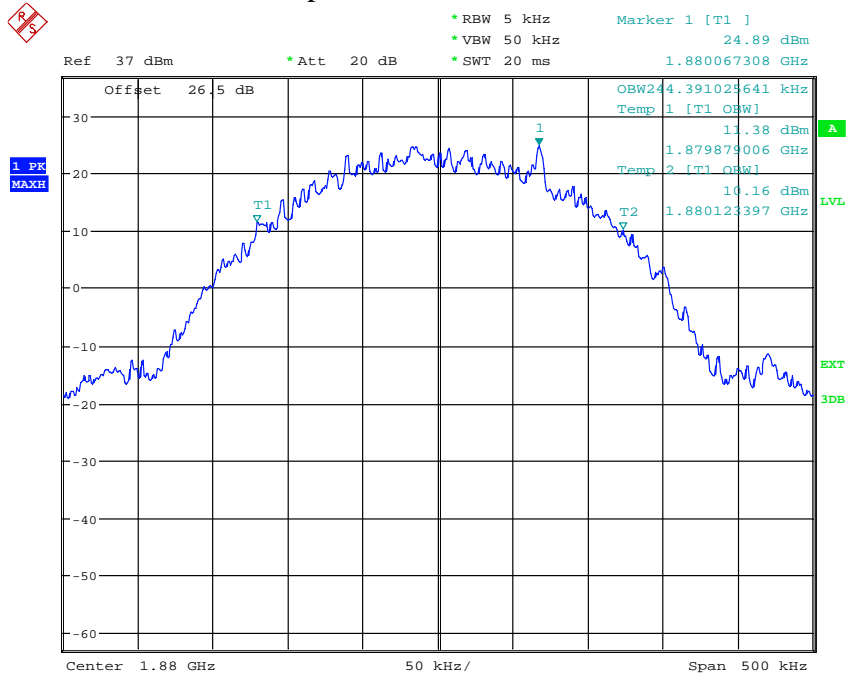

### 26 dB Occupied Bandwidth, Middle Channel

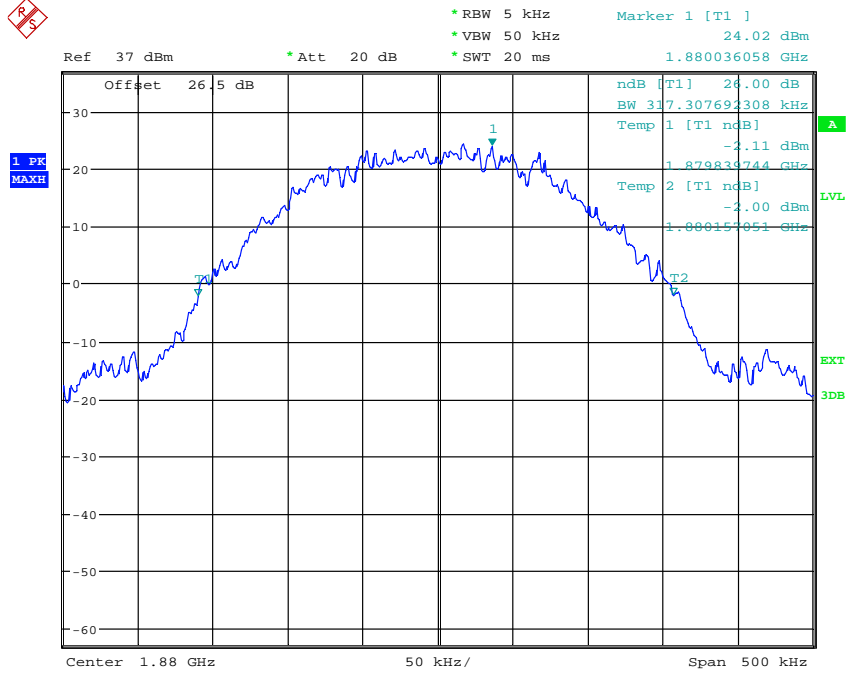

### 99% Occupied Bandwidth, High Channel

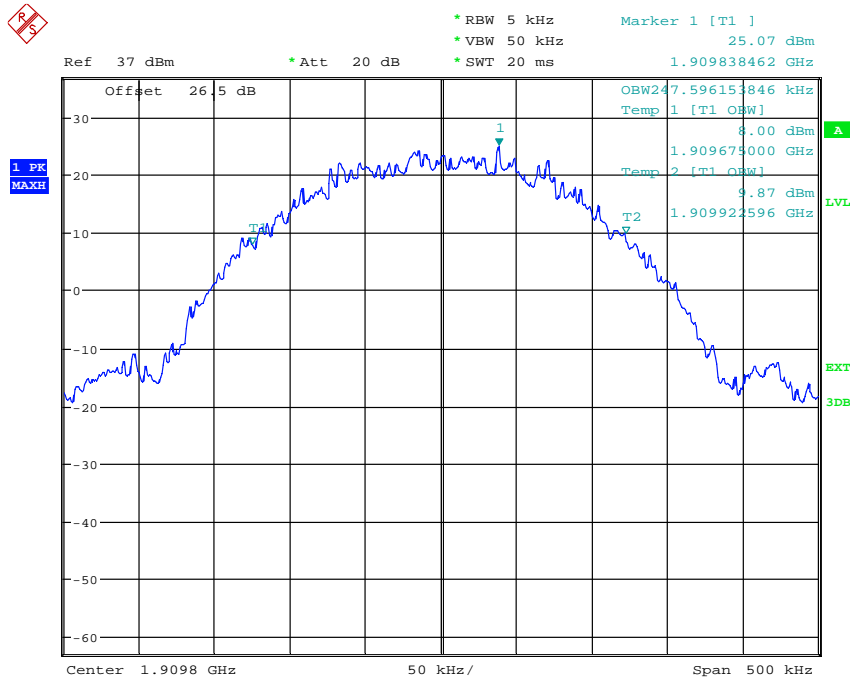

### 26 dB Occupied Bandwidth, High Channel

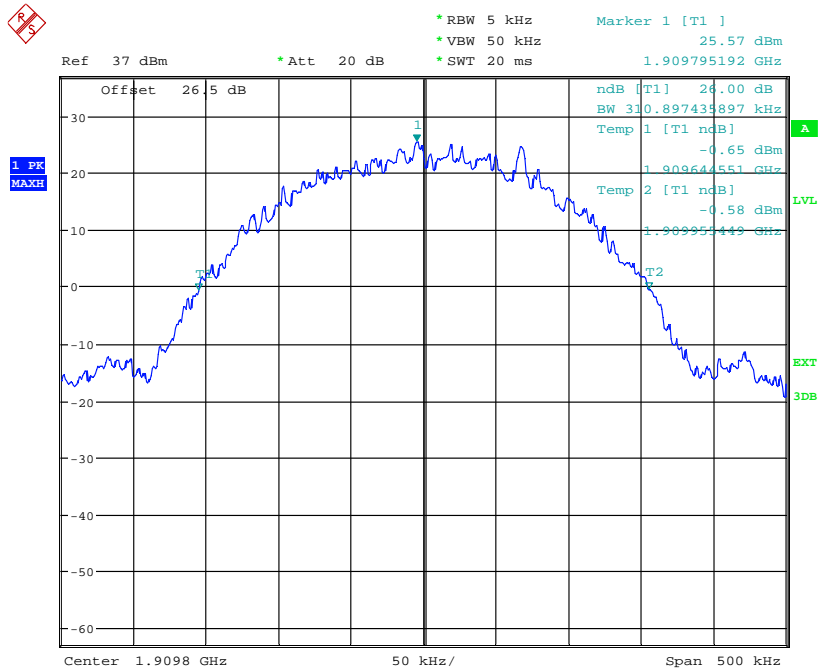

## 7. RF OUTPUT POWER

### 7.1. Block Diagram of Test Setup

Conducted method:

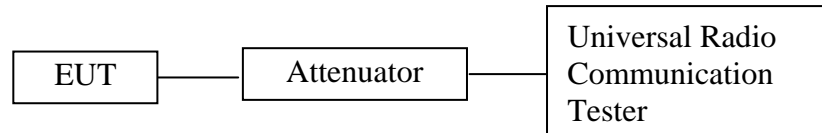

Radiated method:

Frequency range 30MHz – 1000MHz

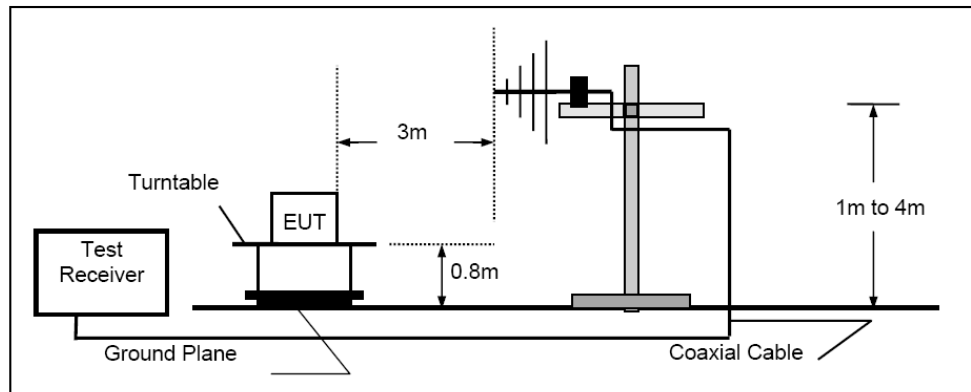

Frequency range above 1GHz-25GHz

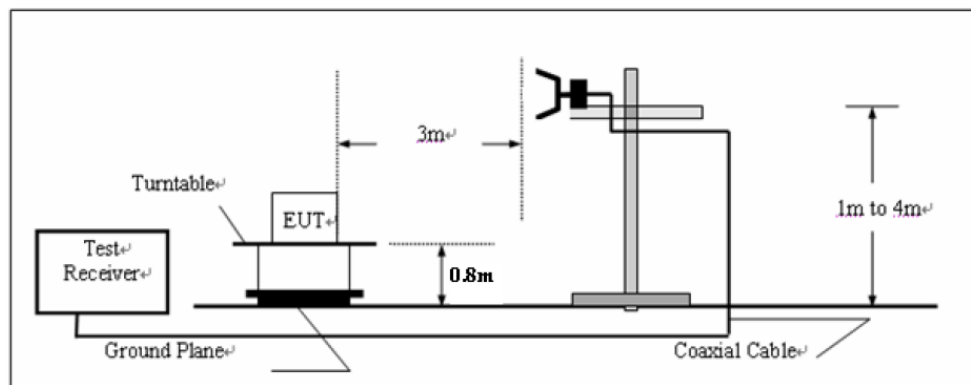

### 7.2. The Requirement For FCC Section §2.1046 and §22.913 (a) & §24.232 (C)

According to FCC §2.1046 and §22.913 (a), the ERP of mobile transmitters and auxiliary test transmitters must not exceed 7 watts.

According to FCC §2.1046 and §24.232 (C), mobile and portable stations are limited to 2 watts EIRP and the equipment must employ a means for limiting power to the minimum necessary for successful communications.

### 7.3. Operating Condition of EUT

7.3.1. Setup the EUT and simulator as shown as Section 7.1.

7.3.2. Turn on the power of all equipment.

7.3.3. Let the EUT work in TX modes measure it. The transmit frequency are 824-849MHz and 1850-1910MHz. We select 824.2MHz, 836.6MHz, 848.8MHz and 1850.2MHz, 1880.0MHz, 1909.8MHz TX frequency to transmit.

### 7.4. Test Procedure

Conducted method:

The RF output of the transmitter was connected to the wireless test set and the spectrum analyzer through sufficient attenuation.

Radiated method(For ERP&EIRP):

1. The transmitter was placed on a wooden turntable, and it was transmitting into a non-radiating load which was also placed on the turntable.
2. The measurement antenna was placed at a distance of 3 meters from the EUT. During the tests, the antenna height and polarization as well as EUT azimuth were varied in order to identify the maximum level of emissions from the EUT. The test was performed by placing the EUT on 3-orthogonal axis.
3. The frequency range up to tenth harmonic of the fundamental frequency was investigated.
4. Remove the EUT and replace it with substitution antenna. A signal generator was connected to the substitution antenna by a non-radiating cable. The absolute levels of the spurious emissions were measured by the substitution.



### 7.5. Test Result

#### Cellular Band (Part 22H)

Mode	Channel	Frequency (MHz)	Output Power (dBm)
GSM	128	824.2	32.07
	190	836.6	32.04
	251	848.8	32.12

Mode	Channel No	Frequency (MHz)	Output Power (dBm)			
			1 slot	2 slots	3 slots	4 slots
GPRS	128	824.2	31.57	31.08	28.65	27.24
	190	836.6	31.68	31.00	28.78	27.14
	251	848.8	31.38	31.14	28.69	27.35

#### PCS Band (Part 24E)

Mode	Channel	Frequency (MHz)	Output Power (dBm)
GSM	512	1850.2	29.27
	661	1880.0	29.33
	810	1909.8	29.37

Mode	Channel No	Frequency (MHz)	Output Power (dBm)			
			1 slot	2 slots	3 slots	4 slots
GPRS	512	1850.2	29.17	28.14	26.35	24.67
	661	1880.0	29.24	28.17	26.38	24.89
	810	1909.8	29.33	28.25	26.38	24.70

**ERP & EIRP**

ERP for GSM900 (Part 22H)

GSM:

Indicated		Table Angle Degree	Test Antenna		Substituted			Antenna Gain Correction (dBi)	Cable Loss (dB)	Absolute Level (dBm)	Part 22H
Frequency (MHz)	S.A. Reading (dBμV/m)		Height (m)	Polar (H/V)	Frequency (MHz)	S.G. Level (dBm)	Polar (H/V)				Limit (dBm)
Low Channel											
824.2	98.25	142	1.0	V	824.2	31.1	V	0	0.9	30.2	38.45
824.2	84.35	22	1.5	H	824.2	21.2	H	0	0.9	20.3	38.45
Middle Channel											
836.6	99.68	241	1.0	V	836.6	31.4	V	0	0.9	30.5	38.45
836.6	85.54	25	1.5	H	836.6	21.5	H	0	0.9	20.6	38.45
High Channel											
848.8	99.23	246	1.0	V	848.8	31.2	V	0	0.9	30.3	38.45
848.8	86.54	24	1.5	H	848.8	21.7	H	0	0.9	20.8	38.45

GPRS:

Indicated		Table Angle Degree	Test Antenna		Substituted			Antenna Gain Correction (dBi)	Cable Loss (dB)	Absolute Level (dBm)	Part 22H
Frequency (MHz)	S.A. Reading (dBμV/m)		Height (m)	Polar (H/V)	Frequency (MHz)	S.G. Level (dBm)	Polar (H/V)				Limit (dBm)
Low Channel											
824.2	99.21	232	1.0	V	824.2	30.2	V	0	0.9	29.3	38.45
824.2	92.14	177	1.5	H	824.2	20.2	H	0	0.9	19.3	38.45
Middle Channel											
836.6	97.58	235	1.0	V	836.6	30.1	V	0	0.9	29.2	38.45
836.6	91.35	145	1.5	H	836.6	20.7	H	0	0.9	19.8	38.45
High Channel											
848.8	98.53	225	1.0	V	848.8	30.3	V	0	0.9	29.4	38.45
848.8	91.24	157	1.5	H	848.8	20.6	H	0	0.9	19.7	38.45

EIRP for PCS1800 Band (Part 24E)

GSM:

Indicated		Table Angle Degree	Test Antenna		Substituted			Antenna Gain Correction (dBi)	Cable Loss (dB)	Absolute Level (dBm)	Part 24E
Frequency (MHz)	S.A. Reading (dBμV/m)		Height (m)	Polar (H/V)	Frequency (MHz)	S.G. Level (dBm)	Polar (H/V)				Limit (dBm)
Low Channel											
1850.2	92.21	235	1.0	V	1850.2	23.0	V	6.2	1.1	28.1	33
1850.2	85.54	15	1.5	H	1850.2	16.1	H	6.2	1.1	21.2	33
Middle Channel											
1880.0	93.25	257	1.0	V	1880.0	23.5	V	6.2	1.1	28.6	33
1880.0	86.25	22	1.5	H	1880.0	16.0	H	6.2	1.1	21.1	33
High Channel											
1909.8	93.21	234	1.0	V	1909.8	22.7	V	6.2	1.1	27.8	33
1909.8	85.21	24	1.5	H	1909.8	15.7	H	6.2	1.1	20.8	33

GPRS:

Indicated		Table Angle Degree	Test Antenna		Substituted			Antenna Gain Correction (dBi)	Cable Loss (dB)	Absolute Level (dBm)	Part 24E
Frequency (MHz)	S.A. Reading (dBμV/m)		Height (m)	Polar (H/V)	Frequency (MHz)	S.G. Level (dBm)	Polar (H/V)				Limit (dBm)
Low Channel											
1850.2	93.24	311	1.0	V	1850.2	22.7	V	6.2	1.1	27.8	33
1850.2	82.21	210	1.5	H	1850.2	15.0	H	6.2	1.1	20.1	33
Middle Channel											
1880.0	94.24	298	1.0	V	1880.0	22.5	V	6.2	1.1	27.6	33
1880.0	82.55	205	1.5	H	1880.0	15.5	H	6.2	1.1	20.6	33
High Channel											
1909.8	94.24	235	1.0	V	1909.8	22.6	V	6.2	1.1	27.7	33
1909.8	82.14	242	1.5	H	1909.8	15.6	H	6.2	1.1	20.7	33

## 8. SPURIOUS EMISSIONS AT ANTENNA TERMINALS

### 8.1. Block Diagram of Test Setup

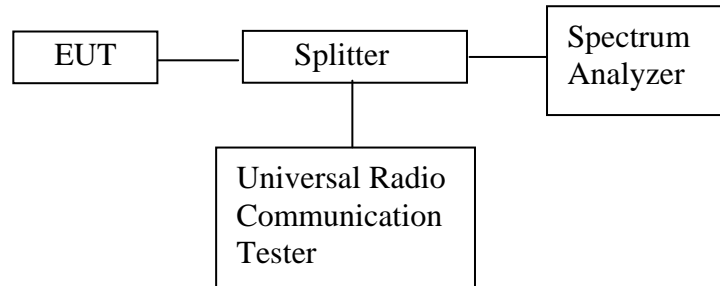

### 8.2. Applicable Standard

FCC §2.1051, §22.917(a) and §24.238(a).

The spectrum was to be investigated to the tenth harmonics of the highest fundamental frequency as specified in §2.1051

### 8.3. EUT Configuration on Measurement

The equipment are installed on the emission Measurement to meet the commission requirements and operating regulations in a manner which tends to maximize its emission characteristics in normal application.

### 8.4. Operating Condition of EUT

8.4.1. Setup the EUT and simulator as shown as Section 8.1.

8.4.2. Turn on the power of all equipment.

8.4.3. Let the EUT work in TX modes measure it. The transmit frequency are 824-849MHz and 1850-1910MHz. We select 836.6MHz and 1880.0MHz, TX frequency to transmit.

### 8.5. Test Procedure

The RF output of the transceiver was connected to a spectrum analyzer and simulator through appropriate attenuation. The resolution bandwidth of the spectrum analyzer was set at 1MHz. Sufficient scans were taken to show any out of band emissions up to 10<sup>th</sup> harmonic.

## 8.6. Test Result

### Cellular Band (Part 22H)

#### 30 – 10000 MHz - Middle Channel

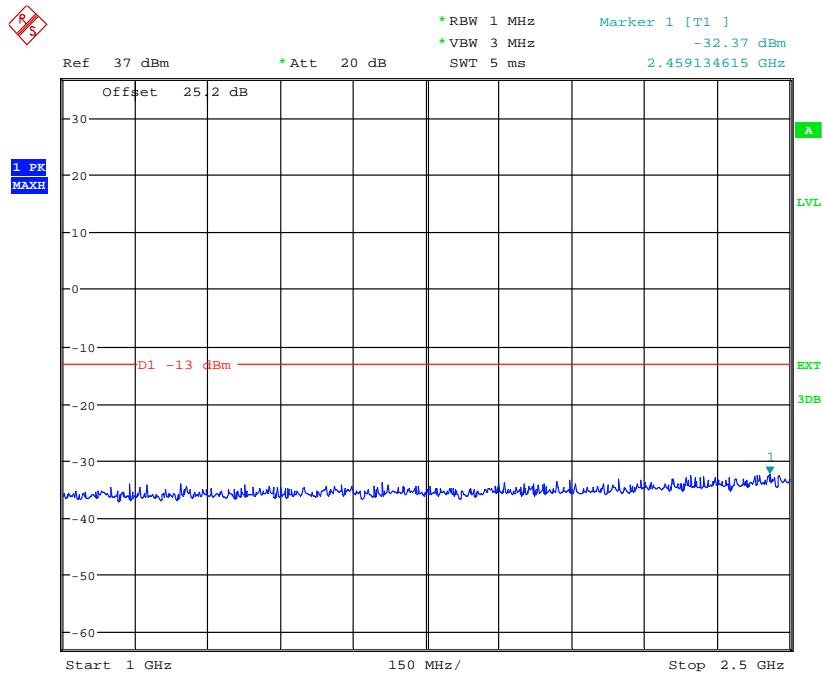
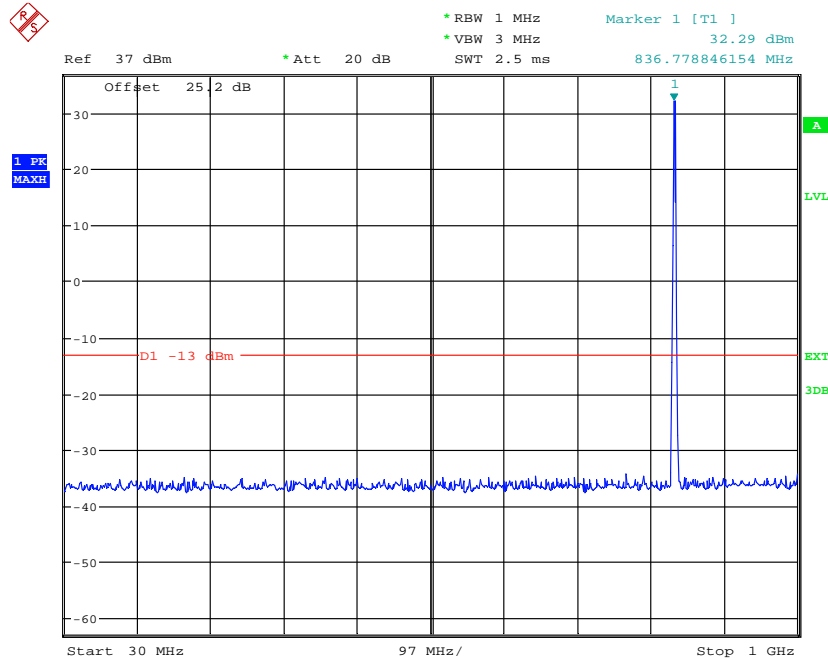

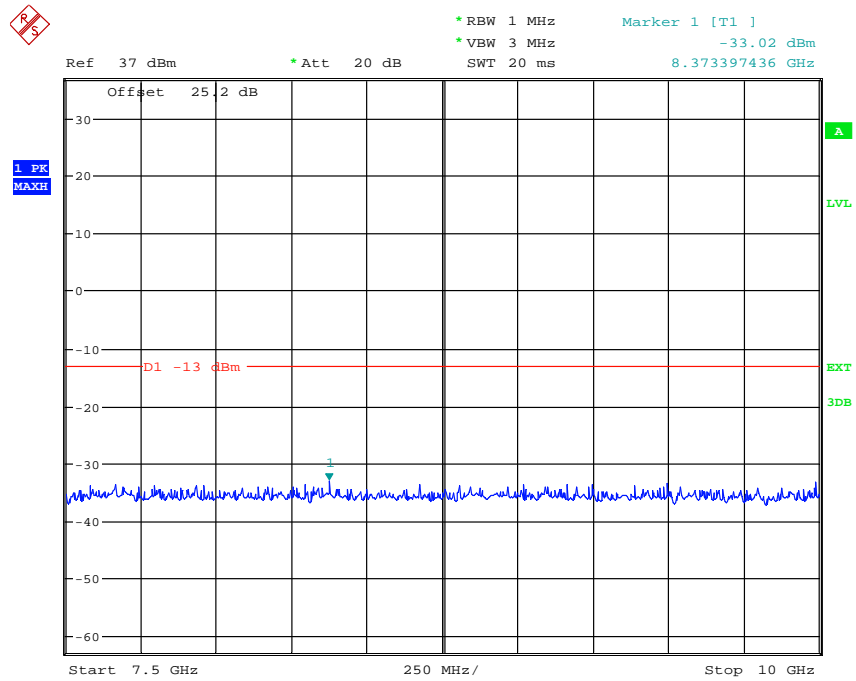
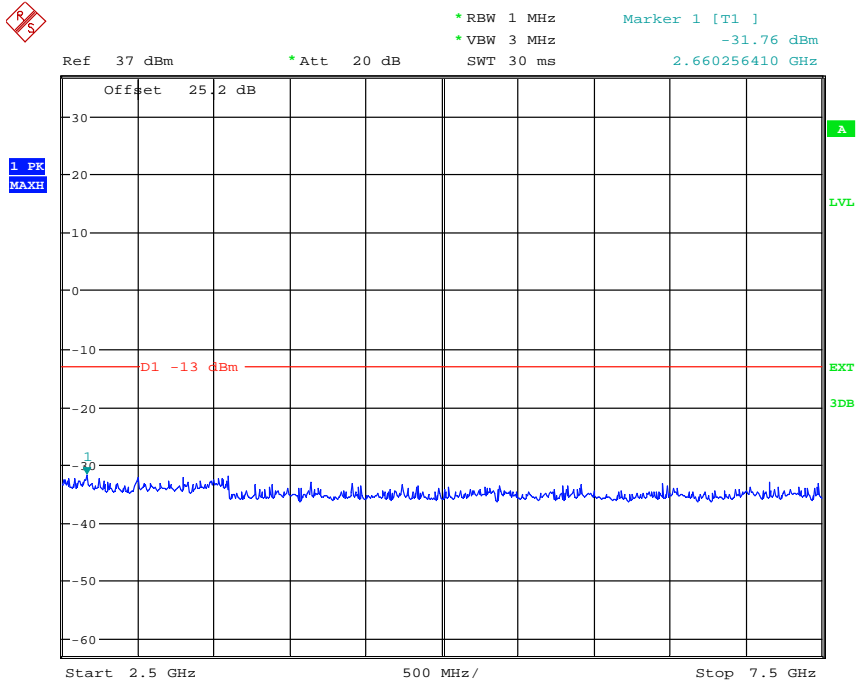

PCS Band (Part24E)

30 – 20000 MHz - Middle Channel

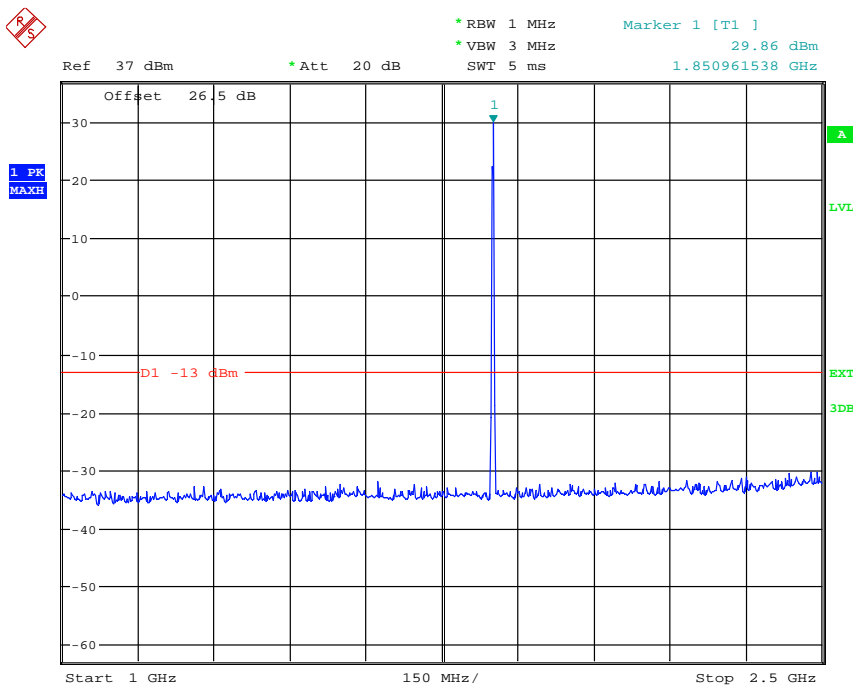
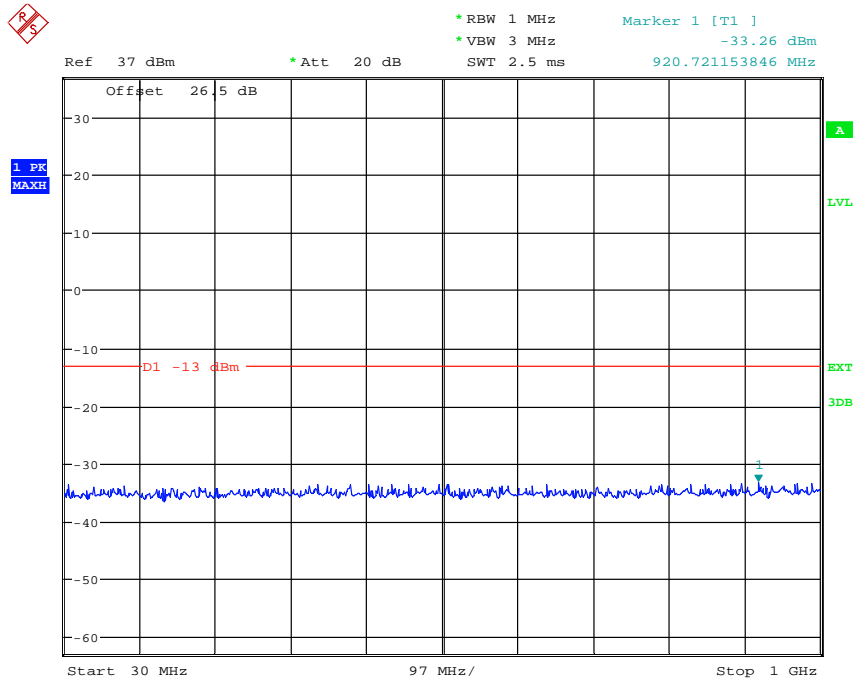

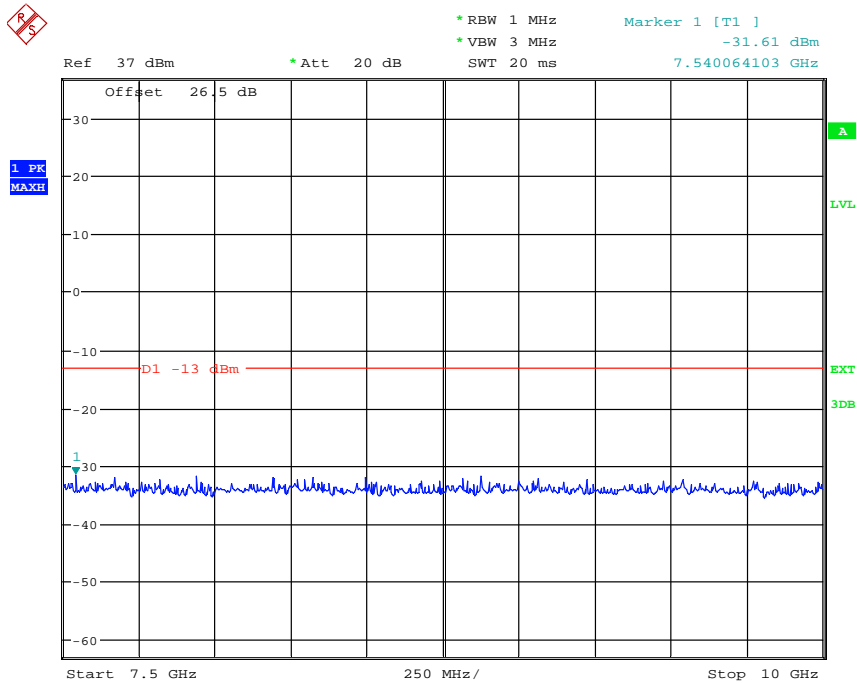
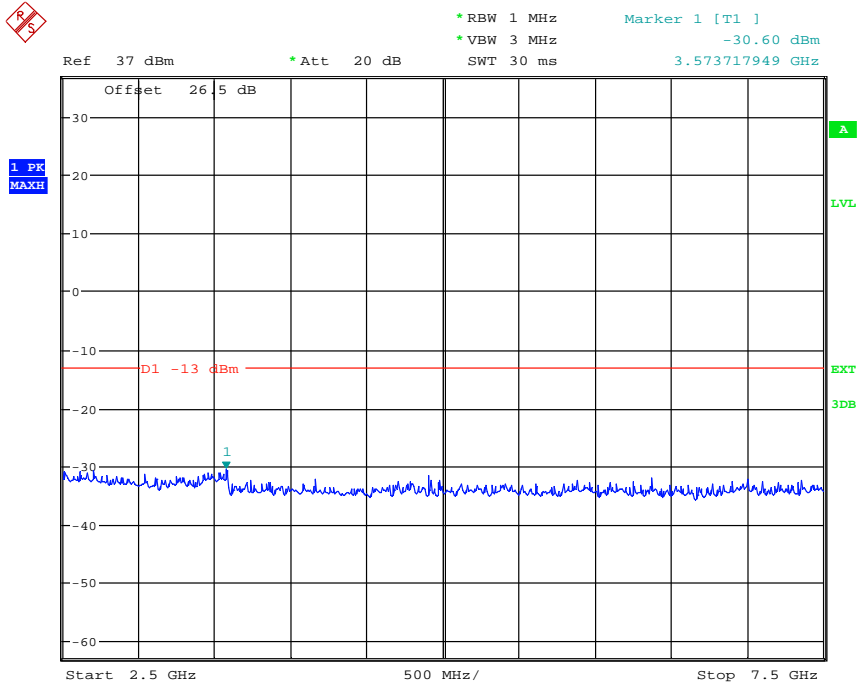



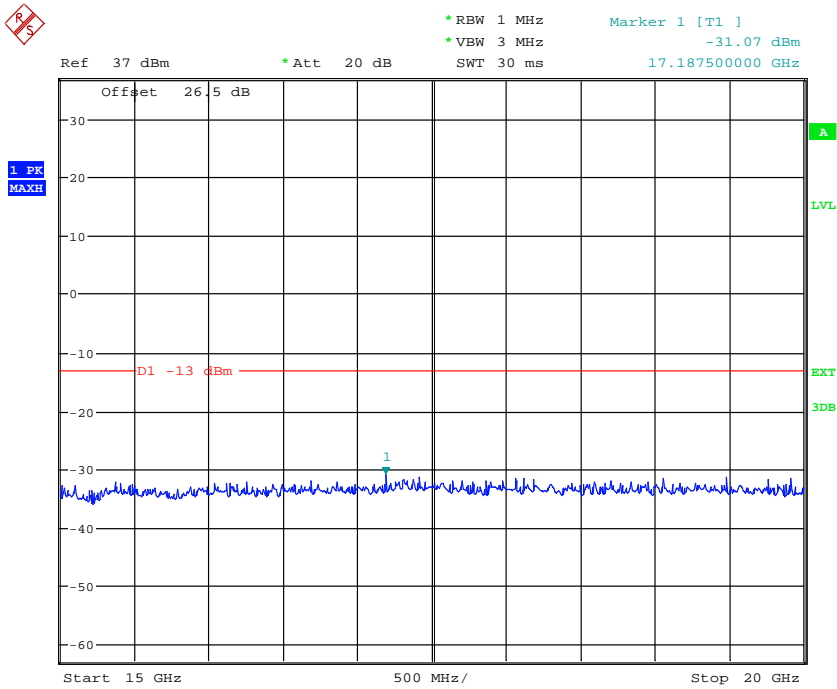
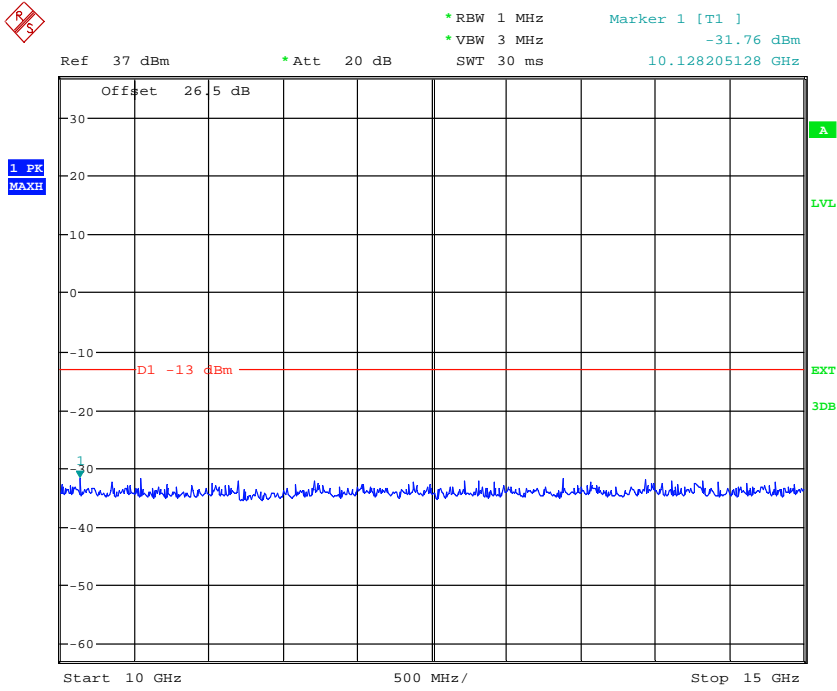

## 9. BAND EDGE TEST

### 9.1. Block Diagram of Test Setup

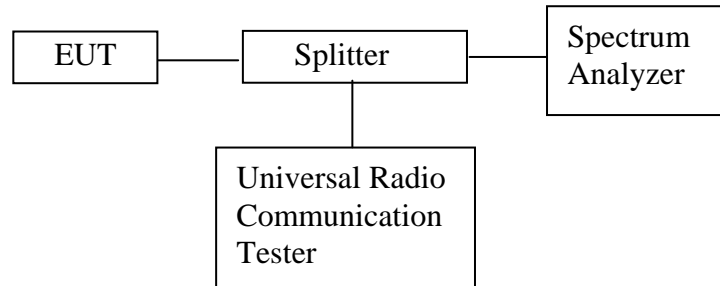

### 9.2. The Requirement For Section § 22.917(a), §24.238(a)

According to § 22.917(a), the power of any emissions outside of the authorized operating frequency ranges must be attenuated below the transmitting power (P) by a factor of at least  $43 + 10 \log(P)$  dB.

According to §24.238(a), the power of any emissions outside of the authorized operating frequency ranges must be attenuated below the transmitting power (P) by a factor of at least  $43 + 10 \log(P)$  dB.

### 9.3. Operating Condition of EUT

9.3.1. Setup the EUT and simulator as shown as Section 9.1.

9.3.2. Turn on the power of all equipment.

9.3.3. Let the EUT work in TX modes measure it. The transmit frequency are 823.980, 849.020 MHz, 1849.996MHz and 1910.016MHz.

### 9.4. Test Procedure

Conducted Band Edge:

The RF output of the transmitter was connected to the input of the spectrum analyzer through sufficient attenuation.

The center of the spectrum analyzer was set to block edge frequency, RBW set to 5 kHz, RBW set to 50 kHz.

## 9.5. Test Result

## Cellular Band (Part 22H)

Mode	Frequency (MHz)	Emission (dBm)	Limit (dBm)
GSM850	823.984	-13.89	-13
	849.002	-13.33	-13

## PCS Band (Part 24E)

Mode	Frequency (MHz)	Emission (dBm)	Limit (dBm)
PCS1900	1849.997	-14.06	-13
	1910.002	-13.53	-13

Note: The offset on the picture below =The loss of test cable+Splitter.

### Cellular Band, Low Channel

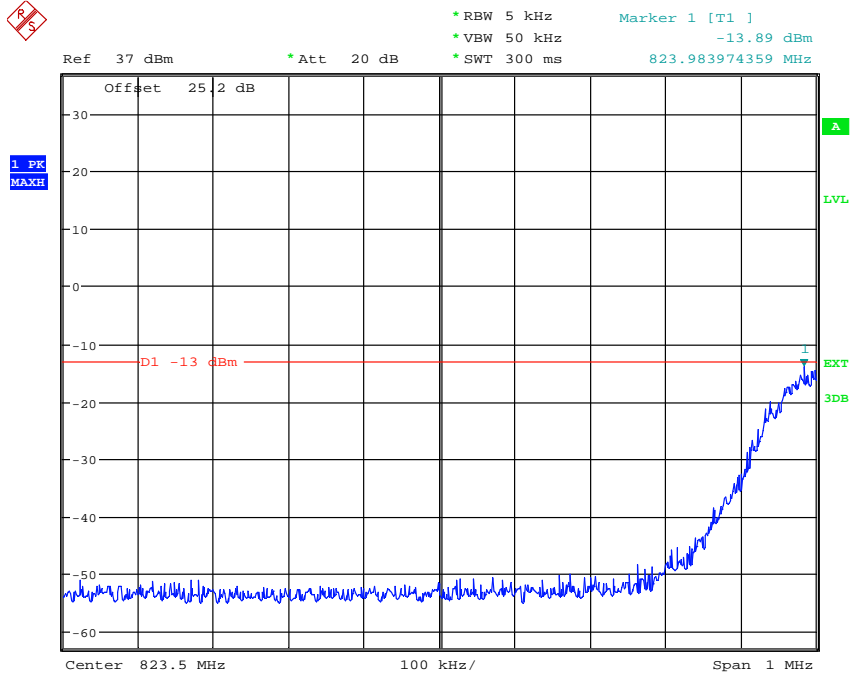

### Cellular Band, High Channel

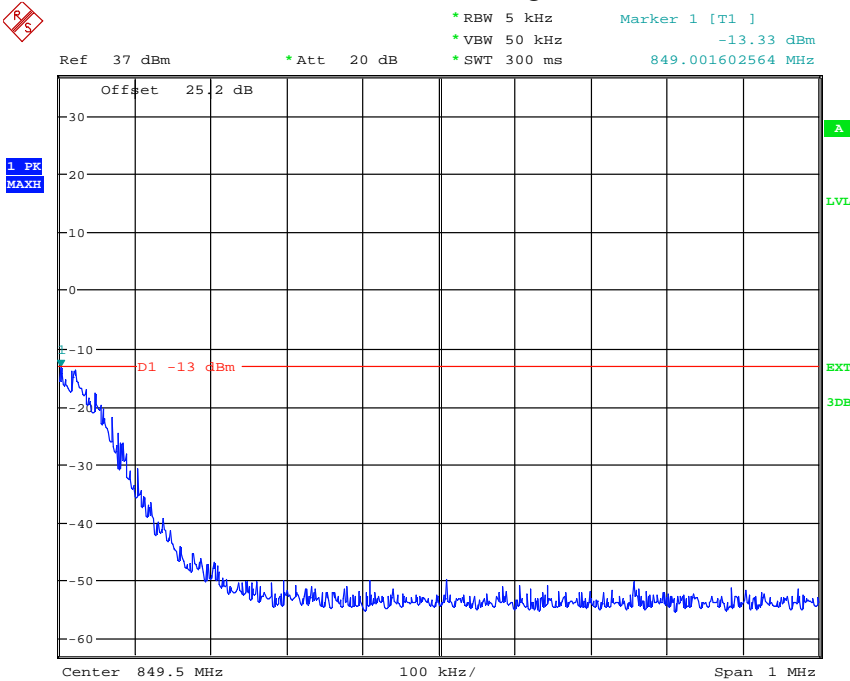

### PCS Band, Lowest Channel

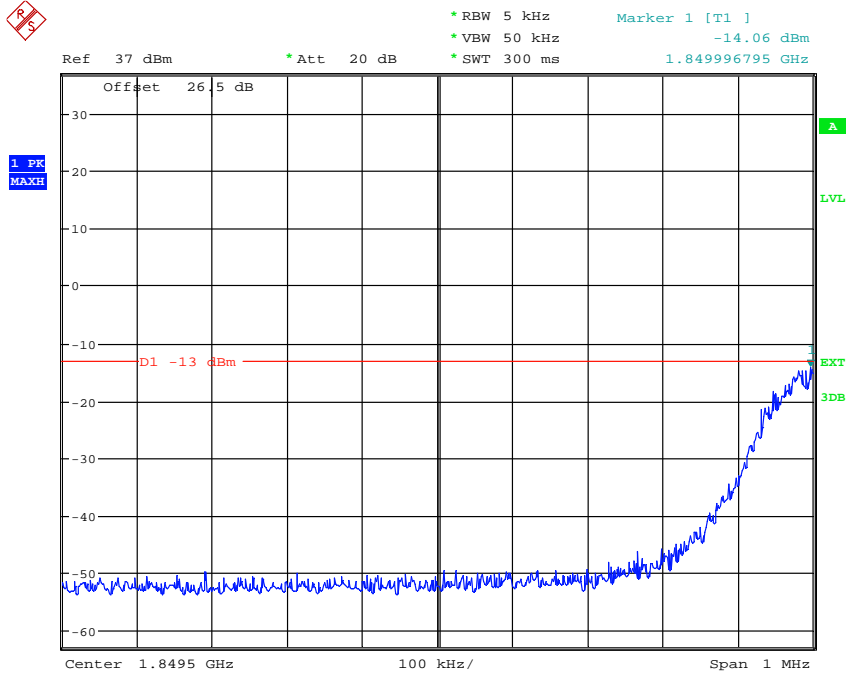

### PCS Band, Highest Channel

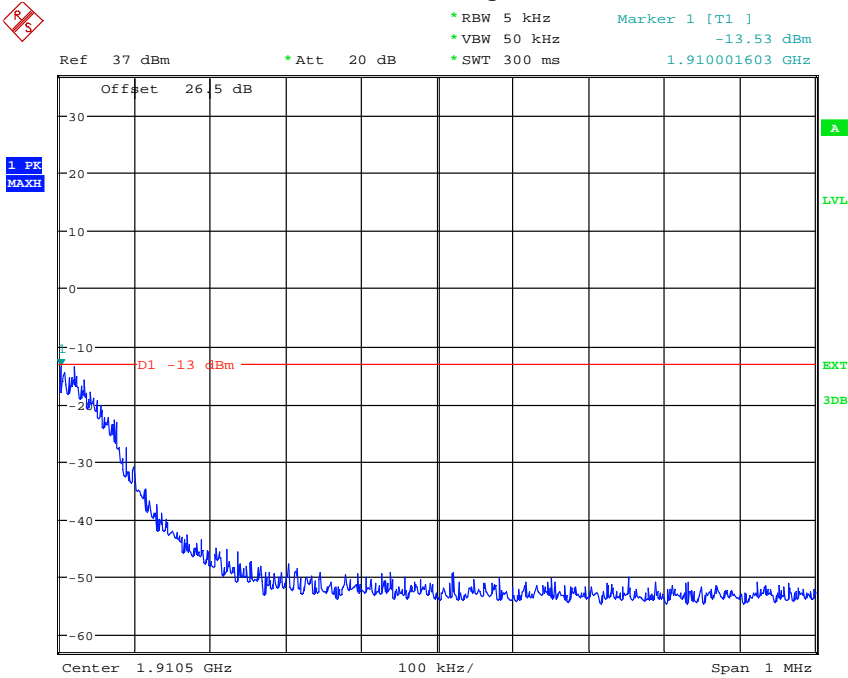

## 10. RADIATED SPURIOUS EMISSION TEST

### 10.1. Block Diagram of Test Setup

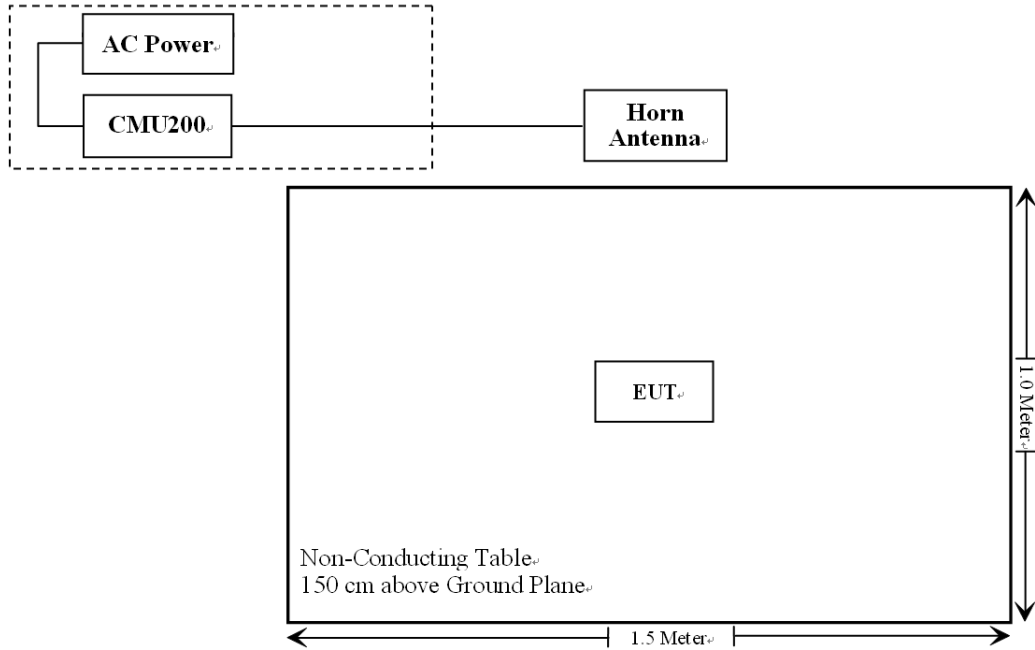

#### 10.1.1. Semi-Anechoic Chamber Test Setup Diagram

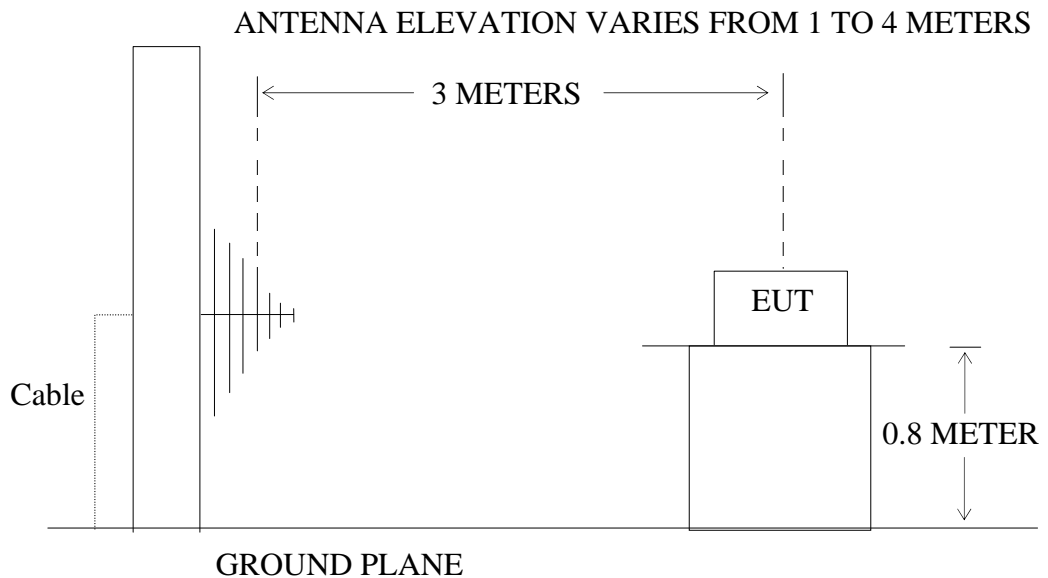

### 10.2. Applicable Standard

FCC §2.1053, §22.917 and §24.238

### 10.3.Restricted bands of operation

#### 10.3.1.FCC Part 15.205 Restricted bands of operation

(a) Except as shown in paragraph (d) of this section, Only spurious emissions are permitted in any of the frequency bands listed below:

MHz	MHz	MHz	GHz
0.090-0.110	16.42-16.423	399.9-410	4.5-5.15
<sup>1</sup> 0.495-0.505	16.69475-16.69525	608-614	5.35-5.46
2.1735-2.1905	16.80425-16.80475	960-1240	7.25-7.75
4.125-4.128	25.5-25.67	1300-1427	8.025-8.5
4.17725-4.17775	37.5-38.25	1435-1626.5	9.0-9.2
4.20725-4.20775	73-74.6	1645.5-1646.5	9.3-9.5
6.215-6.218	74.8-75.2	1660-1710	10.6-12.7
6.26775-6.26825	108-121.94	1718.8-1722.2	13.25-13.4
6.31175-6.31225	123-138	2200-2300	14.47-14.5
8.291-8.294	149.9-150.05	2310-2390	15.35-16.2
8.362-8.366	156.52475-156.52525	2483.5-2500	17.7-21.4
8.37625-8.38675	156.7-156.9	2690-2900	22.01-23.12
8.41425-8.41475	162.0125-167.17	3260-3267	23.6-24.0
12.29-12.293	167.72-173.2	3332-3339	31.2-31.8
12.51975-12.52025	240-285	3345.8-3358	36.43-36.5
12.57675-12.57725	322-335.4	3600-4400	( <sup>2</sup> )
13.36-13.41			

<sup>1</sup>Until February 1, 1999, this restricted band shall be 0.490-0.510

<sup>2</sup>Above 38.6

(b) Except as provided in paragraphs (d) and (e), the field strength of emission appearing within these frequency bands shall not exceed the limits shown in Section 15.209. At frequencies equal to or less than 1000MHz, Compliance with the limits in Section 15.209 shall be demonstrated using measurement instrumentation employing a CISPR quasi-peak detector. Above 1000MHz, compliance with the emission limits in Section 15.209 shall be demonstrated based on the average value of the measured emissions. The provisions in Section 15.35 apply to these measurements.

### 10.4.Configuration of EUT on Measurement

The equipment is installed on Radiated Emission Measurement to meet the commission requirements and operating regulations in a manner which tends to maximize its emission characteristics in normal application.

### 10.5.Operating Condition of EUT

10.5.1.Setup the EUT and simulator as shown as Section 10.1.

10.5.2. Turn on the power of all equipment.

10.5.3. Let the EUT work in TX modes measure it. The transmit frequency are 824-849MHz and 1850-1910MHz. We select 824.2MHz, 836.6MHz, 848.8MHz and 1850.2MHz, 1880.0MHz, 1909.8MHz TX frequency to transmit.

## 10.6. Test Procedure

The EUT and its simulators are placed on a turntable, which is 0.8 meter high above ground. The turntable can rotate 360 degrees to determine the position of the maximum emission level. EUT is set 3.0 meters away from the receiving antenna, which is mounted on an antenna tower. The antenna can be moved up and down between 1.0 meter and 4 meters to find out the maximum emission level. Broadband antenna (calibrated bilog antenna) is used as receiving antenna. Both horizontal and vertical polarizations of the antenna are set on measurement. In order to find the maximum emission levels, all of the interface cables must be manipulated according to TIA 603-D on radiated emission measurement. The EUT was tested in 3 orthogonal planes.

Remove the EUT and replace it with substitution antenna. A signal generator was connected to the substitution antenna by a non-radiating cable. The absolute levels of the spurious emissions were measured by the substitution.

Sample Calculation:

EUT Field Strength (dBm) = Reading(Signal generator) + Antenna Gain(substitution antenna) - Cable loss(From signal Generator to substitution antenna)

The bandwidth of test receiver is set at 9kHz in below 30MHz. and set at 120kHz in 30-1000MHz, and 1MHz in above 1000MHz.

The frequency range from 9KHz to 20GHz is checked.

The final measurement in band 9-90KHz, 110-490kHz and above 1000MHz is performed with Average detector. Except those frequency bands mention above, the final measurement for frequencies below 1000MHz is performed with Quasi Peak detector.

Spurious emissions in dB =  $10 \lg(\text{TXpwr in Watts}/0.001)$  – the absolute level

Spurious attenuation limit in dB =  $43 + 10 \log_{10}(\text{power out in Watts})$

## 10.7. The Field Strength of Radiation Emission Measurement Results

**PASS**

Note: 1. Emissions attenuated more than 20 dB below the permissible value are not reported.

2. The EUT is tested radiation emission at each test mode in three axes. The worst emissions are reported in all test mode and channels.

3. Absolute Level = SG Level - Cable loss + Antenna Gain  
Margin = Limit - Absolute Level



Cellular Band (GSM850)

Indicated		Table Angle Degree	Test Antenna		Substituted				Absolute Level (dBm)	Limit (dBm)	Margin (dB)
Frequency (MHz)	S.A. Reading (dBμV/m)		Height (m)	Polar (H/V)	Frequency (MHz)	Level (dBm)	Ant. Gain (dBi)	Cable Loss (dB)			
Low Channel(824.2MHz)											
1648.4	53.71	124	1.0	V	1648.2	-48.5	9.4	0.95	-40.01	-13	27.01
1648.4	44.98	123	1.5	H	1648.2	-58.7	9.4	0.95	-50.21	-13	37.21
3296.8	44.56	241	1.5	V	3296.8	-48.4	10.1	2.08	-40.34	-13	27.34
3296.8	41.01	12	1.5	H	3296.8	-52.9	10.1	2.08	-44.84	-13	31.84
Middle Channel (836.6MHz)											
1673.2	54.28	224	1.5	V	1673.2	-47.9	9.4	0.98	-39.44	-13	26.44
1673.2	45.55	23	1.5	H	1673.2	-58.1	9.4	0.98	-49.64	-13	36.64
3346.4	45.13	24	1.0	V	3346.4	-48.5	10.2	2.10	-40.36	-13	27.36
3346.4	41.58	144	1.5	H	3346.4	-53.0	10.2	2.10	-44.86	-13	31.86
High Channel(848.8MHz)											
1697.6	52.44	22	1.0	V	1697.6	-49.8	9.4	1.00	-41.36	-13	28.36
1697.6	43.71	147	1.5	H	1697.6	-60.0	9.4	1.00	-51.56	-13	38.56
3395.2	43.29	25	1.0	V	3395.2	-50.4	10.2	2.10	-42.26	-13	29.26
3395.2	39.74	251	1.5	H	3395.2	-54.9	10.2	2.10	-46.76	-13	33.76

PCS Band (GSM1900)

Indicated		Table Angle Degree	Test Antenna		Substituted				Absolute Level (dBm)	Limit (dBm)	Margin (dB)
Frequency (MHz)	S.A. Reading (dBμV/m)		Height (m)	Polar (H/V)	Frequency (MHz)	Level (dBm)	Ant. Gain (dBi)	Cable Loss (dB)			
Low Channel(1850.2MHz)											
3700.4	50.15	210	1.5	V	3700.4	-45.5	10.3	2.58	-37.74	-13	24.74
3700.4	46.27	147	1.5	H	3700.4	-51.1	10.3	2.58	-43.34	-13	30.34
5550.6	38.57	253	1.0	V	5550.6	-52.7	11.6	3.93	-44.99	-13	31.99
5550.6	38.17	114	1.5	H	5550.6	-53.6	11.6	3.93	-45.89	-13	32.89
Middle Channel(1880.0MHz)											
3760	50.25	252	1.5	V	3760	-45.9	10.3	2.59	-38.22	-13	25.22
3760	45.35	250	2.0	H	3760	-51.5	10.3	2.59	-43.82	-13	30.82
5640	37.75	32	1.5	V	5640	-53.2	11.7	3.94	-45.47	-13	32.47
5640	38.27	211	1.5	H	5640	-54.1	11.7	3.94	-46.37	-13	33.37
High Channel(1909.8MHz)											
3819.6	49.52	253	1.0	V	3819.6	-47.3	10.4	2.60	-39.50	-13	26.50
3819.6	44.25	27	1.5	H	3819.6	-52.9	10.4	2.60	-45.10	-13	32.10
5729.4	36.74	257	1.0	V	5729.4	-54.5	11.8	3.95	-46.65	-13	33.65
5729.4	36.53	122	1.5	H	5729.4	-55.4	11.8	3.95	-47.55	-13	34.55

## 11.FREQUENCY STABILITY

### 11.1.Block Diagram of Test Setup

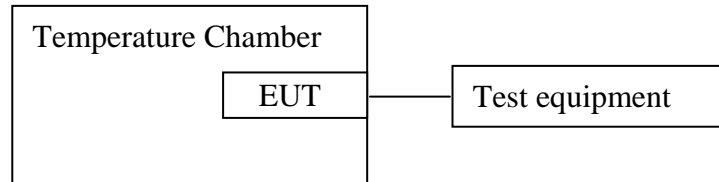

### 11.2.The Requirement For Section CFR47 § 2.1055 (a), § 2.1055 (d), §22.355, §24.235

According to §22.355, the carrier frequency of each transmitter in the Public Mobile Services must be maintained within the tolerances given in Table below:  
Frequency Tolerance for Transmitters in the Public Mobile Services

Frequency Range (MHz)	Base, fixed (ppm)	Mobile ≤ 3 watts (ppm)	Mobile ≤ 3 watts (ppm)
25 to 50	20.0	20.0	50.0
50 to 450	5.0	5.0	50.0
450 to 512	2.5	5.0	5.0
821 to 896	1.5	2.5	2.5
928 to 929.	5.0	N/A	N/A
929 to 960.	1.5	N/A	N/A
2110 to 2220	10.0	N/A	N/A

According to §24.235, the frequency stability shall be sufficient to ensure that the fundamental emissions stays within the authorized frequency block.

### 11.3.Operating Condition of EUT

11.3.1.Setup the EUT and simulator as shown as Section 11.1.

11.3.2.Turn on the power of all equipment.

11.3.3.Let the EUT work in Test modes measure it. The test frequency are 836.6MHz and 1880MHz.

### 11.4.Test Procedure

Frequency Stability vs. Temperature: The equipment under test was connected to an external DC power supply and the RF output was connected to communication test set

via feed-through attenuators. The EUT was placed inside the temperature chamber. The DC leads and RF output cable exited the chamber through an opening made for the purpose.

After the temperature stabilized for approximately 20 minutes, the frequency output was recorded from the communication test set.

Frequency Stability vs. Voltage: An external variable DC power supply was connected to the battery terminals of the equipment under test. The voltage was set to 115% of the nominal value and was then decreased until the transmitter light no longer illuminated; i.e., the battery end point. The output frequency was recorded for each battery voltage.

### 11.5. Test Result

**Pass.**

#### Cellular Band (Part 22H)

Middle Channel, fo = 836.6 MHz				
Temperature (OC)	Power Supplied (VDC)	Frequency Error (Hz)	Frequency Error (ppm)	Limit (ppm)
-30	3.7	24	0.029	2.5
-20		22	0.026	2.5
-10		34	0.041	2.5
0		24	0.029	2.5
10		12	0.014	2.5
20		22	0.026	2.5
30		17	0.020	2.5
40		28	0.033	2.5
50		32	0.038	2.5
25	3.5	12	0.014	2.5
	4.2	11	0.013	2.5

#### PCS Band (Part 24E)

Middle Channel, fo = 1880 MHz				
Temperature (OC)	Power Supplied (VDC)	Frequency Error (Hz)	Frequency Error (ppm)	Limit (ppm)
-30	3.7	21	0.011	2.5
-20		25	0.013	2.5
-10		23	0.012	2.5
0		17	0.009	2.5
10		18	0.010	2.5
20		23	0.012	2.5
30		22	0.012	2.5
40		32	0.017	2.5
50		31	0.016	2.5
25	3.5	24	0.013	2.5
	4.2	31	0.016	2.5

## 12. ANTENNA REQUIREMENT

### 12.1. The Requirement

According to Section 15.203, an intentional radiator shall be designed to ensure that no antenna other than that furnished by the responsible party shall be used with the device.

### 12.2. Antenna Construction

Device is equipped with Ceramic antenna, which isn't displaced by other antenna. Therefore, the equipment complies with the antenna requirement of Section 15.203.

