

# V7S User Manual

**Ver:001**



Amendment Records









Product name	Version number	Person in charge	Establish/amend date	Reason for change	The major change contents
V7S	001	Nancy	2024- 8-15	N/A	NEW

Note:

1. Please fill the form if there is any update.
2. For the first time saving the file, note “N/A” in the “reason for change” and “major change contents” line.

## Safety maintenance:

Please maintain your system properly to make sure its service life and reduce the damage risk.

-  It should avoid the humidity and extreme temperature when being used.
-  Avoid prolonged exposure of the unit to direct sunlight or strong ultraviolet light.
-  Do not drop the unit or let it be in any place with severe shock /vibration.
-  Please avoid the collision as the LCD screen is very easy to be scratched. Do not use any sharp object to touch the screen.
-  To clean the outside fuselage, please turn off the power, unplug the power cord, scrub / wipe with slightly damp soft cloth. When cleaning the screen, please wipe with the lint free soft cloth.
-  Never attempt to disassemble or repair the machine, otherwise the unit may be damaged.
-  Do not place your unit or accessories together with other flammable liquids, gases, or other explosive materials, to avoid danger.
-  Please unplug the power plug and remove the built-in battery if long-term no-use, or thunder weather.

# Contents

1. Product Description
  - 1.1 Brief Introduction
  - 1.2 Optional Functions
  - 1.3 Basic Parameters
2. Structure Function Explanation
  - 2.1 Interface
3. Extended Cable Definition
  - 3.1 Definition
  - 3.2 Serial Port
  - 3.3 CAN test interface
4. Micro SIM Card & Memory Card Instructions
5. Basic Operation
  - 5.1 Click and Slide
  - 5.2 Long-press and Drag
  - 5.3 Install APK
  - 5.4 Delete
- 6.MENU
  - 6.1 Icon Bar
  - 6.2 Menu Setting
7. Accessories
  - 7.1 Standard accessories
  - 7.2 Optional accessories
8. Update firmware
  - 8.1 Supported host OS
  - 8.2 Install RK USB Driver
  - 8.3 Connect Device
  - 8.4.Flash update.img
9. Trouble Shooting

## 1. Product Description

### 1.1 Brief Introduction

- Android 11 operating system
- 7-inch 1024x600 TFT-LCD screen
- WiFi, 1000Mbps Ethernet port and 4G high speed internet surfing
- Built-in high-sensitivity receiving module and active GPS antenna
- 2MP front camera
- With USB DEVICE and USB HOST
- Support 128GB TF card storage
- Touch button + virtual button
- Double track earphone port, built-in 2W left and right speaker, with microphone input
- RS232 port
- Compliant with IP65 standard
- Support VESA 75MM\*75MM mounting & RAM 38MM\*30MM

### 1.2 Optional Functions

- 4G Modem Module
- 2000mAh Li-ion battery (built-in)

### 1.3 Specifications

Specifications		Description
Core	Processor	64bit RK3568 Quad-core Cortex-A55, up to 2.0GHz
	Graphic	Mali-G52-2EE, 800MHz
	RAM	2GB(4GB optional) LPDDR4
	ROM	16GB(32GB optional) eMMC
	OS	Android 11
Display	LCD panel	7 inch TFT-LCD, LED backlight
	Resolutions	1024x600
	Brightness	500nits (typical)
	Contrast Ratio	800:1
	View Angle (°)	75/75(L/R), 70/75(U/D)
	Touch panel	G+G multi-touch capacitive touch panel
Wireless	WiFi	IEEE 802.11 b/g/n (optional)
	Bluetooth	Ver 4.0
	Cellular	4G Full Netcom (3G optional)
	Positioning	Integrated GPS+GLONASS+BEIDOU(optional)
	Speaker	Built-in speaker(2W, 8Ω) x 2
	Microphone	Internal microphone
	Camera	2M CMOS (Front)
Multimedia	Video	Video Decode: 4K@60fps H.264&H.265&VP9 Profile0/2 video decode, 1080P multi video decode
	Video	Video Encode: 1080P video encoding for H.264 and H.265
	Audio	MP3, WMA, OGG, APE, FLAC, AAC etc.
	GPO	12V,500mA (Max )/Optional
	G-sensor	optional
	Gyroscope	optional

	Onboard I/O ports	1 x TF card slot(up to 128GB) 1 x SIM card slot 1 x USB 3.0 Host
Extended I/O ports (on pigtail cable)	Cable 1	1 x DC in
		1 x RJ45(10/100/1000 Mbps) (support POE)
		1 x RS422/485
		1 x RS232
		1 x OTG 2.0
	Cable 2	1x DC in
		1 x ACC
		2 x CAN bus(optional)
		1 x AV IN (support NTSC)
		1 x reverse gear trigger
	Function Key	Power, Menu, Volume+, Volume-, Reset
	Power light	LED light
Power Supply	DC In	12V DC (9~36V)
	Battery	3.7V 2000mAh, Lithium-Polymer battery pack
Power consumption	Normal mod	≤ 6W
	Charging mode	≤ 10w
Environment	IP rating	IP65
	Operating Temp.	-20° C ~ 70° C (w/o battery)
		-20° C ~50° C (w/ battery)
Storage Temp.	-20° C ~ 80° C	
Mechanical	Dimensions	200W x138H x 36D mm
	Weight	0.79kg
	mount	75MM*75MM VESA or 38MM*30MM RAM
Accessories	Standard	DC adaptor , Extended Cables
	optional	Sunshade

## 2. Structure Function Explanation

### 2.1 Interface

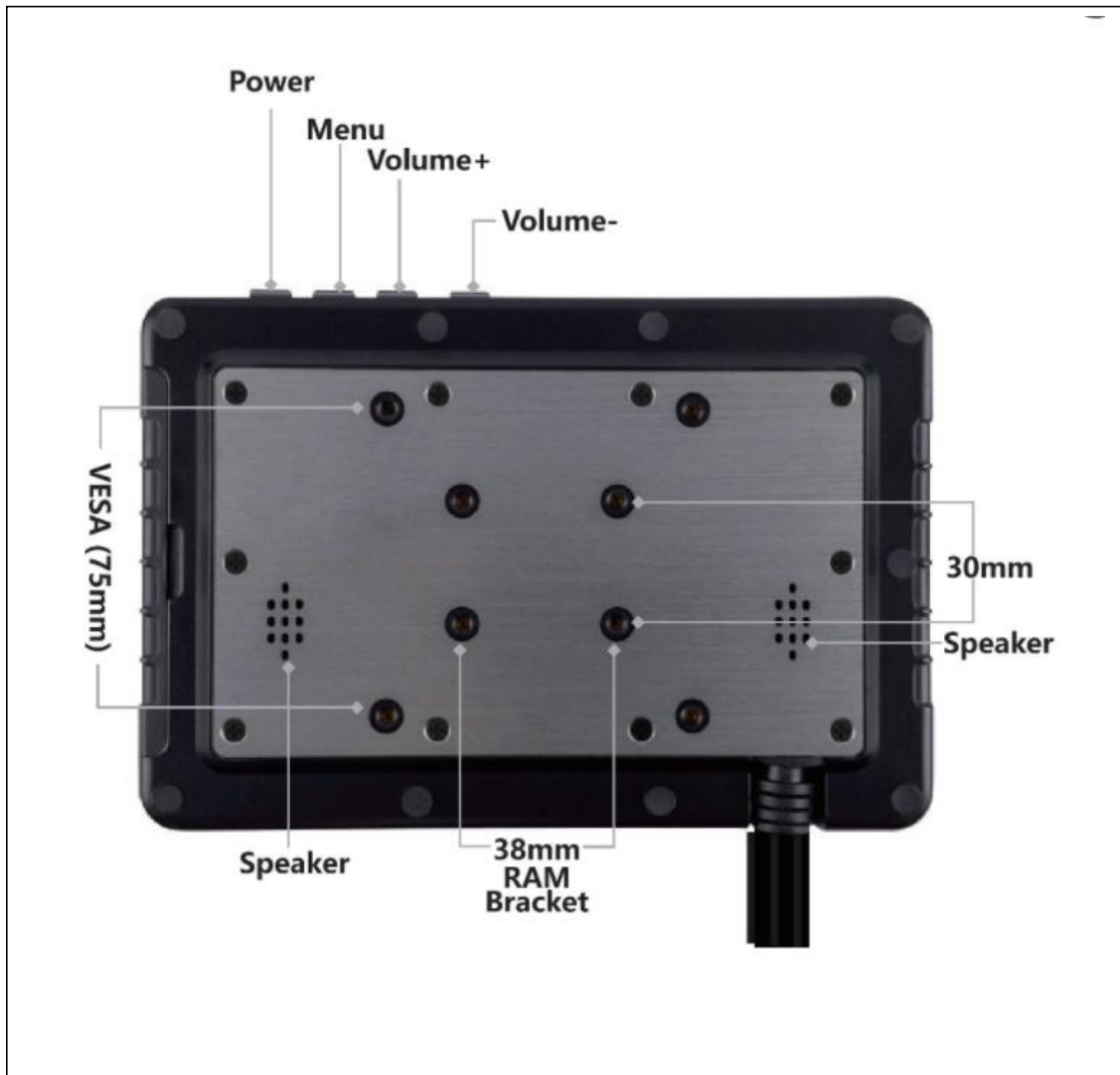



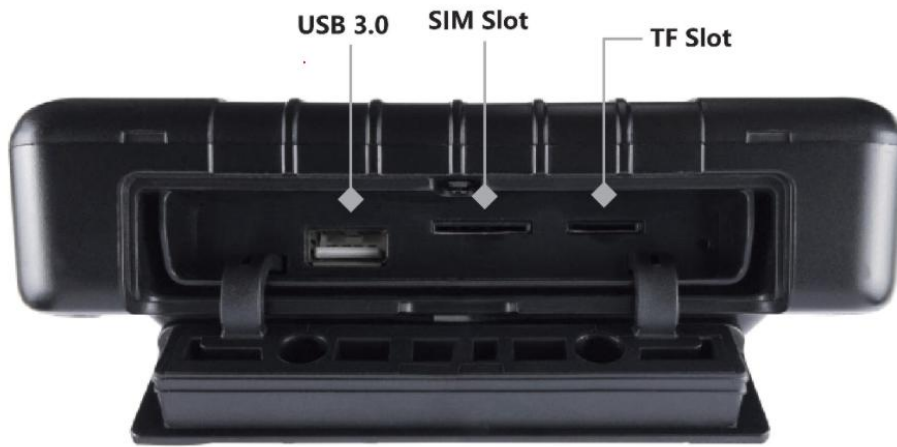

### Accessory

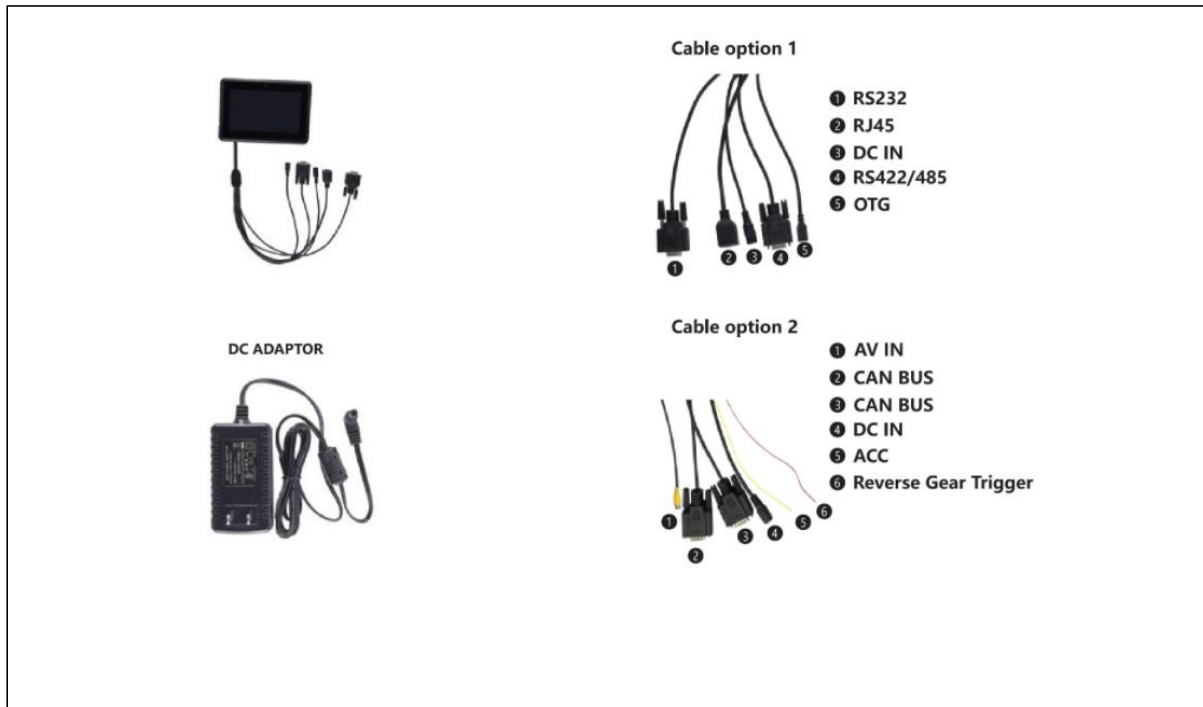

1. Power Key: Short Key:sleep/ wake up V7S  
Length Key: boot, power off
2. Menu: Enter the menu interface
3. Volume +: Increase the volume
4. Volume -: Decrease the volume
5. TF Card: Extended to 128G TF card
6. SIM Card: Identify network communication
7. USB ports: be able to connect with USB driver/ mouse/ keyboard
8. LED:
  - Red light: charging the battery
  - Green light: battery charging saturation

9. Front camera
10. Microphone interface
11. Reset key: used in mechanical down without reset operation
12. 38mm\*30mm RAM mounting screw holes
13. Speaker

### 3 Extended Cable

#### 3.1 Definition:

##### Cable 1

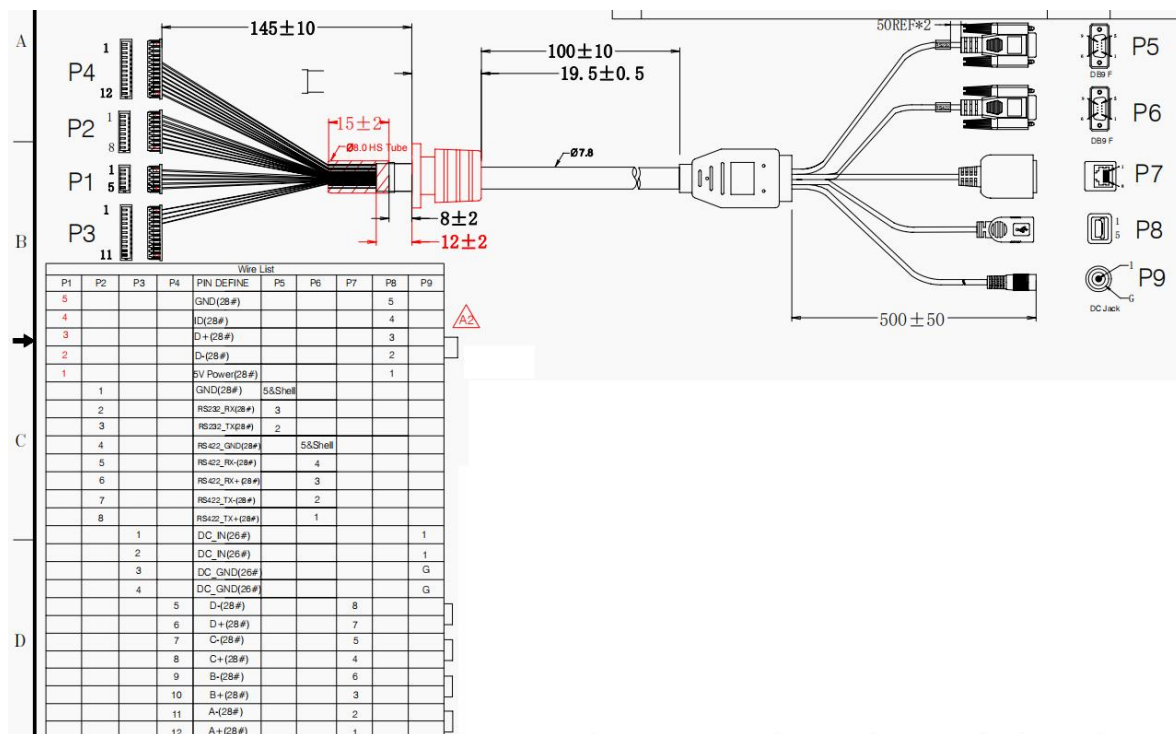

Cable 2

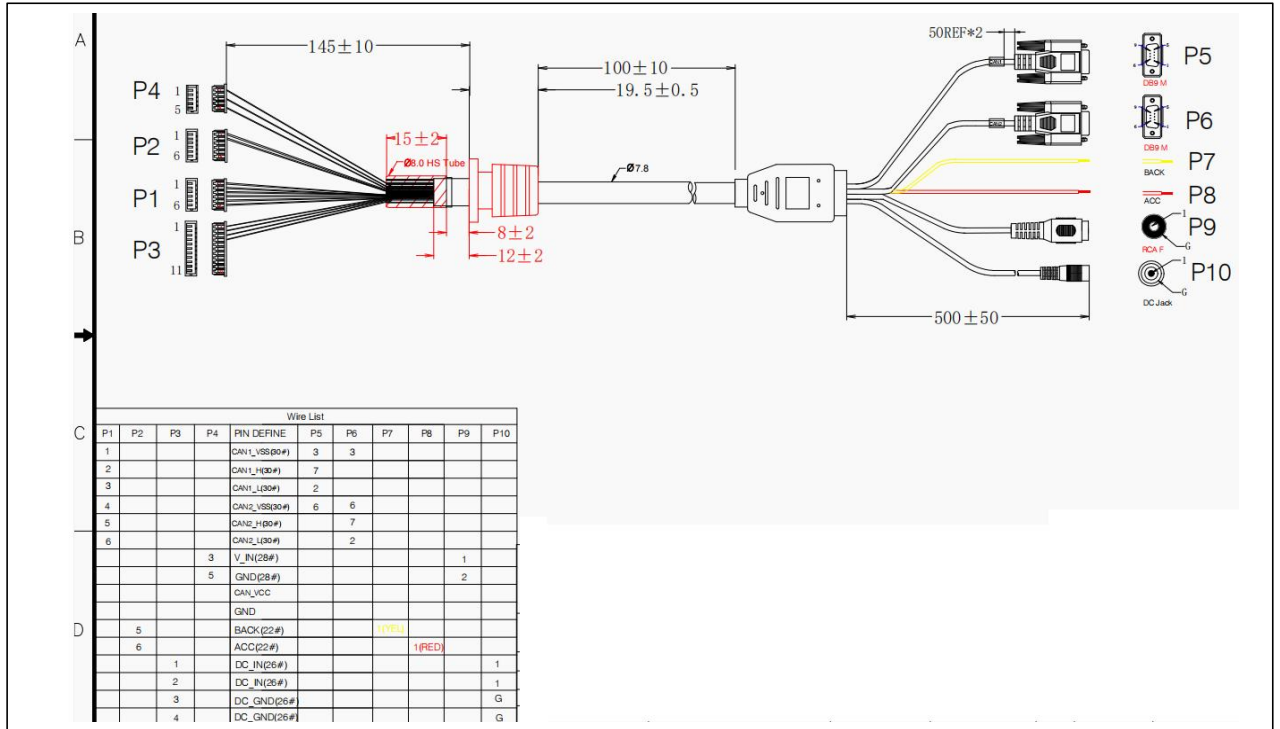

### 3.2 Serial port

#### RS232/ RS422 test:

Connect RS232 or RS422 with DB9 testing jig and click Device\_test\_RS232, and print the data as below:

RS232

/dev/ttyS5Test B

RS422



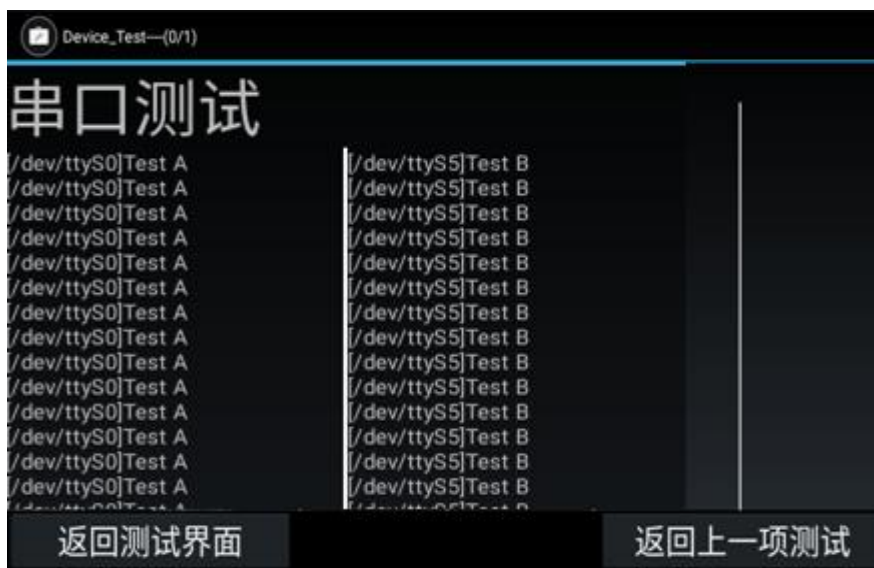

/dev/ttyS0Test A



### 3.3 CAN test interface



## 4. Micro SIM Card & Memory Card Instructions

-  In order to avoid damaging of the 3G/4G card & memory card, please insert the card smoothly and push slightly before you draw it out.
-  The memory card will be heat after long time working.
-  If you don't correctly use the memory card or cut the power when it being read, maybe some data will be damaged.
-  If you don't correctly use 3G/4G card or cut the power when it being read, the network will be interrupted.
-  If you do not use Micro SD card for a long time, please put it into packing box.

## 5. Basic Operation

### 5.1 Click and Slide:

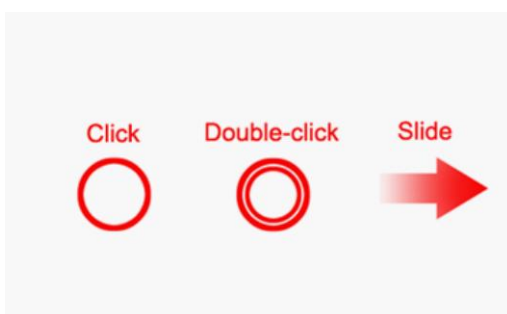

### 5.2 Long-press and Drag



### 5.3 Install APK

Settings→Security→Unknown sources→Install APK

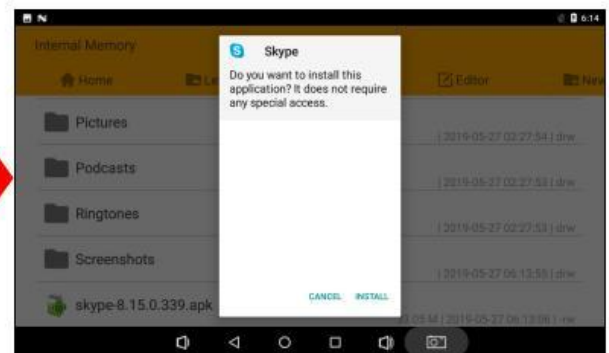
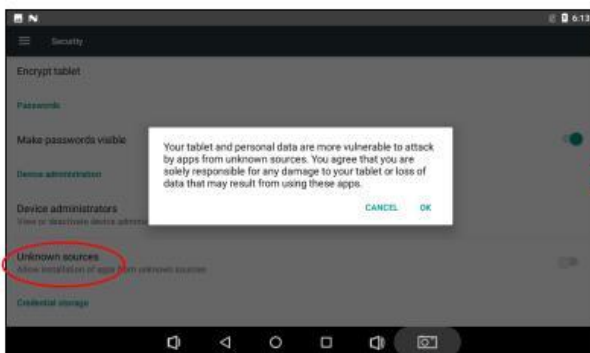

### 5.4 Delete

#### 5.4.1 Delete APK

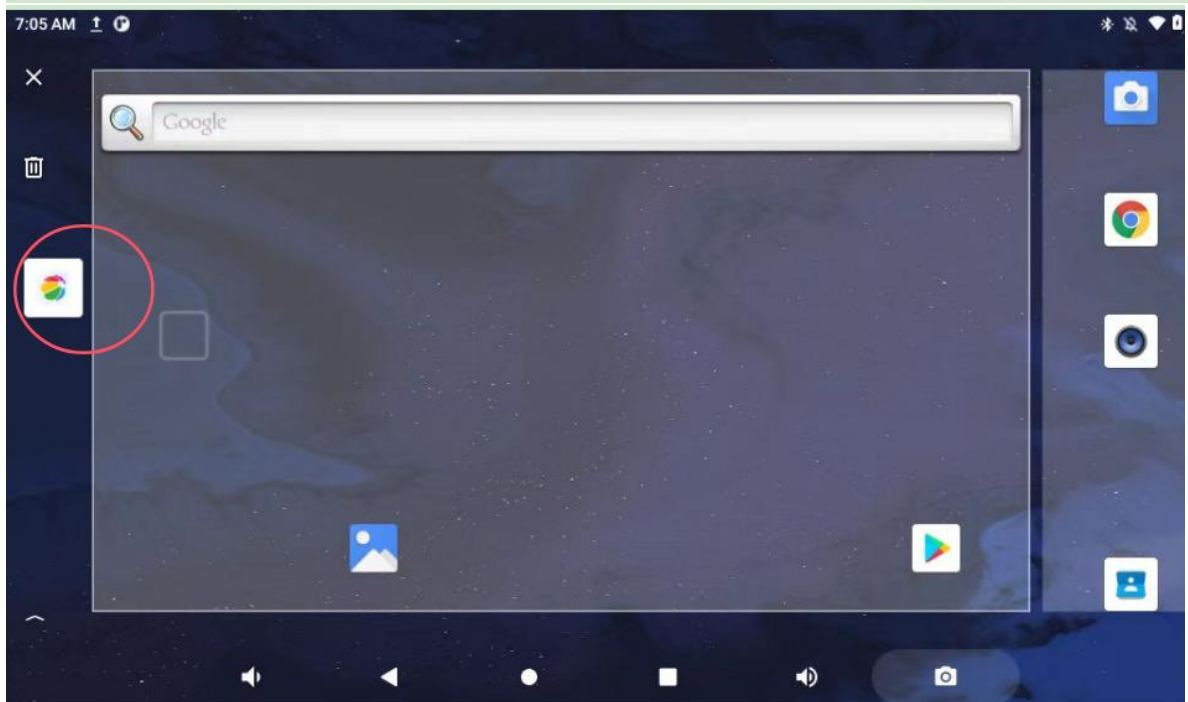
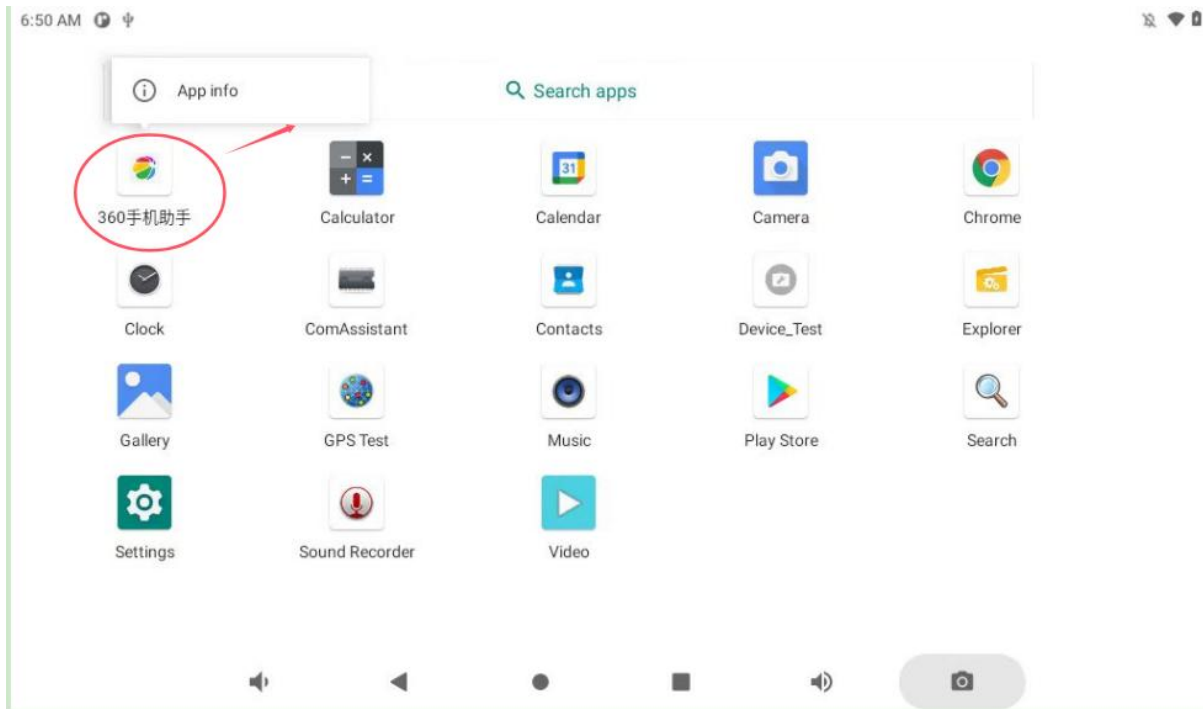

Long-press the application icon, and drag to the Home screen, then drop to the recycle, lift-up to delete this software.









## 6.MENU

### 6.1 Icon Bar

Icon bar shows on the top of screen:

Icon	Name	Description
	Wi-Fi	Wi-Fi signal connection and status of signal weakness or strength.
	No SIM card	Icon displayed when no SIM card.
	Mobile Network	Network available but not surf the Internet via 2G/3G/4G.

		Signal connection and status.
	Time	Current time
	Wi-Fi Hotspot	Wi-Fi Hotspot available
	Bluetooth	Bluetooth available
	Position	GPS positioning
	Flight Mode	Flight mode status

## 6.2 Menu Setting

Scroll up to enter application list

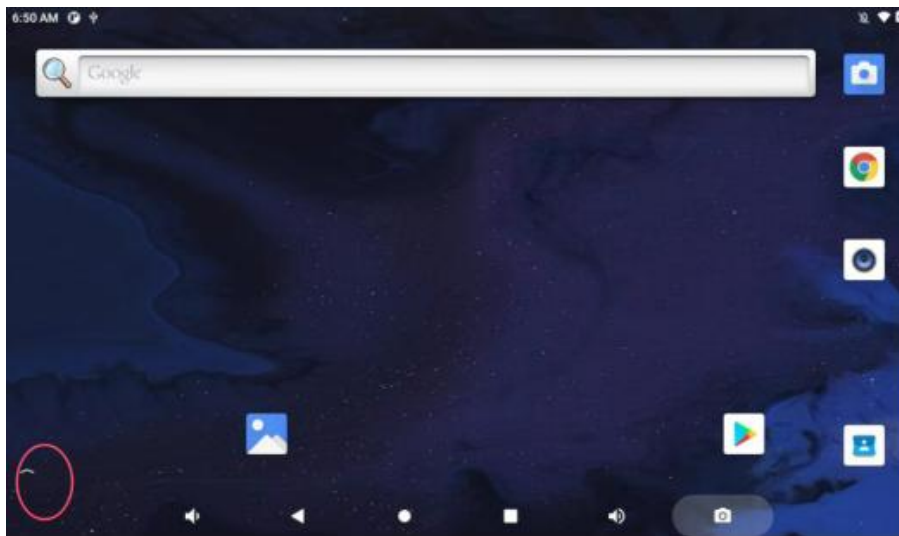



### 6.2.1 Drop down from the top of the screen to enter notification bar.

The notification bar shows system, running and error notice.

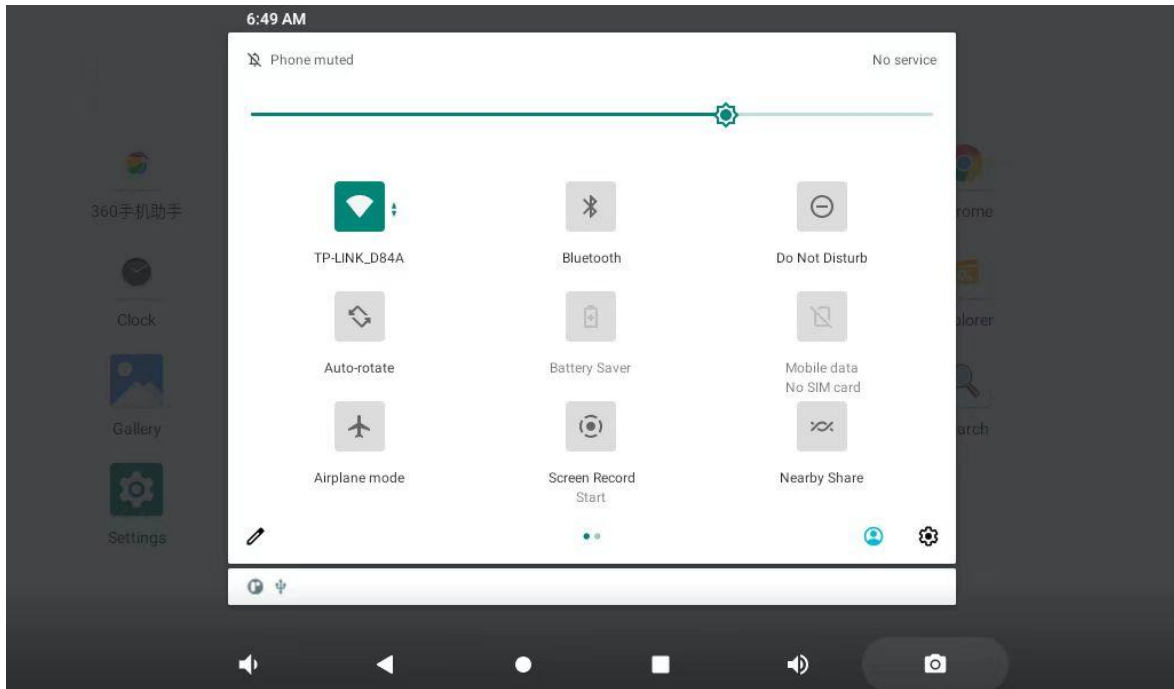

### 6.2.2 Click 'Settings' to launch setting in the application list

Setting according to users' needs. Click search icon to search function options on the upper right corner of screen. To set Wi-Fi, Bluetooth, mobile network

 VPN, Hotspot, Ethernet functions in 'Network & Internet' option.

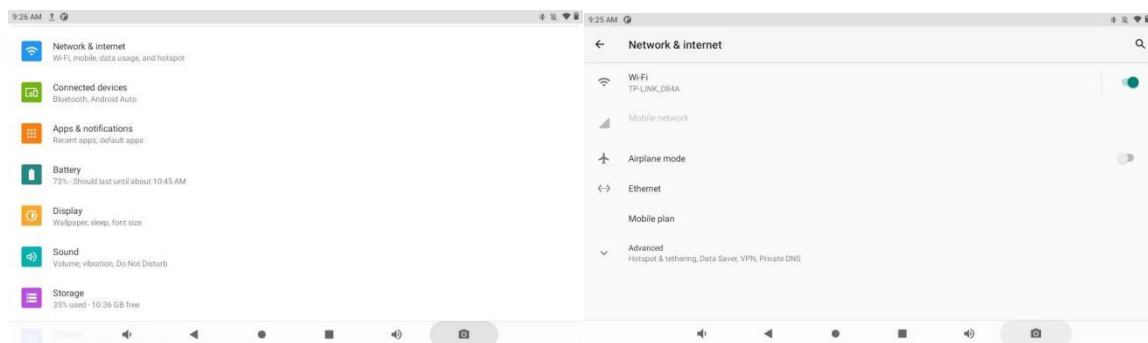

### 6.2.3 To view and set brightness, wallpaper, screen rotation, screen timeout in 'Display' option.

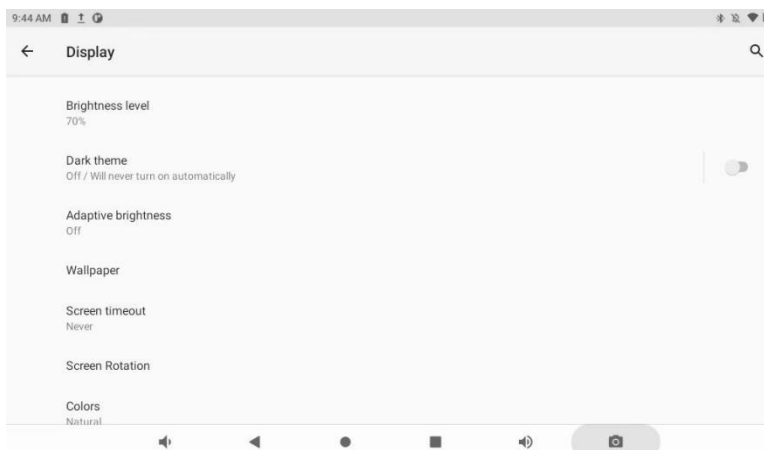

View RAM in the 'About tablet' option

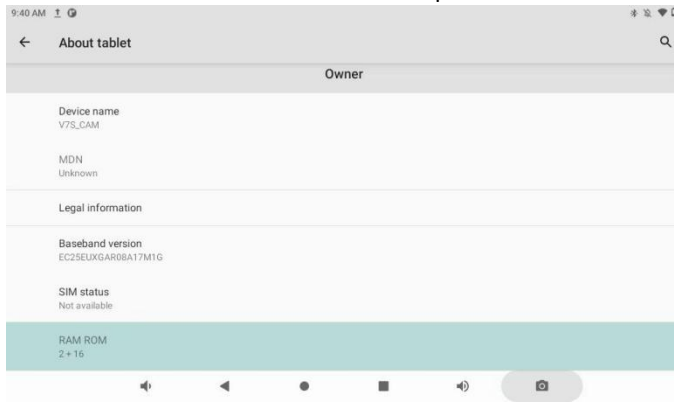

6.2.4 To manage language & input and reset options in 'System' option. Add new language is available.

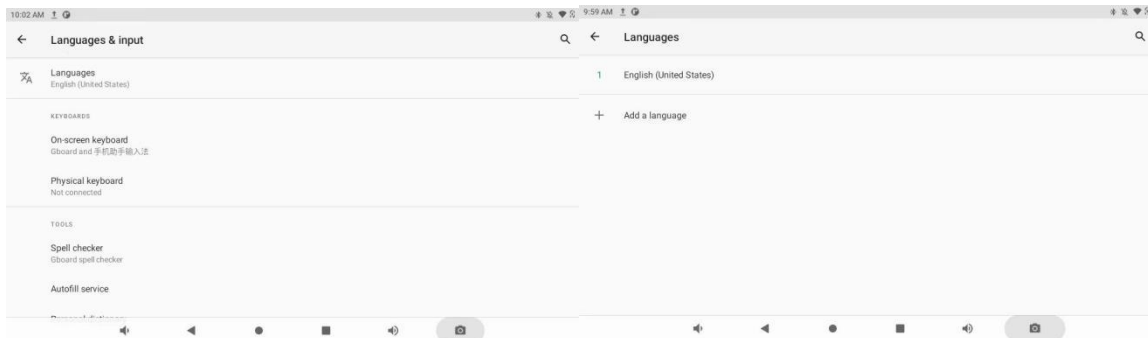

6.2.5 When unrecovered problems occurred, try to click 'Backup' & 'reset' and 'Factory data reset' then follow the instructions. Device will delete settings and applications after restart, and restore to factory defaults. (Please backup all important files before reset. Otherwise files will be deleted automatically and restore to factory defaults.

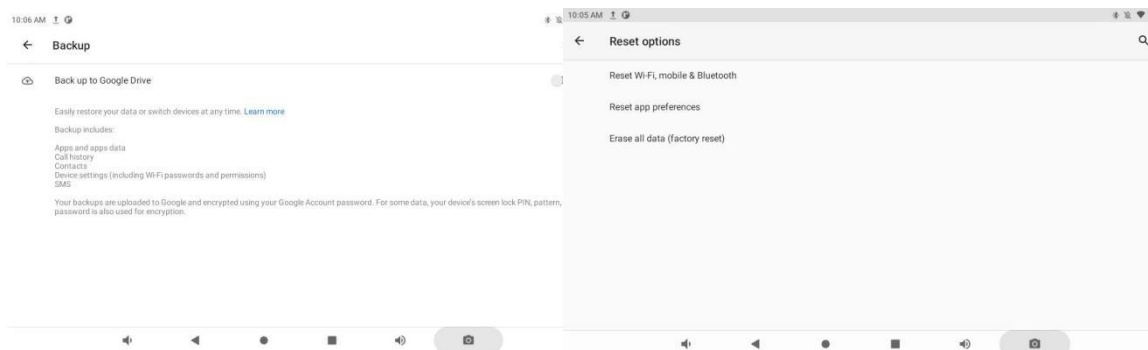

6.2.6 To set date & time and accessibility in 'System' option. View Android version, Build number, kernel version, status information in 'About tablet' option.

(Do NOT operate if unfamiliar with 'Developer options')

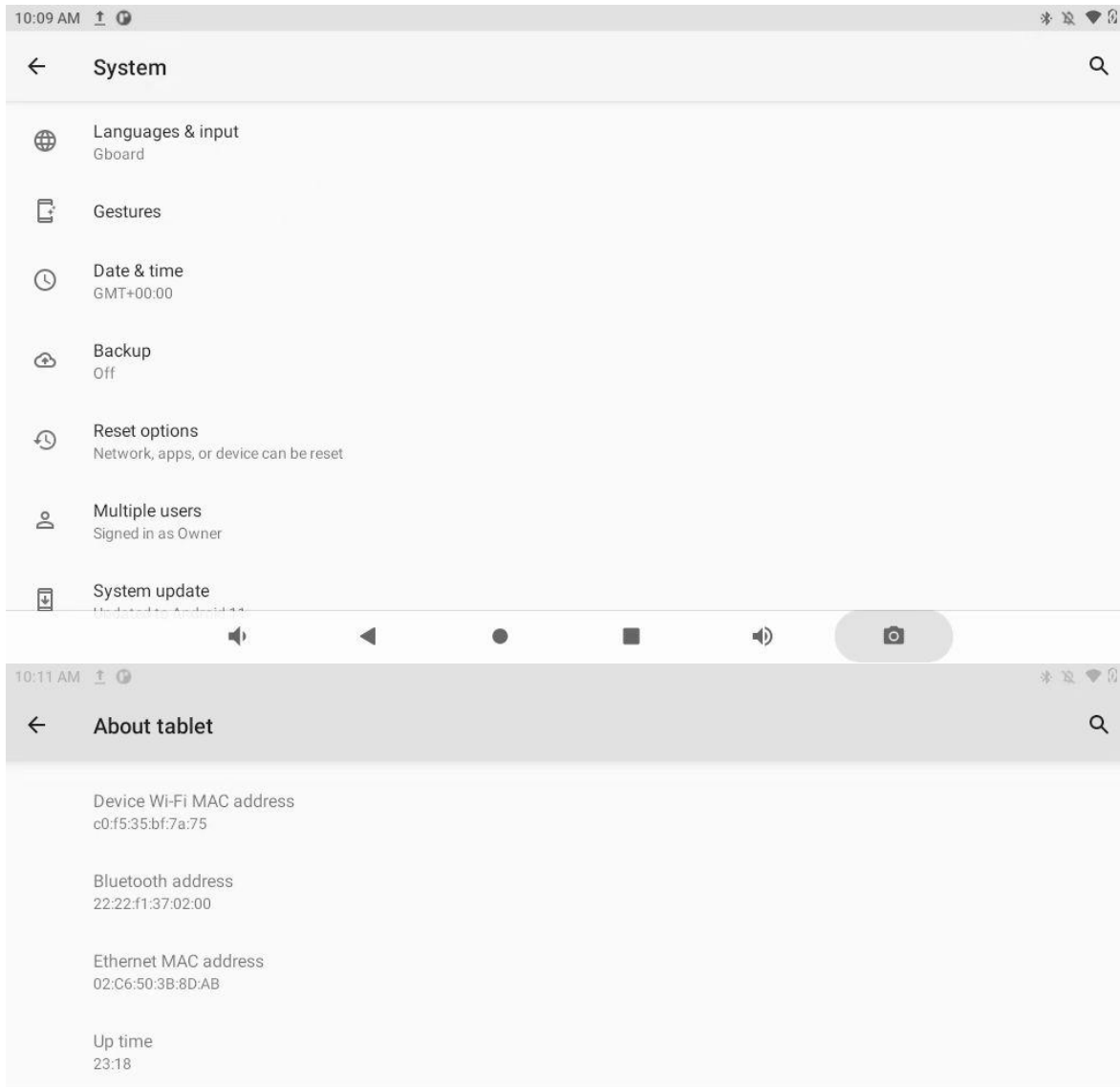

## 7. Accessories

### 7.1 Standard accessories:

- DC 12V adapter 1pc
- Extension Cable 1pc

### 7.2 Optional accessories:

- Sunshade 1pc

## 8. Update firmware

### 8.1 Supported host OS

- Windows XP (32/64bit)
- Windows 7 (32/64bit)
- Windows 8 (32/64bit)
- Windows 10 (32/64bit)

## 8.2 Install RK USB Driver

Uncompress DriverAssitant.zip, then run DriverInstall.exe inside.

## 8.3 Connect Device

8.3.1 Use USB OTG cable to connect host and V7S together.

8.3.2 Plug in the power

8.3.3 Run AndroidTool.exe: (Note: If using Windows 7/8, you'll need to right click it, select to run it as Administrator)

If AndroidTool defaults to display in Chinese. We need to change it to English. Open config.ini with an text editor (like notepad).

The starting lines are:

```
#选择工具语言:Selected=1(中文);Selected=2(英文)

[Language]
Kinds=2
Selected=1
LangPath=Language\
```

Change "Selected=1" to "Selected=2", and save. From now on, AndroidTool will display in English.

## 8.4.Flash update.img

8.4.1 Switch to "Upgrade Firmware" tab page. Show “found one MSC device”

8.4.2 Click "Firmware" button and open the image file. Detail information of the image file, like version and chip

8.4.3 Click "Switch" button to change ADB Device to LOADER Device.

8.4.4 Click "Upgrade" button to start flash.

8.4.5 Flash update success , Auto reset device.

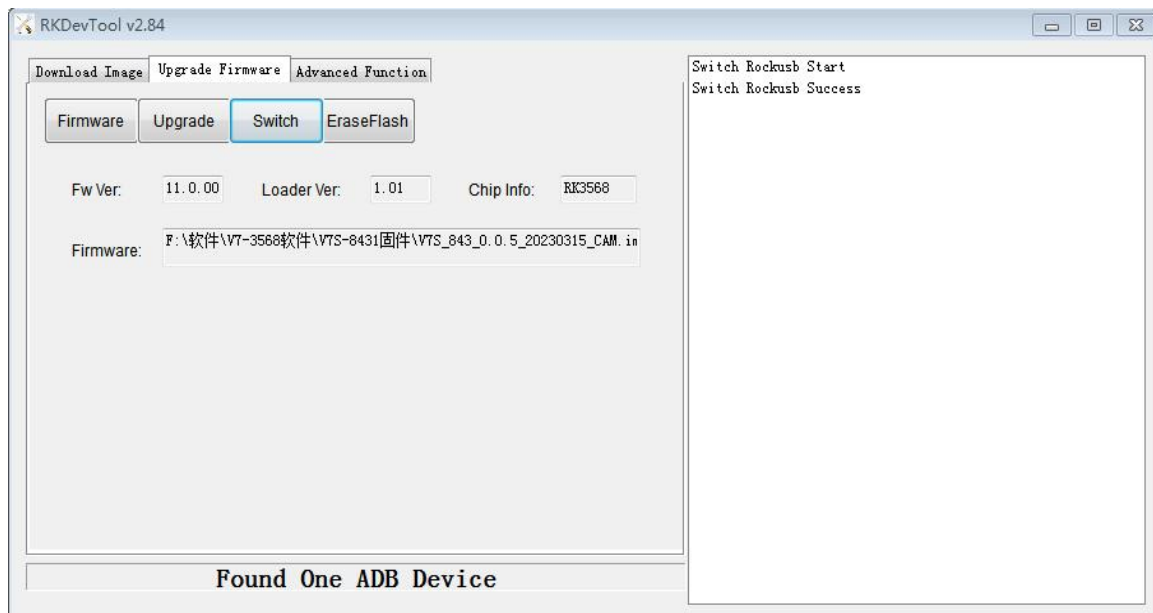

## 9. Trouble Shooting

### 9.1 Power Problem Cannot boot up

- Wrong cable connection:  
Connect Extended cable with device first, and connect the AC end of DC adapter with DC input port of Extended cable, then the other end of DC adapter connect with power plug socket.
- Bad connection:  
Check every connection and socket of power source.

### 9.2 Screen Problem

- No picture on screen.
- The application reaction time is too long and cannot be activated when clicked.
- The image appears delay or still when switching.  
Please restart your system if the device has any problem as described above.
- Display screen is misty.  
Please check whether the display screen surface has dust filth or not. Please simply wipe with clean and soft cloth.

### Warning:

Changes or modifications to this unit not expressly approved by the party responsible for compliance could void the user's authority to operate the equipment.

NOTE: This device complies with part 15 of the FCC Rules.

Operation is subject to the following two conditions:

- (1) This device may not cause harmful interference, and
- (2) this device must accept any interference received, including interference that may cause undesired operation.

### FCC Statement:

This equipment has been tested and found to comply with the limits for a Class B Digital device, pursuant to part 15 of the FCC Rules. These limits are designed to provide reasonable protection against harmful interference in a residential installation.

This equipment generates, uses and can radiate radio frequency energy and, if not installed and used in accordance with the instructions, may cause harmful interference to radio communications. However, there is no guarantee that Interference will not occur in a particular installation. If this equipment does cause harmful interference to radio or television reception, which can be determined by turning the equipment off and on, the user is encouraged to try to correct the interference by one or more of the following measures:

- Reorient or relocate the receiving antenna.
- Increase the separation between the equipment and receiver.
- Connect the equipment into an outlet on a circuit different from that to which the receiver is connected.
- Consult the dealer or an experienced radio/ TV technician for help.

The equipment complies with FCC Radiation exposure limit set forth for uncontrolled environment. This equipment should be installed and operated with minimum distance 20cm between the radiator and your body.

**Note: Due to constant effort to improve products and product features, specifications may change without prior notice.**