

ISED CABid: ES1909
 Lab. Company Number: 4621A

Test Report No:
 72676RRF.001A2

Test Report

USA FCC Part 22

CANADA RSS-132

(*) Identification of item tested	Continuous Positive Airway Pressure (CPAP) Device
(*) Trademark	ResMed
(*) Model and/or type reference	39485
(*) Derived model not tested	39523,39524,39525,39526,39527,39528
Other identification of the product	FCC ID: 2ACHL-AIR11M1U IC: 9103A-AIR11M1U
(*) Features	LTE Cat-M1, BLE HW version: R390-7667 SW version: SW04600
Applicant	ResMed Pty Ltd 1 Elizabeth Macarthur Drive, Bella Vista, NSW, 2153, Australia
Test method requested, standard	USA FCC Part 22 (10-1-21 Edition). CANADA RSS-132 Issue 3, Jan. 2013. ANSI C63.26-2015. KDB 971168 D01 Power Meas License Digital Systems v03r01, April. 2018.
Summary	IN COMPLIANCE
Approved by (name / position & signature)	José Manuel Gómez Galván EMC Consumer & RF Lab. Manager
Date of issue	2023-03-27
Report template No	FDT08_24 (* "Data provided by the client")

Index

Competences and guarantees	3
General conditions	3
Uncertainty	3
Data provided by the client.....	3
Usage of samples	5
Test sample description	5
Identification of the client.....	6
Testing period and place.....	6
Document history	7
Environmental conditions	7
Remarks and comments	8
Testing verdicts.....	8
Summary	9
Appendix A: Test results for FCC 22 / RSS-132.....	10

Competences and guarantees

DEKRA Testing and Certification is a testing laboratory accredited by the National Accreditation Body (ENAC - Entidad Nacional de Acreditación) to perform the tests indicated in the Certificate No. 51/LE 147.

DEKRA Testing and Certification is an FCC-recognized accredited testing laboratory with appropriate scope of accreditation that covers the performed tests in this report.

DEKRA Testing and Certification is an ISED-recognized accredited testing laboratory, CABid: ES1909, Company Number: 4621A, with the appropriate scope of accreditation that covers the performed tests in this report.

In order to assure the traceability to other national and international laboratories, DEKRA Testing and Certification has a calibration and maintenance program for its measurement equipment.

DEKRA Testing and Certification guarantees the reliability of the data presented in this report, which is the result of the measurements and the tests performed to the item under test on the date and under the conditions stated on the report and it is based on the knowledge and technical facilities available at DEKRA Testing and Certification at the time of performance of the test.

DEKRA Testing and Certification is liable to the client for the maintenance of the confidentiality of all information related to the item under test and the results of the test.

The results presented in this Test Report apply only to the particular item under test established in this document.

IMPORTANT: No parts of this report may be reproduced or quoted out of context, in any form or by any means, except in full, without the previous written permission of DEKRA Testing and Certification.

General conditions

1. This report is only referred to the item that has undergone the test.
2. This report does not constitute or imply on its own an approval of the product by the Certification Bodies or competent Authorities.
3. This document is only valid if complete; no partial reproduction can be made without previous written permission of DEKRA Testing and Certification S.A.U.
4. This test report cannot be used partially or in full for publicity and/or promotional purposes without previous written permission of DEKRA Testing and Certification S.A.U. and the Accreditation Bodies.

Uncertainty

Uncertainty (factor $k=2$) was calculated according to the DEKRA Testing and Certification S.A.U. internal document PODT000.

Data provided by the client

The following data has been provided by the client:

1. Information relating to the description of the sample ("Identification of the item tested", "Trademark", "Model and/or type reference tested").
2. The sample of the model 39485 is a CPAP device with integrated cellular and Bluetooth connectivity.
3. Derived models not tested. These models have been declared by the supplier of the sample as being the same as the model under test.



Date: 30-Nov-2022

DECLARATION OF EQUIVALENCE

This document declares that the following designated products are equivalent to the unit under test 39485.

Model Name / Product Code	Marketing Name
39523	AirSense 11 AutoSet USA
39524	AirSense 11 CPAP USA
39525	AirSense 11 Elite USA
39526	AirSense 11 AutoSet CAN
39527	AirSense 11 CPAP CAN
39528	AirSense 11 Elite CAN

All the above stated products and the unit under test - 39485 have the same cellular hardware and firmware.

Applicant:

Company Name: ResMed Pty Ltd
Address: 1 Elizabeth Macarthur Drive,
Bella Vista NSW 2153
Australia

By,



Christopher Jenkins
Title: Manager – Systems Engineering
Company: ResMed Pty Ltd
Telephone: +61 2 8884 1517
e-mail: Christopher.jenkins@resmed.com.au

DEKRA Testing and Certification S.A.U. declines any responsibility with respect to the information provided by the client and that may affect the validity of results.

Usage of samples

Samples undergoing test have been selected by: The client.

- Sample S/01 is composed of the following elements:

Control Nº	Description	Model	Serial Nº	Date of reception
72676/003	Continuous Positive Airway Pressure (CPAP) Device	39485	22222172432	2022/10/03
72676/007	AC/DC Adapter	390000	02GNXL04	2022/10/03
72676/009	Power Cord	-	-	2022/10/03
66427/006	Climate line	AIR11	-	2020/12/29

Sample S/01 has undergone the following test(s): The radiated tests indicated in Appendix A.

- Sample S/02 is composed of the following elements:

Control Nº	Description	Model	Serial Nº	Date of reception
72676/001	Continuous Positive Airway Pressure (CPAP) Device	39485	22222172433	2022/10/03
72676/003	Continuous Positive Airway Pressure (CPAP) Device	39485	22222172432	2022/10/03
72676/007	AC/DC Adapter	390000	02GNXL04	2022/10/03

Sample S/02 has undergone the following test(s): The RF Output Power and Spurious Emissions at Antenna Terminals at Block Edges conducted tests indicated in Appendix A.

- Sample S/03 is composed of the following elements:

Control Nº	Description	Model	Serial Nº	Date of reception
72676/002	Continuous Positive Airway Pressure (CPAP) Device	39485	22222172424	2022/10/03
72676/008	AC/DC Adapter	390000	02GNXH04	2022/10/03
72676/010	Power Cord	-	-	2022/10/03

Sample S/03 has undergone the following test(s): The Modulation Characteristics, Frequency Stability, Occupied Bandwidth, Spurious Emissions at Antenna Terminals conducted tests indicated in Appendix A.

Test sample description

Ports.....:	Port name and description	Cable				
		Specified max length [m]	Attached during test	Shielded	Coupled to patient ⁽³⁾	
	Power		<input checked="" type="checkbox"/>	<input type="checkbox"/>	<input type="checkbox"/>	
Supplementary information to the ports.....:	-					
Rated power supply	Voltage and Frequency	Reference poles				
		L1	L2	L3	N	PE

	<input checked="" type="checkbox"/>	AC: 100-240V~50-60 Hz 2.0A	<input checked="" type="checkbox"/>	<input type="checkbox"/>	<input type="checkbox"/>	<input checked="" type="checkbox"/>	<input type="checkbox"/>
	<input checked="" type="checkbox"/>	AC: 115V~400Hz 1.5A	<input checked="" type="checkbox"/>	<input type="checkbox"/>	<input type="checkbox"/>	<input checked="" type="checkbox"/>	<input type="checkbox"/>
	<input checked="" type="checkbox"/>	DC: 12V (DC-DC for Vehicle Use)					
	<input checked="" type="checkbox"/>	DC: 24V (DC-DC for Vehicle Use)					
Rated Power..... :	-						
Clock frequencies..... :	N/A						
Other parameters..... :	390000 (PSU Model Number)						
Software version..... :	SW04600 (DUT)						
Hardware version..... :	R390-7667						
Dimensions in cm (W x H x D) ... :	138.5 mm x 259.4 mm x 94.5 mm						
Mounting position..... :	<input checked="" type="checkbox"/>	Table top equipment					
	<input type="checkbox"/>	Wall/Ceiling mounted equipment					
	<input type="checkbox"/>	Floor standing equipment					
	<input type="checkbox"/>	Hand-held equipment					
	<input type="checkbox"/>	Other:					
Modules/parts..... :	Module/parts of test item		Type	Manufacturer			
	Wireless Module		SARA-R5	U-blox			
	Bluetooth LE		EFR32BG22	SiLabs			
Accessories (not part of the test item)..... :	Description		Type	Manufacturer			
	-		-	-			
Documents as provided by the applicant..... :	Description		File name	Issue date			
	-		-	-			

⁽³⁾ Only for Medical Equipment

Identification of the client

ResMed Pty Ltd
 1 Elizabeth Macarthur Drive, Bella Vista, NSW, 2153, Australia

Testing period and place

Test Location	DEKRA Testing and Certification S.A.U.
Date (start)	2022-10-13
Date (finish)	2023-03-13

Document history

Report number	Date	Description
72676RRF.001	2022-12-29	First release.
72676RRF.001A1	2023-01-31	Second release. The following tests are included: - FCC 22.913 / RSS-132 5.4: RF Output Power. - FCC 22.917 / RSS-132 5.5: Spurious Emissions at Antenna Terminals at Block Edges.
72676RRF.001A2	2023-03-27	Third release. The following tests are included: - FCC 2.1047 / RSS-132 5.2: Modulation Characteristics. - FCC 22.355 / RSS-132 5.3: Frequency Stability. - FCC 2.1049: Occupied Bandwidth. - FCC 22.917 / RSS-132 5.5: Spurious Emissions at Antenna Terminals.

Environmental conditions

In the control chamber, the following limits were not exceeded during the test:

Temperature	Min. = 15 °C Max. = 35 °C
Relative humidity	Min. = 20 % Max. = 75 %

In the semi-anechoic chamber, the following limits were not exceeded during the test:

Temperature	Min. = 15 °C Max. = 35 °C
Relative humidity	Min. = 20 % Max. = 75 %

In the chamber for conducted measurements, the following limits were not exceeded during the test:

Temperature	Min. = 15 °C Max. = 35 °C
Relative humidity	Min. = 20 % Max. = 75 %

Remarks and comments

The tests have been performed by the technical personnel: Miguel Manuel López, Rafael Fernández, Fernando Chito.

Used instrumentation:

Conducted Measurements

	Last Calibration	Due Calibration
1. Shielded Room ETS LINDGREN S101	N/A	N/A
2. Wideband Radio Communication Tester ROHDE AND SCHWARZ CMW500	2022-03	2023-03
3. Signal Analyzer 20 Hz to 8 GHz ROHDE AND SCHWARZ FSQ8	2021-11	2023-11
4. Attenuator DC, 26.5 GHz, 10 dB, 2W TECHNIWAVE TWSMAG2	2022-05	2023-05
5. Attenuator DC, 26.5 GHz, 6 dB, 2W TECHNIWAVE TWSMAG2	2022-02	2023-02
6. Power Divider, DC-25 GHz TEKTRONIX 5333	2022-02	2023-02
7. Climatic Chamber BINDER MK 56	2022-03	2023-03
8. Signal and Spectrum Analyzer 10 Hz - 40 GHz ROHDE AND SCHWARZ FSV40	2021-02	2023-02
9. Attenuator 5 dB 2W DC-26.5GHz	2022-07	2023-07

Radiated Measurements

	Last Calibration	Due Calibration
1. Semianechoic Absorber Lined Chamber ETS LINDGREN FACT 3 200 STP	N/A	N/A
2. Shielded Room ETS LINDGREN S101	N/A	N/A
3. Biconical/Log Antenna 30 MHz - 6 GHz ETS LINDGREN 3142E	2020-10	2023-10
4. Horn Antenna 1-18 GHz SCHWARZBECK MESS-ELEKTRONIK BBHA 9120 D	2020-08	2023-08
5. RF Preamplicifier G>30dB, 1-18GHz BONN ELEKTRONIK BLMA 0118-3A	2021-12	2022-12
6. EMI Test Receiver 2Hz-44GHz, ROHDE AND SCHWARZ ESW44	2021-12	2023-12
7. Wideband Radio Communication Tester ROHDE AND SCHWARZ CMW500	N/A	N/A
8. AC Power Supply CHROMA 6490	2020-12	2022-12
9. EMC/RF Testing SW ROHDE AND SCHWARZ EMC32	N/A	N/A

Testing verdicts

Not applicable:	N/A
Pass:	P
Fail:	F
Not measured:	N/M

Summary

FCC PART 22 / RSS-132 PARAGRAPH		
Requirement – Test case	Verdict	Remark
FCC 22.913 / RSS-132 5.4: RF Output Power	P	
FCC 2.1047 / RSS-132 5.2: Modulation Characteristics	P	
FCC 22.355 / RSS-132 5.3: Frequency Stability	P	
FCC 2.1049: Occupied Bandwidth	P	
FCC 22.917 / RSS-132 5.5: Spurious Emissions at Antenna Terminals	P	
FCC 22.917 / RSS-132 5.5: Spurious Emissions at Antenna Terminals at Block Edges	P	
FCC 22.917 / RSS-132 5.5: Radiated Emissions	P	
<u>Supplementary information and remarks:</u>		
None.		

Appendix A: Test results for FCC 22 / RSS-132

INDEX

TEST CONDITIONS	12
RF Output Power	13
Frequency Stability	26
Modulation Characteristics	29
Occupied Bandwidth	31
Spurious Emissions at Antenna Terminals	36
Spurious Emissions at Antenna Terminals at Block Edges	39
Radiated Emissions	45

TEST CONDITIONS

(*): Declared by the Applicant.

POWER SUPPLY (*):

Vnormal: Preliminary scan determined 115 Vac / 60 Hz as worst case of power supply.
 Type of Power Supply: Mains Supply.

ANTENNA GAIN (*):

Bands	Gain (dBi)	Type
LTE 5	+2.2	Ceramic
LTE 26	+2.2	Ceramic

TEST FREQUENCIES:

LTE Band 5. QPSK and 16QAM modulations:

	Channel (Frequency MHz)			
	BW=1.4 MHz	BW=3 MHz	BW=5 MHz	BW=10 MHz
Low	20407 (824.70)	20415 (825.50)	20425 (826.50)	20450 (829.00)
Middle	20525 (836.50)	20525 (836.50)	20525 (836.50)	20525 (836.50)
High	20643 (848.30)	20635 (847.50)	20625 (846.50)	20600 (844.00)

LTE Band 26 sub-band 824-849 MHz. QPSK and 16QAM modulations:

	Channel (Frequency MHz)				
	BW=1.4 MHz	BW=3 MHz	BW=5 MHz	BW=10 MHz	BW=15 MHz
Low	26797 (824.70)	26805 (825.50)	26815 (826.50)	26840 (829.00)	26865 (831.50)
Middle	26915 (836.50)	26915 (836.50)	26915 (836.50)	26915 (836.50)	26915 (836.50)
High	27033 (848.30)	27025 (847.50)	27015 (846.50)	26990 (844.00)	26965 (841.50)

NOTE: The 824-849 MHz sub-band of the LTE Band 26 is completely included in the LTE Band 5, so the LTE Band 5 channels were tested to give **you** conformity to the assigned block.

RF Output Power

Limits

FCC §2.1046 and FCC §22.913. The Effective Radiated Power (E.R.P) of mobile transmitter and auxiliary test transmitter must not exceed 7 Watts (38.45 dBm E.R.P.).

RSS-132. Clause 5.4. The equivalent isotropically radiated power (e.i.r.p.) for mobile equipment shall not exceed 11.5 watts (38.45 dBm E.R.P.).

In addition, the peak-to-average power ratio (PAPR) of the transmitter shall not exceed 13 dB for more than 0.1% of the time using a signal corresponding to the High PAPR during periods of continuous transmission.

Method

The conducted RF output power measurements were made at the RF output terminals of the EUT using the power meter of the Universal Radio Communication tester R&S CMW500, selecting maximum transmission power of the EUT and different modes of modulation.

The peak-to-average power ratio (PAPR) is measured using an attenuator, power splitter and spectrum analyser with a Complementary Cumulative Distribution Function implemented.

The maximum equivalent isotropically radiated power (e.i.r.p.) is calculated by adding the declared maximum antenna gain (dBi).

The maximum effective radiated power e.r.p. is calculated from the maximum equivalent isotropically radiated power (e.i.r.p.) by subtracting 2.15 dB:

$$E.R.P. = E.I.R.P. - 2.15 \text{ dB}$$

Test setup

1. CONDUCTED AVERAGE POWER:

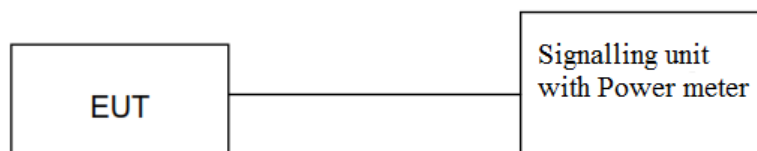

2. PEAK-TO-AVERAGE POWER RATIO (PAPR) and Conducted Average power:

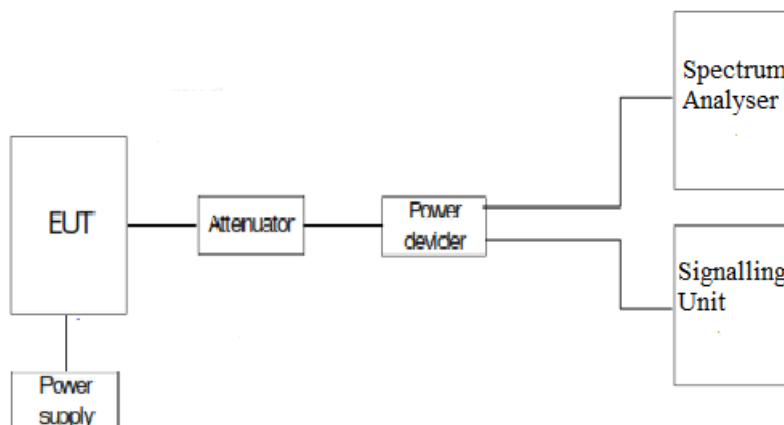

Results

1. CONDUCTED AVERAGE POWER

LTE Band 5:

LTE Band 5. QPSK modulation. BW=1.4 MHz.

Channel	Low	Middle	High
Maximum declared antenna gain (dBi)	2.2		
Measured maximum average power (dBm) at antenna port	22.30	22.29	22.39
Maximum equivalent isotropically radiated power (E.I.R.P.) (dBm)	24.50	24.49	24.59
Maximum effective radiated power E.R.P. (dBm)	22.35	22.34	22.44
PAPR (dB)	(*)	7.12	(*)
Measurement uncertainty (dB)	<±0.94		

Average Power Worst Case: Modulation QPSK. RB Size: 6. RB Offset: 0.

PAPR Worst Case: Modulation QPSK. RB Size: 6. RB Offset: 0.

(*): Preliminary measurements determined the Middle Channel as the worst case.

LTE Band 5. 16QAM modulation. BW=1.4 MHz.

Channel	Low	Middle	High
Maximum declared antenna gain (dBi)	2.2		
Measured maximum average power (dBm) at antenna port	22.44	22.47	22.46
Maximum equivalent isotropically radiated power (E.I.R.P.) (dBm)	24.64	24.67	24.66
Maximum effective radiated power E.R.P. (dBm)	22.49	22.52	22.51
PAPR (dB)	7.56	7.66	7.53
Measurement uncertainty (dB)	<±0.94		

Average Power Worst Case: Modulation 16QAM. RB Size: 5. RB Offset: 0.

PAPR Worst Case: Modulation 16QAM. RB Size: 1. RB Offset: 0.

LTE Band 5. QPSK modulation. BW=3 MHz.

Channel	Low	Middle	High
Maximum declared antenna gain (dBi)	2.2		
Measured maximum average power (dBm) at antenna port	22.25	22.27	22.36
Maximum equivalent isotropically radiated power (E.I.R.P.) (dBm)	24.45	24.47	24.56
Maximum effective radiated power E.R.P. (dBm)	22.30	22.32	22.41
PAPR (dB)	(*)	7.02	(*)
Measurement uncertainty (dB)	<±0.94		

Average Power Worst Case: Modulation QPSK. RB Size: 1. RB Offset: 0.
 PAPR Worst Case: Modulation QPSK. RB Size: 6. RB Offset: 0.
 (*): Preliminary measurements determined the Middle Channel as the worst case.

LTE Band 5. 16QAM modulation. BW=3 MHz.

Channel	Low	Middle	High
Maximum declared antenna gain (dBi)	2.2		
Measured maximum average power (dBm) at antenna port	22.49	22.45	22.56
Maximum equivalent isotropically radiated power (E.I.R.P.) (dBm)	24.69	24.65	24.76
Maximum effective radiated power E.R.P. (dBm)	22.54	22.50	22.61
PAPR (dB)	7.18	7.31	7.18
Measurement uncertainty (dB)	<±0.94		

Average Power Worst Case: Modulation 16QAM. RB Size: 5. RB Offset: 0.
 PAPR Worst Case: Modulation 16QAM. RB Size: 1. RB Offset: 0.

LTE Band 5. QPSK modulation. BW=5 MHz.

Channel	Low	Middle	High
Maximum declared antenna gain (dBi)	2.2		
Measured maximum average power (dBm) at antenna port	22.31	22.28	22.40
Maximum equivalent isotropically radiated power (E.I.R.P.) (dBm)	24.51	24.48	24.60
Maximum effective radiated power E.R.P. (dBm)	22.36	22.33	22.45
PAPR (dB)	(*)	6.76	(*)
Measurement uncertainty (dB)	<±0.94		

Average Power Worst Case: Modulation QPSK. RB Size: 6. RB Offset: 0.
 PAPR Worst Case: Modulation QPSK. RB Size: 6. RB Offset: 0.
 (*): Preliminary measurements determined the Middle Channel as the worst case.

LTE Band 5. 16QAM modulation. BW=5 MHz.

Channel	Low	Middle	High
Maximum declared antenna gain (dBi)	2.2		
Measured maximum average power (dBm) at antenna port	22.56	22.48	22.58
Maximum equivalent isotropically radiated power (E.I.R.P.) (dBm)	24.76	24.68	24.78
Maximum effective radiated power E.R.P. (dBm)	22.61	22.53	22.63
PAPR (dB)	7.4	7.69	6.99
Measurement uncertainty (dB)	<±0.94		

Average Power Worst Case: Modulation 16QAM. RB Size: 5. RB Offset: 0.
 PAPR Worst Case: Modulation 16QAM. RB Size: 1. RB Offset: 0.

LTE Band 5. QPSK modulation. BW=10 MHz.

Channel	Low	Middle	High
Maximum declared antenna gain (dBi)	2.2		
Measured maximum average power (dBm) at antenna port	22.29	22.28	22.29
Maximum equivalent isotropically radiated power (E.I.R.P.) (dBm)	24.49	24.48	24.49
Maximum effective radiated power E.R.P. (dBm)	22.34	22.33	22.34
PAPR (dB)	(*)	7.05	(*)
Measurement uncertainty (dB)	<±0.94		

Average Power Worst Case: Modulation QPSK. RB Size: 6. RB Offset: 0.

PAPR Worst Case: Modulation QPSK. RB Size: 6. RB Offset: 0.

(*): Preliminary measurements determined the Middle Channel as the worst case.

LTE Band 5. 16QAM modulation. BW=10 MHz.

Channel	Low	Middle	High
Maximum declared antenna gain (dBi)	2.2		
Measured maximum average power (dBm) at antenna port	22.49	22.55	22.47
Maximum equivalent isotropically radiated power (E.I.R.P.) (dBm)	24.69	24.75	24.67
Maximum effective radiated power E.R.P. (dBm)	22.54	22.60	22.52
PAPR (dB)	7.6	7.44	7.5
Measurement uncertainty (dB)	<±0.94		

Average Power Worst Case: Modulation 16QAM. RB Size: 5. RB Offset: 0.

PAPR Worst Case: Modulation 16QAM. RB Size: 1. RB Offset: 0.

Verdict

Pass

2. PEAK-TO-AVERAGE POWER RATIO (PAPR)

Worst-case modulation in terms of PAPR is reported below: 16QAM.

LTE Band 5. BW=1.4 MHz. 16QAM MODULATION. RB Size: 1. RB Offset: 0.

Low Channel:

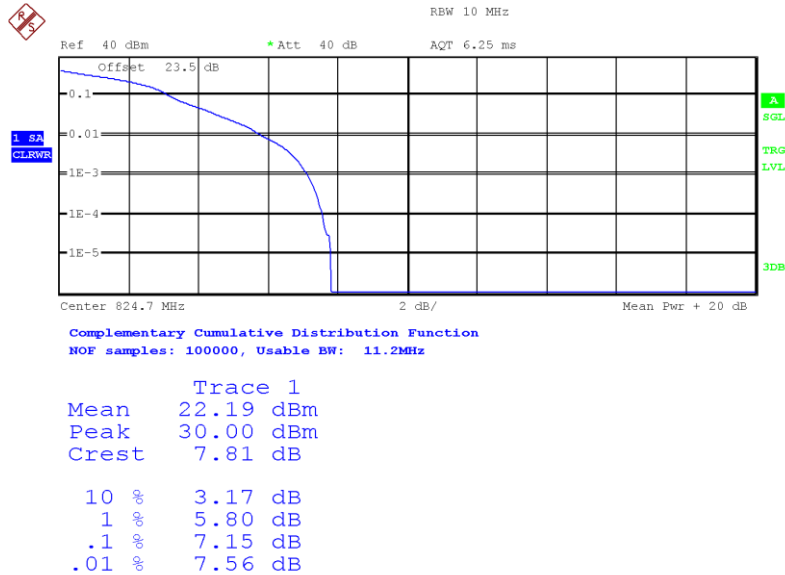

Date: 11.JAN.2023 20:03:03

Middle Channel:

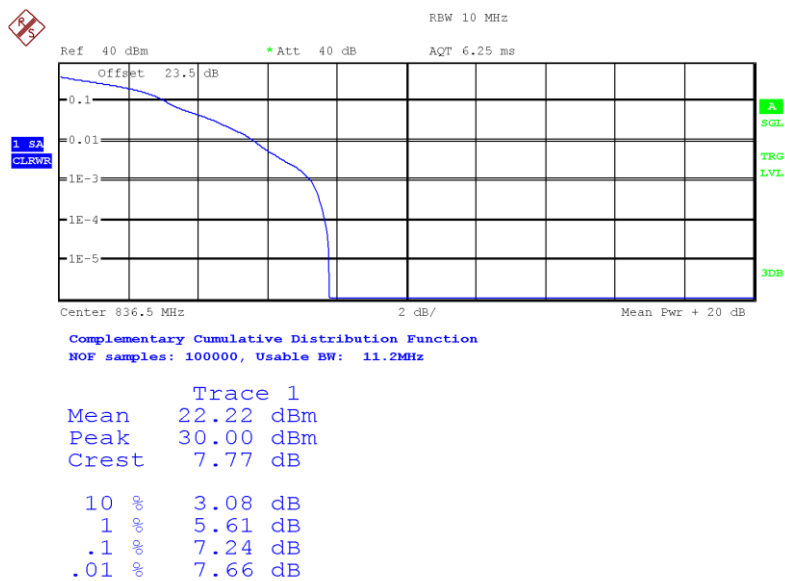

Date: 11.JAN.2023 20:06:33

High Channel:

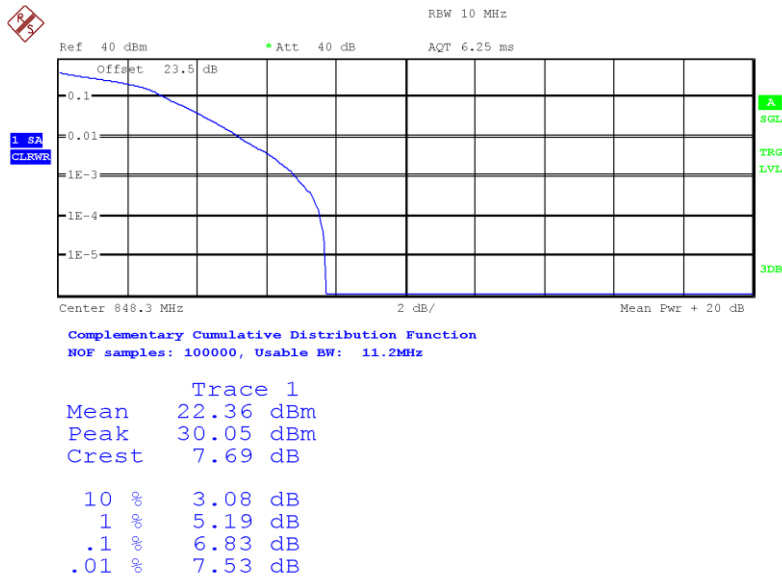

Date: 11.JAN.2023 20:01:06

LTE Band 5. BW=3 MHz. 16QAM MODULATION. RB Size: 1. RB Offset: 0.

Low Channel:

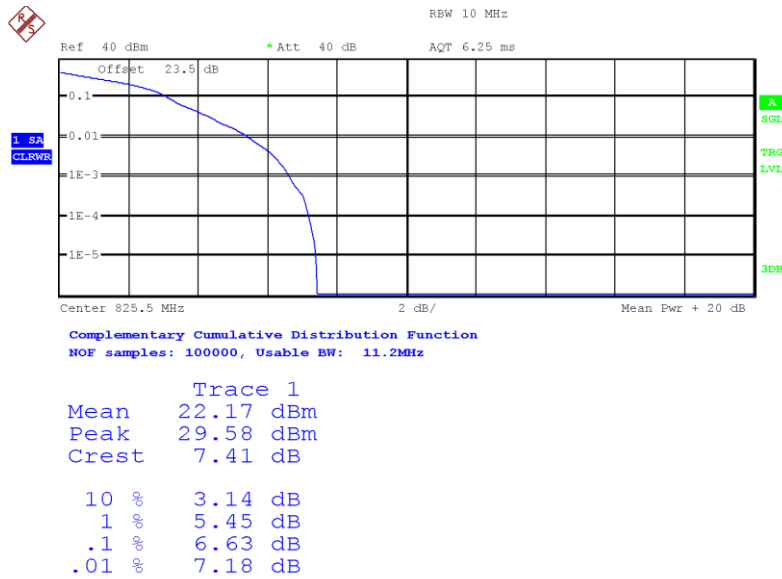

Date: 11.JAN.2023 19:53:12

Middle Channel:

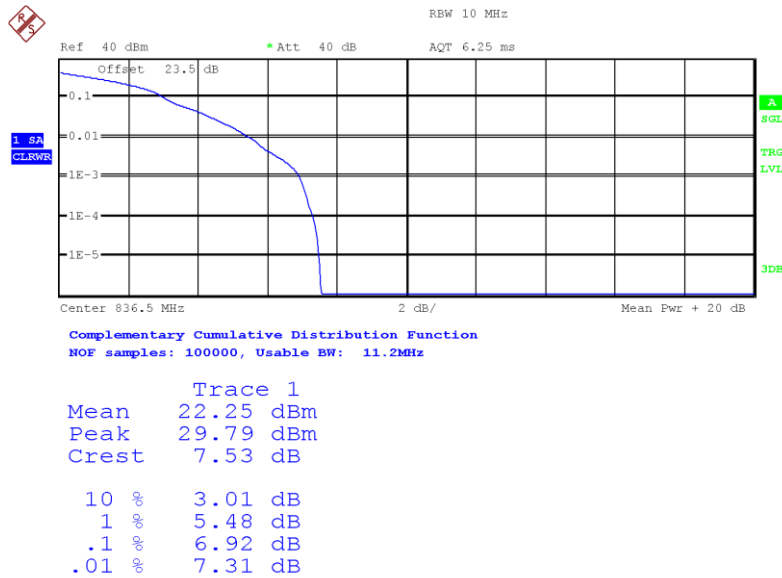

Date: 11.JAN.2023 19:56:25

High Channel:

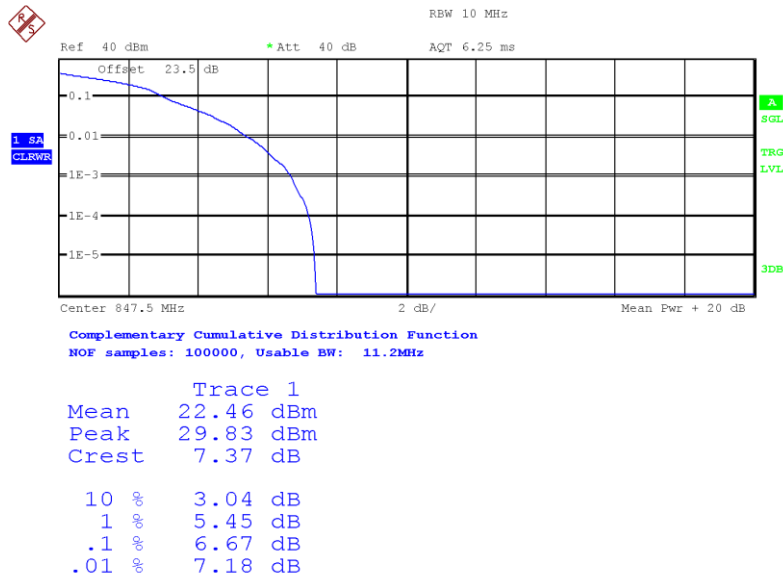

Date: 11.JAN.2023 19:59:07

LTE Band 5. BW=5 MHz. 16QAM MODULATION. RB Size: 1. RB Offset: 0.

Low Channel:

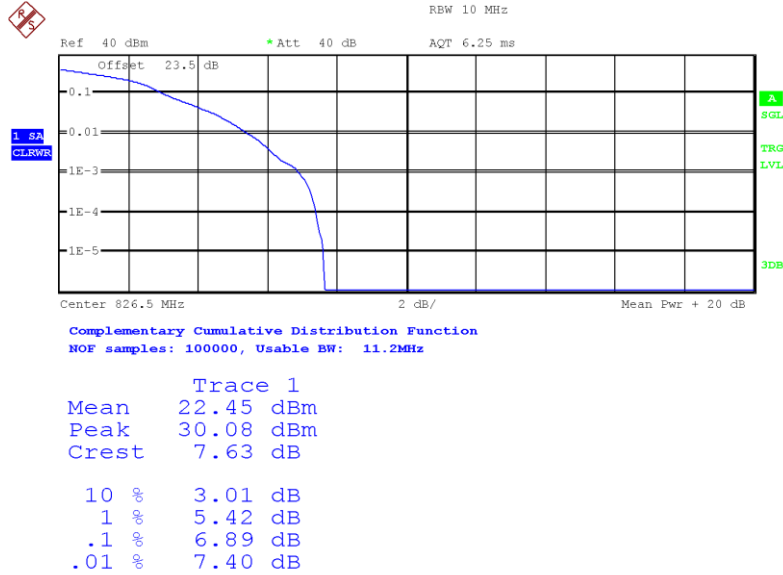

Date: 11.JAN.2023 20:28:11

Middle Channel:

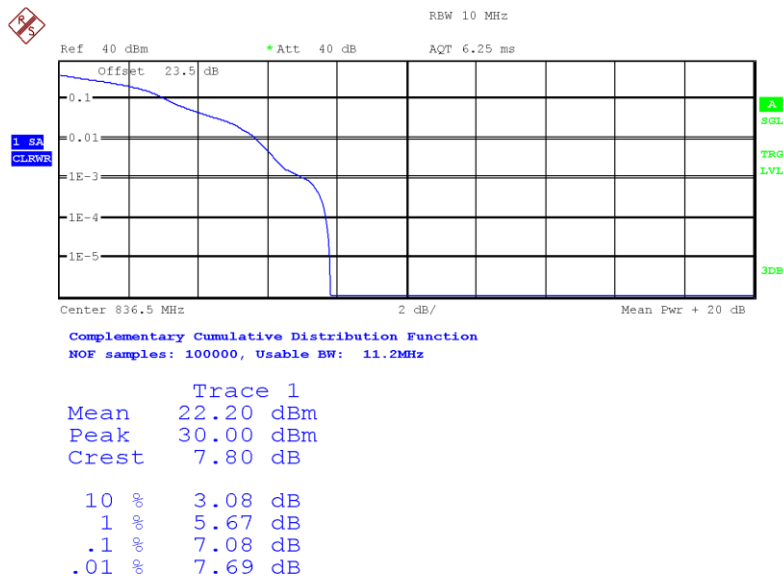

Date: 11.JAN.2023 20:11:47

High Channel:

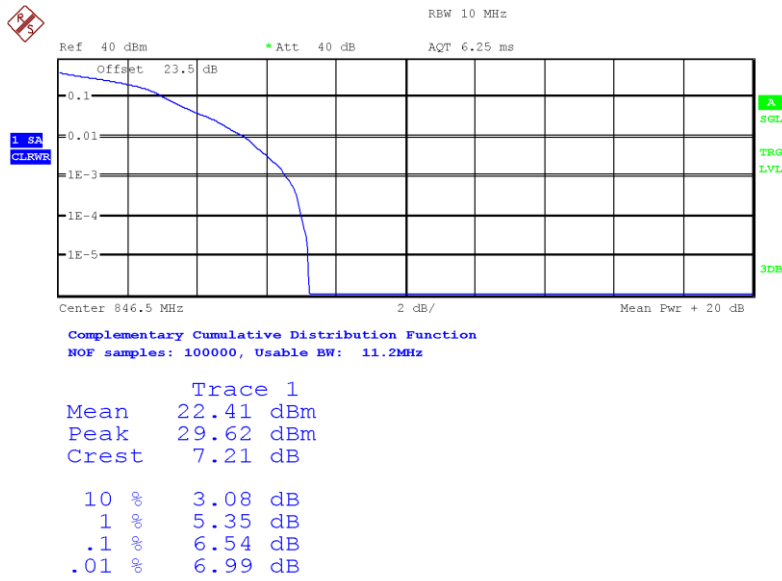

Date: 11.JAN.2023 20:21:53

LTE Band 5. BW=10 MHz. 16QAM MODULATION. RB Size: 1. RB Offset: 0.

Low Channel:

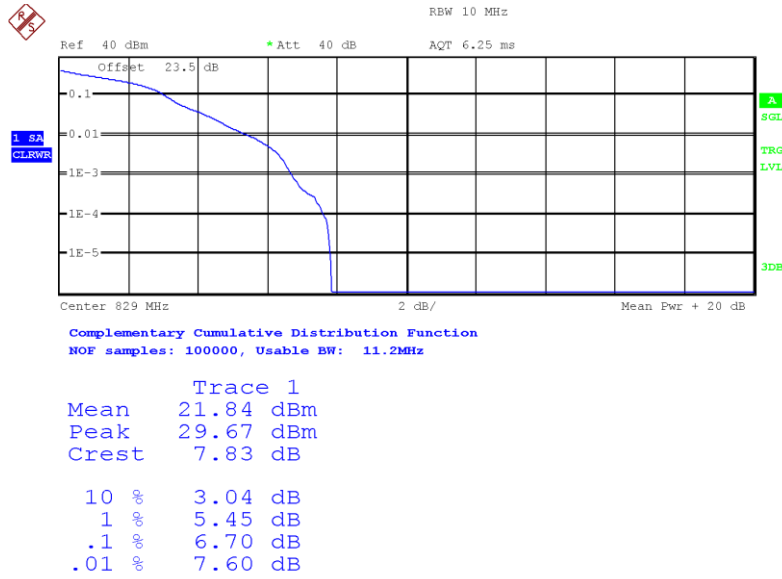

Date: 11.JAN.2023 20:45:58

Middle Channel:

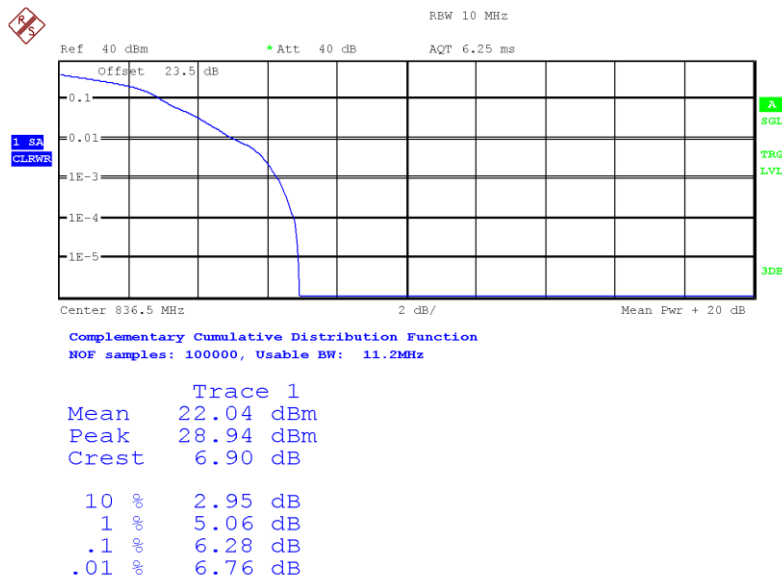

Date: 11.JAN.2023 20:36:35

High Channel:

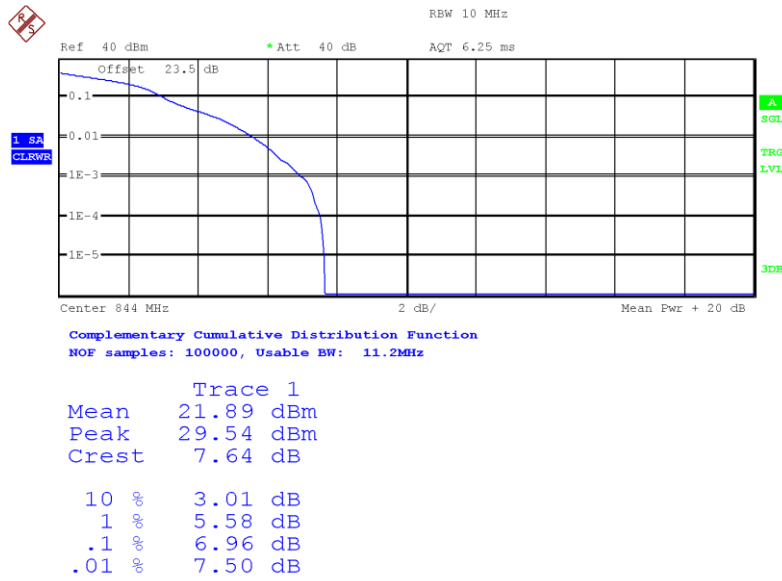

Date: 11.JAN.2023 20:42:41

Channel	Measured maximum average power at antenna port (dBm)	Maximum declared antenna gain (dBi)	Maximum equivalent isotropically radiated power E.I.R.P (dBm)	Maximum effective radiated power E.R.P (dBm)	PAPR (dB)
Low	22.56	2.2	24.56	22.41	7.6
Middle	22.55		24.55	22.4	7.69
High	22.58		24.58	22.43	7.53
Measurement uncertainty (dB)	<±0.94				

Frequency Stability

SPECIFICATION:

FCC §2.1055 and §22.355. ± 2.5 ppm for mobile stations operating in the range 821 to 896 MHz.

RSS-132. Clause 5.3. The carrier frequency shall not depart from the reference frequency in excess of ± 2.5 ppm for mobile stations.

METHOD:

The frequency tolerance measurements over temperature variations were made over the temperature range of -30°C to $+50^{\circ}\text{C}$. The EUT was placed inside a climatic chamber and the temperature was raised hourly in 10°C steps from -30°C up to $+50^{\circ}\text{C}$.

The supply voltage was varied between 85% and 115% of nominal voltage.

The EUT was set in "Radio Resource Control (RRC) mode" on the middle channel using the Universal Radio Communication tester R&S CMW500 and the maximum frequency error was measured using the built-in calibrated frequency meter.

The worst-case LTE mode for conducted power was used for the test.

In order to check that the frequency stability is sufficient such that the fundamental emissions stay within the authorized bands of operation, a reference point is established at the applicable unwanted emissions limit using a RBW equal to the RBW required by the unwanted emissions specification of the applicable regulatory standard. These reference points measured using the lowest and highest channels of operation are identified as fL and fH respectively. The worst-case frequency offset determined in the above methods is added or subtracted from the values of fL and fH to check that the resulting frequencies remain within the band.

The reference point measurements were made at the RF output terminals of the EUT using an attenuator, power splitter and spectrum analyser. The EUT was controlled via the Universal Radio Communication tester R&S CMW500 selecting maximum transmission power of the EUT and different modes of modulation.

TEST SETUP

Frequency tolerance:

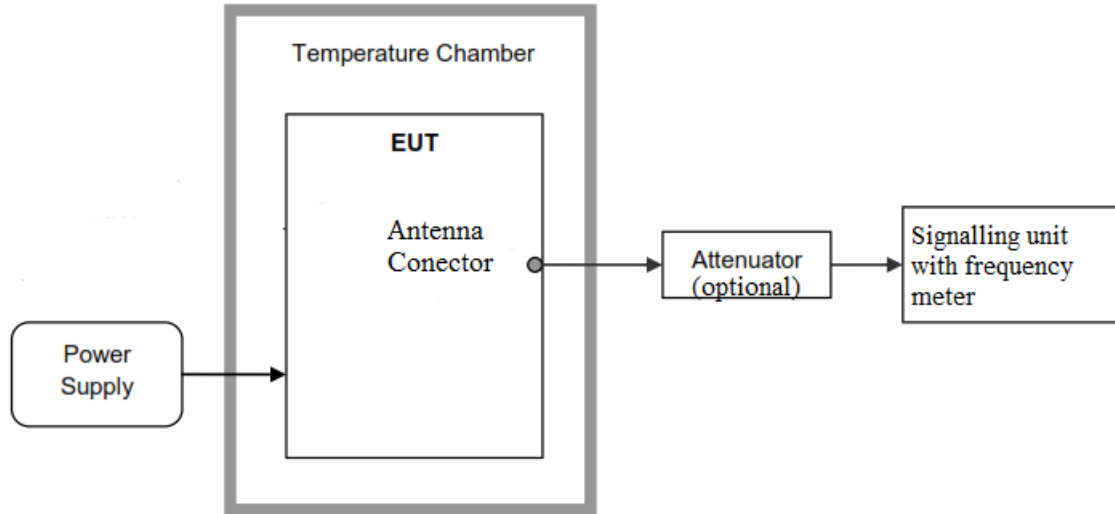

Reference points f_L and f_H :

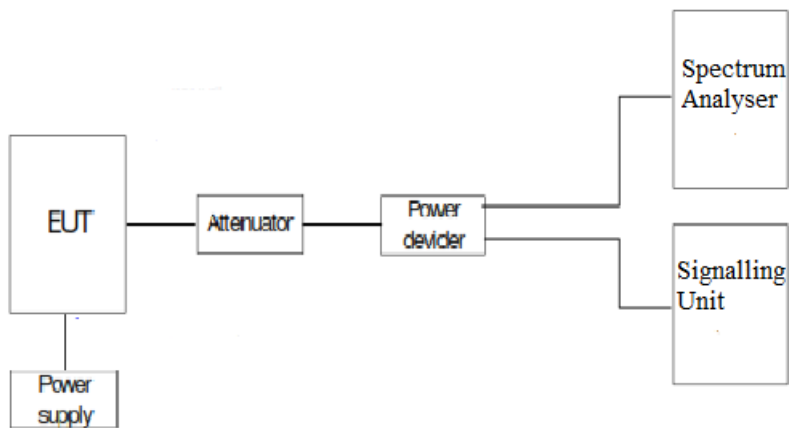

RESULTS

LTE Band 5:

1. Frequency Tolerance:

- **Frequency Stability over Temperature Variations:**

Temperature (°C)	Frequency Error (Hz)	Frequency Error (ppm)
+50	-4.55	-0.005439331
+40	-6.48	-0.007746563
+30	-5.66	-0.006766288
+20	-7.48	-0.00894202
+10	-5.02	-0.006001195
0	-5.57	-0.006658697
-10	-5.05	-0.006037059
-20	-3.14	-0.003753736
-30	-5.83	-0.006969516

- **Frequency Stability over Voltage Variations.**

Supply voltage	Voltage (V)	Frequency Error (Hz)	Frequency Error (ppm)
Vmax	240	-8.1	-0.009683204
Vmin	110	-7.22	-0.008631201

2. Reference Frequency Points fL and fH:

The worst-case frequency offsets added or subtracted per band and bandwidth:

QPSK. Nominal Bandwidth 5 MHz.

fL (MHz)	824.002000
fH (MHz)	848.995000

The reference frequency points fL and fH stay within the authorized blocks for the band above.

Measurement uncertainty (Hz) $< \pm 249.55$

Verdict: PASS

Modulation Characteristics

SPECIFICATION:

FCC §2.1047.

RSS-132. Clause 5.2: Equipment certified under this standard shall use digital modulation.

METHOD:

For LTE the EUT operates with QPSK and 16QAM modulation modes in which the information is digitized and coded into a bit stream. The RF transmission is multiplexed using *Orthogonal Frequency Division Multiplexing (OFDM)* using different possible arrangement of subcarriers (Resource Blocks RB).

TEST SETUP:

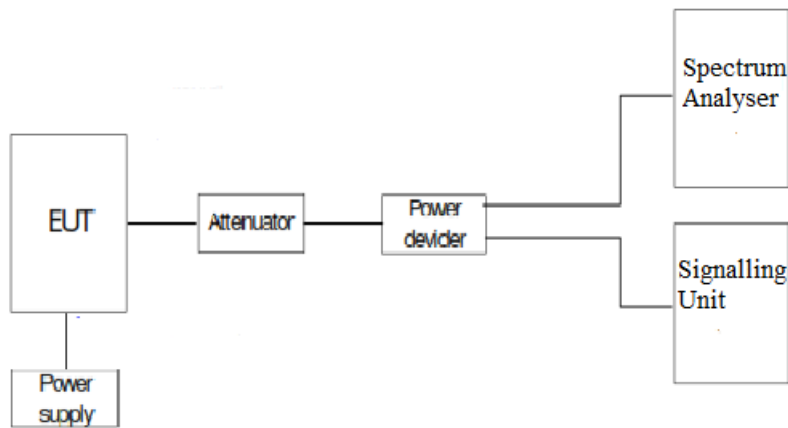

RESULTS:

The following plots show the modulation schemes in the EUT.

LTE Band 5. QPSK MODULATION. BW = 1.4 MHz.

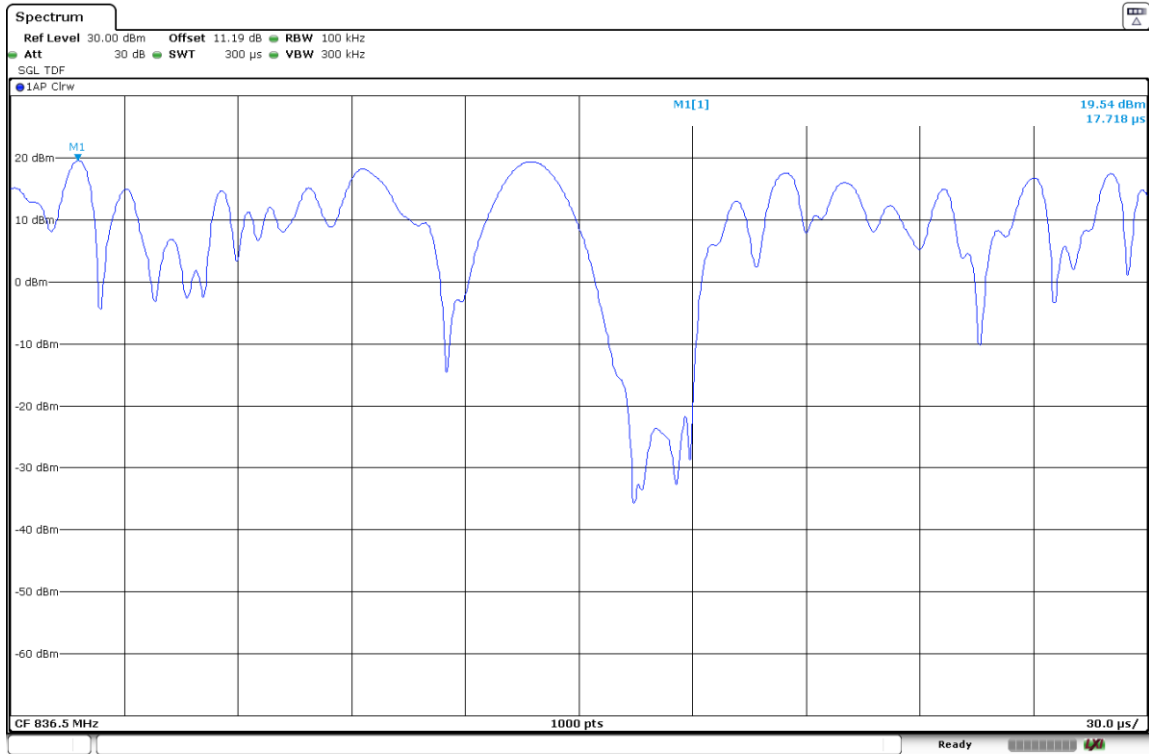

LTE Band 5. 16QAM MODULATION. BW = 1.4 MHz.

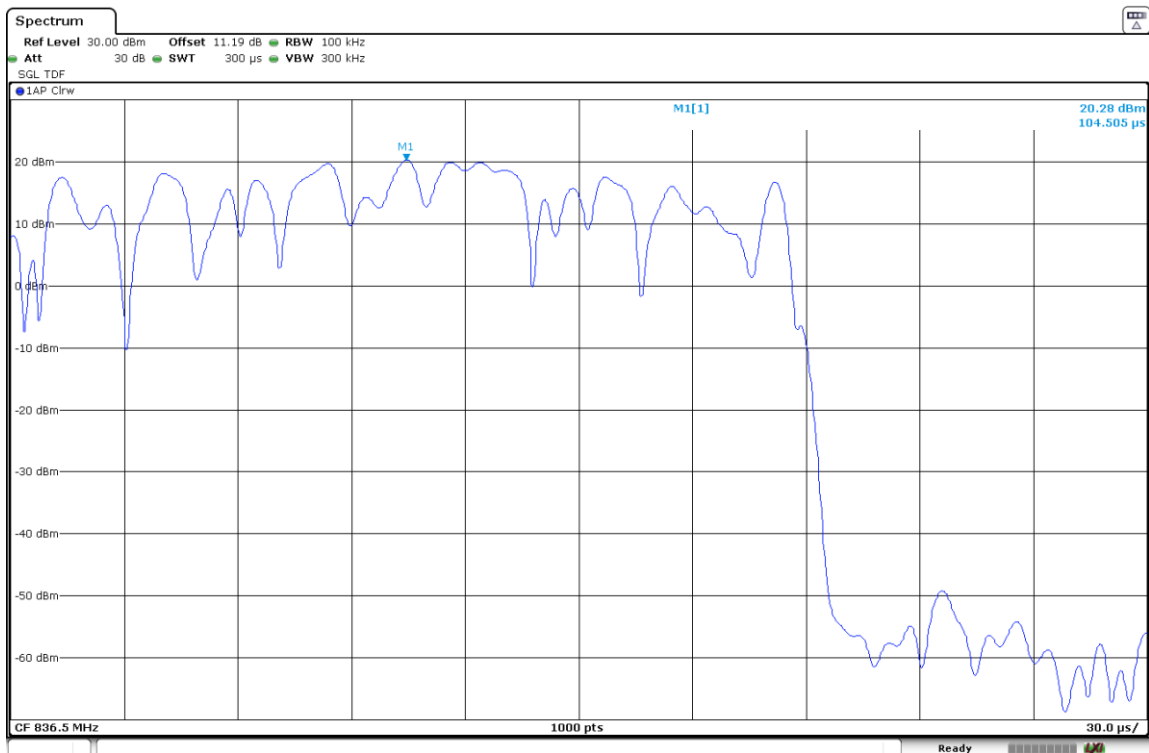

Occupied Bandwidth

SPECIFICATION:

FCC §2.1049. Measurements required: Occupied bandwidth.

RSS-Gen, Clause 6.7.

METHOD:

The occupied bandwidth measurement was performed at the output terminals of the EUT using an attenuator, power splitter and spectrum analyser. The EUT was controlled via the Universal Radio Communication tester R&S CMW500 selecting maximum transmission power of the EUT and different modes of modulation. The 99% occupied bandwidth and the -26 dBc bandwidth were measured directly using the built-in bandwidth measuring option of spectrum analyser.

TEST SETUP:

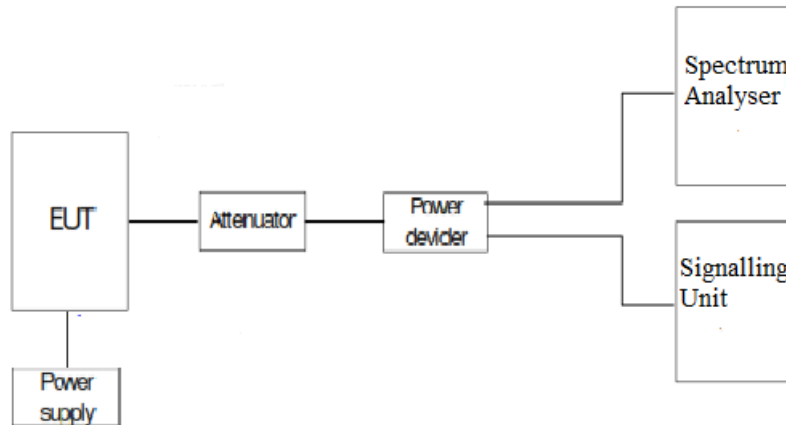

RESULTS:

The worst case per modulation is:

LTE Band 5:

LTE Band 5. QPSK MODULATION. Nominal Bandwidth 1.4 MHz. RB Size 6. Offset 0. Narrowband 0. Position 1.

	Low Channel	Middle Channel	High Channel
99% Occupied Bandwidth (MHz)	1.11150	1.11250	1.10900
-26 dBc Bandwidth (MHz)	1.43433	1.39144	1.54250
Measurement uncertainty (kHz)	<±3.75		

LTE Band 5. 16QAM MODULATION. Nominal Bandwidth 1.4 MHz. RB Size 5. Offset 0. Narrowband 0. Position 1.

	Low Channel	Middle Channel	High Channel
99% Occupied Bandwidth (MHz)	0.94400	0.94200	0.94300
-26 dBc Bandwidth (MHz)	1.36759	1.30180	1.28703
Measurement uncertainty (kHz)	<±3.75		

LTE Band 5. QPSK MODULATION. Nominal Bandwidth 1.4 MHz. RB Size 6. Offset 0. Narrowband 0. Position 1.

Low Channel:

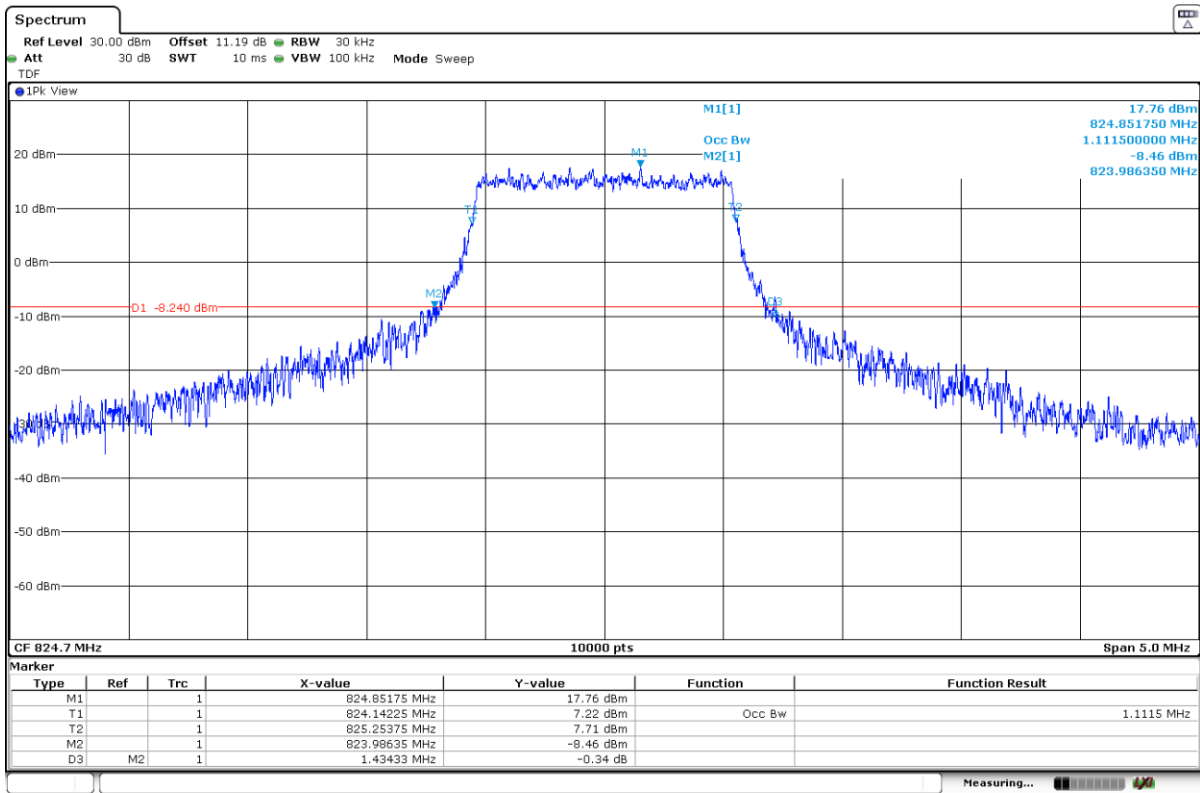

Middle Channel:

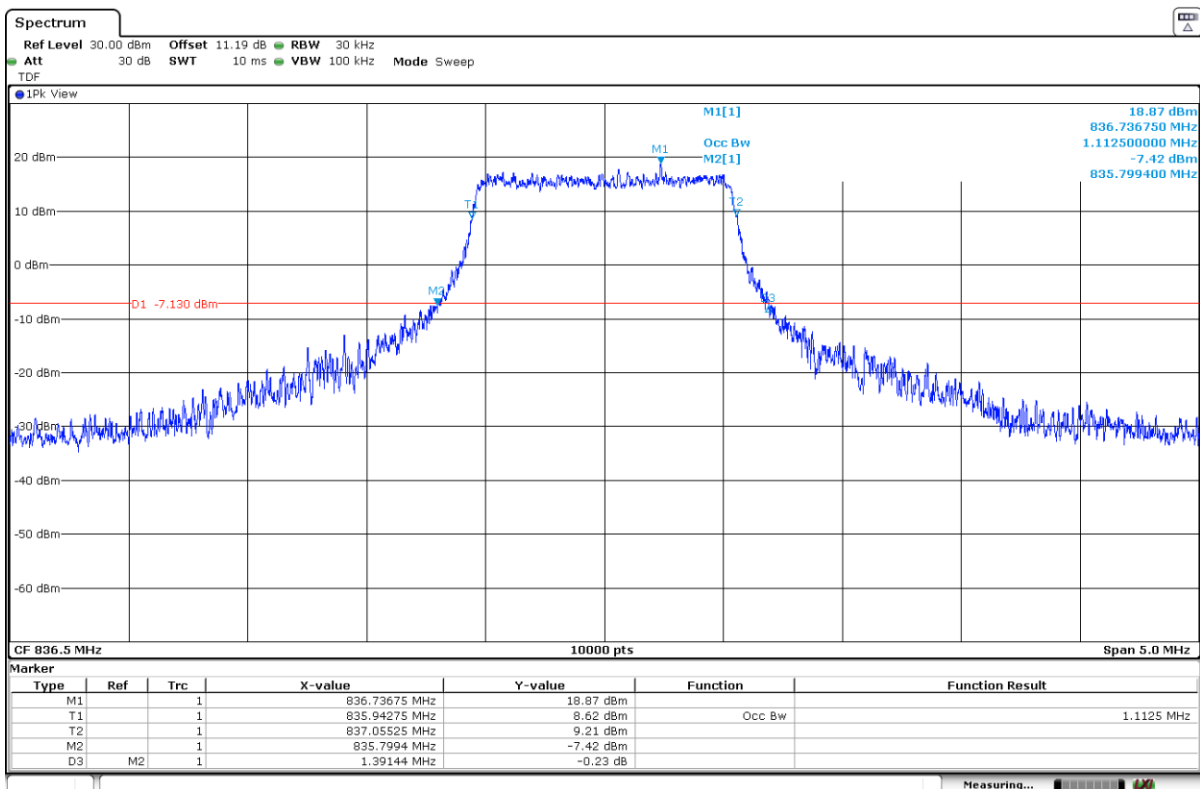

High Channel:

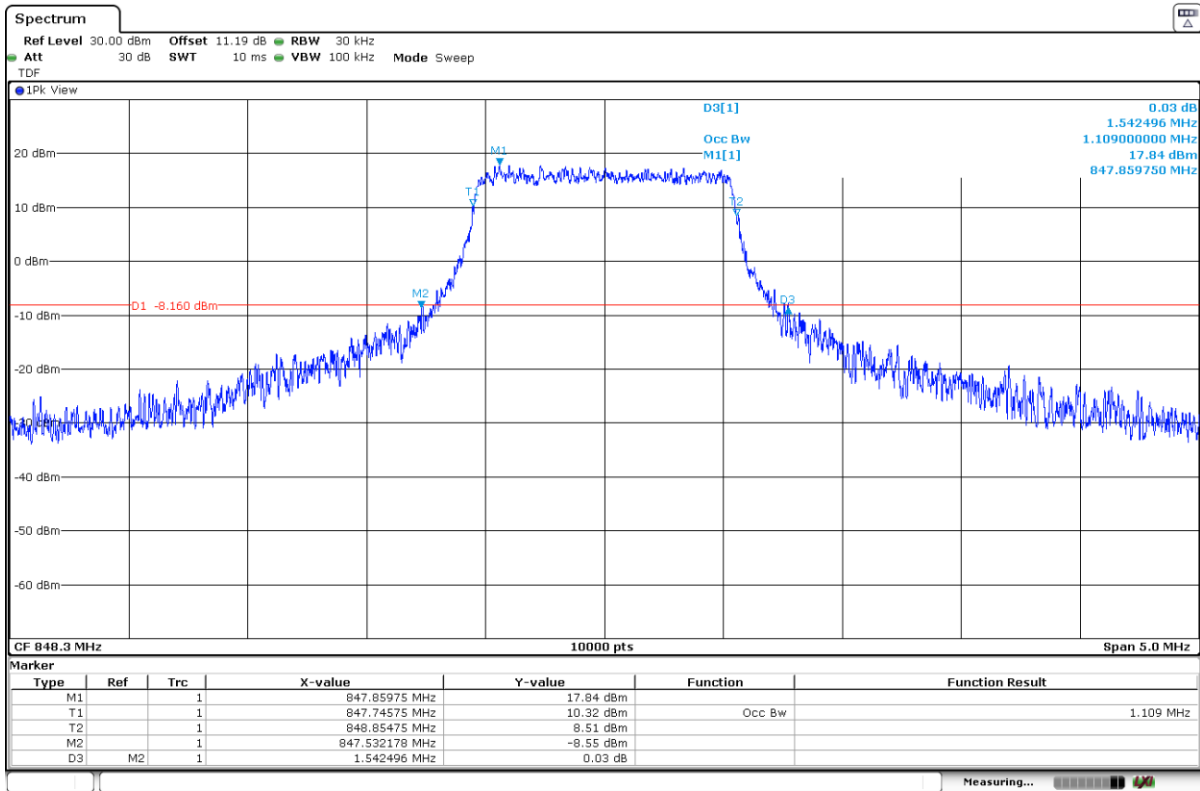

LTE Band 5. 16QAM MODULATION. Nominal Bandwidth 1.4 MHz. RB Size 5. Offset 0. Narrowband 0. Position 1.

Low Channel:

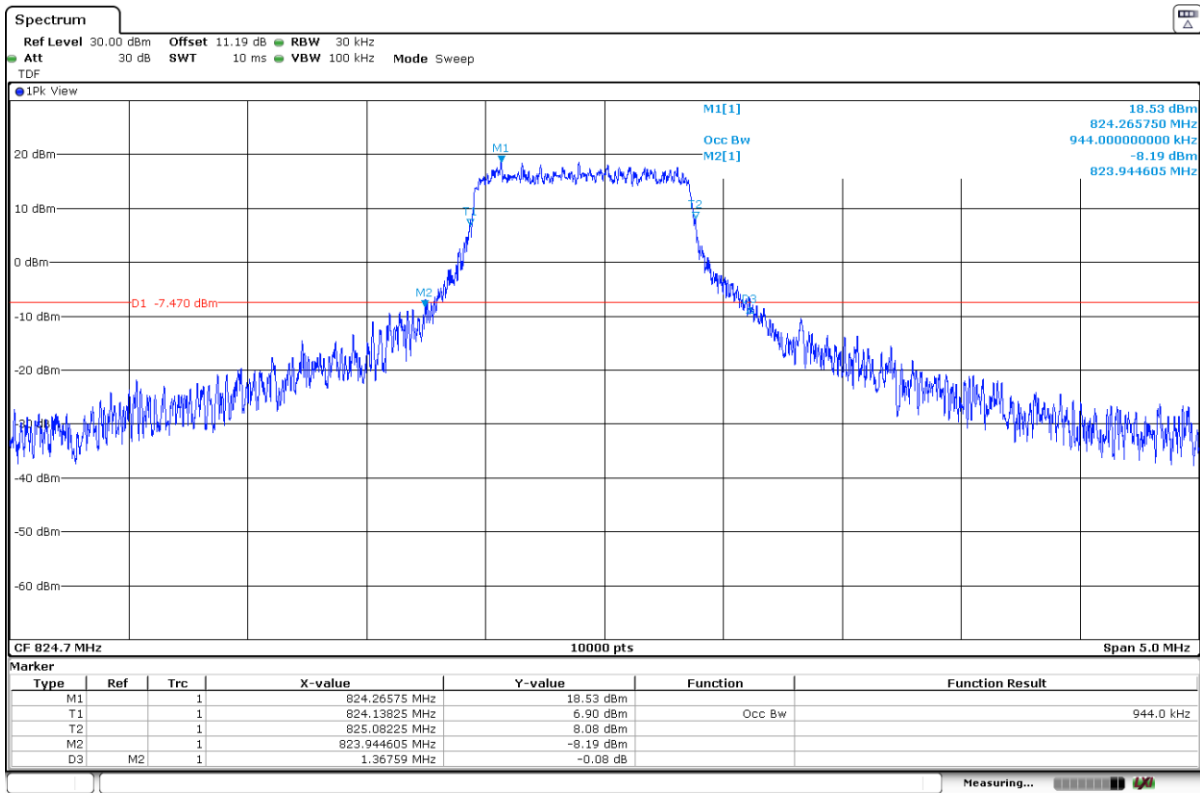

Middle Channel:

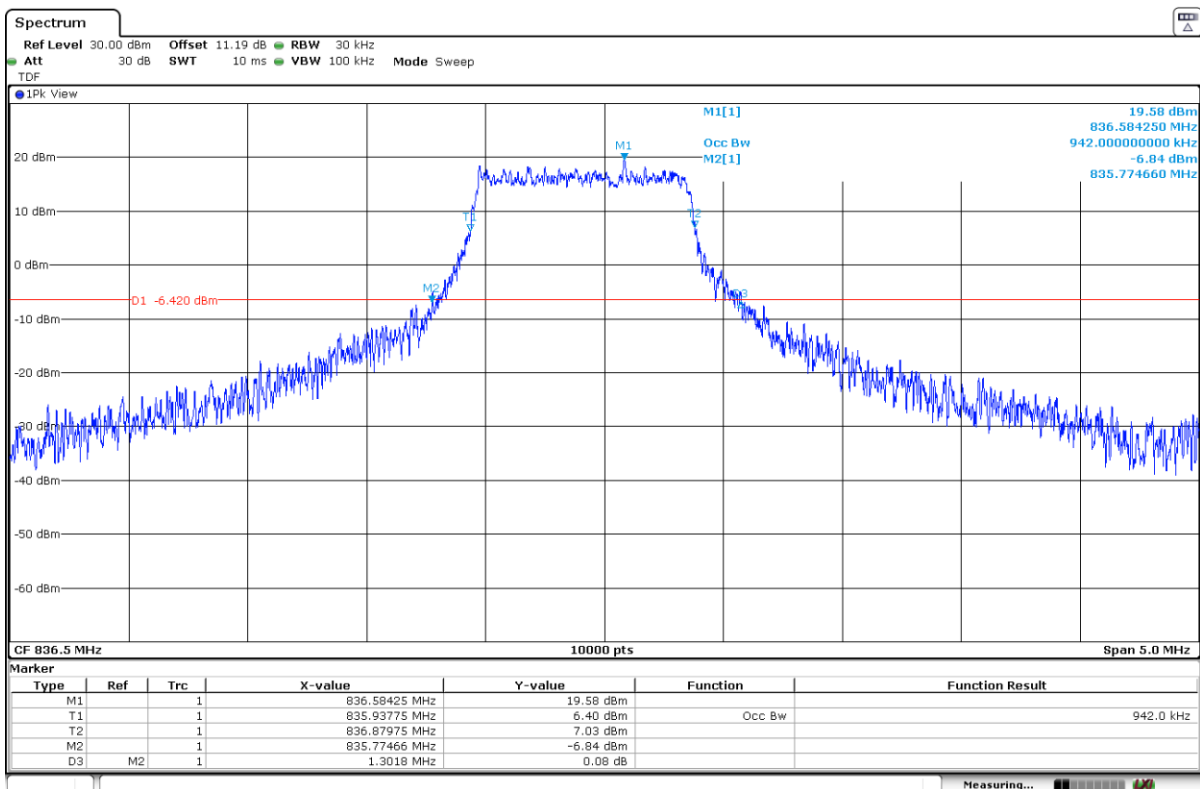

High Channel:

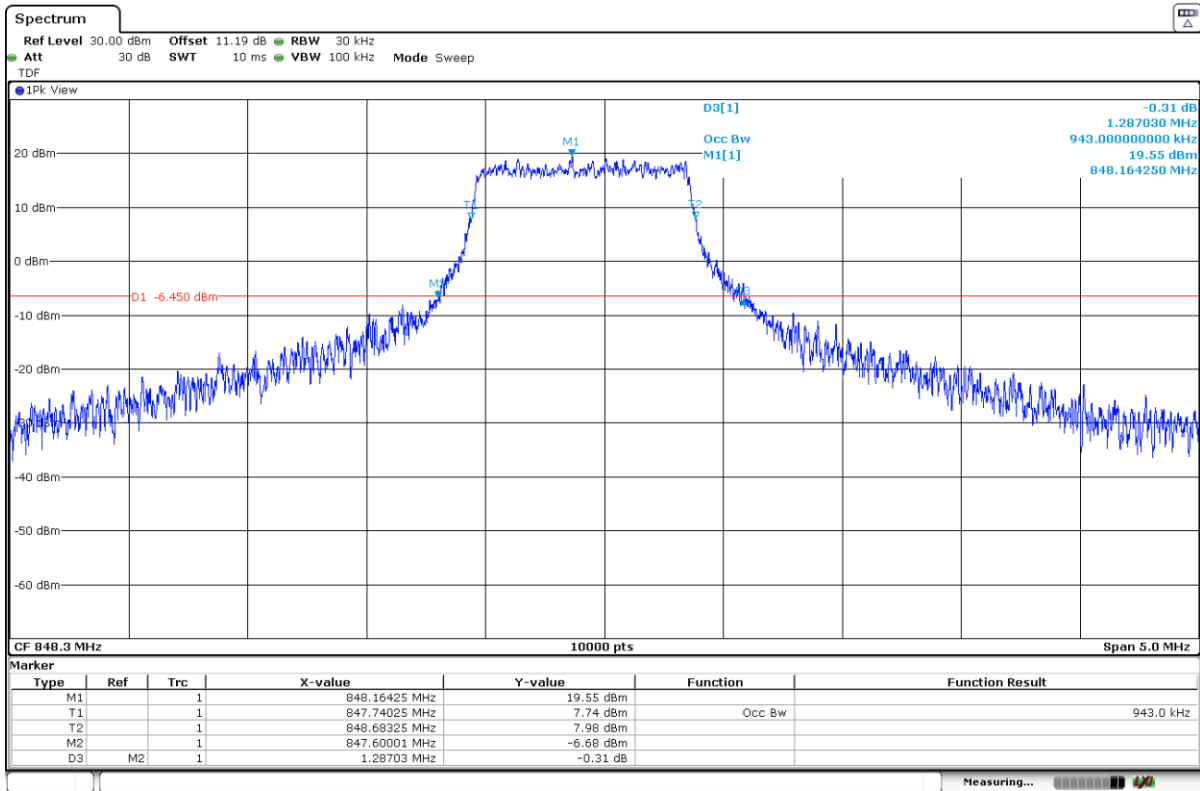

Spurious Emissions at Antenna Terminals

SPECIFICATION:

FCC §2.1051 and §22.917. RSS-132 Clause 5.5.

The power of emissions shall be attenuated below the transmitter power (P) by a factor of at least $43 + 10 \log (P)$ dB. P in watts.

In the spectrum below 1 GHz, instrumentation should employ a reference bandwidth of 100 kHz or greater.
In the spectrum above 1 GHz, instrumentation should employ a reference bandwidth of 1 MHz.

At P_o transmitting power, the specified minimum attenuation becomes $43+10 \log (P_o)$, and the level in dBm relative to P_o becomes:

$$P_o \text{ (dBm)} - [43 + 10 \log (P_o \text{ in mW}) - 30] = -13 \text{ dBm}$$

METHOD:

The EUT RF output connector was connected to a spectrum analyser and to the Universal Radio Communication tester R&S CMW500 (selecting maximum transmission power of the EUT and different modes of modulation) using a 50-Ohm attenuator and a power divider.

The spectrum was investigated from 9 kHz to 8.5 GHz.

The reading of the spectrum analyser is corrected with the attenuation loss of connection between output terminal of EUT and input of the spectrum analyser.

The configuration of Resource Blocks and modulation which is the worst case for conducted power was used.

TEST SETUP:

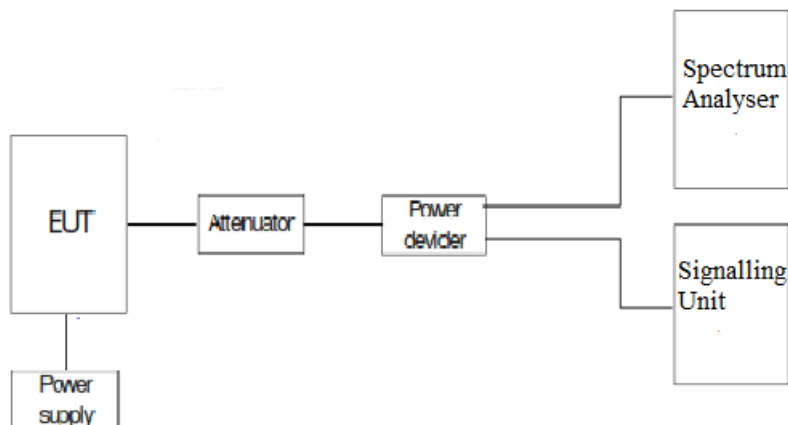

RESULTS:

LTE Band 5: 16QAM. Nominal Bandwidth 3 MHz. RB Size 5. Offset 0. Narrowband 0. Position 1.

- Low Channel: Spurious frequencies at less than 20 dB below the limit:

Frequency (MHz)	Emission limitations conducted (dBm)
1648.609	-27.89

- Middle Channel: Spurious frequencies at less than 20 dB below the limit:

Frequency (MHz)	Emission limitations conducted (dBm)
1672.649	-28.75

- High Channel: Spurious frequencies at less than 20 dB below the limit:

Frequency (MHz)	Emission limitations conducted (dBm)
1695.929	-25.59
2543.249	-31.84

Measurement uncertainty (dB): ± 2.76

Verdict: PASS

LTE Band 5: 16QAM. Nominal Bandwidth 3 MHz. RB Size 5. Offset 0. Narrowband 0. Position 1.

Low Channel:

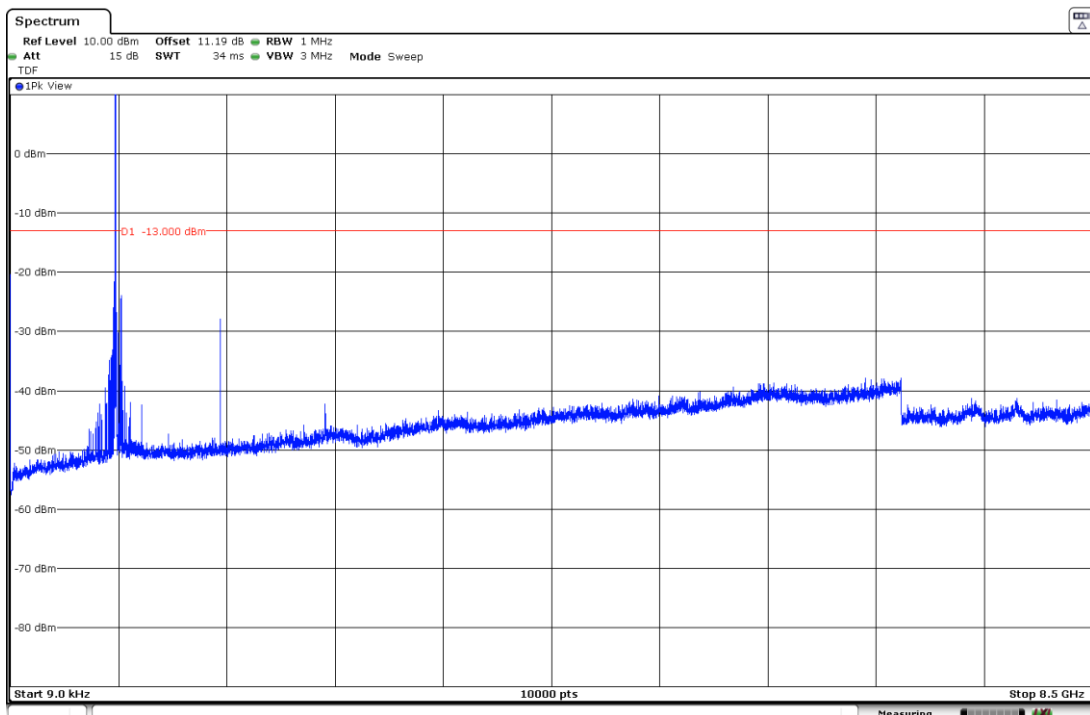

Middle Channel:

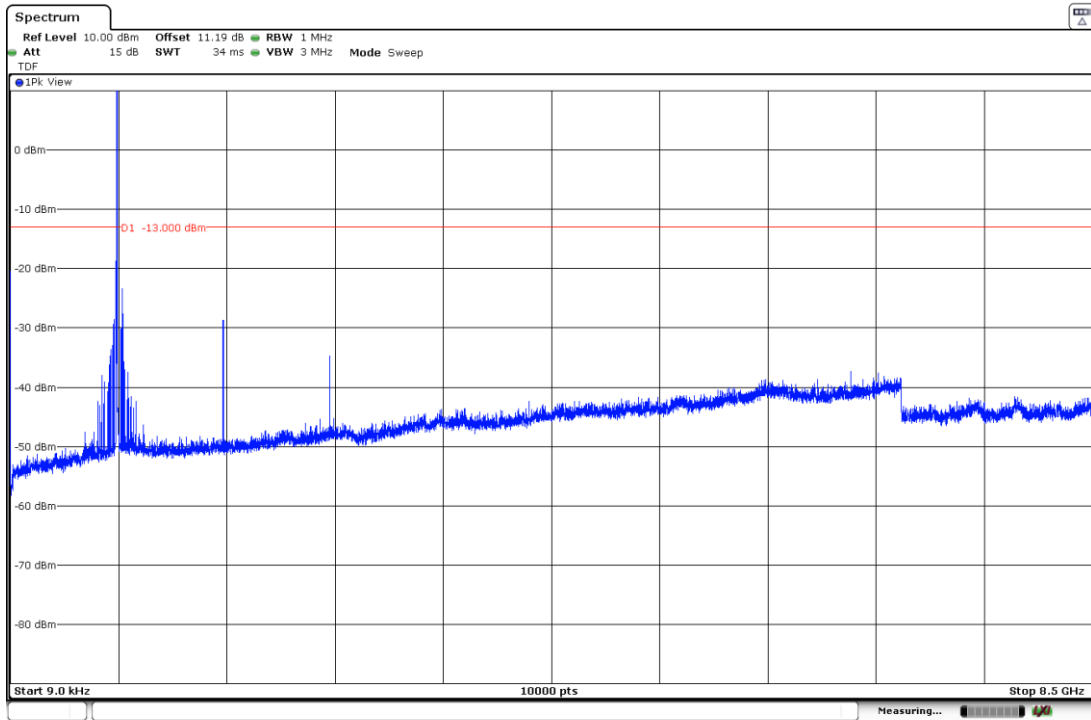

High Channel:

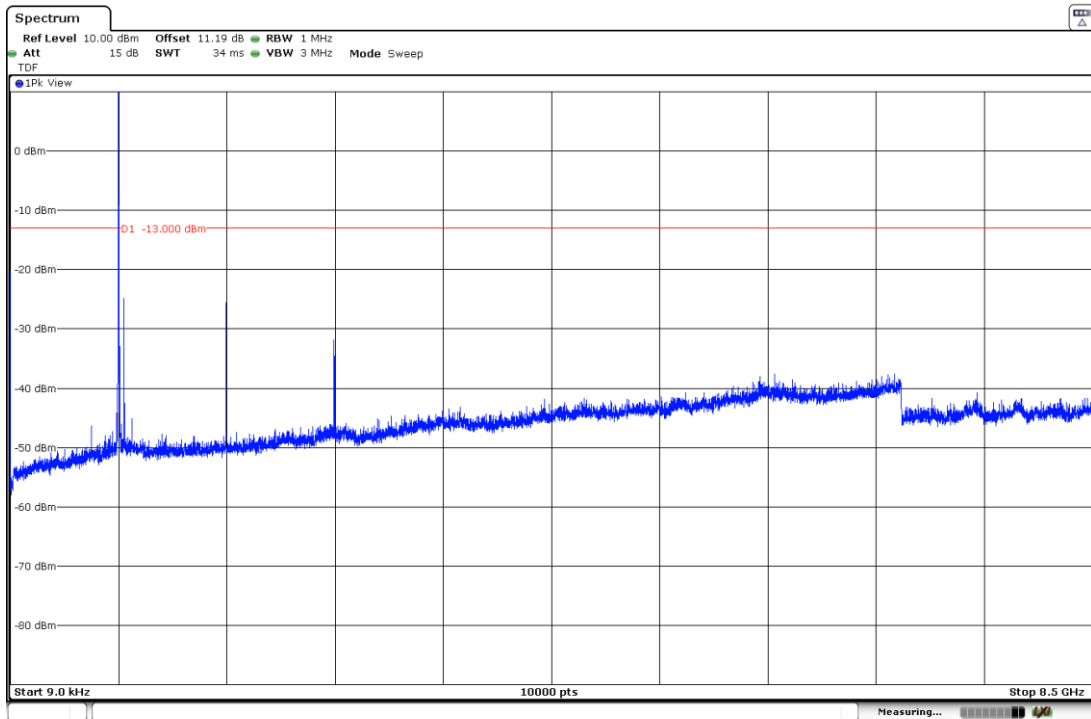

Measurement uncertainty (dB): $< \pm 2.76$

Verdict: PASS

Spurious Emissions at Antenna Terminals at Block Edges

Limits:

FCC § 2.1051 and § 22.917:

The power of any emission outside of the authorized operating frequency ranges must be attenuated below the transmitting power (P) by a factor of at least $43 + 10 \log(P)$ dB.

Compliance with these rules is based on the use of measurement instrumentation employing a reference bandwidth as follows:

In the spectrum below 1 GHz, instrumentation should employ a reference bandwidth of 100 kHz or greater. In the 1 MHz bands immediately outside and adjacent to the frequency block, a resolution bandwidth of at least one percent of the emission bandwidth of the fundamental emission of the transmitter may be employed.

RSS-132. Clause 5.5:

Mobile and base station equipment shall comply with the limits below.

In the first 1.0 MHz band immediately outside and adjacent to each of the sub-bands, the power of emissions per any 1% of the occupied bandwidth shall be attenuated (in dB) below the transmitter output power P (dBW) by at least $43 + 10 \log 10 p$ (watts).

Method:

The EUT RF output connector was connected to a spectrum analyzer and to the Universal Radio Communication tester R&S CMW500 (selecting maximum transmission power of the EUT and different modes of modulation) using a 50-Ohm attenuator and a power splitter.

The reading of the spectrum analyser is corrected with the path loss of the connection between the output terminal of the EUT and the input of the spectrum analyzer.

The configuration of modulation which is the worst case for conducted power was used.

As stated in FCC part 22.917 / RSS-132 Clause 5.5, in the 1 MHz bands immediately outside and adjacent to the frequency block or band a resolution bandwidth of at least one percent of the emission bandwidth of the fundamental emission of the transmitter may be employed.

Measurement Limit:

At P_o transmitting power, the specified minimum attenuation $43 + 10 \log_{10} p$ (watts) becomes:

$$P_o \text{ (dBm)} - [43 + 10 \log (P_o \text{ in mwatts}) - 30] = -13 \text{ dBm}$$

Test setup:

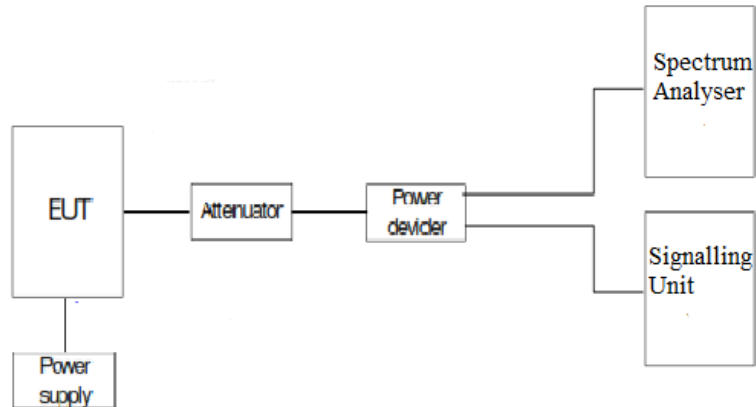

Results:

LTE Band 5:

Preliminary measurements determined the Nominal Bandwidth 1.4 MHz, QPSK modulation as the worst case. Results attached are for this worst-case configuration.

Measurement uncertainty (dB): $<\pm 2.76$

Verdict

Pass

Attachments

824-849 MHz Band (Band 5). Band edge:

Narrowband = 1. RB = 1. Offset = 0. BW = 1.4 MHz.

Low Channel:

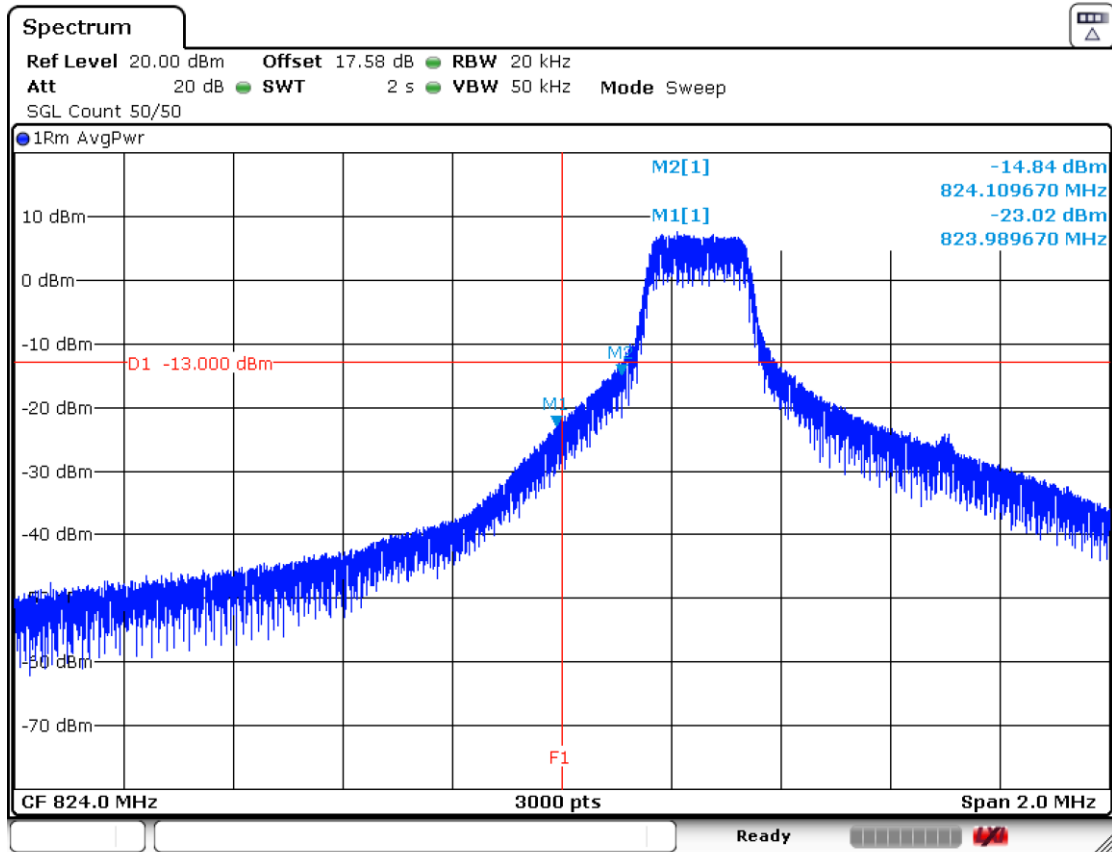

Date: 25.JAN.2023 18:51:35

Narrowband = 1. RB = 1. Offset = Max. BW = 1.4 MHz.

High Channel:

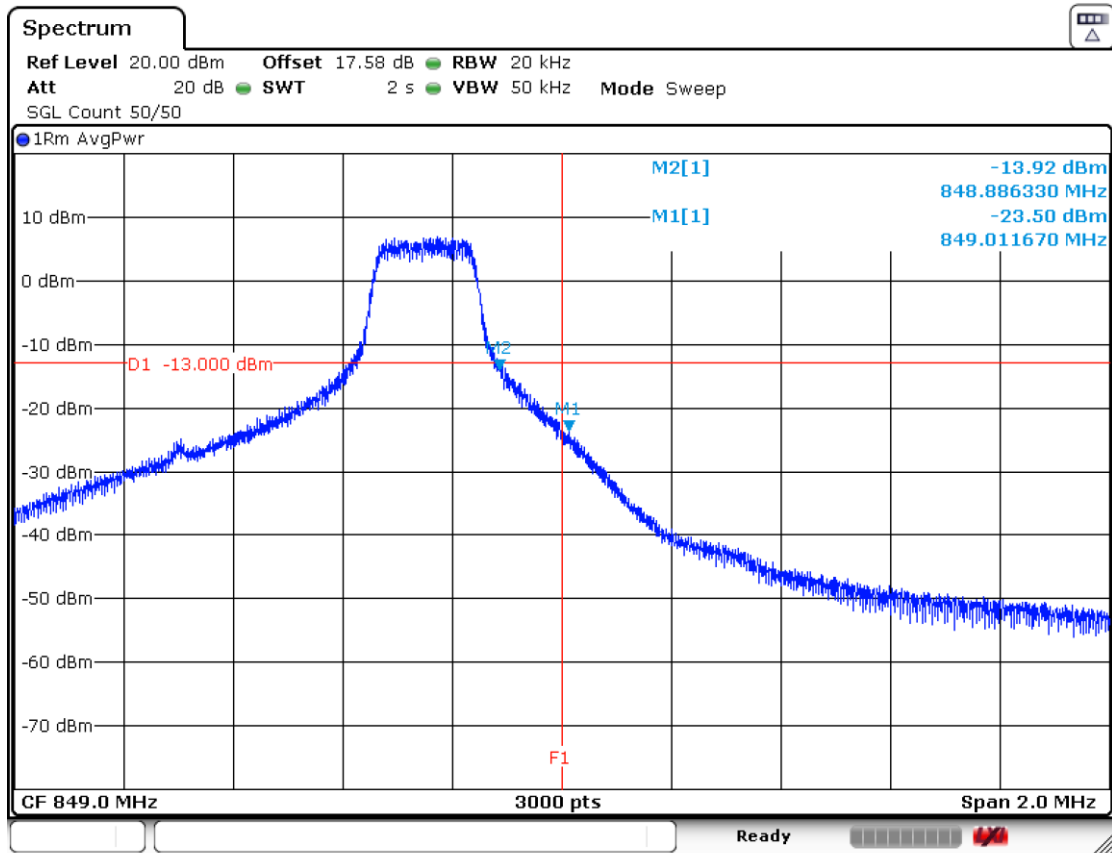

Date: 25. JAN. 2023 19:33:38

Narrowband = 1. RB = All. Offset = 0. BW = 1.4 MHz.

Low Channel:

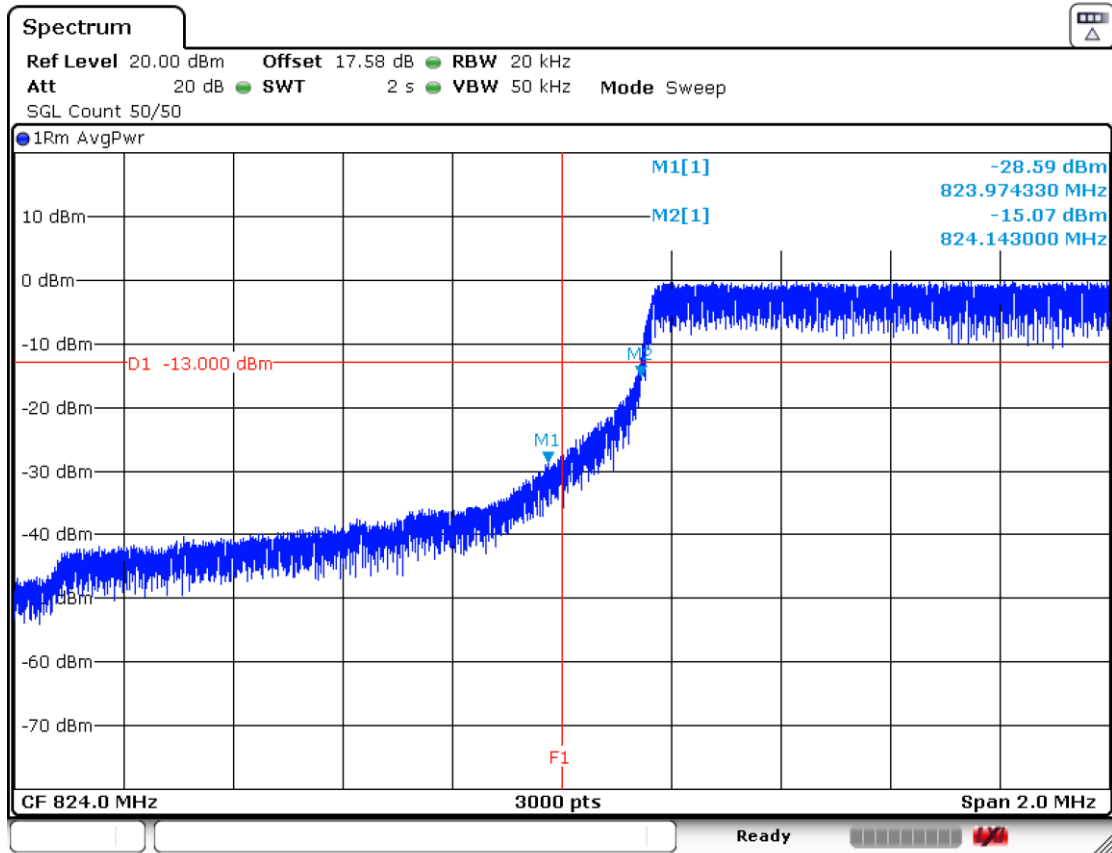

Date: 25.JAN.2023 19:40:21

Narrowband = 1. RB = All. Offset = 0. BW = 1.4 MHz.

High Channel:

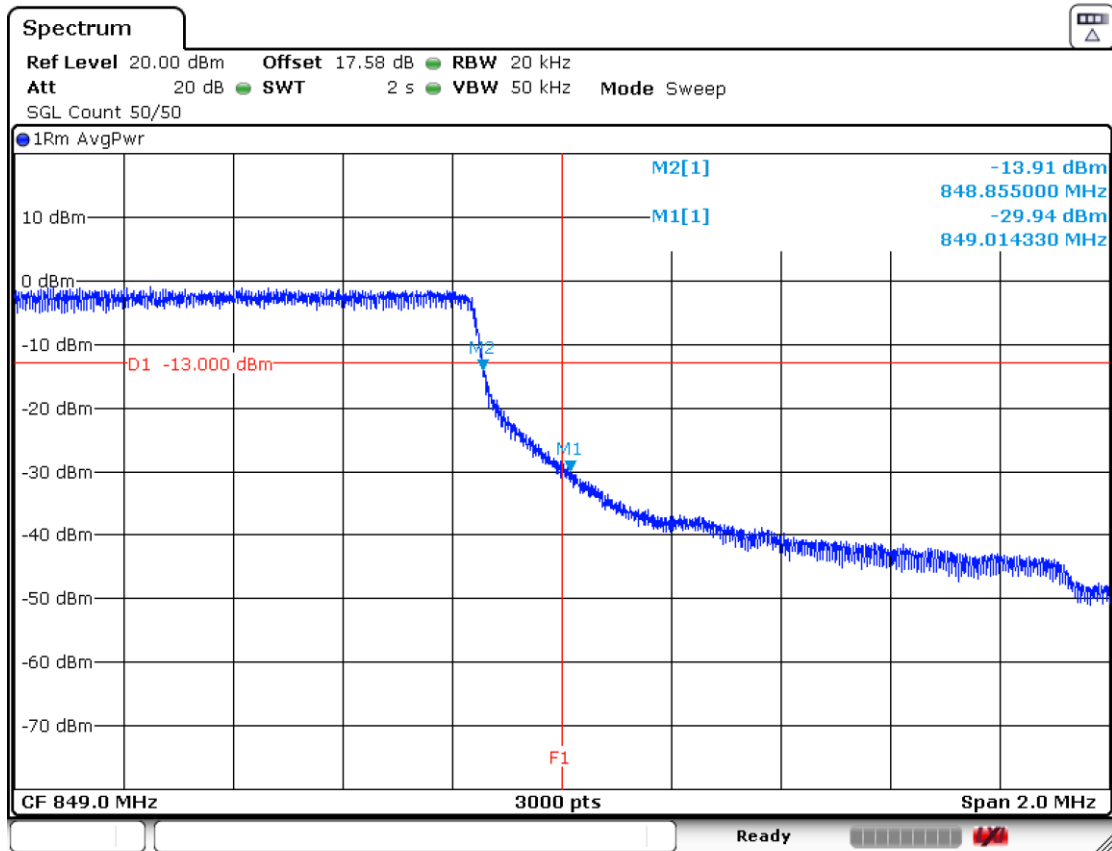

Date: 25.JAN.2023 19:26:21

Radiated Emissions

SPECIFICATION:

- * FCC §2.1051 and §22.917: The power of any emission outside of the authorized operating frequency ranges must be attenuated below the transmitting power (P) by a factor of at least $43 + 10 \log(P)$ dB.
- * RSS-132. 5.5: Mobile and base station equipment shall comply with the limits in (i) and (ii) below.
- i. In the first 1.0 MHz band immediately outside and adjacent to each of the sub-bands specified in Section 5.1, the power of emissions per any 1% of the occupied bandwidth shall be attenuated (in dB) below the transmitter output power P (dBW) by at least $43 + 10 \log_{10} P$ (watts).
 - ii. After the first 1.0 MHz immediately outside and adjacent to each of the sub-bands, the power of emissions in any 100 kHz bandwidth shall be attenuated (in dB) below the transmitter output power P (dBW) by at least $43 + 10 \log_{10} P$ (watts). If the measurement is performed using 1% of the occupied bandwidth, power integration over 100 kHz is required.

METHOD:

The measurement was performed with the EUT inside an anechoic chamber. The spectrum was scanned from 30 MHz to at least the 10th harmonic of the highest frequency generated within the equipment.

The EUT was placed on a 1 meter high non-conductive stand at a 3 meter distance from the measuring antenna. Detected emissions were maximized at each frequency by rotating the EUT and adjusting the height and polarization of the measuring antenna. The maximum meter reading was recorded.

Measurement Limit:

According to specification, the power of emissions shall be attenuated below the transmitter power (P) by a factor of at least $43 + 10 \log (P)$ dB, P in watts.

At P_o transmitting power, the specified minimum attenuation becomes $43+10\log (P_o)$, and the level in dBm relative P_o becomes:

$$P_o \text{ (dBm)} - [43 + 10 \log (P_o \text{ in mwatts}) - 30] = - 13 \text{ dBm}$$

The maximum field strength (dB μ V/m) of each detected emission at less than 20 dB respect to the limit is converted to an equivalent EIRP level (dBm) according to ANSI C63.26 with the formula:

$EIRP \text{ (dBm)} = E \text{ (dB}\mu\text{V/m)} + 20 \log(D) - 104.8$; where D is the measurement distance (in the far field region) in m. D = 3 m

TEST SETUP:

Radiated measurements below 1 GHz:

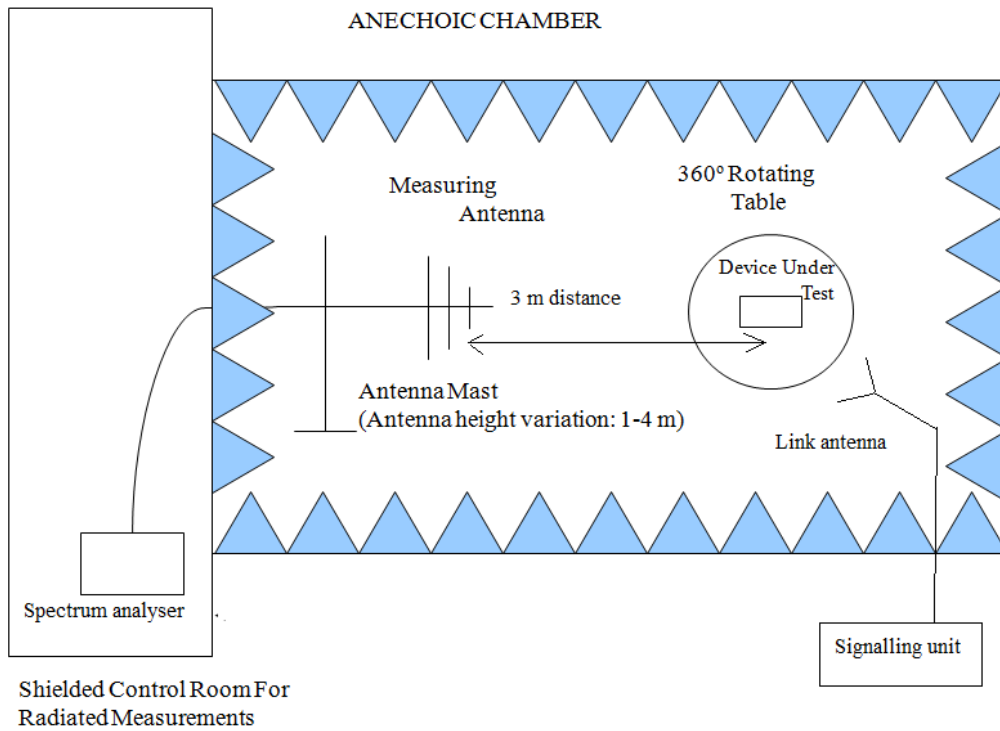

Radiated measurements above 1 GHz:

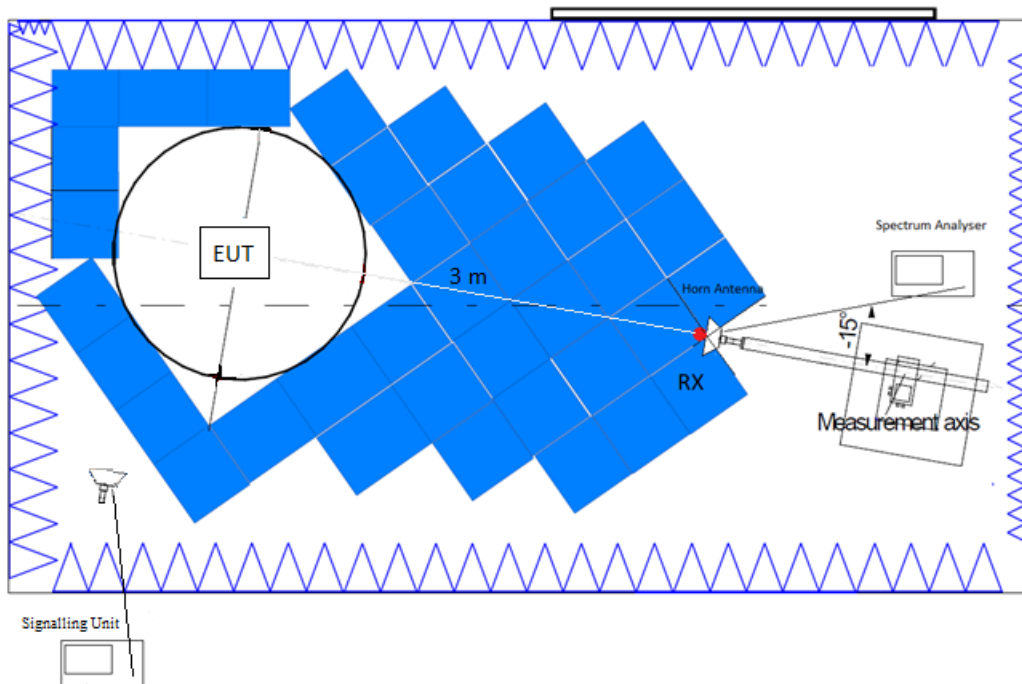

RESULTS:

LTE Band 5:

QPSK modulation:

A preliminary scan determined the QPSK modulation, BW=1.4 MHz, RB Size=1, RB Offset=0, Narrowband=0 as the worst case. The following tables and plots show the results for the worst case modulation.

- LOW CHANNEL:

Frequency range 30 MHz - 1 GHz

No spurious frequencies at less than 20 dB below the limit.

Frequency range 1 - 8.5 GHz

No spurious frequencies at less than 20 dB below the limit.

- MIDDLE CHANNEL:

Frequency range 30 MHz - 1 GHz

No spurious frequencies at less than 20 dB below the limit.

Frequency range 1 - 8.5 GHz

No spurious frequencies at less than 20 dB below the limit.

- HIGH CHANNEL:

Frequency range 30 MHz - 1 GHz

No spurious frequencies at less than 20 dB below the limit.

Frequency range 1 - 8.5 GHz

No spurious frequencies at less than 20 dB below the limit.

Measurement uncertainty (dB): $<\pm 5.35$ for $f \geq 30$ MHz up to 1 GHz
 $<\pm 4.32$ for $f \geq 1$ GHz up to 8.5 GHz

Verdict: PASS

Subrange	Step Size	Detectors	Bandwidth	Sweep Time	Preamp
Receiver: [ESW 44]					
30 MHz - 1 GHz	30,312 kHz	PK+	1 MHz	1 s	0 dB
1 GHz - 8.5 GHz	234,375 kHz	PK+	1 MHz	1 s	0 dB

FREQUENCY RANGE 30 MHz - 1 GHz:

- Low Channel:

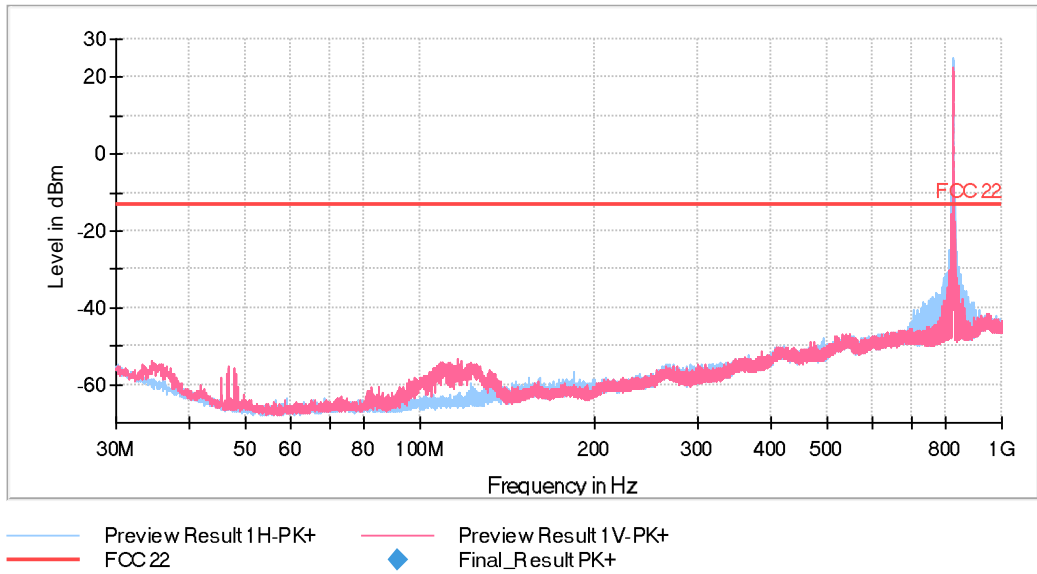

The peak above the limit is the carrier frequency.

- Middle Channel:

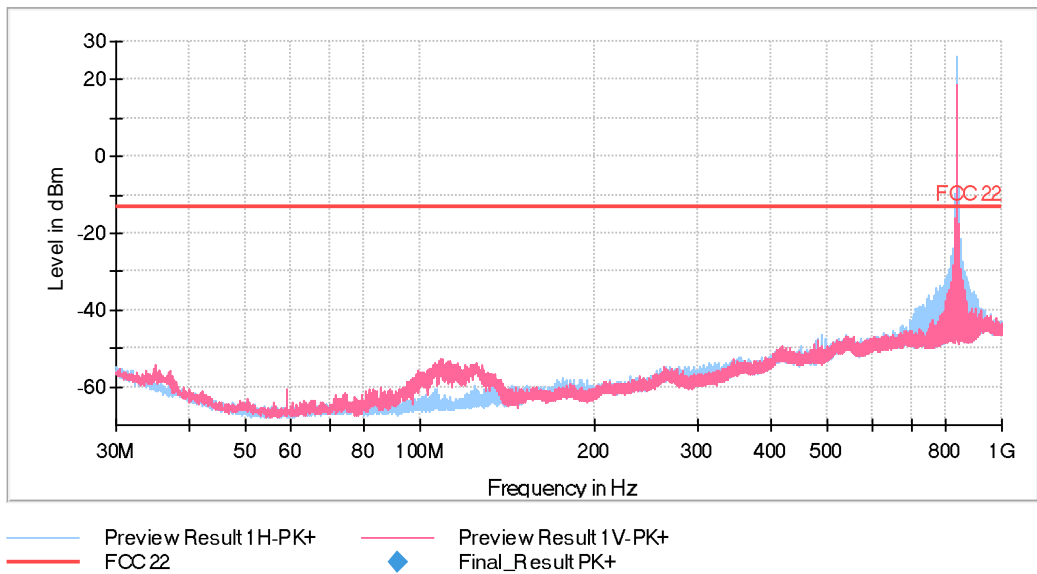

The peak above the limit is the carrier frequency.

- High Channel:

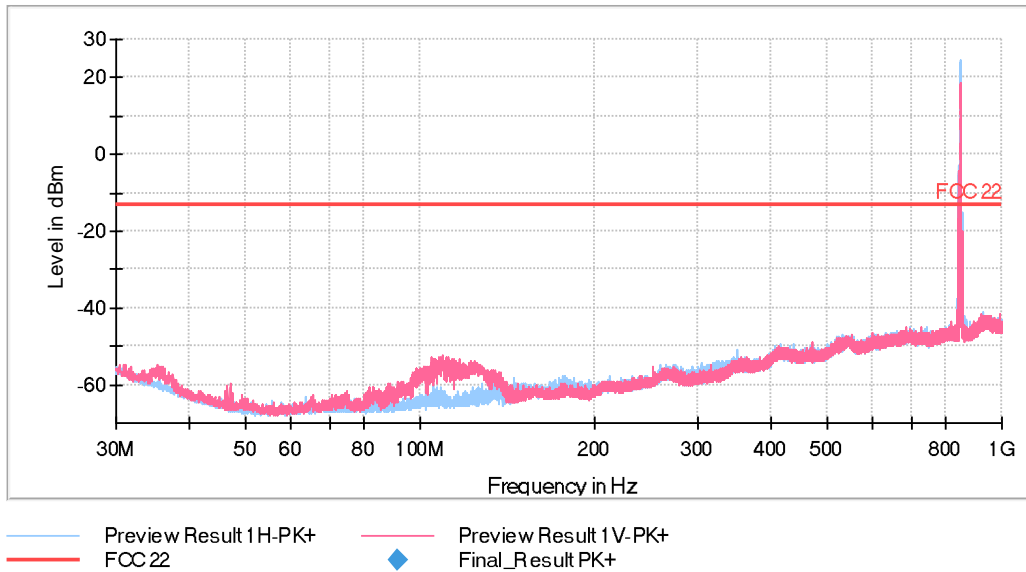

The peak above the limit is the carrier frequency.

FREQUENCY RANGE 1 - 8.5 GHz:

- Low Channel:

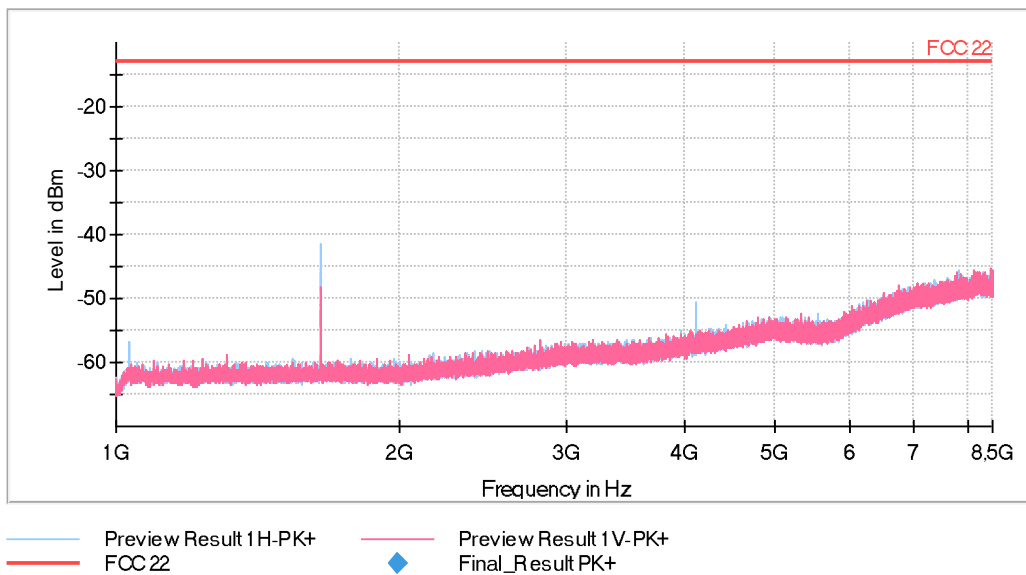

- Middle Channel:

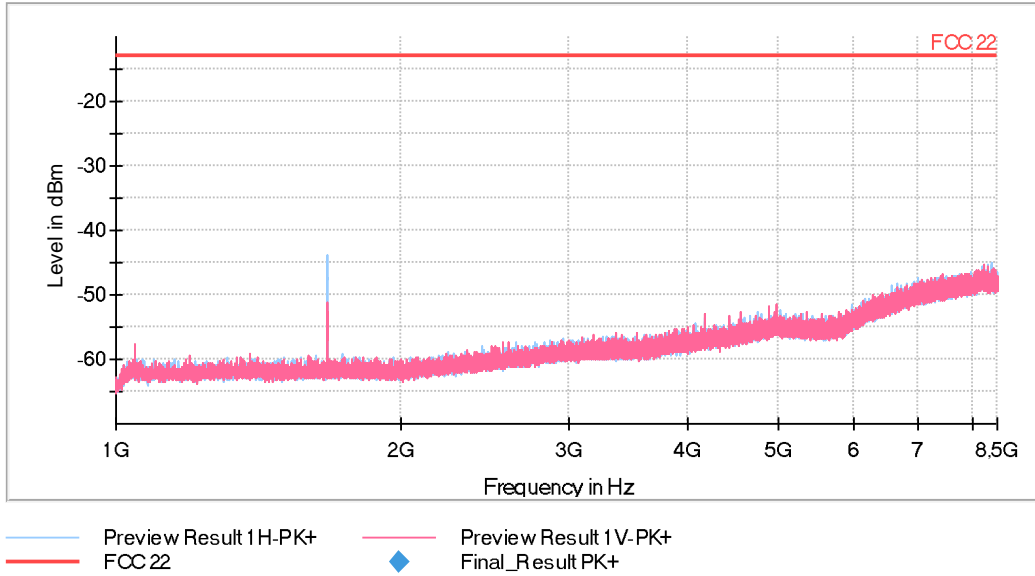

- High Channel:

