



ResMed

AirCurve™ 10

ST-A



User guide
English

Welcome

The AirCurve™ 10 ST-A is a bilevel positive airway pressure device.

WARNING

Read this entire guide before using the device.

CAUTION

In the US, Federal law restricts this device to sale by or on the order of a physician.

Indications for use

AirCurve 10 ST-A

The AirCurve 10 ST-A is indicated to provide non-invasive ventilation for patients weighing more than 30 lb (13 kg) with respiratory insufficiency or obstructive sleep apnea (OSA).

The iVAPS mode is indicated for patients weighing more than 66 lb (30 kg).

The AirCurve 10 ST-A is intended for home and hospital use.

The humidifier is intended for single patient use in the home environment and re-use in a hospital/institutional environment.

Contraindications

Positive airway pressure therapy may be contraindicated in some patients with the following pre-existing conditions:

- severe bullous lung disease
- pneumothorax or pneumomediastinum
- pathologically low blood pressure, particularly if associated with intravascular volume depletion
- dehydration
- cerebrospinal fluid leak, recent cranial surgery, or trauma.

Adverse effects

You should report unusual chest pain, severe headache, or increased breathlessness to your prescribing physician. An acute upper respiratory tract infection may require temporary discontinuation of treatment.

The following side effects may arise during the course of therapy with the device:

- drying of the nose, mouth, or throat
- nosebleed
- bloating
- ear or sinus discomfort
- eye irritation
- skin rashes.

At a glance

The AirCurve 10 includes the following:

- Device with HumidAir™ integrated humidifier
- Water tub
- Air tubing
- Power supply unit
- Travel bag
- SD card (already inserted).

Contact your care provider for a range of accessories available for use with the device including:

- Air tubing (heated and non-heated): ClimateLineAir™, ClimateLineAir Oxy, SlimLine™, Standard
- Water tub: Standard water tub, cleanable water tub (can be disinfected)
- Side cover for use without the humidifier
- Filter: Hypoallergenic filter, standard filter
- Air10™ DC/DC converter (12V/24V)
- SD card reader
- Air10 oximeter adapter
- Air10 USB adapter
- Power Station II
- Air10 tubing elbow

About your device

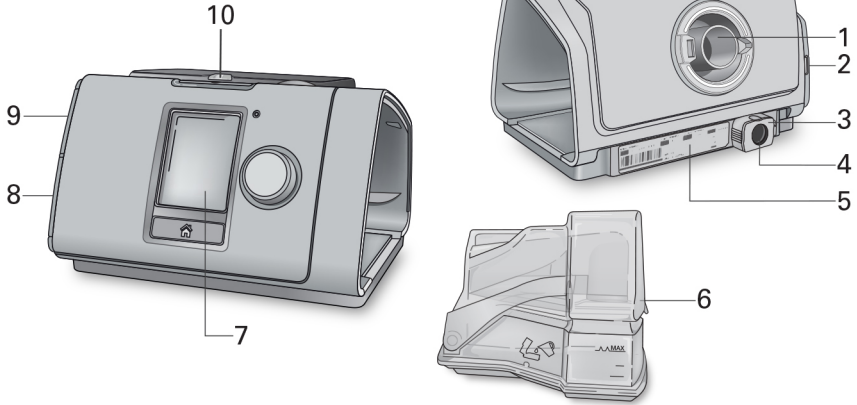

- 1 Air outlet
- 2 Air filter cover
- 3 Retention clip
- 4 Power inlet
- 5 Serial number and device number

- 6 HumidAir humidifier (water tub)
- 7 Screen
- 8 Adapter cover
- 9 SD card cover
- 10 LED alarm indicator

About the control panel



Start/Stop button

Press to start/stop therapy.
Press and hold for three seconds to enter power save mode.



Dial

Turn to navigate the menu and press to select an option.
Turn to adjust a selected option and press to save your change.



Home button

Press to return to the Home screen.

Different icons may be displayed on the screen at different times including:



Ramp Time



Wireless signal strength (green)



Humidity



Wireless transfer not enabled (gray)



Humidifier warming



No wireless connection



Humidifier cooling



Airplane Mode



Alarm muted

Setup

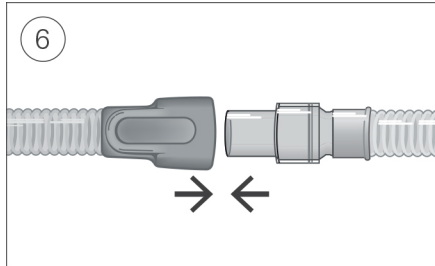
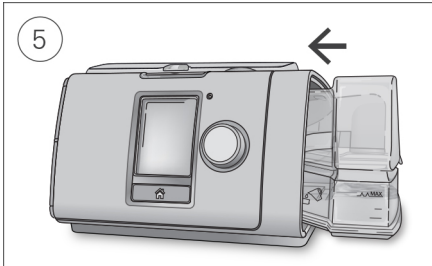
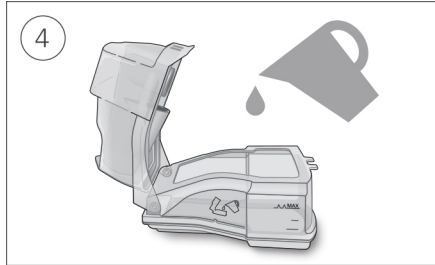
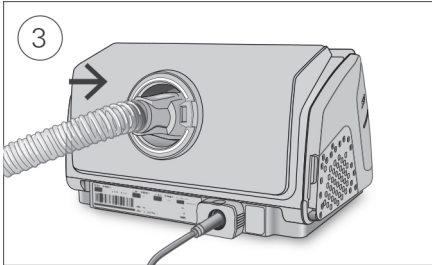
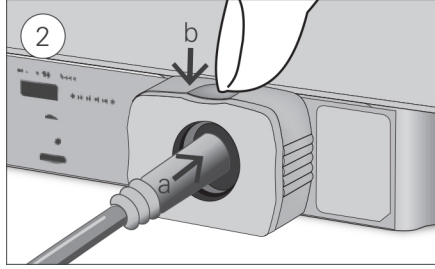
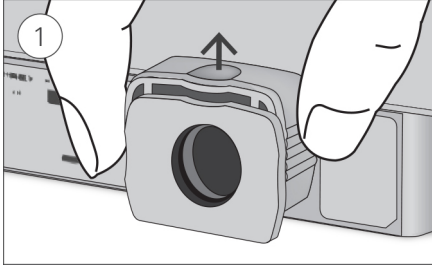

CAUTION

Do not overfill the water tub as water may enter the device and air tubing.

1. With the device on a stable level surface, grip the retention clip on the back of the device and pull up to open. Note: The retention clip is shown in the open position.
2. (a) Plug the power connector into the device power inlet then (b) push down the retention clip to secure in place. Connect one end of the power cord into the power supply unit and the other end into the power outlet.
3. Connect the air tubing firmly to the air outlet located on the rear of the device.
4. Open the water tub and fill it with distilled water up to the maximum water level mark. Do not fill the water tub with hot water.
5. Close the water tub and insert it into the side of the device.
6. Connect the free end of the air tubing firmly onto the assembled mask. See the mask user guide for detailed information.

Recommended masks are available on www.resmed.com.

Note: Ensure the device is placed so that the LED alarm indicator is clearly visible.

Starting therapy

1. Fit your mask.
2. Press Start/Stop or breathe normally if SmartStart™ is enabled.

You will know that therapy is on when the **Monitoring** screen is displayed.

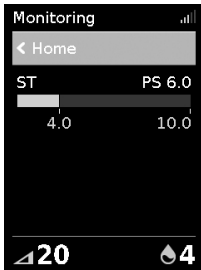

The pressure bar shows the inspiratory and expiratory pressures in green. The green bar will expand and contract as you breathe in and out.

The screen will go black automatically after a short period of time. You can press Home or the dial to turn it back on. If power is interrupted during therapy, the device will automatically restart therapy when power is restored.

The AirCurve 10 device has a light sensor that adjusts the screen brightness based on the light in the room.

Stopping therapy

1. Remove your mask.
2. Press Start/Stop or if SmartStart is enabled, therapy will stop automatically after a few seconds.

Note: If Confirm Stop is enabled, a message is displayed asking if you want to stop therapy. Turn the dial to select **Yes** and then press the dial to stop therapy.

Once therapy has stopped, the **Sleep Report** gives you a summary of your therapy session.



Usage hours—Indicates the number of hours of therapy you received last session.

Mask Seal—Indicates how well your mask sealed:

 Good mask seal.

 Needs adjusting, see Mask Fit.

Humidifier—Indicates if your humidifier is working properly:

 Humidifier working.

 Humidifier might be faulty, contact your care provider.

If set by your care provider, you will also see:

Events per hour—Indicates the number of apneas and hypopneas experienced per hour.

More Info—Turn the dial to scroll down to view more detailed usage data.

Power save mode

Your AirCurve 10 device records your therapy data. In order to allow it to transmit the data to your care provider, you should not unplug the device. However, you can put it into power save mode to save electricity.

To enter power save mode:

- Press and hold Start/Stop for three seconds.
The screen goes black.

To exit power save mode:

- Press Start/Stop once.
The Home screen is displayed.

My Options

Your AirCurve 10 device has been set up for your needs by your care provider, but you may find you want to make small adjustments to make your therapy more comfortable.

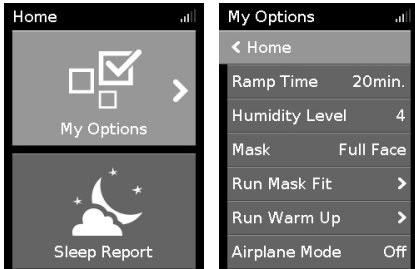

Highlight **My Options** and press the dial to see your current settings. From here, you can personalize your options.

Ramp Time

Designed to make the beginning of therapy more comfortable, Ramp Time is the period during which the pressure increases from a low start pressure to the prescribed treatment pressure.

You can set your Ramp Time to Off or between 5 to 45 minutes.

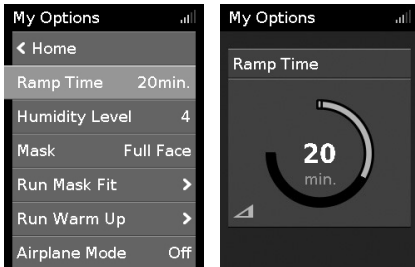

To adjust Ramp Time:

1. In **My Options**, turn the dial to highlight **Ramp Time** and then press the dial.
2. Turn the dial to adjust the ramp time to your preferred setting and press the dial to save the change.

Ramp Down

Ramp Down is intended to make stopping therapy more comfortable by reducing your pressure over a fixed 15 minute period. This option will only be available to you via your care provider.



To enable Ramp Down:

1. In **My Options**, turn the dial to highlight **Ramp Down** and then press the dial.
2. Turn the dial to select **On** and then press the dial to save the change.

To start Ramp Down:

1. Press the Start/Stop button.

Note: If Confirm Stop is enabled, a message is displayed asking if you want to start Ramp Down. Turn the dial to select **Yes** and then press the dial to start Ramp Down.

The Ramp Down icon  and time remaining will be displayed at the bottom left of the screen.

Once Ramp Down is complete, the device will continue to run at low pressure. To stop therapy at any time, press Start/Stop.

Humidity Level

The humidifier moistens the air and is designed to make therapy more comfortable. If you are getting a dry nose or mouth, turn up the humidity. If you are getting any moisture in your mask, turn down the humidity.

You can set the Humidity Level to Off or between 1 and 8, where 1 is the lowest humidity setting and 8 is the highest humidity setting.



To adjust the Humidity Level:

1. In **My Options**, turn the dial to highlight **Humidity Level** and then press the dial.
2. Turn the dial to adjust the humidity level and press the dial to save the change.

If you continue to get a dry nose or mouth, or moisture in your mask, consider using ClimateLineAir heated air tubing. ClimateLineAir together with Climate Control delivers more comfortable therapy.

Mask Fit

Mask Fit is designed to help you assess and identify possible air leaks around your mask.



To check Mask Fit:

1. Fit the mask as described in the mask user guide.
2. In **My Options**, turn the dial to highlight **Run Mask Fit** and then press the dial.
The device starts blowing air.
3. Adjust the mask, mask cushion and headgear until you get a **Good** result.

To stop Mask Fit, press the dial or Start/Stop. If you are unable to get a good mask seal, talk to your care provider.

More options

There are some more options on your device which you can personalize.

Mask	This option shows your mask type setting. If you use more than one type of mask, adjust this setting when switching between masks.
Run Warm Up	This option allows you to pre-heat the water before starting therapy, so that the air is not cold or dry at the beginning of therapy.
Ramp Down*	This option is intended to make stopping therapy more comfortable by reducing your pressure over a fixed 15 minute period.
SmartStart*	When SmartStart is enabled, therapy starts automatically when you breathe into your mask. When you remove your mask, it stops automatically after few seconds.

*When enabled by your care provider.

Working with alarms

The device is fitted with an alarm feature that monitors your therapy and alerts you to changes that may affect your treatment.

When power is connected to the device, the yellow LED alarm indicator will flash and the alarm will sound to confirm that the alarm is working.

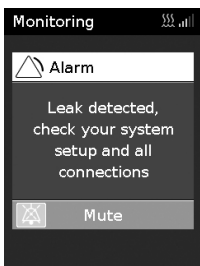

When an alarm is activated, the yellow LED alarm indicator will flash, the alarm will sound and a message will appear on the screen.

Muting activated alarms

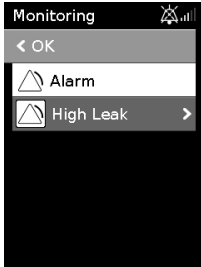

To mute the alarm:

1. Press the dial. A list of activated alarms will appear and the flashing alarm mute icon will be displayed in the top right corner of the screen. The alarm will be muted for 2 minutes.
2. To return to the previous screen, highlight OK and press the dial.

Once the condition that activated the alarm is corrected, the alarm sound and flashing icon will stop. If the condition that activated the alarm remains after 2 minutes, the alarm will re-occur. See the **Alarms troubleshooting** section for help with managing common alarm conditions.

Multiple alarms

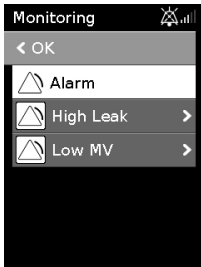

If multiple alarms are activated at the same time, the most recent alarm message will be displayed on the screen and any other activated alarms will be shown in the Alarms list.

Viewing the alarms

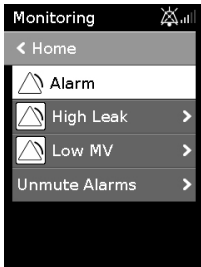

To view the alarm list:

1. From the **Monitoring** screen, turn the dial clockwise until the last **Monitoring** screen is displayed.
2. To view the alarm details, highlight the alarm and press the dial.

Caring for your device

It is important that you regularly clean your AirCurve 10 device to make sure you receive optimal therapy. The following sections will help you with disassembling, cleaning, checking and reassembling your device.

WARNING

Regularly clean the tubing assembly, water tub and mask for optimal therapy and to prevent the growth of germs that can adversely affect the patient's health.

Disassembling

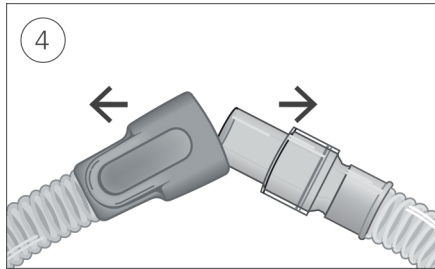
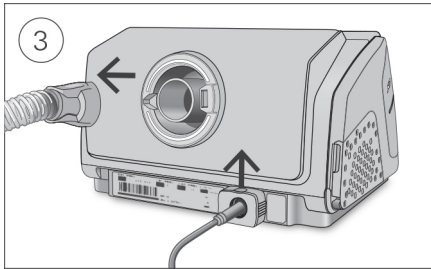
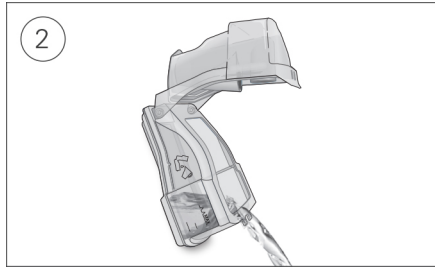
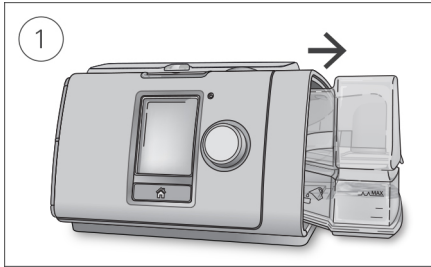

1. Hold the water tub at the top and bottom, press it gently and pull it away from the device.
2. Open the water tub and discard any remaining water.
3. Hold the cuff of the air tubing and gently pull it away from the device.
Grip the retention clip and pull up to release the power cord.
4. Hold both the cuff of the air tubing and the swivel of the mask, then gently pull apart.

Cleaning

You should clean the device weekly as described. Refer to the mask user guide for detailed instructions on cleaning your mask.

1. Wash the water tub and air tubing in warm water using mild detergent.
Do not wash in a dishwasher or washing machine.
2. Rinse the water tub and air tubing thoroughly and allow to dry out of direct sunlight and/or heat.
3. Wipe the exterior of the device with a dry cloth.

Checking

You should regularly check the water tub, air tubing and the air filter for any damage.

1. Check the water tub:
 - Replace it if it is leaking or has become cracked, cloudy or pitted.
 - Replace it if the seal is cracked or torn.
 - Remove any white powder deposits using a solution of one part household vinegar to 10 parts water.
2. Check the air tubing and replace it if there are any holes, tears or cracks.
3. Check the air filter and replace it at least every six months. Replace it more often if there are any holes or blockages by dirt or dust.

To replace the air filter:

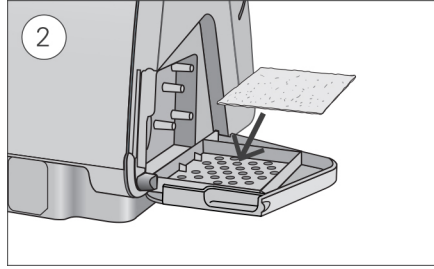
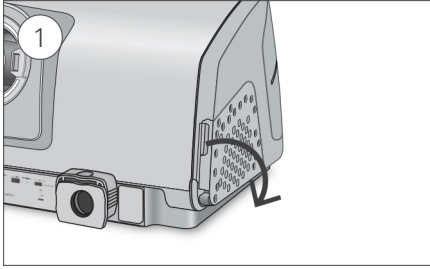

1. Open the air filter cover and remove the old air filter.
The air filter is not washable or reusable.
2. Place a new air filter onto the air filter cover and then close it.
Make sure the air filter is fitted at all times to prevent water and dust from entering the device.

Reassembling

When the water tub and air tubing are dry, you can reassemble the parts.

1. Connect the air tubing firmly to the air outlet located on the rear of the device.
2. Open the water tub and fill it with distilled room temperature water up to the maximum water level mark.
3. Close the water tub and insert it into the side of the device.
4. Connect the free end of the air tubing firmly onto the assembled mask.

Therapy data

Your AirCurve 10 device records your therapy data for you and your care provider so they can view and make changes to your therapy if required. The data is recorded and then transferred to your care provider wirelessly, if wireless network is available, or via an SD card.

Data transmission

Your AirCurve 10 device has the capability of cellular communication so that your therapy data can be transmitted to your care provider to improve the quality of your treatment. It also allows your care provider to update your therapy settings in a more timely manner or upgrade your device software to ensure you receive the best therapy possible.

The data is usually transmitted after therapy has stopped. In order to make sure that your data is transferred:

- Leave your device connected to the power outlet at all times.
- Make sure that it is not in Airplane Mode.
- Check the Wireless signal strength icon  for adequate wireless coverage.

Notes:

- Therapy data might not be transmitted if you use it outside of the country or region of purchase.
- Devices with cellular communication might not be available in all regions.

Please be aware that within the wireless network, the availability and quality of the network may be affected by terrain, buildings, and the weather. Wireless communication depends on network availability. Coverage is not available everywhere and varies by service.

SD card

An alternative way for your therapy data to be transferred to your care provider is via the SD card. Your care provider may ask you to send the SD card by mail or to bring it in. When instructed by your care provider, remove the SD card.

Do not remove the SD card from the device when the SD light is flashing because data is being written to the card.

To remove the SD card:

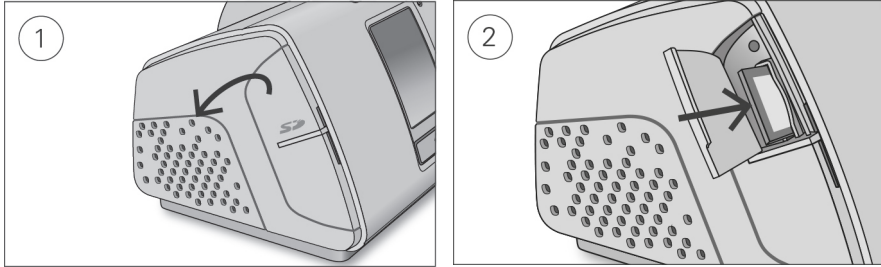

1. Open the SD card cover.
2. Push in the SD card to release it. Remove the SD card from the device.
Place the SD card in the protective folder and send it back to your care provider.

For more information on the SD card refer to the SD card protective folder provided with your device.

Note: The SD card should not be used for any other purpose.

Traveling

You can take your AirCurve 10 device with you wherever you go. Just keep the following in mind:

- Use the travel bag provided to prevent damage to the device.
- Empty the water tub and pack it separately in the travel bag.
- Make sure you have the appropriate power cord for the region you are traveling to. For information on purchasing, contact your care provider.
- If you are using an external battery, you should turn off the humidifier in order to maximize the life of your battery. Do this by turning the **Humidity Level** to Off.

Traveling by plane

Your AirCurve 10 device may be taken on board as carry-on luggage. Medical devices do not count toward your carry-on luggage limit.

You can use your AirCurve 10 device on a plane as it meets the Federal Aviation Administration (FAA) requirements. Air travel compliance letters can be downloaded and printed from www.resmed.com.

When using the device on a plane:

- Make sure the water tub is completely empty and inserted into your device. The device will not work without the water tub inserted.
- Turn on **Airplane Mode**.

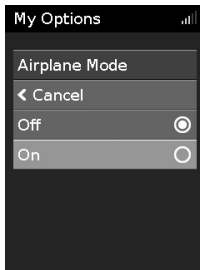

To turn on Airplane Mode:

1. In **My Options**, turn the dial to highlight **Airplane Mode** and then press the dial.
2. Turn the dial to select **On** and then press the dial to save the change.
The Airplane Mode icon ✈️ is displayed at the top right of the screen.

⚠️ CAUTION





Do not use the device with water in the water tub on a plane due to the risk of inhalation of water during turbulence.



Troubleshooting

If you have any problems, have a look at the following troubleshooting topics. If you are not able to fix the problem, contact your care provider or ResMed. Do not try to open the device.

General troubleshooting

Problem/possible cause	Solution
Air is leaking from around my mask Mask may be fitted incorrectly.	Make sure your mask is fitted correctly. See your mask user guide for fitting instructions or use the Mask Fit function to check your mask fit and seal.
I am getting a dry or blocked nose Humidity level may be set too low.	Adjust the Humidity Level. If you have ClimateLineAir heated air tubing, see the ClimateLineAir user guide.
I am getting droplets of water on my nose, in the mask and air tubing Humidity level may be set too high.	Adjust the Humidity Level. If you have ClimateLineAir heated air tubing, see the ClimateLineAir user guide.
My mouth is very dry and uncomfortable Air may be escaping through your mouth.	Increase the Humidity Level. You may need a chin strap to keep your mouth closed or a full face mask.
Air pressure in my mask seems too high (it feels like I am getting too much air) Ramp may be turned off.	Use the Ramp Time option.

Problem/possible cause	Solution
Air pressure in my mask seems too low (it feels like I am not getting enough air)	
Ramp may be in progress 	Wait for air pressure to build up or turn Ramp Time off.
Ramp Down may be in progress 	Press Start/Stop to stop therapy then press Start/Stop to restart and continue therapy.
Non-vented mask is used.	Only use a vented mask.
Mask vents might be blocked.	Check if you have sufficient venting. Unblock mask vents if necessary.
Expiratory pressure (EPAP) may be set too low.	Talk to your care provider about your settings.
My screen is black	
Backlight on the screen may have turned off. It turns off automatically after a short period of time.	Press Home or the dial to turn it back on.
Power may not be connected.	Connect the power supply and make sure the plug is fully inserted. Note: The retention clip should be in the open position when inserting the plug. For instructions refer to the Setup section.
I have stopped therapy, but the device is still blowing air	
Device is cooling down.	Device blows a small amount of air in order to avoid condensation in the air tubing. It will stop automatically after 30 minutes.
My water tub is leaking	
Water tub may not be assembled correctly.	Check for damage and reassemble the water tub correctly.
Water tub may be damaged or cracked.	Contact your care provider for a replacement.
My therapy data has not been sent to my care provider	
Power may not be connected.	Connect the power supply and make sure the plug is fully inserted. Note: The retention clip should be in the open position when inserting the plug. For instructions refer to the Setup section.
Wireless coverage may be poor.	Make sure that the device is placed where there is coverage (ie, on your bedside table, not in a drawer or on the floor) and away from other communication devices. The Wireless signal strength icon  indicates good coverage when all bars are displayed, and poor coverage when fewer bars are displayed.
The No wireless connection icon  is displayed on the top right of the screen. no wireless network available.	Make sure that the device is placed where there is coverage (ie, on your bedside table, not in a drawer or on the floor) and away from other communication devices. If instructed to do so, send the SD card to your care provider. The SD card also contains your therapy data.

Problem/possible cause	Solution
Device may be in Airplane Mode.	Turn off Airplane Mode, see Traveling by plane.
Data transfer is not enabled for your device.	Talk to your care provider about your settings.
My screen and buttons are flashing but there is no alarm sound or message	
Software upgrade is in progress.	Software upgrade takes approximately 10 minutes to complete.
Displays message: Read only card, please remove, unlock and re-insert SD card	
SD card switch may be in the lock (read-only) position.	Move the switch on the SD Card from the lock position  to the unlock position  and then re-insert it.

Alarms troubleshooting

Problem/possible cause	Solution
Display disappears and an alarm is activated	
Power failure.	Remove your mask until power is restored.
Power cord is disconnected or mains power has been turned off during therapy.	Ensure the power cord is connected and the mains power switch (if available) is on.
Displays message: High leak detected, check your water tub, tub seal or side cover	
Water tub may not be inserted properly.	Make sure the water tub is correctly inserted.
Water tub seal may not be inserted properly.	Open the water tub and make sure that the seal is correctly inserted.
Displays message: High leak detected, connect your tubing	
Air tubing may not be connected properly.	Make sure the air tubing is firmly connected at both ends.
Mask may be fitted incorrectly.	Make sure your mask is fitted correctly. See your mask user guide for fitting instructions or use the Mask Fit function to check your mask fit and seal.
Displays message: Tubing blocked, check your tubing	
Air tubing may be blocked.	Check the air tubing and remove any blockages. Press the dial to clear the message and then press Start/Stop to restart the device.
Displays message: Leak detected, check your system setup and all connections	
Mask may be fitted incorrectly.	Make sure your mask is fitted correctly. See your mask user guide for fitting instructions or use the Mask Fit function to check your mask fit and seal.
Displays message: Low MV detected	
Minute ventilation level has dropped below the pre-set alarm level.	Contact your care provider.

Problem/possible cause	Solution
Displays message: Apnea detected	
The device detects an apnea that has exceeded the pre-set alarm.	Breathe normally to disable the alarm. If the problem persists contact your care provider.
Displays message: Low SpO₂ detected	
SpO ₂ has dropped below the pre-set alarm level.	Check the attachment of the sensor. If the problem persists contact your care provider.
Displays message: No SpO₂ data, check your oxi sensor attachment to module/finger	
Oximeter sensor is not attached properly.	Ensure that the oximeter sensor is attached properly to the module and to your finger.
Oximeter sensor may be faulty.	If the message appears repeatedly, the oximeter sensor might be faulty. Replace the oximeter.
Displays message: Non-vented mask detected, use vented mask or unblock your mask vents	
Non-vented mask is used.	Only use a vented mask.
Mask vents might be blocked.	Check if you have sufficient venting. Unblock mask vents if necessary.
Expiratory pressure (EPAP) may be set too low.	Talk to your care provider about your settings.
Displays message: System fault, refer to user guide, Error 004	
Device may have been left in a hot environment.	Allow to cool before re-use. Disconnect the power supply and then reconnect it to restart the device.
Air filter may be blocked.	Check the air filter and replace it if there are any blockages. Disconnect the power supply and then reconnect it to restart the device.
Air tubing may be blocked.	Check the air tubing and remove any blockages. Press the dial to clear the message and then press Start/Stop to restart the device.
There may be water in the air tubing.	Empty the water from the air tubing. Disconnect the power supply and then reconnect it to restart the device.
Displays message: System fault, refer to user guide, Error 022	
Power cord may not be correctly inserted into the device.	Remove the power cord from the device and then re-insert it. Ensure that the power cord is fully inserted into the device. Note: the retention clip should be in the open position when inserting the plug. For instructions refer to the Setup section. If the problem continues, contact your local ResMed dealer or ResMed office. Do not open the device.
All other error messages, for example, System fault, refer to user guide, Error 0XX	
An unrecoverable error has occurred on the device.	Contact your care provider. Do not open the device.

Reassembling parts

Some parts of your device are designed to easily come off in order to avoid damage to the parts or the device. You can easily reassemble them as described below.

To insert the water tub seal:

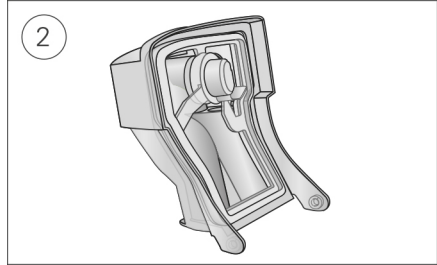
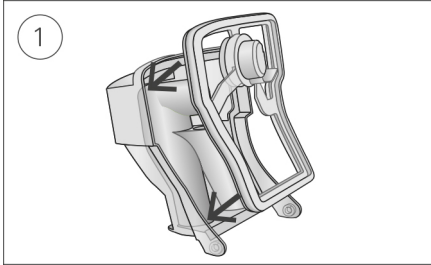

1. Place the seal into the lid.
2. Press down along all edges of the seal until it is firmly in place.

To reassemble the water tub lid:

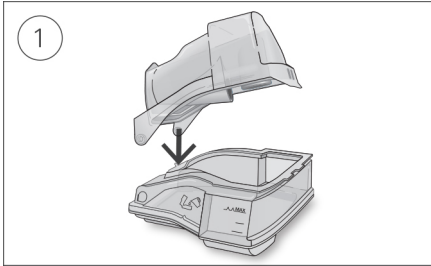

1. Insert one side of the lid into the pivot hole of the base.
2. Slide the other side down the ridge until it clicks into place.

General warnings and cautions

WARNING

- Make sure that you arrange the air tubing so that it will not twist around the head or neck.
- Make sure the power cord and plug are in good condition and the equipment is not damaged.
- Keep the power cord away from hot surfaces.
- If you notice any unexplained changes in the performance of the device, if it is making unusual sounds, if the device or the power supply are dropped or mishandled, or if the enclosure is broken, discontinue use and contact your care provider or your ResMed Service Center.
- Do not open or modify the device. There are no user serviceable parts inside. Repairs and servicing should only be performed by an authorized ResMed service agent.
- Beware of electrocution. Do not immerse the device, power supply or power cord in water. If liquids are spilled into or onto the device, unplug the device and let the parts dry. Always unplug the device before cleaning and make sure that all parts are dry before plugging it back in.
- Supplemental oxygen must not be used while smoking or in the presence of an open flame.
- Always make sure that the device is turned on and airflow generated before the oxygen supply is turned on. Always turn the oxygen supply off before the device is turned off, so that unused oxygen does not accumulate within the device enclosure and create a risk of fire.
- Do not perform any maintenance tasks while the device is in operation.
- The device should not be used adjacent to or stacked with other equipment. If adjacent or stacked use is necessary, the device should be observed to verify normal operation in the configuration in which it will be used.
- The use of accessories other than those specified for the device is not recommended. They may result in increased emissions or decreased immunity of the device.
- Regularly check the antibacterial filter for signs of moisture or other contaminants, particularly during nebulization or humidification. Failure to do so could result in increased breathing system resistance.
- The device has not been tested or certified for use in the vicinity of X-ray, CT or MRI equipment. Do not bring the device within 13 ft (4 m) of X-ray or CT equipment. Never bring the device into an MR environment.
- Therapy settings should not be changed remotely for patients in a hospital setting. Remote changes in a hospital setting may not be appropriate for certain patients, as these setting changes may not be communicated to all hospital personnel treating the patient. Hospital staff should liaise with the patient's regular care provider such that the desired therapy outcome is achieved.

CAUTION

- Use only ResMed parts and accessories with the device. Non-ResMed parts may reduce the effectiveness of the treatment and/or damage the device.
- Use only vented masks recommended by ResMed or by the prescribing doctor with this device. Fitting the mask without the device blowing air can result in rebreathing of exhaled air. Make sure that the mask vent holes are kept clear and unblocked to maintain the flow of the fresh air into the mask.
- Be careful not to place the device where it can be bumped or where someone is likely to trip over the power cord.

- Blocking the air tubing and/or air inlet of the device while in operation could lead to overheating of the device.
- Keep the area around the device dry, clean and clear of anything (eg, clothes or bedding) that could block the air inlet or cover the power supply unit.
- Do not place the device on its side as water might get into the device.
- Incorrect system setup may result in incorrect mask pressure reading. Ensure the system is correctly set up.
- Do not use bleach, chlorine, alcohol, or aromatic-based solutions, moisturizing or antibacterial soaps or scented oils to clean the device, the humidifier or air tubing. These solutions may cause damage or affect the humidifier performance and reduce the life of the products.
- If you use the humidifier, always place the device on a level surface lower than your head to prevent the mask and air tubing from filling with water.
- Leave the water tub to cool for ten minutes before handling to allow the water to cool and to make sure that the water tub is not too hot to touch.
- Make sure that the water tub is empty before transporting the device.

Note: The device is not intended to be operated by persons (including children) with reduced physical, sensory or mental capabilities without adequate supervision by a person responsible for the patient's safety.

Technical specifications

90W power supply unit

AC input range:	100–240V, 50–60Hz 1.0–1.5A, Class II 115V, 400Hz 1.5A, Class II (nominal for aircraft use)
DC output:	24V  3.75A
Typical power consumption:	53W (57VA)
Peak power consumption:	104W (108VA)

Environmental conditions

Operating temperature:	+41°F to +95°F (+5°C to +35°C) Note: The air flow for breathing produced by this therapy device can be higher than the temperature of the room. Under extreme ambient temperature conditions (104°F/40°C) the device remains safe.
Operating humidity:	10 to 95% relative humidity, non-condensing
Operating altitude:	Sea level to 8,500' (2,591 m); air pressure range 1013 hPa to 738 hPa
Storage and transport temperature:	-4°F to +140°F (-20°C to +60°C)
Storage and transport humidity:	5 to 95% relative humidity, non-condensing

Electromagnetic compatibility

The AirCurve 10 complies with all applicable electromagnetic compatibility requirements (EMC) according to IEC 60601-1-2:2014, for residential, commercial and light industry environments. It is recommended that mobile communication devices are kept at least 1 m away from the device.

For further details see the Guidance and manufacturer's declaration – electromagnetic emissions and immunity section.

Classification: IEC 60601-1:2005+A1:2012

Class II (double insulation), Type BF, Ingress protection IP22.

Sensors

Pressure sensors:	Internally located at device outlet, analog gauge pressure type, -5 to +45 cm H ₂ O (-5 to +45 hPa)
Flow sensor:	Internally located at device inlet, digital mass flow type, -70 to +180 L/min

Maximum single fault steady pressure

Device will shut down in the presence of a single fault if the steady state pressure exceeds:
30 cm H₂O (30 hPa) for more than 6 sec or 40 cm H₂O (40 hPa) for more than 1 sec.

Sound

Pressure level measured according to ISO 80601-2-70:2015 (CPAP mode):

SlimLine:	25 dBA with uncertainty of 2 dBA
Standard:	25 dBA with uncertainty of 2 dBA
SlimLine or Standard and humidification:	27 dBA with uncertainty of 2 dBA

Power level measured according to ISO 80601-2-70:2015 (CPAP mode):

SlimLine:	33 dBA with uncertainty of 2 dBA
Standard:	33 dBA with uncertainty of 2 dBA
SlimLine or Standard and humidification:	35 dBA with uncertainty of 2 dBA

Declared dual-number noise emission values in accordance with ISO 4871:1996.

Alarm volume settings

Low (nominal 54 dBA), Medium (nominal 60 dBA), High (nominal 73 dBA)

Physical - device and water tub

Dimensions (W x D x H):	10.04" x 5.91" x 4.57" (255 mm x 150 mm x 116 mm)
Air outlet (complies with ISO 5356-1:2004):	22 mm
Weight (device and standard water tub):	47.1 oz (1336 g)
Weight (device and cleanable water tub):	47.1 oz (1336 g)
Housing construction:	Flame retardant engineering thermoplastic
Water capacity:	To maximum fill line 380 mL
Standard water tub - material:	Injection molded plastic, stainless steel and silicone seal
Cleanable water tub - material:	Injection molded plastic, stainless steel and silicone seal

Temperature

Maximum heater plate:	154°F (68°C)
Cut-out:	165°F (74°C)
Maximum gas temperature:	≤ 106°F (≤ 41°C)

Air filter

Standard:	Material: Polyester non woven fiber Average arrestance: >75% for ~7 micron dust
Hypoallergenic:	Material: Acrylic and polypropylene fibers in a polypropylene carrier Efficiency: >98% for ~7-8 micron dust; >80% for ~0.5 micron dust

Aircraft use

ResMed confirms that device meets the Federal Aviation Administration (FAA) requirements (RTCA/DO-160, section 21, category M) for all phases of air travel.

Wireless module

Technology used:	CDMA (USA only), 4G (USA and Canada) 3G, 2G
Frequencies:	CDMA (800/1900 MHz) 4G (700/850/1900 Mhz) 3G (850/900/1700/1900/2100 MHz) 2G (850/900/1800/1900 MHz)
Max RF power output:	CDMA 24.5 dBm 4G 23.0 dBm 3G 24.0 dBm 2G 33.0 dBm (850/900MHz) 30,0 dBm (1800/1900 MHz)

FCC ID: 2ACHL-A10STACD, 2ACHL-A10STA3G, 2ACHL-AIR104G

IC: 9103A-A10STA3G, 9103A-AIR104G

The AirCurve 10 device complies with FCC Rules and Industry Canada Rules.

The AirCurve 10 device should be used at a minimum distance of 0.8" (2 cm) from the body during operation.

Additional information regarding the FCC Rules and IC compliance for this device can be found on www.resmed.com/downloads/devices

Operating pressure range

S, ST, T, PAC, iVAPS:	3 to 30 cm H ₂ O
CPAP	4 to 20 cm H ₂ O

Supplemental oxygen

Maximum flow:	15 L/min (S, ST, T, PAC, CPAP), 4 L/min (iVAPS)
---------------	---

Pneumatic flow path

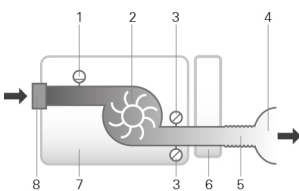

- 1. Flow sensor
- 2. Blower
- 3. Pressure sensor
- 4. Mask
- 5. Air tubing
- 6. Water tub
- 7. Device
- 8. Inlet filter

Design life

Device, power supply unit:	5 years
Cleanable water tub:	2.5 years
Standard water tub, air tubing:	6 months

General

The patient is an intended operator.

Operator position

The device is designed to be operated within arm's length. An operator should position their line of sight within an angle of 30 degrees from a plane perpendicular to the screen.

Humidifier performance

Mask Pressure cm H ₂ O (hPa)	Nominal RH output %		Nominal system output AH ¹ , BTPS ²	
	Setting 4	Setting 8	Setting 4	Setting 8
3	85	100	6	>10
4	85	100	6	>10
10	85	100	6	>10
20	85	90	6	>10
25	85	90	6	>10
30	85	90	6	>10

¹ AH - Absolute Humidity in mg/L

² BTPS - Body Temperature Pressure Saturated

Air tubing

Air tubing	Material	Length	Inner diameter
ClimateLineAir	Flexible plastic and electrical components	6'6" (2 m)	0.6" (15 mm)
ClimateLineAir Oxy	Flexible plastic and electrical components	6'4" (1.9 m)	0.75" (19 mm)
SlimLine	Flexible plastic	6' (1.8 m)	0.6" (15 mm)
Standard	Flexible plastic	6'6" (2 m)	0.75" (19 mm)
3 m	Flexible plastic	9'10" (3 m)	0.75" (19 mm)

Heated air tubing temperature cut-out: ≤ 106°F (≤ 41°C)

Notes:

- The manufacturer reserves the right to change these specifications without notice.
- The electrical connector end of the heated air tubing is only compatible with the air outlet at the device end and should not be fitted to the mask.
- Do not use electrically conductive or antistatic air tubing.
- The temperature and relative humidity settings displayed are not measured values.

Displayed values

Value	Range	Display resolution
Pressure sensor at air outlet:		
Mask pressure	3–30 cm H ₂ O	0.1 cm H ₂ O
Flow derived values:		
Leak	0–120 L/min	1 L/min
Tidal volume	0–4000 mL	1 mL
Respiratory rate	0–50 BPM	1 BPM
Minute ventilation	0–30 L/min	0.1 L/min
Ti	0.1–4.0 sec	0.1 sec
I:E ratio	1:100–2:1	0.1

Value	Accuracy ¹
Pressure measurement ¹ :	
Mask pressure ²	±[0.5 cm H ₂ O (0.5 hPa) + 4% of measured value]
Flow and flow derived values ¹ :	
Flow	±6 L/min or 10% of reading, whichever is greater, at 0 to 150 L/min positive flow
Leak ²	±12 L/min or 20% of reading, whichever is greater, 0 to 60 L/min
Tidal volume ^{2,3}	±20%
Respiratory rate ^{2,3}	±1.0 BPM
Minute ventilation ^{2,3}	±20%

¹ Results are expressed as STPD (Standard Temperature and Pressure, Dry). 101.3kPa at an operating temperature of 68°F (20°C), dry.

² Accuracy may be reduced by the presence of leaks, supplemental oxygen, tidal volumes <100 mL or minute ventilation <3 L/min.

³ Measurement accuracy verified as per ISO 10651-6:2004 for Home Care Ventilatory Support Devices (Figure 101 and Table 101) using nominal ResMed mask vent flows.

Measurement system uncertainties

In accordance with ISO 80601-2-70:2015 the measurement uncertainty of the manufacturer's test equipment is:

For measures of flow	± 1.5 L/min or ± 2.7% of reading (whichever is greater)
For measures of volume (< 100 mL)	± 5 mL or 6% of reading (whichever is greater)
For measures of volume (≥ 100 mL)	± 20 mL or 3% of reading (whichever is greater)
For measures of pressure	± 0.15 cm H ₂ O (0.15 hPa)
For measures of time	± 10 ms

Pressure accuracy - CPAP

Maximum static pressure variation at 10 cm H₂O (10 hPa) according to ISO 80601-2-70:2015

	Standard air tubing	SlimLine air tubing
Without humidification	± 0.5 cm H ₂ O (± 0.5 hPa)	± 0.5 cm H ₂ O (± 0.5 hPa)
With humidification	± 0.5 cm H ₂ O (± 0.5 hPa)	± 0.5 cm H ₂ O (± 0.5 hPa)

Maximum dynamic pressure variation according to ISO 80601-2-70:2015

Device without humidification and Standard air tubing / Device with humidification and Standard air tubing

Pressure [cm H ₂ O (hPa)]	10 BPM	15 BPM	20 BPM
4	0.5 / 0.5	0.5 / 0.5	0.8 / 0.8
8	0.5 / 0.5	0.5 / 0.5	0.8 / 0.8
12	0.5 / 0.5	0.5 / 0.5	0.8 / 0.8
16	0.5 / 0.5	0.5 / 0.5	0.8 / 0.8
20	0.5 / 0.5	0.5 / 0.5	0.8 / 0.8

Device without humidification and SlimLine air tubing / Device with humidification and SlimLine air tubing

Pressure [cm H ₂ O (hPa)]	10 BPM	15 BPM	20 BPM
4	0.5 / 0.5	0.5 / 0.5	0.8 / 0.8
8	0.5 / 0.5	0.5 / 0.5	0.8 / 0.8
12	0.5 / 0.5	0.5 / 0.5	0.8 / 0.8
16	0.5 / 0.5	0.5 / 0.5	0.8 / 0.8
20	0.5 / 0.5	0.5 / 0.5	0.8 / 0.8

Pressure accuracy - bilevel

Maximum dynamic pressure variation according to ISO 80601-2-70:2015.

Device without humidification and Standard air tubing / Device with humidification and Standard air tubing

Breath rate	Inspiratory pressure (cm H ₂ O [hPa]) (Means, Standard Deviations)					
	6	10	16	21	25	30
10 BPM	-0.09, 0.01 / - 0.22, 0.01	-0.01, 0.07 / - 0.22, 0.01	0.07, 0.05 / - 0.24, 0.01	-0.03, 0.09 / - 0.29, 0.03	0.12, 0.01 / - 0.26, 0.02	0.12, 0.01 / - 0.14, 0.02
15 BPM	0.02, 0.08 / - 0.22, 0.01	0.12, 0.01 / - 0.22, 0.01	0.15, 0.01 / - 0.26, 0.01	0.15, 0.01 / - 0.31, 0.02	0.16, 0.12 / - 0.30, 0.02	0.20, 0.05 / - 0.22, 0.02
20 BPM	0.17, 0.01 / - 0.23, 0.01	0.21, 0.01 / - 0.28, 0.01	0.25, 0.01 / - 0.34, 0.01	0.21, 0.17 / - 0.38, 0.02	0.32, 0.02 / - 0.40, 0.03	0.34, 0.02 / - 0.34, 0.03
Breath rate	Expiratory pressure (cm H ₂ O [hPa]) (Means, Standard Deviations)					
	2	6	12	17	21	25
10 BPM	-0.14, 0.01 / - 0.27, 0.01	-0.16, 0.01 / - 0.29, 0.02	-0.11, 0.10 / - 0.34, 0.02	-0.16, 0.05 / - 0.33, 0.01	-0.17, 0.05 / - 0.33, 0.02	0.04, 0.17 / - 0.21, 0.01
15 BPM	-0.16, 0.01 / - 0.25, 0.01	-0.20, 0.01 / - 0.33, 0.02	-0.20, 0.05 / - 0.35, 0.01	-0.21, 0.05 / - 0.38, 0.02	-0.23, 0.08 / - 0.38, 0.02	0.04, 0.21 / - 0.25, 0.01
20 BPM	-0.27, 0.01 / - 0.37, 0.01	-0.26, 0.02 / - 0.34, 0.01	-0.25, 0.01 / - 0.38, 0.01	-0.29, 0.01 / - 0.43, 0.02	-0.31, 0.01 / - 0.45, 0.03	-0.13, 0.23 / - 0.31, 0.01

Device without humidification and SlimLine air tubing / Device with humidification and SlimLine air tubing

Breath rate	Inspiratory pressure (cm H ₂ O [hPa]) (Means, Standard Deviations)					
	6	10	16	21	25	30
10 BPM	-0.26, 0.01 / - 0.52, 0.01	-0.25, 0.02 / - 0.53, 0.02	-0.24, 0.02 / - 0.53, 0.01	-0.25, 0.02 / - 0.54, 0.02	-0.20, 0.02 / - 0.51, 0.02	-0.07, 0.09 / - 0.18, 0.02
15 BPM	-0.26, 0.01 / - 0.51, 0.01	-0.25, 0.01 / - 0.54, 0.01	-0.26, 0.01 / - 0.56, 0.01	-0.31, 0.03 / - 0.58, 0.02	-0.30, 0.05 / - 0.60, 0.03	0.18, 0.08 / - 0.25, 0.02
20 BPM	-0.25, 0.02 / - 0.52, 0.01	-0.29, 0.02 / - 0.58, 0.01	-0.34, 0.02 / - 0.62, 0.01	-0.36, 0.02 / - 0.67, 0.02	-0.36, 0.03 / - 0.69, 0.02	0.36, 0.02 / - 0.40, 0.02
Breath rate	Expiratory pressure (cm H ₂ O [hPa]) (Means, Standard Deviations)					
	2	6	12	17	21	25
10 BPM	-0.28, 0.01 / - 0.43, 0.01	-0.30, 0.03 / - 0.50, 0.01	-0.30, 0.01 / - 0.54, 0.01	-0.33, 0.01 / - 0.58, 0.01	-0.34, 0.01 / - 0.60, 0.02	-0.27, 0.01 / - 0.30, 0.01
15 BPM	-0.24, 0.02 / - 0.37, 0.01	-0.29, 0.02 / - 0.47, 0.01	-0.35, 0.01 / - 0.55, 0.01	-0.38, 0.01 / - 0.62, 0.02	-0.42, 0.02 / - 0.66, 0.01	-0.33, 0.01 / - 0.36, 0.01
20 BPM	0.05, 0.21 / - 0.38, 0.01	-0.31, 0.02 / - 0.50, 0.02	-0.37, 0.02 / - 0.57, 0.02	-0.43, 0.02 / - 0.65, 0.02	-0.48, 0.02 / - 0.68, 0.02	-0.43, 0.02 / - 0.45, 0.01

Note: The table above is based on data that covers between 60.1 and 88.8% of the inspiratory phase and 66.1 and 93.4% of the expiratory phase durations. These data time slots start immediately after the initial transient overshoot/undershoot periods and end at the point that flow diminishes to an equivalent absolute value of its starting point, towards the end of the breath phases (this corresponds to the % ranges of values given immediately above).

Flow (maximum) at set pressures

The following are measured accordingly to ISO 80601-2-70:2015 at the end of the specified air tubing:

Pressure cm H ₂ O (hPa)	AirCurve 10 and Standard L/min	AirCurve 10, humidification and Standard L/min	AirCurve 10 and SlimLine L/min	AirCurve 10, humidification and ClimateLineAir L/min
4	180	143	162	151
8	168	135	151	142
12	157	136	140	135
16	144	134	128	121
20	131	123	117	109
25	120	115	96	84

Guidance and manufacturer's declaration electromagnetic emissions and immunity

Medical electrical equipment needs special precautions regarding EMC and needs to be installed and put into service according to EMC information provided in this document.

The AirCurve 10 device has been designed to meet EMC standards. However, should you suspect that the device performance (eg, pressure or flow) is affected by other equipment, move the device away from the possible cause of interference.

Guidance and manufacturer's declaration—electromagnetic emissions

The device is intended for use in the electromagnetic environment specified below. The customer or the user of the device should assure that the device is used in such an environment.

Emissions test	Compliance	Electromagnetic environment — guidance
RF emissions CISPR 11	Group 1	The device uses RF energy only for its internal function. Therefore, its RF emissions are very low and are not likely to cause any interference in nearby electronic equipment.
RF emissions CISPR 11	Class B	The device is suitable for use in all establishments, including domestic establishments and those directly connected to the public low-voltage network that supplies buildings used for domestic purposes.
Harmonic Emissions IEC 61000-3-2	Class A	
Voltage Fluctuations/Flicker Emissions IEC 61000-3-3	Complies	

Guidance and manufacturer's declaration – electromagnetic immunity

The device is intended for use in the electromagnetic environment specified below. The customer or the user of the device should assure that the device is used in such an environment.

Immunity test	IEC60601-1-2 test level	Compliance level	Electromagnetic environment — guidance
Electrostatic discharge (ESD) IEC 61000-4-2	±6 kV contact ±8 kV air	±8 kV contact ±15 kV air	Floors should be wood, concrete or ceramic tile. If floors are covered with synthetic material, the relative humidity should be at least 30%.
Electrical fast transient/burst IEC 61000-4-4	±2 kV for power supply lines ±1 kV for input/output lines	±2 kV ±1 kV for input/output lines	Mains power quality should be that of a typical commercial or hospital environment.

Immunity test	IEC60601-1-2 test level	Compliance level	Electromagnetic environment — guidance
Surge IEC 61000-4-5	±1 kV differential mode ±2 kV common mode	±1 kV differential mode ±2 kV common mode	Mains power quality should be that of a typical commercial or hospital environment.
Voltage dips, short interruptions and voltage variations on power supply input lines IEC 61000-4-11	<5% U_t (>95% dip in U_t) for 0.5 cycle 40% U_t (60% dip in U_t) for 5 cycles 70% U_t (30% dip in U_t) for 25 cycles <5% U_t (>95% dip in U_t) for 5 sec	100V 240V	Mains power quality should be that of a typical commercial or hospital environment. If the user of the device requires continued operation during power mains interruptions, it is recommended that the device be powered from an uninterruptible power source.
Power frequency (50/60 Hz) magnetic field IEC 61000-4-8	3 A/m	30 A/m	Power frequency magnetic fields should be at levels characteristic of a typical location in a typical commercial or hospital environment.
Conducted RF IEC 61000-4-6	3 Vrms 150 kHz to 80 MHz	3 Vrms 150 kHz to 80 MHz	Portable and mobile RF communications equipment should be used no closer to any part of the device, including cables, than the recommended separation distance calculated from the equation applicable to the frequency of the transmitter.
Radiated RF IEC 61000-4-3	3 V/m 80 MHz to 2.5 GHz	10 V/m 80 MHz to 2.5 GHz	Recommended separation distance $d = 0.35 \sqrt{P}$ $d = 0.35 \sqrt{P}$ 80 MHz to 800 MHz $d = 0.70 \sqrt{P}$ 800 MHz to 2.5 GHz Where (P) is the maximum output power rating of the transmitter in watts (W) according to the transmitter manufacturer and d is the recommended separation distance in meters (m). Field strengths from fixed RF transmitters, as determined by an electromagnetic site survey, ^a should be less than the compliance level in each frequency range. ^b Interference may occur in the vicinity of equipment marked with the following symbol: 

^a Field strengths from fixed transmitters, such as base stations for radio (cellular/cordless) telephones and land mobile radios, amateur radio, AM and FM radio broadcast and TV broadcast cannot be predicted theoretically with accuracy. To assess the electromagnetic environment due to fixed RF transmitters, an electromagnetic site survey should be considered. If the measured field strength in the location in which the device is used exceeds the applicable RF compliance level above, the device should be observed to verify normal operation. If abnormal performance is observed, additional measures may be necessary, such as reorienting or relocating the device.

^b Over the frequency range 150 kHz to 80 MHz, field strengths should be less than 3 V/m.

Notes:

- U_t is the AC mains voltage prior to application of the test level.
- At 80 MHz and 800 MHz, the higher frequency range applies.
- These guidelines may not apply in all situations. Electromagnetic propagation is affected by absorption and reflection from structures, objects and people.

Recommended separation distances between portable and mobile RF communications equipment and the device

The device is intended for use in an environment in which radiated RF disturbances are controlled. The customer or the user of the device can help prevent electromagnetic interference by maintaining a minimum distance between portable and mobile RF communications equipment (transmitters) and the device as recommended below, according to the maximum output power of the communications equipment.

Rated maximum output power of transmitter (W)	Separation distance according to frequency of transmitter (m)		
	150 kHz to 80 MHz $d = 0.35 \sqrt{P}$	80 MHz to 800 MHz $d = 0.35 \sqrt{P}$	800 MHz to 2.5 GHz $d = 0.7 \sqrt{P}$
0.01	0.035	0.035	0.070
0.1	0.11	0.11	0.22
1	0.35	0.35	0.70
10	1.1	1.1	2.2
100	3.5	3.5	7.0

























For transmitters rated at a maximum output power not listed above, the recommended separation distance d in metres (m) can be determined using the equation applicable to the frequency of the transmitter, where P is the maximum output power rating of the transmitter in watts (W) according to the transmitter manufacturer.

Notes:

- At 80 MHz and 800 MHz, the separation distance for the higher frequency range applies.
- These guidelines may not apply in all situations. Electromagnetic propagation is affected by absorption and reflection from structures, objects and people.

Symbols

The following symbols may appear on the product or packaging.

 Read instructions before use.  Indicates a warning or caution.  Follow instructions before use.  Manufacturer.  EC REP European Authorized Representative.  LOT Batch code.  REF Catalog number.  SN Serial number.  DN Device number.  On / Off.  Device weight. **IP22** Protected against finger sized objects and against dripping water when tilted up to 15 degrees from specified orientation.  Direct current.  Type BF applied part.  Class II equipment.  Humidity limitation.  Temperature limitation.  Non-ionising radiation.  China pollution control logo 1.  China pollution control logo 2. **Rx Only** Prescription only (In the US, Federal law restricts these devices to sale by or on the order of a physician).  **MAX** Maximum water level.  Use distilled water only.  Operating altitude.  Atmospheric pressure limitation.  Complies with RTCA DO-160 section 21, category M.  MR unsafe (do not use in the vicinity of an MRI device).



Environmental information

This device should be disposed of separately, not as unsorted municipal waste. To dispose of your device, you should use appropriate collection, reuse and recycling systems available in your region. The use of these collection, reuse and recycling systems is designed to reduce pressure on natural resources and prevent hazardous substances from damaging the environment.

If you need information on these disposal systems, please contact your local waste administration. The crossed-bin symbol invites you to use these disposal systems. If you require information on collection and disposal of your ResMed device please contact your ResMed office, local distributor or go to www.resmed.com/environment.

Servicing

The AirCurve 10 device is intended to provide safe and reliable operation when operated in accordance with the instructions provided by ResMed. ResMed recommends that the AirCurve 10 device be inspected and serviced by an authorized ResMed Service Centre if there is any sign of wear or concern with device function. Otherwise, service and inspection of the products generally should not be required during their design life.

Limited warranty

ResMed Ltd (hereafter 'ResMed') warrants that your ResMed product shall be free from defects in material and workmanship from the date of purchase for the period specified below.

Product	Warranty period
<ul style="list-style-type: none"> Mask systems (including mask frame, cushion, headgear and tubing)—excluding single-use devices Accessories—excluding single-use devices Flex-type finger pulse sensors Humidifier water tubs 	90 days
<ul style="list-style-type: none"> Batteries for use in ResMed internal and external battery systems 	6 months
<ul style="list-style-type: none"> Clip-type finger pulse sensors CPAP and bilevel device data modules Oximeters and CPAP and bilevel device oximeter adapters Humidifier cleanable water tubs Titration control devices 	1 year
<ul style="list-style-type: none"> CPAP, bilevel and ventilation devices (including external power supply units) Humidifiers Battery accessories Portable diagnostic/screening devices 	2 years

This warranty is only available to the initial consumer. It is not transferable.

If the product fails under conditions of normal use, ResMed will repair or replace, at its option, the defective product or any of its components.

This Limited Warranty does not cover: a) any damage caused as a result of improper use, abuse, modification or alteration of the product; b) repairs carried out by any service organization that has not been expressly authorized by ResMed to perform such repairs; and c) any damage or contamination due to cigarette, pipe, cigar or other smoke.

Warranty is void on product sold, or resold, outside the region of original purchase.

Warranty claims on defective product must be made by the initial consumer at the point of purchase.

This warranty replaces all other expressed or implied warranties, including any implied warranty of merchantability or fitness for a particular purpose. Some regions or states do not allow limitations on how long an implied warranty lasts, so the above limitation may not apply to you.

ResMed shall not be responsible for any incidental or consequential damages claimed to have resulted from the sale, installation or use of any ResMed product. Some regions or states do not allow the exclusion or limitation of incidental or consequential damages, so the above limitation may not apply to you.

This warranty gives you specific legal rights, and you may also have other rights which vary from region to region. For further information on your warranty rights, contact your local ResMed dealer or ResMed office.

Further information

If you have any questions or require additional information on how to use the device, contact your care provider.



ResMed Ltd

MANUFACTURER 1 Elizabeth Macarthur Drive Bella Vista NSW 2153 Australia

See ResMed.com for other ResMed locations worldwide. Air10, AirCurve, ClimateLine, SlimLine, HumidAir, SmartStart and VPAP are trademarks and/or registered trademarks of the ResMed family of companies. For patent and other intellectual property information, see ResMed.com/ip. SD Logo is a trademark of SD-3C, LLC. © 2018 ResMed Ltd. 288156/1 2018-07

ResMed.com



288156