

FCC Test Report

Report No.: RF160104C01-1

FCC ID: VPYLB1GC

Test Model: Type1GC

Received Date: Jan. 04, 2016

Test Date: Feb. 16 ~ Mar. 31, 2016

Issued Date: Apr. 21, 2016

Applicant: Murata Manufacturing Co., Ltd.

Address: 10-1, Higashikotari 1-chome, Nagaokakyo-shi, Kyoto 617-8555, Japan

Issued By: Bureau Veritas Consumer Products Services (H.K.) Ltd., Taoyuan Branch

Lab Address: No. 47-2, 14th Ling, Chia Pau Vil., Lin Kou Dist., New Taipei City, Taiwan, R.O.C.

Test Location: No. 19, Hwa Ya 2nd Rd., Wen Hwa Vil., Kwei Shan Dist., Taoyuan City 33383, TAIWAN (R.O.C.)



This report is for your exclusive use. Any copying or replication of this report to or for any other person or entity, or use of our name or trademark, is permitted only with our prior written permission. This report sets forth our findings solely with respect to the test samples identified herein. The results set forth in this report are not indicative or representative of the quality or characteristics of the lot from which a test sample was taken or any similar or identical product unless specifically and expressly noted. Our report includes all of the tests requested by you and the results thereof based upon the information that you provided to us. You have 60 days from date of issuance of this report to notify us of any material error or omission caused by our negligence, provided, however, that such notice shall be in writing and shall specifically address the issue you wish to raise. A failure to raise such issue within the prescribed time shall constitute your unqualified acceptance of the completeness of this report, the tests conducted and the correctness of the report contents. Unless specific mention, the uncertainty of measurement has been explicitly taken into account to declare the compliance or non-compliance to the specification. The report must not be used by the client to claim product certification, approval, or endorsement by TAF or any government agencies.

Table of Contents

Release Control Record	4
1 Certificate of Conformity	5
2 Summary of Test Results	6
2.1 Measurement Uncertainty.....	6
2.2 Modification Record.....	6
3 General Information	7
3.1 General Description of EUT.....	7
3.2 Description of Test Modes.....	8
3.2.1 Test Mode Applicability and Tested Channel Detail.....	10
3.3 Duty Cycle of Test Signal.....	12
3.4 Description of Support Units.....	13
3.4.1 Configuration of System under Test.....	13
3.5 General Description of Applied Standards.....	13
4 Test Types and Results	14
4.1 Radiated Emission and Bandedge Measurement.....	14
4.1.1 Limits of Radiated Emission and Bandedge Measurement.....	14
4.1.2 Test Instruments.....	15
4.1.3 Test Procedures.....	16
4.1.4 Deviation from Test Standard.....	16
4.1.5 Test Set Up.....	17
4.1.6 EUT Operating Conditions.....	17
4.1.7 Test Results.....	18
4.2 Conducted Emission Measurement.....	55
4.2.1 Limits of Conducted Emission Measurement.....	55
4.2.2 Test Instruments.....	55
4.2.3 Test Procedures.....	56
4.2.4 Deviation from Test Standard.....	56
4.2.5 Test Setup.....	56
4.2.6 EUT Operating Conditions.....	56
4.2.7 Test Results.....	57
4.3 Transmit Power Measurement.....	59
4.3.1 Limits of Transmit Power Measurement.....	59
4.3.2 Test Setup.....	59
4.3.3 Test Instruments.....	59
4.3.4 Test Procedure.....	60
4.3.5 Deviation from Test Standard.....	60
4.3.6 EUT Operating Conditions.....	60
4.3.7 Test Result.....	61
4.4 Peak Power Spectral Density Measurement.....	69
4.4.1 Limits of Peak Power Spectral Density Measurement.....	69
4.4.2 Test Setup.....	69
4.4.3 Test Instruments.....	69
4.4.4 Test Procedures.....	70
4.4.5 Deviation from Test Standard.....	70
4.4.6 EUT Operating Conditions.....	70
4.4.7 Test Results.....	71
4.5 Frequency Stability.....	76
4.5.1 Limits of Frequency Stability Measurement.....	76
4.5.2 Test Setup.....	76
4.5.3 Test Instruments.....	76
4.5.4 Test Procedure.....	76
4.5.5 Deviation from Test Standard.....	76
4.5.6 EUT Operating Condition.....	76



4.5.7 Test Results	77
4.6 6dB Bandwidth Measurement.....	78
4.6.1 Limits of 6dB Bandwidth Measurement.....	78
4.6.2 Test Setup.....	78
4.6.3 Test Instruments	78
4.6.4 Test Procedure	78
4.6.5 Deviation from Test Standard	78
4.6.6 EUT Operating Condition	78
4.6.7 Test Results	79
5 Pictures of Test Arrangements.....	81
Appendix – Information on the Testing Laboratories	82



A D T

Release Control Record

Issue No.	Description	Date Issued
RF160104C01-1	Original release	Apr. 21, 2016



A D T

1 Certificate of Conformity

Product: Communication Module
Brand: MURATA
Test Model: Type1GC
Sample Status: Engineering sample
Applicant: Murata Manufacturing Co., Ltd.
Test Date: Feb. 16 ~ Mar. 31, 2016
Standards: 47 CFR FCC Part 15, Subpart E (Section 15.407)
ANSI C63.10:2013

The above equipment has been tested by **Bureau Veritas Consumer Products Services (H.K.) Ltd., Taoyuan Branch**, and found compliance with the requirement of the above standards. The test record, data evaluation & Equipment Under Test (EUT) configurations represented herein are true and accurate accounts of the measurements of the sample's EMC characteristics under the conditions specified in this report.

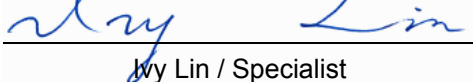
Prepared by :  , **Date:** Apr. 21, 2016
Ivy Lin / Specialist

Approved by :  , **Date:** Apr. 21, 2016
Ken Liu / Senior Manager

2 Summary of Test Results

47 CFR FCC Part 15, Subpart E (SECTION 15.407)			
FCC Clause	Test Item	Result	Remarks
15.407(b)(6)	AC Power Conducted Emissions	Pass	Meet the requirement of limit. Minimum passing margin is -20.72dB at 0.42344MHz.
15.407(b)(1/2/3/4/6)	Radiated Emissions & Band Edge Measurement	Pass	Meet the requirement of limit. Minimum passing margin is -1.2dB at 5150.00MHz.
15.407(a)(1/2/3)	Max Average Transmit Power	Pass	Meet the requirement of limit.
15.407(a)(1/2/3)	Peak Power Spectral Density	Pass	Meet the requirement of limit.
15.407(e)	6dB bandwidth	Pass	Meet the requirement of limit. (U-NII-3 Band only)
15.407(g)	Frequency Stability	Pass	Meet the requirement of limit.
15.203	Antenna Requirement	Pass	No antenna connector is used.

2.1 Measurement Uncertainty

Where relevant, the following measurement uncertainty levels have been estimated for tests performed on the EUT as specified in CISPR 16-4-2:

Measurement	Frequency	Expanded Uncertainty (k=2) (±)
Conducted Emissions at mains ports	150kHz ~ 30MHz	2.44 dB
Radiated Emissions up to 1 GHz	30MHz ~ 200MHz	3.86 dB
	200MHz ~ 1000MHz	3.87 dB
Radiated Emissions above 1 GHz	1GHz ~ 18GHz	2.29 dB
	18GHz ~ 40GHz	2.29 dB

2.2 Modification Record

There were no modifications required for compliance.

3 General Information

3.1 General Description of EUT

Product	Communication Module
Brand	MURATA
Test Model	Type1GC
Status of EUT	Engineering sample
Power Supply Rating	3.6Vdc (host)
Modulation Type	64QAM, 16QAM, QPSK, BPSK
Modulation Technology	OFDM
Transfer Rate	802.11a: 54.0/ 48.0/ 36.0/ 24.0/ 18.0/ 12.0/ 9.0/ 6.0Mbps 802.11n: up to 135Mbps
Operating Frequency	5180 ~ 5240MHz, 5260 ~ 5320MHz, 5500 ~ 5720MHz & 5745 ~ 5825MHz
Number of Channel	5180 ~ 5240MHz: 4 for 802.11a, 802.11n (HT20) 2 for 802.11n (HT40) 5260 ~ 5320MHz: 4 for 802.11a, 802.11n (HT20) 2 for 802.11n (HT40) 5500 ~ 5720MHz: 12 for 802.11a, 802.11n (HT20) 6 for 802.11n (HT40) 5745 ~ 5825MHz: 5 for 802.11a, 802.11n (HT20) 2 for 802.11n (HT40)
Output Power	5180 ~ 5240MHz: 19.724mW 5260 ~ 5320MHz: 20.137mW 5500 ~ 5720MHz: 19.588mW 5745 ~ 5825MHz: 18.923mW
Antenna Type	Monopole pattern antenna with 2.5dBi gain
Antenna Connector	NA
Accessory Device	NA
Data Cable Supplied	NA

Note:

1. The EUT provides 1 completed transmitter and 1 receiver.

Modulation Mode	TX Function
802.11a	1TX
802.11n (HT20)	1TX
802.11n (HT40)	1TX

2. The 2.4GHz and 5GHz cannot transmit simultaneously.

3.2 Description of Test Modes

FOR 5180 ~ 5240MHz:

4 channels are provided for 802.11a, 802.11n (HT20):

Channel	Frequency	Channel	Frequency
36	5180 MHz	44	5220 MHz
40	5200 MHz	48	5240 MHz

2 channels are provided for 802.11n (HT40):

Channel	Frequency	Channel	Frequency
38	5190 MHz	46	5230 MHz

FOR 5260 ~ 5320MHz:

4 channels are provided for 802.11a, 802.11n (HT20):

Channel	Frequency	Channel	Frequency
52	5260 MHz	60	5300 MHz
56	5280 MHz	64	5320 MHz

2 channels are provided for 802.11n (HT40):

Channel	Frequency	Channel	Frequency
54	5270 MHz	62	5310 MHz

FOR 5500 ~ 5720MHz:

12 channels are provided for 802.11a, 802.11n (HT20):

Channel	Frequency	Channel	Frequency
100	5500 MHz	124	5620 MHz
104	5520 MHz	128	5640 MHz
108	5540 MHz	132	5660 MHz
112	5560 MHz	136	5680 MHz
116	5580 MHz	140	5700 MHz
120	5600 MHz	144	5720 MHz

6 channels are provided for 802.11n (HT40):

Channel	Frequency	Channel	Frequency
102	5510 MHz	126	5630 MHz
110	5550 MHz	134	5670 MHz
118	5590 MHz	142	5710 MHz

FOR 5745 ~ 5825MHz:

5 channels are provided for 802.11a, 802.11n (HT20):

Channel	Frequency	Channel	Frequency
149	5745 MHz	161	5805 MHz
153	5765 MHz	165	5825 MHz
157	5785 MHz		

2 channels are provided for 802.11n (HT40):

Channel	Frequency	Channel	Frequency
151	5755 MHz	159	5795 MHz

3.2.1 Test Mode Applicability and Tested Channel Detail

EUT CONFIGURE MODE	APPLICABLE TO				DESCRIPTION
	RE≥1G	RE<1G	PLC	APCM	
-	√	√	√	√	-

Where **RE≥1G**: Radiated Emission above 1GHz & Bandedge Measurement
RE<1G: Radiated Emission below 1GHz
PLC: Power Line Conducted Emission
APCM: Antenna Port Conducted Measurement

Note: The EUT had been pre-tested on the positioned of each 3 axis. The worst case was found when positioned on **X-plane**.

Radiated Emission Test (Above 1GHz):

Pre-Scan has been conducted to determine the worst-case mode from all possible combinations between available modulations, data rates and antenna ports (if EUT with antenna diversity architecture).

Following channel(s) was (were) selected for the final test as listed below.

EUT CONFIGURE MODE	MODE	FREQ. BAND (MHz)	AVAILABLE CHANNEL	TESTED CHANNEL	MODULATION TECHNOLOGY	MODULATION TYPE	DATA RATE (Mbps)
-	802.11a	5180-5240	36 to 48	36, 40, 48	OFDM	BPSK	6.0
-	802.11n (HT20)		36 to 48	36, 40, 48	OFDM	BPSK	6.5
-	802.11n (HT40)		38 to 46	38, 46	OFDM	BPSK	13.5
-	802.11a	5260-5320	52 to 64	52, 60, 64	OFDM	BPSK	6.0
-	802.11n (HT20)		52 to 64	52, 60, 64	OFDM	BPSK	6.5
-	802.11n (HT40)		54 to 62	54, 62	OFDM	BPSK	13.5
-	802.11a	5500-5720	100 to 144	100, 116, 140, 144	OFDM	BPSK	6.0
-	802.11n (HT20)		100 to 144	100, 116, 140, 144	OFDM	BPSK	6.5
-	802.11n (HT40)		102 to 142	102, 110, 134, 142	OFDM	BPSK	13.5
-	802.11a	5745-5825	149 to 165	149, 157, 165	OFDM	BPSK	6.0
-	802.11n (HT20)		149 to 165	149, 157, 165	OFDM	BPSK	6.5
-	802.11n (HT40)		151 to 159	151, 159	OFDM	BPSK	13.5

Radiated Emission Test (Below 1GHz):

Pre-Scan has been conducted to determine the worst-case mode from all possible combinations between available modulations, data rates and antenna ports (if EUT with antenna diversity architecture).

Following channel(s) was (were) selected for the final test as listed below.

EUT CONFIGURE MODE	MODE	FREQ. BAND (MHz)	AVAILABLE CHANNEL	TESTED CHANNEL	MODULATION TECHNOLOGY	MODULATION TYPE	DATA RATE (Mbps)
-	802.11a	5180-5240	36 to 48	60	OFDM	BPSK	6.0
	802.11a	5260-5320	52 to 64		OFDM	BPSK	6.0
	802.11a	5500-5720	100 to 144		OFDM	BPSK	6.0
	802.11a	5745-5825	149 to 165		OFDM	BPSK	6.0

Power Line Conducted Emission Test:

- Pre-Scan has been conducted to determine the worst-case mode from all possible combinations between available modulations, data rates and antenna ports (if EUT with antenna diversity architecture).
- Following channel(s) was (were) selected for the final test as listed below.

EUT CONFIGURE MODE	MODE	FREQ. BAND (MHz)	AVAILABLE CHANNEL	TESTED CHANNEL	MODULATION TECHNOLOGY	MODULATION TYPE	DATA RATE (Mbps)
-	802.11a	5180-5240	36 to 48	60	OFDM	BPSK	6.0
	802.11a	5260-5320	52 to 64		OFDM	BPSK	6.0
	802.11a	5500-5720	100 to 144		OFDM	BPSK	6.0
	802.11a	5745-5825	149 to 165		OFDM	BPSK	6.0

Antenna Port Conducted Measurement:

- This item includes all test value of each mode, but only includes spectrum plot of worst value of each mode.
- Pre-Scan has been conducted to determine the worst-case mode from all possible combinations between available modulations, data rates and antenna ports (if EUT with antenna diversity architecture).
- Following channel(s) was (were) selected for the final test as listed below.

EUT CONFIGURE MODE	MODE	FREQ. BAND (MHz)	AVAILABLE CHANNEL	TESTED CHANNEL	MODULATION TECHNOLOGY	MODULATION TYPE	DATA RATE (Mbps)
-	802.11a	5180-5240	36 to 48	36, 40, 48	OFDM	BPSK	6.0
-	802.11n (HT20)		36 to 48	36, 40, 48	OFDM	BPSK	6.5
-	802.11n (HT40)		38 to 46	38, 46	OFDM	BPSK	13.5
-	802.11a	5260-5320	52 to 64	52, 60, 64	OFDM	BPSK	6.0
-	802.11n (HT20)		52 to 64	52, 60, 64	OFDM	BPSK	6.5
-	802.11n (HT40)		54 to 62	54, 62	OFDM	BPSK	13.5
-	802.11a	5500-5720	100 to 144	100, 116, 140, 144	OFDM	BPSK	6.0
-	802.11n (HT20)		100 to 144	100, 116, 140, 144	OFDM	BPSK	6.5
-	802.11n (HT40)		102 to 142	102, 110, 134, 142	OFDM	BPSK	13.5
-	802.11a	5745-5825	149 to 165	149, 157, 165	OFDM	BPSK	6.0
-	802.11n (HT20)		149 to 165	149, 157, 165	OFDM	BPSK	6.5
-	802.11n (HT40)		151 to 159	151, 159	OFDM	BPSK	13.5

Test Condition:

APPLICABLE TO	ENVIRONMENTAL CONDITIONS	INPUT POWER (System)	TESTED BY
RE _≥ 1G	18deg. C, 70%RH, 19deg. C, 70%RH	120Vac, 60Hz	Jones Chang
RE _{<} 1G	20deg. C, 70%RH	120Vac, 60Hz	Jones Chang
PLC	25deg. C, 65%RH	120Vac, 60Hz	Jones Chang
APCM	25deg. C, 60%RH	120Vac, 60Hz	Antony Lee

3.3 Duty Cycle of Test Signal

Duty cycle of test signal is < 98%, duty factor is required.

802.11a: Duty cycle = $1.427/1.472 = 0.969$, Duty factor = $10 * \log(1/0.969) = 0.13$

802.11n (HT20): Duty cycle = $0.168/0.190 = 0.884$, Duty factor = $10 * \log(1/0.884) = 0.53$

802.11n (HT40): Duty cycle = $0.098/0.143 = 0.685$, Duty factor = $10 * \log(1/0.685) = 1.64$

802.11a

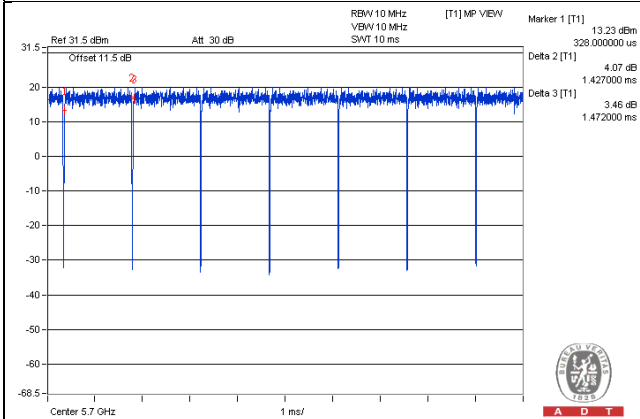

802.11n (HT20)

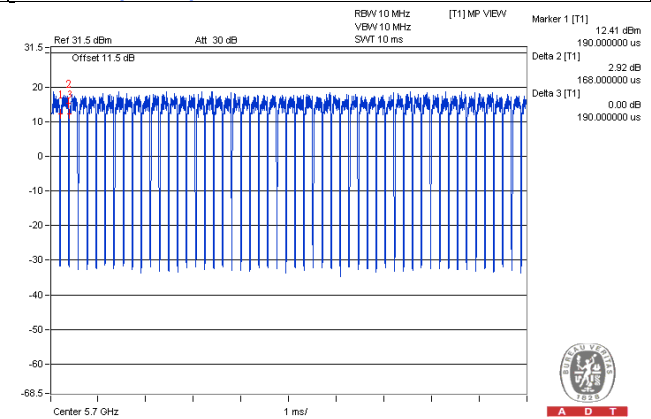

802.11n (HT40)

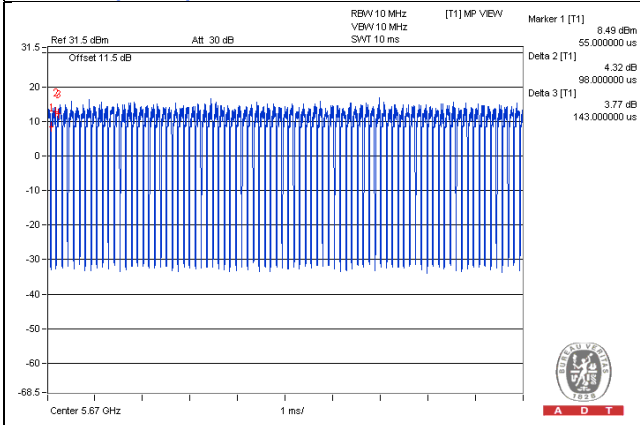

3.4 Description of Support Units

The EUT has been tested as an independent unit together with other necessary accessories or support units. The following support units or accessories were used to form a representative test configuration during the tests.

ID	Product	Brand	Model No.	Serial No.	FCC ID	Remarks
A.	Power Supply	Topward	6603D	700637	NA	-
B.	Convertible board	NA	NA	NA	NA	-

Note:

1. All power cords of the above support units are non-shielded (1.8m).

ID	Descriptions	Qty.	Length (m)	Shielding (Yes/No)	Cores (Qty.)	Remarks
1.	DC	4	1.8	-	0	-

3.4.1 Configuration of System under Test

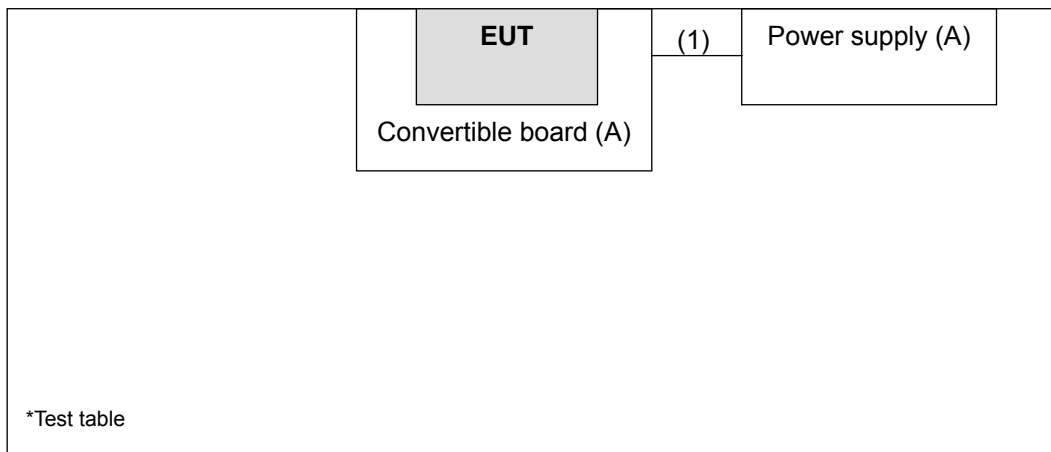

3.5 General Description of Applied Standards

The EUT is a RF Product. According to the specifications of the manufacturer, it must comply with the requirements of the following standards:

FCC Part 15, Subpart E (15.407)

789033 D02 General UNII Test Procedures New Rules v01r02

662911 D01 Multiple Transmitter Output v02r01

ANSI C63.10-2013

All test items have been performed and recorded as per the above standards.

NOTE: The EUT has been verified to comply with the requirements of FCC Part 15, Subpart B, Class B (DoC). The test report has been issued separately.

4 Test Types and Results

4.1 Radiated Emission and Bandedge Measurement

4.1.1 Limits of Radiated Emission and Bandedge Measurement

Radiated emissions which fall in the restricted bands must comply with the radiated emission limits specified as below table. Other emissions shall be at least 20dB below the highest level of the desired power:

Frequencies (MHz)	Field Strength (microvolts/meter)	Measurement Distance (meters)
0.009 ~ 0.490	2400/F(kHz)	300
0.490 ~ 1.705	24000/F(kHz)	30
1.705 ~ 30.0	30	30
30 ~ 88	100	3
88 ~ 216	150	3
216 ~ 960	200	3
Above 960	500	3

NOTE:

1. The lower limit shall apply at the transition frequencies.
2. Emission level (dBuV/m) = 20 log Emission level (uV/m).
3. For frequencies above 1000MHz, the field strength limits are based on average detector, however, the peak field strength of any emission shall not exceed the maximum permitted average limits, specified above by more than 20dB under any condition of modulation.

LIMITS OF UNWANTED EMISSION OUT OF THE RESTRICTED BANDS

APPLICABLE TO	LIMIT	
789033 D02 General UNII Test Procedures New Rules v01r02	FIELD STRENGTH AT 3m	
	PK:74 (dBµV/m)	AV:54 (dBµV/m)
APPLICABLE TO	EIRP LIMIT	EQUIVALENT FIELD STRENGTH AT 3m
15.407(b)(1)	PK:-27 (dBm/MHz)	PK:68.2(dBµV/m)
15.407(b)(2)		
15.407(b)(3)		
15.407(b)(4)	PK:-27 (dBm/MHz) ^{*1} PK:-17 (dBm/MHz) ^{*2}	PK:68.2(dBµV/m) ^{*1} PK:78.2 (dBµV/m) ^{*2}

NOTE: ^{*1} beyond 10MHz of the band edge ^{*2} within 10 MHz of band edge

The following formula is used to convert the equipment isotropic radiated power (eirp) to field strength:

$$E = \frac{1000000\sqrt{30P}}{3} \mu\text{V/m, where P is the eirp (Watts).}$$

4.1.2 Test Instruments

Description & Manufacturer	Model No.	Serial No.	Cal. Date	Cal. Due
Test Receiver ROHDE & SCHWARZ	ESIB7	100187	Apr. 10, 2015	Apr. 09, 2016
Spectrum Analyzer ROHDE & SCHWARZ	FSP40	100041	Sep. 02, 2015	Sep. 01, 2016
BILOG Antenna SCHWARZBECK	VULB9168	9168-171	Jan. 07, 2016	Jan. 06, 2017
HORN Antenna SCHWARZBECK	9120D	209	Jan. 20, 2016	Jan. 19, 2017
HORN Antenna SCHWARZBECK	BBHA 9170	BBHA9170241	Jan. 18, 2016	Jan. 17, 2017
Preamplifier Agilent	8447D	2944A10738	Oct.18, 2015	Oct. 17, 2016
Preamplifier Agilent	8449B	3008A01964	Aug. 22, 2015	Aug. 21, 2016
RF signal cable HUBER+SUHNER	SUCOFLEX 104	Cable-CH3-03 (214378)	Aug. 22, 2015	Aug. 21, 2016
RF signal cable HUBER+SUHNER	SUCOFLEX 106	Cable-CH3-03 (309224+12738)	Aug. 22, 2015	Aug. 21, 2016
Software BV ADT	ADT_Radiated_ V7.6.15.9.4	NA	NA	NA
Antenna Tower inn-co GmbH	MA 4000	013303	NA	NA
Antenna Tower Controller BV ADT	AT100	AT93021702	NA	NA
Turn Table BV ADT	TT100	TT93021702	NA	NA
Turn Table Controller BV ADT	SC100	SC93021702	NA	NA
26GHz ~ 40GHz Amplifier	EM26400	815221	Oct. 18, 2015	Oct. 17, 2016
High Speed Peak Power Meter	ML2495A	0824011	Jul. 09, 2015	Jul. 08, 2016
Power Sensor	MA2411B	0738171	Jul. 09, 2015	Jul. 08, 2016
WIT Standard Temperature And Humidity Chamber	TH-4S-C	W981030	Jun. 08, 2015	Jun. 07, 2016

- Note: 1. The calibration interval of the above test instruments is 12 months and the calibrations are traceable to NML/ROC and NIST/USA.
 2. The test was performed in HwaYa Chamber 3.
 3. The horn antenna and preamplifier (model: 8449B) are used only for the measurement of emission frequency above 1GHz if tested.
 4. The FCC Site Registration No. is 988962.
 5. The IC Site Registration No. is IC 7450F-3.

4.1.3 Test Procedures

- a. The EUT was placed on the top of a rotating table 0.8 meters (for below 1GHz) / 1.5 meters (for above 1GHz) above the ground at 3 meter chamber room for test. The table was rotated 360 degrees to determine the position of the highest radiation.
- b. The EUT was set 3 meters away from the interference-receiving antenna, which was mounted on the top of a variable-height antenna tower.
- c. The height of antenna is varied from one meter to four meters above the ground to determine the maximum value of the field strength. Both horizontal and vertical polarizations of the antenna are set to make the measurement.
- d. For each suspected emission, the EUT was arranged to its worst case and then the antenna was tuned to heights from 1 meter to 4 meters and the rotatable table was turned from 0 degrees to 360 degrees to find the maximum reading.
- e. The test-receiver system was set to quasi-peak detect function and specified bandwidth with maximum hold mode when the test frequency is below 1 GHz.
- f. The test-receiver system was set to peak and average detect function and specified bandwidth with maximum hold mode when the test frequency is above 1 GHz. If the peak reading value also meets average limit, measurement with the average detector is unnecessary.

Note:

1. The resolution bandwidth and video bandwidth of test receiver/spectrum analyzer is 120kHz for Quasi-peak detection (QP) at frequency below 1GHz.
2. The resolution bandwidth of test receiver/spectrum analyzer is 1 MHz and the video bandwidth is 3 MHz for Peak detection (PK) at frequency above 1GHz.
3. The resolution bandwidth of test receiver/spectrum analyzer is 1MHz and the video bandwidth is 3MHz for RMS Average (Duty cycle < 98%) for Average detection (AV) at frequency above 1GHz, then the measurement results was added to a correction factor ($10 \log(1/\text{duty cycle})$).
4. The resolution bandwidth of test receiver/spectrum analyzer is 1MHz and the video bandwidth is 10Hz (Duty cycle $\geq 98\%$) for Average detection (AV) at frequency above 1GHz.
5. All modes of operation were investigated and the worst-case emissions are reported.

4.1.4 Deviation from Test Standard

No deviation.

4.1.5 Test Set Up

<Frequency Range 30MHz ~ 1GHz>

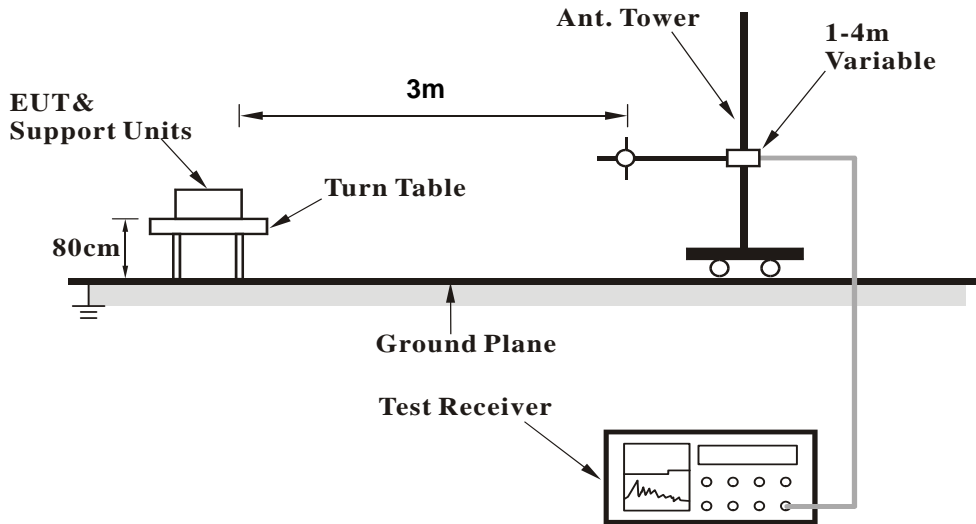

<Frequency Range above 1GHz>

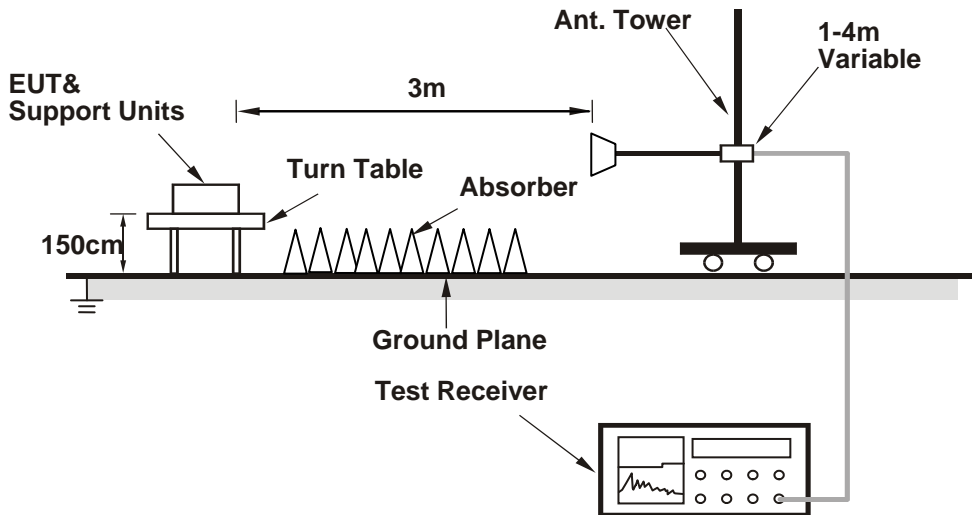

For the actual test configuration, please refer to the attached file (Test Setup Photo)

4.1.6 EUT Operating Conditions

Set the EUT under transmission condition continuously at specific channel frequency.

4.1.7 Test Results

Above 1GHz data:

802.11a

CHANNEL	TX Channel 36	DETECTOR FUNCTION	Peak (PK) Average (AV)
FREQUENCY RANGE	1GHz ~ 40GHz		

ANTENNA POLARITY & TEST DISTANCE: HORIZONTAL AT 3 M

NO.	FREQ. (MHz)	EMISSION LEVEL (dBuV/m)	LIMIT (dBuV/m)	MARGIN (dB)	ANTENNA HEIGHT (m)	TABLE ANGLE (Degree)	RAW VALUE (dBuV)	CORRECTION FACTOR (dB/m)
1	5150.00	62.3 PK	74.0	-11.7	1.22 H	59	56.30	6.00
2	5150.00	48.7 AV	54.0	-5.3	1.22 H	59	42.70	6.00
3	*5180.00	109.3 PK			1.20 H	63	69.90	39.40
4	*5180.00	99.3 AV			1.20 H	63	59.90	39.40
5	#10360.00	60.3 PK	74.0	-13.7	1.60 H	260	42.50	17.80
6	#10360.00	47.4 AV	54.0	-6.6	1.60 H	260	29.60	17.80

ANTENNA POLARITY & TEST DISTANCE: VERTICAL AT 3 M

NO.	FREQ. (MHz)	EMISSION LEVEL (dBuV/m)	LIMIT (dBuV/m)	MARGIN (dB)	ANTENNA HEIGHT (m)	TABLE ANGLE (Degree)	RAW VALUE (dBuV)	CORRECTION FACTOR (dB/m)
1	5150.00	59.5 PK	74.0	-14.5	1.87 V	280	53.50	6.00
2	5150.00	46.7 AV	54.0	-7.3	1.87 V	280	40.70	6.00
3	*5180.00	102.8 PK			1.87 V	277	63.40	39.40
4	*5180.00	91.4 AV			1.87 V	277	52.00	39.40
5	#10360.00	61.0 PK	74.0	-13.0	2.01 V	105	43.20	17.80
6	#10360.00	47.9 AV	54.0	-6.1	2.01 V	105	30.10	17.80

REMARKS:

1. Emission Level(dBuV/m) = Raw Value(dBuV) + Correction Factor(dB/m)
2. Correction Factor(dB/m) = Antenna Factor(dB/m) + Cable Factor(dB)
3. The other emission levels were very low against the limit.
4. Margin value = Emission Level – Limit value
5. " * ": Fundamental frequency.
6. " # ": The radiated frequency is out of the restricted band.



CHANNEL	TX Channel 40	DETECTOR FUNCTION	Peak (PK)
FREQUENCY RANGE	1GHz ~ 40GHz		Average (AV)

ANTENNA POLARITY & TEST DISTANCE: HORIZONTAL AT 3 M

NO.	FREQ. (MHz)	EMISSION LEVEL (dBuV/m)	LIMIT (dBuV/m)	MARGIN (dB)	ANTENNA HEIGHT (m)	TABLE ANGLE (Degree)	RAW VALUE (dBuV)	CORRECTION FACTOR (dB/m)
1	*5200.00	107.8 PK			1.57 H	63	68.30	39.50
2	*5200.00	98.2 AV			1.57 H	63	58.70	39.50
3	#10400.00	59.9 PK	74.0	-14.1	1.78 H	182	42.20	17.70
4	#10400.00	47.1 AV	54.0	-6.9	1.78 H	182	29.40	17.70

ANTENNA POLARITY & TEST DISTANCE: VERTICAL AT 3 M

NO.	FREQ. (MHz)	EMISSION LEVEL (dBuV/m)	LIMIT (dBuV/m)	MARGIN (dB)	ANTENNA HEIGHT (m)	TABLE ANGLE (Degree)	RAW VALUE (dBuV)	CORRECTION FACTOR (dB/m)
1	*5200.00	100.5 PK			1.80 V	274	61.00	39.50
2	*5200.00	89.5 AV			1.80 V	274	50.00	39.50
3	#10400.00	60.8 PK	74.0	-13.2	1.96 V	100	43.10	17.70
4	#10400.00	47.7 AV	54.0	-6.3	1.96 V	100	30.00	17.70

REMARKS:

1. Emission Level(dBuV/m) = Raw Value(dBuV) + Correction Factor(dB/m)
2. Correction Factor(dB/m) = Antenna Factor(dB/m) + Cable Factor(dB)
3. The other emission levels were very low against the limit.
4. Margin value = Emission Level – Limit value
5. " * ": Fundamental frequency.
6. " # ": The radiated frequency is out of the restricted band.

CHANNEL	TX Channel 48	DETECTOR FUNCTION	Peak (PK)
FREQUENCY RANGE	1GHz ~ 40GHz		Average (AV)

ANTENNA POLARITY & TEST DISTANCE: HORIZONTAL AT 3 M

NO.	FREQ. (MHz)	EMISSION LEVEL (dBuV/m)	LIMIT (dBuV/m)	MARGIN (dB)	ANTENNA HEIGHT (m)	TABLE ANGLE (Degree)	RAW VALUE (dBuV)	CORRECTION FACTOR (dB/m)
1	*5240.00	109.1 PK			1.57 H	68	69.50	39.60
2	*5240.00	99.6 AV			1.57 H	68	60.00	39.60
3	5350.00	58.1 PK	74.0	-15.9	1.57 H	55	51.60	6.50
4	5350.00	46.6 AV	54.0	-7.4	1.57 H	55	40.10	6.50
5	#10480.00	61.1 PK	74.0	-12.9	2.00 H	189	42.40	18.70
6	#10480.00	48.1 AV	54.0	-5.9	2.00 H	189	29.40	18.70

ANTENNA POLARITY & TEST DISTANCE: VERTICAL AT 3 M

NO.	FREQ. (MHz)	EMISSION LEVEL (dBuV/m)	LIMIT (dBuV/m)	MARGIN (dB)	ANTENNA HEIGHT (m)	TABLE ANGLE (Degree)	RAW VALUE (dBuV)	CORRECTION FACTOR (dB/m)
1	*5240.00	99.1 PK			1.82 V	275	59.50	39.60
2	*5240.00	89.7 AV			1.82 V	275	50.10	39.60
3	5350.00	58.2 PK	74.0	-15.8	1.80 V	280	51.70	6.50
4	5350.00	47.4 AV	54.0	-6.6	1.80 V	280	40.90	6.50
5	#10480.00	62.2 PK	74.0	-11.8	1.66 V	170	43.50	18.70
6	#10480.00	49.0 AV	54.0	-5.0	1.66 V	170	30.30	18.70

REMARKS:

1. Emission Level(dBuV/m) = Raw Value(dBuV) + Correction Factor(dB/m)
2. Correction Factor(dB/m) = Antenna Factor(dB/m) + Cable Factor(dB)
3. The other emission levels were very low against the limit.
4. Margin value = Emission Level – Limit value
5. " * ": Fundamental frequency.
6. " # ": The radiated frequency is out of the restricted band.



CHANNEL	TX Channel 52	DETECTOR FUNCTION	Peak (PK)
FREQUENCY RANGE	1GHz ~ 40GHz		Average (AV)

ANTENNA POLARITY & TEST DISTANCE: HORIZONTAL AT 3 M

NO.	FREQ. (MHz)	EMISSION LEVEL (dBuV/m)	LIMIT (dBuV/m)	MARGIN (dB)	ANTENNA HEIGHT (m)	TABLE ANGLE (Degree)	RAW VALUE (dBuV)	CORRECTION FACTOR (dB/m)
1	5150.00	56.6 PK	74.0	-17.4	1.19 H	273	50.60	6.00
2	5150.00	45.0 AV	54.0	-9.0	1.19 H	273	39.00	6.00
3	*5260.00	110.1 PK			1.10 H	66	70.50	39.60
4	*5260.00	100.1 AV			1.10 H	66	60.50	39.60
5	#10520.00	60.8 PK	74.0	-13.2	1.69 H	212	41.90	18.90
6	#10520.00	47.7 AV	54.0	-6.3	1.69 H	212	28.80	18.90

ANTENNA POLARITY & TEST DISTANCE: VERTICAL AT 3 M

NO.	FREQ. (MHz)	EMISSION LEVEL (dBuV/m)	LIMIT (dBuV/m)	MARGIN (dB)	ANTENNA HEIGHT (m)	TABLE ANGLE (Degree)	RAW VALUE (dBuV)	CORRECTION FACTOR (dB/m)
1	5150.00	55.9 PK	74.0	-18.1	1.79 V	122	49.90	6.00
2	5150.00	44.5 AV	54.0	-9.5	1.79 V	122	38.50	6.00
3	*5260.00	101.2 PK			1.80 V	275	61.60	39.60
4	*5260.00	91.9 AV			1.80 V	275	52.30	39.60
5	#10520.00	60.8 PK	74.0	-13.2	1.58 V	56	41.90	18.90
6	#10520.00	47.9 AV	54.0	-6.1	1.58 V	56	29.00	18.90

REMARKS:

1. Emission Level(dBuV/m) = Raw Value(dBuV) + Correction Factor(dB/m)
2. Correction Factor(dB/m) = Antenna Factor(dB/m) + Cable Factor(dB)
3. The other emission levels were very low against the limit.
4. Margin value = Emission Level – Limit value
5. " * ": Fundamental frequency.
6. " # ": The radiated frequency is out of the restricted band.

CHANNEL	TX Channel 60	DETECTOR FUNCTION	Peak (PK)
FREQUENCY RANGE	1GHz ~ 40GHz		Average (AV)

ANTENNA POLARITY & TEST DISTANCE: HORIZONTAL AT 3 M

NO.	FREQ. (MHz)	EMISSION LEVEL (dBuV/m)	LIMIT (dBuV/m)	MARGIN (dB)	ANTENNA HEIGHT (m)	TABLE ANGLE (Degree)	RAW VALUE (dBuV)	CORRECTION FACTOR (dB/m)
1	*5300.00	109.3 PK			1.15 H	69	69.60	39.70
2	*5300.00	100.0 AV			1.15 H	69	60.30	39.70
3	10600.00	61.0 PK	74.0	-13.0	1.74 H	232	42.10	18.90
4	10600.00	48.2 AV	54.0	-5.8	1.74 H	232	29.30	18.90

ANTENNA POLARITY & TEST DISTANCE: VERTICAL AT 3 M

NO.	FREQ. (MHz)	EMISSION LEVEL (dBuV/m)	LIMIT (dBuV/m)	MARGIN (dB)	ANTENNA HEIGHT (m)	TABLE ANGLE (Degree)	RAW VALUE (dBuV)	CORRECTION FACTOR (dB/m)
1	*5300.00	98.4 PK			1.81 V	243	58.70	39.70
2	*5300.00	89.0 AV			1.81 V	243	49.30	39.70
3	10600.00	61.5 PK	74.0	-12.5	1.59 V	352	42.60	18.90
4	10600.00	48.5 AV	54.0	-5.5	1.59 V	352	29.60	18.90

REMARKS:

1. Emission Level(dBuV/m) = Raw Value(dBuV) + Correction Factor(dB/m)
2. Correction Factor(dB/m) = Antenna Factor(dB/m) + Cable Factor(dB)
3. The other emission levels were very low against the limit.
4. Margin value = Emission Level – Limit value
5. " * ": Fundamental frequency.

CHANNEL	TX Channel 64	DETECTOR FUNCTION	Peak (PK)
FREQUENCY RANGE	1GHz ~ 40GHz		Average (AV)

ANTENNA POLARITY & TEST DISTANCE: HORIZONTAL AT 3 M

NO.	FREQ. (MHz)	EMISSION LEVEL (dBuV/m)	LIMIT (dBuV/m)	MARGIN (dB)	ANTENNA HEIGHT (m)	TABLE ANGLE (Degree)	RAW VALUE (dBuV)	CORRECTION FACTOR (dB/m)
1	*5320.00	111.4 PK			1.25 H	63	71.70	39.70
2	*5320.00	100.4 AV			1.25 H	63	60.70	39.70
3	5350.00	65.4 PK	74.0	-8.6	1.14 H	70	58.90	6.50
4	5350.00	50.1 AV	54.0	-3.9	1.14 H	70	43.60	6.50
5	10640.00	60.8 PK	74.0	-13.2	1.45 H	349	42.00	18.80
6	10640.00	48.0 AV	54.0	-6.0	1.45 H	349	29.20	18.80

ANTENNA POLARITY & TEST DISTANCE: VERTICAL AT 3 M

NO.	FREQ. (MHz)	EMISSION LEVEL (dBuV/m)	LIMIT (dBuV/m)	MARGIN (dB)	ANTENNA HEIGHT (m)	TABLE ANGLE (Degree)	RAW VALUE (dBuV)	CORRECTION FACTOR (dB/m)
1	*5320.00	98.2 PK			1.80 V	244	58.50	39.70
2	*5320.00	88.4 AV			1.80 V	244	48.70	39.70
3	5350.00	58.5 PK	74.0	-15.5	1.99 V	211	52.00	6.50
4	5350.00	47.0 AV	54.0	-7.0	1.99 V	211	40.50	6.50
5	10640.00	62.1 PK	74.0	-11.9	1.55 V	222	43.30	18.80
6	10640.00	49.2 AV	54.0	-4.8	1.55 V	222	30.40	18.80

REMARKS:

1. Emission Level(dBuV/m) = Raw Value(dBuV) + Correction Factor(dB/m)
2. Correction Factor(dB/m) = Antenna Factor(dB/m) + Cable Factor(dB)
3. The other emission levels were very low against the limit.
4. Margin value = Emission Level – Limit value
5. " * ": Fundamental frequency.

CHANNEL	TX Channel 100	DETECTOR FUNCTION	Peak (PK)
FREQUENCY RANGE	1GHz ~ 40GHz		Average (AV)

ANTENNA POLARITY & TEST DISTANCE: HORIZONTAL AT 3 M

NO.	FREQ. (MHz)	EMISSION LEVEL (dBuV/m)	LIMIT (dBuV/m)	MARGIN (dB)	ANTENNA HEIGHT (m)	TABLE ANGLE (Degree)	RAW VALUE (dBuV)	CORRECTION FACTOR (dB/m)
1	5460.00	63.7 PK	74.0	-10.3	1.17 H	66	56.80	6.90
2	5460.00	48.0 AV	54.0	-6.0	1.17 H	66	41.10	6.90
3	#5470.00	69.7 PK	74.0	-4.3	1.17 H	66	62.80	6.90
4	#5470.00	50.2 AV	54.0	-3.8	1.17 H	66	43.30	6.90
5	*5500.00	110.9 PK			1.12 H	65	70.70	40.20
6	*5500.00	101.4 AV			1.12 H	65	61.20	40.20
7	11000.00	62.3 PK	74.0	-11.7	1.58 H	240	42.40	19.90
8	11000.00	49.1 AV	54.0	-4.9	1.58 H	240	29.20	19.90

ANTENNA POLARITY & TEST DISTANCE: VERTICAL AT 3 M

NO.	FREQ. (MHz)	EMISSION LEVEL (dBuV/m)	LIMIT (dBuV/m)	MARGIN (dB)	ANTENNA HEIGHT (m)	TABLE ANGLE (Degree)	RAW VALUE (dBuV)	CORRECTION FACTOR (dB/m)
1	5460.00	59.6 PK	74.0	-14.4	1.91 V	20	52.70	6.90
2	5460.00	46.4 AV	54.0	-7.6	1.91 V	20	39.50	6.90
3	#5470.00	59.9 PK	74.0	-14.1	1.91 V	19	53.00	6.90
4	#5470.00	47.1 AV	54.0	-6.9	1.91 V	19	40.20	6.90
5	*5500.00	103.8 PK			1.99 V	95	63.60	40.20
6	*5500.00	94.4 AV			1.99 V	95	54.20	40.20
7	11000.00	62.4 PK	74.0	-11.6	1.56 V	279	42.50	19.90
8	11000.00	48.9 AV	54.0	-5.1	1.56 V	279	29.00	19.90

REMARKS:

1. Emission Level(dBuV/m) = Raw Value(dBuV) + Correction Factor(dB/m)
2. Correction Factor(dB/m) = Antenna Factor(dB/m) + Cable Factor(dB)
3. The other emission levels were very low against the limit.
4. Margin value = Emission Level – Limit value
5. " * ": Fundamental frequency.
6. " # ": The radiated frequency is out of the restricted band.



CHANNEL	TX Channel 116	DETECTOR FUNCTION	Peak (PK)
FREQUENCY RANGE	1GHz ~ 40GHz		Average (AV)

ANTENNA POLARITY & TEST DISTANCE: HORIZONTAL AT 3 M

NO.	FREQ. (MHz)	EMISSION LEVEL (dBuV/m)	LIMIT (dBuV/m)	MARGIN (dB)	ANTENNA HEIGHT (m)	TABLE ANGLE (Degree)	RAW VALUE (dBuV)	CORRECTION FACTOR (dB/m)
1	*5580.00	109.9 PK			1.22 H	69	69.60	40.30
2	*5580.00	100.6 AV			1.22 H	69	60.30	40.30
3	11160.00	61.7 PK	74.0	-12.3	1.49 H	269	42.30	19.40
4	11160.00	48.5 AV	54.0	-5.5	1.49 H	269	29.10	19.40

ANTENNA POLARITY & TEST DISTANCE: VERTICAL AT 3 M

NO.	FREQ. (MHz)	EMISSION LEVEL (dBuV/m)	LIMIT (dBuV/m)	MARGIN (dB)	ANTENNA HEIGHT (m)	TABLE ANGLE (Degree)	RAW VALUE (dBuV)	CORRECTION FACTOR (dB/m)
1	*5580.00	103.2 PK			1.97 V	97	62.90	40.30
2	*5580.00	94.0 AV			1.97 V	97	53.70	40.30
3	11160.00	61.8 PK	74.0	-12.2	1.66 V	177	42.40	19.40
4	11160.00	48.7 AV	54.0	-5.3	1.66 V	177	29.30	19.40

REMARKS:

1. Emission Level(dBuV/m) = Raw Value(dBuV) + Correction Factor(dB/m)
2. Correction Factor(dB/m) = Antenna Factor(dB/m) + Cable Factor(dB)
3. The other emission levels were very low against the limit.
4. Margin value = Emission Level – Limit value
5. " * ": Fundamental frequency.

CHANNEL	TX Channel 140	DETECTOR FUNCTION	Peak (PK)
FREQUENCY RANGE	1GHz ~ 40GHz		Average (AV)

ANTENNA POLARITY & TEST DISTANCE: HORIZONTAL AT 3 M

NO.	FREQ. (MHz)	EMISSION LEVEL (dBuV/m)	LIMIT (dBuV/m)	MARGIN (dB)	ANTENNA HEIGHT (m)	TABLE ANGLE (Degree)	RAW VALUE (dBuV)	CORRECTION FACTOR (dB/m)
1	*5700.00	109.4 PK			1.16 H	69	69.00	40.40
2	*5700.00	99.9 AV			1.16 H	69	59.50	40.40
3	#5725.00	67.8 PK	74.0	-6.2	1.25 H	69	60.40	7.40
4	#5725.00	49.2 AV	54.0	-4.8	1.25 H	69	41.80	7.40
5	11140.00	62.1 PK	74.0	-11.9	1.61 H	296	42.80	19.30
6	11140.00	48.8 AV	54.0	-5.2	1.61 H	296	29.50	19.30

ANTENNA POLARITY & TEST DISTANCE: VERTICAL AT 3 M

NO.	FREQ. (MHz)	EMISSION LEVEL (dBuV/m)	LIMIT (dBuV/m)	MARGIN (dB)	ANTENNA HEIGHT (m)	TABLE ANGLE (Degree)	RAW VALUE (dBuV)	CORRECTION FACTOR (dB/m)
1	*5700.00	100.9 PK			1.93 V	84	60.50	40.40
2	*5700.00	91.6 AV			1.93 V	84	51.20	40.40
3	#5725.00	64.4 PK	74.0	-9.6	2.52 V	87	57.00	7.40
4	#5725.00	48.2 AV	54.0	-5.8	2.52 V	87	40.80	7.40
5	11400.00	62.3 PK	74.0	-11.7	1.89 V	99	43.50	18.80
6	11400.00	49.1 AV	54.0	-4.9	1.89 V	99	30.30	18.80

REMARKS:

1. Emission Level(dBuV/m) = Raw Value(dBuV) + Correction Factor(dB/m)
2. Correction Factor(dB/m) = Antenna Factor(dB/m) + Cable Factor(dB)
3. The other emission levels were very low against the limit.
4. Margin value = Emission Level – Limit value
5. " * ": Fundamental frequency.
6. " # ": The radiated frequency is out of the restricted band.

CHANNEL	TX Channel 144	DETECTOR FUNCTION	Peak (PK)
FREQUENCY RANGE	1GHz ~ 40GHz		Average (AV)

ANTENNA POLARITY & TEST DISTANCE: HORIZONTAL AT 3 M

NO.	FREQ. (MHz)	EMISSION LEVEL (dBuV/m)	LIMIT (dBuV/m)	MARGIN (dB)	ANTENNA HEIGHT (m)	TABLE ANGLE (Degree)	RAW VALUE (dBuV)	CORRECTION FACTOR (dB/m)
1	*5720.00	110.6 PK			1.29 H	77	70.10	40.50
2	*5720.00	99.1 AV			1.29 H	77	58.60	40.50
3	11440.00	62.8 PK	74.0	-11.2	1.81 H	96	44.10	18.70
4	11440.00	49.9 AV	54.0	-4.1	1.81 H	96	31.20	18.70

ANTENNA POLARITY & TEST DISTANCE: VERTICAL AT 3 M

NO.	FREQ. (MHz)	EMISSION LEVEL (dBuV/m)	LIMIT (dBuV/m)	MARGIN (dB)	ANTENNA HEIGHT (m)	TABLE ANGLE (Degree)	RAW VALUE (dBuV)	CORRECTION FACTOR (dB/m)
1	*5720.00	99.5 PK			2.33 V	274	59.00	40.50
2	*5720.00	89.9 AV			2.33 V	274	49.40	40.50
3	11440.00	62.1 PK	74.0	-11.9	1.91 V	209	43.40	18.70
4	11440.00	50.0 AV	54.0	-4.0	1.91 V	209	31.30	18.70

REMARKS:

1. Emission Level(dBuV/m) = Raw Value(dBuV) + Correction Factor(dB/m)
2. Correction Factor(dB/m) = Antenna Factor(dB/m) + Cable Factor(dB)
3. The other emission levels were very low against the limit.
4. Margin value = Emission Level – Limit value
5. " * ": Fundamental frequency.



CHANNEL	TX Channel 149	DETECTOR FUNCTION	Peak (PK)
FREQUENCY RANGE	1GHz ~ 40GHz		Average (AV)

ANTENNA POLARITY & TEST DISTANCE: HORIZONTAL AT 3 M

NO.	FREQ. (MHz)	EMISSION LEVEL (dBuV/m)	LIMIT (dBuV/m)	MARGIN (dB)	ANTENNA HEIGHT (m)	TABLE ANGLE (Degree)	RAW VALUE (dBuV)	CORRECTION FACTOR (dB/m)
1	#5714.90	72.4 PK	74.0	-1.6	1.10 H	72	65.00	7.40
2	#5714.90	50.4 AV	54.0	-3.6	1.10 H	72	43.00	7.40
3	#5722.00	76.0 PK	78.2	-2.2	1.22 H	68	68.60	7.40
4	#5725.00	65.1 PK	78.2	-13.1	1.22 H	68	57.70	7.40
5	*5745.00	109.2 PK			1.10 H	72	68.70	40.50
6	*5745.00	99.2 AV			1.10 H	72	58.70	40.50
7	11490.00	60.6 PK	74.0	-13.4	1.56 H	266	41.90	18.70
8	11490.00	47.8 AV	54.0	-6.2	1.56 H	266	29.10	18.70

ANTENNA POLARITY & TEST DISTANCE: VERTICAL AT 3 M

NO.	FREQ. (MHz)	EMISSION LEVEL (dBuV/m)	LIMIT (dBuV/m)	MARGIN (dB)	ANTENNA HEIGHT (m)	TABLE ANGLE (Degree)	RAW VALUE (dBuV)	CORRECTION FACTOR (dB/m)
1	#5714.00	64.2 PK	74.0	-9.8	2.76 V	87	56.80	7.40
2	#5714.00	46.9 AV	54.0	-7.1	2.76 V	87	39.50	7.40
3	#5722.00	70.1 PK	78.2	-8.1	2.56 V	90	62.70	7.40
4	#5725.00	57.5 PK	78.2	-20.7	2.56 V	90	50.10	7.40
5	*5745.00	104.8 PK			2.76 V	87	64.30	40.50
6	*5745.00	95.3 AV			2.76 V	87	54.80	40.50
7	11490.00	61.4 PK	74.0	-12.6	2.10 V	310	42.70	18.70
8	11490.00	48.6 AV	54.0	-5.4	2.10 V	310	29.90	18.70

REMARKS:

1. Emission Level(dBuV/m) = Raw Value(dBuV) + Correction Factor(dB/m)
2. Correction Factor(dB/m) = Antenna Factor(dB/m) + Cable Factor(dB)
3. The other emission levels were very low against the limit.
4. Margin value = Emission Level – Limit value
5. " * ": Fundamental frequency.
6. " # ": The radiated frequency is out of the restricted band.



CHANNEL	TX Channel 157	DETECTOR FUNCTION	Peak (PK)
FREQUENCY RANGE	1GHz ~ 40GHz		Average (AV)

ANTENNA POLARITY & TEST DISTANCE: HORIZONTAL AT 3 M

NO.	FREQ. (MHz)	EMISSION LEVEL (dBuV/m)	LIMIT (dBuV/m)	MARGIN (dB)	ANTENNA HEIGHT (m)	TABLE ANGLE (Degree)	RAW VALUE (dBuV)	CORRECTION FACTOR (dB/m)
1	*5785.00	110.0 PK			1.07 H	67	69.40	40.60
2	*5785.00	100.5 AV			1.07 H	67	59.90	40.60
3	11570.00	61.2 PK	74.0	-12.8	1.50 H	120	42.50	18.70
4	11570.00	48.0 AV	54.0	-6.0	1.50 H	120	29.30	18.70

ANTENNA POLARITY & TEST DISTANCE: VERTICAL AT 3 M

NO.	FREQ. (MHz)	EMISSION LEVEL (dBuV/m)	LIMIT (dBuV/m)	MARGIN (dB)	ANTENNA HEIGHT (m)	TABLE ANGLE (Degree)	RAW VALUE (dBuV)	CORRECTION FACTOR (dB/m)
1	*5785.00	106.5 PK			2.71 V	96	65.90	40.60
2	*5785.00	97.0 AV			2.71 V	96	56.40	40.60
3	11570.00	61.7 PK	74.0	-12.3	2.20 V	199	43.00	18.70
4	11570.00	48.6 AV	54.0	-5.4	2.20 V	199	29.90	18.70

REMARKS:

1. Emission Level(dBuV/m) = Raw Value(dBuV) + Correction Factor(dB/m)
2. Correction Factor(dB/m) = Antenna Factor(dB/m) + Cable Factor(dB)
3. The other emission levels were very low against the limit.
4. Margin value = Emission Level – Limit value
5. " * ": Fundamental frequency.

CHANNEL	TX Channel 165	DETECTOR FUNCTION	Peak (PK)
FREQUENCY RANGE	1GHz ~ 40GHz		Average (AV)

ANTENNA POLARITY & TEST DISTANCE: HORIZONTAL AT 3 M

NO.	FREQ. (MHz)	EMISSION LEVEL (dBuV/m)	LIMIT (dBuV/m)	MARGIN (dB)	ANTENNA HEIGHT (m)	TABLE ANGLE (Degree)	RAW VALUE (dBuV)	CORRECTION FACTOR (dB/m)
1	*5825.00	110.3 PK			1.14 H	74	69.70	40.60
2	*5825.00	101.3 AV			1.14 H	74	60.70	40.60
3	#5850.00	58.1 PK	78.2	-20.1	1.20 H	56	50.50	7.60
4	#5852.00	70.2 PK	78.2	-8.0	1.20 H	56	62.50	7.70
5	#5861.00	65.5 PK	74.0	-8.5	1.27 H	67	57.80	7.70
6	#5861.00	49.9 AV	54.0	-4.1	1.27 H	67	42.20	7.70
7	11650.00	61.4 PK	74.0	-12.6	1.67 H	100	42.20	19.20
8	11650.00	48.2 AV	54.0	-5.8	1.67 H	100	29.00	19.20

ANTENNA POLARITY & TEST DISTANCE: VERTICAL AT 3 M

NO.	FREQ. (MHz)	EMISSION LEVEL (dBuV/m)	LIMIT (dBuV/m)	MARGIN (dB)	ANTENNA HEIGHT (m)	TABLE ANGLE (Degree)	RAW VALUE (dBuV)	CORRECTION FACTOR (dB/m)
1	*5825.00	105.5 PK			2.67 V	79	64.90	40.60
2	*5825.00	96.1 AV			2.67 V	79	55.50	40.60
3	#5850.00	64.5 PK	78.2	-13.7	2.71 V	90	56.90	7.60
4	#5852.00	55.5 PK	78.2	-22.7	2.71 V	90	47.80	7.70
5	#5861.00	60.0 PK	74.0	-14.0	2.57 V	86	52.30	7.70
6	#5861.00	47.2 AV	54.0	-6.8	2.57 V	86	39.50	7.70
7	11650.00	61.9 PK	74.0	-12.1	2.34 V	123	42.70	19.20
8	11650.00	48.8 AV	54.0	-5.2	2.34 V	123	29.60	19.20

REMARKS:

1. Emission Level(dBuV/m) = Raw Value(dBuV) + Correction Factor(dB/m)
2. Correction Factor(dB/m) = Antenna Factor(dB/m) + Cable Factor(dB)
3. The other emission levels were very low against the limit.
4. Margin value = Emission Level – Limit value
5. " * ": Fundamental frequency.
6. " # ": The radiated frequency is out of the restricted band.

802.11n (HT20)

CHANNEL	TX Channel 36	DETECTOR	Peak (PK)
FREQUENCY RANGE	1GHz ~ 40GHz	FUNCTION	Average (AV)

ANTENNA POLARITY & TEST DISTANCE: HORIZONTAL AT 3 M

NO.	FREQ. (MHz)	EMISSION LEVEL (dBuV/m)	LIMIT (dBuV/m)	MARGIN (dB)	ANTENNA HEIGHT (m)	TABLE ANGLE (Degree)	RAW VALUE (dBuV)	CORRECTION FACTOR (dB/m)
1	5150.00	60.1 PK	74.0	-13.9	1.22 H	58	54.10	6.00
2	5150.00	47.0 AV	54.0	-7.0	1.22 H	58	41.00	6.00
3	*5180.00	107.7 PK			1.22 H	58	68.30	39.40
4	*5180.00	97.6 AV			1.22 H	58	58.20	39.40
5	#10360.00	59.7 PK	74.0	-14.3	1.56 H	258	41.90	17.80
6	#10360.00	46.4 AV	54.0	-7.6	1.56 H	258	28.60	17.80

ANTENNA POLARITY & TEST DISTANCE: VERTICAL AT 3 M

NO.	FREQ. (MHz)	EMISSION LEVEL (dBuV/m)	LIMIT (dBuV/m)	MARGIN (dB)	ANTENNA HEIGHT (m)	TABLE ANGLE (Degree)	RAW VALUE (dBuV)	CORRECTION FACTOR (dB/m)
1	5150.00	58.3 PK	74.0	-15.7	3.51 V	141	52.30	6.00
2	5150.00	46.0 AV	54.0	-8.0	3.51 V	141	40.00	6.00
3	*5180.00	105.7 PK			3.51 V	82	66.30	39.40
4	*5180.00	95.7 AV			3.51 V	82	56.30	39.40
5	#10360.00	60.2 PK	74.0	-13.8	2.23 V	225	42.40	17.80
6	#10360.00	47.4 AV	54.0	-6.6	2.23 V	225	29.60	17.80

REMARKS:

1. Emission Level(dBuV/m) = Raw Value(dBuV) + Correction Factor(dB/m)
2. Correction Factor(dB/m) = Antenna Factor(dB/m) + Cable Factor(dB)
3. The other emission levels were very low against the limit.
4. Margin value = Emission Level – Limit value
5. " * ": Fundamental frequency.
6. " # ": The radiated frequency is out of the restricted band.

CHANNEL	TX Channel 40	DETECTOR FUNCTION	Peak (PK)
FREQUENCY RANGE	1GHz ~ 40GHz		Average (AV)

ANTENNA POLARITY & TEST DISTANCE: HORIZONTAL AT 3 M

NO.	FREQ. (MHz)	EMISSION LEVEL (dBuV/m)	LIMIT (dBuV/m)	MARGIN (dB)	ANTENNA HEIGHT (m)	TABLE ANGLE (Degree)	RAW VALUE (dBuV)	CORRECTION FACTOR (dB/m)
1	*5200.00	108.2 PK			1.31 H	60	68.70	39.50
2	*5200.00	98.0 AV			1.31 H	60	58.50	39.50
3	#10400.00	59.4 PK	74.0	-14.6	1.81 H	355	41.70	17.70
4	#10400.00	46.4 AV	54.0	-7.6	1.81 H	355	28.70	17.70

ANTENNA POLARITY & TEST DISTANCE: VERTICAL AT 3 M

NO.	FREQ. (MHz)	EMISSION LEVEL (dBuV/m)	LIMIT (dBuV/m)	MARGIN (dB)	ANTENNA HEIGHT (m)	TABLE ANGLE (Degree)	RAW VALUE (dBuV)	CORRECTION FACTOR (dB/m)
1	*5200.00	103.5 PK			2.73 V	162	64.00	39.50
2	*5200.00	93.3 AV			2.73 V	162	53.80	39.50
3	#10400.00	60.3 PK	74.0	-13.7	2.11 V	177	42.60	17.70
4	#10400.00	47.2 AV	54.0	-6.8	2.11 V	177	29.50	17.70

REMARKS:

1. Emission Level(dBuV/m) = Raw Value(dBuV) + Correction Factor(dB/m)
2. Correction Factor(dB/m) = Antenna Factor(dB/m) + Cable Factor(dB)
3. The other emission levels were very low against the limit.
4. Margin value = Emission Level – Limit value
5. " * ": Fundamental frequency.
6. " # ": The radiated frequency is out of the restricted band.



CHANNEL	TX Channel 48	DETECTOR FUNCTION	Peak (PK)
FREQUENCY RANGE	1GHz ~ 40GHz		Average (AV)

ANTENNA POLARITY & TEST DISTANCE: HORIZONTAL AT 3 M

NO.	FREQ. (MHz)	EMISSION LEVEL (dBuV/m)	LIMIT (dBuV/m)	MARGIN (dB)	ANTENNA HEIGHT (m)	TABLE ANGLE (Degree)	RAW VALUE (dBuV)	CORRECTION FACTOR (dB/m)
1	*5240.00	108.8 PK			1.20 H	63	69.20	39.60
2	*5240.00	98.9 AV			1.20 H	63	59.30	39.60
3	5350.00	59.5 PK	74.0	-14.5	1.21 H	66	53.00	6.50
4	5350.00	46.9 AV	54.0	-7.1	1.21 H	66	40.40	6.50
5	#10480.00	60.5 PK	74.0	-13.5	1.70 H	260	41.80	18.70
6	#10480.00	47.5 AV	54.0	-6.5	1.70 H	260	28.80	18.70

ANTENNA POLARITY & TEST DISTANCE: VERTICAL AT 3 M

NO.	FREQ. (MHz)	EMISSION LEVEL (dBuV/m)	LIMIT (dBuV/m)	MARGIN (dB)	ANTENNA HEIGHT (m)	TABLE ANGLE (Degree)	RAW VALUE (dBuV)	CORRECTION FACTOR (dB/m)
1	*5240.00	104.0 PK			2.64 V	77	64.40	39.60
2	*5240.00	94.2 AV			2.64 V	77	54.60	39.60
3	5350.00	57.3 PK	74.0	-16.7	2.20 V	80	50.80	6.50
4	5350.00	46.1 AV	54.0	-7.9	2.20 V	80	39.60	6.50
5	#10480.00	61.3 PK	74.0	-12.7	2.12 V	255	42.60	18.70
6	#10480.00	47.9 AV	54.0	-6.1	2.12 V	255	29.20	18.70

REMARKS:

1. Emission Level(dBuV/m) = Raw Value(dBuV) + Correction Factor(dB/m)
2. Correction Factor(dB/m) = Antenna Factor(dB/m) + Cable Factor(dB)
3. The other emission levels were very low against the limit.
4. Margin value = Emission Level – Limit value
5. " * ": Fundamental frequency.
6. " # ": The radiated frequency is out of the restricted band.



CHANNEL	TX Channel 52	DETECTOR FUNCTION	Peak (PK)
FREQUENCY RANGE	1GHz ~ 40GHz		Average (AV)

ANTENNA POLARITY & TEST DISTANCE: HORIZONTAL AT 3 M

NO.	FREQ. (MHz)	EMISSION LEVEL (dBuV/m)	LIMIT (dBuV/m)	MARGIN (dB)	ANTENNA HEIGHT (m)	TABLE ANGLE (Degree)	RAW VALUE (dBuV)	CORRECTION FACTOR (dB/m)
1	5150.00	56.3 PK	74.0	-17.7	1.40 H	59	50.30	6.00
2	5150.00	45.3 AV	54.0	-8.7	1.40 H	59	39.30	6.00
3	*5260.00	108.7 PK			1.33 H	60	69.10	39.60
4	*5260.00	98.1 AV			1.33 H	60	58.50	39.60
5	#10520.00	60.4 PK	74.0	-13.6	1.73 H	307	41.50	18.90
6	#10520.00	47.4 AV	54.0	-6.6	1.73 H	307	28.50	18.90

ANTENNA POLARITY & TEST DISTANCE: VERTICAL AT 3 M

NO.	FREQ. (MHz)	EMISSION LEVEL (dBuV/m)	LIMIT (dBuV/m)	MARGIN (dB)	ANTENNA HEIGHT (m)	TABLE ANGLE (Degree)	RAW VALUE (dBuV)	CORRECTION FACTOR (dB/m)
1	5150.00	56.6 PK	74.0	-17.4	1.89 V	110	50.60	6.00
2	5150.00	44.9 AV	54.0	-9.1	1.89 V	110	38.90	6.00
3	*5260.00	107.3 PK			3.23 V	86	67.70	39.60
4	*5260.00	96.9 AV			3.23 V	86	57.30	39.60
5	#10520.00	61.2 PK	74.0	-12.8	1.92 V	310	42.30	18.90
6	#10520.00	48.4 AV	54.0	-5.6	1.92 V	310	29.50	18.90

REMARKS:

1. Emission Level(dBuV/m) = Raw Value(dBuV) + Correction Factor(dB/m)
2. Correction Factor(dB/m) = Antenna Factor(dB/m) + Cable Factor(dB)
3. The other emission levels were very low against the limit.
4. Margin value = Emission Level – Limit value
5. " * ": Fundamental frequency.
6. " # ": The radiated frequency is out of the restricted band.



CHANNEL	TX Channel 60	DETECTOR FUNCTION	Peak (PK)
FREQUENCY RANGE	1GHz ~ 40GHz		Average (AV)

ANTENNA POLARITY & TEST DISTANCE: HORIZONTAL AT 3 M

NO.	FREQ. (MHz)	EMISSION LEVEL (dBuV/m)	LIMIT (dBuV/m)	MARGIN (dB)	ANTENNA HEIGHT (m)	TABLE ANGLE (Degree)	RAW VALUE (dBuV)	CORRECTION FACTOR (dB/m)
1	*5300.00	108.0 PK			1.36 H	64	68.30	39.70
2	*5300.00	98.5 AV			1.36 H	64	58.80	39.70
3	10600.00	60.6 PK	74.0	-13.4	1.66 H	165	41.70	18.90
4	10600.00	47.4 AV	54.0	-6.6	1.66 H	165	28.50	18.90

ANTENNA POLARITY & TEST DISTANCE: VERTICAL AT 3 M

NO.	FREQ. (MHz)	EMISSION LEVEL (dBuV/m)	LIMIT (dBuV/m)	MARGIN (dB)	ANTENNA HEIGHT (m)	TABLE ANGLE (Degree)	RAW VALUE (dBuV)	CORRECTION FACTOR (dB/m)
1	*5300.00	105.2 PK			3.19 V	85	65.50	39.70
2	*5300.00	95.8 AV			3.19 V	85	56.10	39.70
3	10600.00	61.8 PK	74.0	-12.2	2.40 V	290	42.90	18.90
4	10600.00	48.7 AV	54.0	-5.3	2.40 V	290	29.80	18.90

REMARKS:

1. Emission Level(dBuV/m) = Raw Value(dBuV) + Correction Factor(dB/m)
2. Correction Factor(dB/m) = Antenna Factor(dB/m) + Cable Factor(dB)
3. The other emission levels were very low against the limit.
4. Margin value = Emission Level – Limit value
5. " * ": Fundamental frequency.

CHANNEL	TX Channel 64	DETECTOR FUNCTION	Peak (PK)
FREQUENCY RANGE	1GHz ~ 40GHz		Average (AV)

ANTENNA POLARITY & TEST DISTANCE: HORIZONTAL AT 3 M

NO.	FREQ. (MHz)	EMISSION LEVEL (dBuV/m)	LIMIT (dBuV/m)	MARGIN (dB)	ANTENNA HEIGHT (m)	TABLE ANGLE (Degree)	RAW VALUE (dBuV)	CORRECTION FACTOR (dB/m)
1	*5320.00	110.2 PK			1.13 H	64	70.50	39.70
2	*5320.00	98.7 AV			1.13 H	64	59.00	39.70
3	5350.00	64.4 PK	74.0	-9.6	1.23 H	72	57.90	6.50
4	5350.00	48.6 AV	54.0	-5.4	1.23 H	72	42.10	6.50
5	10640.00	60.8 PK	74.0	-13.2	1.55 H	269	42.00	18.80
6	10640.00	47.5 AV	54.0	-6.5	1.55 H	269	28.70	18.80

ANTENNA POLARITY & TEST DISTANCE: VERTICAL AT 3 M

NO.	FREQ. (MHz)	EMISSION LEVEL (dBuV/m)	LIMIT (dBuV/m)	MARGIN (dB)	ANTENNA HEIGHT (m)	TABLE ANGLE (Degree)	RAW VALUE (dBuV)	CORRECTION FACTOR (dB/m)
1	*5320.00	106.1 PK			3.31 V	86	66.40	39.70
2	*5320.00	95.9 AV			3.31 V	86	56.20	39.70
3	5350.00	62.0 PK	74.0	-12.0	2.87 V	106	55.50	6.50
4	5350.00	47.6 AV	54.0	-6.4	2.87 V	106	41.10	6.50
5	10640.00	61.4 PK	74.0	-12.6	2.00 V	196	42.60	18.80
6	10640.00	48.4 AV	54.0	-5.6	2.00 V	196	29.60	18.80

REMARKS:

1. Emission Level(dBuV/m) = Raw Value(dBuV) + Correction Factor(dB/m)
2. Correction Factor(dB/m) = Antenna Factor(dB/m) + Cable Factor(dB)
3. The other emission levels were very low against the limit.
4. Margin value = Emission Level – Limit value
5. " * ": Fundamental frequency.

CHANNEL	TX Channel 100	DETECTOR FUNCTION	Peak (PK)
FREQUENCY RANGE	1GHz ~ 40GHz		Average (AV)

ANTENNA POLARITY & TEST DISTANCE: HORIZONTAL AT 3 M

NO.	FREQ. (MHz)	EMISSION LEVEL (dBuV/m)	LIMIT (dBuV/m)	MARGIN (dB)	ANTENNA HEIGHT (m)	TABLE ANGLE (Degree)	RAW VALUE (dBuV)	CORRECTION FACTOR (dB/m)
1	5460.00	63.7 PK	74.0	-10.3	1.24 H	80	56.80	6.90
2	5460.00	48.1 AV	54.0	-5.9	1.24 H	80	41.20	6.90
3	#5470.00	70.3 PK	74.0	-3.7	1.30 H	71	63.40	6.90
4	#5470.00	49.2 AV	54.0	-4.8	1.30 H	71	42.30	6.90
5	*5500.00	109.5 PK			1.24 H	67	69.30	40.20
6	*5500.00	99.7 AV			1.24 H	67	59.50	40.20
7	11100.00	61.1 PK	74.0	-12.9	1.36 H	307	41.90	19.20
8	11100.00	48.5 AV	54.0	-5.5	1.36 H	307	29.30	19.20

ANTENNA POLARITY & TEST DISTANCE: VERTICAL AT 3 M

NO.	FREQ. (MHz)	EMISSION LEVEL (dBuV/m)	LIMIT (dBuV/m)	MARGIN (dB)	ANTENNA HEIGHT (m)	TABLE ANGLE (Degree)	RAW VALUE (dBuV)	CORRECTION FACTOR (dB/m)
1	5460.00	60.4 PK	74.0	-13.6	2.58 V	102	53.50	6.90
2	5460.00	46.4 AV	54.0	-7.6	2.58 V	102	39.50	6.90
3	#5470.00	64.7 PK	74.0	-9.3	2.58 V	102	57.80	6.90
4	#5470.00	47.0 AV	54.0	-7.0	2.58 V	102	40.10	6.90
5	*5500.00	106.5 PK			2.57 V	77	66.30	40.20
6	*5500.00	96.2 AV			2.57 V	77	56.00	40.20
7	11000.00	62.6 PK	74.0	-11.4	2.33 V	192	42.70	19.90
8	11000.00	49.9 AV	54.0	-4.1	2.33 V	192	30.00	19.90

REMARKS:

1. Emission Level(dBuV/m) = Raw Value(dBuV) + Correction Factor(dB/m)
2. Correction Factor(dB/m) = Antenna Factor(dB/m) + Cable Factor(dB)
3. The other emission levels were very low against the limit.
4. Margin value = Emission Level – Limit value
5. " * ": Fundamental frequency.
6. " # ": The radiated frequency is out of the restricted band.

CHANNEL	TX Channel 116	DETECTOR FUNCTION	Peak (PK)
FREQUENCY RANGE	1GHz ~ 40GHz		Average (AV)

ANTENNA POLARITY & TEST DISTANCE: HORIZONTAL AT 3 M

NO.	FREQ. (MHz)	EMISSION LEVEL (dBuV/m)	LIMIT (dBuV/m)	MARGIN (dB)	ANTENNA HEIGHT (m)	TABLE ANGLE (Degree)	RAW VALUE (dBuV)	CORRECTION FACTOR (dB/m)
1	*5580.00	109.4 PK			1.24 H	70	69.10	40.30
2	*5580.00	99.3 AV			1.24 H	70	59.00	40.30
3	11160.00	61.5 PK	74.0	-12.5	1.74 H	270	42.10	19.40
4	11160.00	48.3 AV	54.0	-5.7	1.74 H	270	28.90	19.40

ANTENNA POLARITY & TEST DISTANCE: VERTICAL AT 3 M

NO.	FREQ. (MHz)	EMISSION LEVEL (dBuV/m)	LIMIT (dBuV/m)	MARGIN (dB)	ANTENNA HEIGHT (m)	TABLE ANGLE (Degree)	RAW VALUE (dBuV)	CORRECTION FACTOR (dB/m)
1	*5580.00	106.6 PK			3.18 V	87	66.30	40.30
2	*5580.00	96.2 AV			3.18 V	87	55.90	40.30
3	11160.00	62.0 PK	74.0	-12.0	2.20 V	36	42.60	19.40
4	11160.00	49.2 AV	54.0	-4.8	2.20 V	36	29.80	19.40

REMARKS:

1. Emission Level(dBuV/m) = Raw Value(dBuV) + Correction Factor(dB/m)
2. Correction Factor(dB/m) = Antenna Factor(dB/m) + Cable Factor(dB)
3. The other emission levels were very low against the limit.
4. Margin value = Emission Level – Limit value
5. " * ": Fundamental frequency.

CHANNEL	TX Channel 140	DETECTOR FUNCTION	Peak (PK)
FREQUENCY RANGE	1GHz ~ 40GHz		Average (AV)

ANTENNA POLARITY & TEST DISTANCE: HORIZONTAL AT 3 M

NO.	FREQ. (MHz)	EMISSION LEVEL (dBuV/m)	LIMIT (dBuV/m)	MARGIN (dB)	ANTENNA HEIGHT (m)	TABLE ANGLE (Degree)	RAW VALUE (dBuV)	CORRECTION FACTOR (dB/m)
1	*5700.00	109.1 PK			1.31 H	74	68.70	40.40
2	*5700.00	98.9 AV			1.31 H	74	58.50	40.40
3	#5725.00	69.0 PK	74.0	-5.0	1.40 H	84	61.60	7.40
4	#5725.00	52.3 AV	54.0	-1.7	1.40 H	84	44.90	7.40
5	11400.00	60.8 PK	74.0	-13.2	1.71 H	274	42.00	18.80
6	11400.00	48.0 AV	54.0	-6.0	1.71 H	274	29.20	18.80

ANTENNA POLARITY & TEST DISTANCE: VERTICAL AT 3 M

NO.	FREQ. (MHz)	EMISSION LEVEL (dBuV/m)	LIMIT (dBuV/m)	MARGIN (dB)	ANTENNA HEIGHT (m)	TABLE ANGLE (Degree)	RAW VALUE (dBuV)	CORRECTION FACTOR (dB/m)
1	*5700.00	106.0 PK			3.04 V	87	65.60	40.40
2	*5700.00	96.5 AV			3.04 V	87	56.10	40.40
3	#5725.00	68.5 PK	74.0	-5.5	3.00 V	90	61.10	7.40
4	#5725.00	50.8 AV	54.0	-3.2	3.00 V	90	43.40	7.40
5	11400.00	62.2 PK	74.0	-11.8	1.79 V	231	43.40	18.80
6	11400.00	49.1 AV	54.0	-4.9	1.79 V	231	30.30	18.80

REMARKS:

1. Emission Level(dBuV/m) = Raw Value(dBuV) + Correction Factor(dB/m)
2. Correction Factor(dB/m) = Antenna Factor(dB/m) + Cable Factor(dB)
3. The other emission levels were very low against the limit.
4. Margin value = Emission Level – Limit value
5. " * ": Fundamental frequency.
6. " # ": The radiated frequency is out of the restricted band.

CHANNEL	TX Channel 144	DETECTOR FUNCTION	Peak (PK)
FREQUENCY RANGE	1GHz ~ 40GHz		Average (AV)

ANTENNA POLARITY & TEST DISTANCE: HORIZONTAL AT 3 M

NO.	FREQ. (MHz)	EMISSION LEVEL (dBuV/m)	LIMIT (dBuV/m)	MARGIN (dB)	ANTENNA HEIGHT (m)	TABLE ANGLE (Degree)	RAW VALUE (dBuV)	CORRECTION FACTOR (dB/m)
1	*5720.00	108.8 PK			1.26 H	73	68.30	40.50
2	*5720.00	98.9 AV			1.26 H	73	58.40	40.50
3	11440.00	62.6 PK	74.0	-11.4	1.89 H	200	43.90	18.70
4	11440.00	49.7 AV	54.0	-4.3	1.89 H	200	31.00	18.70

ANTENNA POLARITY & TEST DISTANCE: VERTICAL AT 3 M

NO.	FREQ. (MHz)	EMISSION LEVEL (dBuV/m)	LIMIT (dBuV/m)	MARGIN (dB)	ANTENNA HEIGHT (m)	TABLE ANGLE (Degree)	RAW VALUE (dBuV)	CORRECTION FACTOR (dB/m)
1	*5720.00	100.1 PK			2.31 V	89	59.60	40.50
2	*5720.00	91.2 AV			2.31 V	89	50.70	40.50
3	11440.00	62.3 PK	74.0	-11.7	1.87 V	211	43.60	18.70
4	11440.00	49.5 AV	54.0	-4.5	1.87 V	211	30.80	18.70

REMARKS:

1. Emission Level(dBuV/m) = Raw Value(dBuV) + Correction Factor(dB/m)
2. Correction Factor(dB/m) = Antenna Factor(dB/m) + Cable Factor(dB)
3. The other emission levels were very low against the limit.
4. Margin value = Emission Level – Limit value
5. " * ": Fundamental frequency.



CHANNEL	TX Channel 149	DETECTOR FUNCTION	Peak (PK)
FREQUENCY RANGE	1GHz ~ 40GHz		Average (AV)

ANTENNA POLARITY & TEST DISTANCE: HORIZONTAL AT 3 M

NO.	FREQ. (MHz)	EMISSION LEVEL (dBuV/m)	LIMIT (dBuV/m)	MARGIN (dB)	ANTENNA HEIGHT (m)	TABLE ANGLE (Degree)	RAW VALUE (dBuV)	CORRECTION FACTOR (dB/m)
1	#5714.00	72.2 PK	74.0	-1.8	1.20 H	71	64.80	7.40
2	#5714.00	50.5 AV	54.0	-3.5	1.20 H	71	43.10	7.40
3	#5722.00	74.7 PK	78.2	-3.5	1.20 H	68	67.30	7.40
4	#5725.00	62.4 PK	78.2	-15.8	1.20 H	68	55.00	7.40
5	*5745.00	109.8 PK			1.18 H	76	69.30	40.50
6	*5745.00	99.7 AV			1.18 H	76	59.20	40.50
7	11490.00	60.6 PK	74.0	-13.4	1.45 H	266	41.90	18.70
8	11490.00	47.5 AV	54.0	-6.5	1.45 H	266	28.80	18.70

ANTENNA POLARITY & TEST DISTANCE: VERTICAL AT 3 M

NO.	FREQ. (MHz)	EMISSION LEVEL (dBuV/m)	LIMIT (dBuV/m)	MARGIN (dB)	ANTENNA HEIGHT (m)	TABLE ANGLE (Degree)	RAW VALUE (dBuV)	CORRECTION FACTOR (dB/m)
1	#5714.00	67.8 PK	74.0	-6.2	3.00 V	92	60.40	7.40
2	#5714.00	47.9 AV	54.0	-6.1	3.00 V	92	40.50	7.40
3	#5722.00	72.2 PK	78.2	-6.0	2.93 V	99	64.80	7.40
4	#5725.00	58.9 PK	78.2	-19.3	2.93 V	99	51.50	7.40
5	*5745.00	105.2 PK			3.03 V	88	64.70	40.50
6	*5745.00	95.6 AV			3.03 V	88	55.10	40.50
7	11490.00	60.6 PK	74.0	-13.4	2.40 V	111	41.90	18.70
8	11490.00	48.0 AV	54.0	-6.0	2.40 V	111	29.30	18.70

REMARKS:

1. Emission Level(dBuV/m) = Raw Value(dBuV) + Correction Factor(dB/m)
2. Correction Factor(dB/m) = Antenna Factor(dB/m) + Cable Factor(dB)
3. The other emission levels were very low against the limit.
4. Margin value = Emission Level – Limit value
5. " * ": Fundamental frequency.
6. " # ": The radiated frequency is out of the restricted band.

CHANNEL	TX Channel 157	DETECTOR FUNCTION	Peak (PK)
FREQUENCY RANGE	1GHz ~ 40GHz		Average (AV)

ANTENNA POLARITY & TEST DISTANCE: HORIZONTAL AT 3 M

NO.	FREQ. (MHz)	EMISSION LEVEL (dBuV/m)	LIMIT (dBuV/m)	MARGIN (dB)	ANTENNA HEIGHT (m)	TABLE ANGLE (Degree)	RAW VALUE (dBuV)	CORRECTION FACTOR (dB/m)
1	*5785.00	109.4 PK			1.16 H	74	68.80	40.60
2	*5785.00	99.7 AV			1.16 H	74	59.10	40.60
3	11570.00	60.5 PK	74.0	-13.5	1.46 H	174	41.80	18.70
4	11570.00	47.4 AV	54.0	-6.6	1.46 H	174	28.70	18.70

ANTENNA POLARITY & TEST DISTANCE: VERTICAL AT 3 M

NO.	FREQ. (MHz)	EMISSION LEVEL (dBuV/m)	LIMIT (dBuV/m)	MARGIN (dB)	ANTENNA HEIGHT (m)	TABLE ANGLE (Degree)	RAW VALUE (dBuV)	CORRECTION FACTOR (dB/m)
1	*5785.00	104.1 PK			2.94 V	96	63.50	40.60
2	*5785.00	93.8 AV			2.94 V	96	53.20	40.60
3	11570.00	60.9 PK	74.0	-13.1	2.40 V	103	42.20	18.70
4	11570.00	48.2 AV	54.0	-5.8	2.40 V	103	29.50	18.70

REMARKS:

1. Emission Level(dBuV/m) = Raw Value(dBuV) + Correction Factor(dB/m)
2. Correction Factor(dB/m) = Antenna Factor(dB/m) + Cable Factor(dB)
3. The other emission levels were very low against the limit.
4. Margin value = Emission Level – Limit value
5. " * ": Fundamental frequency.



CHANNEL	TX Channel 165	DETECTOR FUNCTION	Peak (PK)
FREQUENCY RANGE	1GHz ~ 40GHz		Average (AV)

ANTENNA POLARITY & TEST DISTANCE: HORIZONTAL AT 3 M

NO.	FREQ. (MHz)	EMISSION LEVEL (dBuV/m)	LIMIT (dBuV/m)	MARGIN (dB)	ANTENNA HEIGHT (m)	TABLE ANGLE (Degree)	RAW VALUE (dBuV)	CORRECTION FACTOR (dB/m)
1	*5825.00	109.9 PK			1.24 H	76	69.30	40.60
2	*5825.00	99.4 AV			1.24 H	76	58.80	40.60
3	#5850.00	70.3 PK	78.2	-7.9	1.26 H	80	62.70	7.60
4	#5852.00	70.8 PK	78.2	-7.4	1.26 H	80	63.10	7.70
5	#5861.00	62.9 PK	74.0	-11.1	1.24 H	76	55.20	7.70
6	#5861.00	48.2 AV	54.0	-5.8	1.24 H	76	40.50	7.70
7	11650.00	61.2 PK	74.0	-12.8	1.80 H	129	42.00	19.20
8	11650.00	48.1 AV	54.0	-5.9	1.80 H	129	28.90	19.20

ANTENNA POLARITY & TEST DISTANCE: VERTICAL AT 3 M

NO.	FREQ. (MHz)	EMISSION LEVEL (dBuV/m)	LIMIT (dBuV/m)	MARGIN (dB)	ANTENNA HEIGHT (m)	TABLE ANGLE (Degree)	RAW VALUE (dBuV)	CORRECTION FACTOR (dB/m)
1	*5825.00	105.2 PK			2.94 V	97	64.60	40.60
2	*5825.00	95.5 AV			2.94 V	97	54.90	40.60
3	#5850.00	61.0 PK	78.2	-17.2	2.91 V	88	53.40	7.60
4	#5852.00	62.7 PK	78.2	-15.5	2.91 V	88	55.00	7.70
5	#5861.00	61.3 PK	74.0	-12.7	2.66 V	84	53.60	7.70
6	#5861.00	48.3 AV	54.0	-5.7	2.66 V	84	40.60	7.70
7	11650.00	61.8 PK	74.0	-12.2	2.54 V	20	42.60	19.20
8	11650.00	48.6 AV	54.0	-5.4	2.54 V	20	29.40	19.20

REMARKS:

1. Emission Level(dBuV/m) = Raw Value(dBuV) + Correction Factor(dB/m)
2. Correction Factor(dB/m) = Antenna Factor(dB/m) + Cable Factor(dB)
3. The other emission levels were very low against the limit.
4. Margin value = Emission Level – Limit value
5. " * ": Fundamental frequency.
6. " # ": The radiated frequency is out of the restricted band.

802.11n (HT40)

CHANNEL	TX Channel 38	DETECTOR FUNCTION	Peak (PK)
FREQUENCY RANGE	1GHz ~ 40GHz		Average (AV)

ANTENNA POLARITY & TEST DISTANCE: HORIZONTAL AT 3 M								
NO.	FREQ. (MHz)	EMISSION LEVEL (dBuV/m)	LIMIT (dBuV/m)	MARGIN (dB)	ANTENNA HEIGHT (m)	TABLE ANGLE (Degree)	RAW VALUE (dBuV)	CORRECTION FACTOR (dB/m)
1	5150.00	68.4 PK	74.0	-5.6	1.20 H	58	62.40	6.00
2	5150.00	52.8 AV	54.0	-1.2	1.20 H	58	46.80	6.00
3	*5190.00	104.1 PK			1.24 H	67	64.70	39.40
4	*5190.00	94.3 AV			1.24 H	67	54.90	39.40
5	#10380.00	59.2 PK	74.0	-14.8	1.33 H	168	41.50	17.70
6	#10380.00	45.9 AV	54.0	-8.1	1.33 H	168	28.20	17.70

ANTENNA POLARITY & TEST DISTANCE: VERTICAL AT 3 M								
NO.	FREQ. (MHz)	EMISSION LEVEL (dBuV/m)	LIMIT (dBuV/m)	MARGIN (dB)	ANTENNA HEIGHT (m)	TABLE ANGLE (Degree)	RAW VALUE (dBuV)	CORRECTION FACTOR (dB/m)
1	5150.00	62.9 PK	74.0	-11.1	2.66 V	100	56.90	6.00
2	5150.00	49.4 AV	54.0	-4.6	2.66 V	100	43.40	6.00
3	*5190.00	100.7 PK			2.97 V	90	61.30	39.40
4	*5190.00	91.7 AV			2.97 V	90	52.30	39.40
5	#10380.00	59.6 PK	74.0	-14.4	2.32 V	125	41.90	17.70
6	#10380.00	46.5 AV	54.0	-7.5	2.32 V	125	28.80	17.70

REMARKS:

1. Emission Level(dBuV/m) = Raw Value(dBuV) + Correction Factor(dB/m)
2. Correction Factor(dB/m) = Antenna Factor(dB/m) + Cable Factor(dB)
3. The other emission levels were very low against the limit.
4. Margin value = Emission Level – Limit value
5. " * ": Fundamental frequency.
6. " # ": The radiated frequency is out of the restricted band.



CHANNEL	TX Channel 46	DETECTOR FUNCTION	Peak (PK)
FREQUENCY RANGE	1GHz ~ 40GHz		Average (AV)

ANTENNA POLARITY & TEST DISTANCE: HORIZONTAL AT 3 M

NO.	FREQ. (MHz)	EMISSION LEVEL (dBuV/m)	LIMIT (dBuV/m)	MARGIN (dB)	ANTENNA HEIGHT (m)	TABLE ANGLE (Degree)	RAW VALUE (dBuV)	CORRECTION FACTOR (dB/m)
1	*5230.00	105.0 PK			1.22 H	64	65.40	39.60
2	*5230.00	96.2 AV			1.22 H	64	56.60	39.60
3	5350.00	62.1 PK	74.0	-11.9	1.36 H	119	55.60	6.50
4	5350.00	47.7 AV	54.0	-6.3	1.36 H	119	41.20	6.50
5	#10460.00	60.1 PK	74.0	-13.9	1.72 H	293	41.60	18.50
6	#10460.00	46.5 AV	54.0	-7.5	1.72 H	293	28.00	18.50

ANTENNA POLARITY & TEST DISTANCE: VERTICAL AT 3 M

NO.	FREQ. (MHz)	EMISSION LEVEL (dBuV/m)	LIMIT (dBuV/m)	MARGIN (dB)	ANTENNA HEIGHT (m)	TABLE ANGLE (Degree)	RAW VALUE (dBuV)	CORRECTION FACTOR (dB/m)
1	*5230.00	102.9 PK			3.27 V	90	63.30	39.60
2	*5230.00	93.7 AV			3.27 V	90	54.10	39.60
3	5350.00	60.9 PK	74.0	-13.1	2.88 V	101	54.40	6.50
4	5350.00	47.0 AV	54.0	-7.0	2.88 V	101	40.50	6.50
5	#10460.00	60.4 PK	74.0	-13.6	2.54 V	359	41.90	18.50
6	#10460.00	47.5 AV	54.0	-6.5	2.54 V	359	29.00	18.50

REMARKS:

1. Emission Level(dBuV/m) = Raw Value(dBuV) + Correction Factor(dB/m)
2. Correction Factor(dB/m) = Antenna Factor(dB/m) + Cable Factor(dB)
3. The other emission levels were very low against the limit.
4. Margin value = Emission Level – Limit value
5. " * ": Fundamental frequency.
6. " # ": The radiated frequency is out of the restricted band.

CHANNEL	TX Channel 54	DETECTOR FUNCTION	Peak (PK)
FREQUENCY RANGE	1GHz ~ 40GHz		Average (AV)

ANTENNA POLARITY & TEST DISTANCE: HORIZONTAL AT 3 M

NO.	FREQ. (MHz)	EMISSION LEVEL (dBuV/m)	LIMIT (dBuV/m)	MARGIN (dB)	ANTENNA HEIGHT (m)	TABLE ANGLE (Degree)	RAW VALUE (dBuV)	CORRECTION FACTOR (dB/m)
1	5150.00	59.6 PK	74.0	-14.4	1.23 H	66	53.60	6.00
2	5150.00	45.3 AV	54.0	-8.7	1.23 H	66	39.30	6.00
3	*5270.00	106.1 PK			1.16 H	63	66.50	39.60
4	*5270.00	96.4 AV			1.16 H	63	56.80	39.60
5	#10540.00	60.1 PK	74.0	-13.9	1.51 H	121	41.10	19.00
6	#10540.00	46.8 AV	54.0	-7.2	1.51 H	121	27.80	19.00

ANTENNA POLARITY & TEST DISTANCE: VERTICAL AT 3 M

NO.	FREQ. (MHz)	EMISSION LEVEL (dBuV/m)	LIMIT (dBuV/m)	MARGIN (dB)	ANTENNA HEIGHT (m)	TABLE ANGLE (Degree)	RAW VALUE (dBuV)	CORRECTION FACTOR (dB/m)
1	5150.00	59.1 PK	74.0	-14.9	2.86 V	86	53.10	6.00
2	5150.00	46.5 AV	54.0	-7.5	2.86 V	86	40.50	6.00
3	*5270.00	102.9 PK			3.23 V	91	63.30	39.60
4	*5270.00	93.5 AV			3.23 V	91	53.90	39.60
5	#10540.00	60.5 PK	74.0	-13.5	2.02 V	126	41.50	19.00
6	#10540.00	47.7 AV	54.0	-6.3	2.02 V	126	28.70	19.00

REMARKS:

1. Emission Level(dBuV/m) = Raw Value(dBuV) + Correction Factor(dB/m)
2. Correction Factor(dB/m) = Antenna Factor(dB/m) + Cable Factor(dB)
3. The other emission levels were very low against the limit.
4. Margin value = Emission Level – Limit value
5. " * ": Fundamental frequency.
6. " # ": The radiated frequency is out of the restricted band.

CHANNEL	TX Channel 62	DETECTOR FUNCTION	Peak (PK)
FREQUENCY RANGE	1GHz ~ 40GHz		Average (AV)

ANTENNA POLARITY & TEST DISTANCE: HORIZONTAL AT 3 M

NO.	FREQ. (MHz)	EMISSION LEVEL (dBuV/m)	LIMIT (dBuV/m)	MARGIN (dB)	ANTENNA HEIGHT (m)	TABLE ANGLE (Degree)	RAW VALUE (dBuV)	CORRECTION FACTOR (dB/m)
1	*5310.00	105.6 PK			1.19 H	62	65.90	39.70
2	*5310.00	95.6 AV			1.19 H	62	55.90	39.70
3	5350.00	59.9 PK	74.0	-14.1	1.10 H	71	53.40	6.50
4	5350.00	52.1 AV	54.0	-1.9	1.10 H	71	45.60	6.50
5	10620.00	59.9 PK	74.0	-14.1	1.60 H	70	41.00	18.90
6	10620.00	46.8 AV	54.0	-7.2	1.60 H	70	27.90	18.90

ANTENNA POLARITY & TEST DISTANCE: VERTICAL AT 3 M

NO.	FREQ. (MHz)	EMISSION LEVEL (dBuV/m)	LIMIT (dBuV/m)	MARGIN (dB)	ANTENNA HEIGHT (m)	TABLE ANGLE (Degree)	RAW VALUE (dBuV)	CORRECTION FACTOR (dB/m)
1	*5310.00	101.6 PK			2.98 V	87	61.90	39.70
2	*5310.00	92.0 AV			2.98 V	87	52.30	39.70
3	5350.00	67.5 PK	74.0	-6.5	2.94 V	85	61.00	6.50
4	5350.00	49.6 AV	54.0	-4.4	2.94 V	85	43.10	6.50
5	10620.00	60.3 PK	74.0	-13.7	1.90 V	276	41.40	18.90
6	10620.00	47.3 AV	54.0	-6.7	1.90 V	276	28.40	18.90

REMARKS:

1. Emission Level(dBuV/m) = Raw Value(dBuV) + Correction Factor(dB/m)
2. Correction Factor(dB/m) = Antenna Factor(dB/m) + Cable Factor(dB)
3. The other emission levels were very low against the limit.
4. Margin value = Emission Level – Limit value
5. " * ": Fundamental frequency.

CHANNEL	TX Channel 102	DETECTOR FUNCTION	Peak (PK)
FREQUENCY RANGE	1GHz ~ 40GHz		Average (AV)

ANTENNA POLARITY & TEST DISTANCE: HORIZONTAL AT 3 M

NO.	FREQ. (MHz)	EMISSION LEVEL (dBuV/m)	LIMIT (dBuV/m)	MARGIN (dB)	ANTENNA HEIGHT (m)	TABLE ANGLE (Degree)	RAW VALUE (dBuV)	CORRECTION FACTOR (dB/m)
1	5460.00	65.3 PK	74.0	-8.7	1.18 H	66	58.40	6.90
2	5460.00	49.1 AV	54.0	-4.9	1.18 H	66	42.20	6.90
3	#5470.00	69.4 PK	74.0	-4.6	1.16 H	67	62.50	6.90
4	#5470.00	52.2 AV	54.0	-1.8	1.16 H	67	45.30	6.90
5	*5510.00	104.8 PK			1.22 H	68	64.60	40.20
6	*5510.00	95.3 AV			1.22 H	68	55.10	40.20
7	11020.00	60.6 PK	74.0	-13.4	1.72 H	156	40.80	19.80
8	11020.00	47.7 AV	54.0	-6.3	1.72 H	156	27.90	19.80

ANTENNA POLARITY & TEST DISTANCE: VERTICAL AT 3 M

NO.	FREQ. (MHz)	EMISSION LEVEL (dBuV/m)	LIMIT (dBuV/m)	MARGIN (dB)	ANTENNA HEIGHT (m)	TABLE ANGLE (Degree)	RAW VALUE (dBuV)	CORRECTION FACTOR (dB/m)
1	5460.00	61.4 PK	74.0	-12.6	2.78 V	97	54.50	6.90
2	5460.00	46.8 AV	54.0	-7.2	2.78 V	97	39.90	6.90
3	#5470.00	62.4 PK	74.0	-11.6	2.81 V	93	55.50	6.90
4	#5470.00	50.8 AV	54.0	-3.2	2.81 V	93	43.90	6.90
5	*5510.00	101.0 PK			3.07 V	91	60.80	40.20
6	*5510.00	91.3 AV			3.07 V	91	51.10	40.20
7	11020.00	60.5 PK	74.0	-13.5	2.01 V	101	40.70	19.80
8	11020.00	47.8 AV	54.0	-6.2	2.01 V	101	28.00	19.80

REMARKS:

1. Emission Level(dBuV/m) = Raw Value(dBuV) + Correction Factor(dB/m)
2. Correction Factor(dB/m) = Antenna Factor(dB/m) + Cable Factor(dB)
3. The other emission levels were very low against the limit.
4. Margin value = Emission Level – Limit value
5. " * ": Fundamental frequency.
6. " # ": The radiated frequency is out of the restricted band.

CHANNEL	TX Channel 110	DETECTOR FUNCTION	Peak (PK)
FREQUENCY RANGE	1GHz ~ 40GHz		Average (AV)

ANTENNA POLARITY & TEST DISTANCE: HORIZONTAL AT 3 M

NO.	FREQ. (MHz)	EMISSION LEVEL (dBuV/m)	LIMIT (dBuV/m)	MARGIN (dB)	ANTENNA HEIGHT (m)	TABLE ANGLE (Degree)	RAW VALUE (dBuV)	CORRECTION FACTOR (dB/m)
1	*5550.00	107.3 PK			1.22 H	71	67.10	40.20
2	*5550.00	97.8 AV			1.22 H	71	57.60	40.20
3	11100.00	60.3 PK	74.0	-13.7	1.52 H	180	41.10	19.20
4	11100.00	47.2 AV	54.0	-6.8	1.52 H	180	28.00	19.20

ANTENNA POLARITY & TEST DISTANCE: VERTICAL AT 3 M

NO.	FREQ. (MHz)	EMISSION LEVEL (dBuV/m)	LIMIT (dBuV/m)	MARGIN (dB)	ANTENNA HEIGHT (m)	TABLE ANGLE (Degree)	RAW VALUE (dBuV)	CORRECTION FACTOR (dB/m)
1	*5550.00	103.2 PK			2.78 V	97	63.00	40.20
2	*5550.00	92.8 AV			2.78 V	97	52.60	40.20
3	11100.00	60.7 PK	74.0	-13.3	2.38 V	322	41.50	19.20
4	11100.00	47.7 AV	54.0	-6.3	2.38 V	322	28.50	19.20

REMARKS:

1. Emission Level(dBuV/m) = Raw Value(dBuV) + Correction Factor(dB/m)
2. Correction Factor(dB/m) = Antenna Factor(dB/m) + Cable Factor(dB)
3. The other emission levels were very low against the limit.
4. Margin value = Emission Level – Limit value
5. " * ": Fundamental frequency.

CHANNEL	TX Channel 134	DETECTOR FUNCTION	Peak (PK)
FREQUENCY RANGE	1GHz ~ 40GHz		Average (AV)

ANTENNA POLARITY & TEST DISTANCE: HORIZONTAL AT 3 M

NO.	FREQ. (MHz)	EMISSION LEVEL (dBuV/m)	LIMIT (dBuV/m)	MARGIN (dB)	ANTENNA HEIGHT (m)	TABLE ANGLE (Degree)	RAW VALUE (dBuV)	CORRECTION FACTOR (dB/m)
1	*5670.00	106.8 PK			1.20 H	68	66.50	40.30
2	*5670.00	96.6 AV			1.20 H	68	56.30	40.30
3	#5725.00	67.3 PK	74.0	-6.7	1.20 H	68	59.90	7.40
4	#5725.00	50.6 AV	54.0	-3.4	1.20 H	68	43.20	7.40
5	11340.00	59.9 PK	74.0	-14.1	1.45 H	18	40.70	19.20
6	11340.00	46.8 AV	54.0	-7.2	1.45 H	18	27.60	19.20

ANTENNA POLARITY & TEST DISTANCE: VERTICAL AT 3 M

NO.	FREQ. (MHz)	EMISSION LEVEL (dBuV/m)	LIMIT (dBuV/m)	MARGIN (dB)	ANTENNA HEIGHT (m)	TABLE ANGLE (Degree)	RAW VALUE (dBuV)	CORRECTION FACTOR (dB/m)
1	*5670.00	102.0 PK			3.01 V	95	61.70	40.30
2	*5670.00	92.5 AV			3.01 V	95	52.20	40.30
3	#5725.00	59.2 PK	74.0	-14.8	2.96 V	108	51.80	7.40
4	#5725.00	47.7 AV	54.0	-6.3	2.96 V	108	40.30	7.40
5	11340.00	60.5 PK	74.0	-13.5	2.01 V	290	41.30	19.20
6	11340.00	47.5 AV	54.0	-6.5	2.01 V	290	28.30	19.20

REMARKS:

1. Emission Level(dBuV/m) = Raw Value(dBuV) + Correction Factor(dB/m)
2. Correction Factor(dB/m) = Antenna Factor(dB/m) + Cable Factor(dB)
3. The other emission levels were very low against the limit.
4. Margin value = Emission Level – Limit value
5. " * ": Fundamental frequency.
6. " # ": The radiated frequency is out of the restricted band.

CHANNEL	TX Channel 142	DETECTOR FUNCTION	Peak (PK)
FREQUENCY RANGE	1GHz ~ 40GHz		Average (AV)

ANTENNA POLARITY & TEST DISTANCE: HORIZONTAL AT 3 M

NO.	FREQ. (MHz)	EMISSION LEVEL (dBuV/m)	LIMIT (dBuV/m)	MARGIN (dB)	ANTENNA HEIGHT (m)	TABLE ANGLE (Degree)	RAW VALUE (dBuV)	CORRECTION FACTOR (dB/m)
1	*5710.00	105.7 PK			1.31 H	74	65.20	40.50
2	*5710.00	95.8 AV			1.31 H	74	55.30	40.50
3	11420.00	62.4 PK	74.0	-11.6	1.77 H	100	43.70	18.70
4	11420.00	49.2 AV	54.0	-4.8	1.77 H	100	30.50	18.70

ANTENNA POLARITY & TEST DISTANCE: VERTICAL AT 3 M

NO.	FREQ. (MHz)	EMISSION LEVEL (dBuV/m)	LIMIT (dBuV/m)	MARGIN (dB)	ANTENNA HEIGHT (m)	TABLE ANGLE (Degree)	RAW VALUE (dBuV)	CORRECTION FACTOR (dB/m)
1	*5710.00	98.8 PK			2.30 V	90	58.30	40.50
2	*5710.00	88.8 AV			2.30 V	90	48.30	40.50
3	11420.00	62.0 PK	74.0	-12.0	1.99 V	233	43.30	18.70
4	11420.00	48.9 AV	54.0	-5.1	1.99 V	233	30.20	18.70

REMARKS:

1. Emission Level(dBuV/m) = Raw Value(dBuV) + Correction Factor(dB/m)
2. Correction Factor(dB/m) = Antenna Factor(dB/m) + Cable Factor(dB)
3. The other emission levels were very low against the limit.
4. Margin value = Emission Level – Limit value
5. " * ": Fundamental frequency.

CHANNEL	TX Channel 151	DETECTOR FUNCTION	Peak (PK)
FREQUENCY RANGE	1GHz ~ 40GHz		Average (AV)

ANTENNA POLARITY & TEST DISTANCE: HORIZONTAL AT 3 M

NO.	FREQ. (MHz)	EMISSION LEVEL (dBuV/m)	LIMIT (dBuV/m)	MARGIN (dB)	ANTENNA HEIGHT (m)	TABLE ANGLE (Degree)	RAW VALUE (dBuV)	CORRECTION FACTOR (dB/m)
1	#5714.00	69.1 PK	74.0	-4.9	1.20 H	69	61.70	7.40
2	#5714.00	52.4 AV	54.0	-1.6	1.20 H	69	45.00	7.40
3	#5722.00	72.0 PK	78.2	-6.2	1.18 H	75	64.60	7.40
4	#5725.00	60.1 PK	78.2	-18.1	1.18 H	75	52.70	7.40
5	*5755.00	103.3 PK			1.18 H	70	62.70	40.60
6	*5755.00	94.5 AV			1.18 H	70	53.90	40.60
7	11510.00	60.2 PK	74.0	-13.8	1.49 H	103	41.50	18.70
8	11510.00	47.2 AV	54.0	-6.8	1.49 H	103	28.50	18.70

ANTENNA POLARITY & TEST DISTANCE: VERTICAL AT 3 M

NO.	FREQ. (MHz)	EMISSION LEVEL (dBuV/m)	LIMIT (dBuV/m)	MARGIN (dB)	ANTENNA HEIGHT (m)	TABLE ANGLE (Degree)	RAW VALUE (dBuV)	CORRECTION FACTOR (dB/m)
1	#5714.00	64.3 PK	74.0	-9.7	2.94 V	73	56.90	7.40
2	#5714.00	47.0 AV	54.0	-7.0	2.94 V	73	39.60	7.40
3	#5722.00	63.9 PK	78.2	-14.3	2.88 V	88	56.50	7.40
4	#5725.00	54.9 PK	78.2	-23.3	2.88 V	88	47.50	7.40
5	*5755.00	98.4 PK			2.85 V	82	57.80	40.60
6	*5755.00	89.3 AV			2.85 V	82	48.70	40.60
7	11510.00	61.4 PK	74.0	-12.6	2.65 V	90	42.70	18.70
8	11510.00	48.2 AV	54.0	-5.8	2.65 V	90	29.50	18.70

REMARKS:

1. Emission Level(dBuV/m) = Raw Value(dBuV) + Correction Factor(dB/m)
2. Correction Factor(dB/m) = Antenna Factor(dB/m) + Cable Factor(dB)
3. The other emission levels were very low against the limit.
4. Margin value = Emission Level – Limit value
5. " * ": Fundamental frequency.
6. " # ": The radiated frequency is out of the restricted band.

CHANNEL	TX Channel 159	DETECTOR FUNCTION	Peak (PK)
FREQUENCY RANGE	1GHz ~ 40GHz		Average (AV)

ANTENNA POLARITY & TEST DISTANCE: HORIZONTAL AT 3 M

NO.	FREQ. (MHz)	EMISSION LEVEL (dBuV/m)	LIMIT (dBuV/m)	MARGIN (dB)	ANTENNA HEIGHT (m)	TABLE ANGLE (Degree)	RAW VALUE (dBuV)	CORRECTION FACTOR (dB/m)
1	*5795.00	105.8 PK			1.23 H	74	65.20	40.60
2	*5795.00	96.6 AV			1.23 H	74	56.00	40.60
3	#5850.00	57.2 PK	78.2	-21.0	1.19 H	80	49.60	7.60
4	#5852.00	70.0 PK	78.2	-8.2	1.19 H	80	62.30	7.70
5	#5861.00	62.8 PK	74.0	-11.2	1.25 H	80	55.10	7.70
6	#5861.00	48.5 AV	54.0	-5.5	1.25 H	80	40.80	7.70
7	11590.00	60.7 PK	74.0	-13.3	1.60 H	200	41.90	18.80
8	11590.00	47.5 AV	54.0	-6.5	1.60 H	200	28.70	18.80

ANTENNA POLARITY & TEST DISTANCE: VERTICAL AT 3 M

NO.	FREQ. (MHz)	EMISSION LEVEL (dBuV/m)	LIMIT (dBuV/m)	MARGIN (dB)	ANTENNA HEIGHT (m)	TABLE ANGLE (Degree)	RAW VALUE (dBuV)	CORRECTION FACTOR (dB/m)
1	*5795.00	100.0 PK			2.94 V	73	59.40	40.60
2	*5795.00	90.3 AV			2.94 V	73	49.70	40.60
3	#5850.00	54.3 PK	78.2	-23.9	2.77 V	99	46.70	7.60
4	#5852.00	63.5 PK	78.2	-14.7	2.77 V	99	55.80	7.70
5	#5861.00	60.0 PK	74.0	-14.0	2.88 V	77	52.30	7.70
6	#5861.00	47.2 AV	54.0	-6.8	2.88 V	77	39.50	7.70
7	11590.00	61.1 PK	74.0	-12.9	2.60 V	333	42.30	18.80
8	11590.00	48.2 AV	54.0	-5.8	2.60 V	333	29.40	18.80

REMARKS:

1. Emission Level(dBuV/m) = Raw Value(dBuV) + Correction Factor(dB/m)
2. Correction Factor(dB/m) = Antenna Factor(dB/m) + Cable Factor(dB)
3. The other emission levels were very low against the limit.
4. Margin value = Emission Level – Limit value
5. " * ": Fundamental frequency.
6. " # ": The radiated frequency is out of the restricted band.

Below 1GHz worst-case data:

802.11a

CHANNEL	TX Channel 60	DETECTOR FUNCTION	Quasi-Peak (QP)
FREQUENCY RANGE	30MHz ~ 1GHz		

ANTENNA POLARITY & TEST DISTANCE: HORIZONTAL AT 3 M

NO.	FREQ. (MHz)	EMISSION LEVEL (dBuV/m)	LIMIT (dBuV/m)	MARGIN (dB)	ANTENNA HEIGHT (m)	TABLE ANGLE (Degree)	RAW VALUE (dBuV)	CORRECTION FACTOR (dB/m)
1	90.17	25.6 QP	43.5	-17.9	2.00 H	15	45.20	-19.60
2	166.00	26.5 QP	43.5	-17.0	1.50 H	228	40.60	-14.10
3	527.64	25.9 QP	46.0	-20.1	2.00 H	102	33.50	-7.60
4	665.68	27.0 QP	46.0	-19.0	2.00 H	172	31.60	-4.60
5	840.67	31.4 QP	46.0	-14.6	1.50 H	192	32.90	-1.50
6	994.27	31.5 QP	54.0	-22.5	1.50 H	29	30.50	1.00

ANTENNA POLARITY & TEST DISTANCE: VERTICAL AT 3 M

NO.	FREQ. (MHz)	EMISSION LEVEL (dBuV/m)	LIMIT (dBuV/m)	MARGIN (dB)	ANTENNA HEIGHT (m)	TABLE ANGLE (Degree)	RAW VALUE (dBuV)	CORRECTION FACTOR (dB/m)
1	51.29	27.7 QP	40.0	-12.3	1.00 V	9	42.10	-14.40
2	72.67	27.8 QP	40.0	-12.2	1.50 V	93	44.70	-16.90
3	255.44	29.1 QP	46.0	-16.9	1.00 V	303	43.20	-14.10
4	335.15	32.3 QP	46.0	-13.7	1.50 V	81	43.70	-11.40
5	722.07	32.1 QP	46.0	-13.9	1.50 V	17	35.60	-3.50
6	840.67	33.3 QP	46.0	-12.7	2.00 V	301	34.80	-1.50

REMARKS:

1. Emission Level(dBuV/m) = Raw Value(dBuV) + Correction Factor(dB/m)
2. Correction Factor(dB/m) = Antenna Factor(dB/m) + Cable Factor(dB)
3. The other emission levels were very low against the limit.
4. Margin value = Emission Level – Limit value

4.2 Conducted Emission Measurement

4.2.1 Limits of Conducted Emission Measurement

Frequency (MHz)	Conducted Limit (dBuV)	
	Quasi-peak	Average
0.15 - 0.5	66 - 56	56 - 46
0.50 - 5.0	56	46
5.0 - 30.0	60	50

Note: 1. The lower limit shall apply at the transition frequencies.

2. The limit decreases in line with the logarithm of the frequency in the range of 0.15 to 0.50MHz.

4.2.2 Test Instruments

Description & Manufacturer	Model No.	Serial No.	Cal. Date	Cal. Due
Test Receiver ROHDE & SCHWARZ	ESCS 30	100288	Apr. 27, 2015	Apr. 26, 2016
RF signal cable (with 10dB PAD) Woken	5D-FB	Cable-cond2-01	Dec. 26, 2015	Dec. 25, 2016
LISN ROHDE & SCHWARZ (EUT)	ESH2-Z5	100100	Jan. 11, 2016	Jan. 10, 2017
LISN ROHDE & SCHWARZ (Peripheral)	ESH3-Z5	100312	Jul. 21, 2015	Jul. 20, 2016
Software ADT	BV ADT_Cond_ V7.3.7.3	NA	NA	NA

Note: 1. The calibration interval of the above test instruments is 12 months and the calibrations are traceable to NML/ROC and NIST/USA.

2. The test was performed in HwaYa Shielded Room 2.

3. The VCCI Site Registration No. is C-2047.

4.2.3 Test Procedures

- The EUT was placed 0.4 meters from the conducting wall of the shielded room with EUT being connected to the power mains through a line impedance stabilization network (LISN). Other support units were connected to the power mains through another LISN. The two LISNs provide 50 ohm/ 50uH of coupling impedance for the measuring instrument.
- Both lines of the power mains connected to the EUT were checked for maximum conducted interference.
- The frequency range from 150kHz to 30MHz was searched. Emission levels under (Limit - 20dB) was not recorded.

NOTE: The resolution bandwidth and video bandwidth of test receiver is 9kHz for quasi-peak detection (QP) and average detection (AV) at frequency 0.15MHz-30MHz.

4.2.4 Deviation from Test Standard

No deviation.

4.2.5 Test Setup

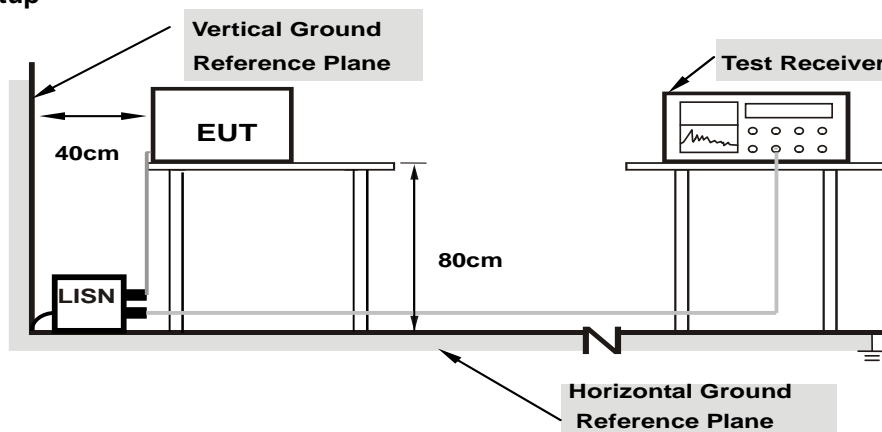

Note: 1.Support units were connected to second LISN.

For the actual test configuration, please refer to the attached file (Test Setup Photo).

4.2.6 EUT Operating Conditions

Same as 4.1.6.

4.2.7 Test Results

Phase	Line (L)	Detector Function	Quasi-Peak (QP) / Average (AV)
-------	----------	-------------------	--------------------------------

No	Freq. [MHz]	Corr. Factor (dB)	Reading Value [dB (uV)]		Emission Level [dB (uV)]		Limit [dB (uV)]		Margin (dB)	
			Q.P.	AV.	Q.P.	AV.	Q.P.	AV.	Q.P.	AV.
			1	0.16172	9.70	13.86	9.03	23.56	18.73	65.38
2	0.23203	9.70	14.25	11.59	23.95	21.29	62.38	52.38	-38.43	-31.09
3	0.42344	9.69	18.37	16.97	28.06	26.66	57.38	47.38	-29.32	-20.72
4	0.51328	9.69	18.80	14.50	28.49	24.19	56.00	46.00	-27.51	-21.81
5	20.25626	9.93	20.51	16.31	30.44	26.24	60.00	50.00	-29.56	-23.76
6	21.31250	9.95	13.14	11.46	23.09	21.41	60.00	50.00	-36.91	-28.59

REMARKS:

1. Q.P. and AV. are abbreviations of quasi-peak and average individually.
2. The emission levels of other frequencies were very low against the limit.
3. Margin value = Emission level - Limit value
4. Correction factor = Insertion loss + Cable loss
5. Emission Level = Correction Factor + Reading Value.

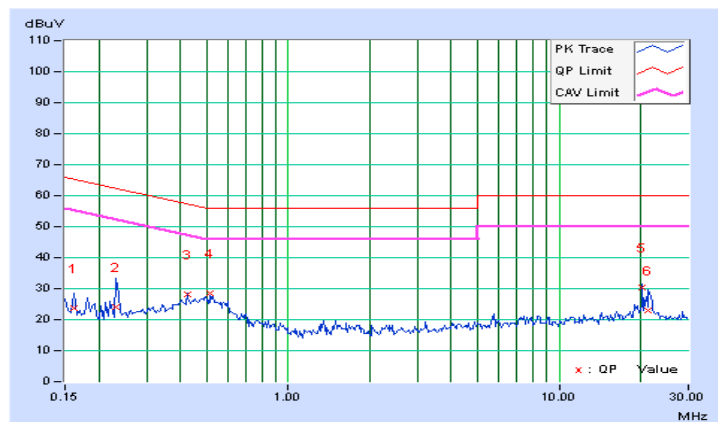

Phase	Neutral (N)	Detector Function	Quasi-Peak (QP) / Average (AV)
-------	-------------	-------------------	--------------------------------

No	Freq. [MHz]	Corr. Factor (dB)	Reading Value [dB (uV)]		Emission Level [dB (uV)]		Limit [dB (uV)]		Margin (dB)	
			Q.P.	AV.	Q.P.	AV.	Q.P.	AV.	Q.P.	AV.
	1	0.16953	9.78	12.42	0.53	22.20	10.31	64.98	54.98	-42.79
2	0.27891	9.77	12.57	9.26	22.34	19.03	60.85	50.85	-38.51	-31.82
3	0.44688	9.78	8.43	0.66	18.21	10.44	56.93	46.93	-38.72	-36.49
4	0.57244	9.77	4.82	3.47	14.59	13.24	56.00	46.00	-41.41	-32.76
5	19.69569	10.02	13.09	8.62	23.11	18.64	60.00	50.00	-36.89	-31.36
6	21.34657	10.03	13.57	5.36	23.60	15.39	60.00	50.00	-36.40	-34.61

REMARKS:

1. Q.P. and AV. are abbreviations of quasi-peak and average individually.
2. The emission levels of other frequencies were very low against the limit.
3. Margin value = Emission level - Limit value
4. Correction factor = Insertion loss + Cable loss
5. Emission Level = Correction Factor + Reading Value.

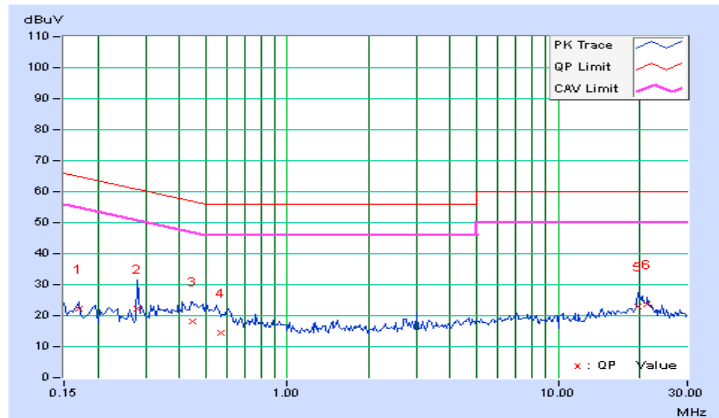

4.3 Transmit Power Measurement

4.3.1 Limits of Transmit Power Measurement

Operation Band	EUT Category		LIMIT
U-NII-1		Outdoor Access Point	1 Watt (30 dBm) (Max. e.i.r.p 125mW(21 dBm) at any elevation angle above 30 degrees as measured from the horizon)
		Fixed point-to-point Access Point	1 Watt (30 dBm)
		Indoor Access Point	1 Watt (30 dBm)
	√	Mobile and Portable client device	250mW (24 dBm)
U-NII-2A		√	250mW (24 dBm) or 11 dBm+10 log B*
U-NII-2C		√	250mW (24 dBm) or 11 dBm+10 log B*
U-NII-3		√	1 Watt (30 dBm)

*B is the 26 dB emission bandwidth in megahertz

Per KDB 662911 Method of conducted output power measurement on IEEE 802.11 devices,

- Array Gain = 0 dB (i.e., no array gain) for $N_{ANT} \leq 4$;
- Array Gain = 0 dB (i.e., no array gain) for channel widths ≥ 40 MHz for any N_{ANT} ;
- Array Gain = $5 \log(N_{ANT}/N_{SS})$ dB or 3 dB, whichever is less for 20-MHz channel widths with $N_{ANT} \geq 5$.

For power measurements on all other devices: Array Gain = $10 \log(N_{ANT}/N_{SS})$ dB.

4.3.2 Test Setup

For Power Output Measurement

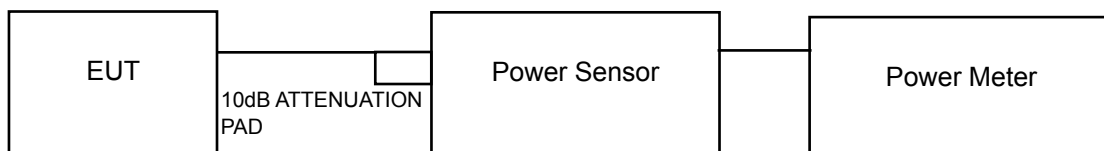

For 26dB and Occupied Bandwidth

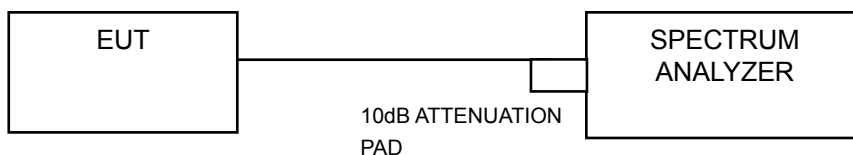

4.3.3 Test Instruments

Refer to section 4.1.2 to get information of above instrument.

4.3.4 Test Procedure

FOR AVERAGE POWER MEASUREMENT

Method PM is used to perform output power measurement, trigger and gating function of wide band power meter is enabled to measure max output power of TX on burst. Duty factor is not added to measured value.

FOR OCCUPIED BANDWIDTH

The transmitter output was connected to the spectrum analyzer through an attenuator. The bandwidth of the fundamental frequency was measured by spectrum analyzer with resolution bandwidth in the range of 1% to 5% of the anticipated emission bandwidth, and a video bandwidth at least 3x the resolution bandwidth and set the detector to average. The width of a frequency band such that, below the lower and above the upper frequency limits, the mean powers emitted are each equal to a specified percentage 0.5 %of the total mean power of a given emission.

4.3.5 Deviation fromTest Standard

No deviation.

4.3.6 EUT Operating Conditions

The software provided by client to enable the EUT under transmission condition continuously at lowest, middle and highest channel frequencies individually.

4.3.7 Test Result

POWER OUTPUT:

802.11a

Chan.	Freq. (MHz)	Maximum Conducted Power (mW)	Maximum Conducted Power (dBm)	Power Limit (dBm)	Pass / Fail
36	5180	19.634	12.93	24.00	Pass
40	5200	19.231	12.84	24.00	Pass
48	5240	19.724	12.95	24.00	Pass
52	5260	19.815	12.97	24.00	Pass
60	5300	20.137	13.04	24.00	Pass
64	5320	19.634	12.93	24.00	Pass
100	5500	19.588	12.92	24.00	Pass
116	5580	19.099	12.81	24.00	Pass
140	5700	19.454	12.89	24.00	Pass
144	5720 For U-NII-2C	7.703	8.87	23.00	Pass
144	5720 For U-NII-3	1.377	1.39	30.00	Pass
149	5745	15.885	12.01	30.00	Pass
157	5785	18.88	12.76	30.00	Pass
165	5825	18.923	12.77	30.00	Pass

NOTE:

For U-NII-2A, U-NII-2C Band:

- $11\text{dBm} + 10\log(21.61) = 24.35\text{ dBm} > 24\text{dBm}$.
- $11\text{dBm} + 10\log(21.77) = 24.38\text{ dBm} > 24\text{dBm}$.
- $11\text{dBm} + 10\log(21.68) = 24.36\text{ dBm} > 24\text{dBm}$.
- $11\text{dBm} + 10\log(21.79) = 24.38\text{ dBm} > 24\text{dBm}$.
- $11\text{dBm} + 10\log(21.77) = 24.38\text{ dBm} > 24\text{dBm}$.
- $11\text{dBm} + 10\log(21.82) = 24.39\text{ dBm} > 24\text{dBm}$.
- $11\text{dBm} + 10\log(5725.00 - 5709.12) = 23.00\text{ dBm} < 24\text{dBm}$.

802.11n (HT20)

Chan.	Freq. (MHz)	Maximum Conducted Power (mW)	Maximum Conducted Power (dBm)	Power Limit (dBm)	Pass / Fail
36	5180	15.704	11.96	24.00	Pass
40	5200	15.417	11.88	24.00	Pass
48	5240	15.311	11.85	24.00	Pass
52	5260	15.205	11.82	24.00	Pass
60	5300	15.631	11.94	24.00	Pass
64	5320	15.996	12.04	24.00	Pass
100	5500	15.776	11.98	24.00	Pass
116	5580	15.101	11.79	24.00	Pass
140	5700	16.069	12.06	24.00	Pass
144	5720 For U-NII-2C	4.995	6.99	22.99	Pass
144	5720 For U-NII-3	1.317	1.20	30.00	Pass
149	5745	15.56	11.92	30.00	Pass
157	5785	15.136	11.80	30.00	Pass
165	5825	14.859	11.72	30.00	Pass

NOTE:
For U-NII-2A, U-NII-2C Band:

1. $11\text{dBm} + 10\log(21.86) = 24.40\text{ dBm} > 24\text{dBm}$.
2. $11\text{dBm} + 10\log(21.78) = 24.38\text{ dBm} > 24\text{dBm}$.
3. $11\text{dBm} + 10\log(21.75) = 24.37\text{ dBm} > 24\text{dBm}$.
4. $11\text{dBm} + 10\log(21.75) = 24.37\text{ dBm} > 24\text{dBm}$.
5. $11\text{dBm} + 10\log(21.79) = 24.38\text{ dBm} > 24\text{dBm}$.
6. $11\text{dBm} + 10\log(21.89) = 24.40\text{ dBm} > 24\text{dBm}$.
7. $11\text{dBm} + 10\log(5725.00 - 5709.16) = 22.99\text{ dBm} < 24\text{dBm}$.

802.11n (HT40)

Chan.	Freq. (MHz)	Maximum Conducted Power (mW)	Maximum Conducted Power (dBm)	Power Limit (dBm)	Pass / Fail
38	5190	15.812	11.99	24.00	Pass
46	5230	15.885	12.01	24.00	Pass
54	5270	15.776	11.98	24.00	Pass
62	5310	15.668	11.95	24.00	Pass
102	5510	15.885	12.01	24.00	Pass
110	5550	15.631	11.94	24.00	Pass
134	5670	15.276	11.84	24.00	Pass
142	5710 For U-NII-2C	7.985	9.02	24.00	Pass
142	5710 For U-NII-3	0.7644	-1.17	30.00	Pass
151	5755	9.84	9.93	30.00	Pass
159	5795	15.596	11.93	30.00	Pass

NOTE:
For U-NII-2A, U-NII-2C Band:

1. $11\text{dBm} + 10\log(40.94) = 27.12\text{ dBm} > 24\text{dBm}$.
2. $11\text{dBm} + 10\log(41.41) = 27.17\text{ dBm} > 24\text{dBm}$.
3. $11\text{dBm} + 10\log(41.15) = 27.14\text{ dBm} > 24\text{dBm}$.
4. $11\text{dBm} + 10\log(41.14) = 27.14\text{ dBm} > 24\text{dBm}$.
5. $11\text{dBm} + 10\log(41.27) = 27.16\text{ dBm} > 24\text{dBm}$.
6. $11\text{dBm} + 10\log(5725.00 - 5689.14) = 56.55\text{ dBm} > 24\text{dBm}$.

26dB BANDWIDTH:**802.11a**

Chan.	Freq. (MHz)	26dBc Bandwidth (MHz)
36	5180	21.67
40	5200	21.70
48	5240	21.69
52	5260	21.61
60	5300	21.77
64	5320	21.68
100	5500	21.79
116	5580	21.77
140	5700	21.82
144	5720	15.88

802.11n (HT20)

Chan.	Freq. (MHz)	26dBc Bandwidth (MHz)
36	5180	21.76
40	5200	21.80
48	5240	21.72
52	5260	21.86
60	5300	21.78
64	5320	21.75
100	5500	21.75
116	5580	21.79
140	5700	21.89
144	5720	15.84

802.11n (HT40)

Chan.	Freq. (MHz)	26dBc Bandwidth (MHz)
38	5190	41.03
46	5230	41.03
54	5270	40.94
62	5310	41.41
102	5510	41.15
110	5550	41.14
134	5670	41.27
142	5710	35.86

Spectrum Plot of Worst Value

802.11a

802.11n (HT20)

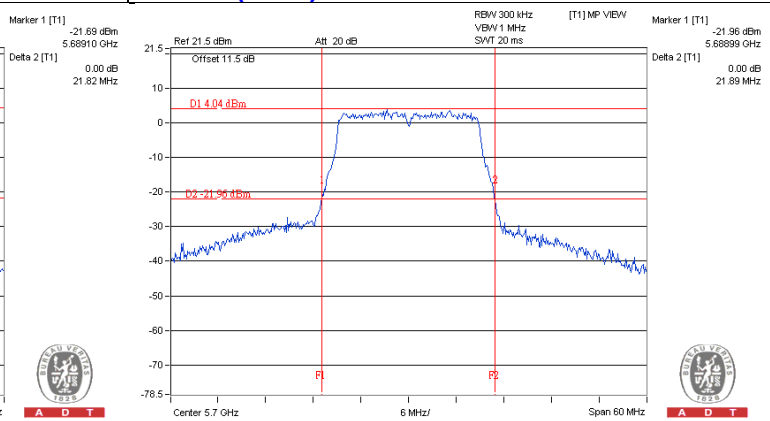
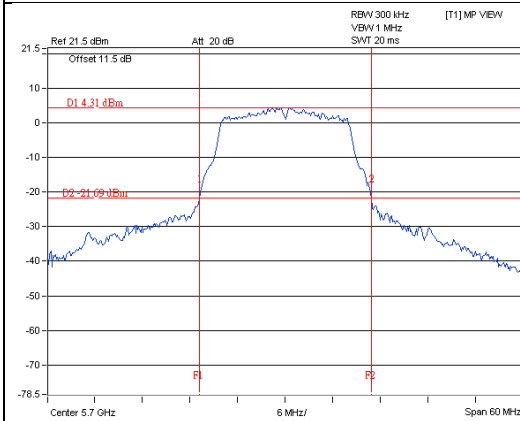

802.11n (HT40)

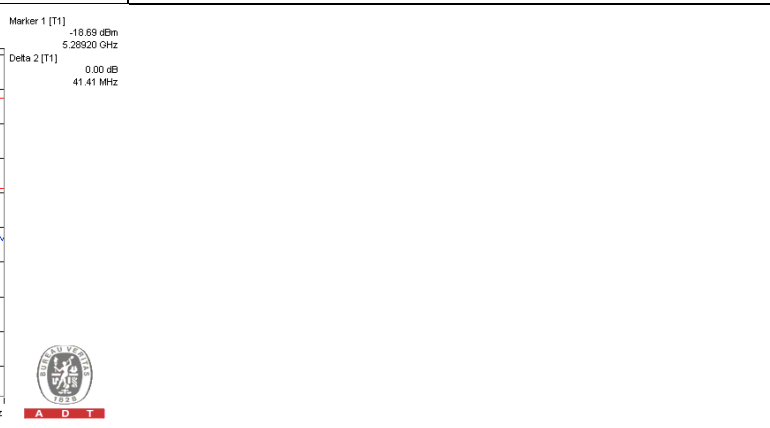
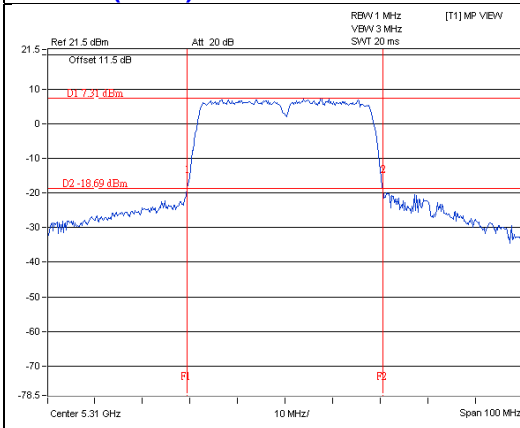

OCCUPIED BANDWIDTH:
802.11a

Chan.	Freq. (MHz)	Occupied Bandwidth (MHz)
36	5180	16.92
40	5200	16.92
48	5240	16.92
52	5260	17.04
60	5300	17.04
64	5320	17.04
100	5500	16.92
116	5580	17.16
140	5700	17.16
144	5720 For U-NII-2C	13.28
144	5720 For U-NII-3	3.16
149	5745	17.04
157	5785	17.16
165	5825	17.04

802.11n (HT20)

Chan.	Freq. (MHz)	Occupied Bandwidth (MHz)
36	5180	18.00
40	5200	18.00
48	5240	18.00
52	5260	18.12
60	5300	18.00
64	5320	18.00
100	5500	18.00
116	5580	18.12
140	5700	18.12
144	5720 For U-NII-2C	13.88
144	5720 For U-NII-3	3.76
149	5745	18.00
157	5785	18.12
165	5825	18.00

802.11n (HT40)

Chan.	Freq. (MHz)	Occupied Bandwidth (MHz)
38	5190	36.84
46	5230	36.72
54	5270	36.72
62	5310	36.72
102	5510	36.72
110	5550	36.84
134	5670	36.84
142	5710 For U-NII-2C	33.36
142	5710 For U-NII-3	3.24
151	5755	36.84
159	5795	36.84

Spectrum Plot of Worst Value

802.11a

802.11n (HT20)

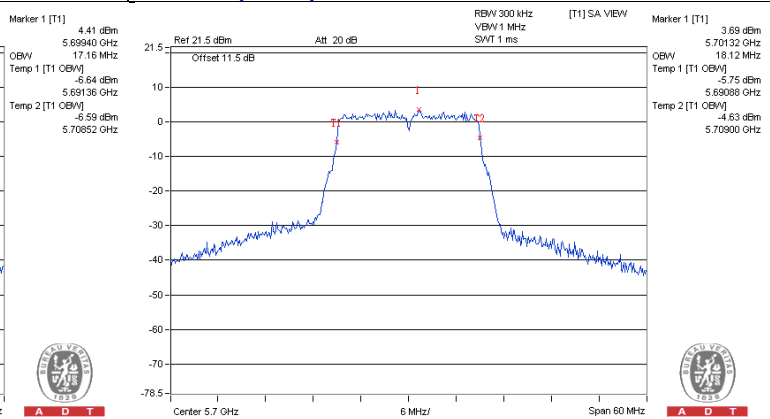
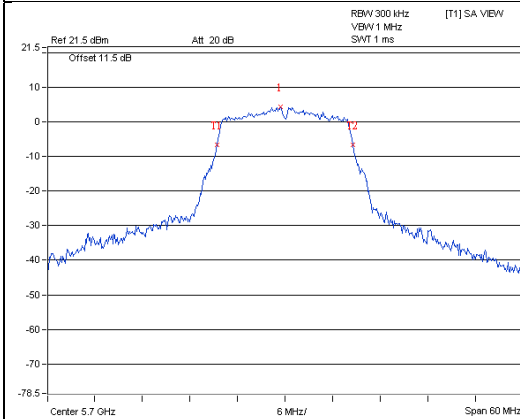

802.11n (HT40)

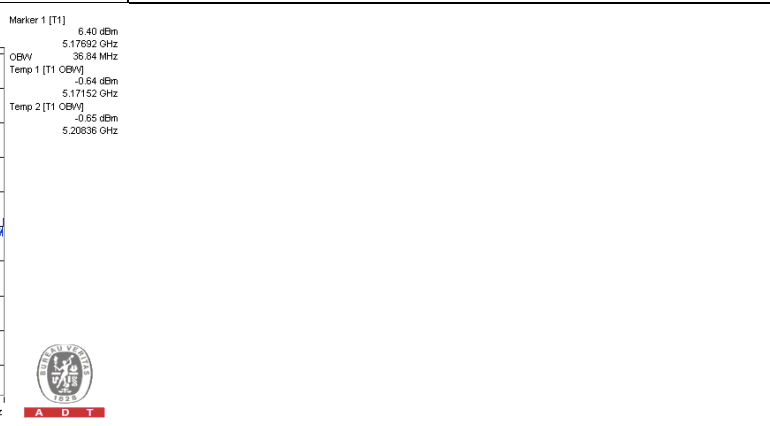
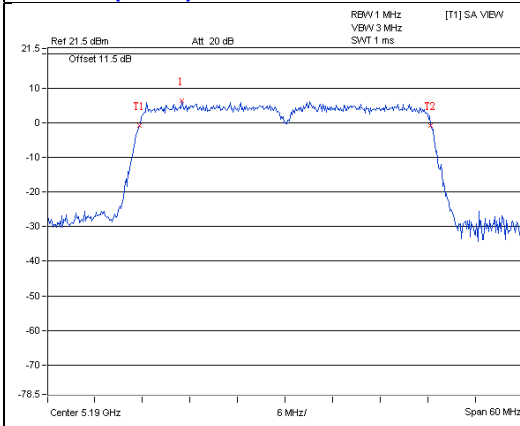

EUT MAXIMUM CONDUCTED POWER
802.11a

Frequency Band (MHz)	Max. Power	
	Output Power (mW)	Output Power (dBm)
5250~5350	20.137	13.04
5470~5725	19.588	12.92

NOTE: Manufacturer provides Transmit Power Control description to meet this requirement.

802.11n (HT20)

Frequency Band (MHz)	Max. Power	
	Output Power (mW)	Output Power (dBm)
5250~5350	15.996	12.04
5470~5725	16.069	12.06

NOTE: Manufacturer provides Transmit Power Control description to meet this requirement.

802.11n (HT40)

Frequency Band (MHz)	Max. Power	
	Output Power (mW)	Output Power (dBm)
5250~5350	15.776	11.98
5470~5725	15.885	12.01

NOTE: Manufacturer provides Transmit Power Control description to meet this requirement.

4.4 Peak Power Spectral Density Measurement

4.4.1 Limits of Peak Power Spectral Density Measurement

Operation Band	EUT Category		LIMIT
U-NII-1		Outdoor Access Point	17dBm/ MHz
		Fixed point-to-point Access Point	
		Indoor Access Point	
	√	Mobile and Portable client device	11dBm/ MHz
U-NII-2A	√		11dBm/ MHz
U-NII-2C	√		11dBm/ MHz
U-NII-3	√		30dBm/ 500kHz

4.4.2 Test Setup

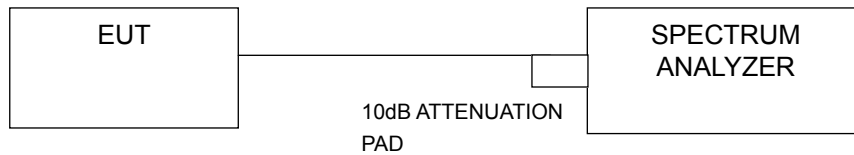

4.4.3 Test Instruments

Refer to section 4.1.2 to get information of above instrument.

4.4.4 Test Procedures

For U-NII-1, U-NII-2A, U-NII-2C band:

- 1) Set span to encompass the entire emission bandwidth (EBW) of the signal.
- 2) Set RBW = 1MHz, Set VBW \geq 3MHz, Detector = RMS
- 3) Set Channel power measure = 1MHz
- 4) Sweep time = auto, trigger set to "free run".
- 5) Trace average at least 100 traces in power averaging mode.
- 6) Record the max value and add $10 \log (1/\text{duty cycle})$

For U-NII-3 band:

- 1) Set span to encompass the entire emission bandwidth (EBW) of the signal.
- 2) Set RBW = 300 kHz, Set VBW \geq 1 MHz, Detector = RMS
- 3) Use the peak marker function to determine the maximum power level in any 300 kHz band segment within the fundamental EBW.
- 4) Scale the observed power level to an equivalent value in 500 kHz by adjusting (reducing) the measured power by a bandwidth correction factor (BWCF) where $\text{BWCF} = 10\log(500\text{kHz}/300\text{kHz})$
- 5) Sweep time = auto, trigger set to "free run".
- 6) Trace average at least 100 traces in power averaging mode.
- 7) Record the max value and add $10 \log (1/\text{duty cycle})$

4.4.5 Deviation from Test Standard

No deviation.

4.4.6 EUT Operating Conditions

Same as Item 4.3.6.

4.4.7 Test Results

For U-NII-1, U-NII-2A, U-NII-2C Band

802.11a

Chan.	Freq. (MHz)	PSD w/o duty factor	Duty factor	Total PSD with duty factor (dBm)	Max. Limit (dBm)	Pass / Fail
36	5180	0.66	0.13	0.80	11.00	Pass
40	5200	0.71	0.13	0.85	11.00	Pass
48	5240	0.68	0.13	0.82	11.00	Pass
52	5260	0.86	0.13	1.00	11.00	Pass
60	5300	0.99	0.13	1.13	11.00	Pass
64	5320	0.98	0.13	1.12	11.00	Pass
100	5500	1.01	0.13	1.15	11.00	Pass
116	5580	0.59	0.13	0.73	11.00	Pass
140	5700	0.67	0.13	0.81	11.00	Pass
144	5720 For U-NII-2C	-0.46	0.13	-0.32	11.00	Pass

Note:

1. Method 1 of power density measurement of KDB 662911 is using for calculating total power density. Total power density is summing entire spectra across corresponding frequency bins on the various outputs by computer.
2. Refer to section 3.3 for duty cycle spectrum plot.

802.11n (HT20)

Chan.	Freq. (MHz)	PSD w/o duty factor	Duty factor	Total PSD with duty factor (dBm)	Max. Limit (dBm)	Pass / Fail
36	5180	-1.89	0.53	-1.35	11.00	Pass
40	5200	-1.92	0.53	-1.38	11.00	Pass
48	5240	-1.98	0.53	-1.44	11.00	Pass
52	5260	-1.88	0.53	-1.34	11.00	Pass
60	5300	-2.03	0.53	-1.49	11.00	Pass
64	5320	-1.90	0.53	-1.36	11.00	Pass
100	5500	-1.81	0.53	-1.27	11.00	Pass
116	5580	-2.10	0.53	-1.56	11.00	Pass
140	5700	-2.25	0.53	-1.71	11.00	Pass
144	5720 For U-NII-2C	-3.54	0.53	-3.01	11.00	Pass

Note:

- Method 1 of power density measurement of KDB 662911 is using for calculating total power density. Total power density is summing entire spectra across corresponding frequency bins on the various outputs by computer.
- Refer to section 3.3 for duty cycle spectrum plot.

802.11n (HT40)

Chan.	Freq. (MHz)	PSD w/o duty factor	Duty factor	Total PSD with duty factor (dBm)	Max. Limit (dBm)	Pass / Fail
38	5190	-4.87	1.64	-3.23	11.00	Pass
46	5230	-4.92	1.64	-3.28	11.00	Pass
54	5270	-4.25	1.64	-2.61	11.00	Pass
62	5310	-4.12	1.64	-2.48	11.00	Pass
102	5510	-4.33	1.64	-2.69	11.00	Pass
110	5550	-4.38	1.64	-2.74	11.00	Pass
134	5670	-5.06	1.64	-3.42	11.00	Pass
142	5710 For U-NII-2C	-5.93	1.64	-4.29	11.00	Pass

Note:

- Method 1 of power density measurement of KDB 662911 is using for calculating total power density. Total power density is summing entire spectra across corresponding frequency bins on the various outputs by computer.
- Refer to section 3.3 for duty cycle spectrum plot.

Spectrum Plot of Worst Value

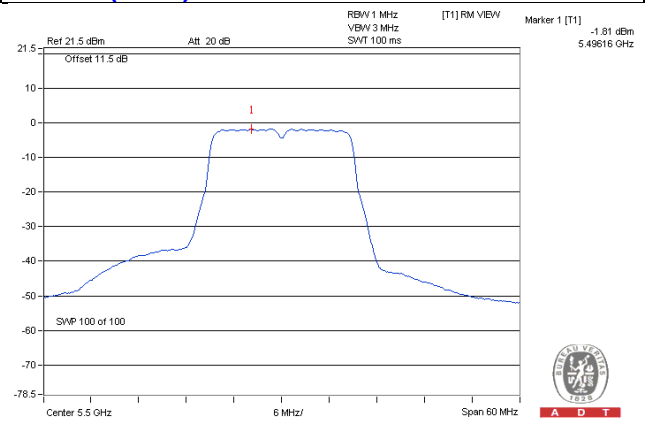
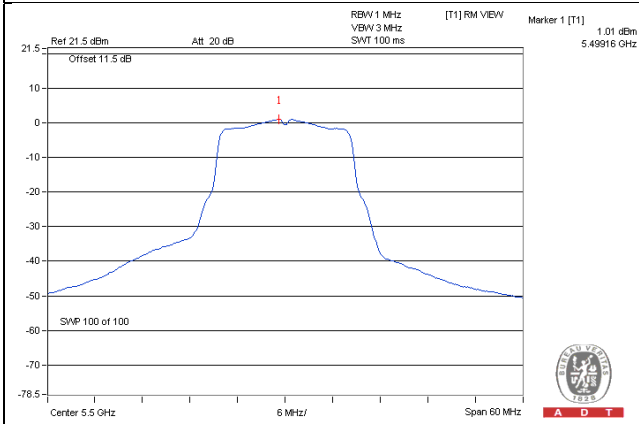
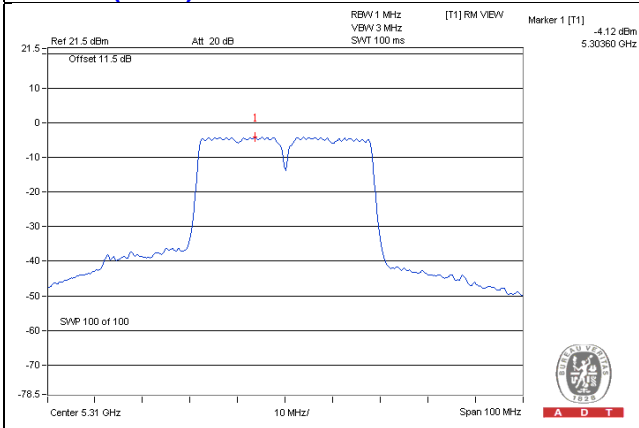
802.11a**802.11n (HT20)****802.11n (HT40)**

For U-NII-3 Band

802.11a

Chan.	Freq. (MHz)	PSD (dBm/300kHz)	PSD (dBm/500kHz)	Duty factor	Total PSD (dBm/500kHz)	Limit (dBm/500kHz)	Pass / Fail
144	5720 For U-NII-3	-10.25	-8.03	0.13	-7.90	30.00	Pass
149	5745	-8.32	-6.10	0.13	-5.97	30.00	Pass
157	5785	-7.36	-5.14	0.13	-5.01	30.00	Pass
165	5825	-7.33	-5.11	0.13	-4.98	30.00	Pass

Note:

- Method 1 of power density measurement of KDB 662911 is using for calculating total power density. Total power density is summing entire spectra across corresponding frequency bins on the various outputs by computer.
- Refer to section 3.3 for duty cycle spectrum plot.

802.11n (HT20)

Chan.	Freq. (MHz)	PSD (dBm/300kHz)	PSD (dBm/500kHz)	Duty factor	Total PSD (dBm/500kHz)	Limit (dBm/500kHz)	Pass / Fail
144	5720 For U-NII-3	-10.41	-8.19	0.53	-7.66	30.00	Pass
149	5745	-9.18	-6.96	0.53	-6.43	30.00	Pass
157	5785	-9.35	-7.13	0.53	-6.60	30.00	Pass
165	5825	-9.27	-7.05	0.53	-6.52	30.00	Pass

Note:

- Method 1 of power density measurement of KDB 662911 is using for calculating total power density. Total power density is summing entire spectra across corresponding frequency bins on the various outputs by computer.
- Refer to section 3.3 for duty cycle spectrum plot.

802.11n (HT40)

Chan.	Freq. (MHz)	PSD (dBm/300kHz)	PSD (dBm/500kHz)	Duty factor	Total PSD (dBm/500kHz)	Limit (dBm/500kHz)	Pass / Fail
142	5710 For U-NII-3	-12.67	-10.45	1.64	-8.81	30.00	Pass
151	5755	-14.43	-12.21	1.64	-10.57	30.00	Pass
159	5795	-13.05	-10.83	1.64	-9.19	30.00	Pass

Note:

- Method 1 of power density measurement of KDB 662911 is using for calculating total power density. Total power density is summing entire spectra across corresponding frequency bins on the various outputs by computer.
- Refer to section 3.3 for duty cycle spectrum plot.

Spectrum Plot of Worst Value

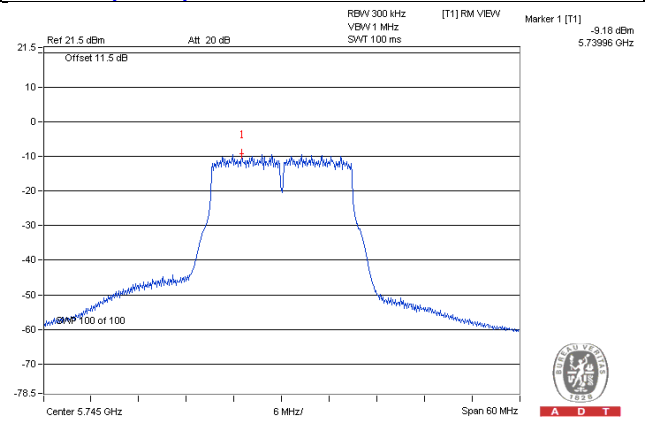
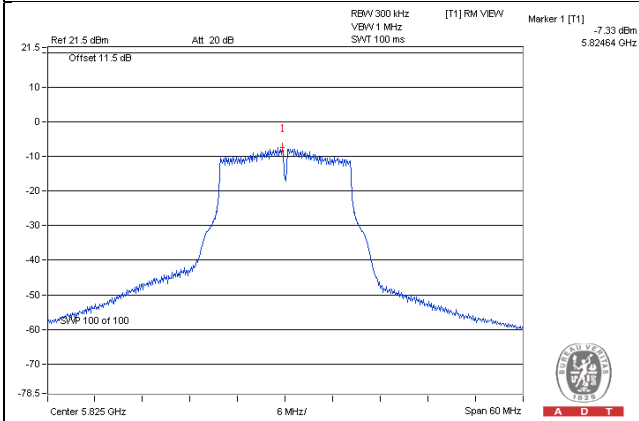
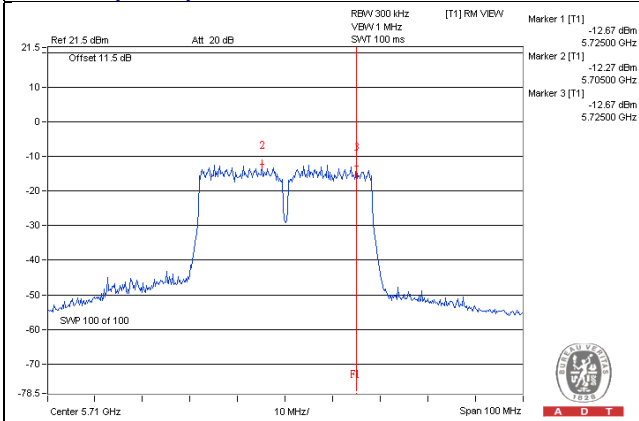
802.11a**802.11n (HT20)****802.11n (HT40)**

4.5 Frequency Stability

4.5.1 Limits of Frequency Stability Measurement

The frequency of the carrier signal shall be maintained within band of operation

4.5.2 Test Setup

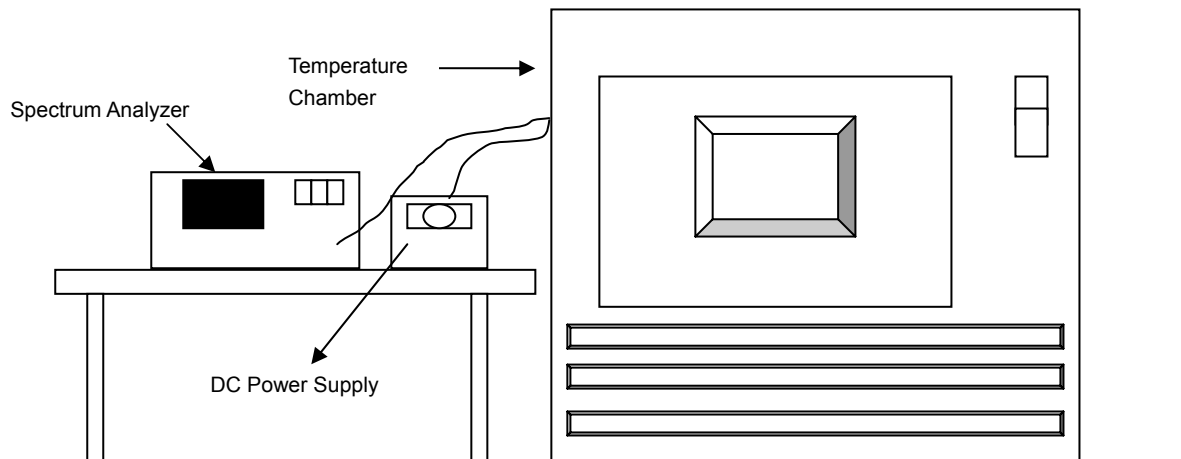

4.5.3 Test Instruments

Refer to section 4.1.2 to get information of above instrument.

4.5.4 Test Procedure

- a. The EUT was placed inside the environmental test chamber and powered by nominal DC voltage.
- b. Turn the EUT on and couple its output to a spectrum analyzer.
- c. Turn the EUT off and set the chamber to the highest temperature specified.
- d. Allow sufficient time (approximately 30 min) for the temperature of the chamber to stabilize, turn the EUT on and measure the operating frequency after 2, 5, and 10 minutes.
- e. Repeat step 2 and 3 with the temperature chamber set to the lowest temperature.
- f. The test chamber was allowed to stabilize at +20 degree C for a minimum of 30 minutes. The supply voltage was then adjusted on the EUT from 85% to 115% and the frequency record.

4.5.5 Deviation from Test Standard

No deviation.

4.5.6 EUT Operating Condition

Set the EUT transmit at un-modulation mode to test frequency stability.

4.5.7 Test Results

Frequency Stability Versus Temp.									
Operating Frequency: 5180MHz									
Temp. ()	Power Supply (Vac)	0 Minute		2 Minute		5 Minute		10 Minute	
		Measured Frequency (MHz)	Frequency Drift (%)	Measured Frequency (MHz)	Frequency Drift (%)	Measured Frequency (MHz)	Frequency Drift (%)	Measured Frequency (MHz)	Frequency Drift (%)
50	3.6	5180.0171	0.00033	5180.0159	0.00031	5180.0135	0.00026	5180.0163	0.00031
40	3.6	5179.9983	-0.00003	5179.9966	-0.00007	5179.9981	-0.00004	5179.999	-0.00002
30	3.6	5179.9785	-0.00042	5179.978	-0.00042	5179.9757	-0.00047	5179.9742	-0.00050
20	3.6	5179.9887	-0.00022	5179.9869	-0.00025	5179.9894	-0.00020	5179.9874	-0.00024
10	3.6	5180.0115	0.00022	5180.0107	0.00021	5180.0099	0.00019	5180.0098	0.00019
0	3.6	5180.0202	0.00039	5180.0198	0.00038	5180.0195	0.00038	5180.0196	0.00038
-10	3.6	5180.0118	0.00023	5180.0108	0.00021	5180.0121	0.00023	5180.0089	0.00017
-20	3.6	5179.9773	-0.00044	5179.9746	-0.00049	5179.9782	-0.00042	5179.978	-0.00042
-30	3.6	5179.9982	-0.00003	5180.0012	0.00002	5179.9992	-0.00002	5179.998	-0.00004

Frequency Stability Versus Voltage									
Operating Frequency: 5180MHz									
Temp. ()	Power Supply (Vac)	0 Minute		2 Minute		5 Minute		10 Minute	
		Measured Frequency (MHz)	Frequency Drift (%)	Measured Frequency (MHz)	Frequency Drift (%)	Measured Frequency (MHz)	Frequency Drift (%)	Measured Frequency (MHz)	Frequency Drift (%)
20	4.14	5179.9882	-0.00023	5179.9863	-0.00026	5179.9896	-0.00020	5179.9868	-0.00025
	3.6	5179.9887	-0.00022	5179.9869	-0.00025	5179.9894	-0.00020	5179.9874	-0.00024
	3.06	5179.988	-0.00023	5179.9871	-0.00025	5179.9887	-0.00022	5179.987	-0.00025

4.6 6dB Bandwidth Measurement

4.6.1 Limits of 6dB Bandwidth Measurement

The minimum of 6dB Bandwidth Measurement is 0.5MHz.

4.6.2 Test Setup

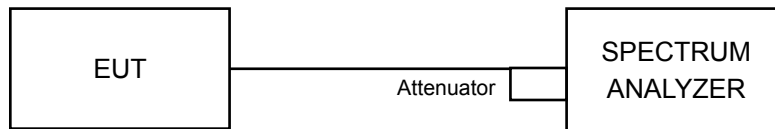

4.6.3 Test Instruments

Refer to section 4.1.2 to get information of above instrument.

4.6.4 Test Procedure

MEASUREMENT PROCEDURE REF

- Set resolution bandwidth (RBW) = 100kHz
- Set the video bandwidth (VBW) $\geq 3 \times$ RBW, Detector = Peak.
- Trace mode = max hold.
- Sweep = auto couple.
- Measure the maximum width of the emission that is constrained by the frequencies associated with the two amplitude points (upper and lower) that are attenuated by 6 dB relative to the maximum level measured in the fundamental emission

4.6.5 Deviation from Test Standard

No deviation.

4.6.6 EUT Operating Condition

The software provided by client to enable the EUT under transmission condition continuously at lowest, middle and highest channel frequencies individually.

4.6.7 Test Results

802.11a

Channel	Frequency (MHz)	6dB Bandwidth (MHz)	Minimum Limit (MHz)	Pass / Fail
144	5720 For U-NII-3	3.17	0.5	Pass
149	5745	16.37	0.5	Pass
157	5785	16.39	0.5	Pass
165	5825	16.39	0.5	Pass

802.11n (HT20)

Channel	Frequency (MHz)	6dB Bandwidth (MHz)	Minimum Limit (MHz)	Pass / Fail
144	5720 For U-NII-3	3.90	0.5	Pass
149	5745	17.82	0.5	Pass
157	5785	17.81	0.5	Pass
165	5825	17.81	0.5	Pass

802.11n (HT40)

Channel	Frequency (MHz)	6dB Bandwidth (MHz)	Minimum Limit (MHz)	Pass / Fail
142	5710 For U-NII-3	3.30	0.5	Pass
151	5755	36.63	0.5	Pass
159	5795	36.58	0.5	Pass

Spectrum Plot of Worst Value

802.11a

802.11n (HT20)

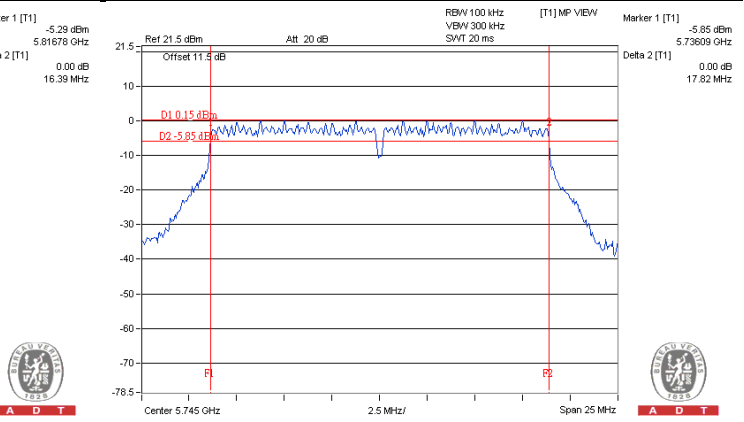
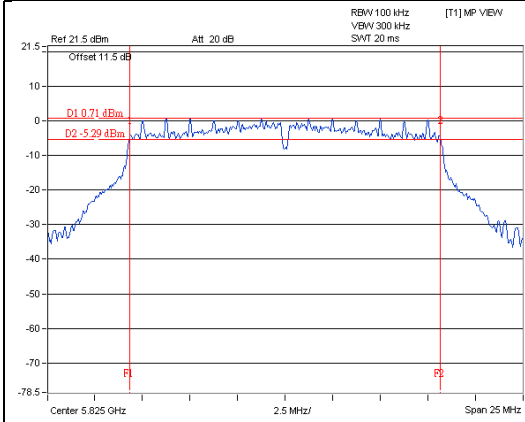

802.11n (HT40)

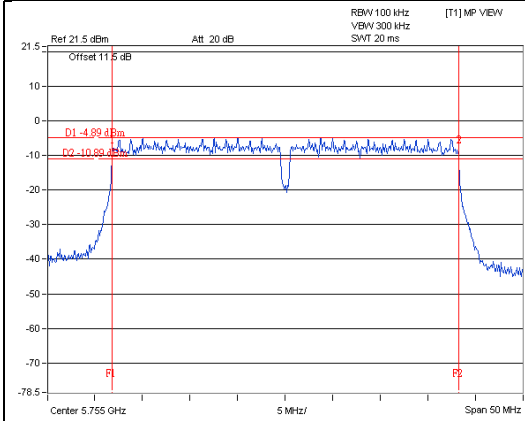

5 Pictures of Test Arrangements

Please refer to the attached file (Test Setup Photo).

Appendix – Information on the Testing Laboratories

We, Bureau Veritas Consumer Products Services (H.K.) Ltd., Taoyuan Branch, were founded in 1988 to provide our best service in EMC, Radio, Telecom and Safety consultation. Our laboratories are accredited and approved according to ISO/IEC 17025.

If you have any comments, please feel free to contact us at the following:

Linko EMC/RF Lab

Tel: 886-2-26052180

Fax: 886-2-26051924

Hsin Chu EMC/RF/Telecom Lab

Tel: 886-3-6668565

Fax: 886-3-6668323

Hwa Ya EMC/RF/Safety

Tel: 886-3-3183232

Fax: 886-3-3270892

Email: service.adt@tw.bureauveritas.com

Web Site: www.bureauveritas-adt.com

The address and road map of all our labs can be found in our web site also.

--- END ---