



# Bestway®

Para la instrucción en español,  
visite [bestwaycorp.com/support](http://bestwaycorp.com/support)

## SaluSpa™

Owner's Manual

Visit Bestway YouTube channel 

**FOR INSTRUCTION VIDEOS  
PLEASE VISIT**

[bestwaycorp.com/support](http://bestwaycorp.com/support)



303021213407

## CONTENTS

<b>1. Warning</b> .....P2	<b>4. Maintenance</b> ..... P8
<b>2. Installation</b> .....P5	Filter Cartridge Maintenance
Selected Location	Water Maintenance
GFCI Test	Air-Valve Adjustment
Assembly	Draining the Spa
<b>3. Pump Operation</b> .....P7	Cleaning the Spa
Control Panel	Deflation
Alarms	Spa Repair
	<b>5. Troubleshooting</b> ..... P10

# WARNING IMPORTANT SAFETY INSTRUCTIONS

When using this electrical equipment, basic safety precautions should always be followed, including the following:

## READ AND FOLLOW ALL INSTRUCTIONS.

**WARNING** – To reduce the risk of injury, do not permit children to use this product unless they are closely supervised at all times.

A wire connector is provided on this unit to connect a minimum 8 AWG (8.37 mm<sup>2</sup>) solid copper conductor between this unit and any metal equipment, metal enclosures of electrical equipment, metal water pipe, or conduit within 5 feet (1.5 m) of the unit.

**DANGER** – Risk of injury.

a) Replace damaged cord immediately.

b) Do not bury cord.

c) Connect to a grounded, grounding type receptacle only.

**WARNING** – This product is provided with a ground-fault circuit-interrupter integrated with the power plug at the end of the cord. The GFCI must be tested before each use. With the product operating, push the test button on the GFCI and the product should not operate. Push the reset button on the GFCI and the product should now operate normally. When the product fails to operate in this manner, there is a ground current flowing indicating the possibility of an electrical shock. Disconnect the power until the fault has been identified and corrected.

**DANGER** – Risk of Accidental Drowning. Extreme caution must be exercised to prevent unauthorized access by children. To avoid accidents, ensure that children cannot use this spa unless they are supervised at all times.

**DANGER** – Risk of Injury. The suction fittings in this spa are sized to match the specific water flow created by the pump. Should the need arise to replace the suction fittings or the pump, be sure that the flow rates are compatible. Never operate spa if the suction fittings are broken or missing. Never replace a suction fitting with one rated less than the flow rate marked on the original suction fitting.

**DANGER** – Risk of Electric Shock. Install at least 5 feet (1.5 m) from all metal surfaces. As an alternative, a spa may be installed within 5 feet of metal surfaces if each metal surface is permanently connected by a minimum 8 AWG (8.37 mm<sup>2</sup>) solid copper conductor to the wire connector on the terminal box that is provided for this purpose.

**DANGER** – Risk of Electric Shock. Do not permit any electric appliance, such as a light, telephone, radio, or television, within 5 feet (1.5 m) of a spa.

**WARNING** – To reduce the risk of injury:

a) The water in a spa should never exceed 104°F (40°C). Water temperatures

between 100°F (38°C) and 104°F (40°C) are considered safe for a healthy adult. Lower water temperatures are recommended for young children and when spa use exceeds 10 minutes.

- b) Since excessive water temperatures have a high potential for causing fetal damage during the early months of pregnancy, pregnant or possibly pregnant women should limit spa water temperatures to 100°F (38°C).
- c) Before entering a spa, the user should measure the water temperature with an accurate thermometer since the tolerance of water temperature-regulating devices varies.
- d) The use of alcohol, drugs, or medication before or during spa use may lead to unconsciousness with the possibility of drowning.
- e) Obese persons and persons with a history of heart disease, low or high blood pressure, circulatory system problems, or diabetes should consult a physician before using a spa.
- f) Persons using medication should consult a physician before using a spa since some medication may induce drowsiness while other medication may affect heart rate, blood pressure, and circulation.

**WARNING:** TO AVOID ELECTRIC SHOCK, DO NOT USE THE SPA WHEN IT IS RAINING.

**WARNING:** Water attracts children; Always attach a spa cover after each use.

**WARNING:** TO REDUCE THE RISK OF INJURY: Never add water that is higher than 104°F (40°C) into the Spa.

**CONSULT YOUR PHYSICIAN FOR RECOMMENDATIONS.**

**CAUTION:** The spa should not be setup or left out in temperatures lower than 40°F (4°C).

**CAUTION:** Do not use the spa alone.

**CAUTION:** Always enter and exit the spa slowly and cautiously. Wet surfaces are slippery.

**CAUTION:** To avoid damage to the pump, the spa must never be operated unless the spa is filled with water.

**CAUTION:** Immediately leave spa if the user feels uncomfortable or sleepy.

**NOTE:** Please examine equipment before use. Notify Bestway® at the customer service address listed on this manual for any damaged or missing parts at the time of purchase. Verify that the equipment components represent the model that you had intended to purchase.

This device complies with part 15 of the FCC Rules. Operation is subject to the following two conditions: (1) This device may not cause harmful interference, and (2) this device must accept any interference received, including interference that may cause undesired operation.

Any changes or modifications to this unit not expressly approved by the party responsible for compliance could void the user's authority to operate the equipment.

**NOTE:** This equipment has been tested and found to comply with the limits for a Class B digital device, pursuant to part 15 of the FCC Rules. These limits are designed to provide reasonable protection against harmful interference in a residential installation. This equipment generates, uses and can radiate radio frequency energy and, if not installed and used in accordance with the instructions, may cause harmful interference to radio communications. However, there is no guarantee that interference will not occur in a particular installation. If this equipment does cause harmful interference to radio or television reception, which can be determined by turning the equipment off and on, the user is encouraged to try to correct the

interference by one or more of the following measures:

- Reorient or relocate the receiving antenna.
- Increase the separation between the equipment and receiver.
- Connect the equipment into an outlet on a circuit different from that to which the receiver is connected.
- Consult the dealer or an experienced radio/TV technician for help.

## **SAVE THESE INSTRUCTIONS**

**ASSEMBLY: THE PROVIDED WARNING LABEL**



# **WARNING**

## **REDUCE THE RISK OF ELECTROCUTION**

- 1. NEVER PLACE AN ELECTRIC APPLIANCE WITHIN 5 FEET OF SPA.**

## **REDUCE THE RISK OF CHILD DROWNING**

- 1. SUPERVISE CHILDREN AT ALL TIMES.**
- 2. ATTACH SPA COVER AFTER EACH USE.**

## **REDUCE THE RISK OF OVERHEATING**

- 1. CHECK WITH A DOCTOR BEFORE USE IF PREGNANT, DIABETIC, IN POOR HEALTH, OR UNDER MEDICAL CARE.**
- 2. EXIT IMMEDIATELY IF UNCOMFORTABLE, DIZZY, OR SLEEPY. SPA HEAT CAN CAUSE HYPERTHERMIA AND UNCONSCIOUSNESS.**
- 3. SPA HEAT IN CONJUNCTION WITH ALCOHOL, DRUGS, OR MEDICATION CAN CAUSE UNCONSCIOUSNESS.**

**WHEN PREGNANT, SOAKING IN HOT WATER FOR LONG PERIODS CAN HARM YOUR FETUS. MEASURE WATER TEMPERATURE BEFORE ENTERING.**

- 1. DO NOT ENTER SPA IF WATER IS HOTTER THAN 100°F (38°C)**
- 2. DO NOT STAY IN SPA FOR LONGER THAN 10 MINUTES.**

**NOTE: The warning label must be posted near your spa in a readable position during using your spa.**

1. Take out the warning label from the accessory kit.
2. Carefully peel the warning label.
3. Affix the warning label.

To order the warning label, please contact your local Bestway After Sales Service.

## IMPORTANT !

To reach 104°F (40°C), the heating duration required is base on the starting water temperature and ambient temperature, the data below is purely for reference. To display the current water temperature, run the filter system for at least a minute.

Ambient Temperature	Water Temperature	Set Temperature	Heating Duration
50°F	50°F	104°F	32 h
59°F	59°F	104°F	26 h
68°F	68°F	104°F	20 h
77°F	77°F	104°F	14 h
86°F	86°F	104°F	9 h

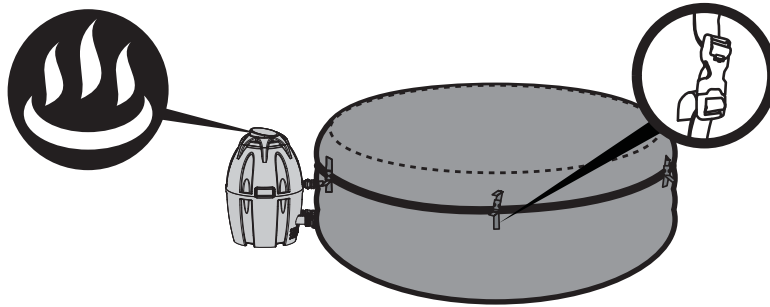

**Be sure to cover the spa with the spa cover whenever the heating function is activated. Leaving the spa uncovered will increase the heating duration required. Please do not use the spa when ambient temperature is lower than 39°F.**

Power Rate	Massage Tube Power	Heat Element Power	Water Pump Power
110-120V AC, 12A at 20°C	6.5A	11.3A at 20°C	0.7A

## INSTALLATION

### Selected Location

**IMPORTANT:** Because of the combined weight of the SaluSpa, water, and users, it is extremely important that the base where the SaluSpa is installed is smooth, flat, level and capable of uniformly supporting the weight for the entire time the SaluSpa is installed (not on the carpet or other similar material). If the SaluSpa is placed on a surface, which does not meet these requirements, any damage caused by improper support is not covered under the manufacturer's warranty. It is the responsibility of the SaluSpa owner to assure the integrity of the site at all times.

#### 1. Indoor Installation:

**Be aware of special requirements if you install the spa indoors.**

- Humidity is a natural side effect with SaluSpa installation. Determine the effects of moisture on exposed wood, paper, etc. in the proposed location. To minimize these effects, it is best to provide plenty of ventilation to the selected area. An architect can help determine if more ventilation is needed.

#### 2. Outdoor Installation:

- During filling, draining or when in use, water may spill out of the spa. Therefore the SaluSpa should be installed near a floor drain.
- Do not leave the spa's surface exposed to direct sunlight for long periods of time.

## SPECIFICATIONS 54299E

Capacity:	2-4 Adults	Massaging Turbo Blower:	6.5A	Increased Heat Rate:	Approximately 2-3°F/h (1-1.5°C/h)
Water Capacity (80%):	177 gal. (669 L)	Heat Element:	11.3A at 68°F (20°C)	Power Rate:	110-120V AC, 12A at 68°F (20°C)
Inflated Size:	71in. x 26in. (1.80m x 66cm)	Pump:	0.7A Circulation Filter Pump	Working Pressure:	0.055Bar (0.8PSI)
Filled Weight:	1,534 lbs. (696 kg)	Temperature Capacities:	104°F (40°C)	Actual Water Flow:	350 gal./h (1,325 L/h)

**NOTE:** The above heating rate is based on a lab test conducted with an ambient temperature of 77°F (25°C) and above.

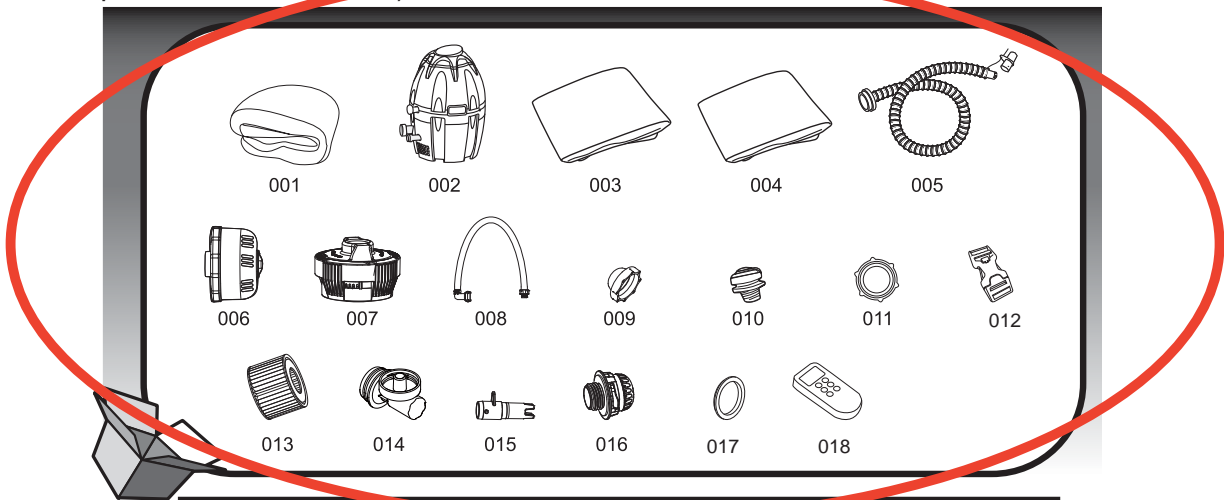

Part N.	Part Code	Description	QTY
001	P04936	Pool liner	1
002	P05036	Spa Heater	1
003	P04940	Top Reinforce Cover	1
004	54123GASS17	Inflatable Cover	1
005	P6931ASS16	Inflation Hose	1
006	P04674	Filter Set	2
007	P03821	Chemical Dispenser	1
008	P6934ASS16	Water Hose Set	1
009	P6575ASS16	Stoppers	3
010	F4C009B-02ASS17	Screw Valve	1
011	P00217	Cover Adapter A	1
012	F6414ASS16	Buckle	6
013	58323	Filter Cartridge (VI)	2
014	P61726ASS18	Deflation T-joint	1
015	P61727ASS18	Deflation Valve Adapter	1
016	P00260	Spa Debris Screen	1
017	P6609ASS16	Deflation Seal Ring	1
018	P05038	Remote Control	1

## GFCI Test

**IMPORTANT:** RISK OF ELECTRIC SHOCK. THE GFCI MUST BE TESTED BEFORE TURNING ON THE PUMP EACH TIME.

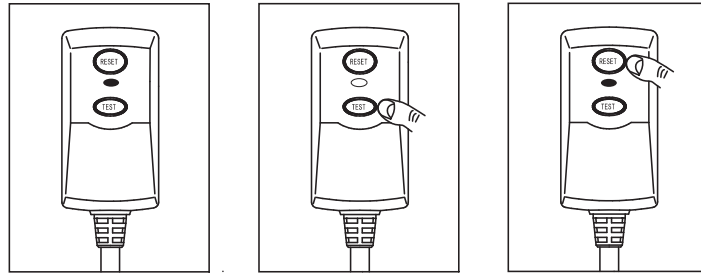

1. Plug the GFCI into a power outlet, the indicator turns red.
2. Press the test button, the indicator turns off.
3. Press the reset button again, the indicator turns red and the spa is ready for use.

**WARNING:** The GFCI plug must be tested before each use to avoid risk of electric shock.

**WARNING:** Before inserting plug into a power outlet, make sure the current rate of the power outlet is suitable for the pump.

**WARNING:** Do not use the pump if this test fails and contact our Aftersales Service.

**WARNING:** Using an extension lead or multi plug adaptor with the spa heater can cause the plug to overheat, causing damage to the equipment and surrounding items. The spa is a class 1 electrical appliance and must be connected directly to a grounded socket. It is recommended to only use a socket which is resistant to humidity and capable of high power loading. Regularly check the plug and socket for signs of damage before using the spa – do not use the spa if the plug or socket is damaged. If you are unsure about the quality of the electrical supply, please consult a qualified electrician before use.

**NOTE:** When inflating, you will notice that air will be expelled from the area where the air hose connects to the pump, this is normal for technique requirements.

**NOTE:** Do not use an air compressor to inflate the pool.

**NOTE:** Do not drag the pool on rough ground as this may cause damage to the pool liner.

**NOTE:** Inflation time for reference only.

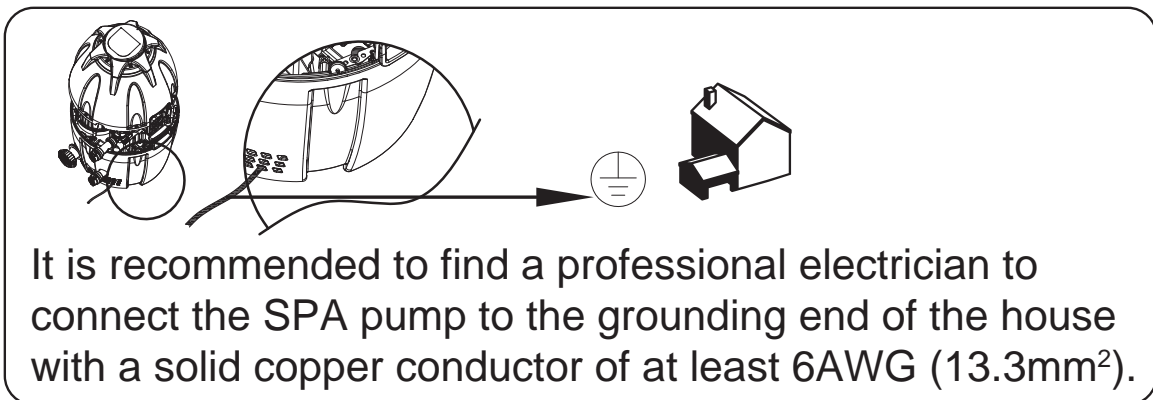

# Assembly

1.

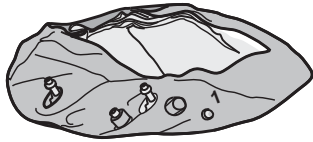

2.

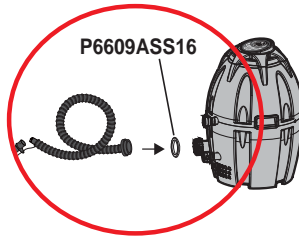

3.

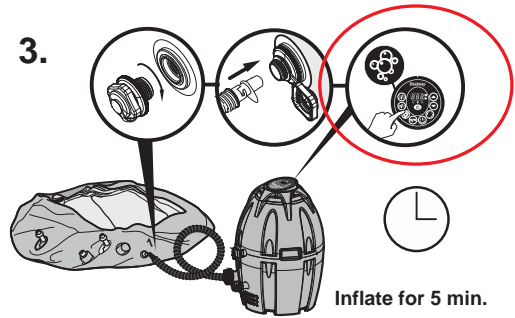

3 seconds to unlock.



4.

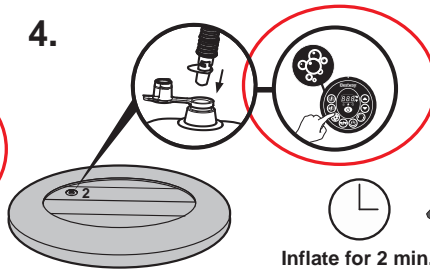

5.

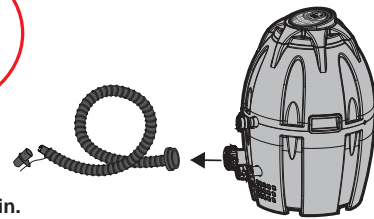

To stop inflation.

6.

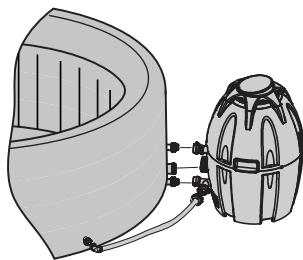

7.

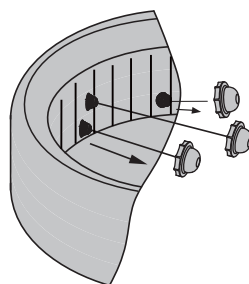

8.

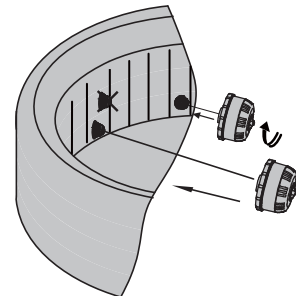

9.

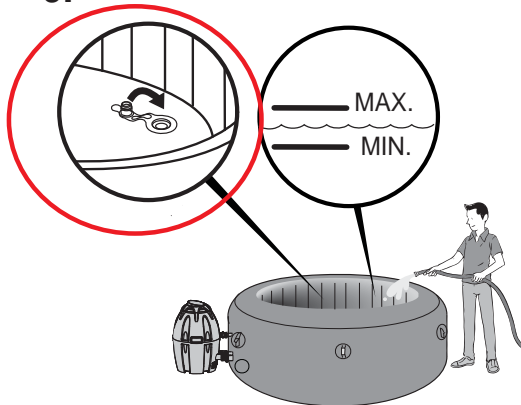

10.

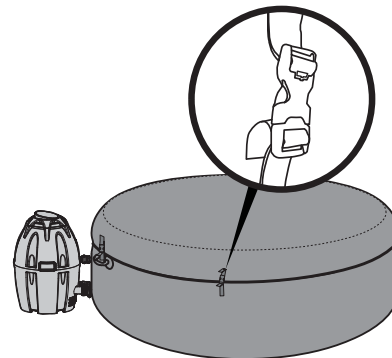



Hyperthermia occurs when the internal temperature of the body reaches a level several degrees above the normal body temperature of 37°C (98.6°F). The symptoms of hyperthermia include an increase in the internal temperature of the body, dizziness, lethargy, drowsiness, and fainting. The effects of hyperthermia include failure to perceive heat; failure to recognize the need to exit spa or hot tub; unawareness of impending hazard; fetal damage in pregnant women; physical inability to exit the spa or hot tub; and unconsciousness resulting in the danger of drowning.

**WARNING: THE USE OF ALCOHOL OR DRUGS CAN GREATLY INCREASE THE RISK OF FATAL HYPERTHERMIA IN HOT TUBS AND SPAS.**



#### Lock/Unlock Button







The pump has a 5-minute auto-lock. The LED light will dim out when the pump is locked (no function is activated). To lock or unlock the pump, place a finger over the lock/unlock button for 3 seconds.

#### Power-Saving Timer Button



This is a newly added function, designed to help avoid wasting power by setting the time and duration of the heating cycle for the spa. This way, you can enjoy your spa at the time you desire, without needing to leave the heater on at all times.

##### STEP 1: Set the heating duration

1. Press the  button until the  LED starts to flash.
2. Press the  or  button to adjust the heating duration (From 1-48 hours).
3. Press the  button again to confirm the heating duration.

##### STEP 2: Set the number of hours FROM NOW when the heater will activate

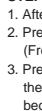
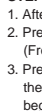
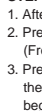
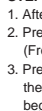
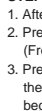
1. After setting the heating duration, the  LED starts to flash.
2. Press the  or  button to adjust the hours until time of activation (From 0-99 hours).
3. Press  button again or simply touch nothing for 10 seconds to confirm the setting. The  LED will light steadily, and the countdown to heater activation will begin.

**To modify the timer settings:** Press the  button and use the  or  button to adjust.

**Cancel the setting:** Press the  button for 2 seconds.

**NOTE:** After setting, the screen flashes the current temperature and time alternately.  
**NOTE:** Timer adjustment (amount of time with the heater ON) may be set from 1 to 48 hours; Reservation time adjustment (the number of hours FROM NOW when the heater will begin to function) may be set from 0 to 99 hours. If the timer is set at 0 hour, the heating system will activate immediately.

Note that the timer is one time per use - the user sets the duration of the heating cycle, and how many hours from now the heating cycle begins. The timer does NOT repeat until reset.

#### Message System Button



Use this button to activate the message system, which has a 30-minute auto-shutoff feature. The light above the Message System Button displays red when activated.

**IMPORTANT:** Do not run the Massage system when the cover is attached. Air can accumulate inside the spa and cause irreparable damage and bodily harm.

**NOTE:** Heat and massage system work together to create a warm massage experience.



#### Celsius/Fahrenheit Toggle

**This button has two function:**  
 The temperature can be displayed in either Fahrenheit or Celsius.

**This button has a matching pump and the remote control function, For more information, please refer to remote controller and pump matching operation instructions .**



#### Heat Button

Use this button to activate the heating system. When the light above the heat button is red, the heating system is activated. When the light is green, the water is at the set temperature and the heating system is at rest.

**NOTE:** If the heating system is activated the filtration system will automatically start.

**NOTE:** After turning off the heating system the filtration system will continue to operate.

#### Water Filter Button



This button turns the filter pump on and off. The light above the Water Filter Button displays red when activated.



#### Temperature Adjustment Buttons

Pressing the Temperature Increase or Decrease buttons will cause the LED to flash. When it is flashing you can adjust to the desired temperature setting. If you hold these buttons down the values will rapidly increase or decrease. The new and desired temperature setting will remain on the LED display for 3 seconds to confirm the new value.

**NOTE:** The default temperature is 35°C (95°F).

**NOTE:** Temperature adjustment ranges from 20°C (68°F) to 40°C (104°F).

#### On/Off Button



Press this button for 2 seconds to activate the control panel buttons and the light turns to green. Press this button for 2 seconds to turn off all currently activated functions.

**NOTE: when the remote control and pump matching, this button indicator will start flashing .**

#### Power-Saving Timer LED



This LED flashing means you are setting the heating duration. The light will be on when the heating function starts to work.



This LED flashing means you are setting the number of hours FROM NOW when the heater will activate. When the light is on, the Power-Saving Timer function is set.

#### LED Display



Once powered-up the LED displays the current water temperature automatically.



After 72 hours of filtration (without using the power saving timer function), the pump will hibernate and flash "End" with the current water temperature. When the pump is hibernating both the heating and water filter functions are disabled. To re-activate the pump press lock/unlock button for 3 seconds.







**NOTE:** The water heat rate may change in the conditions below:

- When the outdoor temperature is below 15°C (59°F).

- If the cover is not in position when the heating function is activated.

**NOTE:** To display the current water temperature, run the filter system for at least a minute. The water temperature as tested by an external thermometer may vary from the temperature as displayed on the spa panel by as much as approximately 2°C.

## Alarms

	Causes	Reasons	Solutions
	The water flow sensors work without pressing the filter or heat button.	<ol style="list-style-type: none"> <li>The water flow sensor flags didn't fall back into the correct position.</li> <li>The water flow sensors are broken.</li> </ol>	<ol style="list-style-type: none"> <li>Unplug the pump, strike the side of the pump firmly (but not violently), and plug it back in.</li> <li>To get assistance visit our website <a href="http://www.bestwaycorp.com">www.bestwaycorp.com</a> support section.</li> </ol>
	After starting or during the functions of filtering or/and heating, the water flow sensors do not detect water flow.	<ol style="list-style-type: none"> <li>You forgot to remove the 3 stopper caps from inside the pool.</li> <li>Filter cartridges are dirty.</li> <li>Activate the filter or heat system and put your hand in front of the outlet pipe inside the pool to check if you can feel water flowing out.               <ol style="list-style-type: none"> <li>If no water flows out the water pump is broken.</li> <li>Water flows out but the alarm <b>E02</b> appears, than the water flow sensors are broken.</li> </ol> </li> <li>Filter housing issue blockage</li> <li>Kinked or bent pipes. Poor water flow through the plastic pipes of the liner</li> <li>Debris screens are blocked: debris screens can become blocked by the hard water are as due to calcium build-up, those small debris block the opening of the debris and stop the flow.</li> <li>Perished washers The washers within the spa couplings may have become perished or worn.</li> </ol>	<ol style="list-style-type: none"> <li>Remove the two stopper caps before starting the heating system. Refer to the Assembly section in the User's Manual.</li> <li>Remove the filter set from inside the pool and push the filter or heat button. If no alarm appears, clean or change the filter cartridges and re-install the filter set inside the pool.</li> <li>To get assistance visit our website <a href="http://www.bestwaycorp.com">www.bestwaycorp.com</a> support section.</li> <li>Clean the filter housing and check for damage. Replace or re-install as necessary. If not, please to get assistance visit our website <a href="http://www.bestwaycorp.com">www.bestwaycorp.com</a> support section.</li> <li>Please check through the spa connection if you can see the pipes bending, to get assistance visit our website <a href="http://www.bestwaycorp.com">www.bestwaycorp.com</a> support section.</li> <li>Empty the spa and place a garden hose inside the pipes and wash the debris, to be sure all debris are removed perform the operation from outside and inside the spa. Use a toothbrush to remove any stubborn debris If the above steps, please to get assistance visit our website <a href="http://www.bestwaycorp.com">www.bestwaycorp.com</a> support section.</li> <li>Check the washers inside the coupling for damage. Unscrew the couplings and remove the washer for further inspection. If not, please to get assistance visit our website <a href="http://www.bestwaycorp.com">www.bestwaycorp.com</a> support section.</li> </ol>
	The pump's thermometer reads the water temperature below 4°C (40°F).	<ol style="list-style-type: none"> <li>The water temperature is lower than 4°C (40°F).</li> <li>If the water temperature is higher than 7°C (44.6°F), the pump's thermometer is broken.</li> </ol>	<ol style="list-style-type: none"> <li>The spa is not designed to operate with water temperatures lower than 4°C (40°F). Unplug the pump and only re-start the pump when the water temperature reaches 6°C (43°F).</li> <li>To get assistance visit our website <a href="http://www.bestwaycorp.com">www.bestwaycorp.com</a> support section.</li> </ol>
	The pump's thermometer reads the water temperature over 48°C (119°F).	<ol style="list-style-type: none"> <li>The water temperature is over 48°C (119°F).</li> <li>If the water temperature is lower than 45°C (113°F), the pump's thermometer is broken.</li> </ol>	<ol style="list-style-type: none"> <li>The spa is not designed to operate with water temperatures greater than 40°C (104°F). Unplug the pump and only re-start the pump when the water temperature reaches 38°C (100°F) or lower.</li> <li>To get assistance visit our website <a href="http://www.bestwaycorp.com">www.bestwaycorp.com</a> support section.</li> </ol>
	The pump's thermometer connections have issues.	<ol style="list-style-type: none"> <li>The pump's thermometer connectors don't work properly.</li> <li>The pump's thermometer is broken.</li> </ol>	To get assistance visit our website <a href="http://www.bestwaycorp.com">www.bestwaycorp.com</a> support section.
	The thermal cut-out cut off.	<ol style="list-style-type: none"> <li>The ambient temperature is over 50°C (122°F) or the pump is directly under the sunshine.</li> <li>The thermal cut-out is broken.</li> </ol>	<ol style="list-style-type: none"> <li>Unplug the pump, and put the pump in a dry, cool place. Only re-start the pump when the water temperature reaches 34°C (93.2°F) or lower.</li> <li>To get assistance visit our website <a href="http://www.bestwaycorp.com">www.bestwaycorp.com</a> support section.</li> </ol>

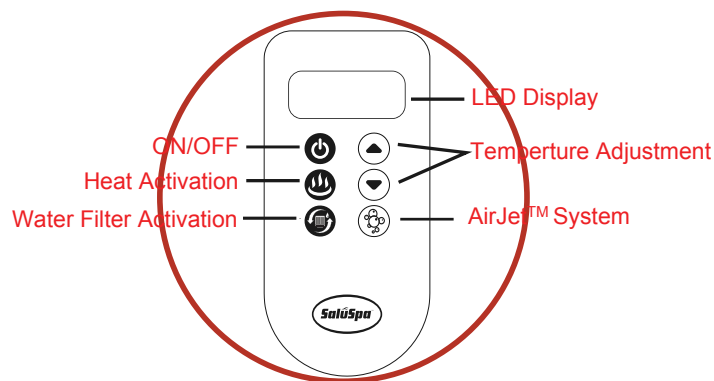

**IMPORTANT:** When the pump power, press the ON/OFF button . When the remote damage or loss, replace the new remote controls, you need to follow these steps to the remote control and pump matching: Remote controller and pump matching operation instructions:

1. After the GFCI Test, press the "RESET" button , then press the pump button on the control panel for 3 seconds, then the indicator start to flash , pump has entered the matching condition.
2. Press the button for 3 seconds on remote control , the LED display on remote control will appear "PIR", remote controller has entered the matching condition. If LED display appear "PAS" , means finish connection.

**NOTE:** 1. When the remote control or pump into the matching condition, only 20 seconds matching time, matching will fail over time, You need to follow the steps above to match.

3. When the pump and the remote control matching conditions at the same time, the matching will be successful.

4. The remote controller matching is successful, First of all, you need to open the button, Then you can start to use

**NOTE:** The distance of remote control is less the 10m.

**WARNING !**

Do not put the Remote Control in the water, if the remote control falls into water, take it out of the water immediately. Damage to the remote control caused by immersion in the water is not covered under your warranty.

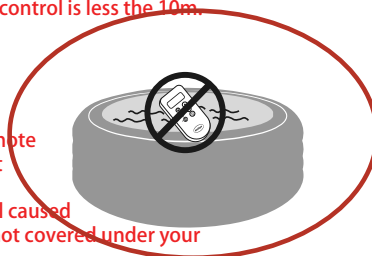

**The battery replacement**

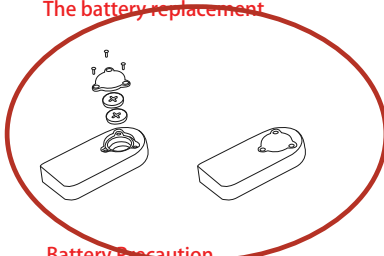

**Battery Precaution**

- Do not mix old and new batteries.
- Do not mix the different types of batteries. Do not mix alkaline, standard (Carbon - Zinc), or rechargeable (Nickel - Cadmium) batteries.
- Ensure batteries are installed correctly with regard to polarity (+ and -).
- Do not short-circuit the battery.
- Never attempt to recharge primary batteries as this may cause leakage, fire, or explosion.
- Rechargeable batteries are to be removed from this product before being charged.
- Never attempt to disassemble or open batteries as this can lead to electrolyte burns.
- Remove batteries from equipment which is not to be used for an extended period of time.
- Exhausted batteries are to be removed from this product.
- Do not dispose of product and its batteries in fire. Check your local regulations for proper disposal instructions.
- Batteries shall not be exposed to excessive heat such as sunshine, fire or the similar.
- Keep batteries out of the reach of children.
- Only use 2x CR2032 batteries.