



# **FCC RADIO TEST REPORT**

## **FCC ID: 2ACG9E503**

**Product :** GSM MOBILE PHONE

**Trade Name :** Vantec Mobile

**Model Number :** E503

**Serial Model :** N/A

**Report No. :** BZT14052987

### **Prepared for**

Conedera sa

alborada 10 etapa local 23,Guayaquil,Ecuador

### **Prepared by**

BZT Testing Technology Co., Ltd.

**TEST RESULT CERTIFICATION**

**Applicant's name** ..... Conedera sa

Address..... alborada 10 etapa local 23,Guayaquil,Ecuador

**Manufacture's Name** ..... Shenzhen L&P Ace Technology Co.,Ltd

Address..... 5th floor, 23block,Changxing Technology, Wan'an Road, Shayi Village, Shajin Town, Shenzhen,China

**Product description**

Product name ..... GSM MOBILE PHONE

Model and/or type reference ..... E503

Serial Model : N/A

Ratings DC 5V from Adapter AC 120V/60Hz

**Standards** ..... FCC Part15.247

Test procedure ..... ANSI C63.4-2003

This device described above has been tested by BZT, and the test results show that the equipment under test (EUT) is in compliance with the FCC requirements. And it is applicable only to the tested sample identified in the report.

This report shall not be reproduced except in full, without the written approval of BZT, this document may be altered or revised by BZT, personal only, and shall be noted in the revision of the document.

**Date of Test**.....

Date (s) of performance of tests ..... 12 May 2014 ~25 May 2014

Date of Issue..... 29 May 2014

Test Result ..... **Pass**

Testing Engineer : Apple Huang  
(Apple Huang)

Technical Manager : Tom Zhang  
(Tom Zhang)

Authorized Signatory : Bovey Yang  
(Bovey Yang)

**Table of Contents**

	<b>Page</b>
<b>1 . SUMMARY OF TEST RESULTS</b>	<b>5</b>
1.1 TEST FACILITY	6
1.2 MEASUREMENT UNCERTAINTY	6
<b>2 . GENERAL INFORMATION</b>	<b>7</b>
2.1 GENERAL DESCRIPTION OF EUT	7
2.2 DESCRIPTION OF TEST MODES	9
2.3 TABLE OF PARAMETERS OF TEXT SOFTWARE SETTING	9
2.4 BLOCK DIGRAM SHOWING THE CONFIGURATION OF SYSTEM TESTED	10
2.5 DESCRIPTION OF SUPPORT UNITS(CONDUCTED MODE)	11
2.6 EQUIPMENTS LIST FOR ALL TEST ITEMS	12
<b>3 . EMC EMISSION TEST</b>	<b>13</b>
3.1 CONDUCTED EMISSION MEASUREMENT	13
3.1.1 POWER LINE CONDUCTED EMISSION LIMITS	13
3.1.2 TEST PROCEDURE	14
3.1.3 DEVIATION FROM TEST STANDARD	14
3.1.4 TEST SETUP	14
3.1.5 EUT OPERATING CONDITIONS	14
3.1.6 TEST RESULTS	15
3.2 RADIATED EMISSION MEASUREMENT	17
3.2.1 RADIATED EMISSION LIMITS	17
3.2.2 TEST PROCEDURE	18
3.2.3 DEVIATION FROM TEST STANDARD	18
3.2.4 TEST SETUP	19
3.2.5 EUT OPERATING CONDITIONS	20
3.2.6 TEST RESULTS (BELOW 30 MHZ)	21
3.2.7 TEST RESULTS (BETWEEN 30M – 1000 MHZ)	22
3.2.8 TEST RESULTS (ABOVE 1000 MHZ)	24
3.2.9 TEST RESULTS (RESTRICTED BANDS REQUIREMENTS)	27
<b>4 . NUMBER OF HOPPING CHANNEL</b>	<b>28</b>
4.1 APPLIED PROCEDURES / LIMIT	28
4.1.1 TEST PROCEDURE	28
4.1.2 DEVIATION FROM STANDARD	28
4.1.3 TEST SETUP	28
4.1.4 EUT OPERATION CONDITIONS	28
4.1.5 TEST RESULTS	29
<b>5 . AVERAGE TIME OF OCCUPANCY</b>	<b>30</b>
5.1 APPLIED PROCEDURES / LIMIT	30

**Table of Contents**

	<b>Page</b>
5.1.1 TEST PROCEDURE	30
5.1.2 DEVIATION FROM STANDARD	30
5.1.3 TEST SETUP	30
5.1.4 EUT OPERATION CONDITIONS	30
5.1.5 TEST RESULTS	31
<b>6 . HOPPING CHANNEL SEPARATION MEASUREMENT</b>	<b>32</b>
6.1 APPLIED PROCEDURES / LIMIT	32
6.1.1 TEST PROCEDURE	32
6.1.2 DEVIATION FROM STANDARD	32
6.1.3 TEST SETUP	32
6.1.4 EUT OPERATION CONDITIONS	32
6.1.5 TEST RESULTS	33
<b>7 . BANDWIDTH TEST</b>	<b>35</b>
7.1 APPLIED PROCEDURES / LIMIT	35
7.1.1 TEST PROCEDURE	35
7.1.2 DEVIATION FROM STANDARD	35
7.1.3 TEST SETUP	35
7.1.4 EUT OPERATION CONDITIONS	35
7.1.5 TEST RESULTS	36
<b>8 . PEAK OUTPUT POWER TEST</b>	<b>38</b>
8.1 APPLIED PROCEDURES / LIMIT	38
8.1.1 TEST PROCEDURE	38
8.1.2 DEVIATION FROM STANDARD	38
8.1.3 TEST SETUP	38
8.1.4 EUT OPERATION CONDITIONS	38
8.1.5 TEST RESULTS	39
<b>9 . ANTENNA REQUIREMENT</b>	<b>40</b>
9.1 STANDARD REQUIREMENT	40
9.2 EUT ANTENNA	40
<b>10 . EUT TEST PHOTO</b>	<b>41</b>
<b>APPENDIX-PHOTOGRAPHS OF EUT CONSTRUCTIONAL DETAILS</b>	

## 1. SUMMARY OF TEST RESULTS

Test procedures according to the technical standards:

<b>FCC Part15 (15.247) , Subpart C</b>			
Standard Section	Test Item	Judgment	Remark
15.207	Conducted Emission	PASS	
15.247(a)(1)	Hopping Channel Separation	PASS	
15.247(b)(1)	Peak Output Power	PASS	
15.247(c)	Radiated Spurious Emission	PASS	
15.247(a)(iii)	Number of Hopping Frequency	PASS	
15.247(a)(iii)	Dwell Time	PASS	
15.247(a)(1)	Bandwidth	PASS	
15.205	Band Edge Emission	PASS	
15.203	Antenna Requirement	PASS	

**NOTE:**

(1) "N/A" denotes test is not applicable in this Test Report

## 1.1 TEST FACILITY

BZT Testing Technology Co., Ltd

Add. : 1/F, Building E, Fenda Science Park, Sanwei Community, Xixiang Street, Bao'an District, Shenzhen P.R. China.

FCC Registration No.: 701733

## 1.2 MEASUREMENT UNCERTAINTY

The reported uncertainty of measurement  $y \pm U$ , where expanded uncertainty  $U$  is based on a standard uncertainty multiplied by a coverage factor of  $k=2$ , providing a level of confidence of approximately **95 %**.

No.	Item	Uncertainty
1	Conducted Emission Test	$\pm 1.38\text{dB}$
2	RF power,conducted	$\pm 0.16\text{dB}$
3	Spurious emissions,conducted	$\pm 0.21\text{dB}$
4	All emissions,radiated(<1G)	$\pm 4.68\text{dB}$
5	All emissions,radiated(>1G)	$\pm 4.89\text{dB}$
6	Temperature	$\pm 0.5^{\circ}\text{C}$
7	Humidity	$\pm 2\%$

## 2. GENERAL INFORMATION

### 2.1 GENERAL DESCRIPTION OF EUT

Equipment	GSM MOBILE PHONE	
Trade Name	Vantec Mobile	
Model Name	E503	
Serial Model	N/A	
Model Difference	N/A	
Product Description	The EUT is a GSM MOBILE PHONE	
	Operation Frequency:	2402~2480 MHz
	Modulation Type:	FHSS
	Bit Rate of Transmitter	GFSK
	Number Of Channel	79 CH
	Antenna Designation:	Please see Note 3.
	Antenna Gain(Peak)	0.8dBi
	Output Power(Conducted):	2.04 dBm (Max.)
	Based on the application, features, or specification exhibited in User's Manual, the EUT is considered as an ITE/Computing Device. More details of EUT technical specification, please refer to the User's Manual.	
Channel List	Please refer to the Note 2.	
Adapter	N/A	
Battery	Rated Voltage: 3.7V	
Connecting I/O Port(s)	Please refer to the User's Manual	

Note:

1. For a more detailed features description, please refer to the manufacturer's specifications or the User's Manual.

2.

Channel List					
Channel	Frequency (MHz)	Channel	Frequency (MHz)	Channel	Frequency (MHz)
00	2402	27	2429	54	2456
01	2403	28	2430	55	2457
02	2404	29	2431	56	2458
03	2405	30	2432	57	2459
04	2406	31	2433	58	2460
05	2407	32	2434	59	2461
06	2408	33	2435	60	2462
07	2409	34	2436	61	2463
08	2410	35	2437	62	2464
09	2411	36	2438	63	2465
10	2412	37	2439	64	2466
11	2413	38	2440	65	2467
12	2414	39	2441	66	2468
13	2415	40	2442	67	2469
14	2416	41	2443	68	2470
15	2417	42	2444	69	2471
16	2418	43	2445	70	2472
17	2419	44	2446	71	2473
18	2420	45	2447	72	2474
19	2421	46	2448	73	2475
20	2422	47	2449	74	2476
21	2423	48	2450	75	2477
22	2424	49	2451	76	2478
23	2425	50	2452	77	2479
24	2426	51	2453	78	2480
25	2427	52	2454		
26	2428	53	2455		

3.

Table for Filed Antenna

Ant	Brand	Model Name	Antenna Type	Connector	Gain (dBi)	NOTE
1	N/A	N/A	Wire Antenna	NA	0.8	BT Antenna

The EUT antenna is integral Antenna. no antenna other than that furnished by the responsible party shall be used with the device.



## 2.2 DESCRIPTION OF TEST MODES

To investigate the maximum EMI emission characteristics generates from EUT, the test system was pre-scanning tested base on the consideration of following EUT operation mode or test configuration mode which possible have effect on EMI emission level. Each of these EUT operation mode(s) or test configuration mode(s) mentioned above was evaluated respectively.

Pretest Mode	Description
Mode 1	CH00
Mode 2	CH39
Mode 3	CH78

For Conducted Emission	
Final Test Mode	Description
Mode4	Link mode

For Radiated Emission	
Final Test Mode	Description
Mode 1	CH00
Mode 2	CH39
Mode 3	CH78
Mode4	Link mode

Note:

(1) The measurements are performed at the highest, middle, lowest available channels.

## 2.3 TABLE OF PARAMETERS OF TEXT SOFTWARE SETTING

During testing channel & power controlling software provided by the customer was used to control the operating channel as well as the output power level. The RF output power selection is for the setting of RF output power expected by the customer and is going to be fixed on the firmware of the final end product power parameters of FHSS

Test software Version	Test program: N/A		
Frequency	2402 MHz	2441 MHz	2480 MHz
Parameters(1Mbps)	DEF	DEF	DEF

**2.4 BLOCK DIGRAM SHOWING THE CONFIGURATION OF SYSTEM TESTED**

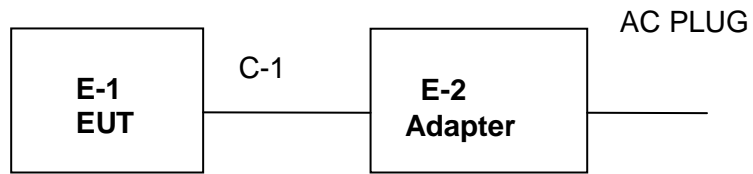

**2.5 DESCRIPTION OF SUPPORT UNITS(CONDUCTED MODE)**

The EUT has been tested as an independent unit together with other necessary accessories or support units. The following support units or accessories were used to form a representative test configuration during the tests.

Item	Equipment	Mfr/Brand	Model/Type No.	Series No.	Note
E-1	GSM MOBILE PHONE	N/A	E503	N/A	EUT
E-2	Adapter	N/A	E503	N/A	

Item	Shielded Type	Ferrite Core	Length	Note
C-1	NO	NO	0.8m	

**Note:**

- (1) The support equipment was authorized by Declaration of Confirmation.
- (2) For detachable type I/O cable should be specified the length in cm in 『Length』 column.
- (3) “YES” is means “shielded” “with core”; “NO” is means “unshielded” “without core”.

## 2.6 EQUIPMENTS LIST FOR ALL TEST ITEMS

### Radiation Test equipment

Item	Kind of Equipment	Manufacturer	Type No.	Serial No.	Calibrated until
1	Spectrum Analyzer	Agilent	E4407B	160400005	Jul. 06. 2014
2	Test Receiver	R&S	ESPI	101318	Jul. 06. 2014
3	Bilog Antenna	TESEQ	CBL6111D	31216	Nov.23. 2014
4	50Ω Coaxial Switch	Anritsu	MP59B	6200264416	Jul. 06. 2014
5	Spectrum Analyzer	ADVANTEST	R3132	150900201	Jul. 06. 2014
6	Horn Antenna	EM	EM-AH-10180	2011071402	Nov.23. 2014
7	Horn Ant	Schwarzbeck	BBHA 9170	9170-181	Jul. 06. 2014
8	Amplifier	EM	EM-30180	060538	Jul. 06. 2014
9	Loop Antenna	ARA	PLA-1030/B	1029	Jul. 06. 2014
10	Power Meter	R&S	NRVS	100696	Jul. 06. 2014
11	Power Sensor (Peak)	R&S	NRV-Z31	0396.0101.1 9	Jul. 06. 2014

### Conduction Test equipment

Item	Kind of Equipment	Manufacturer	Type No.	Serial No.	Calibrated until
1	Test Receiver	R&S	ESCI	101160	Jul. 06. 2014
2	LISN	R&S	ENV216	101313	Jul. 06. 2014
3	LISN	EMCO	3816/2	00042990	Jul. 06. 2014
4	50Ω Coaxial Switch	Anritsu	MP59B	6200264417	Jul. 06. 2014
5	Passive Voltage Probe	R&S	ESH2-Z3	100196	Jul. 06. 2014
6	Absorbing clamp	R&S	MOS-21	100423	Jul. 06. 2014

### 3. EMC EMISSION TEST

#### 3.1 CONDUCTED EMISSION MEASUREMENT

##### 3.1.1 POWER LINE CONDUCTED EMISSION Limits (Frequency Range 150KHz-30MHz)

FREQUENCY (MHz)	Class A (dBuV)		Class B (dBuV)		Standard
	Quasi-peak	Average	Quasi-peak	Average	
0.15 -0.5	79.00	66.00	66 - 56 *	56 - 46 *	CISPR
0.50 -5.0	73.00	60.00	56.00	46.00	CISPR
5.0 -30.0	73.00	60.00	60.00	50.00	CISPR

0.15 -0.5	79.00	66.00	66 - 56 *	56 - 46 *	FCC
0.50 -5.0	73.00	60.00	56.00	46.00	FCC
5.0 -30.0	73.00	60.00	60.00	50.00	FCC

Note:

- (1) The tighter limit applies at the band edges.
- (2) The limit of " \* " marked band means the limitation decreases linearly with the logarithm of the frequency in the range.

The following table is the setting of the receiver

Receiver Parameters	Setting
Attenuation	10 dB
Start Frequency	0.15 MHz
Stop Frequency	30 MHz
IF Bandwidth	9 kHz

**3.1.2 TEST PROCEDURE**

- a. The EUT was placed 0.4 meters from the horizontal ground plane with EUT being connected to the power mains through a line impedance stabilization network (LISN). All other support equipments powered from additional LISN(s). The LISN provide 50 Ohm/ 50uH of coupling impedance for the measuring instrument.
- b. Interconnecting cables that hang closer than 40 cm to the ground plane shall be folded back and forth in the center forming a bundle 30 to 40 cm long.
- c. I/O cables that are not connected to a peripheral shall be bundled in the center. The end of the cable may be terminated, if required, using the correct terminating impedance. The overall length shall not exceed 1 m.
- d. LISN at least 80 cm from nearest part of EUT chassis.
- e. For the actual test configuration, please refer to the related Item –EUT Test Photos.

**3.1.3 DEVIATION FROM TEST STANDARD**

No deviation

**3.1.4 TEST SETUP**

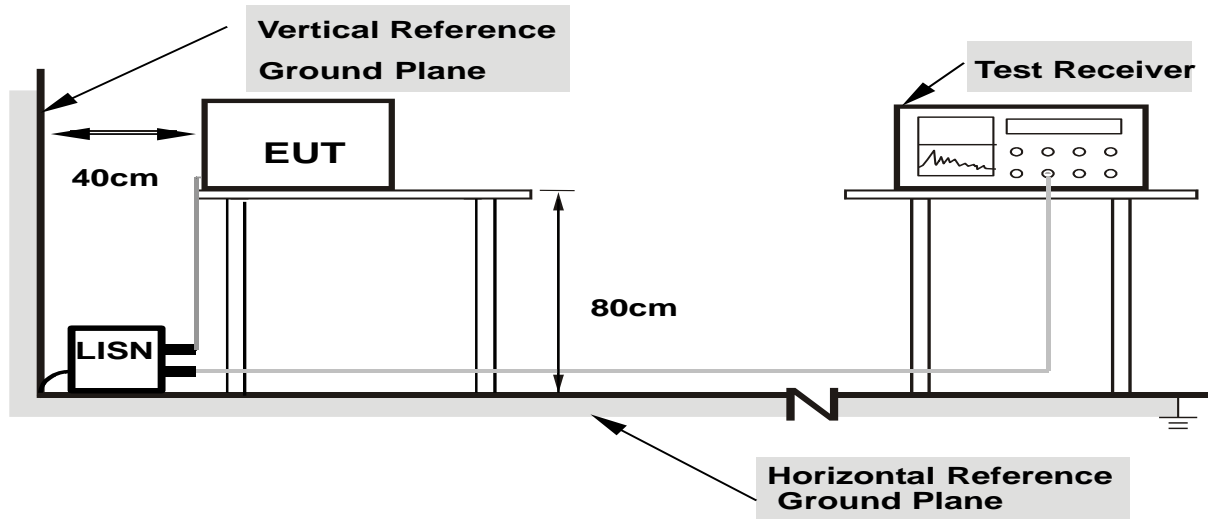

- Note:**
- 1.Support units were connected to second LISN.
  - 2.Both of LISNs (AMN) are 80 cm from EUT and at least 80 from other units and other metal planes

**3.1.5 EUT OPERATING CONDITIONS**

The EUT was configured for testing in a typical fashion (as a customer would normally use it). The EUT has been programmed to continuously transmit during test. This operating condition was tested and used to collect the included data.

### 3.1.6 TEST RESULTS

EUT :	GSM MOBILE PHONE	Model Name. :	E503
Temperature :	26 °C	Relative Humidity :	54%
Pressure :	1010hPa	Phase :	N
Test Voltage :	DC 5V from Adapter with AC 120V/60Hz	Test Mode :	Mode 4

Frequency (MHz)	Meter Reading (dBμV)	Factor (dB)	Emission Level (dBμV/m)	Limits (dBμV/m)	Margin (dB)	Detector Type
0.2459	46.33	9.5	55.83	61.89	-6.06	QP
0.2459	39.3	9.5	48.8	51.89	-3.09	AVG
0.3699	41.19	9.52	50.71	58.5	-7.79	QP
0.3699	35.09	9.52	44.61	48.5	-3.89	AVG
0.4939	35.98	9.53	45.51	56.1	-10.59	QP
0.4939	30.65	9.53	40.18	46.1	-5.92	AVG
1.114	34.63	9.55	44.18	56	-11.82	QP
1.114	29.19	9.55	38.74	46	-7.26	AVG
1.9739	33.71	9.57	43.28	56	-12.72	QP
1.9739	26.05	9.57	35.62	46	-10.38	AVG
8.9778	30.36	9.71	40.07	60	-19.93	QP
8.9778	13.93	9.71	23.64	50	-26.36	AVG

Remark:

1. Factor = Antenna Factor + Cable Loss – Pre-amplifier.

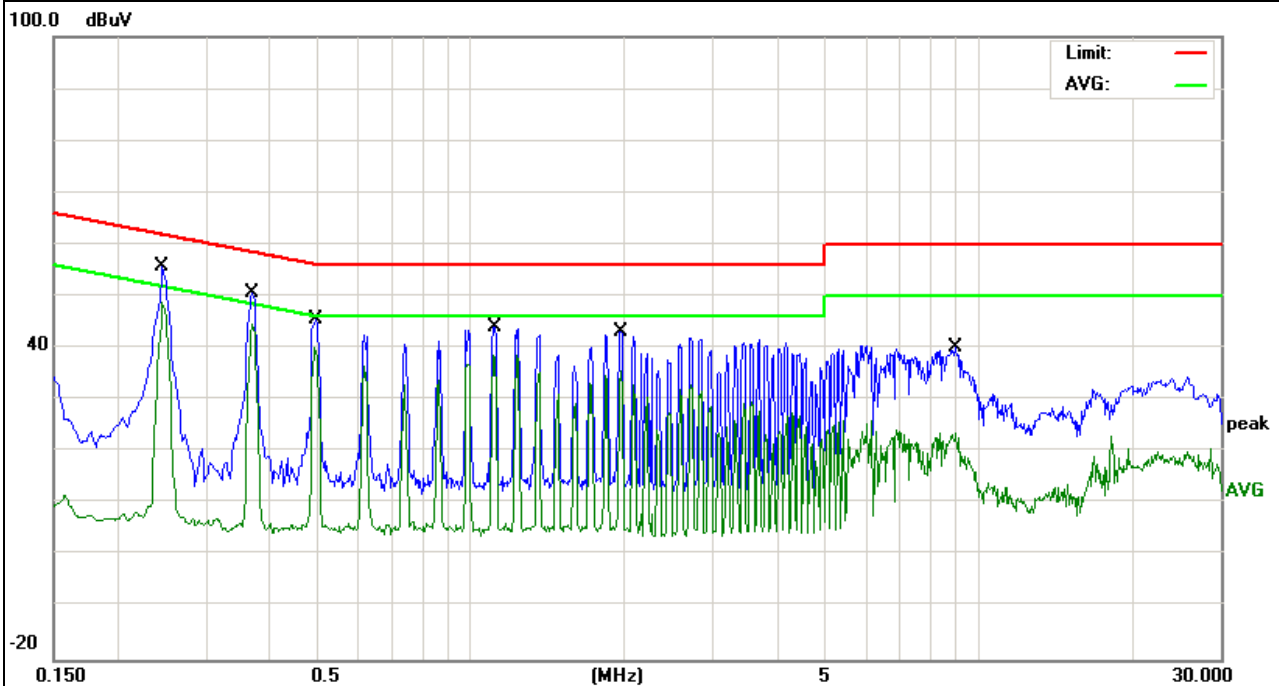

EUT :	GSM MOBILE PHONE	Model Name. :	E503
Temperature :	26 °C	Relative Humidity :	54%
Pressure :	1010hPa	Phase :	L
Test Voltage :	DC 5V from Adapter with AC 120V/60Hz	Test Mode :	Mode 4

Frequency (MHz)	Meter Reading (dBμV)	Factor (dB)	Emission Level (dBμV/m)	Limits (dBμV/m)	Margin (dB)	Detector Type
0.2403	40.76	9.5	50.26	62.08	-11.82	QP
0.2403	33.49	9.5	42.99	52.08	-9.09	AVG
0.3619	34.48	9.52	44	58.68	-14.68	QP
0.3619	29.38	9.52	38.9	48.68	-9.78	AVG
1.1019	35.47	9.55	45.02	56	-10.98	QP
1.1019	31.63	9.55	41.18	46	-4.82	AVG
2.6979	34.27	9.57	43.84	56	-12.16	QP
2.6979	25.86	9.57	35.43	46	-10.57	AVG
5.8658	33.4	9.63	43.03	60	-16.97	QP
5.8658	19.98	9.63	29.61	50	-20.39	AVG
17.2099	24.51	9.99	34.5	60	-25.5	QP
17.2099	13.48	9.99	23.47	50	-26.53	AVG

**Remark:**

1. Factor = Antenna Factor + Cable Loss – Pre-amplifier.

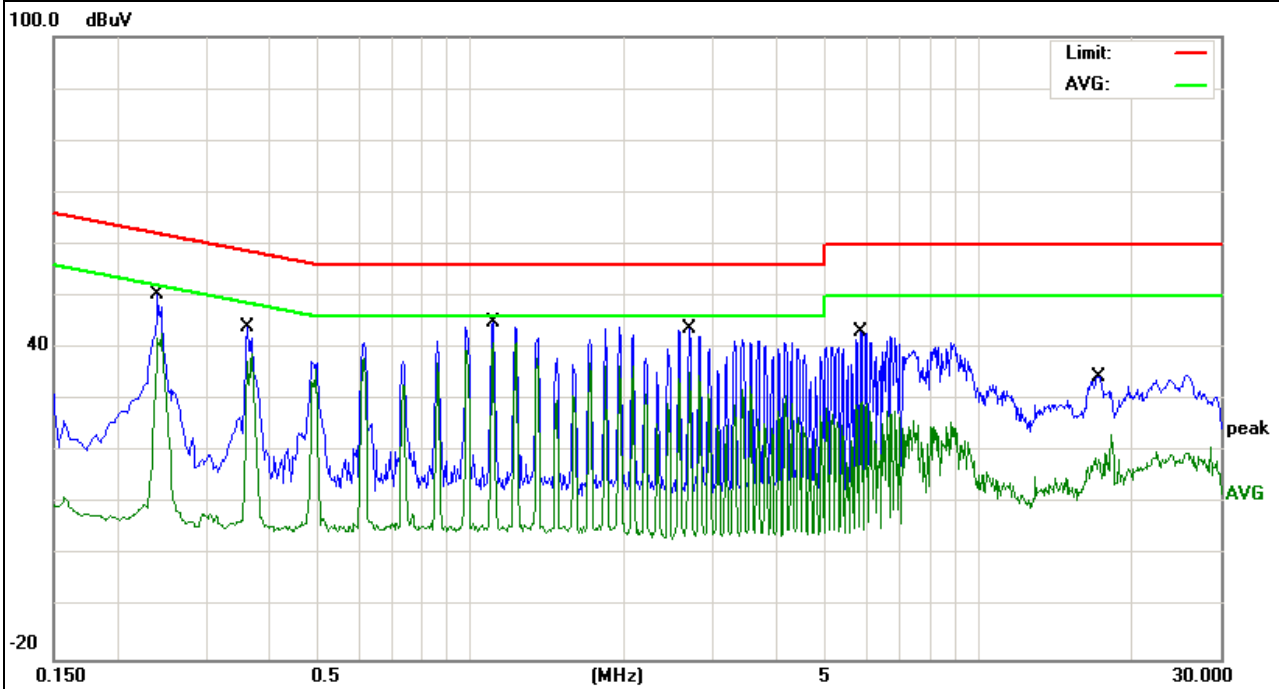



### 3.2 RADIATED EMISSION MEASUREMENT

#### 3.2.1 RADIATED EMISSION LIMITS (Frequency Range 9kHz-1000MHz)

20dBc in any 100 kHz bandwidth outside the operating frequency band. In case the emission fall within the restricted band specified on 15.205(a), then the 15.209(a) limit in the table below has to be followed.

Frequencies (MHz)	Field Strength (micorvolts/meter)	Measurement Distance (meters)
0.009~0.490	2400/F(KHz)	300
0.490~1.705	24000/F(KHz)	30
1.705~30.0	30	30
30~88	100	3
88~216	150	3
216~960	200	3
Above 960	500	3

#### LIMITS OF RADIATED EMISSION MEASUREMENT (Above 1000MHz)

FREQUENCY (MHz)	Class A (dBuV/m) (at 3M)		Class B (dBuV/m) (at 3M)	
	PEAK	AVERAGE	PEAK	AVERAGE
Above 1000	80	60	74	54

Notes:

- (1) The limit for radiated test was performed according to FCC PART 15C.
- (2) The tighter limit applies at the band edges.
- (3) Emission level (dBuV/m)=20log Emission level (uV/m).

#### FREQUENCY RANGE OF RADIATED MEASUREMENT (For unintentional radiators)

Highest frequency generated or Upper frequency of measurement used in the device or on which the device operates or tunes (MHz)	Range (MHz)
Below 1.705	30
1.705 – 108	1000
108 – 500	2000
500 – 1000	5000
Above 1000	5 <sup>th</sup> harmonic of the highest frequency or 40 GHz, whichever is lower

Spectrum Parameter	Setting
Attenuation	Auto
Start Frequency	1000 MHz
Stop Frequency	10th carrier harmonic
RB / VB (emission in restricted band)	1 MHz / 1 MHz for Peak, 1 MHz / 10Hz for Average

Receiver Parameter	Setting
Attenuation	Auto
Start ~ Stop Frequency	9kHz~150kHz / RB 200Hz for QP
Start ~ Stop Frequency	150kHz~30MHz / RB 9kHz for QP
Start ~ Stop Frequency	30MHz~1000MHz / RB 120kHz for QP

**3.2.2 TEST PROCEDURE**

- a. The measuring distance of at 3 m shall be used for measurements at frequency up to 1GHz. For frequencies above 1GHz, any suitable measuring distance may be used.
- b. The EUT was placed on the top of a rotating table 0.8 meters above the ground at a 3 meter open area test site. The table was rotated 360 degrees to determine the position of the highest radiation.
- c. The height of the equipment or of the substitution antenna shall be 0.8 m; the height of the test antenna shall vary between 1 m to 4 m. Both horizontal and vertical polarizations of the antenna are set to make the measurement.
- d. The initial step in collecting conducted emission data is a spectrum analyzer peak detector mode pre-scanning the measurement frequency range. Significant peaks are then marked and then Quasi Peak detector mode re-measured.
- e. If the Peak Mode measured value compliance with and lower than Quasi Peak Mode Limit, the EUT shall be deemed to meet QP Limits and then no additional QP Mode measurement performed.
- f. For the actual test configuration, please refer to the related Item –EUT Test Photos.

Note:

Both horizontal and vertical antenna polarities were tested and performed pretest to three orthogonal axis. The worst case emissions were reported

**3.2.3 DEVIATION FROM TEST STANDARD**

No deviation

### 3.2.4 TEST SETUP

#### (A) Radiated Emission Test-Up Frequency Below 30MHz

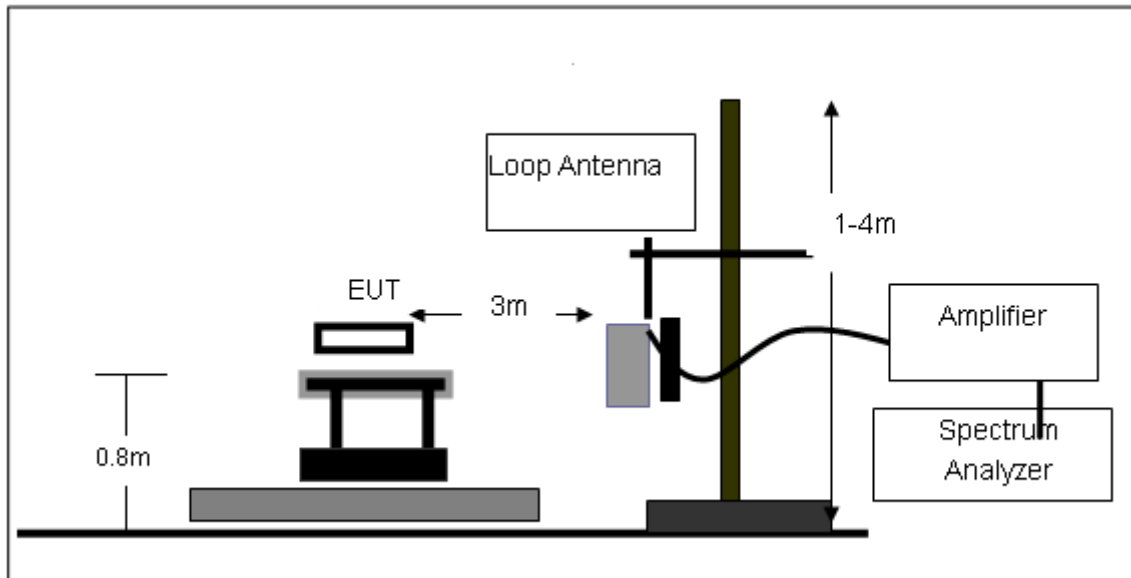

#### (B) Radiated Emission Test-Up Frequency 30MHz~1GHz

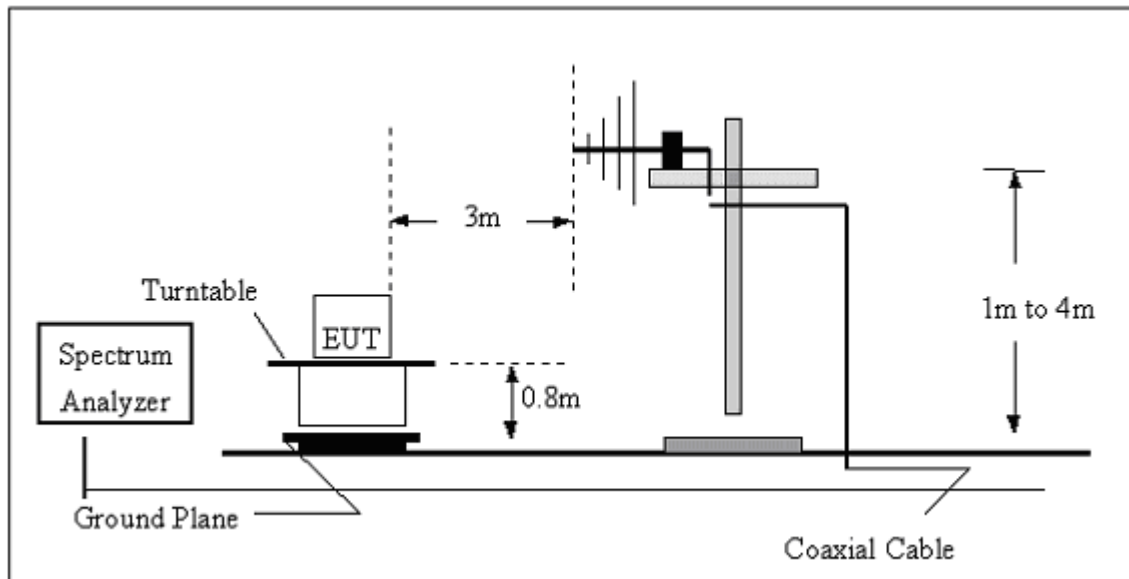

(C) Radiated Emission Test-Up Frequency Above 1GHz

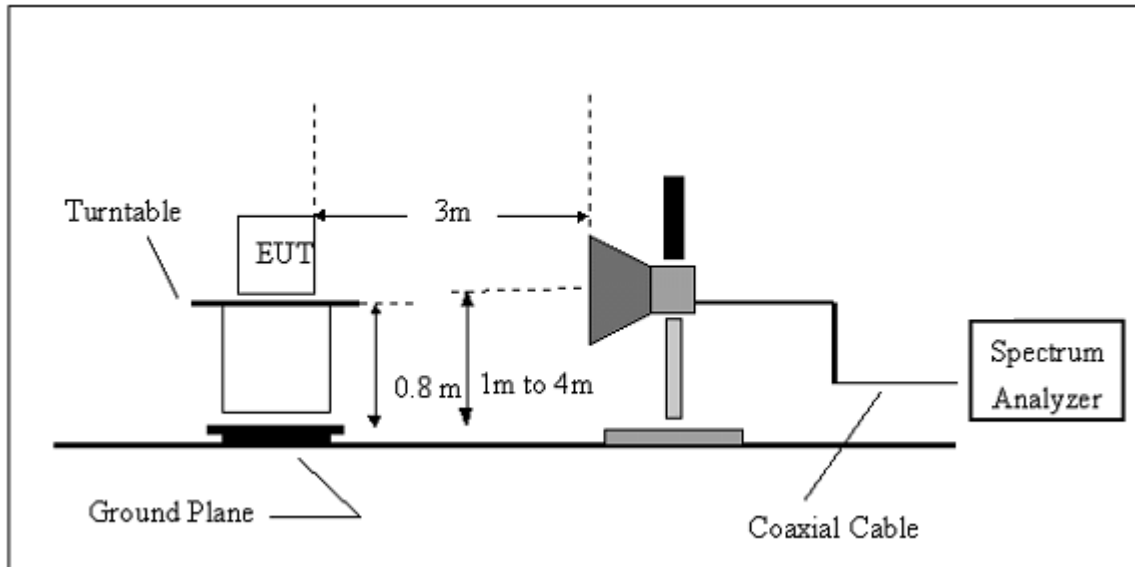

**3.2.5 EUT OPERATING CONDITIONS**

The EUT tested system was configured as the statements of 2.4 Unless otherwise a special operating condition is specified in the follows during the testing.

### 3.2.6 TEST RESULTS (BELOW 30 MHZ)

EUT :	GSM MOBILE PHONE	Model Name :	E503
Temperature :	20 °C	Relative Humidity :	48%
Pressure :	1010 hPa	Polarization :	---
Test Voltage :	DC 5V from Adapter AC 120V/60Hz		
Test Mode :	Link mode		

Freq. (MHz)	Reading (dBuV/m)	Limit (dBuV/m)	Margin (dB)	State P/F
--	--	--	--	PASS
--	--	--	--	PASS

**NOTE:**

The amplitude of spurious emissions which are attenuated by more than 20dB below the permissible value has no need to be reported.

Distance extrapolation factor =  $40 \log (\text{specific distance}/\text{test distance})$ (dB);

Limit line = specific limits(dBuv) + distance extrapolation factor.

**3.2.7 TEST RESULTS (BETWEEN 30M – 1000 MHZ)**

EUT :	GSM MOBILE PHONE	Model Name :	E503
Temperature :	20 °C	Relative Humidity :	48%
Pressure :	1010 hPa	Polarization :	Horizontal
Test Voltage :	DC 5V from Adapter AC 120V/60Hz		
Test Mode :	Link mode		

Frequency (MHz)	Meter Reading (dBμV)	Factor (dB)	Emission Level (dBμV/m)	Limits (dBμV/m)	Margin (dB)	Detector Type
30.6377	6.24	18.04	24.28	40	-15.72	QP
54.4515	16.28	6.44	22.72	40	-17.28	QP
127.2176	8.07	12.21	20.28	43.5	-23.22	QP
261.9753	6.68	14.77	21.45	46	-24.55	QP
414.7223	6.42	18.88	25.3	46	-20.7	QP
755.3872	8.45	26.4	34.85	46	-11.15	QP

Remark:

1. Factor = Antenna Factor + Cable Loss – Pre-amplifier.

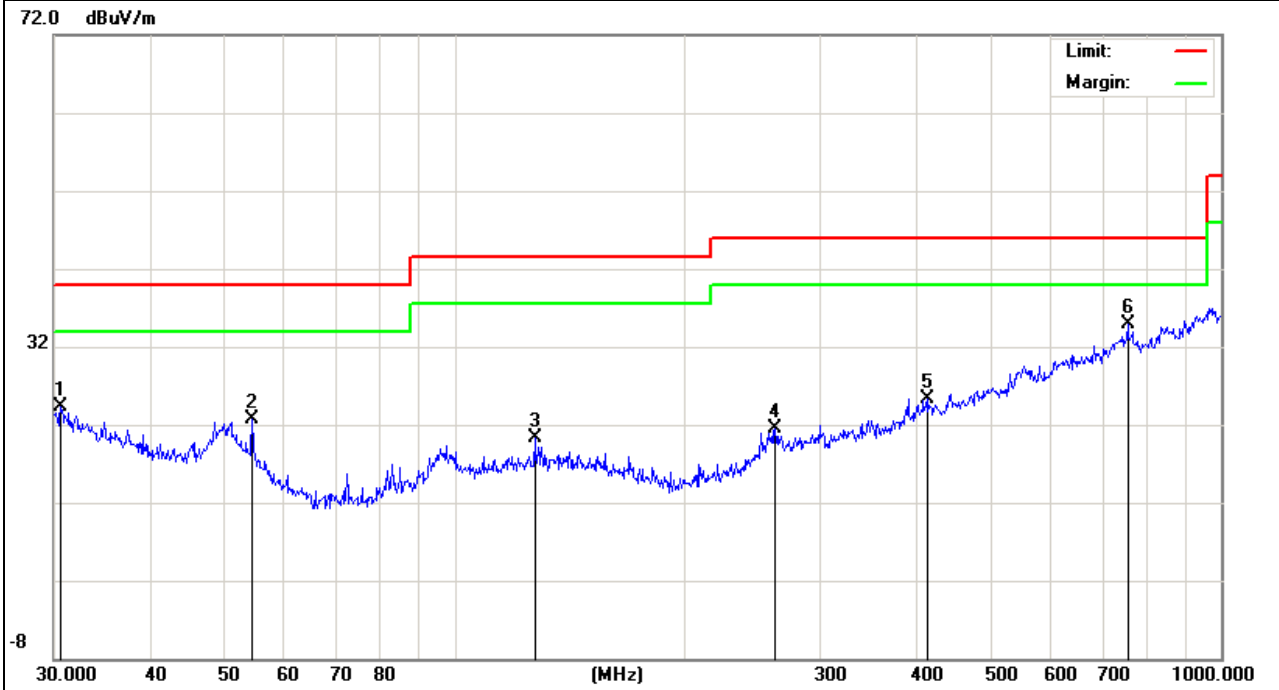

EUT :	GSM MOBILE PHONE	Model Name :	E503
Temperature :	20 °C	Relative Humidity :	48%
Pressure :	1010 hPa	Polarization :	Vertical
Test Voltage :	DC 5V from Adapter AC 120V/60Hz		
Test Mode :	Link mode		

Frequency (MHz)	Meter Reading (dBµV)	Factor (dB)	Emission Level (dBµV/m)	Limits (dBµV/m)	Margin (dB)	Detector Type
30	6.98	18.33	25.31	40	-14.69	QP
132.685	6.1	12.23	18.33	43.5	-25.17	QP
269.4284	8.83	14.14	22.97	46	-23.03	QP
350.4768	9.24	16.35	25.59	46	-20.41	QP
390.7225	8.21	17.78	25.99	46	-20.01	QP
912.8618	10.38	28.34	38.72	46	-7.28	QP

Remark:

1. Factor = Antenna Factor + Cable Loss – Pre-amplifier.

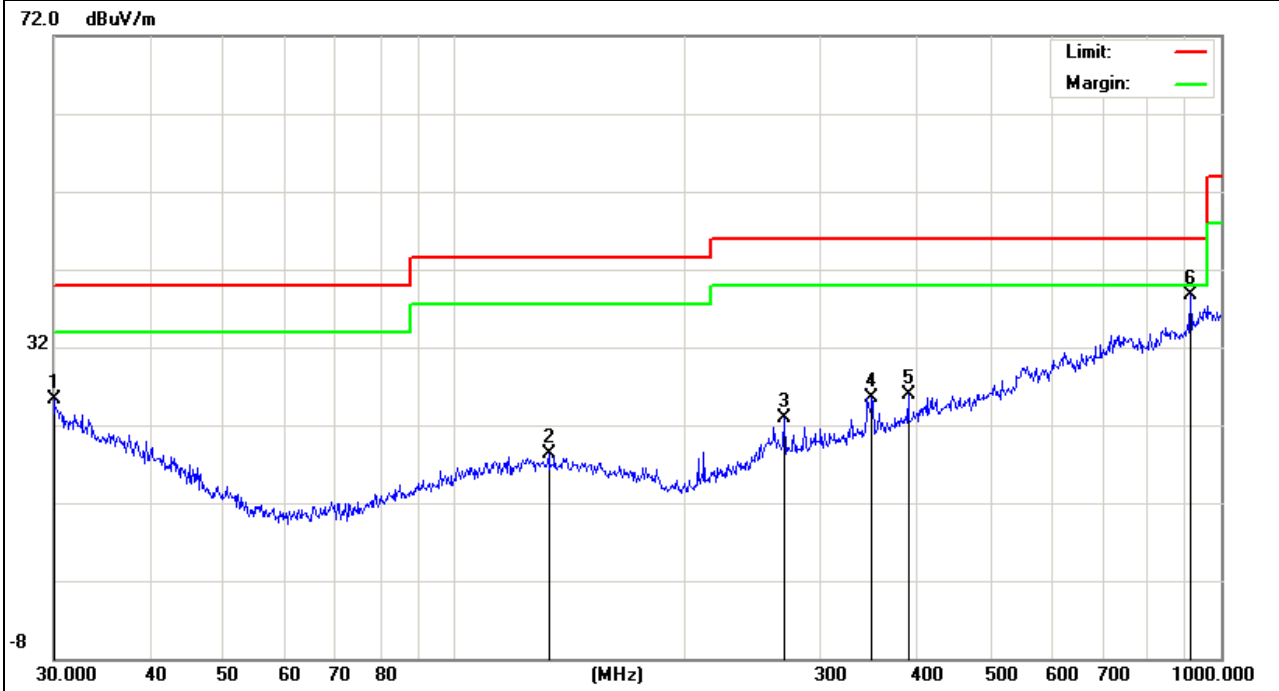

### 3.2.8 TEST RESULTS (ABOVE 1000 MHZ)

EUT :	GSM MOBILE PHONE	Model Name :	E503
Temperature :	20 °C	Relative Humidity :	48%
Pressure :	1010 hPa	Test Voltage :	DC 5V from Adapter AC 120V/60Hz
Test Mode :	TX 2402MHz – CH 00(1Mbps)	Polarization :	Horizontal

Frequency (MHz)	Meter Reading (dBµV)	Factor (dB)	Emission Level (dBµV/m)	Limits (dBµV/m)	Margin (dB)	Detector Type
4804	58.41	-3.64	54.77	74	-19.23	peak
4804	47.36	-3.64	43.72	54	-10.28	AVG
7206	56.73	-0.95	55.78	74	-18.22	peak
7206	42.52	-0.95	41.57	54	-12.43	AVG

Remark:  
Factor = Antenna Factor + Cable Loss – Pre-amplifier.

EUT :	GSM MOBILE PHONE	Model Name :	E503
Temperature :	20 °C	Relative Humidity :	48%
Pressure :	1010 hPa	Test Voltage :	DC 5V from Adapter AC 120V/60Hz
Test Mode :	TX 2402MHz – CH 00(1Mbps)	Polarization :	Vertical

Frequency (MHz)	Meter Reading (dBµV)	Factor (dB)	Emission Level (dBµV/m)	Limits (dBµV/m)	Margin (dB)	Detector Type
4804	46.37	-3.64	42.73	74	-31.27	peak
4804	39.84	-3.64	36.2	54	-17.8	AVG
7206	51.95	-0.95	51	74	-23	peak
7206	41.49	-0.95	40.54	54	-13.46	AVG

Remark:  
Factor = Antenna Factor + Cable Loss – Pre-amplifier.



EUT :	GSM MOBILE PHONE	Model Name :	E503
Temperature :	20 °C	Relative Humidity :	48%
Pressure :	1010 hPa	Test Voltage :	DC 5V from Adapter AC 120V/60Hz
Test Mode :	TX 2441MHz – CH 39(1Mbps)	Polarization :	Horizontal

Frequency (MHz)	Meter Reading (dBµV)	Factor (dB)	Emission Level (dBµV/m)	Limits (dBµV/m)	Margin (dB)	Detector Type
4882	57.83	-3.68	54.15	74	-19.85	peak
4882	47.83	-3.68	44.15	54	-9.85	AVG
7323	45.26	-0.82	44.44	74	-29.56	peak
7323	38.21	-0.82	37.39	54	-16.61	AVG

Remark:  
Factor = Antenna Factor + Cable Loss – Pre-amplifier.

EUT :	GSM MOBILE PHONE	Model Name :	E503
Temperature :	20 °C	Relative Humidity :	48%
Pressure :	1010 hPa	Test Voltage :	DC 5V from Adapter AC 120V/60Hz
Test Mode :	TX 2441MHz – CH 39(1Mbps)	Polarization :	Vertical

Frequency (MHz)	Meter Reading (dBµV)	Factor (dB)	Emission Level (dBµV/m)	Limits (dBµV/m)	Margin (dB)	Detector Type
4882	52.26	-3.68	48.58	74	-25.42	peak
4882	43.77	-3.68	40.09	54	-13.91	AVG
7323	46.29	-0.82	45.47	74	-28.53	peak
7323	37.94	-0.82	37.12	54	-16.88	AVG

Remark:  
Factor = Antenna Factor + Cable Loss – Pre-amplifier.

EUT :	GSM MOBILE PHONE	Model Name :	E503
Temperature :	20 °C	Relative Humidity :	48%
Pressure :	1010 hPa	Test Voltage :	DC 5V from Adapter AC 120V/60Hz
Test Mode :	TX 2480MHz – CH 78(1Mbps)	Polarization :	Horizontal

Frequency (MHz)	Meter Reading (dBμV)	Factor (dB)	Emission Level (dBμV/m)	Limits (dBμV/m)	Margin (dB)	Detector Type
4960	55.71	-3.59	52.12	74	-21.88	peak
4960	48.93	-3.59	45.34	54	-8.66	AVG
7440	44.72	-0.69	44.03	74	-29.97	peak
7440	39.28	-0.69	38.59	54	-15.41	AVG

Remark:

Factor = Antenna Factor + Cable Loss – Pre-amplifier.

EUT :	GSM MOBILE PHONE	Model Name :	E503
Temperature :	20 °C	Relative Humidity :	48%
Pressure :	1010 hPa	Test Voltage :	DC 5V from Adapter AC 120V/60Hz
Test Mode :	TX 2480MHz – CH 78(1Mbps)	Polarization :	Vertical

Frequency (MHz)	Meter Reading (dBμV)	Factor (dB)	Emission Level (dBμV/m)	Limits (dBμV/m)	Margin (dB)	Detector Type
4960	49.83	-3.59	46.24	74	-27.76	peak
4960	41.18	-3.59	37.59	54	-16.41	AVG
7440	48.89	-0.69	48.2	74	-25.8	peak
7440	41.73	-0.69	41.04	54	-12.96	AVG

Remark:

Factor = Antenna Factor + Cable Loss – Pre-amplifier.

**3.2.9 TEST RESULTS (RESTRICTED BANDS REQUIREMENTS)**

EUT :	GSM MOBILE PHONE	Model Name :	E503
Temperature :	25 °C	Relative Humidity :	60%
Pressure :	1012 hPa	Polarization :	Horizontal
Test Voltage :	DC 5V from Adapter AC 120V/60Hz		
Test Mode :	GFSK		

Frequency (MHz)	Meter Reading (dBµV)	Factor (dB)	Emission Level (dBµV/m)	Limits (dBµV/m)	Margin (dB)	Detector Type	Comment
<b>GFSK- non-hopping</b>							
2390	63.25	-12.99	50.26	74	-23.74	peak	Vertical
2390	65.52	-12.99	52.53	74	-21.47	peak	Horizontal
2483.5	63.83	-12.78	51.05	74	-22.95	peak	Vertical
2483.5	56.86	-12.78	44.08	74	-29.92	peak	Horizontal
<b>GFSK- hopping</b>							
2390	66.38	-12.99	53.39	74	-20.61	peak	Vertical
2390	54.68	-12.99	41.69	74	-32.31	peak	Horizontal
2483.5	62.29	-12.78	49.51	74	-24.49	peak	Vertical
2483.5	57.27	-12.78	44.49	74	-29.51	peak	Horizontal

NOTE: The result(PK) less than AV limite,No need shown AV result.

**4. NUMBER OF HOPPING CHANNEL**

**4.1 APPLIED PROCEDURES / LIMIT**

FCC Part15 (15.247) , Subpart C				
Section	Test Item	Limit	Frequency Range (MHz)	Result
15.247 (a)(1)(iii)	Number of Hopping Channel	≥15	2400-2483.5	PASS

Spectrum Parameters	Setting
Attenuation	Auto
Span Frequency	> Operating Frequency Range
RB	100 kHz
VB	100 kHz
Detector	Peak
Trace	Max Hold
Sweep Time	Auto

**4.1.1 TEST PROCEDURE**

- a. The EUT was directly connected to the spectrum analyzer and antenna output port as show in the block diagram below,
- b. Spectrum Setting : RBW= 100KHz, VBW=100KHz, Sweep time = Auto.

**4.1.2 DEVIATION FROM STANDARD**

No deviation.

**4.1.3 TEST SETUP**

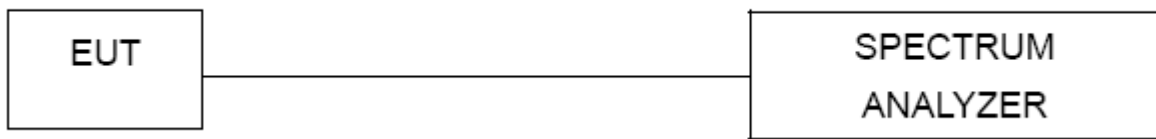

**4.1.4 EUT OPERATION CONDITIONS**

The EUT tested system was configured as the statements of 2.4 Unless otherwise a special operating condition is specified in the follows during the testing.

**4.1.5 TEST RESULTS**

EUT :	GSM MOBILE PHONE	Model Name :	E503
Temperature :	25 °C	Relative Humidity :	60%
Pressure :	1015 hPa	Test Voltage :	DC 5V from Adapter AC 120V/60Hz
Test Mode :	Hopping Mode for GFSK		

Number of Hopping Channel	79
---------------------------	----

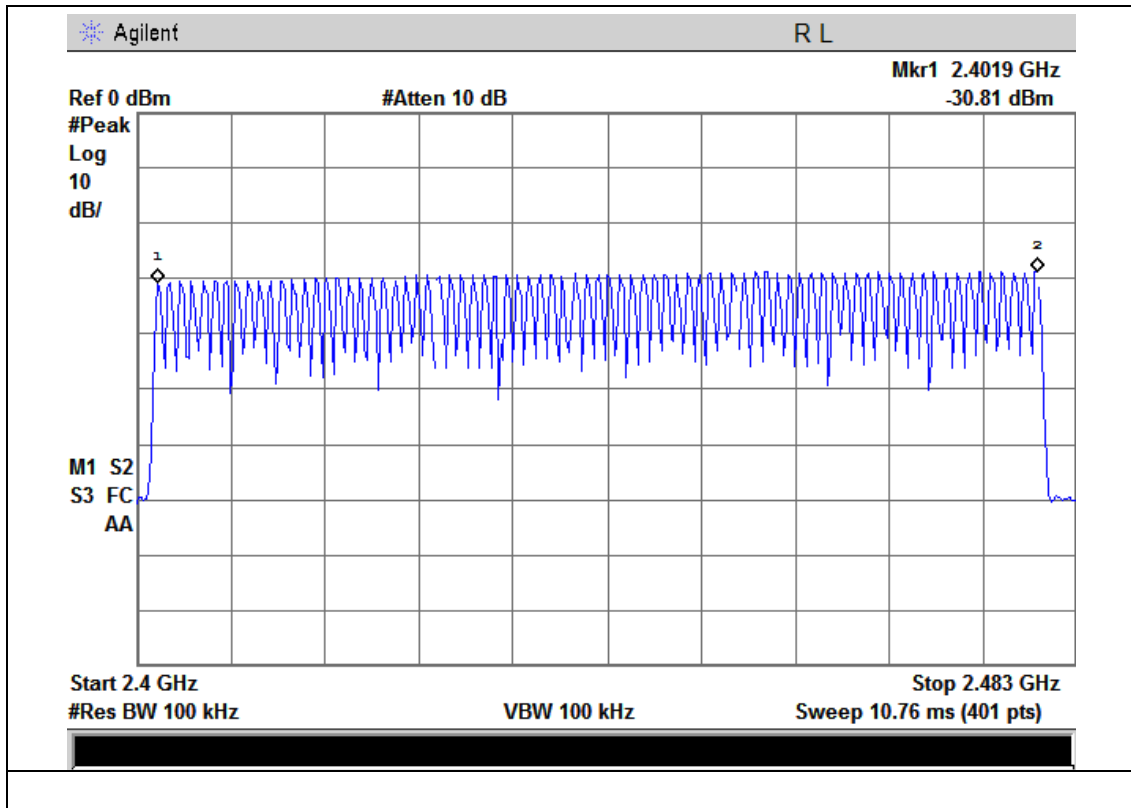

**5. AVERAGE TIME OF OCCUPANCY**

**5.1 APPLIED PROCEDURES / LIMIT**

FCC Part15 (15.247) , Subpart C				
Section	Test Item	Limit	Frequency Range (MHz)	Result
15.247 (a)(1)(iii)	Average Time of Occupancy	0.4sec	2400-2483.5	PASS

**5.1.1 TEST PROCEDURE**

- a. The transmitter output (antenna port) was connected to the spectrum analyzer
- b. Set RBW of spectrum analyzer to 1MHz and VBW to 1MHz.
- c. Use a video trigger with the trigger level set to enable triggering only on full pulses.
- d. Sweep Time is more than once pulse time.
- e. Set the center frequency on any frequency would be measure and set the frequency span to zero span.
- f. Measure the maximum time duration of one single pulse.
- g. Set the EUT for DH5, DH3 and DH1 packet transmitting.
- h. Measure the maximum time duration of one single pulse.
- i. DH5 Packet permit maximum  $1600 / 79 / 6 = 3.37$  hops per second in each channel (5 time slots RX, 1 time slot TX). So, the dwell time is the time duration of the pulse times  $3.37 \times 31.6 = 106.6$  within 31.6 seconds.
- j. DH3 Packet permit maximum  $1600 / 79 / 4 = 5.06$  hops per second in each channel (3 time slots RX, 1 time slot TX). So, the dwell time is the time duration of the pulse times  $5.06 \times 31.6 = 160$  within 31.6 seconds.
- k. DH1 Packet permit maximum  $1600 / 79 / 2 = 10.12$  hops per second in each channel (1 time slot RX, 1 time slot TX). So, the dwell time is the time duration of the pulse times  $10.12 \times 31.6 = 320$  within 31.6 seconds.

**5.1.2 DEVIATION FROM STANDARD**

No deviation.

**5.1.3 TEST SETUP**

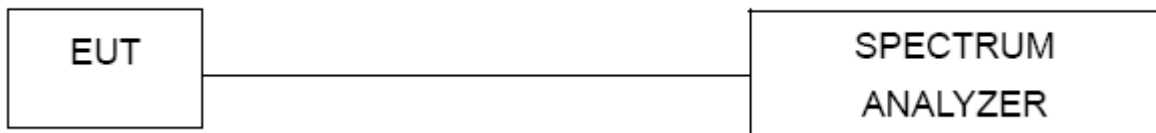

**5.1.4 EUT OPERATION CONDITIONS**

The EUT tested system was configured as the statements of 2.4 Unless otherwise a special operating condition is specified in the follows during the testing.

**5.1.5 TEST RESULTS**

EUT :	GSM MOBILE PHONE	Model Name :	E503
Temperature :	25 °C	Relative Humidity :	60%
Pressure :	1012 hPa	Test Voltage :	DC 5V from Adapter AC 120V/60Hz
Test Mode :	CH39- DH5		

Data Packet	Pulse Duration (ms)	Dwell Time (s)	Limits (s)
DH5	2.95	0.31	0.4000

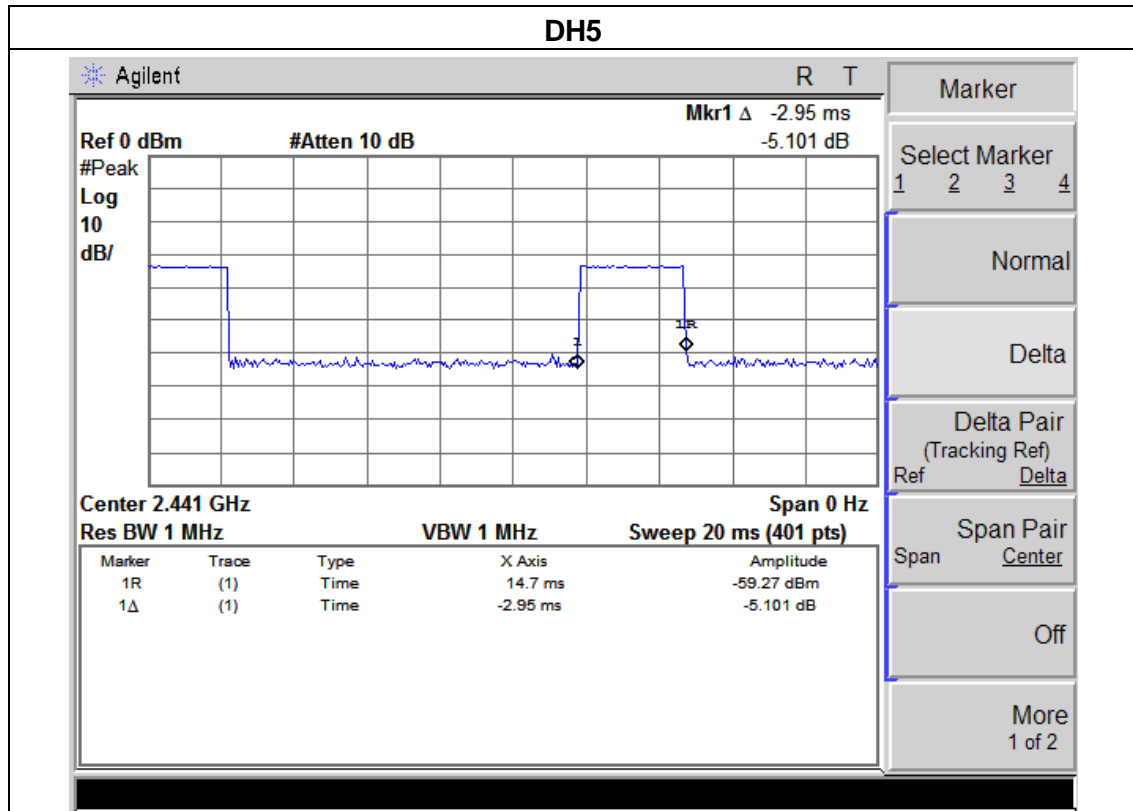

**NOTE:** The dwell time is showed the maximum data of all data (DH1, DH3, DH5), DH5 of mode have the maximum dwell time.

## 6. HOPPING CHANNEL SEPARATION MEASUREMENT

### 6.1 APPLIED PROCEDURES / LIMIT

Frequency hopping systems operating in the 2400-2483.5 MHz band may have hopping channel carrier frequencies that are separated by 25 kHz or two-thirds of the 20 dB bandwidth of the hopping channel, whichever is greater.

Spectrum Parameter	Setting
Attenuation	Auto
Span Frequency	> Measurement Bandwidth or Channel Separation
RB	30 kHz (20dB Bandwidth) / 100 kHz (Channel Separation)
VB	100 kHz (20dB Bandwidth) / 100 kHz (Channel Separation)
Detector	Peak
Trace	Max Hold
Sweep Time	Auto

#### 6.1.1 TEST PROCEDURE

- a. The transmitter output (antenna port) was connected to the spectrum analyser in peak hold mode.
- b. The resolution bandwidth of 30 kHz and the video bandwidth of 100 kHz were utilised for 20 dB bandwidth measurement.
- c. The resolution bandwidth of 100 kHz and the video bandwidth of 100 kHz were utilised for channel separation measurement.

#### 6.1.2 DEVIATION FROM STANDARD

No deviation.

#### 6.1.3 TEST SETUP

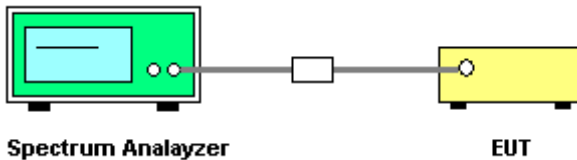

#### 6.1.4 EUT OPERATION CONDITIONS

The EUT was programmed to be in continuously transmitting mode.



**6.1.5 TEST RESULTS**

EUT :	GSM MOBILE PHONE	Model Name :	E503
Temperature :	25 °C	Relative Humidity :	60%
Pressure :	1012 hPa	Test Voltage :	DC 5V from Adapter AC 120V/60Hz
Test Mode :	CH00 / CH39 /CH78 (1Mbps Mode)		

Frequency	Ch. Separation (MHz)	Result
2402 MHz	1.004	<b>Complies</b>
2441 MHz	1.012	<b>Complies</b>
2480 MHz	1.006	<b>Complies</b>

For GFSK:

**Ch. Separation Limits: > 20dB bandwidth**

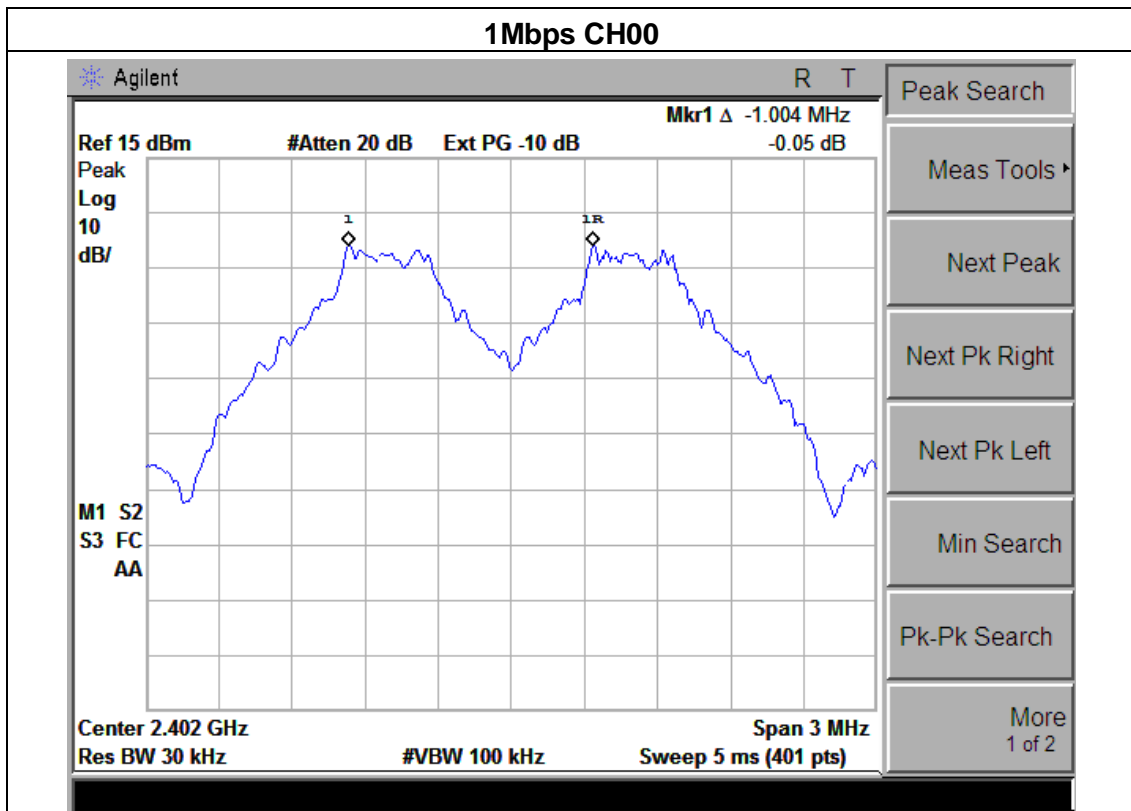

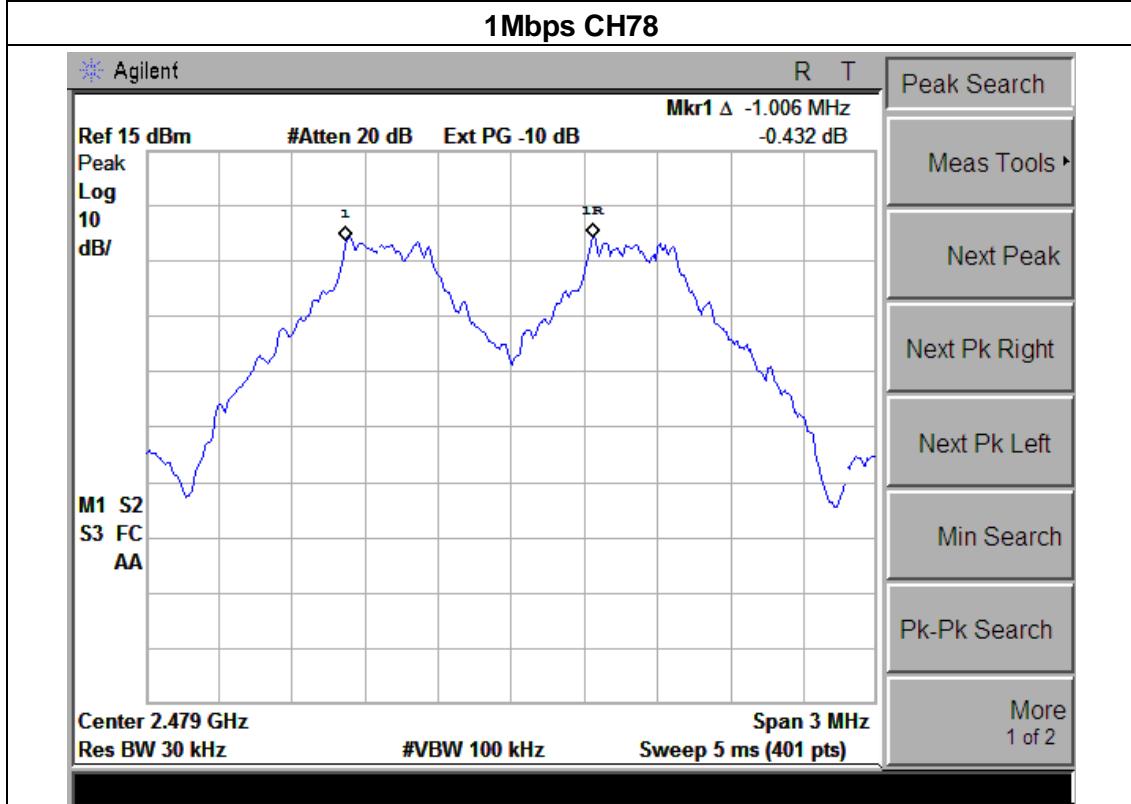
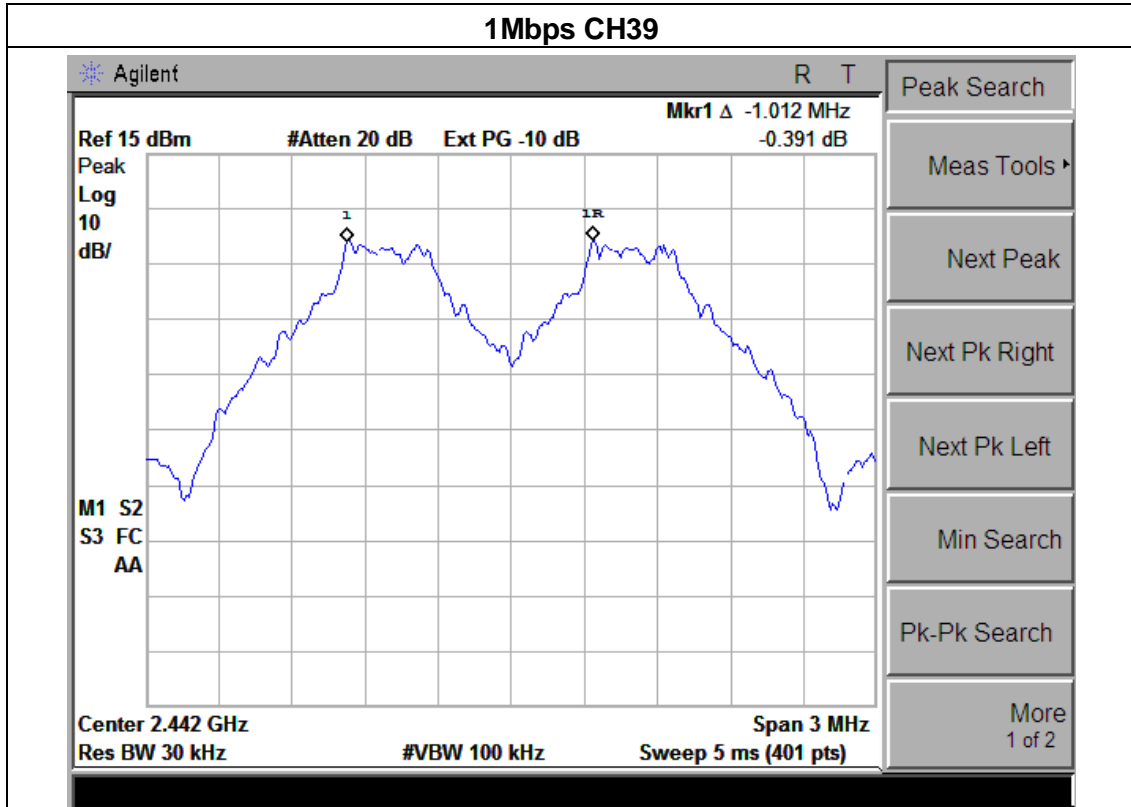

**7. BANDWIDTH TEST**

**7.1 APPLIED PROCEDURES / LIMIT**

FCC Part15 (15.247) , Subpart C				
Section	Test Item	Limit	Frequency Range (MHz)	Result
15.247 (a)(1)	Bandwidth	(20dB bandwidth)	2400-2483.5	PASS

Spectrum Parameter	Setting
Attenuation	Auto
Span Frequency	> Measurement Bandwidth or Channel Separation
RB	30 kHz (20dB Bandwidth) / 30 kHz (Channel Separation)
VB	100 kHz (20dB Bandwidth) / 30 kHz (Channel Separation)
Detector	Peak
Trace	Max Hold
Sweep Time	Auto

**7.1.1 TEST PROCEDURE**

- a. The EUT was directly connected to the spectrum analyzer and antenna output port as show in the block diagram below,
- b. Spectrum Setting : RBW= 30KHz, VBW=100KHz, Sweep time = Auto.

**7.1.2 DEVIATION FROM STANDARD**

No deviation.

**7.1.3 TEST SETUP**



**7.1.4 EUT OPERATION CONDITIONS**

The EUT tested system was configured as the statements of 2.4 Unless otherwise a special operating condition is specified in the follows during the testing.

**7.1.5 TEST RESULTS**

EUT :	GSM MOBILE PHONE	Model Name :	E503
Temperature :	25 °C	Relative Humidity :	60%
Pressure :	1012 hPa	Test Voltage :	DC 5V from Adapter AC 120V/60Hz
Test Mode :	CH00 / CH39 /C78 for GFSK		

Frequency	20dB Bandwidth (kHz)	Result
2402 MHz	913.643	<b>PASS</b>
2441 MHz	866.005	<b>PASS</b>
2480 MHz	865.995	<b>PASS</b>

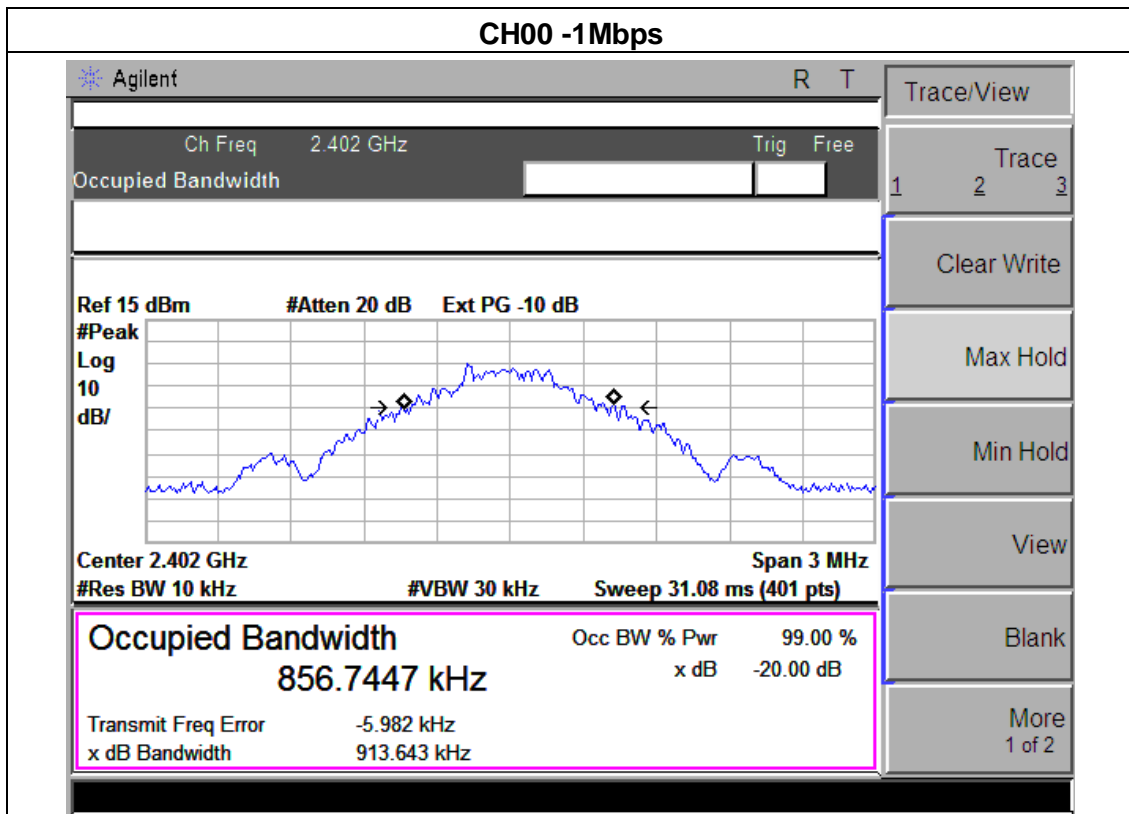

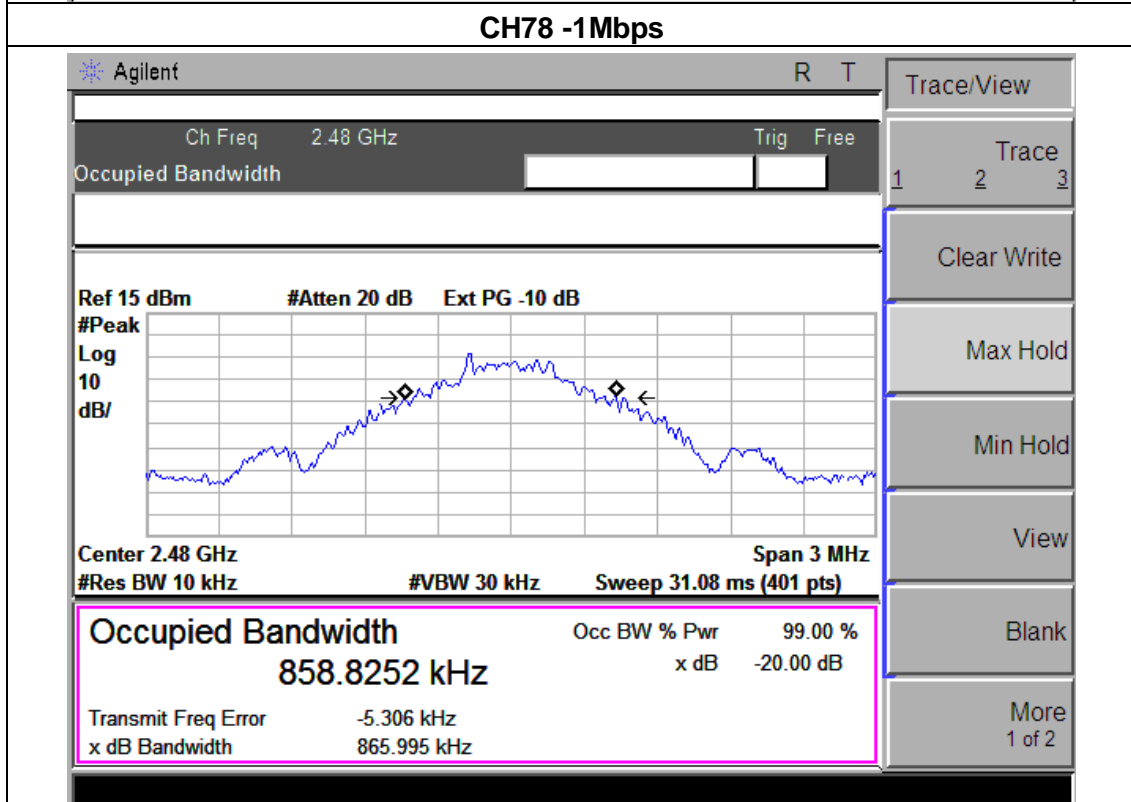
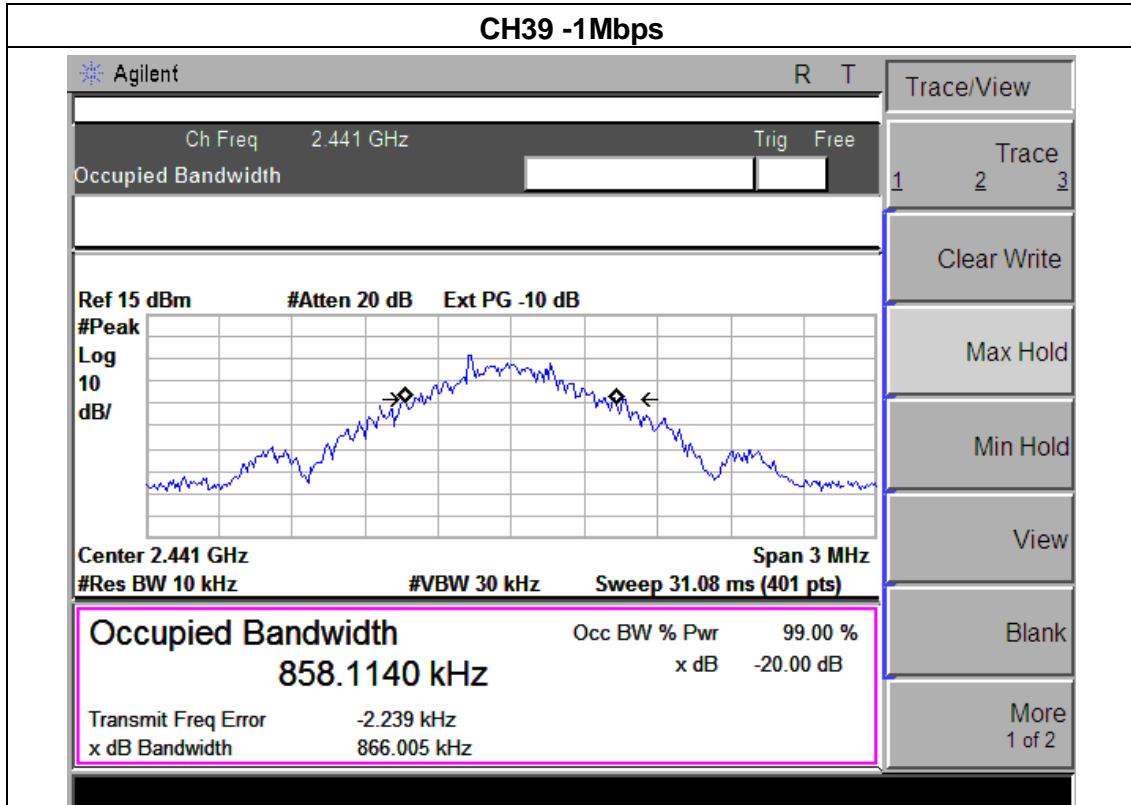

**8. PEAK OUTPUT POWER TEST**

**8.1 APPLIED PROCEDURES / LIMIT**

FCC Part15 (15.247) , Subpart C				
Section	Test Item	Limit	Frequency Range (MHz)	Result
15.247 (b)(i)	Peak Output Power	1W or 30dBm for	2400-2483.5	PASS

**8.1.1 TEST PROCEDURE**

- a. The EUT was directly connected to the Power meter

**8.1.2 DEVIATION FROM STANDARD**

No deviation.

**8.1.3 TEST SETUP**



**8.1.4 EUT OPERATION CONDITIONS**

The EUT tested system was configured as the statements of 2.4 Unless otherwise a special operating condition is specified in the follows during the testing.

**8.1.5 TEST RESULTS**

EUT :	GSM MOBILE PHONE	Model Name :	E503
Temperature :	25 °C	Relative Humidity :	60%
Pressure :	1012 hPa	Test Voltage :	DC 5V from Adapter AC 120V/60Hz
Test Mode :	CH00/ CH39 /CH78 (1Mbps Mode) for GFSK		

Test Channel	Frequency (MHz)	Peak Output Power (dBm)	LIMIT (dBm)	Result
CH00	2402	1.74	30	PASS
CH39	2441	1.29	30	PASS
CH78	2480	2.04	30	PASS

## **9. ANTENNA REQUIREMENT**

### **9.1 STANDARD REQUIREMENT**

15.203 requirement: For intentional device, according to 15.203: an intentional radiator shall be designed to ensure that no antenna other than that furnished by the responsible party shall be used with the device.

### **9.2 EUT ANTENNA**

The EUT antenna is integral Antenna. It comply with the standard requirement.



10. EUT TEST PHOTO

Radiated Measurement Photos

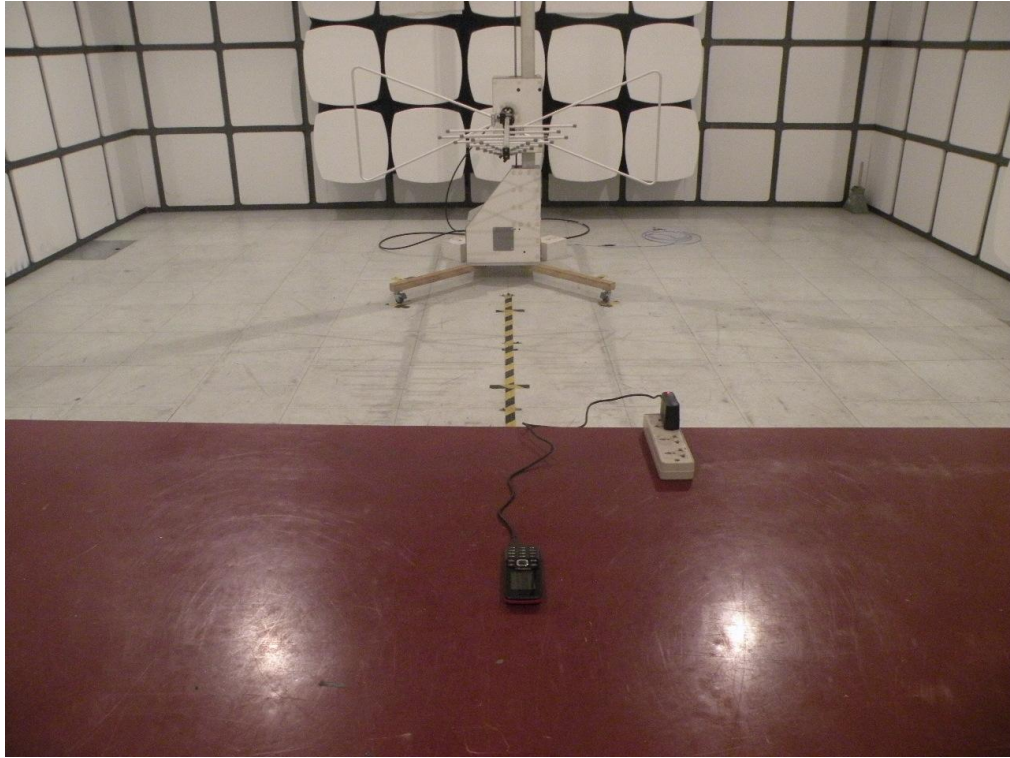

**Conducted Measurement Photos**

