



FCC RADIO TEST REPORT

Applicant : ADESSO INC.

Address : 20659 Valley BLVD. Walnut, CA 91789

Manufacturer : ADESSO ELECTRONICS INC.

Address : No.5,ChengDa East St.,Xiagang
Community,Changan,DongGuan,China

Equipment : Wireless Thermal Printer

Model No. : NuPrint 320B, NuPrint 200B, NuPrint 210B, NuPrint 220B,
NuPrint 230B, NuPrint 240B, NuPrint 250B, NuPrint 260B,
NuPrint 270B, NuPrint 280B, NuPrint 290B, NuPrint 300B,
NuPrint 310B, NuPrint 330B, NuPrint 340B, NuPrint 350B,
NuPrint 360B, NuPrint 370B, NuPrint 380B, NuPrint 390B,
NuPrint 400B, NuPrint 410B, NuPrint 420B, NuPrint 430B,
NuPrint 440B, NuPrint 450B, NuPrint 460B, NuPrint 470B,
NuPrint 480B, NuPrint 490B

Trade Mark : Adesso/Gyration

FCC ID : 2ACFQ-320B

Standard : FCC part 15 Subpart C §15.247

I HEREBY CERTIFY THAT :

The sample was received on May. 17, 2023 and the testing was completed on Aug. 02, 2023 at CerpPASS Technology Corp. The test result refers exclusively to the test presented test model / sample. Without written approval of CerpPASS Technology Corp., the test report shall not be reproduced except in full.

Approved by:



Leevin Li /Supervisor



Contents

1. Report of Measurements and Examinations	5
1.1 List of Measurements and Examinations	5
2. Test Configuration of Equipment under Test	6
2.1 Feature of Equipment under Test	6
2.2 Carrier Frequency of Channels	7
2.3 Test Mode & Test Software	8
2.5 Description of Test System	10
2.6 General Information of Test	11
2.7 Measurement Uncertainty	11
3. Test Equipment and Ancillaries Used for Tests	12
4. Antenna Requirements	13
4.1 Standard Applicable	13
4.2 Antenna Construction and Directional Gain	13
5. Test of Conducted Emission	14
5.1 Test Limit	14
5.2 Test Procedures	14
5.3 Typical Test Setup	15
5.4 Test Result and Data	16
6. Test of Radiated Emission	18
6.1 Test Limit	18
6.2 Test Procedures	19
6.3 Typical Test Setup	20
6.4 Test Result and Data (9kHz ~ 30MHz)	21
6.5 Test Result and Data (30MHz ~ 1GHz)	21
6.6 Test Result and Data (1GHz ~ 25GHz)	23
6.7 Restricted Bands of Operation	41
7. Test of Conducted Spurious Emission	54
7.1 Test Limit	54
7.2 Test Procedure	54
7.3 Test Setup Layout	54
7.4 Test Result and Data	54
8. 20dB Bandwidth Measurement Data	60
8.1 Test Limit	60
8.2 Test Procedures	60
8.3 Test Setup Layout	60
8.4 Test Result and Data	60
9. Frequencies Separation	63
9.1 Test Limit	63
9.2 Test Procedures	63
9.3 Test Setup Layout	63
9.4 Test Result and Data	63
10. Dwell Time on each channel	66



10.1	Test Limit	66
10.2	Test Procedures	66
10.3	Test Setup Layout	66
10.4	Test Result and Data	66
11.	Number of Hopping Channels	70
11.1	Test Limit	70
11.2	Test Procedures	70
11.3	Test Setup Layout	70
11.4	Test Result and Data	70
12.	Maximum Peak Output Power	72
12.1	Test Limit	72
12.2	Test Procedures	72
12.3	Test Setup Layout	72
12.4	Test Result and Data	72



History of this test report

Original.

Additional attachment as following record:

Attachment No.	Issue Date	Description
DEFB2304035	Aug. 16, 2023	Initial Issue



1. Report of Measurements and Examinations

1.1 List of Measurements and Examinations

ANSI C63.10: 2013

KDB 558074 D01 DTS Meas Guidance v05r02

FCC Rules and Regulations Part 15 Subpart C §15.247

FCC Rule	Description of Test	Result
§ 15.203	. Antenna Requirement	Pass
§ 15.207(a)	. Conducted Emission	Pass
§ 15.209(a)	. Radiated Emission	Pass
§ 15.247(a)(1)	. Channel Carrier Frequencies Separation	Pass
§ 15.247(a)(1)	. 20dB Bandwidth Measurement	Pass
§ 15.247(a)(1)	. Dwell Time	Pass
§ 15.247(b)	. Number of Hopping Channels	Pass
§ 15.247(b)	. Peak Output Power Measurement Data	Pass
§ 15.247(d)	. Band Edges Measurement Data	Pass

Note: Deviations Yes No ■

*The lab has reduced the uncertainty risk factor from test equipment, environment and staff technicians which according to the standard on contract. Therefore, the test result will only be determined by standard requirement.



2. Test Configuration of Equipment under Test

2.1 Feature of Equipment under Test

Equipment	Wireless Thermal Printer
Model Name	NuPrint 320B, NuPrint 200B, NuPrint 210B, NuPrint 220B, NuPrint 230B, NuPrint 240B, NuPrint 250B, NuPrint 260B, NuPrint 270B, NuPrint 280B, NuPrint 290B, NuPrint 300B, NuPrint 310B, NuPrint 330B, NuPrint 340B, NuPrint 350B, NuPrint 360B, NuPrint 370B, NuPrint 380B, NuPrint 390B, NuPrint 400B, NuPrint 410B, NuPrint 420B, NuPrint 430B, NuPrint 440B, NuPrint 450B, NuPrint 460B, NuPrint 470B, NuPrint 480B, NuPrint 490B
Model Discrepancy	All the models are electrical identical including PCB Layout, etc. The only difference is color and tooling. Model NuPrint 320B was chosen for final test.
Operation Frequency Range	BT/ BLE: 2400-2483.5MHz
Center Frequency Range	BT/ BLE: 2402-2480MHz
Modulation Type	BT: GFSK, $\pi/4$ -DQPSK, 8DPSK BLE: GFSK
Data Rate	BT: GFSK:1Mbps, $\pi/4$ -DQPSK: 2Mbps, 8DPSK:3Mbps BLE: GFSK: 1Mbps, 2Mbps
Antenna Type	PCB Antenna
Antenna Gain	2.07dBi
Working Temperature	0°C to +50°C
EUT Power Rating	Adapter: MODEL: KA1201A-0901000US INPUT: 100-240V~50/60Hz 0.4A Max OUTPUT: 9V=1000mA Battery: Battery Capacity: 2600mAh / 7.4V 19.24Wh Limited Charge Voltage: 8.4V

Note: For a more detailed features description, please refer to the manufacturer's specifications or the User's Manual.



2.2 Carrier Frequency of Channels

Channel	Frequency (MHz)	Channel	Frequency (MHz)	Channel	Frequency (MHz)	Channel	Frequency (MHz)
00	2402	20	2422	40	2442	60	2462
01	2403	21	2423	41	2443	61	2463
02	2404	22	2424	42	2444	62	2464
03	2405	23	2425	43	2445	63	2465
04	2406	24	2426	44	2446	64	2466
05	2407	25	2427	45	2447	65	2467
06	2408	26	2428	46	2448	66	2468
07	2409	27	2429	47	2449	67	2469
08	2410	28	2430	48	2450	68	2470
09	2411	29	2431	49	2451	69	2471
10	2412	30	2432	50	2452	70	2472
11	2413	31	2433	51	2453	71	2473
12	2414	32	2434	52	2454	72	2474
13	2415	33	2435	53	2455	73	2475
14	2416	34	2436	54	2456	74	2476
15	2417	35	2437	55	2457	75	2477
16	2418	36	2438	56	2458	76	2478
17	2419	37	2439	57	2459	77	2479
18	2420	38	2440	58	2460	78	2480
19	2421	39	2441	59	2461	---	---



2.3 Test Mode & Test Software

- a. During testing, the interface cables and equipment positions were varied according to ANSI C63.10
- b. The complete test system included support units and EUT for RF test.
- c. Run the test software “FCC_assist.exe (Ver.: 1.0.4)” under Win 10 System was executed to transmit and receive data via Bluetooth.
- d. The following test modes were performed for the test:

Conducted Emissions from the AC mains power ports	
Test Mode	Operating Description
1	GFSK (1Mbps) for AC120V
2	$\pi/4$ -DQPSK (2Mbps) for AC120V
3	8DPSK (3Mbps) for AC120V
4	8DPSK (3Mbps) for AC240V
caused “Test Mode 3 at CH00:2402” generated the worst case, it was reported as the final data.	
Radiation Emissions (Below 1GHz)	
Test Mode	Operating Description
1	GFSK (1Mbps)
2	$\pi/4$ -DQPSK (2Mbps)
3	8DPSK (3Mbps)
caused “Test Mode 3 at CH00:2402” generated the worst case, they were reported as the final data.	
Radiation Emissions (1GHz ~ 25GHz)	
Test Mode	Operating Description
1	GFSK (1Mbps)
2	$\pi/4$ -DQPSK (2Mbps)
3	8DPSK (3Mbps)
caused “Test Mode 1, 2, 3” generated the worst case, they were reported as the final data.	



2.4 Power Parameter Value of the test software

Mode	Frequency (MHz)	Power Setting
GFSK (1Mbps)	2402	Default
	2441	Default
	2480	Default
$\pi/4$ -DQPSK (2Mbps)	2402	Default
	2441	Default
	2480	Default
8DPSK (3Mbps)	2402	Default
	2441	Default
	2480	Default



2.5 Description of Test System

Product	Manufacturer	Model No.	Serial No.	Power Cord
1 Notebook	SONY	PCG-71811P	27544574 7000251	Non-Shielded, 1.8m
2 Adapter	Keyu	KA1201A-0901000US	N/A	Non-Shielded, 1.1m

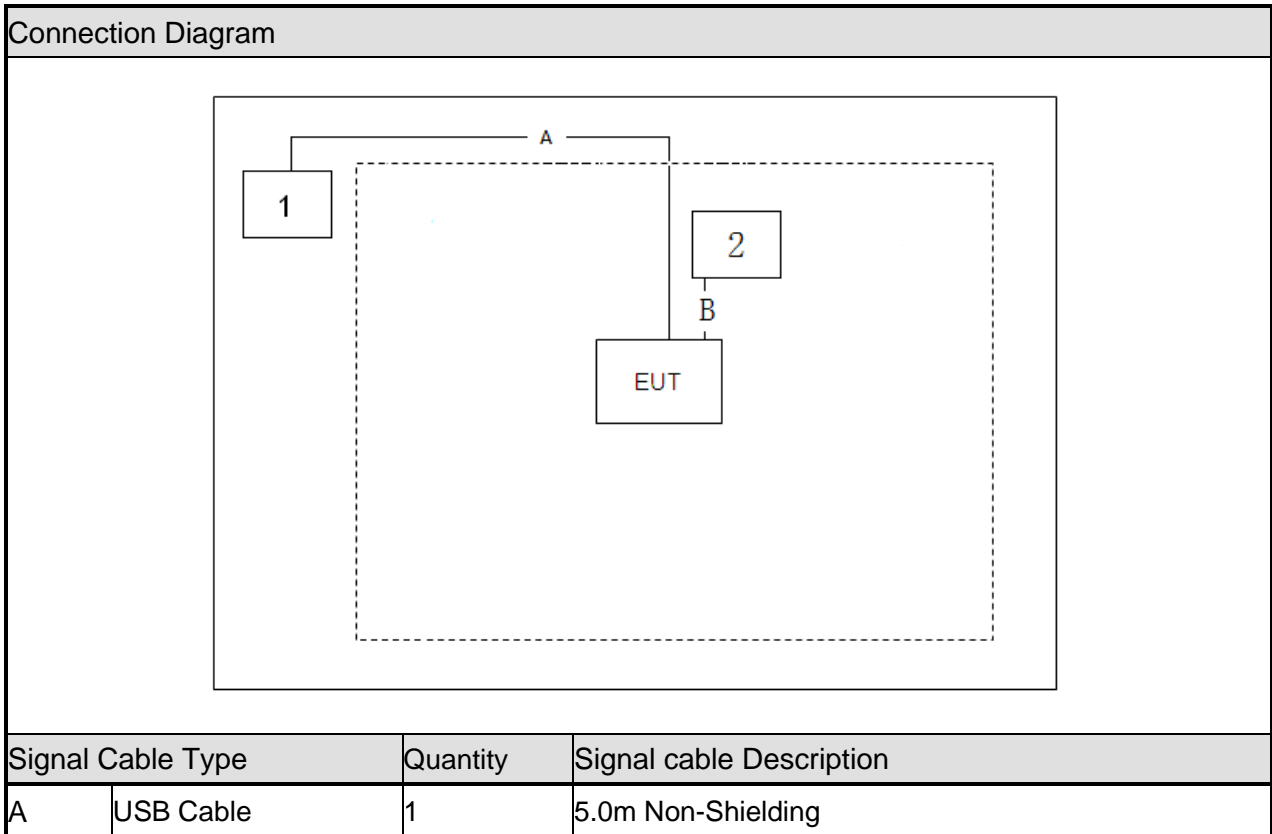



2.6 General Information of Test

Test Site	CerpPASS Technology Corporation(CerpPASS Laboratory) Address: Room 102, No. 5, Xing'an Road, Chang'an Town, Dongguan City, Guangdong Province Tel: +86-769-8547-1212 Fax: +86-769-8547-1912
FCC Designation No.:	CN1288
Frequency Range Investigated:	Conducted: from 150kHz to 30 MHz Radiation: from 30 MHz to 25,000MHz
Test Distance:	The test distance of radiated emission from antenna to EUT is 3 M.

Test Item	Test Site	Test period	Environmental Conditions	Tested By
RF Conducted	RFCON01-DG	2023/05/30	23°C / 54%	Amos Zhang
Radiated Emissions	3M01-DG	2023/06/01~2023/08/02	24~25°C / 46~51%	Amos Zhang
AC Power Line Conducted Emission	CON01-DG	2023/08/02	26°C / 46%	Amos Zhang

2.7 Measurement Uncertainty

ISO/IEC 17025 requires that an estimate of the measurement uncertainties associated with the emissions test results be included in the report. The measurement uncertainties given below are based on a 95% confidence level (based on a coverage factor (k=2)).

Measurement Item	Uncertainty
AC Power Line Conduction(150K~30MHz)	±2.60dB
Radiated Spurious Emission(9KHz~30MHz)	±4.10dB
Radiated Spurious Emission(30MHz~1GHz)	±4.39dB
Radiated Spurious Emission(1GHz~18GHz)	±5.36dB
Radiated Spurious Emission(18GHz~40GHz)	±5.43dB
6dB Bandwidth&20dB Bandwidth	±4.8%
Occupied Bandwidth	±4.5%
Peak Output Power(Conducted Power Meter)	±0.94dB
Power Spectral Density	±1.01dB
Dwell Time / Deactivation Time	±3.5%

**3. Test Equipment and Ancillaries Used for Tests**

AC Power Line Conducted Emission					
Test Site	CON01-DG				
Instrument/Ancillary	Manufacturer	Model No.	Serial No.	Calibration Date	Valid Date.
Test Receiver	R&S	ESCI	100564	2023.01.06	2024.01.05
LISN	SCHWARZBECK	NSLK 8127	8127748	2023.01.06	2024.01.05
LISN	R&S	ENV216	100024	2023.01.06	2024.01.05
ISN	TESEQ	ISN T800	42809	2023.05.06	2024.05.05
Pulse Limiter with 10dB Attenuation	SCHWARZBECK	VTSD 9561-F	9561-F106	2023.01.06	2024.01.05
Temperature/ Humidity Meter	GEMLEAD	STH200A	N/A	2022.08.05	2023.08.04

Radiated Emissions					
Test Site	3M01-DG				
Instrument	Manufacturer	Model No.	Serial No.	Calibration Date	Valid Date
EMI Test Receiver	R&S	ESCI	100565	2023.05.06	2024.05.05
Amplifier	EMCI	EMC330	980082	2023.05.06	2024.05.05
Loop Antenna	R&S	HFH2-Z2	100150	2022.05.11	2024.05.10
Bilog Antenna	Sunol Science	JB6	A111218	2023.01.12	2025.01.11
Preamplifier	Agilent	8449B	3008A02342	2023.01.06	2024.01.05
Preamplifier	COM-POWER	PA-840	711885	2023.05.06	2024.05.05
Broad-Band Horn Antenna	Schwarzbeck	BBHA9120 D	9120D-619	2022.05.22	2024.05.21
Standard Gain Horn Antenna	TRC	HA-2640	18050	2022.05.09	2024.05.08
Standard Gain Horn Antenna	TRC	HA-1726	18051	2022.05.09	2024.05.08
FSQ Signal Analyzer	R&S	FSQ40	200012	2023.05.06	2024.05.05
Temperature/ Humidity Meter	GEMLEAD	STH200A	N/A	2022.08.05	2023.08.04

RF Conducted					
Test Site	RFCON01-DG				
Instrument	Manufacturer	Model No.	Serial No.	Calibration Date	Valid Date
MXA Signal Analyzer	KEYSIGHT	N9020A	US46220290	2023.05.06	2024.05.05
EXA Signal Analyzer	KEYSIGHT	N9010A	MY53400169	2023.05.06	2024.05.05
ESG VECTOR SIGNAL GENERATOR	Agilent	E4438C	MY45092582	2023.05.06	2024.05.05
MXG VECTOR SIGNAL GENERATOR	Agilent	N5182B	MY53050127	2023.05.06	2024.05.05
USB Wideband Power Sensor	Boonton	55006	9778	2023.01.06	2024.01.05
Temperature/ Humidity Meter	mingle	ETH529	N/A	2023.01.06	2024.01.05



4. Antenna Requirements

4.1 Standard Applicable

For intentional device, according to FCC 47 CFR Section 15.203, an intentional radiator shall be designed to ensure that no antenna other than that furnished by the responsible party shall be used with the device.

And according to FCC 47 CFR Section 15.247 (b), if transmitting antennas of directional gain greater than 6dBi are used, the power shall be reduced by the amount in dB that the directional gain of the antenna exceeds 6dBi.

4.2 Antenna Construction and Directional Gain

BT/BLE

Antenna Type	PCB Antenna
Antenna Gain	2.07dBi



5. Test of Conducted Emission

5.1 Test Limit

Conducted Emissions were measured from 150 kHz to 30 MHz with a bandwidth of 9 KHz on the 120 VAC power and return leads of the EUT according to the methods defined in ANSI C63.10-2013. The EUT was placed on a nonmetallic stand in a shielded room 0.8 meters above the ground plane as shown in section 6.2.2. The interface cables and equipment positioning were varied within limits of reasonable applications to determine the position produced maximum conducted emissions

Frequency (MHz)	Quasi Peak (dB μ V)	Average (dB μ V)
0.15 – 0.5	66-56*	56-46*
0.5 – 5.0	56	46
5.0 – 30.0	60	50

*Decreases with the logarithm of the frequency.

5.2 Test Procedures

- The EUT was placed 0.4 meter from the conducting wall of the shielding room was kept at least 80 centimeters from any other grounded conducting surface.
- Connect EUT to the power mains through a line impedance stabilization network (LISN).
- All the support units are connecting to the other LISN.
- The LISN provides 50 ohm coupling impedance for the measuring instrument.
- The FCC states that a 50 ohm, 50 micro-Henry LISN should be used.
- Both sides of AC line were checked for maximum conducted interference.
- The frequency range from 150 kHz to 30 MHz was searched.
- Set the test-receiver system to Peak Detect Function and Specified Bandwidth with Maximum Hold Mode.



5.3 Typical Test Setup

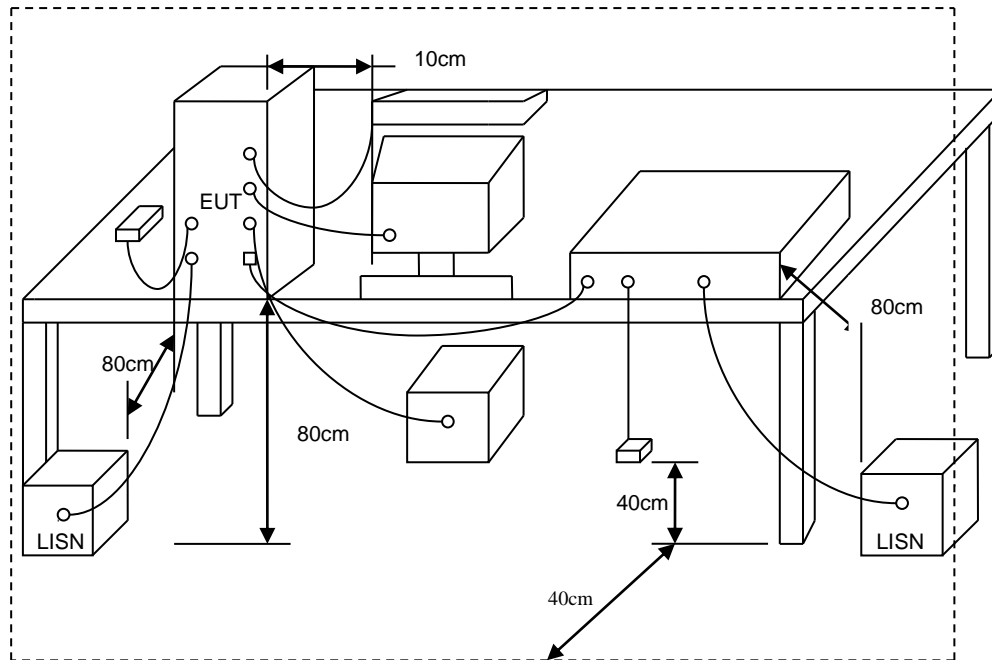



5.4 Test Result and Data

Power	AC 120V/60Hz	Pol/Phase	LINE
Test Mode	Mode 3		

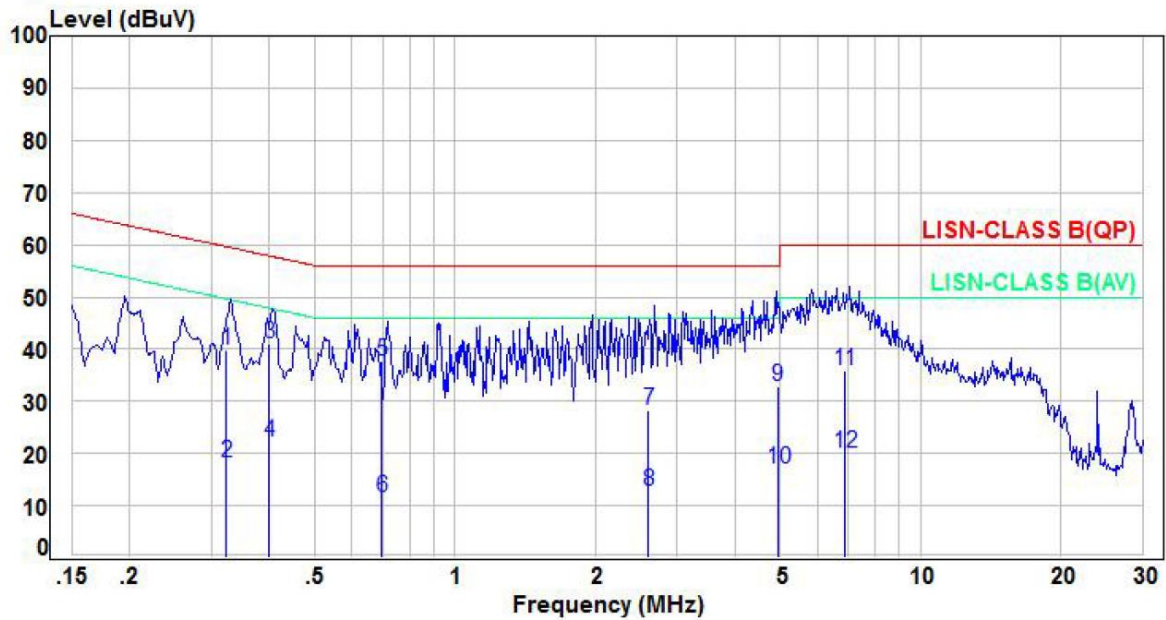

No.	Frequency (MHz)	Factor (dB)	Reading (dBuV)	Level (dBuV)	Limit (dBuV)	Margin (dB)	Detector	P/F
1	0.32	9.71	29.98	39.69	59.64	-19.95	QP	P
2	0.32	9.71	8.52	18.23	49.64	-31.41	Average	P
3	0.40	9.65	31.28	40.93	57.87	-16.94	QP	P
4	0.40	9.65	12.59	22.24	47.87	-25.63	Average	P
5	0.70	9.71	27.97	37.68	56.00	-18.32	QP	P
6	0.70	9.71	1.74	11.45	46.00	-34.55	Average	P
7	2.61	9.82	18.55	28.37	56.00	-27.63	QP	P
8	2.61	9.82	2.93	12.75	46.00	-33.25	Average	P
9	4.93	9.89	22.91	32.80	56.00	-23.20	QP	P
10	4.93	9.89	7.29	17.18	46.00	-28.82	Average	P
11	6.88	10.06	25.76	35.82	60.00	-24.18	QP	P
12	6.88	10.06	9.95	20.01	50.00	-29.99	Average	P

Site: CON01-DG

Note: Level=Reading+Factor

Margin=Level-Limit

Factor=(LISN or ISN or Current/Voltage Probe or Combining Network) Factor +Cabel loss



Power	AC 120V/60Hz	Pol/Phase	NEUTRAL
Test Mode	Mode 3		

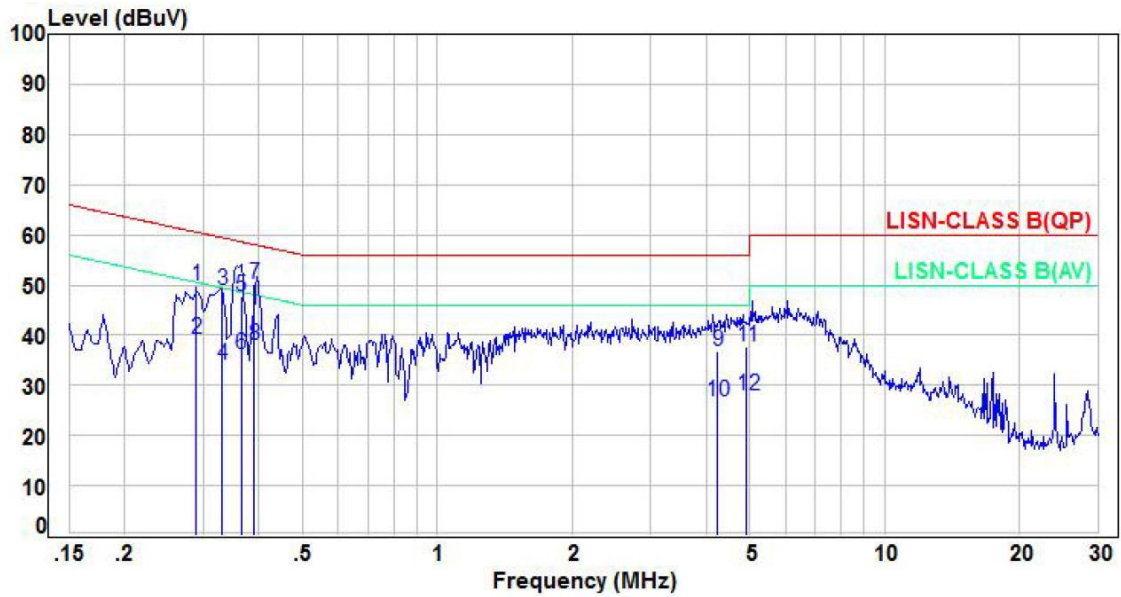

No.	Frequency (MHz)	Factor (dB)	Reading (dBuV)	Level (dBuV)	Limit (dBuV)	Margin (dB)	Detector	P/F
1	0.29	9.83	40.00	49.83	60.55	-10.72	QP	P
2	0.29	9.83	29.26	39.09	50.55	-11.46	Average	P
3	0.33	9.79	39.13	48.92	59.44	-10.52	QP	P
4	0.33	9.79	24.30	34.09	49.44	-15.35	Average	P
5	0.37	9.76	38.01	47.77	58.61	-10.84	QP	P
6	0.37	9.76	26.47	36.23	48.61	-12.38	Average	P
7	0.39	9.74	40.56	50.30	58.05	-7.75	QP	P
8	0.39	9.74	28.13	37.87	48.05	-10.18	Average	P
9	4.25	9.89	26.95	36.84	56.00	-19.16	QP	P
10	4.25	9.89	16.91	26.80	46.00	-19.20	Average	P
11	4.93	9.90	27.84	37.74	56.00	-18.26	QP	P
12	4.93	9.90	18.11	28.01	46.00	-17.99	Average	P

Site: CON01-DG

Note: Level=Reading+Factor

Margin=Level-Limit

Factor=(LISN or ISN or Current/Voltage Probe or Combining Network) Factor +Cabel loss



6. Test of Radiated Emission

6.1 Test Limit

In any 100kHz bandwidth outside the frequency band in which the spread spectrum or digitally modulated intentional radiator is operating, the radio frequency power that is produced by the intentional radiator shall be at least 20dB below that in the 100kHz bandwidth within the band that contains the highest level of the desired power, based on either an RF conducted or a radiated measurement. If the transmitter measurement is based on the maximum conducted output power, the attenuation required under this paragraph shall be 30dB instead of 20dB. In addition, radiated emissions which fall in section 15.205(a) the restricted bands must also comply with the radiated emission limit specified in section 15.209(a).

FREQUENCIES(MHz)	FIELD STRENGTH(microvolts/meter)	MEASUREMENT DISTANCE(meters)
0.009~0.490	2400/F(kHz)	300
0.490~1.705	24000/F(kHz)	30
1.705~30.0	30	30
30~88	100	3
88~216	150	3
216~960	200	3
Above 960	500	3



6.2 Test Procedures

- a. The EUT was placed on a rotatable table top 0.8 meter above ground; above 1GHz, the height was 1.5m.
- b. The EUT was set 3 meters from the interference receiving antenna which was mounted on the top of a variable height antenna tower.
- c. The table was rotated 360 degrees to determine the position of the highest radiation.
- d. The antenna is a broadband antenna and its height is varied between one meter and four meters above ground to find the maximum value of the field strength both horizontal polarization and vertical polarization of the antenna are set to make the measurement.
- e. For each suspected emission the EUT was arranged to its worst case and then tune the antenna tower (from 1 M to 4 M) and turn table (from 0 degree to 360 degrees) to find the maximum reading.
- f. Set the test-receiver system to Peak or CISPR quasi-peak Detect Function and specified bandwidth with Maximum Hold Mode.
- g. If the emission level of the EUT in peak mode was 3 dB lower than the limit specified, then testing will be stopped and peak values of EUT will be reported, otherwise, the emissions which do not have 3 dB margin will be repeated one by one using the quasi-peak method and reported.
- h. For testing above 1GHz, the emission level of the EUT in peak mode was 20dB lower than average limit (that means the emission level in peak mode also complies with the limit in average mode), then testing will be stopped and peak values of EUT will be reported, otherwise, the emissions will be measured in average mode again and reported.
- i. "Cone of radiation" has been considered to be 3dB bandwidth of the measurement antenna.

Note: The supporting fixture shall permit orientation of the EUT in each of three orthogonal axis positions such that emissions from the EUT are maximized.

(X AXIS is the worst.)



6.3 Typical Test Setup

Below 30MHz test setup

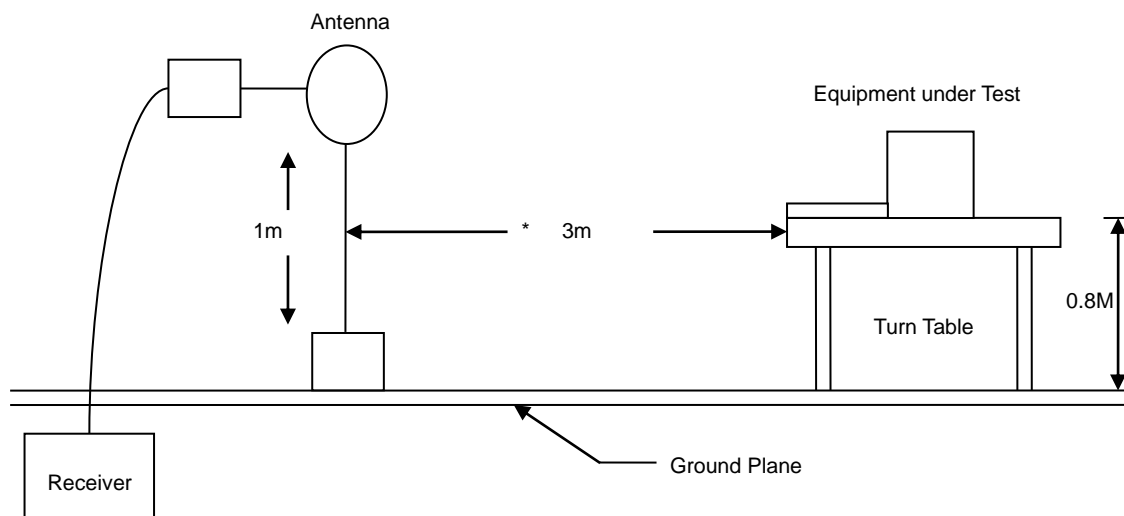

30MHz- 1GHz Test Setup

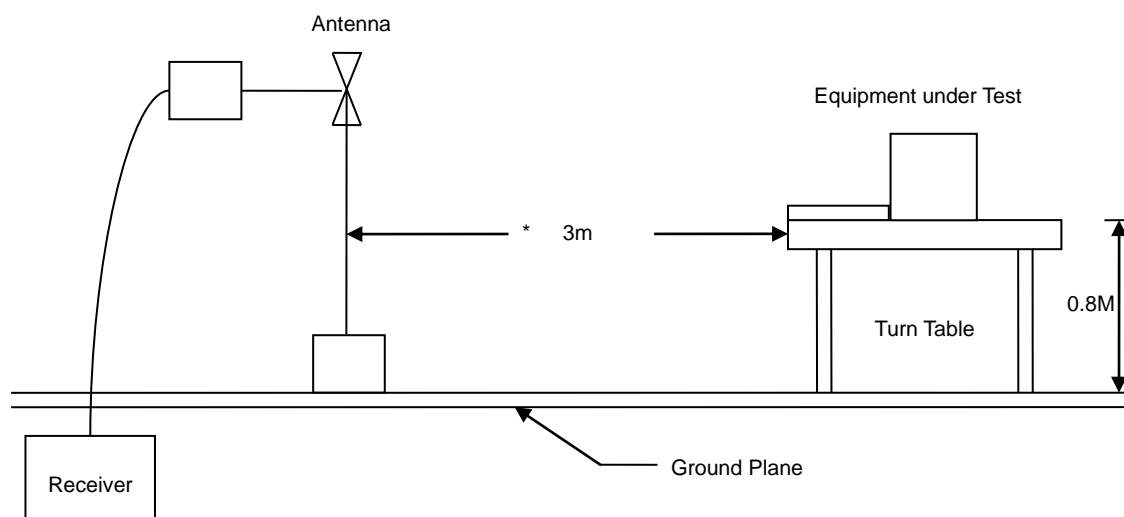

Above 1GHz Test Setup

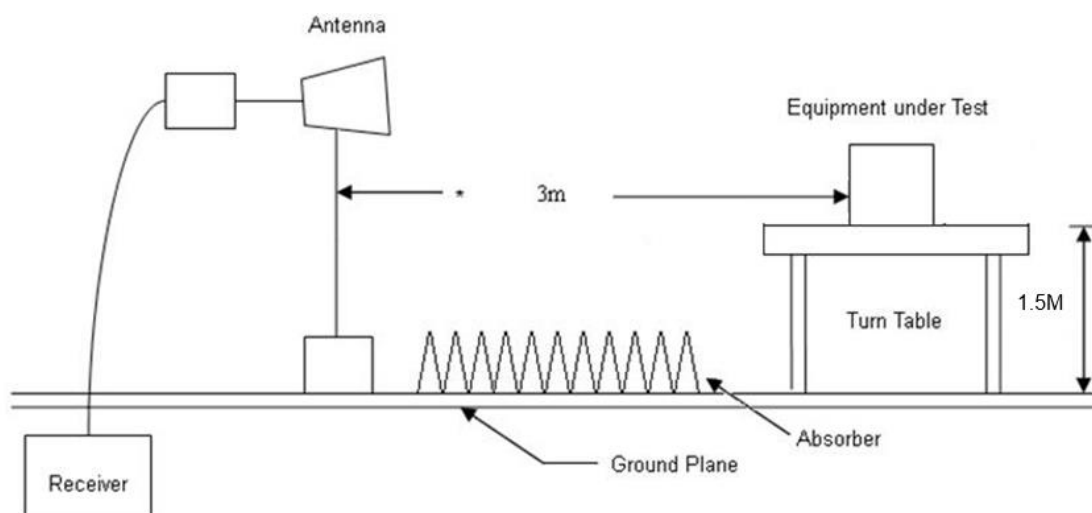



6.4 Test Result and Data (9kHz ~ 30MHz)

The 9kHz-30MHz spurious emission is under limit 20dB more.

6.5 Test Result and Data (30MHz ~ 1GHz)



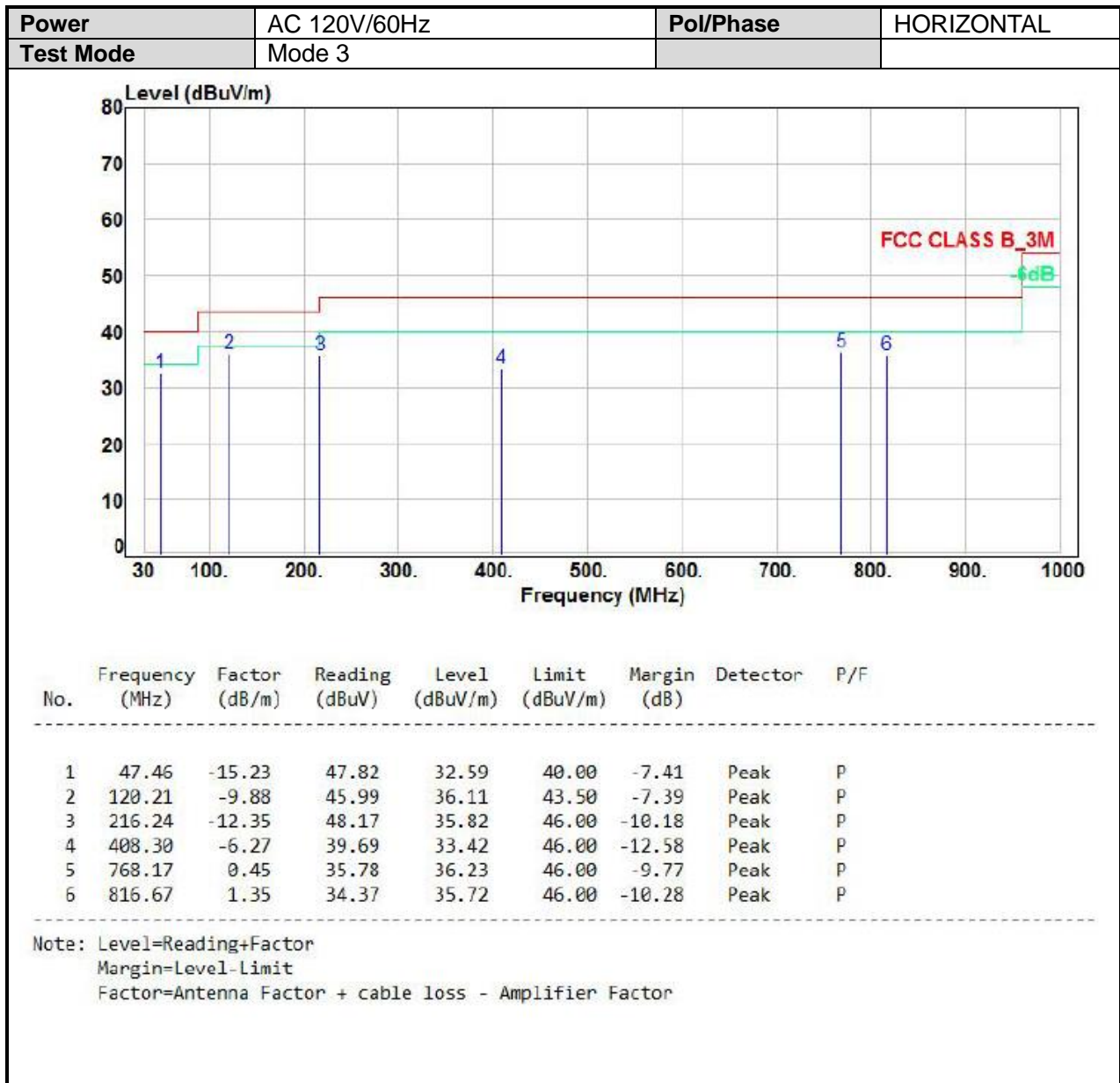



6.6 Test Result and Data (1GHz ~ 25GHz)

Power	AC 120V/60Hz	Pol/Phase	VERTICAL
Test Mode	Mode 1, CH 00	Operation mode	TX

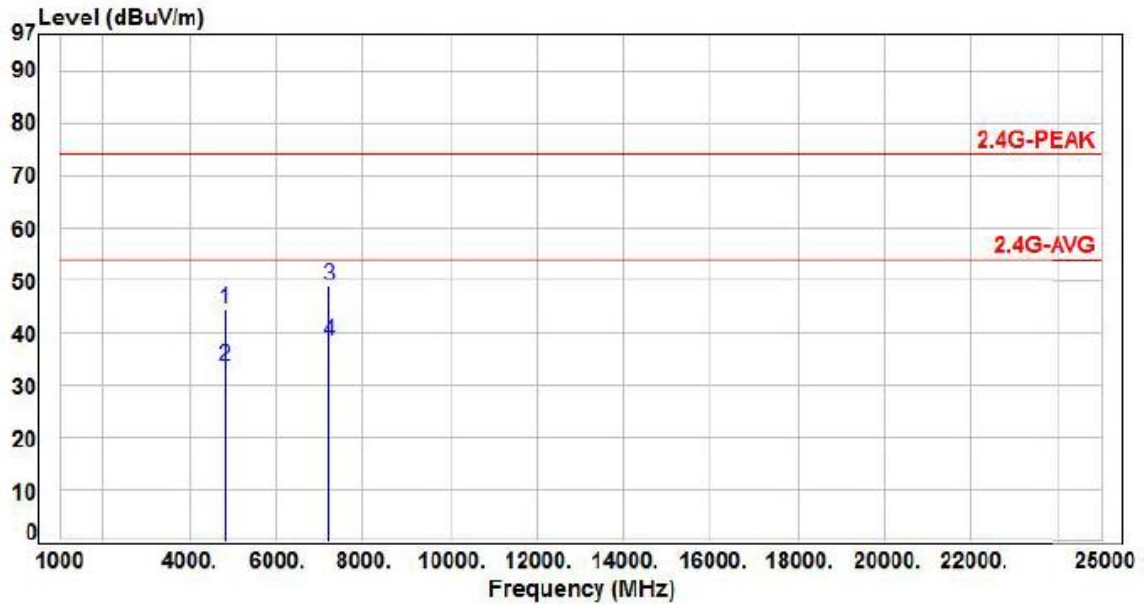

No.	Frequency (MHz)	Factor (dB/m)	Reading (dBuV)	Level (dBuV/m)	Limit (dBuV/m)	Margin (dB)	Detector	P/F
1	4804.00	2.64	41.83	44.47	74.00	-29.53	Peak	P
2	4804.00	2.64	30.94	33.58	54.00	-20.42	Average	P
3	7206.00	8.57	40.53	49.10	74.00	-24.90	Peak	P
4	7206.00	8.57	29.87	38.44	54.00	-15.56	Average	P

Note: Level=Reading+Factor
 Margin=Level-Limit
 Factor=Antenna Factor + cable loss - Amplifier Factor



Power	AC 120V/60Hz	Pol/Phase	HORIZONTAL
Test Mode	Mode 1, CH 00	Operation mode	TX

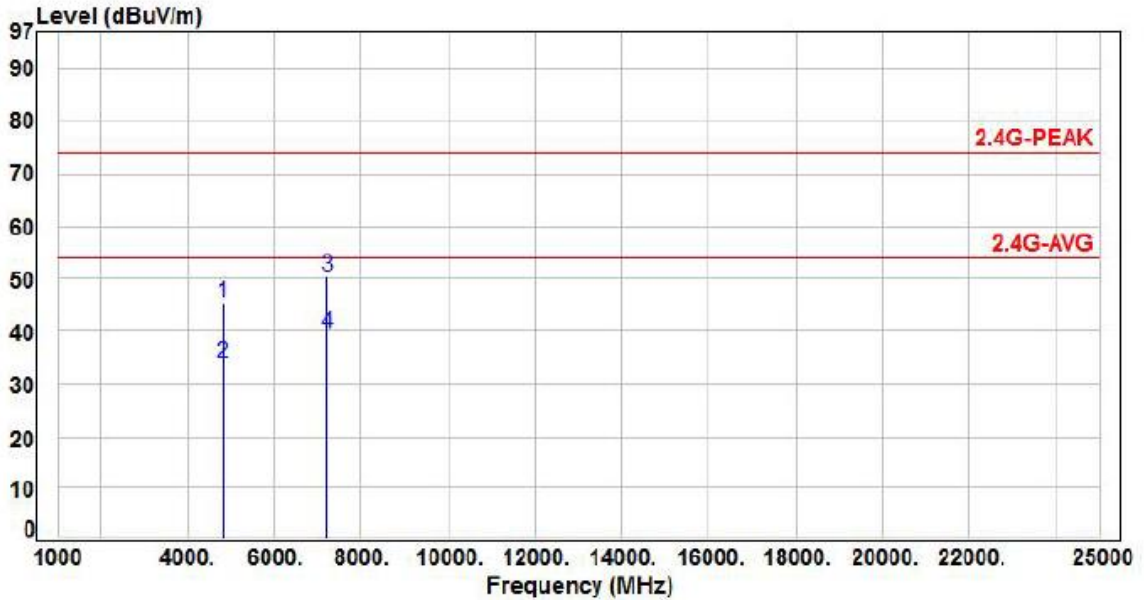

No.	Frequency (MHz)	Factor (dB/m)	Reading (dBuV)	Level (dBuV/m)	Limit (dBuV/m)	Margin (dB)	Detector	P/F
1	4804.00	2.64	42.71	45.35	74.00	-28.65	Peak	P
2	4804.00	2.64	31.37	34.01	54.00	-19.99	Average	P
3	7206.00	8.57	41.77	50.34	74.00	-23.66	Peak	P
4	7206.00	8.57	30.95	39.52	54.00	-14.48	Average	P

Note: Level=Reading+Factor
 Margin=Level-Limit
 Factor=Antenna Factor + cable loss - Amplifier Factor



Power	AC 120V/60Hz	Pol/Phase	VERTICAL
Test Mode	Mode 1, CH 39	Operation mode	TX

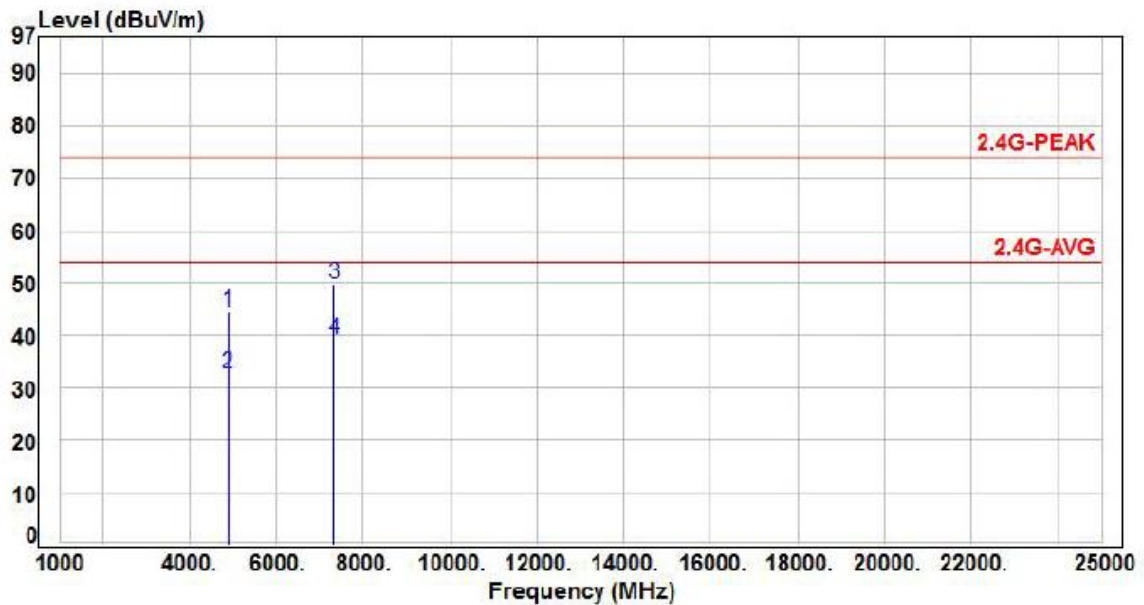

No.	Frequency (MHz)	Factor (dB/m)	Reading (dBuV)	Level (dBuV/m)	Limit (dBuV/m)	Margin (dB)	Detector	P/F
1	4882.00	2.59	41.83	44.42	74.00	-29.58	Peak	P
2	4882.00	2.59	30.15	32.74	54.00	-21.26	Average	P
3	7323.00	8.64	41.23	49.87	74.00	-24.13	Peak	P
4	7323.00	8.64	30.47	39.11	54.00	-14.89	Average	P

Note: Level=Reading+Factor
 Margin=Level-Limit
 Factor=Antenna Factor + cable loss - Amplifier Factor



Power	AC 120V/60Hz	Pol/Phase	HORIZONTAL
Test Mode	Mode 1, CH 39	Operation mode	TX

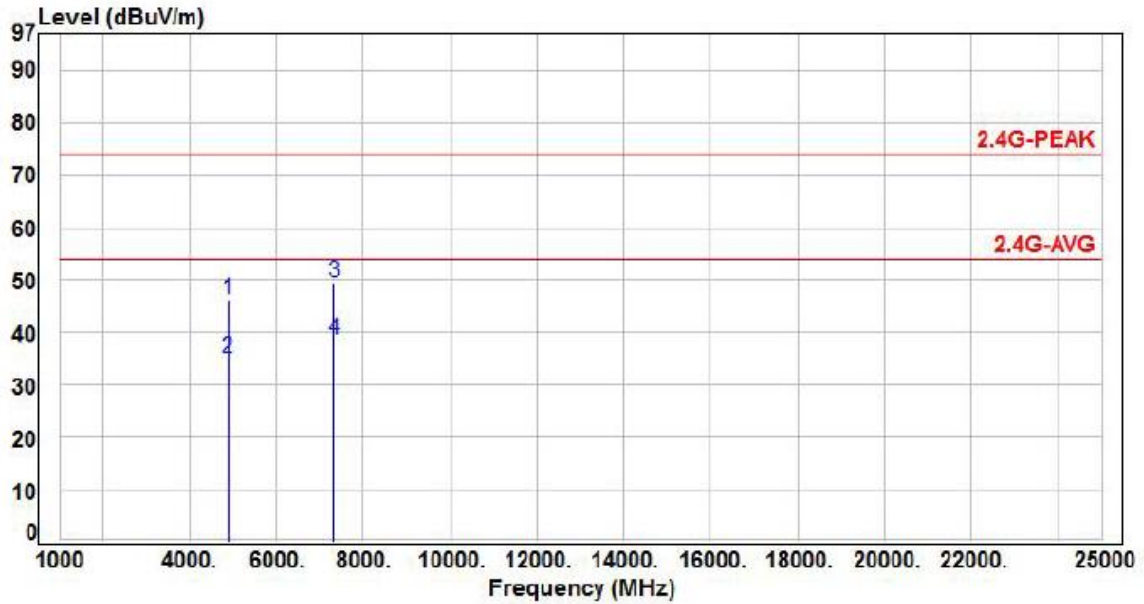

No.	Frequency (MHz)	Factor (dB/m)	Reading (dBuV)	Level (dBuV/m)	Limit (dBuV/m)	Margin (dB)	Detector	P/F
1	4882.00	2.59	43.82	46.41	74.00	-27.59	Peak	P
2	4882.00	2.59	32.54	35.13	54.00	-18.87	Average	P
3	7323.00	8.64	40.93	49.57	74.00	-24.43	Peak	P
4	7323.00	8.64	30.14	38.78	54.00	-15.22	Average	P

Note: Level=Reading+Factor
Margin=Level-Limit
Factor=Antenna Factor + cable loss - Amplifier Factor



Power	AC 120V/60Hz	Pol/Phase	VERTICAL
Test Mode	Mode 1, CH 78	Operation mode	TX

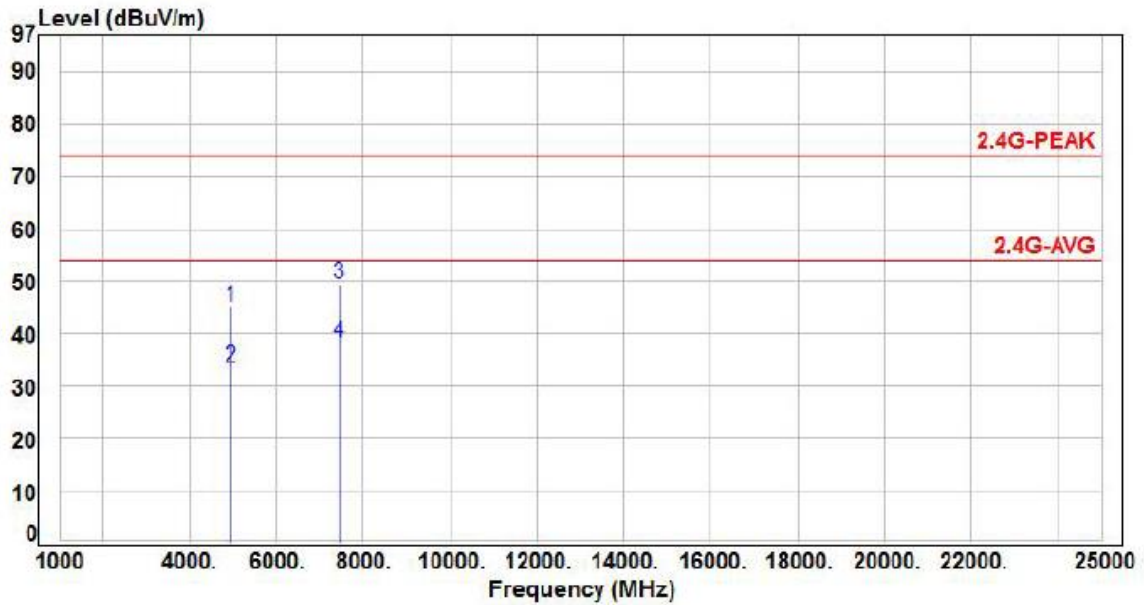

No.	Frequency (MHz)	Factor (dB/m)	Reading (dBuV)	Level (dBuV/m)	Limit (dBuV/m)	Margin (dB)	Detector	P/F
1	4960.00	2.53	42.45	44.98	74.00	-29.02	Peak	P
2	4960.00	2.53	31.16	33.69	54.00	-20.31	Average	P
3	7440.00	8.72	40.85	49.57	74.00	-24.43	Peak	P
4	7440.00	8.72	29.73	38.45	54.00	-15.55	Average	P

Note: Level=Reading+Factor
 Margin=Level-Limit
 Factor=Antenna Factor + cable loss - Amplifier Factor



Power	AC 120V/60Hz	Pol/Phase	HORIZONTAL
Test Mode	Mode 1, CH 78	Operation mode	TX

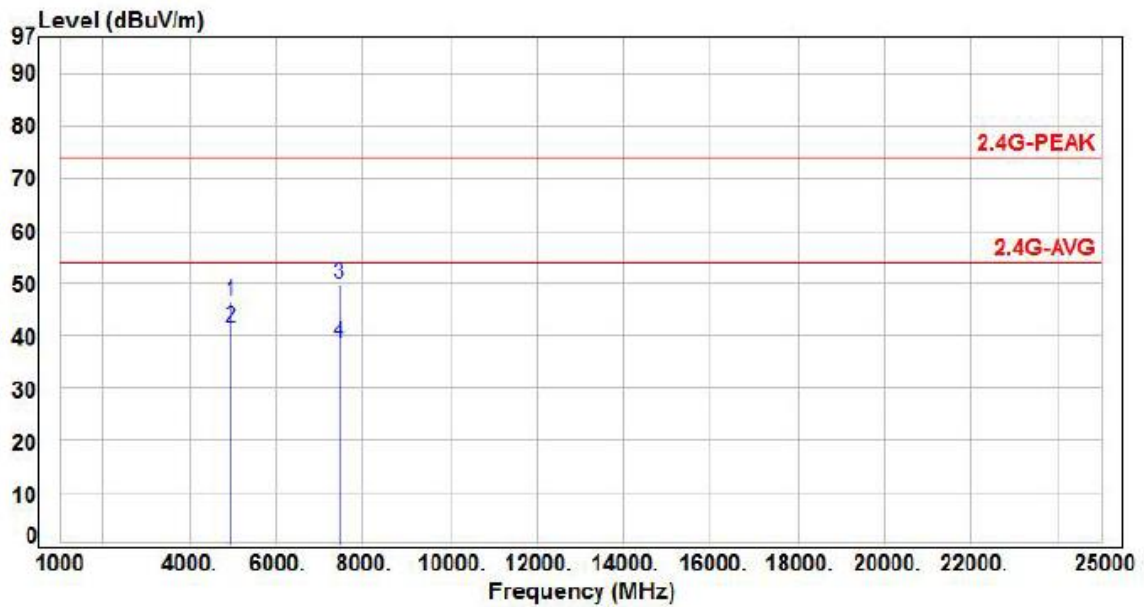

No.	Frequency (MHz)	Factor (dB/m)	Reading (dBuV)	Level (dBuV/m)	Limit (dBuV/m)	Margin (dB)	Detector	P/F
1	4960.00	2.53	44.16	46.69	74.00	-27.31	Peak	P
2	4960.00	2.53	38.94	41.47	54.00	-12.53	Average	P
3	7440.00	8.72	41.16	49.88	74.00	-24.12	Peak	P
4	7440.00	8.72	29.91	38.63	54.00	-15.37	Average	P

Note: Level=Reading+Factor
 Margin=Level-Limit
 Factor=Antenna Factor + cable loss - Amplifier Factor



Power	AC 120V/60Hz	Pol/Phase	VERTICAL
Test Mode	Mode 2, CH 00	Operation mode	TX

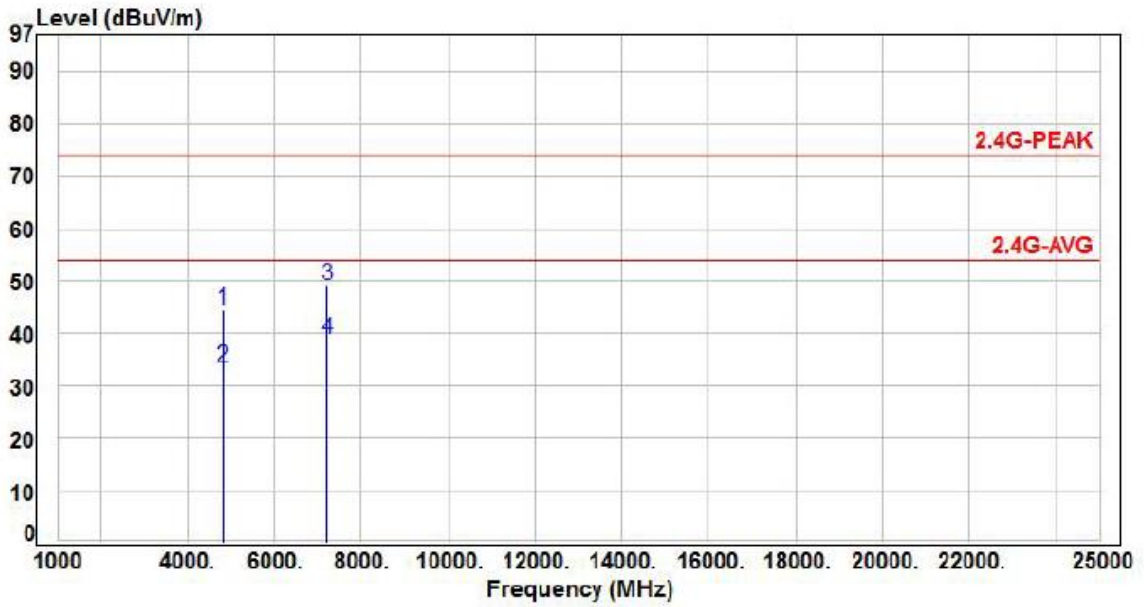

No.	Frequency (MHz)	Factor (dB/m)	Reading (dBuV)	Level (dBuV/m)	Limit (dBuV/m)	Margin (dB)	Detector	P/F
1	4804.00	2.64	41.92	44.56	74.00	-29.44	Peak	P
2	4804.00	2.64	31.09	33.73	54.00	-20.27	Average	P
3	7206.00	8.57	40.77	49.34	74.00	-24.66	Peak	P
4	7206.00	8.57	30.24	38.81	54.00	-15.19	Average	P

Note: Level=Reading+Factor
 Margin=Level-Limit
 Factor=Antenna Factor + cable loss - Amplifier Factor



Power	AC 120V/60Hz	Pol/Phase	HORIZONTAL
Test Mode	Mode 2, CH 00	Operation mode	TX

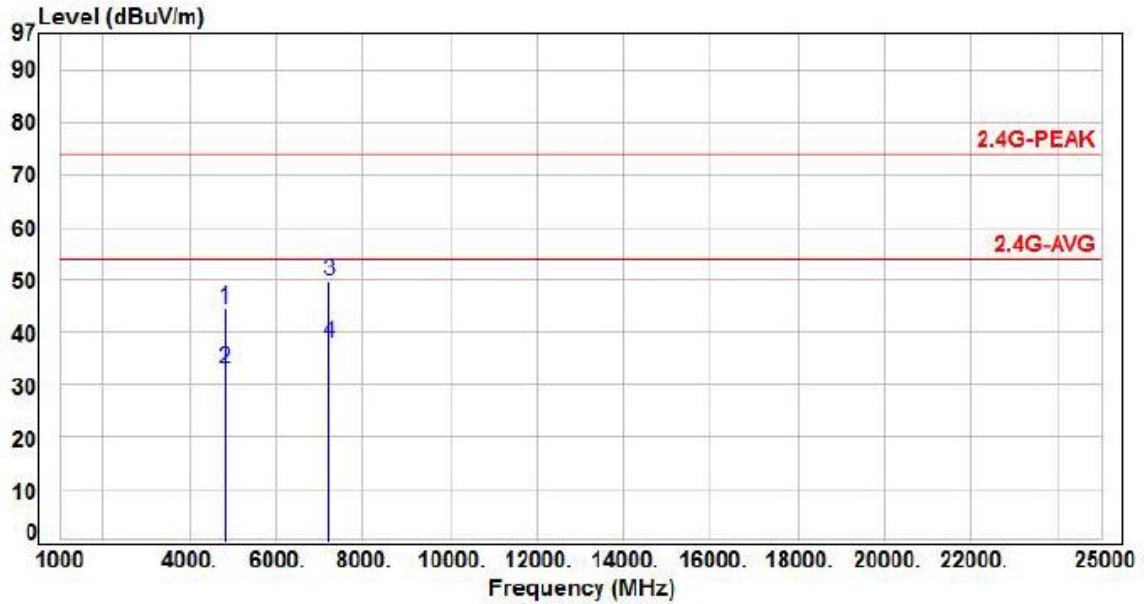

No.	Frequency (MHz)	Factor (dB/m)	Reading (dBuV)	Level (dBuV/m)	Limit (dBuV/m)	Margin (dB)	Detector	P/F
1	4804.00	2.64	41.76	44.40	74.00	-29.60	Peak	P
2	4804.00	2.64	30.46	33.10	54.00	-20.90	Average	P
3	7206.00	8.57	41.37	49.94	74.00	-24.06	Peak	P
4	7206.00	8.57	29.62	38.19	54.00	-15.81	Average	P

Note: Level=Reading+Factor
Margin=Level-Limit
Factor=Antenna Factor + cable loss - Amplifier Factor



Power	AC 120V/60Hz	Pol/Phase	VERTICAL
Test Mode	Mode 2, CH 39	Operation mode	TX

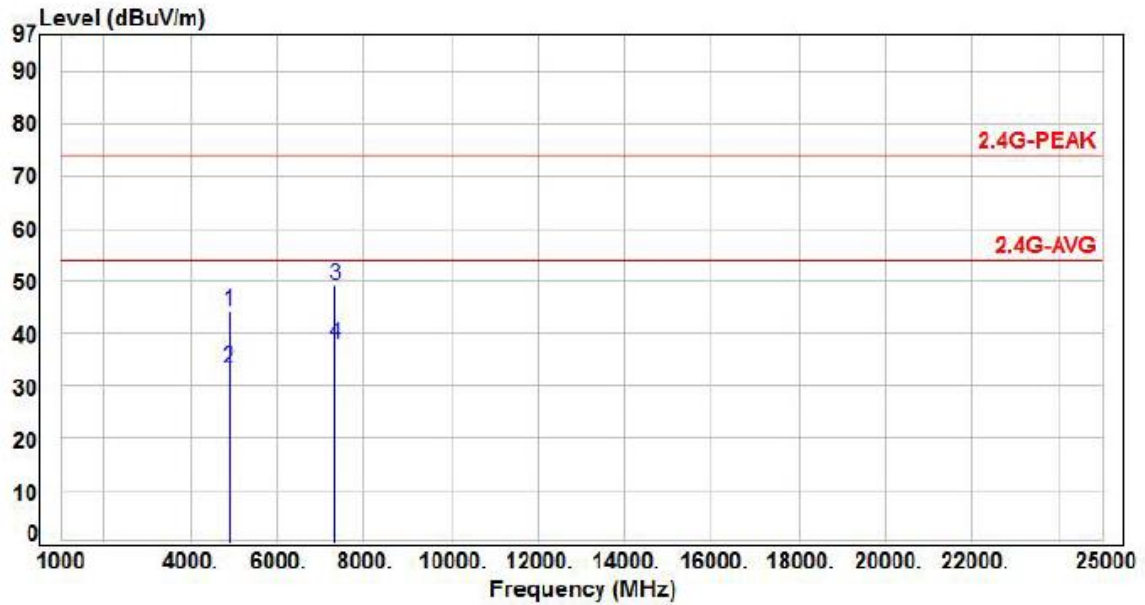

No.	Frequency (MHz)	Factor (dB/m)	Reading (dBuV)	Level (dBuV/m)	Limit (dBuV/m)	Margin (dB)	Detector	P/F
1	4882.00	2.59	41.79	44.38	74.00	-29.62	Peak	P
2	4882.00	2.59	30.82	33.41	54.00	-20.59	Average	P
3	7323.00	8.64	40.69	49.33	74.00	-24.67	Peak	P
4	7323.00	8.64	29.35	37.99	54.00	-16.01	Average	P

Note: Level=Reading+Factor
Margin=Level-Limit
Factor=Antenna Factor + cable loss - Amplifier Factor



Power	AC 120V/60Hz	Pol/Phase	HORIZONTAL
Test Mode	Mode 2, CH 39	Operation mode	TX

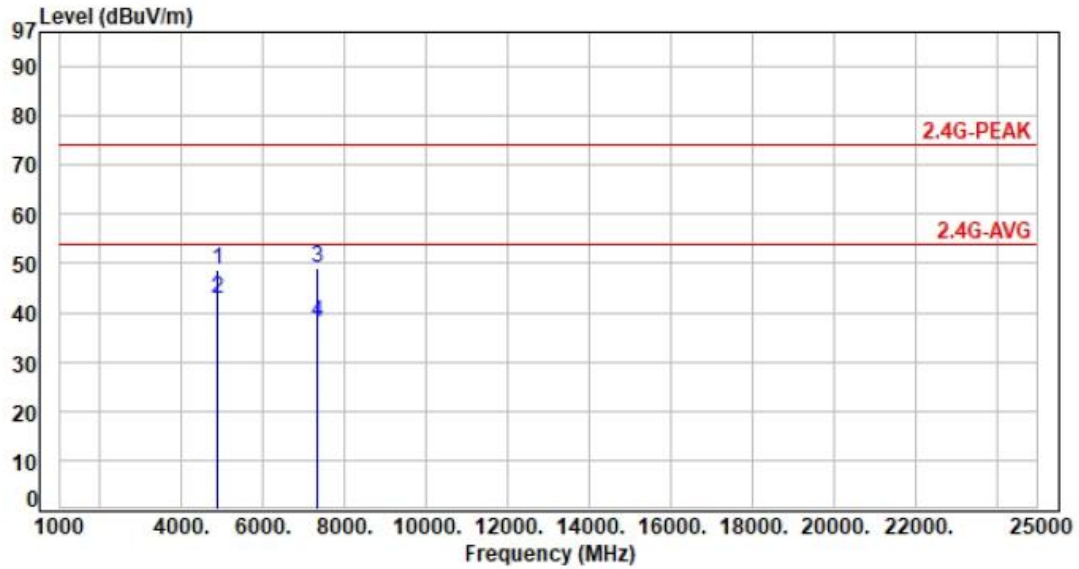

No.	Frequency (MHz)	Factor (dB/m)	Reading (dBuV)	Level (dBuV/m)	Limit (dBuV/m)	Margin (dB)	Detector	P/F
1	4882.00	2.59	46.18	48.77	74.00	-25.23	Peak	P
2	4882.00	2.59	40.26	42.85	54.00	-11.15	Average	P
3	7323.00	8.64	40.53	49.17	74.00	-24.83	Peak	P
4	7323.00	8.64	29.44	38.08	54.00	-15.92	Average	P

Note: Level=Reading+Factor
Margin=Level-Limit
Factor=Antenna Factor + cable loss - Amplifier Factor



Power	AC 120V/60Hz	Pol/Phase	VERTICAL
Test Mode	Mode 2, CH 78	Operation mode	TX

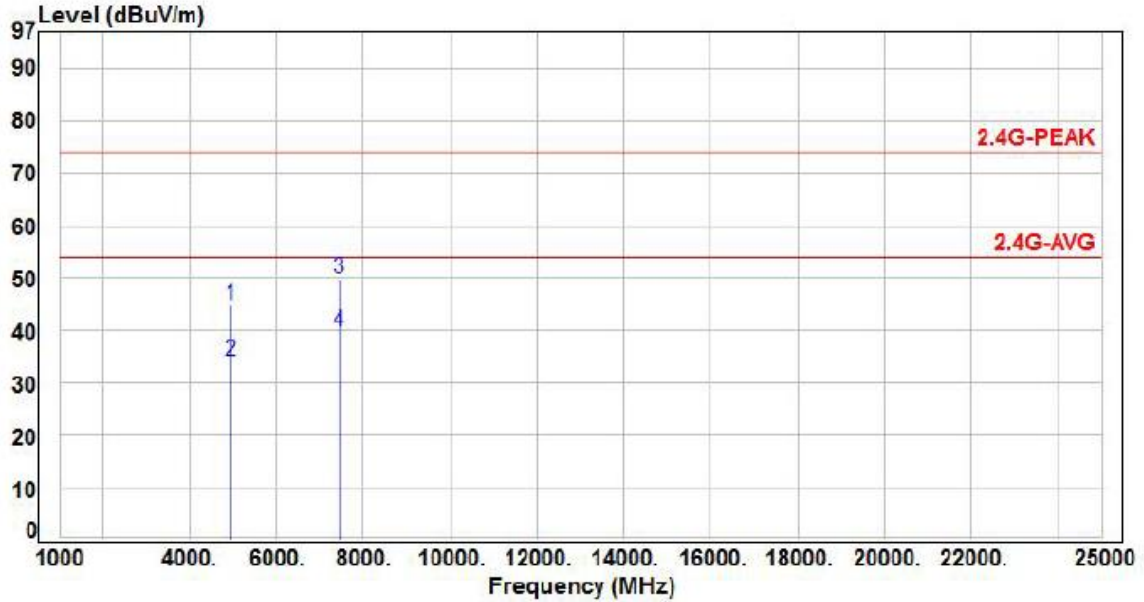

No.	Frequency (MHz)	Factor (dB/m)	Reading (dBuV)	Level (dBuV/m)	Limit (dBuV/m)	Margin (dB)	Detector	P/F
1	4960.00	2.53	42.18	44.71	74.00	-29.29	Peak	P
2	4960.00	2.53	31.71	34.24	54.00	-19.76	Average	P
3	7440.00	8.72	41.06	49.78	74.00	-24.22	Peak	P
4	7440.00	8.72	30.98	39.70	54.00	-14.30	Average	P

Note: Level=Reading+Factor
 Margin=Level-Limit
 Factor=Antenna Factor + cable loss - Amplifier Factor

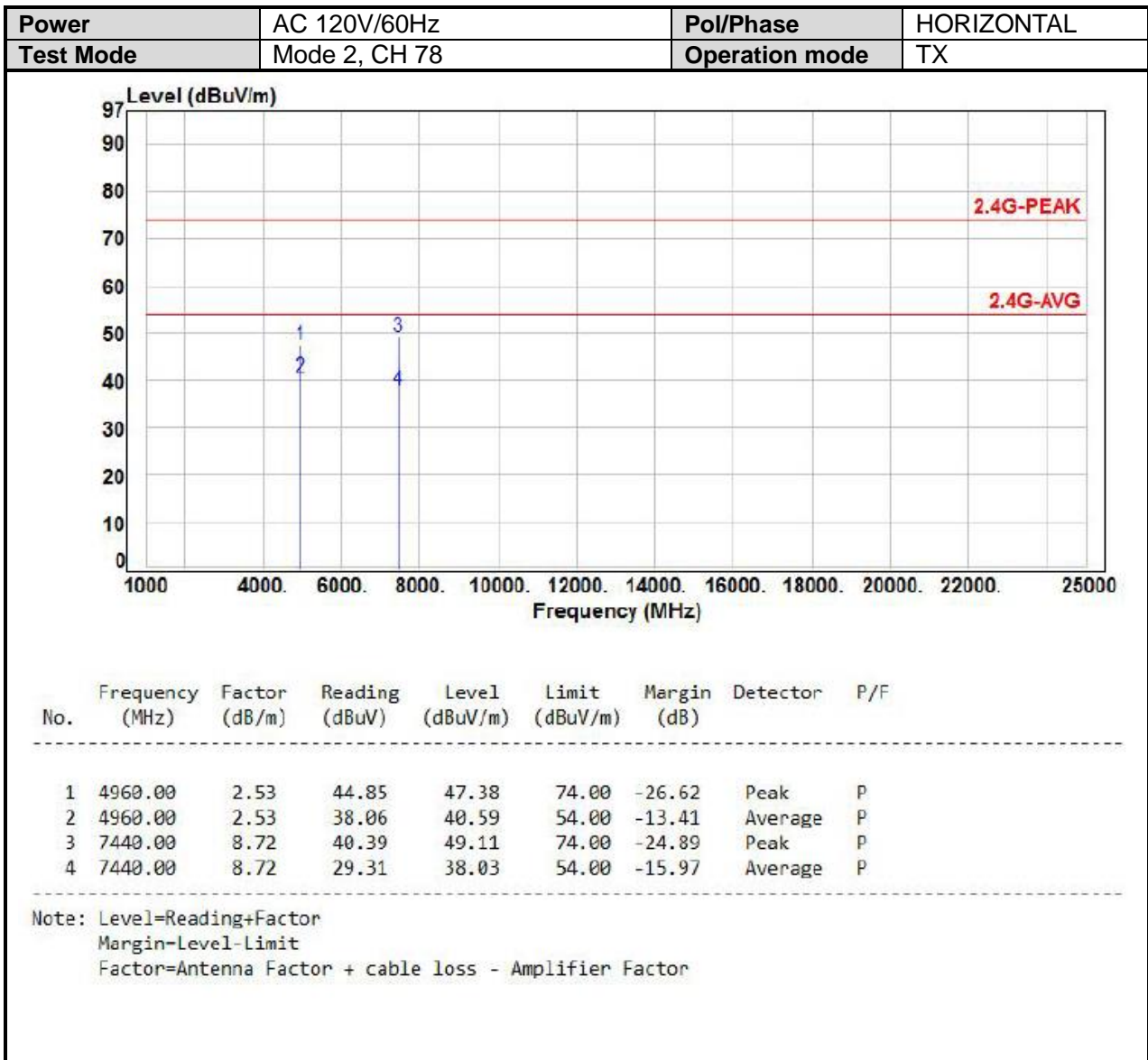



Power	AC 120V/60Hz	Pol/Phase	VERTICAL
Test Mode	Mode 3, CH 00	Operation mode	TX

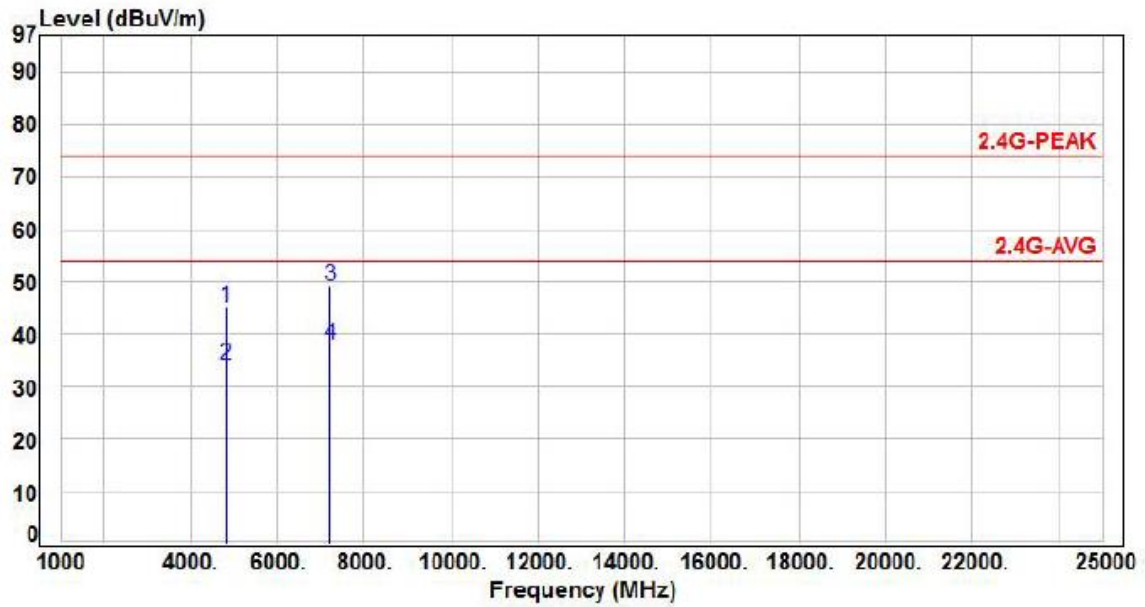

No.	Frequency (MHz)	Factor (dB/m)	Reading (dBuV)	Level (dBuV/m)	Limit (dBuV/m)	Margin (dB)	Detector	P/F
1	4804.00	2.64	42.46	45.10	74.00	-28.90	Peak	P
2	4804.00	2.64	31.53	34.17	54.00	-19.83	Average	P
3	7206.00	8.57	40.61	49.18	74.00	-24.82	Peak	P
4	7206.00	8.57	29.57	38.14	54.00	-15.86	Average	P

Note: Level=Reading+Factor
Margin=Level-Limit
Factor=Antenna Factor + cable loss - Amplifier Factor



Power	AC 120V/60Hz	Pol/Phase	HORIZONTAL
Test Mode	Mode 3, CH 00	Operation mode	TX

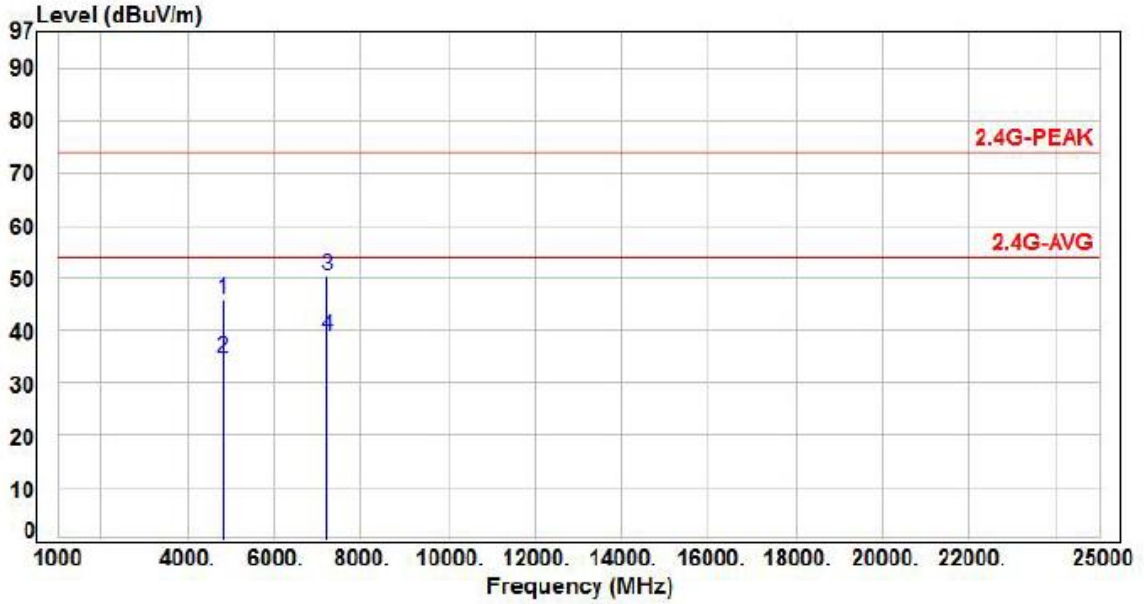

No.	Frequency (MHz)	Factor (dB/m)	Reading (dBuV)	Level (dBuV/m)	Limit (dBuV/m)	Margin (dB)	Detector	P/F
1	4804.00	2.64	43.25	45.89	74.00	-28.11	Peak	P
2	4804.00	2.64	32.17	34.81	54.00	-19.19	Average	P
3	7206.00	8.57	41.77	50.34	74.00	-23.66	Peak	P
4	7206.00	8.57	30.24	38.81	54.00	-15.19	Average	P

Note: Level=Reading+Factor
Margin=Level-Limit
Factor=Antenna Factor + cable loss - Amplifier Factor



Power	AC 120V/60Hz	Pol/Phase	VERTICAL
Test Mode	Mode 3, CH 39	Operation mode	TX

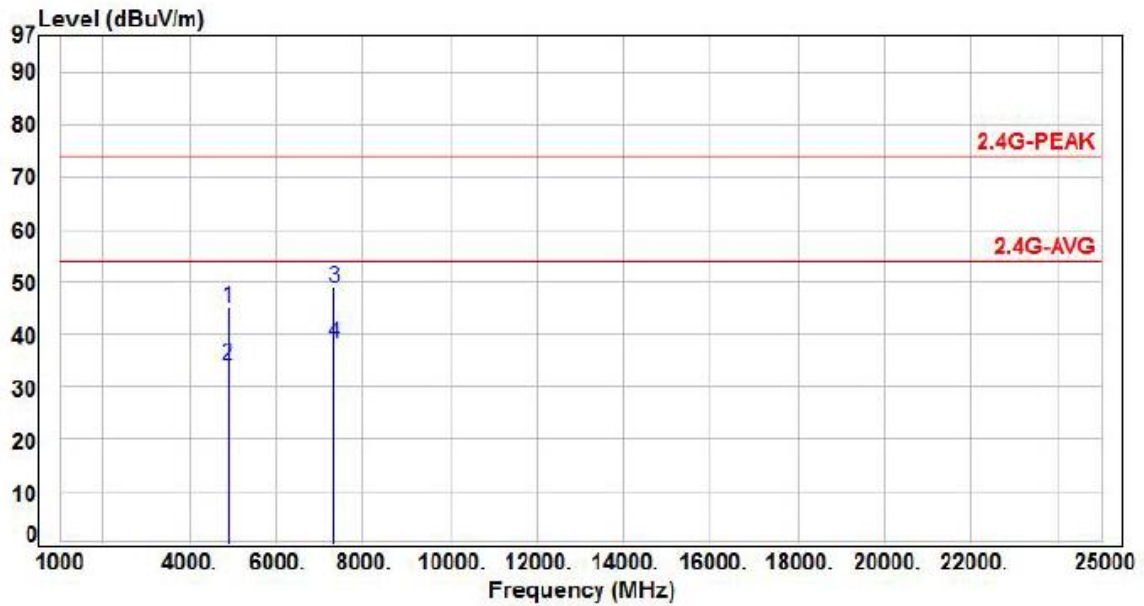

No.	Frequency (MHz)	Factor (dB/m)	Reading (dBuV)	Level (dBuV/m)	Limit (dBuV/m)	Margin (dB)	Detector	P/F
1	4882.00	2.59	42.47	45.06	74.00	-28.94	Peak	P
2	4882.00	2.59	31.51	34.10	54.00	-19.90	Average	P
3	7323.00	8.64	40.26	48.90	74.00	-25.10	Peak	P
4	7323.00	8.64	29.65	38.29	54.00	-15.71	Average	P

Note: Level=Reading+Factor
 Margin=Level-Limit
 Factor=Antenna Factor + cable loss - Amplifier Factor



Power	AC 120V/60Hz	Pol/Phase	HORIZONTAL
Test Mode	Mode 3, CH 39	Operation mode	TX

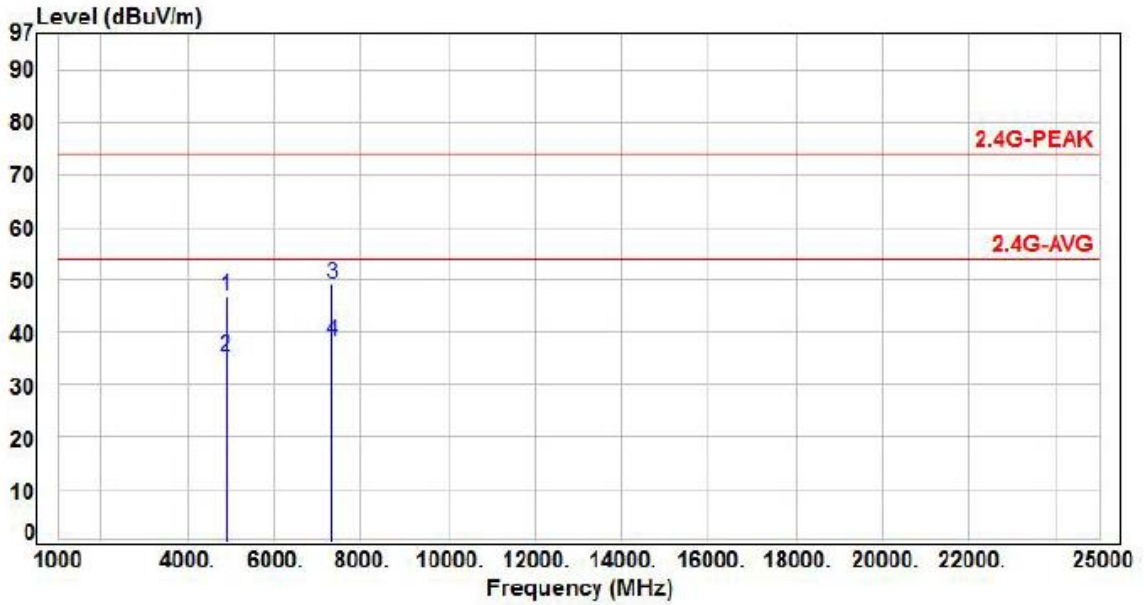

No.	Frequency (MHz)	Factor (dB/m)	Reading (dBuV)	Level (dBuV/m)	Limit (dBuV/m)	Margin (dB)	Detector	P/F
1	4882.00	2.59	44.36	46.95	74.00	-27.05	Peak	P
2	4882.00	2.59	32.68	35.27	54.00	-18.73	Average	P
3	7323.00	8.64	40.52	49.16	74.00	-24.84	Peak	P
4	7323.00	8.64	29.66	38.30	54.00	-15.70	Average	P

Note: Level=Reading+Factor
 Margin=Level-Limit
 Factor=Antenna Factor + cable loss - Amplifier Factor



Power	AC 120V/60Hz	Pol/Phase	VERTICAL
Test Mode	Mode 3, CH 78	Operation mode	TX

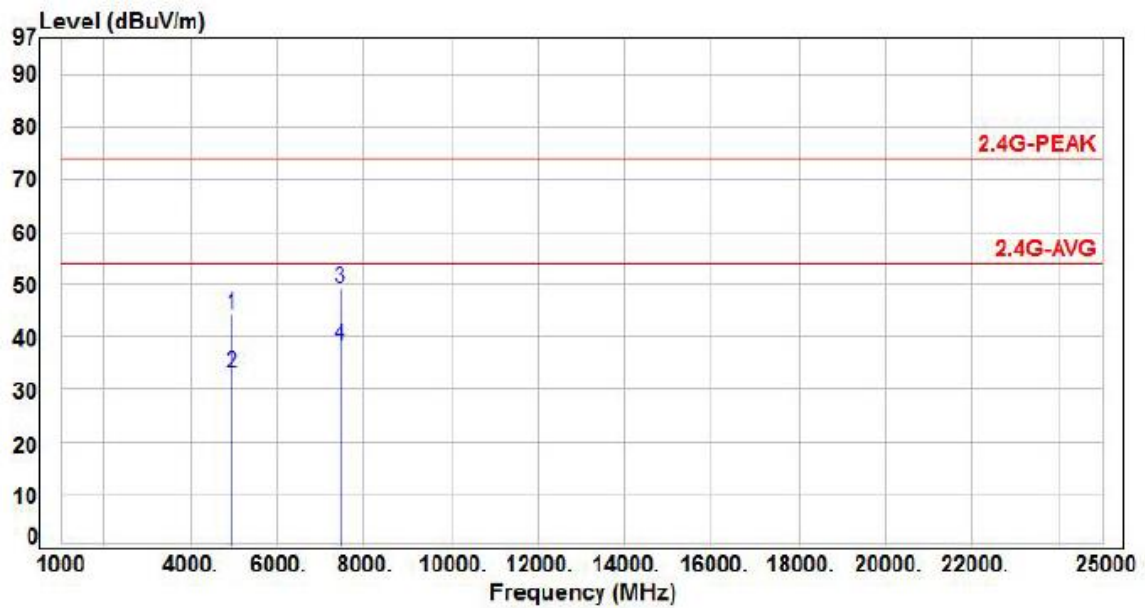

No.	Frequency (MHz)	Factor (dB/m)	Reading (dBuV)	Level (dBuV/m)	Limit (dBuV/m)	Margin (dB)	Detector	P/F
1	4960.00	2.53	41.58	44.11	74.00	-29.89	Peak	P
2	4960.00	2.53	30.46	32.99	54.00	-21.01	Average	P
3	7440.00	8.72	40.66	49.38	74.00	-24.62	Peak	P
4	7440.00	8.72	29.53	38.25	54.00	-15.75	Average	P

Note: Level=Reading+Factor
 Margin=Level-Limit
 Factor=Antenna Factor + cable loss - Amplifier Factor



Power	AC 120V/60Hz	Pol/Phase	HORIZONTAL
Test Mode	Mode 3, CH 78	Operation mode	TX

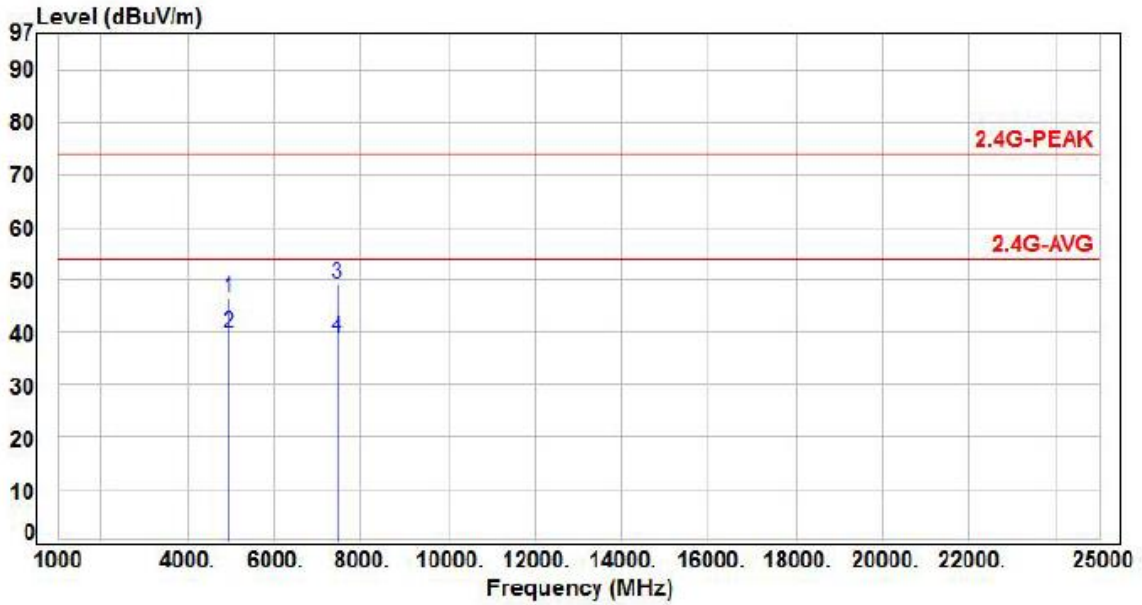

No.	Frequency (MHz)	Factor (dB/m)	Reading (dBuV)	Level (dBuV/m)	Limit (dBuV/m)	Margin (dB)	Detector	P/F
1	4960.00	2.53	44.03	46.56	74.00	-27.44	Peak	P
2	4960.00	2.53	37.34	39.87	54.00	-14.13	Average	P
3	7440.00	8.72	40.46	49.18	74.00	-24.82	Peak	P
4	7440.00	8.72	30.07	38.79	54.00	-15.21	Average	P

Note: Level=Reading+Factor
 Margin=Level-Limit
 Factor=Antenna Factor + cable loss - Amplifier Factor



6.7 Restricted Bands of Operation

Only spurious emissions are permitted in any of the frequency bands listed below:

MHz	MHz	MHz	GHz
0.09000 – 0.11000	16.42000 – 16.42300	399.9 – 410.0	4.500 – 5.250
0.49500 – 0.505**	16.69475 – 16.69525	608.0 – 614.0	5.350 – 5.460
2.17350 – 2.19050	16.80425 – 16.80475	960.0 – 1240.0	7.250 – 7.750
4.12500 – 4.12800	25.50000 – 25.67000	1300.0 – 1427.0	8.025 – 8.500
4.17725 – 4.17775	37.50000 – 38.25000	1435.0 – 1626.5	9.000 – 9.200
4.20725 – 4.20775	73.00000 – 74.60000	1645.5 – 1646.5	9.300 – 9.500
6.21500 – 6.21800	74.80000 – 75.20000	1660.0 – 1710.0	10.600 – 12.700
6.26775 – 6.26825	108.00000 – 121.94000	1718.8 – 1722.2	13.250 – 13.400
6.31175 – 6.31225	123.00000 – 138.00000	2200.0 – 2300.0	14.470 – 14.500
8.29100 – 8.29400	149.90000 – 150.05000	2310.0 – 2390.0	15.350 – 16.200
8.36200 – 8.36600	156.52475 – 156.52525	2483.5 – 2500.0	17.700 – 21.400
8.37625 – 8.38675	156.70000 – 156.90000	2655.0 – 2900.0	22.010 – 23.120
8.41425 – 8.41475	162.01250 – 167.17000	3260.0 – 3267.0	23.600 – 24.000
12.29000 – 12.29300	167.72000 – 173.20000	3332.0 – 3339.0	31.200 – 31.800
12.51975 – 12.52025	240.00000 – 285.00000	3345.8 – 3358.0	36.430 – 36.500
12.57675 – 12.57725	322.00000 – 335.40000	3600.0 – 4400.0	Above 38.6
13.36000 – 13.41000			

** : Until February 1, 1999, this restricted band shall be 0.490-0.510 MHz



Power	AC 120V/60Hz	Pol/Phase	VERTICAL
Test Mode	GFSK, CH00		

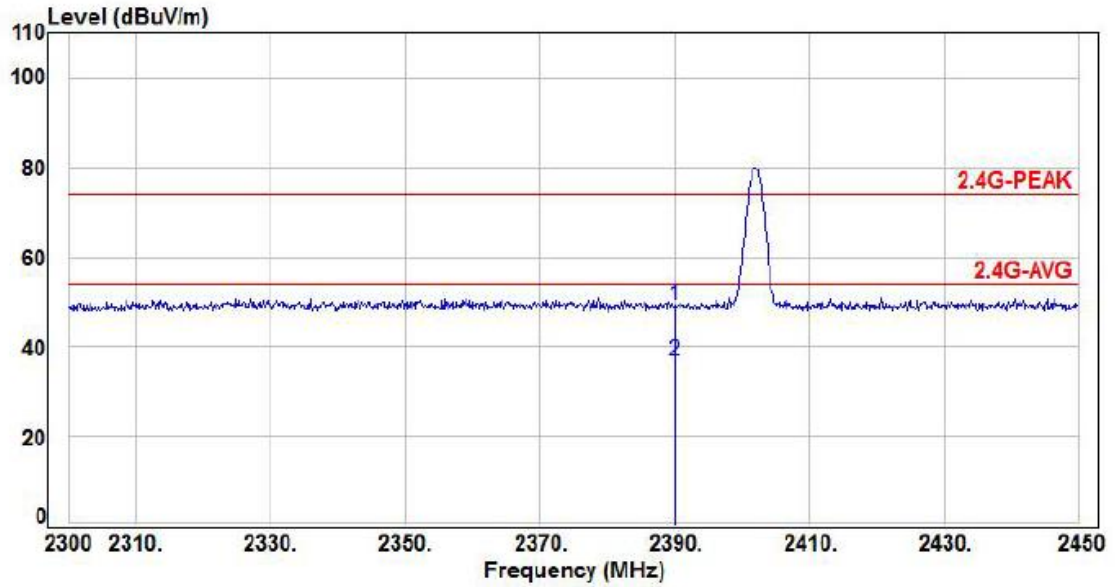

No.	Frequency (MHz)	Factor (dB/m)	Reading (dBuV)	Level (dBuV/m)	Limit (dBuV/m)	Margin (dB)	Detector	P/F
1	2390.00	5.65	43.54	49.19	74.00	-24.81	Peak	P
2	2390.00	5.65	31.06	36.71	54.00	-17.29	Average	P

Note: Level=Reading+Factor
Margin=Level-Limit
Factor=Antenna Factor + cable loss - Amplifier Factor



Power	AC 120V/60Hz	Pol/Phase	HORIZONTAL
Test Mode	GFSK, CH00		

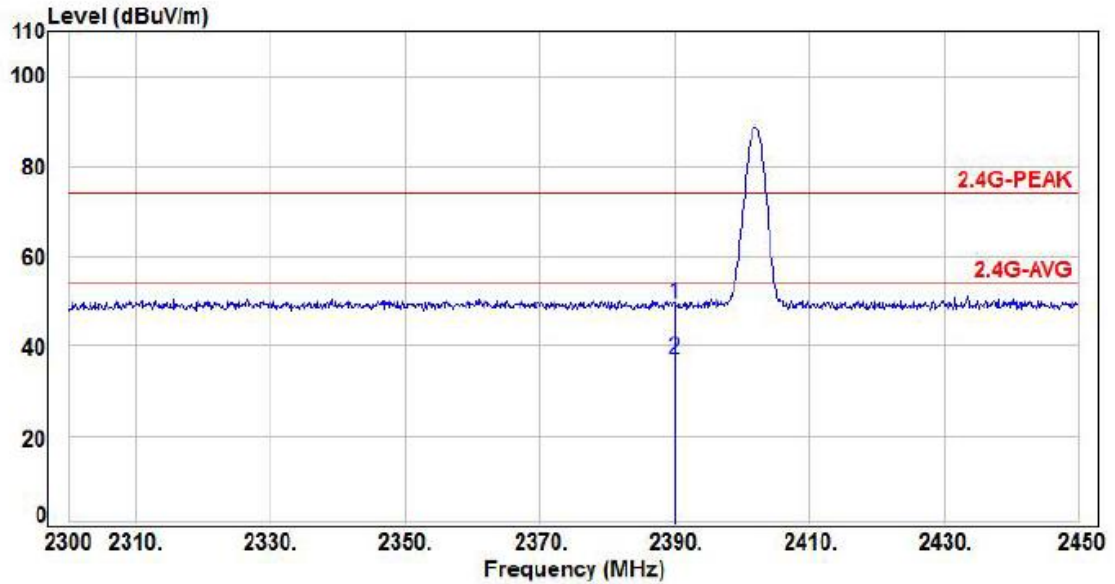

No.	Frequency (MHz)	Factor (dB/m)	Reading (dBuV)	Level (dBuV/m)	Limit (dBuV/m)	Margin (dB)	Detector	P/F
1	2390.00	5.65	43.92	49.57	74.00	-24.43	Peak	P
2	2390.00	5.65	31.50	37.15	54.00	-16.85	Average	P

Note: Level=Reading+Factor
Margin=Level-Limit
Factor=Antenna Factor + cable loss - Amplifier Factor



Power	AC 120V/60Hz	Pol/Phase	VERTICAL
Test Mode	GFSK, CH78		

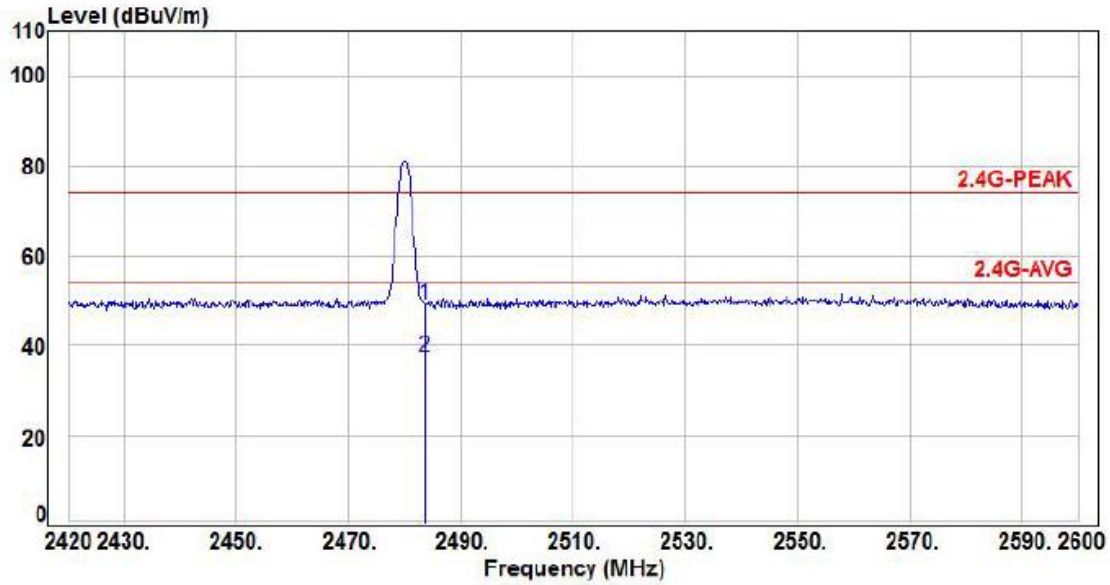

No.	Frequency (MHz)	Factor (dB/m)	Reading (dBUV)	Level (dBUV/m)	Limit (dBUV/m)	Margin (dB)	Detector	P/F
1	2483.50	6.02	43.14	49.16	74.00	-24.84	Peak	P
2	2483.50	6.02	31.61	37.63	54.00	-16.37	Average	P

Note: Level=Reading+Factor
Margin=Level-Limit
Factor=Antenna Factor + cable loss - Amplifier Factor



Power	AC 120V/60Hz	Pol/Phase	HORIZONTAL
Test Mode	GFSK, CH78		

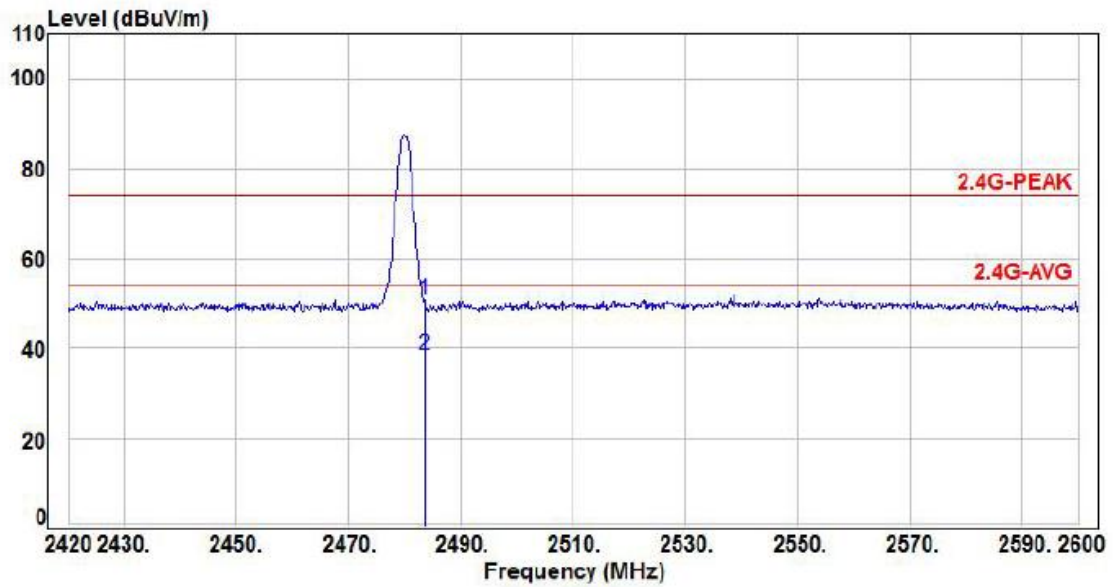

No.	Frequency (MHz)	Factor (dB/m)	Reading (dBUV)	Level (dBUV/m)	Limit (dBUV/m)	Margin (dB)	Detector	P/F
1	2483.50	6.02	44.98	51.00	74.00	-23.00	Peak	P
2	2483.50	6.02	32.56	38.58	54.00	-15.42	Average	P

Note: Level=Reading+Factor
Margin=Level-Limit
Factor=Antenna Factor + cable loss - Amplifier Factor



Power	AC 120V/60Hz	Pol/Phase	VERTICAL
Test Mode	$\pi/4$ -DQPSK , CH00		

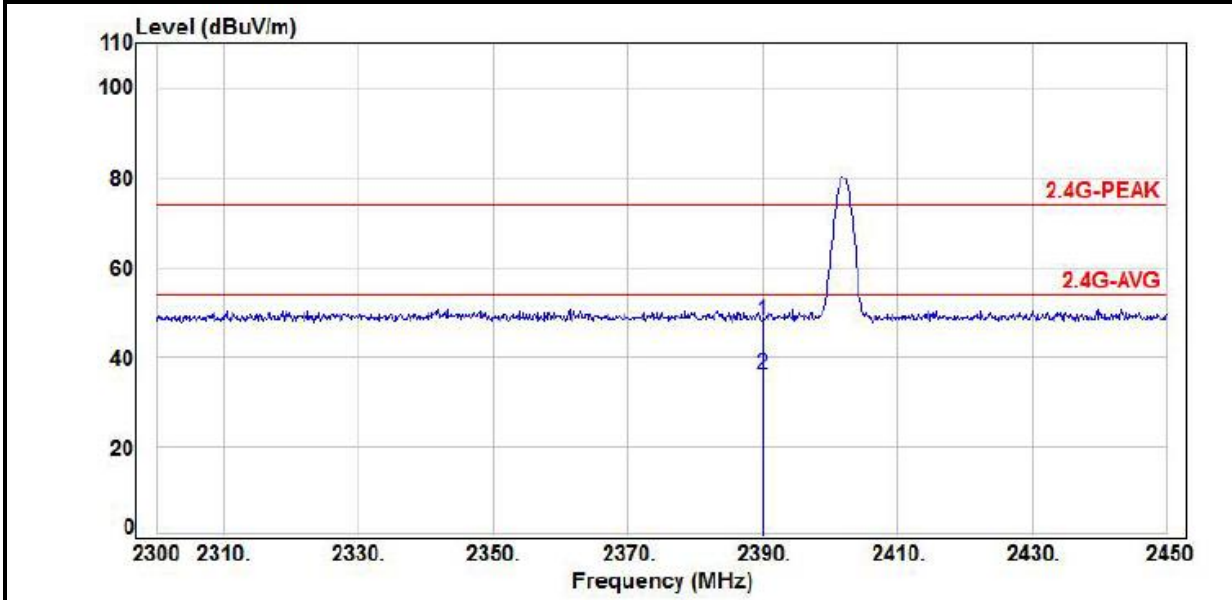

No.	Frequency (MHz)	Factor (dB/m)	Reading (dBuV)	Level (dBuV/m)	Limit (dBuV/m)	Margin (dB)	Detector	P/F
1	2390.00	5.65	42.61	48.26	74.00	-25.74	Peak	P
2	2390.00	5.65	30.36	36.01	54.00	-17.99	Average	P

Note: Level=Reading+Factor
Margin=Level-Limit
Factor=Antenna Factor + cable loss - Amplifier Factor

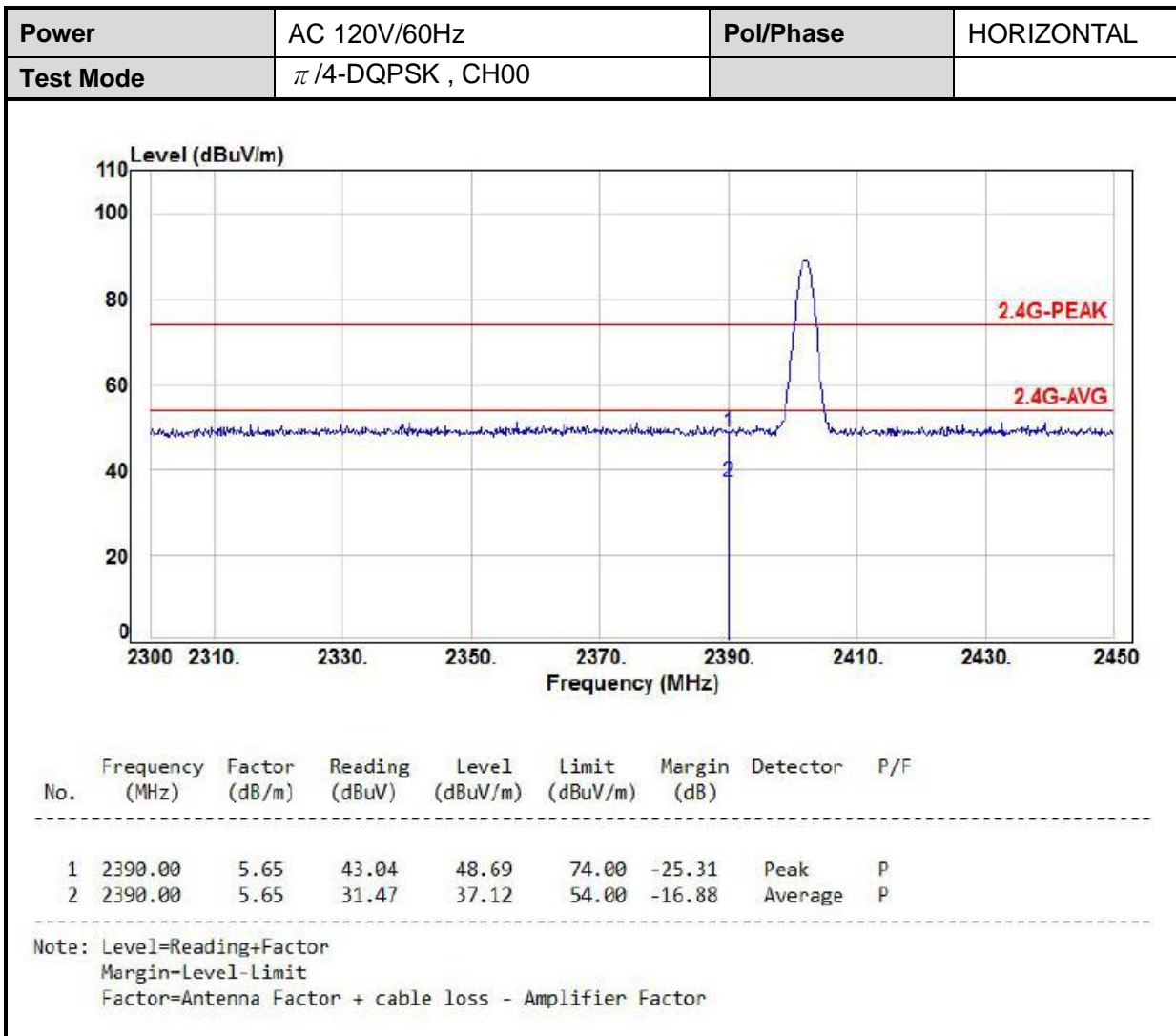

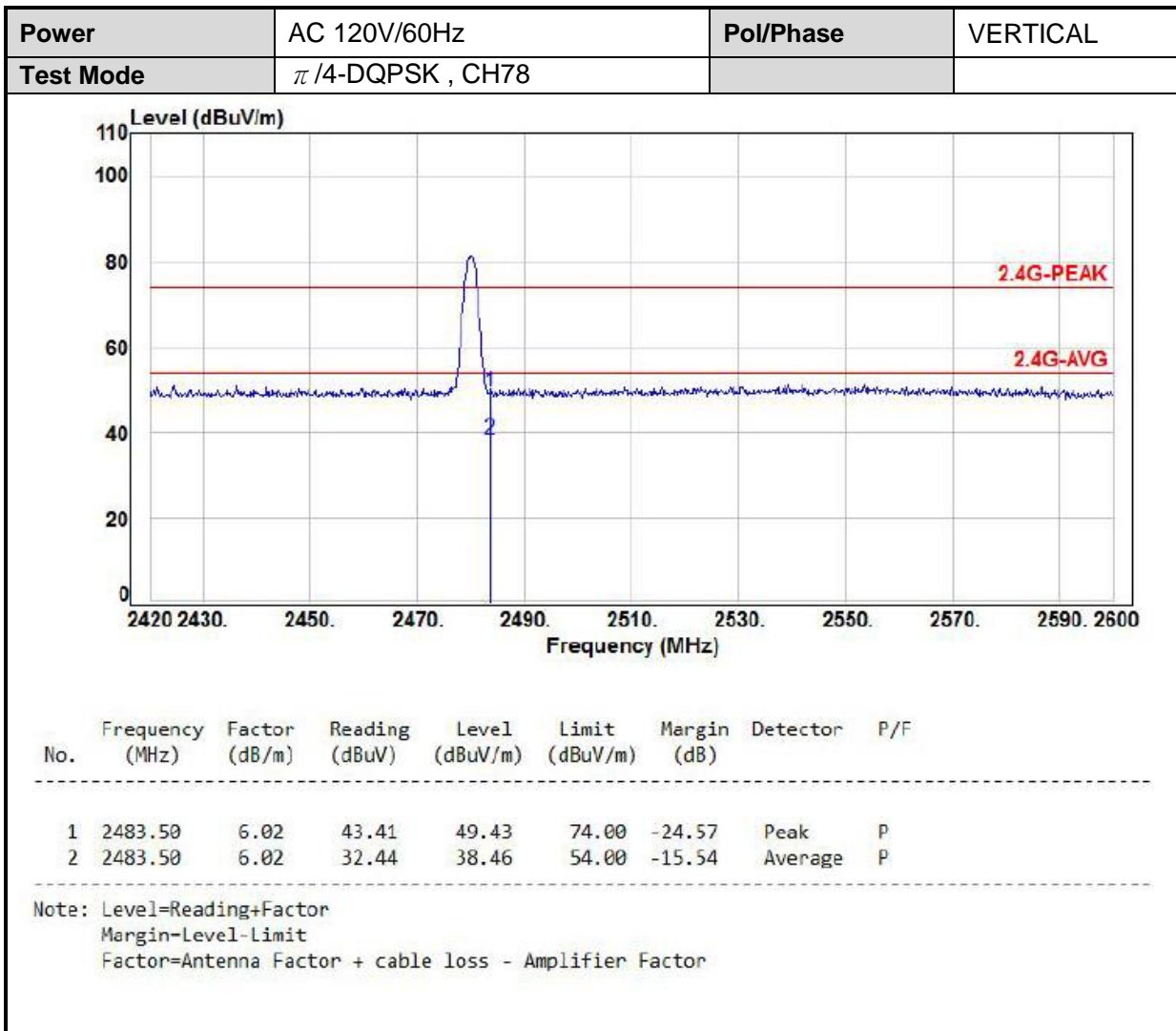

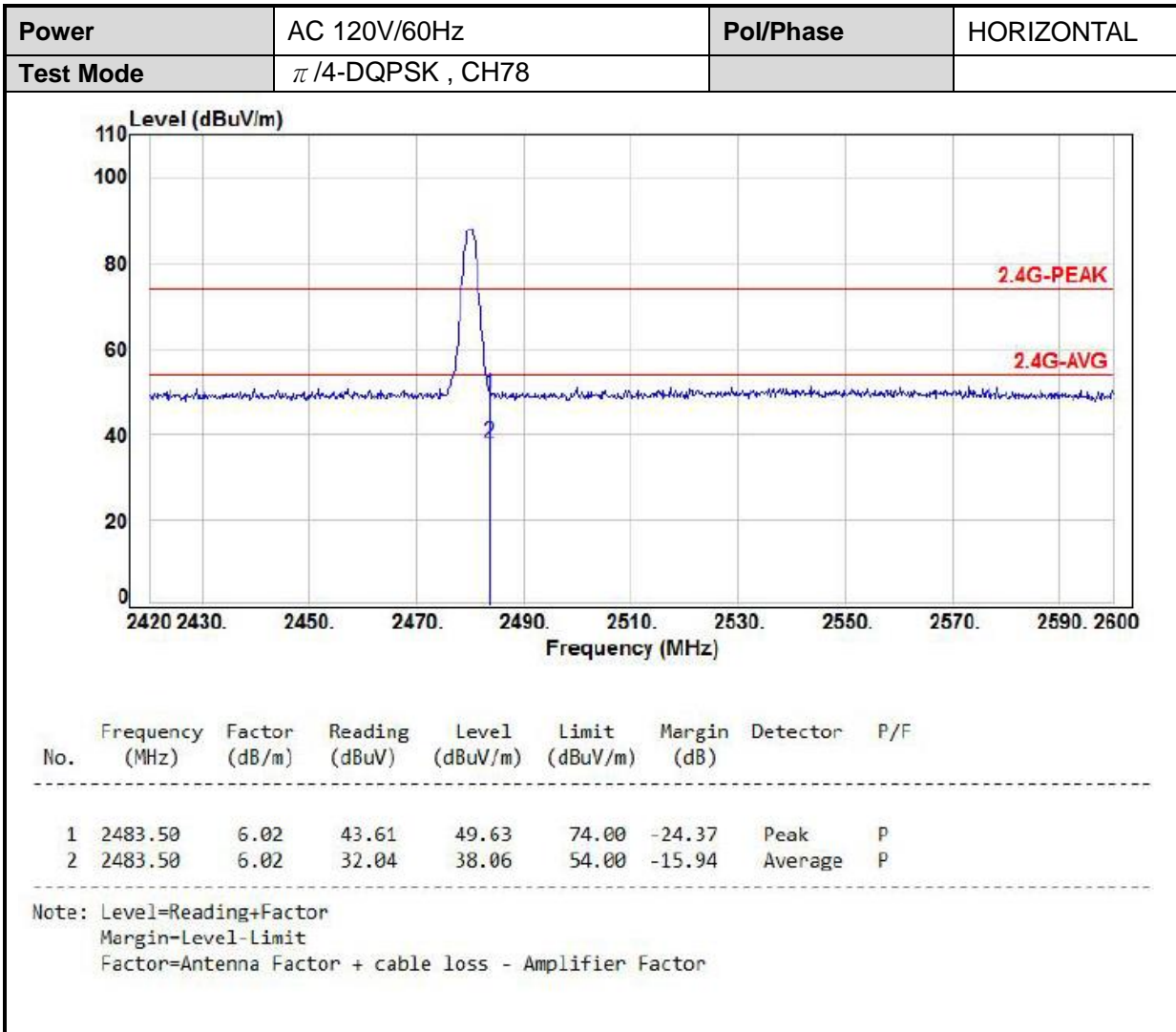



Power	AC 120V/60Hz	Pol/Phase	VERTICAL
Test Mode	8DPSK, CH00		

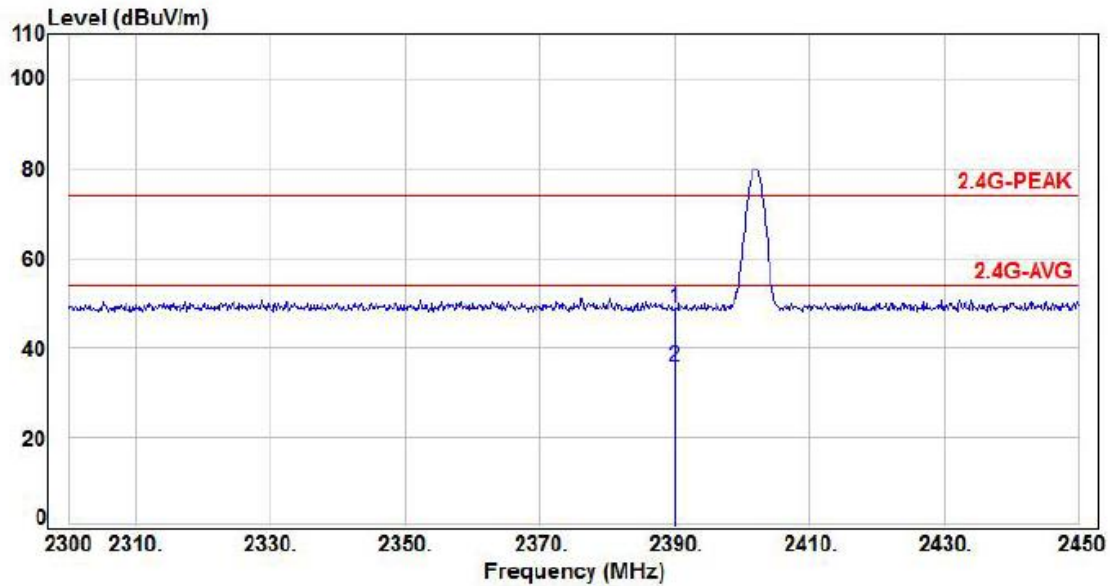

No.	Frequency (MHz)	Factor (dB/m)	Reading (dBUV)	Level (dBUV/m)	Limit (dBUV/m)	Margin (dB)	Detector	P/F
1	2390.00	5.65	43.31	48.96	74.00	-25.04	Peak	P
2	2390.00	5.65	30.27	35.92	54.00	-18.08	Average	P

Note: Level=Reading+Factor
Margin=Level-Limit
Factor=Antenna Factor + cable loss - Amplifier Factor