

FCC Radio Test Report

FCC ID: 2ACFN-QMIROP201W

This report concerns: **Original Grant**

Project No. : 2005H054
Equipment : AI-Powered NAS with Tri-Band Mesh WiFi Router
Brand Name : QNAP
Test Model : QMiroPlus-201W
Series Model : N/A
Applicant : QNAP Systems, Inc.
Address : 2F, No.22, Zhongxing Road, Xizhi District., New Taipei City, Taiwan, 221
Manufacturer : QNAP Systems, Inc.
Address : 2F, No.22, Zhongxing Rd, Xizhi Dist., New Taipei City, 221, Taiwan
Factory : CIG Shanghai Co., Ltd., Shanghai Branch.
Address : F/2,3 Building 1, No. 505 Jiangyue Road, Minhang District, Shanghai, P.R.China
Date of Receipt : Jun. 01, 2020
Date of Test : Jun. 01, 2020 ~ Jul. 01, 2020
Issued Date : Sep. 04, 2020
Report Version : R00
Test Sample : Engineering Sample No.: SH2020060214 for radiated, SH2020060215 and SH2020060213-4 for conducted.
Standard(s) : FCC Part15, Subpart C (15.247)
ANSI C63.10-2013
FCC KDB 558074 D01 15.247 Meas Guidance v05r02

The above equipment has been tested and found compliance with the requirement of the relative standards by BTL Inc.

Allen Wei

Prepared by : Allen Wei

Ryan Wang

Approved by : Ryan Wang



Certificate # 5123.03

Add: No. 29, Jintang Road, Tangzhen Industry Park, Pudong New Area, Shanghai 201210, China
TEL: +86-021-61765666
Web: www.newbtl.com

Declaration

BTL represents to the client that testing is done in accordance with standard procedures as applicable and that test instruments used has been calibrated with standards traceable to international standard(s) and/or national standard(s).

BTL's reports apply only to the specific samples tested under conditions. It is manufacture's responsibility to ensure that additional production units of this model are manufactured with the identical electrical and mechanical components. **BTL** shall have no liability for any declarations, inferences or generalizations drawn by the client or others from **BTL** issued reports.

The report must not be used by the client to claim product certification, approval, or endorsement by NVLAP, NIST, A2LA, or any agency of the U.S. Government.

This report is the confidential property of the client. As a mutual protection to the clients, the public and ourselves, the test report shall not be reproduced, except in full, without our written approval.

BTL's laboratory quality assurance procedures are in compliance with the **ISO/IEC 17025** requirements, and accredited by the conformity assessment authorities listed in this test report.

BTL is not responsible for the sampling stage, so the results only apply to the sample as received.

The information, data and test plan are provided by manufacturer which may affect the validity of results, so it is manufacturer's responsibility to ensure that the apparatus meets the essential requirements of applied standards and in all the possible configurations as representative of its intended use.

Limitation

For the use of the authority's logo is limited unless the Test Standard(s)/Scope(s)/Item(s) mentioned in this test report is (are) included in the conformity assessment authorities acceptance respective.

Please note that the measurement uncertainty is provided for informational purpose only and are not use in determining the Pass/Fail results.

Table of Contents	Page
REPORT ISSUED HISTORY	6
1 . SUMMARY OF TEST RESULTS	7
1.1 TEST FACILITY	8
1.2 MEASUREMENT UNCERTAINTY	8
1.3 TEST ENVIRONMENT CONDITIONS	8
2 . GENERAL INFORMATION	9
2.1 GENERAL DESCRIPTION OF EUT	9
2.2 DESCRIPTION OF TEST MODES	12
2.3 PARAMETERS OF TEST SOFTWARE	14
2.4 DUTY CYCLE	16
2.5 BLOCK DIAGRAM SHOWING THE CONFIGURATION OF SYSTEM TESTED	18
2.6 SUPPORT UNITS	18
3 . AC POWER LINE CONDUCTED EMISSIONS TEST	19
3.1 LIMIT	19
3.2 TEST PROCEDURE	19
3.3 DEVIATION FROM TEST STANDARD	19
3.4 TEST SETUP	20
3.5 EUT OPERATION CONDITIONS	20
3.6 TEST RESULTS	20
4 . RADIATED EMISSIONS TEST	21
4.1 LIMIT	21
4.2 TEST PROCEDURE	22
4.3 DEVIATION FROM TEST STANDARD	22
4.4 TEST SETUP	23
4.5 EUT OPERATION CONDITIONS	24
4.6 TEST RESULTS - 9 KHZ TO 30 MHZ	24
4.7 TEST RESULTS - 30 MHZ TO 1000 MHZ	24
4.8 TEST RESULTS - ABOVE 1000 MHZ	24
5 . BANDWIDTH TEST	25
5.1 LIMIT	25
5.2 TEST PROCEDURE	25
5.3 DEVIATION FROM STANDARD	25
5.4 TEST SETUP	25

Table of Contents	Page
5.5 EUT OPERATION CONDITIONS	25
5.6 TEST RESULTS	25
6 . MAXIMUM OUTPUT POWER TEST	26
6.1 LIMIT	26
6.2 TEST PROCEDURE	26
6.3 DEVIATION FROM STANDARD	26
6.4 TEST SETUP	26
6.5 EUT OPERATION CONDITIONS	26
6.6 TEST RESULTS	26
7 . CONDUCTED SPURIOUS EMISSIONS	27
7.1 LIMIT	27
7.2 TEST PROCEDURE	27
7.3 DEVIATION FROM STANDARD	27
7.4 TEST SETUP	27
7.5 EUT OPERATION CONDITIONS	27
7.6 TEST RESULTS	27
8 . POWER SPECTRAL DENSITY TEST	28
8.1 LIMIT	28
8.2 TEST PROCEDURE	28
8.3 DEVIATION FROM STANDARD	28
8.4 TEST SETUP	28
8.5 EUT OPERATION CONDITIONS	28
8.6 TEST RESULTS	28
9 . MEASUREMENT INSTRUMENTS LIST	29
10 . EUT TEST PHOTO	31
APPENDIX A - AC POWER LINE CONDUCTED EMISSIONS	34
APPENDIX B - RADIATED EMISSION - 9 KHZ TO 30 MHZ	37
APPENDIX C - RADIATED EMISSION - 30 MHZ TO 1000 MHZ	38
APPENDIX D - RADIATED EMISSION- ABOVE 1000 MHZ	41
APPENDIX E - BANDWIDTH	259
APPENDIX F - MAXIMUM OUTPUT POWER	272
APPENDIX G - CONDUCTED SPURIOUS EMISSIONS	289

Table of Contents	Page
APPENDIX H - POWER SPECTRAL DENSITY	314

REPORT ISSUED HISTORY

Report Version	Description	Issued Date
R00	Original Issue.	Sep. 04, 2020

1. SUMMARY OF TEST RESULTS

Test procedures according to the technical standard(s):

FCC Part15, Subpart C (15.247)				
Standard(s) Section	Test Item	Test Result	Judgment	Remark
15.207	AC Power Line Conducted Emissions	APPENDIX A	PASS	-----
15.247(d) 15.205(a) 15.209(a)	Radiated Emissions	APPENDIX B APPENDIX C APPENDIX D	PASS	-----
15.247(a)(2)	Bandwidth	APPENDIX E	PASS	-----
15.247(b)(3)	Maximum Output Power	APPENDIX F	PASS	-----
15.247(d)	Conducted Spurious Emissions	APPENDIX G	PASS	-----
15.247(e)	Power Spectral Density	APPENDIX H	PASS	-----
15.203	Antenna Requirement	-----	PASS	Note(2)

Note:

- (1) "N/A" denotes test is not applicable in this test report.
- (2) The device what use a permanently attached antenna were considered sufficient to comply with the provisions of 15.203.

1.1 TEST FACILITY

The test facilities used to collect the test data in this report is at the location of No. 29, Jintang Road, Tangzhen Industry Park, Pudong New Area, Shanghai 201210, China
 BTL's Test Firm Registration Number for FCC: 476765
 BTL's Designation Number for FCC: CN1241

1.2 MEASUREMENT UNCERTAINTY

ISO/IEC 17025 requires that an estimate of the measurement uncertainties associated with the emissions test results be included in the report. The measurement uncertainties given below are based on a 95% confidence level (based on a coverage factor (k=2))
 The BTL measurement uncertainty as below table:

A. AC power line conducted emissions test:

Test Site	Method	Measurement Frequency Range	U, (dB)
SH-C01	CISPR	150 kHz ~ 30 MHz	2.70

B. Radiated emissions test:

Test Site	Method	Measurement Frequency Range	Ant. H / V	U, (dB)
SH-CB01	CISPR	9 KHz~30 MHz	V	3.79
		9 KHz~30 MHz	H	3.57
		30 MHz~200 MHz	V	4.04
		30 MHz~200 MHz	H	3.76
		200 MHz~1,000 MHz	V	4.24
		200 MHz~1,000 MHz	H	3.84
		1 GHz~18 GHz	V	4.46
		1 GHz~18 GHz	H	4.40
		18 GHz~40 GHz	V	3.95
		18 GHz~40 GHz	H	3.95

Note: Unless specifically mentioned, the uncertainty of measurement has not been taken into account to declare the compliance or non-compliance to the specification.

1.3 TEST ENVIRONMENT CONDITIONS

Test Item	Temperature	Humidity	Test Voltage	Tested By
AC Power Line Conducted Emissions	24°C	58%	AC 120V/60Hz	Vince Zong
Radiated Emissions-30 MHz to 1GHz	24°C	58%	AC 120V/60Hz	Vince Zong
Radiated Emissions-Above 1000 MHz	24°C	58%	AC 120V/60Hz	Vince Zong
Bandwidth	24°C	56%	DC 12V	Bill Dong
Maximum output power	24°C	56%	DC 12V	Bill Dong
Conducted Spurious Emissions	24°C	56%	DC 12V	Bill Dong
Power Spectral Density	24°C	56%	DC 12V	Vince Zong

2. GENERAL INFORMATION

2.1 GENERAL DESCRIPTION OF EUT

Equipment	AI-Powered NAS with Tri-Band Mesh WiFi Router
Brand Name	QNAP
Test Model	QMiroPlus-201W
Series Model	N/A
Model Difference(s)	N/A
Power Source	DC voltage supplied from DC adapter. #1: DPS-65VB #2: EA10731J-120
Power Rating	#1: I/P:100-240V ~ 50-60Hz 2.0A O/P: 12V \equiv 5.417A Max #2: I/P:100-240V ~ 50-60Hz 2.0A O/P: 12V \equiv 5.0A 60.0W
Operation Frequency	2412 MHz ~ 2462 MHz
Modulation Type	IEEE 802.11b: DSSS IEEE 802.11g: OFDM IEEE 802.11n: OFDM IEEE 802.11ac: OFDM
Bit Rate of Transmitter	IEEE 802.11b: 11/5.5/2/1 Mbps IEEE 802.11g: 54/48/36/24/18/12/9/6 Mbps IEEE 802.11n: up to 300 Mbps IEEE 802.11ac: up to 400 Mbps
Maximum Output Power CDD	IEEE 802.11b: 24.51 dBm (0.2825 W) for Ant. 1 IEEE 802.11g: 23.93 dBm (0.2472 W) for Ant. 1 IEEE 802.11n (HT20): 23.81 dBm (0.2404 W) for Ant. 1 IEEE 802.11n (HT40): 20.15 dBm (0.1035 W) for Ant. 1 IEEE 802.11ac (VHT20): 23.84 dBm (0.2421 W) for Ant. 1 IEEE 802.11ac (VHT40):19.44 dBm (0.0879 W) for Ant. 1 IEEE 802.11b: 24.53 dBm (0.2838 W) for Ant. 2 IEEE 802.11g: 22.75 dBm (0.1884 W) for Ant.2 IEEE 802.11n (HT20): 22.67 dBm (0.1849 W) for Ant. 2 IEEE 802.11n (HT40): 16.73 dBm (0.0471 W) for Ant. 2 IEEE 802.11ac (VHT20): 23.44 dBm (0.2208 W) for Ant. 2 IEEE 802.11ac (VHT40):17.80 dBm (0.0603 W) for Ant. 2 IEEE 802.11b: 27.56 dBm (0.5702 W) for Ant. 1+ Ant. 2 IEEE 802.11g: 25.05 dBm (0.3199 W) for Ant. 1+ Ant. 2 IEEE 802.11n (HT20): 26.12 dBm (0.4093 W) for Ant. 1+ Ant. 2 IEEE 802.11n (HT40): 21.89 dBm (0.1545 W) for Ant. 1+ Ant. 2 IEEE 802.11ac (VHT20): 25.64 dBm (0.3664 W) for Ant. 1+ Ant. 2 IEEE 802.11ac (VHT40): 21.99 dBm (0.1581 W) for Ant. 1+ Ant. 2
Maximum Output Power Beamforming	IEEE 802.11b: 26.38 dBm (0.4345 W) for Ant. 1+ Ant. 2 IEEE 802.11g: 24.98 dBm (0.3148 W) for Ant. 1+ Ant. 2 IEEE 802.11n (HT20): 25.99 dBm (0.3972 W) for Ant. 1+ Ant. 2 IEEE 802.11n (HT40): 21.75 dBm (0.1496 W) for Ant. 1+ Ant. 2 IEEE 802.11ac (VHT20): 25.42 dBm (0.3483 W) for Ant. 1+ Ant. 2 IEEE 802.11ac (VHT40):21.62 dBm (0.1452 W) for Ant. 1+ Ant. 2

Note:

- For a more detailed features description, please refer to the manufacturer's specifications or the user's manual.

2. Channel List:

CH01 - CH11 for IEEE 802.11b, IEEE 802.11g, IEEE 802.11n (HT20), IEEE 802.11ac (VHT20) CH03 - CH09 for IEEE 802.11n (HT40), IEEE 802.11ac (VHT40)							
Channel	Frequency (MHz)	Channel	Frequency (MHz)	Channel	Frequency (MHz)	Channel	Frequency (MHz)
01	2412	04	2427	07	2442	10	2457
02	2417	05	2432	08	2447	11	2462
03	2422	06	2437	09	2452		

3. Antenna Specification:

Ant.	Brand	Model Name	Antenna Type	Connector	Gain (dBi)	Note
1	GALTRONICS	N/A	PCB	N/A	2.54	N/A
2	GALTRONICS	N/A	PCB	N/A	2.62	N/A

Note:

This EUT supports CDD, all antenna gains are not equal,
so Directional gain = $10\log [(10^{G1/20} + 10^{G2/20} + \dots + 10^{GN/20})^2 / N]$ dBi,
(1) CDD:

For power spectral density measurements, Directional gain = $10\log [(10^{G1/20} + 10^{G2/20} + \dots + 10^{GN/20})^2 / N]$ dBi.
that is Directional gain = $10\log [(10^{2.54/20} + 10^{2.62/20})^2 / 2] = 5.59$

For power measurements, Directional gain = $G_{ANT\ MAX} + \text{Array Gain}$, Array Gain = 0 dB ($N_{ANT} \leq 4$), so the Directional gain = 2.62

(2) Beamforming:

Directional gain = $10\log [(10^{G1/20} + 10^{G2/20} + \dots + 10^{GN/20})^2 / N]$ dBi = $10\log [(10^{2.54/20} + 10^{2.62/20})^2 / 2] = 5.59$

4. Table for Antenna Configuration:

For CDD

Operating Mode TX Mode	1TX	2TX
802.11b	V (Ant. 1 or Ant. 2)	V (Ant. 1 + Ant. 2)
802.11g	V (Ant. 1 or Ant. 2)	V (Ant. 1 + Ant. 2)
802.11n(20 MHz)	V (Ant. 1 or Ant. 2)	V (Ant. 1 + Ant. 2)
802.11n(40 MHz)	V (Ant. 1 or Ant. 2)	V (Ant. 1 + Ant. 2)
802.11ac(20 MHz)	V (Ant. 1 or Ant. 2)	V (Ant. 1 + Ant. 2)
802.11ac(40 MHz)	V (Ant. 1 or Ant. 2)	V (Ant. 1 + Ant. 2)

For Beamforming

Operating Mode TX Mode	2TX
802.11b	V (Ant. 1 + Ant. 2)
802.11g	V (Ant. 1 + Ant. 2)
802.11n(20 MHz)	V (Ant. 1 + Ant. 2)
802.11n(40 MHz)	V (Ant. 1 + Ant. 2)
802.11ac(20 MHz)	V (Ant. 1 + Ant. 2)
802.11ac(40 MHz)	V (Ant. 1 + Ant. 2)

2.2 DESCRIPTION OF TEST MODES

The test system was pre-tested based on the consideration of all possible combinations of EUT operation mode.

Pretest Mode	Description
Mode 1	TX B Mode Channel 01/06/11
Mode 2	TX G Mode Channel 01/06/11
Mode 3	TX N-20 MHz Mode Channel 01/06/11
Mode 4	TX N-40 MHz Mode Channel 03/06/09
Mode 5	TX AC-20 MHz Mode Channel 01/06/11
Mode 6	TX AC-40 MHz Mode Channel 03/06/09
Mode 7	TX B Mode Channel 11

Following mode(s) was (were) found to be the worst case(s) and selected for the final test.

AC power line conducted emissions test	
Final Test Mode	Description
Mode 7	TX B Mode Channel 11

Radiated emissions test - Below 1GHz	
Final Test Mode	Description
Mode 7	TX B Mode Channel 11

Radiated emissions test- Above 1GHz	
Final Test Mode	Description
Mode 1	TX B Mode Channel 01/06/11
Mode 2	TX G Mode Channel 01/06/11
Mode 3	TX N-20 MHz Mode Channel 01/06/11
Mode 4	TX N-40 MHz Mode Channel 03/06/09
Mode 5	TX AC-20 MHz Mode Channel 01/06/11
Mode 6	TX AC-40 MHz Mode Channel 03/06/09

Conducted test	
Final Test Mode	Description
Mode 1	TX B Mode Channel 01/06/11
Mode 2	TX G Mode Channel 01/06/11
Mode 3	TX N-20 MHz Mode Channel 01/06/11
Mode 4	TX N-40 MHz Mode Channel 03/06/09
Mode 5	TX AC-20 MHz Mode Channel 01/06/11
Mode 6	TX AC-40 MHz Mode Channel 03/06/09

NOTE:

- (1) The measurements are performed at the high, middle, low available channels.
- (2) 802.11b mode: CCK (1 Mbps)
802.11g mode: OFDM (6 Mbps)
802.11n HT20 mode : BPSK (13 Mbps)
802.11n HT40 mode : BPSK (27 Mbps)
802.11ac VHT20 mode : BPSK (13 Mbps)
802.11ac VHT40 mode : BPSK (27 Mbps)
For radiated emission tests, the highest output powers were set for final test.
- (3) For radiated emission below 1 GHz test, the IEEE 802.11b Channel 11 is found to be the worst case and recorded.
- (4) For radiated emission above 1 GHz test, 1GHz~26.5GHz have been pre-tested and in this report only recorded the worst case. The remaining spurious points are all below the limit value of 20dB.

2.3 PARAMETERS OF TEST SOFTWARE
CDD
For Ant. 1

Test Software	QRCT		
Frequency (MHz)	2412	2437	2462
IEEE 802.11b	24	24	24
IEEE 802.11g	19	24	20
IEEE 802.11n (HT20)	19	24	19.5
IEEE 802.11ac (VHT20)	19	24	17.5
Frequency (MHz)	2422	2437	2452
IEEE 802.11n (HT40)	18	20	18.5
IEEE 802.11ac (VHT40)	16	19	17

For Ant. 2

Test Software	QRCT		
Frequency (MHz)	2412	2437	2462
IEEE 802.11b	24	24	24
IEEE 802.11g	17	23	17
IEEE 802.11n (HT20)	16	23	16
IEEE 802.11ac (VHT20)	16	23	24
Frequency (MHz)	2422	2437	2452
IEEE 802.11n (HT40)	14	17	15
IEEE 802.11ac (VHT40)	14	18	15

For Ant. 1 + Ant. 2

Test Software	QRCT		
Frequency (MHz)	2412	2437	2462
IEEE 802.11b	24	24	24
IEEE 802.11g	19	23.5	18
IEEE 802.11n (HT20)	17	23.5	16.5
IEEE 802.11ac (VHT20)	17	23.5	16.5
Frequency (MHz)	2422	2437	2452
IEEE 802.11n (HT40)	15	19	16
IEEE 802.11ac (VHT40)	15	19	16

Beamforming

Test Software	QRCT		
Frequency (MHz)	2412	2437	2462
IEEE 802.11b	23	23	23
IEEE 802.11g	19	23.5	18
IEEE 802.11n (HT20)	17	23.5	16.5
IEEE 802.11ac (VHT20)	17	23.5	16.5
Frequency (MHz)	2422	2437	2452
IEEE 802.11n (HT40)	15	19	16
IEEE 802.11ac (VHT40)	15	19	16

2.4 DUTY CYCLE

If duty cycle is $\geq 98\%$, duty factor is not required.
 If duty cycle is $< 98\%$, duty factor shall be considered.
 The output power = measured power + duty factor.

IEEE 802.11b

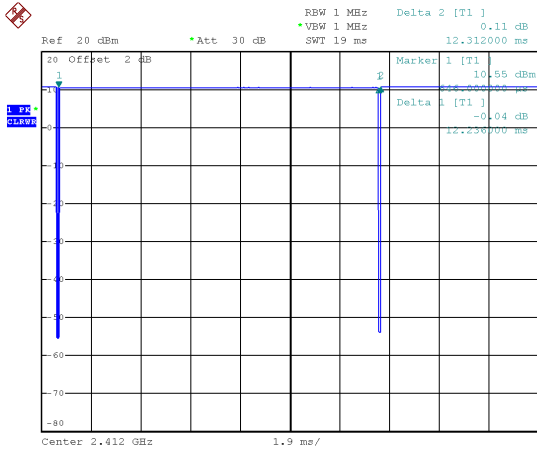

Date: 8.JUN.2020 21:54:49

Duty cycle = $12.236 \text{ ms} / 12.312 \text{ ms} = 99.38\%$
 Duty Factor = $10 \log(1/\text{Duty cycle}) = 0.00$

IEEE 802.11n (HT20)

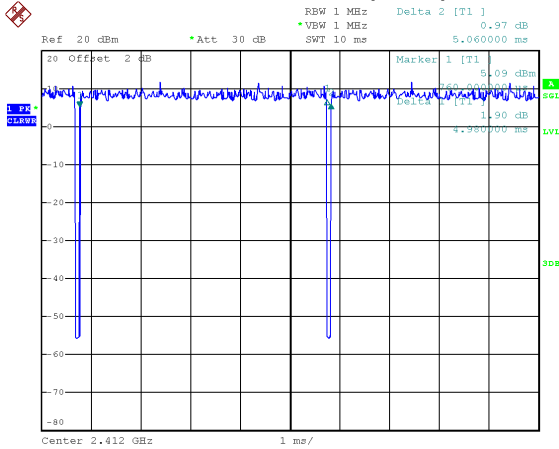

Date: 8.JUN.2020 21:56:09

Duty cycle = $4.980 \text{ ms} / 5.060 \text{ ms} = 98.42\%$
 Duty Factor = $10 \log(1/\text{Duty cycle}) = 0.00$

IEEE 802.11g

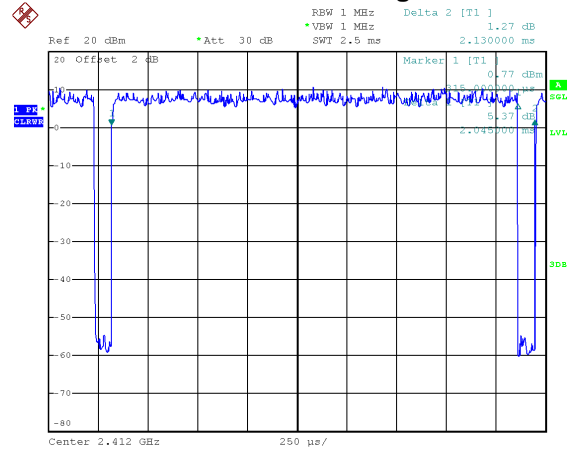

Date: 8.JUN.2020 21:55:20

Duty cycle = $2.045 \text{ ms} / 2.130 \text{ ms} = 96.01\%$
 Duty Factor = $10 \log(1/\text{Duty cycle}) = 0.18$

IEEE 802.11n (HT40)

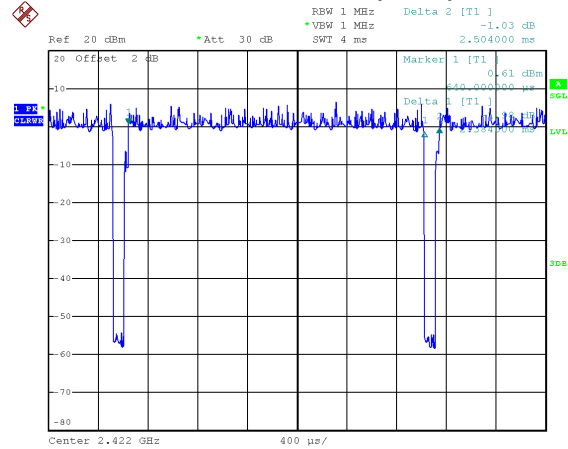

Date: 8.JUN.2020 21:57:20

Duty cycle = $2.384 \text{ ms} / 2.504 \text{ ms} = 95.21\%$
 Duty Factor = $10 \log(1/\text{Duty cycle}) = 0.21$

IEEE 802.11ac (VHT20)

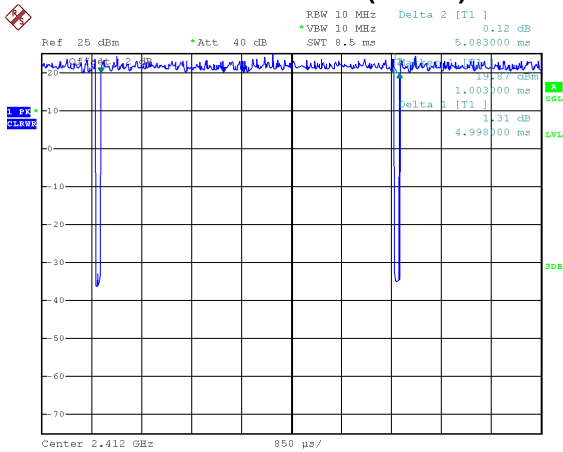

Date: 22.JUN.2020 16:28:13

Duty cycle = $4.998 \text{ ms} / 5.083 \text{ ms} = 98.33\%$
 Duty Factor = $10 \log(1/\text{Duty cycle}) = 0.00$

IEEE 802.11ac (VHT40)

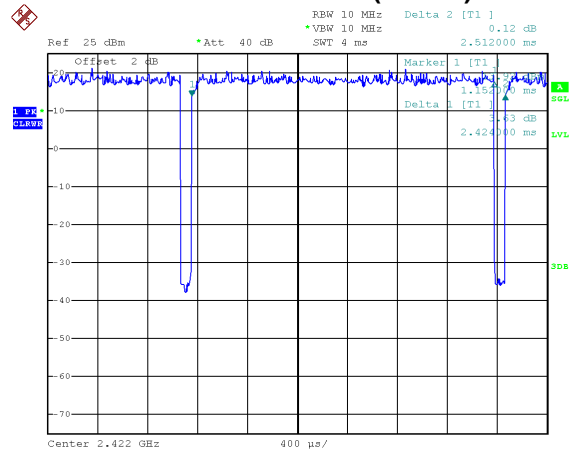

Date: 22.JUN.2020 16:29:43

Duty cycle = $2.424 \text{ ms} / 2.512 \text{ ms} = 96.50\%$
 Duty Factor = $10 \log(1/\text{Duty cycle}) = 0.15$

NOTE:

For IEEE 802.11g and IEEE 802.11n (HT20) and IEEE 802.11ac (VHT20):
 For radiated emissions frequency above 1 GHz, the resolution bandwidth of test receiver/spectrum analyzer is 1 MHz and the video bandwidth is 1 kHz (Duty cycle < 98%).

For IEEE 802.11n (HT40) and IEEE 802.11ac (VHT40):
 For radiated emissions frequency above 1 GHz, the resolution bandwidth of test receiver/spectrum analyzer is 1 MHz and the video bandwidth is 2 kHz (Duty cycle < 98%).

2.5 BLOCK DIAGRAM SHOWING THE CONFIGURATION OF SYSTEM TESTED

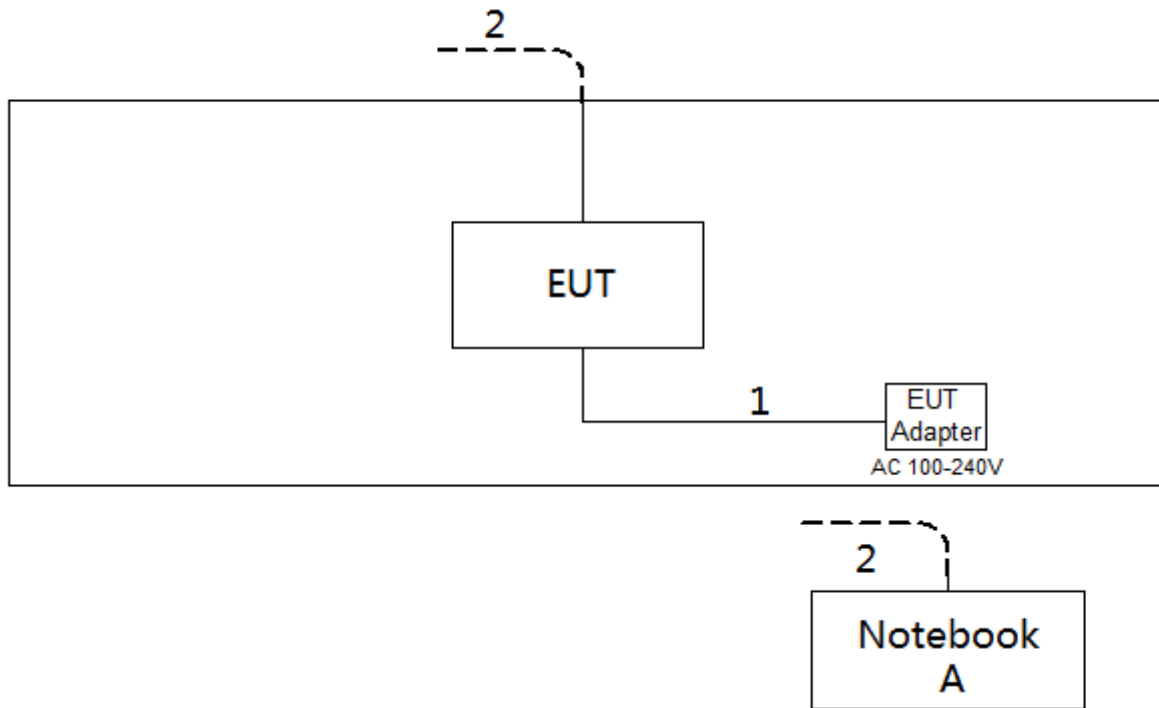

2.6 SUPPORT UNITS

Item	Equipment	Brand	Model No.	Series No.
A	Notebook	Dell	Inspiron 15-7559	N/A

Item	Cable Type	Shielded Type	Ferrite Core	Length
1	DC Cable	NO	NO	1.5m
2	RJ45 Cable	NO	NO	10m

3. AC POWER LINE CONDUCTED EMISSIONS TEST

3.1 LIMIT

Frequency of Emission (MHz)	Limit (dB μ V)	
	Quasi-peak	Average
0.15 - 0.50	66 to 56*	56 to 46*
0.5 - 5.0	56	46
5.0 - 30.0	60	50

NOTE:

- (1) The tighter limit applies at the band edges.
- (2) The limit of " * " marked band means the limitation decreases linearly with the logarithm of the frequency in the range.

The following table is the setting of the receiver

Receiver Parameters	Setting
Attenuation	10 dB
Start Frequency	0.15 MHz
Stop Frequency	30 MHz
IF Bandwidth	9 kHz

3.2 TEST PROCEDURE

- a. The EUT was placed 0.8 meters from the horizontal ground plane with EUT being connected to the power mains through a line impedance stabilization network (LISN). All other support equipment powered from additional LISN(s). The LISN provide 50 Ohm/ 50uH of coupling impedance for the measuring instrument.
- b. Interconnecting cables that hang closer than 40 cm to the ground plane shall be folded back and forth in the center forming a bundle 30 to 40 cm long.
- c. I/O cables that are not connected to a peripheral shall be bundled in the center. The end of the cable may be terminated, if required, using the correct terminating impedance. The overall length shall not exceed 1 m.
- d. LISN at least 80 cm from nearest part of EUT chassis.
- e. For the actual test configuration, please refer to the related Item -EUT Test Photos.

3.3 DEVIATION FROM TEST STANDARD

No deviation

3.4 TEST SETUP

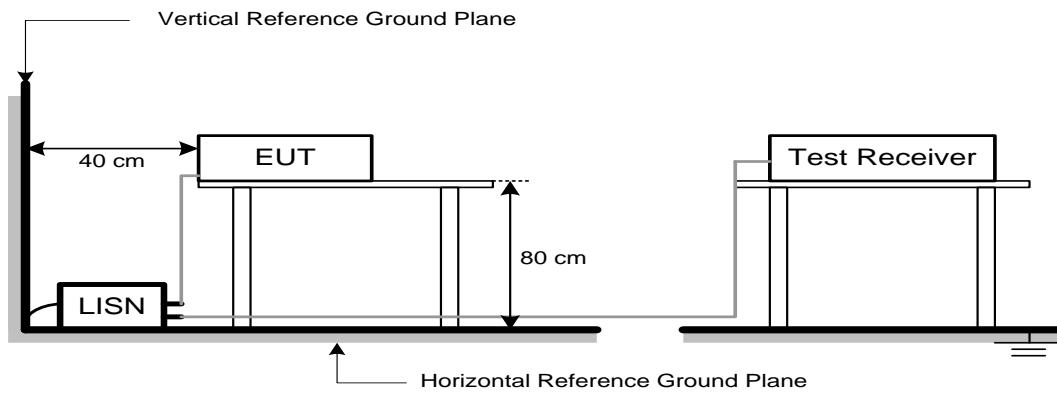

3.5 EUT OPERATION CONDITIONS

EUT was programmed to be in continuously transmitting mode.

3.6 TEST RESULTS

Please refer to the APPENDIX A.

4. RADIATED EMISSIONS TEST

4.1 LIMIT

In case the emission fall within the restricted band specified on 15.205(a), then the 15.209(a) limit in the table below has to be followed.

LIMITS OF RADIATED EMISSION MEASUREMENT (9 kHz-1000 MHz)

Frequency (MHz)	Field Strength (microvolts/meter)	Measurement Distance (meters)
0.009-0.490	2400/F(kHz)	300
0.490-1.705	24000/F(kHz)	30
1.705-30.0	30	30
30-88	100	3
88-216	150	3
216-960	200	3
Above 960	500	3

LIMITS OF RADIATED EMISSION MEASUREMENT (Above 1000 MHz)

Frequency (MHz)	(dBuV/m at 3 m)	
	Peak	Average
Above 1000	74	54

NOTE:

- (1) The limit for radiated test was performed according to FCC PART 15C.
- (2) The tighter limit applies at the band edges.
- (3) Emission level (dBuV/m)=20log Emission level (uV/m).

Spectrum Parameter	Setting
Attenuation	Auto
Start Frequency	1000 MHz
Stop Frequency	10th carrier harmonic
RBW / VBW (Emission in restricted band)	1 MHz / 3 MHz for Peak, 1 MHz / 1/T for Average

Receiver Parameter	Setting
Attenuation	Auto
Start ~ Stop Frequency	9 kHz~90 kHz for PK/AVG detector
Start ~ Stop Frequency	90 kHz~110 kHz for QP detector
Start ~ Stop Frequency	110 kHz~490 kHz for PK/AVG detector
Start ~ Stop Frequency	490 kHz~30 MHz for QP detector
Start ~ Stop Frequency	30 MHz~1000 MHz for QP detector

4.2 TEST PROCEDURE

- a. The measuring distance of 3 m shall be used for measurements. The EUT was placed on the top of a rotating table 0.8 meter above the ground at a 3 meter semi-anechoic chamber. The table was rotated 360 degrees to determine the position of the highest radiation.(below 1 GHz)
- b. The measuring distance of 3 m shall be used for measurements. The EUT was placed on the top of a rotating table 1.5 meter above the ground at a 3 meter semi-anechoic chamber. The table was rotated 360 degrees to determine the position of the highest radiation.(above 1 GHz)
- c. The height of the equipment or of the substitution antenna shall be 0.8m or 1.5m; the height of the test antenna shall vary between 1 m to 4 m. Both horizontal and vertical polarizations of the antenna are set to make the measurement.
- d. For each suspected emission, the EUT was arranged to its worst case and then the antenna was tuned to heights find the maximum reading (used Bore sight function).
- e. The receiver system was set to peak and average detect function and specified bandwidth with maximum hold mode when the test frequency is above 1 GHz.
- f. The initial step in collecting radiated emission data is a receiver peak detector mode pre-scanning the measurement frequency range. Significant peaks are then marked and then Quasi Peak detector mode re-measured.
- g. All readings are Peak unless otherwise stated QP in column of Note. Peak denotes that the Peak reading compliance with the QP Limits and then QP Mode measurement didn't perform.
(below 1 GHz)
- h. All readings are Peak Mode value unless otherwise stated AVG in column of Note. If the Peak Mode Measured value compliance with the Peak Limits and lower than AVG Limits, the EUT shall be deemed to meet both Peak & AVG Limits and then only Peak Mode was measured, but AVG Mode didn't perform. (above 1 GHz)
- i. For the actual test configuration, please refer to the related Item -EUT Test Photos.

4.3 DEVIATION FROM TEST STANDARD

No deviation

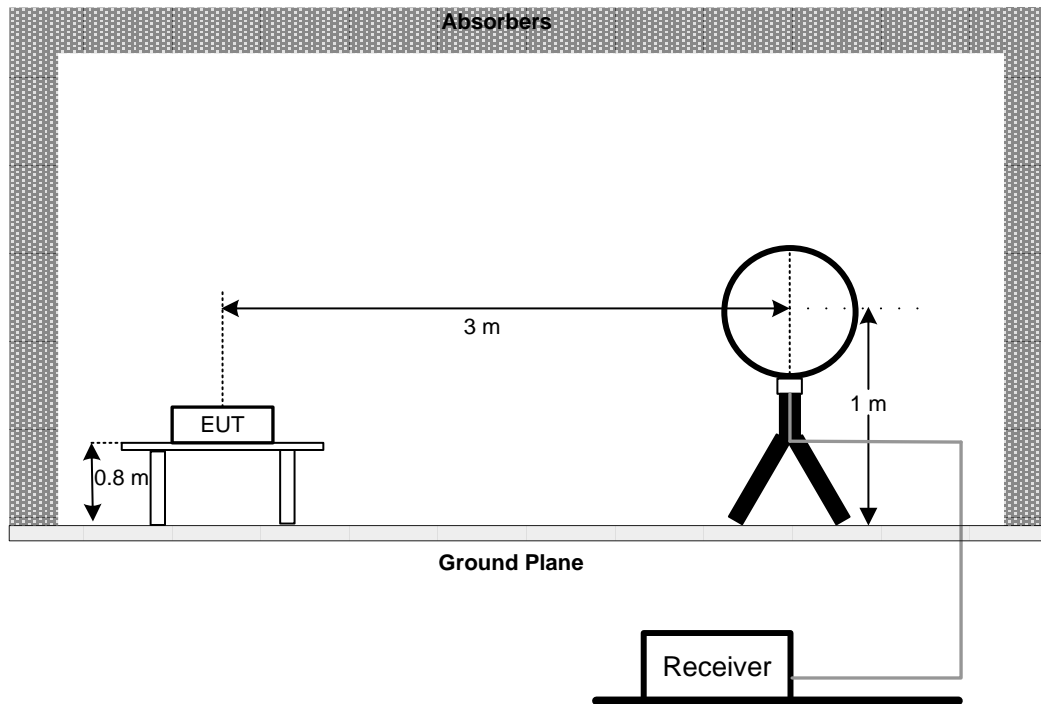
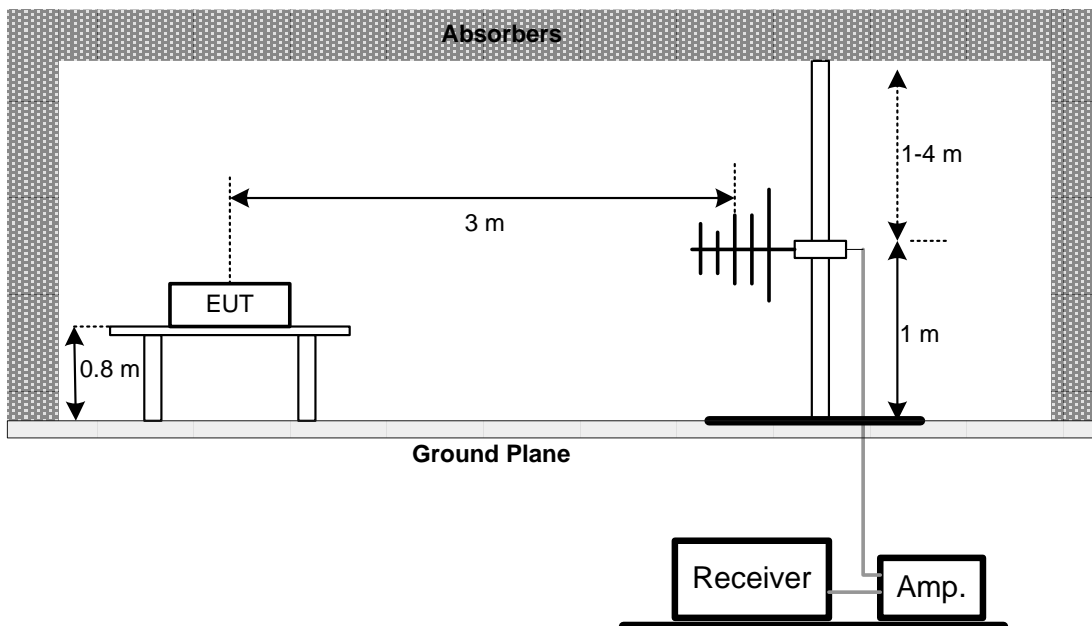
4.4 TEST SETUP**9 kHz-30 MHz****30 MHz to 1 GHz**

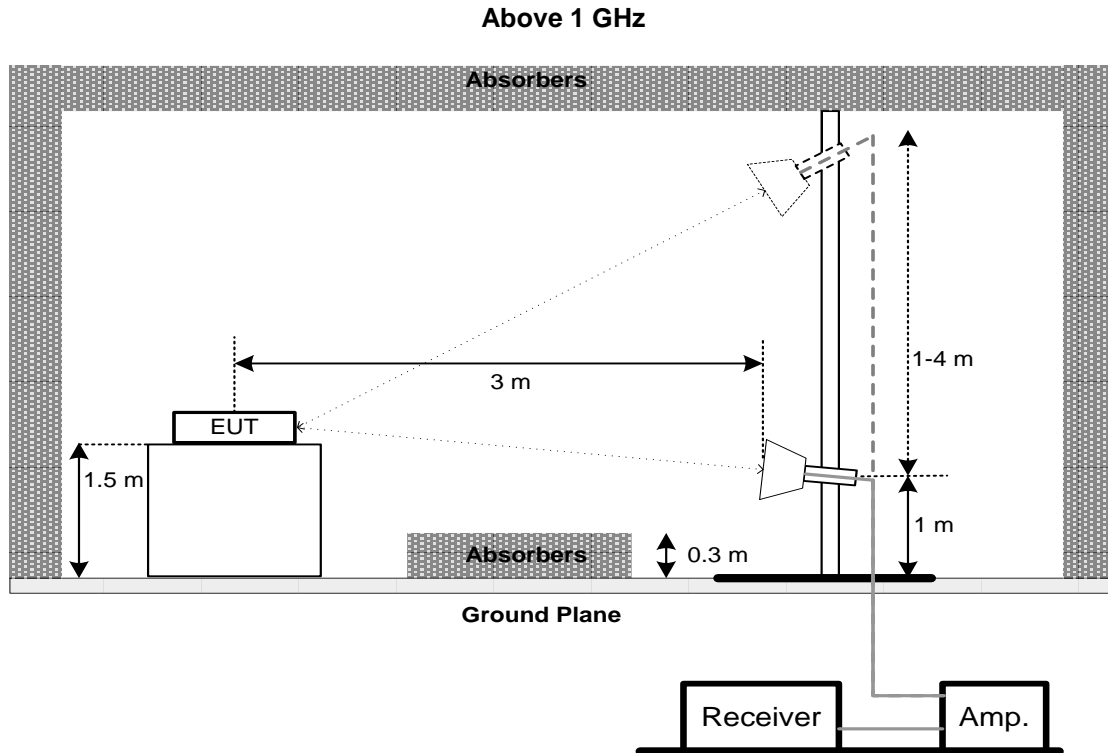

4.5 EUT OPERATION CONDITIONS

The EUT was programmed to be in continuously transmitting mode.

4.6 TEST RESULTS - 9 KHZ TO 30 MHZ

Please refer to the APPENDIX B

Remark:

- (1) Distance extrapolation factor = $40 \log (\text{specific distance} / \text{test distance})$ (dB).
- (2) Limit line = specific limits (dBuV) + distance extrapolation factor.

4.7 TEST RESULTS - 30 MHZ TO 1000 MHZ

Please refer to the APPENDIX C.

4.8 TEST RESULTS - ABOVE 1000 MHZ

Please refer to the APPENDIX D.

Remark:

- (1) No limit: This is fundamental signal, the judgment is not applicable.
For fundamental signal judgment was referred to Peak output test.

5. BANDWIDTH TEST

5.1 LIMIT

FCC Part15, Subpart C (15.247)		
Section	Test Item	Limit
15.247(a)(2)	6 dB Bandwidth	Minimum 500 kHz
	99% Emission Bandwidth	-

5.2 TEST PROCEDURE

- a. The EUT was directly connected to the spectrum analyzer and antenna output port as show in the block diagram below.
- b. Spectrum Setting:
 For 6 dB Bandwidth : RBW= 100 kHz, VBW=300 kHz, Sweep time = auto.
 For 99% Emission Bandwidth B/G/N-20 Mode: RBW= 300 KHz, VBW=1 MHz, Sweep time = 2.5 ms.
- c. The bandwidth was performed in accordance with method 11.8.1 of ANSI C63.10-2013.

5.3 DEVIATION FROM STANDARD

No deviation.

5.4 TEST SETUP



5.5 EUT OPERATION CONDITIONS

The EUT was programmed to be in continuously transmitting mode.

5.6 TEST RESULTS

Please refer to the APPENDIX E.

6. MAXIMUM OUTPUT POWER TEST

6.1 LIMIT

FCC Part15, Subpart C (15.247)		
Section	Test Item	Limit
15.247(b)(3)	Maximum Output Power	1 Watt or 30dBm

6.2 TEST PROCEDURE

- The EUT was directly connected to the power meter and antenna output port as show in the block diagram below.
- The maximum conducted output power was performed in accordance with method 11.9.1.3 (for peak power) or 11.9.2.3.1 (for AVG power) of ANSI C63.10-2013 and FCC KDB 662911 D01 v02r01 Multiple Transmitter Output.

6.3 DEVIATION FROM STANDARD

No deviation.

6.4 TEST SETUP

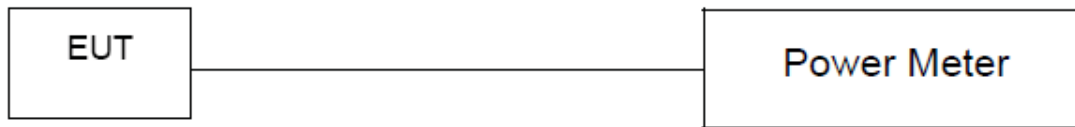

6.5 EUT OPERATION CONDITIONS

The EUT was programmed to be in continuously transmitting mode.

6.6 TEST RESULTS

Please refer to the APPENDIX F.

7. CONDUCTED SPURIOUS EMISSIONS

7.1 LIMIT

In any 100 kHz bandwidth outside the frequency band in which the spread spectrum or digitally modulated intentional radiator is operating, the radio frequency power that is produced by the intentional radiator shall be at least 20 dB below that in the 100 kHz bandwidth within the band that contains the highest level of the desired power, based on either an RF conducted or a radiated measurement, provided the transmitter demonstrates compliance with the peak Output Power limits. If the transmitter complies with the Output Power limits based on the use of RMS averaging over a time interval, as permitted under paragraph (b)(3) of this section, the attenuation required under this paragraph shall be 30 dB instead of 20 dB. Attenuation below the general limits specified in Section 15.209(a) is not required.

7.2 TEST PROCEDURE

- a. The EUT was directly connected to the spectrum analyzer and antenna output port as show in the block diagram below.
- b. Spectrum Setting: RBW= 100 kHz, VBW=300 kHz, Sweep time = Auto.

7.3 DEVIATION FROM STANDARD

No deviation.

7.4 TEST SETUP



7.5 EUT OPERATION CONDITIONS

The EUT was programmed to be in continuously transmitting mode.

7.6 TEST RESULTS

Please refer to the APPENDIX G.

8. POWER SPECTRAL DENSITY TEST

8.1 LIMIT

FCC Part15, Subpart C (15.247)		
Section	Test Item	Limit
15.247(e)	Power Spectral Density	8 dBm (in any 3 kHz)

8.2 TEST PROCEDURE

- The EUT was directly connected to the spectrum analyzer and antenna output port as show in the block diagram below.
- Spectrum Setting: RBW=3 kHz, VBW=10 kHz, Sweep time = Auto.
- The Power Spectral Density was performed in accordance with method 11.10.2 of ANSI C63.10-2013.

8.3 DEVIATION FROM STANDARD

No deviation.

8.4 TEST SETUP



8.5 EUT OPERATION CONDITIONS

The EUT was programmed to be in continuously transmitting mode.

8.6 TEST RESULTS

Please refer to the APPENDIX H.

9. MEASUREMENT INSTRUMENTS LIST

AC Power Line Conducted Emissions					
Item	Kind of Equipment	Manufacturer	Type No.	Serial No.	Calibrated until
1	Line Impedance Stabilisation Network	Schwarzbeck	NNLK 8121	8121-822	Mar. 21, 2021
2	TWO-LINE V-NETWORK	R&S	ENV216	101340	Sep. 01, 2020
3	Test Cable	emci	EMCRG400-BM-N M-10000	170628	Jul. 15, 2021
4	EMI Test Receiver	R&S	ESCI	100082	Mar. 21, 2021
5	50Ω Terminator	SHX	TF2-1G-A	17051602	Mar. 21, 2021
6	50Ω coaxial switch	Anritsu	MP59B	6201750902	Mar. 21, 2021
7	Measurement Software	Farad	EZ-EMC Ver.NB-03A1-01	N/A	N/A

Radiated Emissions - 9 kHz to 30 MHz					
Item	Kind of Equipment	Manufacturer	Type No.	Serial No.	Calibrated until
1	Loop Antenna	EMCI	EMCI LPA600	275	Apr. 02, 2021
2	EMI Test Receiver	R&S	ESCI	100082	Mar. 21, 2021
3	Measurement Software	Farad	EZ-EMC Ver.NB-03A1-01	N/A	N/A

Radiated Emissions - 30 MHz to 1 GHz					
Item	Kind of Equipment	Manufacturer	Type No.	Serial No.	Calibrated until
1	TRILOG Broadband Antenna	Schwarzbeck	VULB 9168	719	Apr. 02, 2021
2	Pre-Amplifier	emci	EMC9135	980400	Mar. 21, 2021
3	MXE EMI Receiver	Keysight	N9038A	MY57150106	May. 06, 2021
4	Test Cable	emci	EMC104-SM-SM-7000	170330	Apr. 13, 2021
5	Test Cable	emci	EMC104-SM-SM-1000	170331	Apr. 13, 2021
6	Test Cable	emci	EMC104-SM-NM-3500	170621	Apr. 13, 2021
7	Measurement Software	Farad	EZ-EMC Ver.NB-03A1-01	N/A	N/A

Radiated Emissions - Above 1 GHz					
Item	Kind of Equipment	Manufacturer	Type No.	Serial No.	Calibrated until
1	Double-Ridged Waveguide Horn Antenna	ETS-Lindgren	9120D	00206960	Apr. 02, 2021
2	Pre-Amplifier	emci	EMC012645SE	980421	May. 11, 2021
3	EXA Spectrum Analyzer	Keysight	N9010A	MY56480545	Mar. 21, 2021
4	Test Cable	emci	EMC104-SM-SM-7000	170330	Apr. 13, 2021
5	Test Cable	emci	EMC104-SM-SM-1000	170331	Apr. 13, 2021
6	Test Cable	emci	EMC104-SM-NM-3500	170621	Apr. 13, 2021
7	Measurement Software	Farad	EZ-EMC Ver.NB-03A1-01	N/A	N/A
8	MXE EMI Receiver	Keysight	N9038A	MY57150106	May. 06, 2021
9	Double-Ridged Waveguide Horn Antenna	ETS-Lindgren	3116C	00203919	Mar. 21, 2021
10	Pre-Amplifier	emci	EMC184045SE	980409	Mar. 21, 2021
11	EXA Spectrum Analyzer	Keysight	N9010A	MY56480579	Mar. 21, 2021
12	Test Cable	emci	EMC102-KM-KM-800	170654	Mar. 21, 2021
13	Test Cable	emci	Super Reliable-40G-SS11-7000	W0030860001	Mar. 21, 2021
14	Measurement Software	Farad	EZ-EMC Ver.NB-03A1-01	N/A	N/A

Bandwidth					
Item	Kind of Equipment	Manufacturer	Type No.	Serial No.	Calibrated until
1	Spectrum Analyzer	R&S	FSP40	100626	Mar. 06, 2021

Maximum Output Power					
Item	Kind of Equipment	Manufacturer	Type No.	Serial No.	Calibrated until
1	Peak Power Analyze	Keysight	8990B	MY51000507	Mar. 21, 2021
2	Wideband Power Sensor	Keysight	N9123A	MY58310003	Mar. 21, 2021

Antenna Conducted Spurious Emissions					
Item	Kind of Equipment	Manufacturer	Type No.	Serial No.	Calibrated until
1	Spectrum Analyzer	R&S	FSP40	100626	Mar. 06, 2021

Power Spectral Density					
Item	Kind of Equipment	Manufacturer	Type No.	Serial No.	Calibrated until
1	Spectrum Analyzer	R&S	FSP40	100626	Mar. 06, 2021

Remark: "N/A" denotes no model name, serial no. or calibration specified.

All calibration period of equipment list is one year.

10. EUT TEST PHOTO**AC Power Line Conducted Emissions Test Photos**

Radiated Emissions Test Photos

30 MHz to 1 GHz

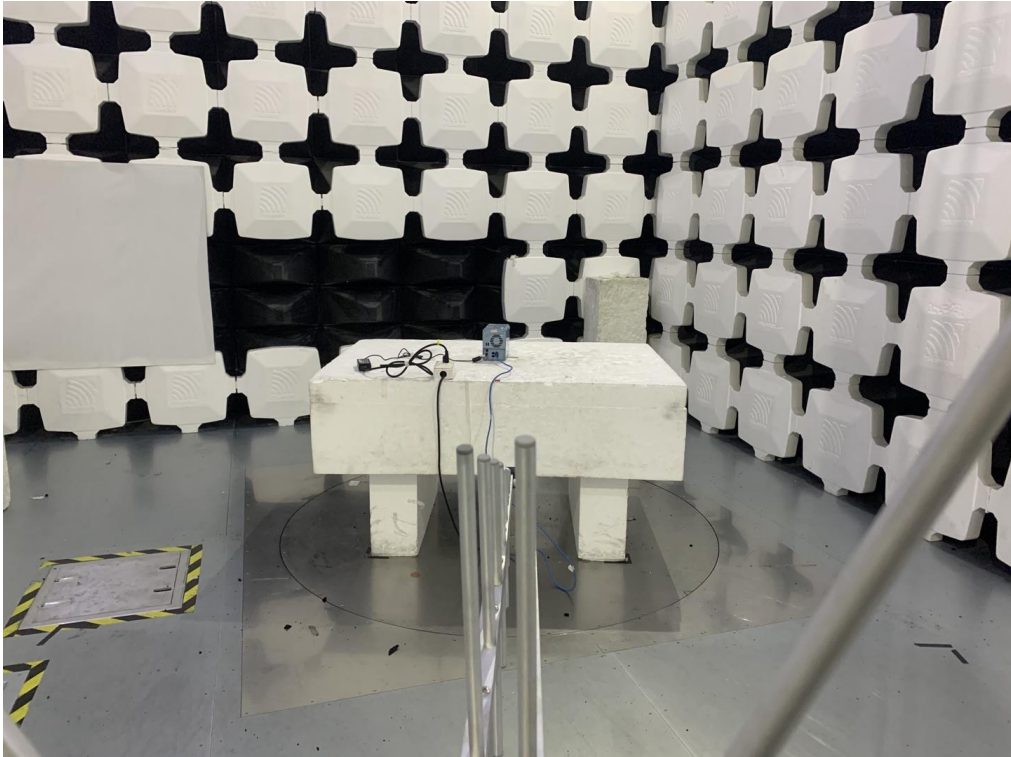
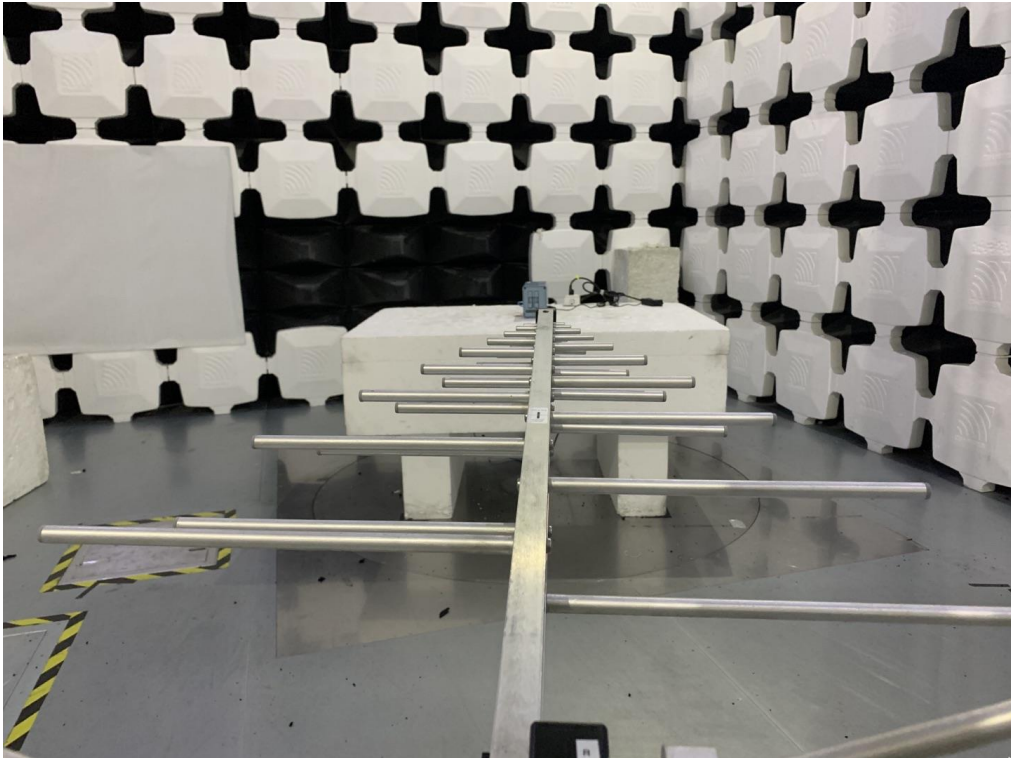

Radiated Emissions Test Photos

Above 1 GHz



APPENDIX A - AC POWER LINE CONDUCTED EMISSIONS

Test Mode: TX B Mode Channel 11

Line

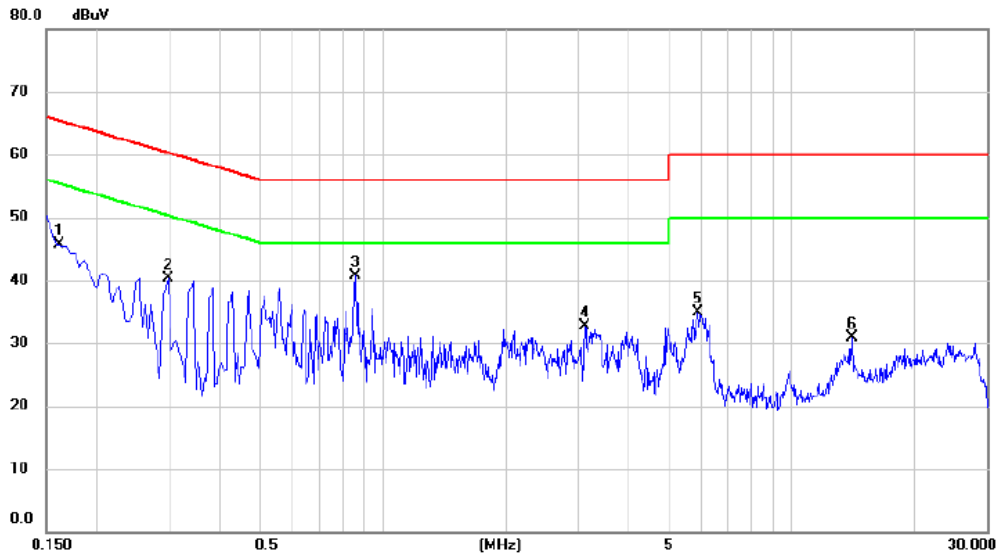

No.	Mk.	Freq. MHz	Reading Level dBuV	Correct Factor dB	Measure- ment dBuV	Limit dBuV	Margin dB	Detector	Comment
1		0.1615	35.89	9.74	45.63	65.39	-19.76	peak	
2		0.2985	30.54	9.82	40.36	60.28	-19.92	peak	
3	*	0.8565	30.94	9.79	40.73	56.00	-15.27	peak	
4		3.1200	22.88	9.86	32.74	56.00	-23.26	peak	
5		5.8875	24.95	10.02	34.97	60.00	-25.03	peak	
6		14.0010	20.80	10.19	30.99	60.00	-29.01	peak	

REMARKS:

- (1) Measurement Value = Reading Level + Correct Factor.
- (2) Margin Level = Measurement Value - Limit Value.

Test Mode: TX B Mode Channel 11

Neutral

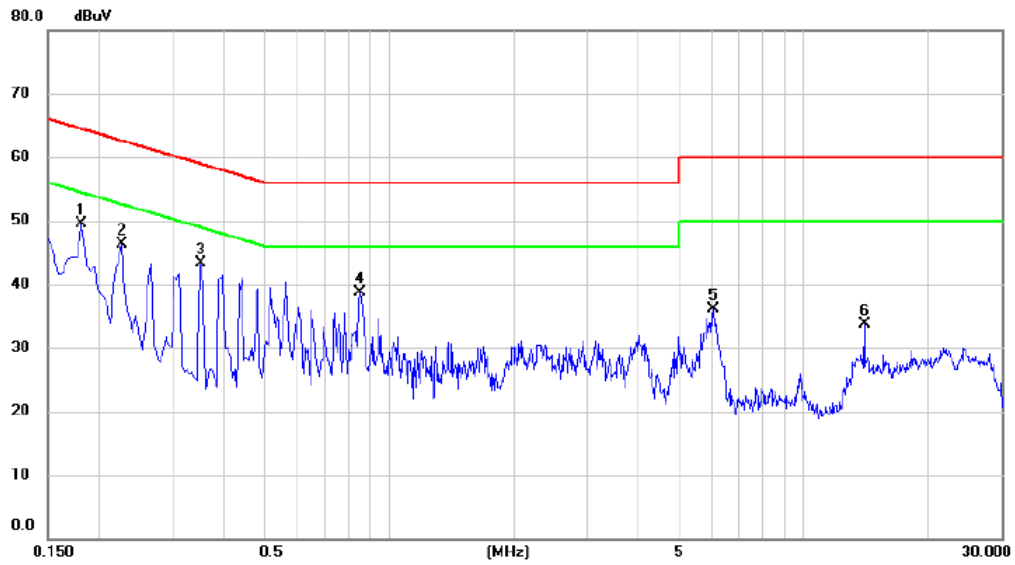

No.	Mk.	Freq. MHz	Reading Level dBuV	Correct Factor dB	Measure- ment dBuV	Limit dBuV	Margin dB	Detector	Comment
1	*	0.1815	39.79	9.63	49.42	64.42	-15.00	peak	
2		0.2265	36.69	9.63	46.32	62.58	-16.26	peak	
3		0.3525	33.60	9.67	43.27	58.90	-15.63	peak	
4		0.8520	29.01	9.72	38.73	56.00	-17.27	peak	
5		6.0630	26.01	10.01	36.02	60.00	-23.98	peak	
6		14.0010	23.52	10.15	33.67	60.00	-26.33	peak	

REMARKS:

- (1) Measurement Value = Reading Level + Correct Factor.
- (2) Margin Level = Measurement Value - Limit Value.

APPENDIX B - RADIATED EMISSION - 9 KHZ TO 30 MHZ

Note: Below 30MHz, The measured value have enough margin over 20dB than the limit, therefore they are not reported

APPENDIX C - RADIATED EMISSION - 30 MHZ TO 1000 MHZ

Test Mode: TX B Mode Channel 11

Vertical

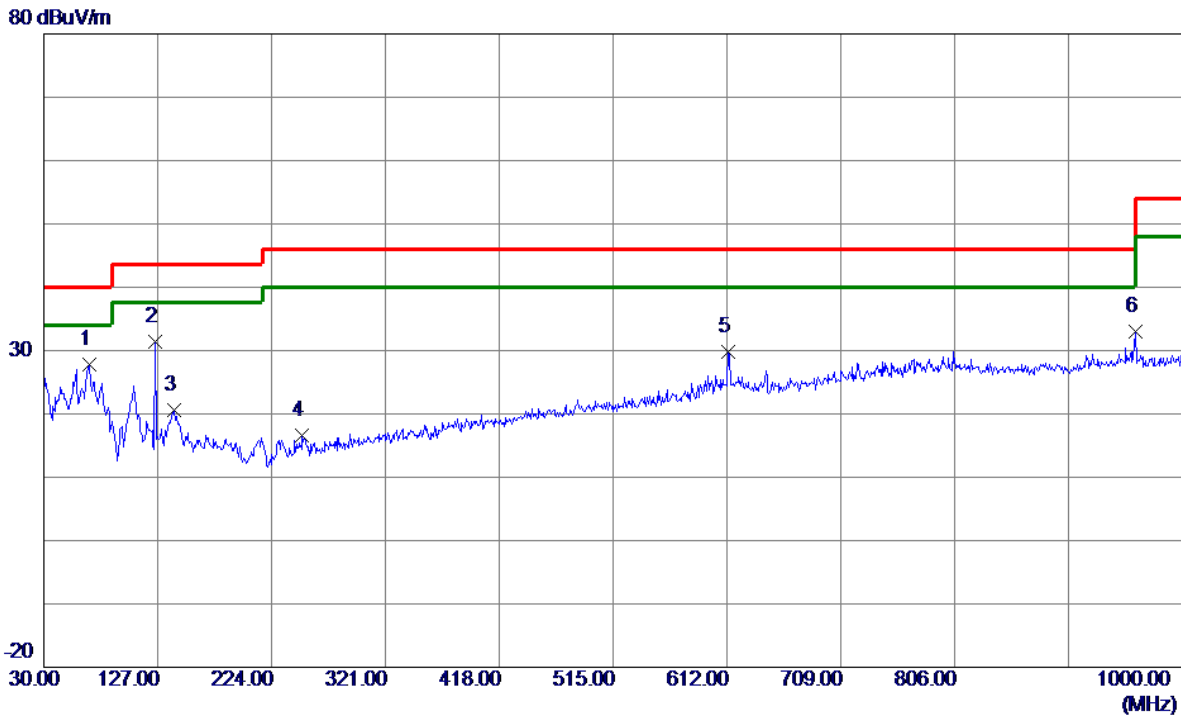

No.	Freq. MHz	Reading Level dBuV/m	Correct Factor dB	Measure ment dBuV/m	Limit dBuV/m	Margin dB	Detector	Comment
1 *	69.2850	45.95	-18.09	27.86	40.00	-12.14	Peak	
2	125.0600	49.03	-17.69	31.34	43.50	-12.16	Peak	
3	141.0650	36.93	-16.25	20.68	43.50	-22.82	Peak	
4	250.1900	33.30	-16.66	16.64	46.00	-29.36	Peak	
5	613.4550	37.81	-7.92	29.89	46.00	-16.11	Peak	
6	959.7450	36.47	-3.45	33.02	46.00	-12.98	Peak	

REMARKS:

- (1) Measurement Value = Reading Level + Correct Factor.
- (2) Margin Level = Measurement Value - Limit Value.

Test Mode: TX B Mode Channel 11

Horizontal

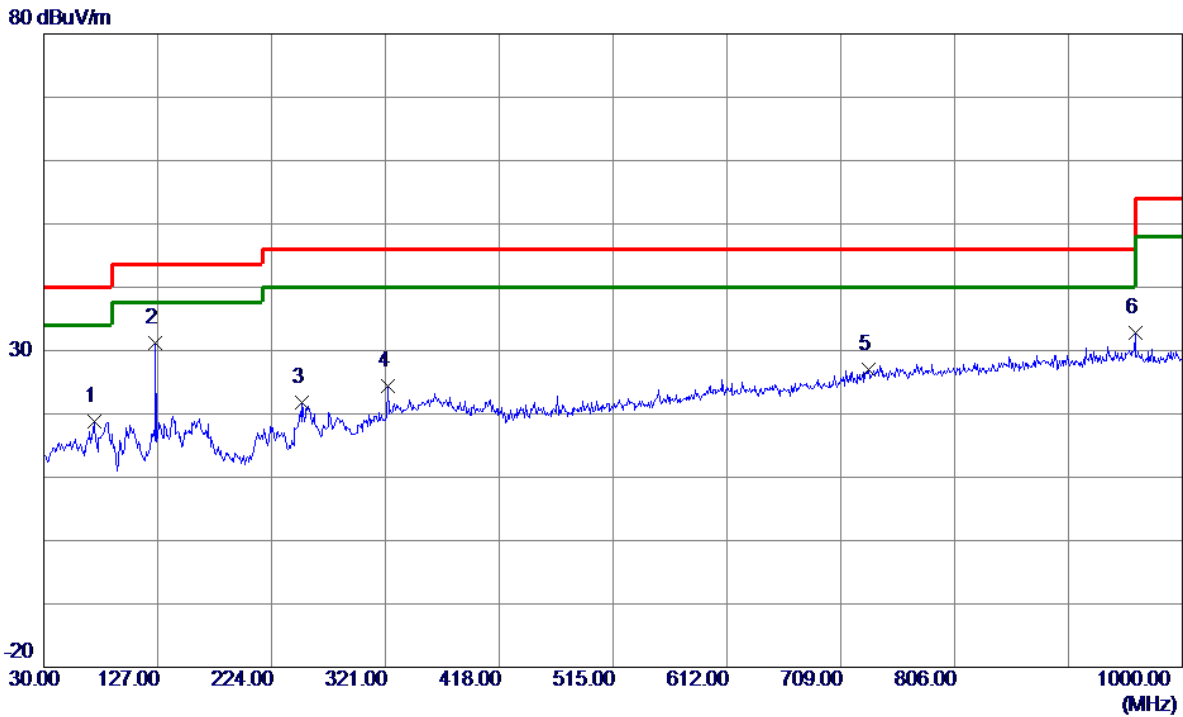

No.	Freq. MHz	Reading Level dBuV/m	Correct Factor dB	Measure ment dBuV/m	Limit dBuV/m	Margin dB	Detector	Comment
1	72.6800	37.57	-18.80	18.77	40.00	-21.23	Peak	
2 *	125.0600	48.86	-17.69	31.17	43.50	-12.33	Peak	
3	250.1900	38.49	-16.66	21.83	46.00	-24.17	Peak	
4	322.9400	38.70	-14.23	24.47	46.00	-21.53	Peak	
5	732.2800	33.12	-6.16	26.96	46.00	-19.04	Peak	
6	959.7450	36.19	-3.45	32.74	46.00	-13.26	Peak	

REMARKS:

- (1) Measurement Value = Reading Level + Correct Factor.
- (2) Margin Level = Measurement Value - Limit Value.

APPENDIX D - RADIATED EMISSION- ABOVE 1000 MHZ

For Ant. 1

Test Mode: TX B Mode 2412 MHz

Vertical

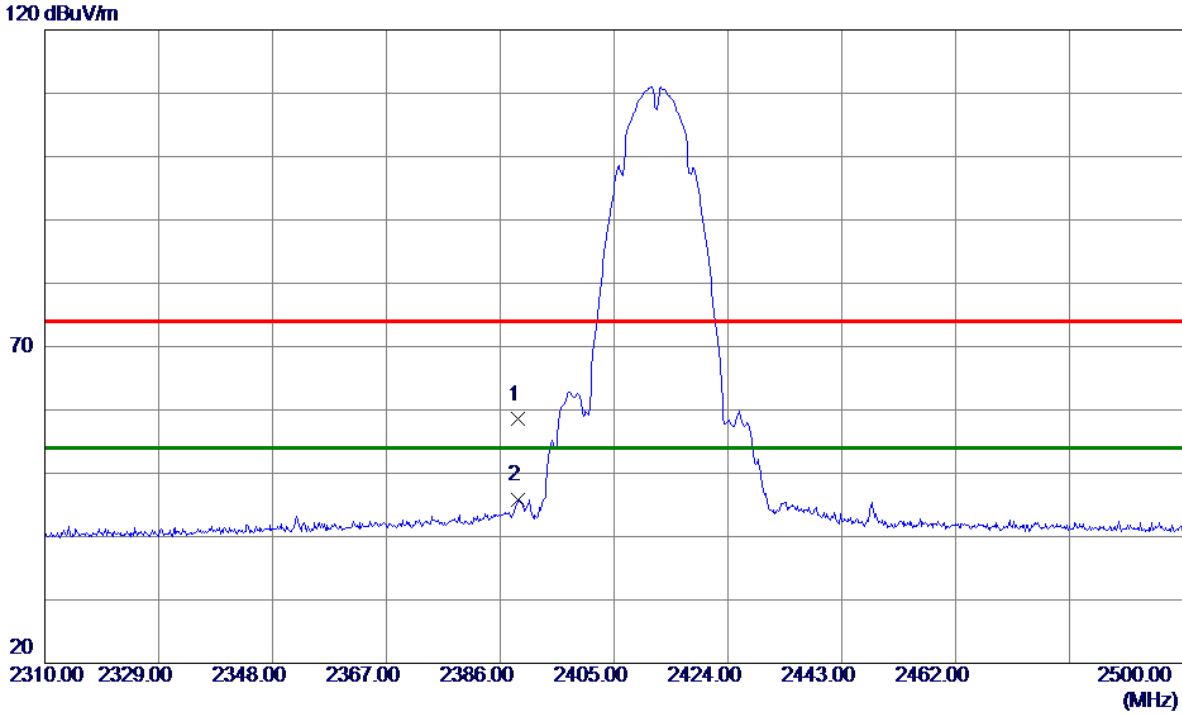

No.	Freq. MHz	Reading Level dBuV/m	Correct Factor dB	Measure ment dBuV/m	Limit dBuV/m	Margin dB	Detector	Comment
1	2389.0400	25.14	33.36	58.50	74.00	-15.50	Peak	
2 *	2389.0400	12.36	33.36	45.72	54.00	-8.28	AVG	

REMARKS:

- (1) Measurement Value = Reading Level + Correct Factor.
- (2) Margin Level = Measurement Value - Limit Value.

Test Mode: TX B Mode 2412 MHz

Vertical

80 dBuV/m

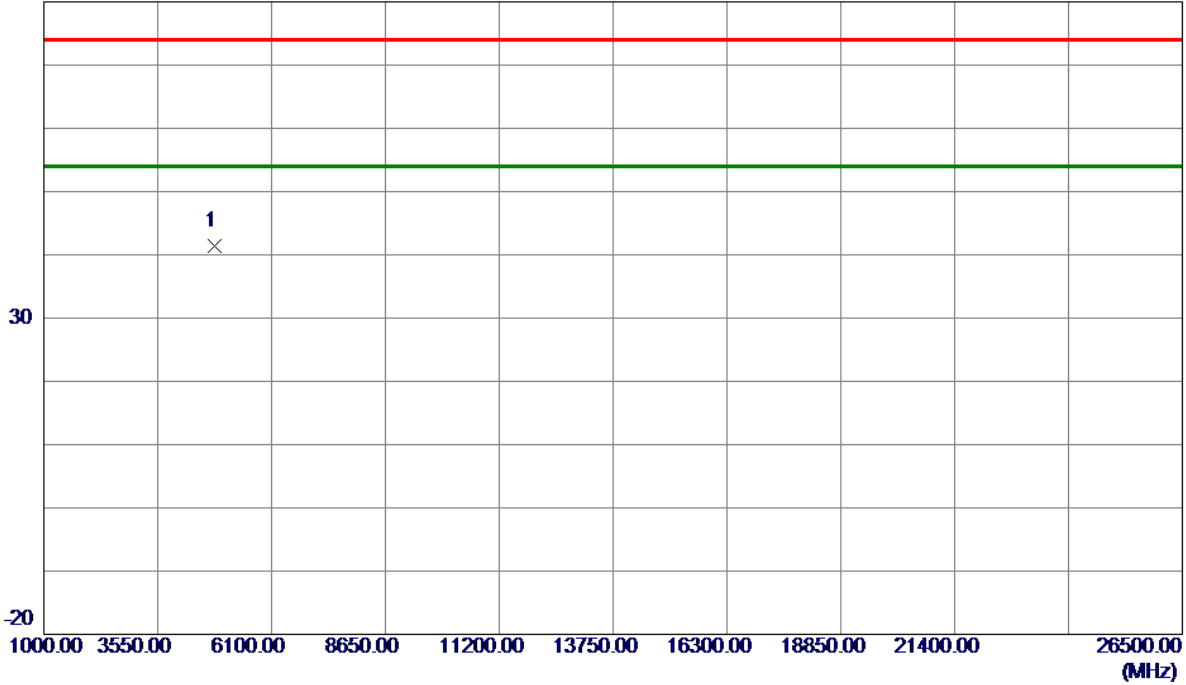

No.	Freq. MHz	Reading Level dBuV/m	Correct Factor dB	Measure ment dBuV/m	Limit dBuV/m	Margin dB	Detector	Comment
1 *	4824.0400	49.65	-8.22	41.43	74.00	-32.57	Peak	

REMARKS:

- (1) Measurement Value = Reading Level + Correct Factor.
- (2) Margin Level = Measurement Value - Limit Value.

Test Mode: TX B Mode 2412 MHz

Horizontal

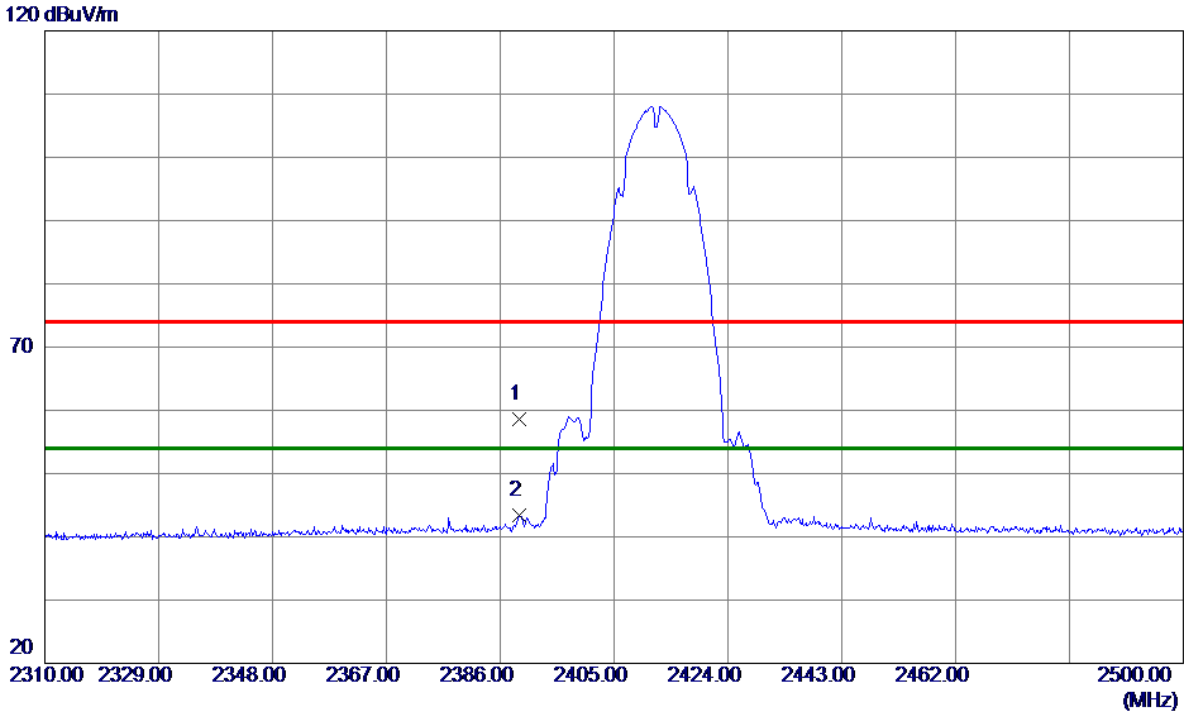

No.	Freq. MHz	Reading Level dBuV/m	Correct Factor dB	Measure ment dBuV/m	Limit dBuV/m	Margin dB	Detector	Comment
1	2389.1350	25.20	33.36	58.56	74.00	-15.44	Peak	
2 *	2389.1350	10.05	33.36	43.41	54.00	-10.59	AVG	

REMARKS:

(1) Measurement Value = Reading Level + Correct Factor.

(2) Margin Level = Measurement Value - Limit Value.

Test Mode: TX B Mode 2412 MHz

Horizontal

80 dBuV/m

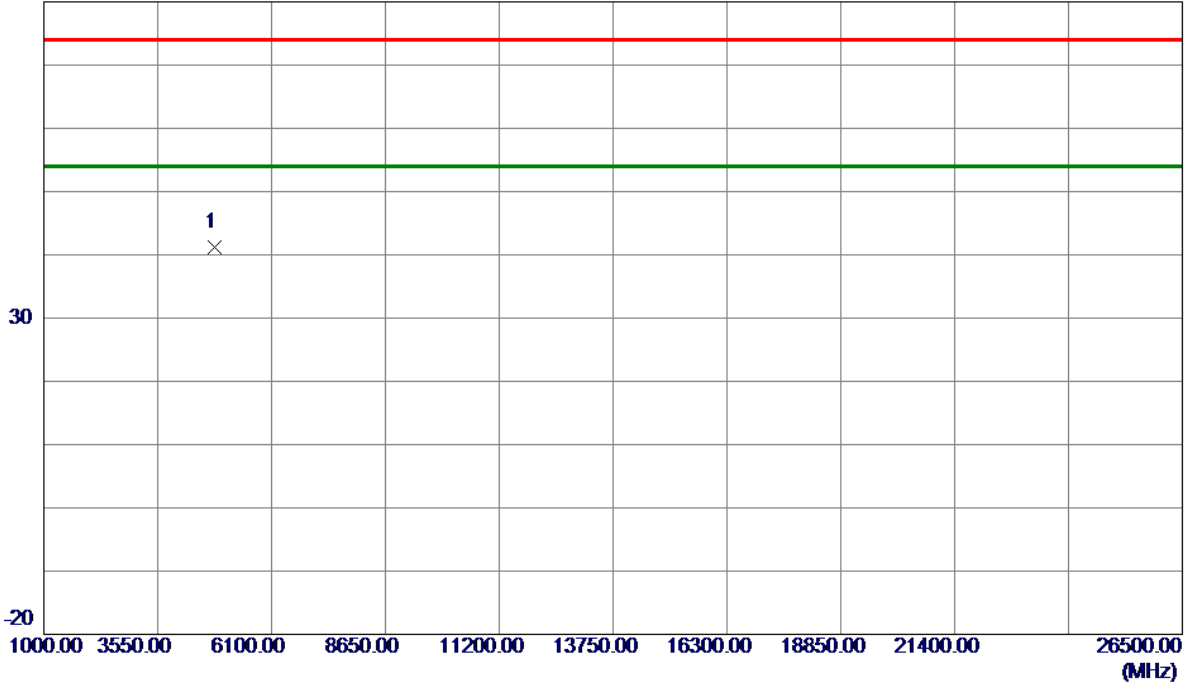

No.	Freq. MHz	Reading Level dBuV/m	Correct Factor dB	Measure ment dBuV/m	Limit dBuV/m	Margin dB	Detector	Comment
1 *	4823.9100	49.46	-8.22	41.24	74.00	-32.76	Peak	

REMARKS:

- (1) Measurement Value = Reading Level + Correct Factor.
- (2) Margin Level = Measurement Value - Limit Value.

Test Mode: TX B Mode 2437 MHz

Vertical

120 dBuV/m

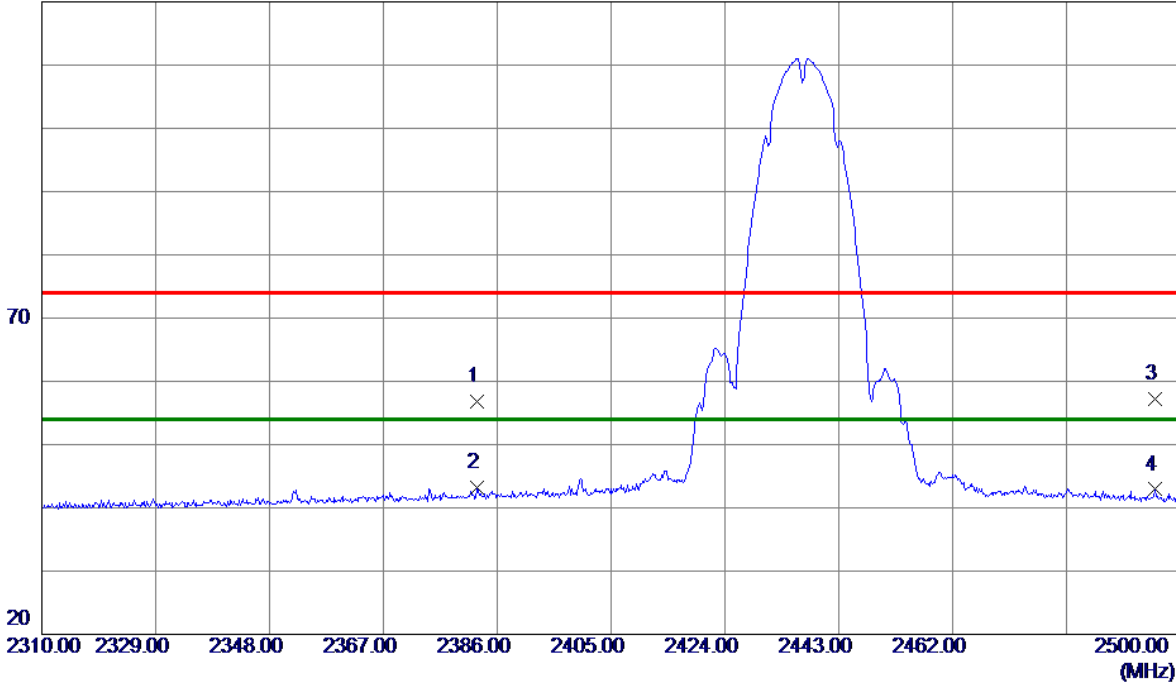

No.	Freq. MHz	Reading Level dBuV/m	Correct Factor dB	Measure ment dBuV/m	Limit dBuV/m	Margin dB	Detector	Comment
1	2382.5800	23.56	33.33	56.89	74.00	-17.11	Peak	
2 *	2382.5800	9.93	33.33	43.26	54.00	-10.74	AVG	
3	2495.7250	23.48	33.81	57.29	74.00	-16.71	Peak	
4	2495.7250	9.09	33.81	42.90	54.00	-11.10	AVG	

REMARKS:

(1) Measurement Value = Reading Level + Correct Factor.

(2) Margin Level = Measurement Value - Limit Value.

Test Mode: TX B Mode 2437 MHz

Vertical

80 dBuV/m

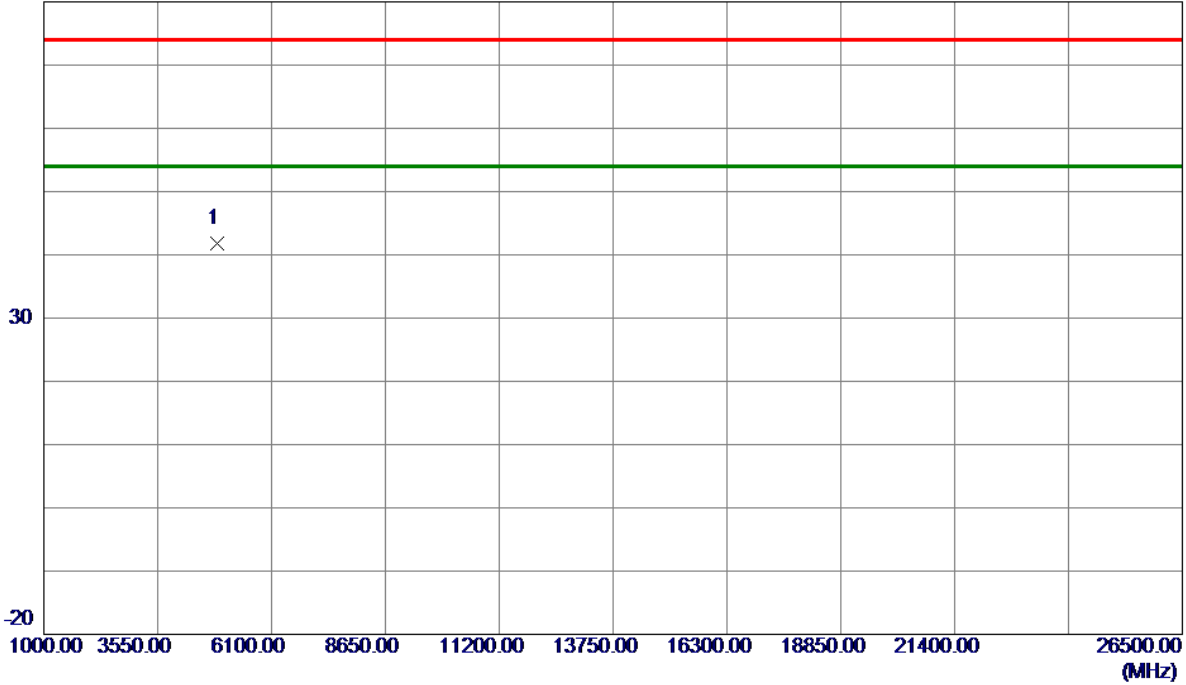

No.	Freq. MHz	Reading Level dBuV/m	Correct Factor dB	Measure ment dBuV/m	Limit dBuV/m	Margin dB	Detector	Comment
1 *	4874.0900	49.84	-8.07	41.77	74.00	-32.23	Peak	

REMARKS:

- (1) Measurement Value = Reading Level + Correct Factor.
- (2) Margin Level = Measurement Value - Limit Value.

Test Mode: TX B Mode 2437 MHz

Horizontal

120 dBuV/m

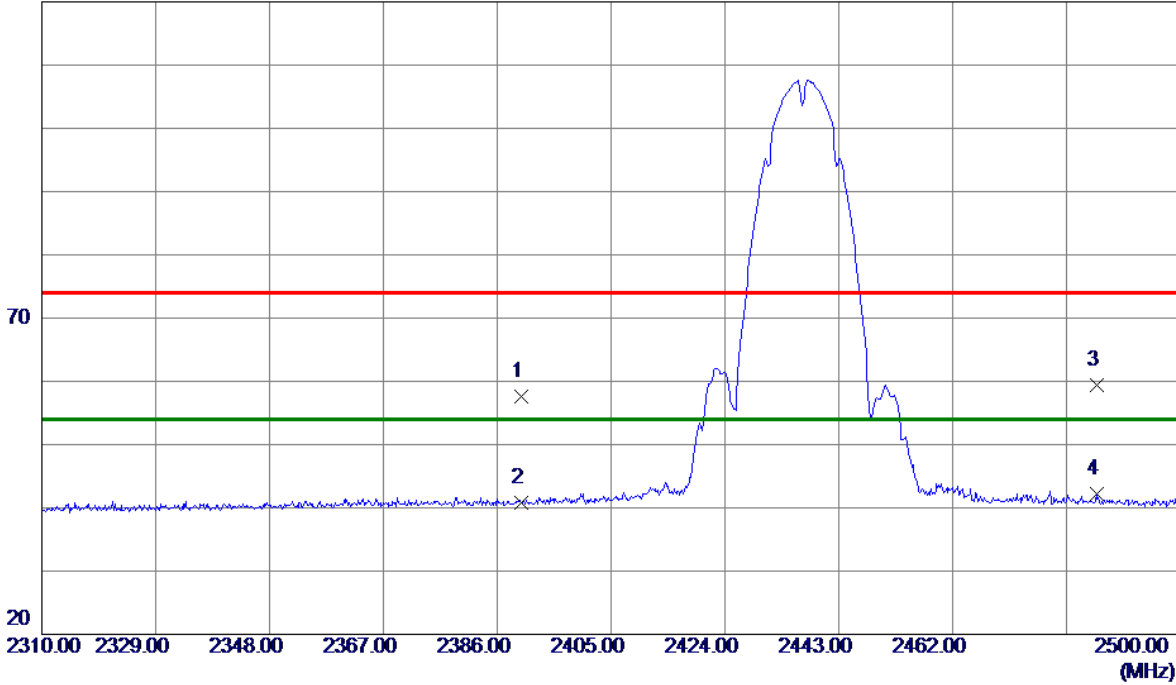

No.	Freq. MHz	Reading Level dBuV/m	Correct Factor dB	Measure ment dBuV/m	Limit dBuV/m	Margin dB	Detector	Comment
1	2390.0000	24.26	33.36	57.62	74.00	-16.38	Peak	
2	2390.0000	7.47	33.36	40.83	54.00	-13.17	AVG	
3	2486.0350	25.54	33.77	59.31	74.00	-14.69	Peak	
4 *	2486.0350	8.51	33.77	42.28	54.00	-11.72	AVG	

REMARKS:

(1) Measurement Value = Reading Level + Correct Factor.

(2) Margin Level = Measurement Value - Limit Value.

Test Mode: TX B Mode 2437 MHz

Horizontal

80 dBuV/m

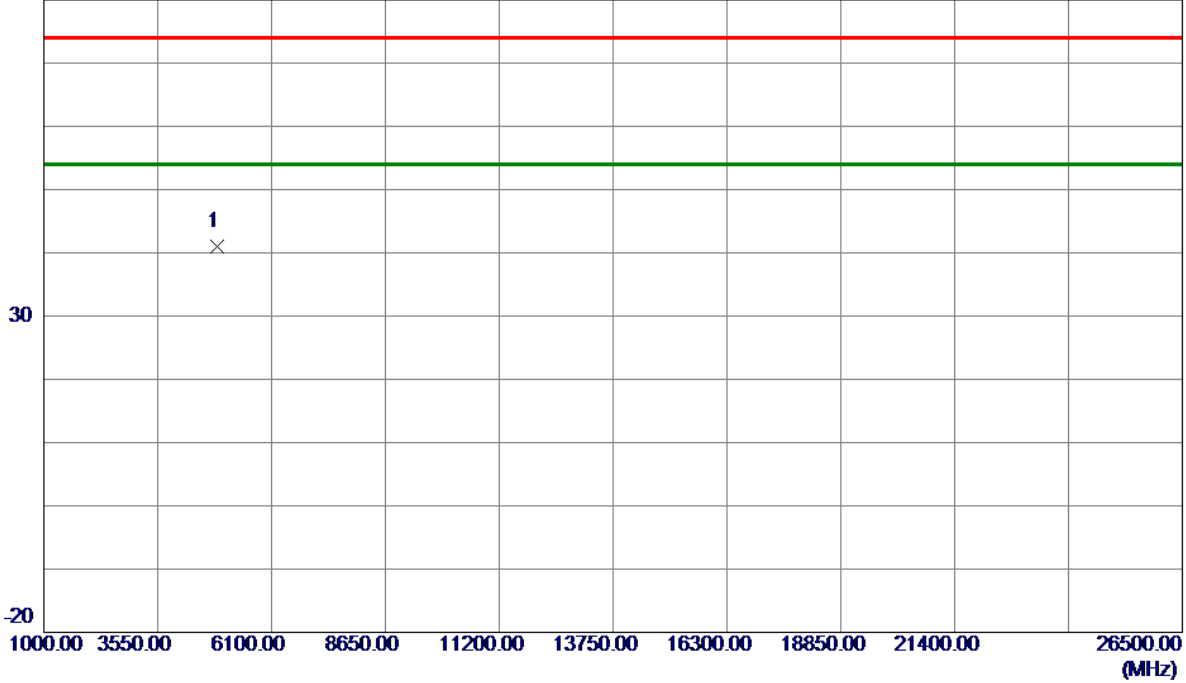

No.	Freq. MHz	Reading Level dBuV/m	Correct Factor dB	Measure ment dBuV/m	Limit dBuV/m	Margin dB	Detector	Comment
1 *	4874.6450	49.14	-8.07	41.07	74.00	-32.93	Peak	

REMARKS:

- (1) Measurement Value = Reading Level + Correct Factor.
- (2) Margin Level = Measurement Value - Limit Value.

Test Mode: TX B Mode 2462 MHz

Vertical

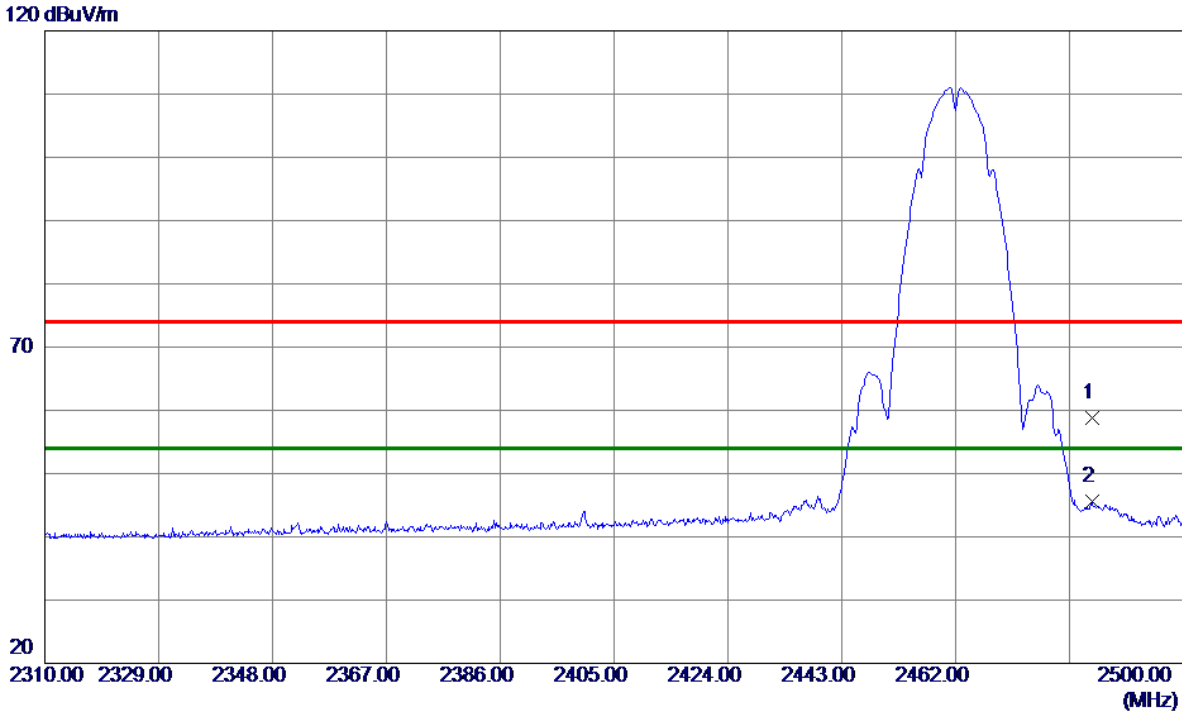

No.	Freq. MHz	Reading Level dBuV/m	Correct Factor dB	Measure ment dBuV/m	Limit dBuV/m	Margin dB	Detector	Comment
1	2484.7050	25.13	33.76	58.89	74.00	-15.11	Peak	
2 *	2484.7050	11.86	33.76	45.62	54.00	-8.38	AVG	

REMARKS:

(1) Measurement Value = Reading Level + Correct Factor.

(2) Margin Level = Measurement Value - Limit Value.

Test Mode: TX B Mode 2462 MHz

Vertical

80 dBuV/m

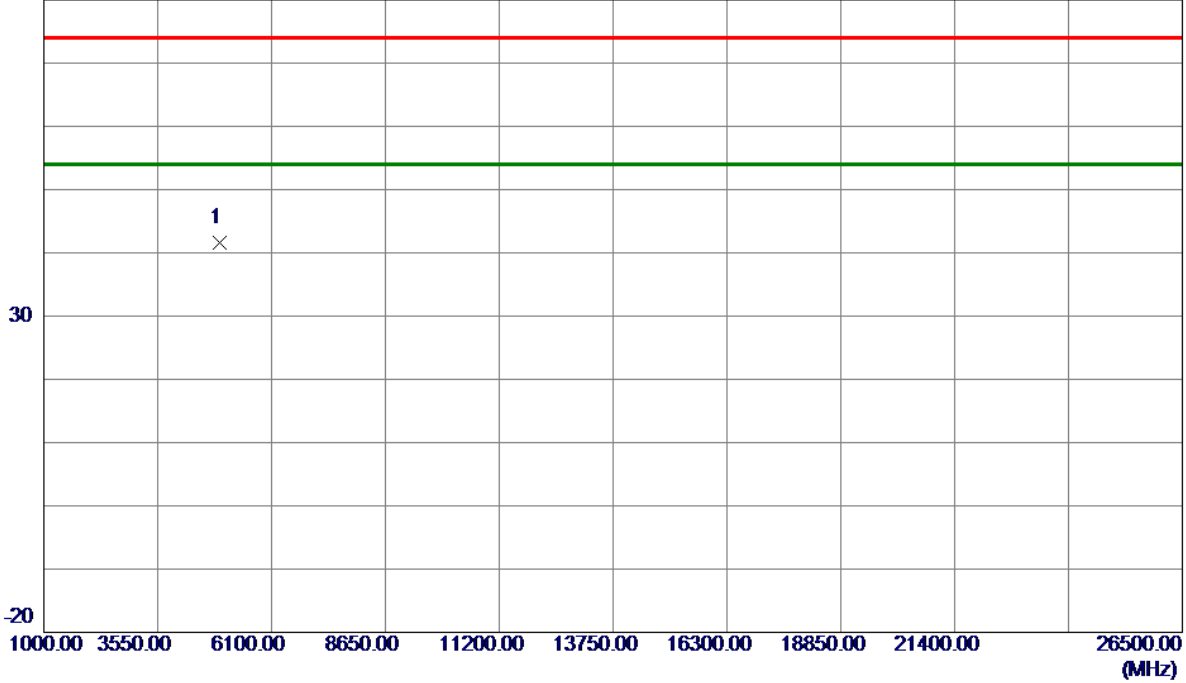

No.	Freq. MHz	Reading Level dBuV/m	Correct Factor dB	Measure ment dBuV/m	Limit dBuV/m	Margin dB	Detector	Comment
1 *	4924.2350	49.52	-7.91	41.61	74.00	-32.39	Peak	

REMARKS:

- (1) Measurement Value = Reading Level + Correct Factor.
- (2) Margin Level = Measurement Value - Limit Value.

Test Mode: TX B Mode 2462 MHz

Horizontal

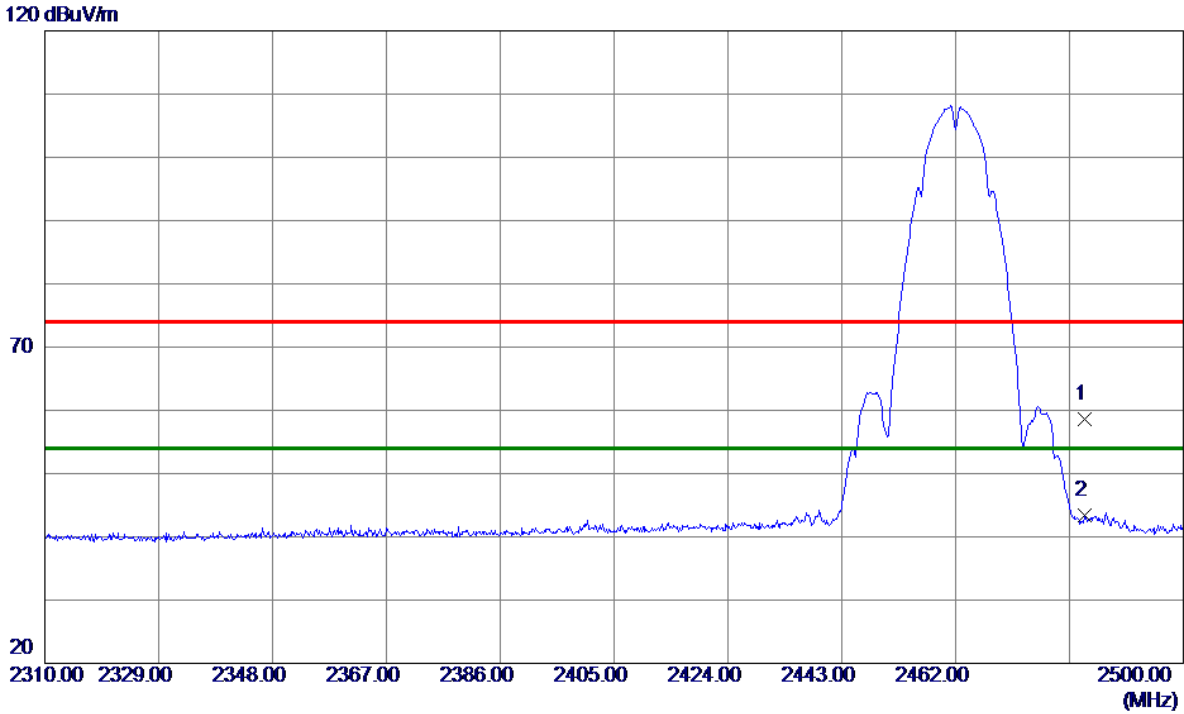

No.	Freq. MHz	Reading Level dBuV/m	Correct Factor dB	Measure ment dBuV/m	Limit dBuV/m	Margin dB	Detector	Comment
1	2483.5000	24.80	33.76	58.56	74.00	-15.44	Peak	
2 *	2483.5000	9.72	33.76	43.48	54.00	-10.52	AVG	

REMARKS:

(1) Measurement Value = Reading Level + Correct Factor.

(2) Margin Level = Measurement Value - Limit Value.

Test Mode: TX B Mode 2462 MHz

Horizontal

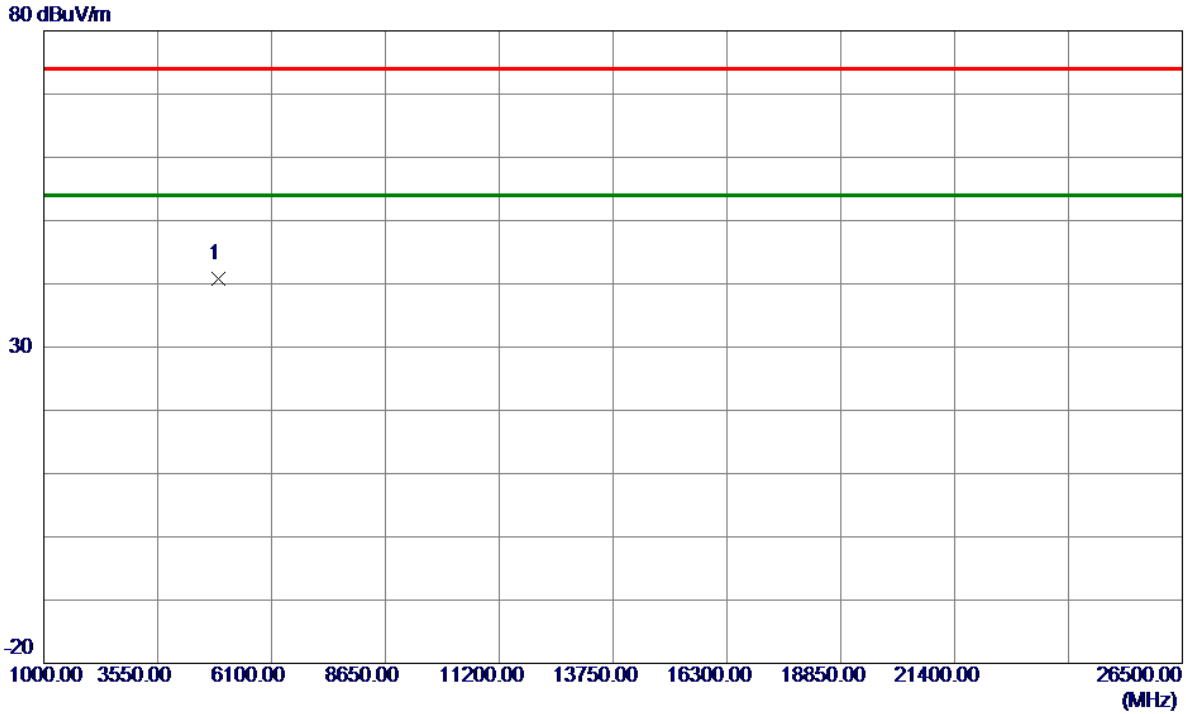

No.	Freq. MHz	Reading Level dBuV/m	Correct Factor dB	Measure ment dBuV/m	Limit dBuV/m	Margin dB	Detector	Comment
1 *	4923.2100	48.78	-7.92	40.86	74.00	-33.14	Peak	

REMARKS:

- (1) Measurement Value = Reading Level + Correct Factor.
- (2) Margin Level = Measurement Value - Limit Value.

Test Mode: TX G Mode 2412 MHz

Vertical

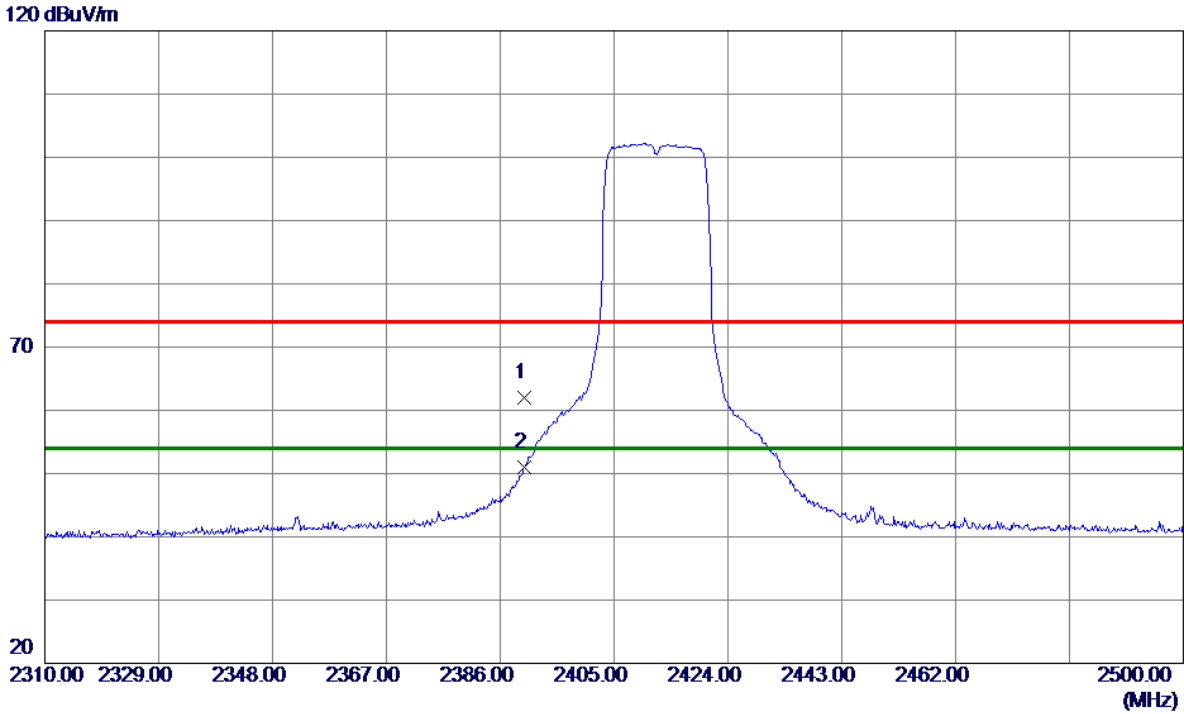

No.	Freq. MHz	Reading Level dBuV/m	Correct Factor dB	Measure ment dBuV/m	Limit dBuV/m	Margin dB	Detector	Comment
1	2390.0000	28.64	33.36	62.00	74.00	-12.00	Peak	
2 *	2390.0000	17.67	33.36	51.03	54.00	-2.97	AVG	

REMARKS:

(1) Measurement Value = Reading Level + Correct Factor.

(2) Margin Level = Measurement Value - Limit Value.

Test Mode: TX G Mode 2412 MHz

Vertical

80 dBuV/m

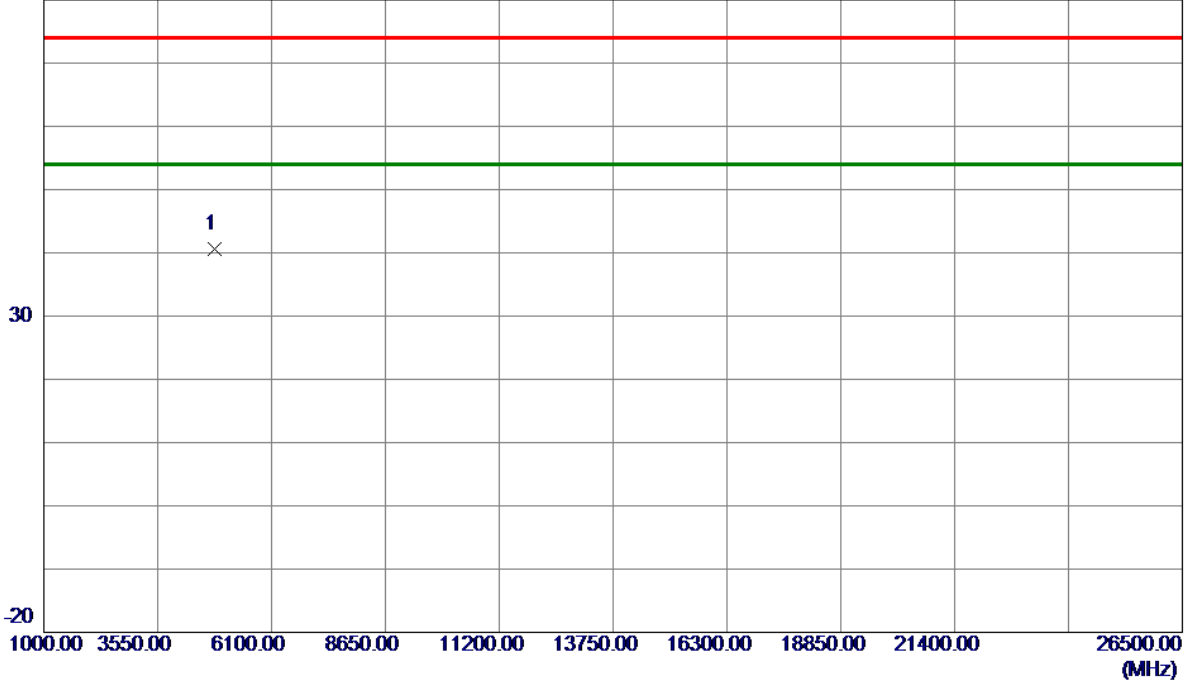

No.	Freq. MHz	Reading Level dBuV/m	Correct Factor dB	Measure ment dBuV/m	Limit dBuV/m	Margin dB	Detector	Comment
1 *	4823.0000	48.79	-8.23	40.56	74.00	-33.44	Peak	

REMARKS:

- (1) Measurement Value = Reading Level + Correct Factor.
- (2) Margin Level = Measurement Value - Limit Value.

Test Mode: TX G Mode 2412 MHz

Horizontal

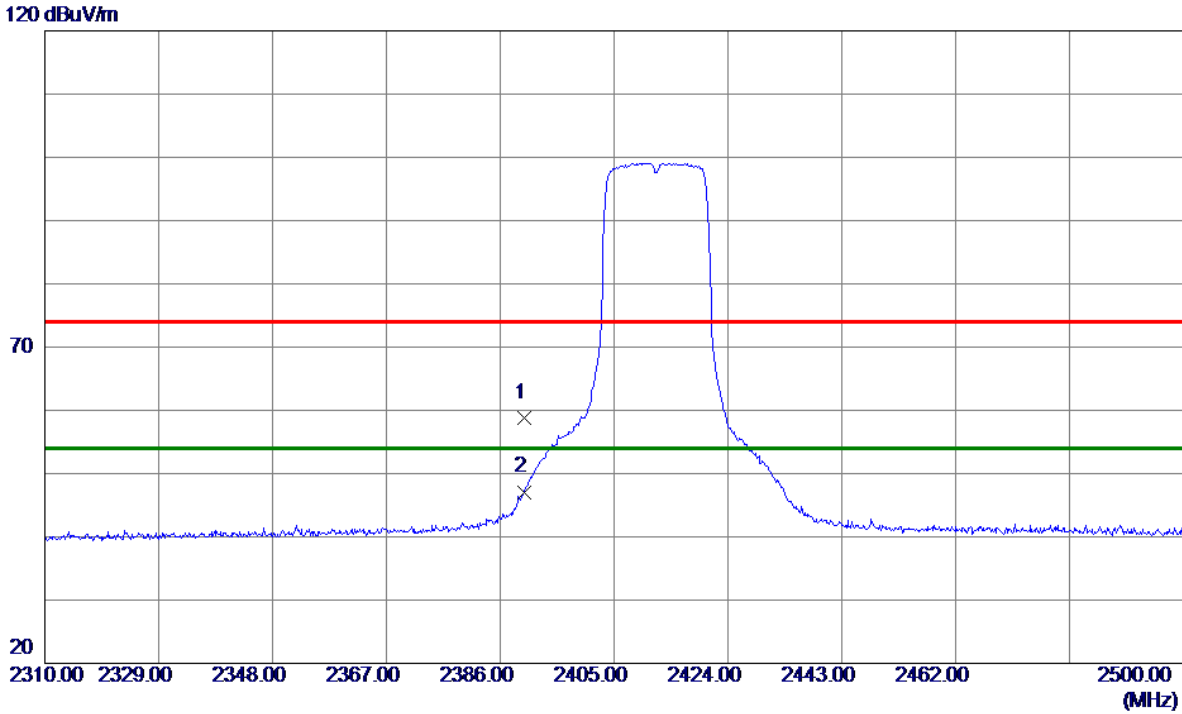

No.	Freq. MHz	Reading Level dBuV/m	Correct Factor dB	Measure ment dBuV/m	Limit dBuV/m	Margin dB	Detector	Comment
1	2390.0000	25.48	33.36	58.84	74.00	-15.16	Peak	
2 *	2390.0000	13.74	33.36	47.10	54.00	-6.90	AVG	

REMARKS:

(1) Measurement Value = Reading Level + Correct Factor.

(2) Margin Level = Measurement Value - Limit Value.

Test Mode: TX G Mode 2412 MHz

Horizontal

80 dBuV/m

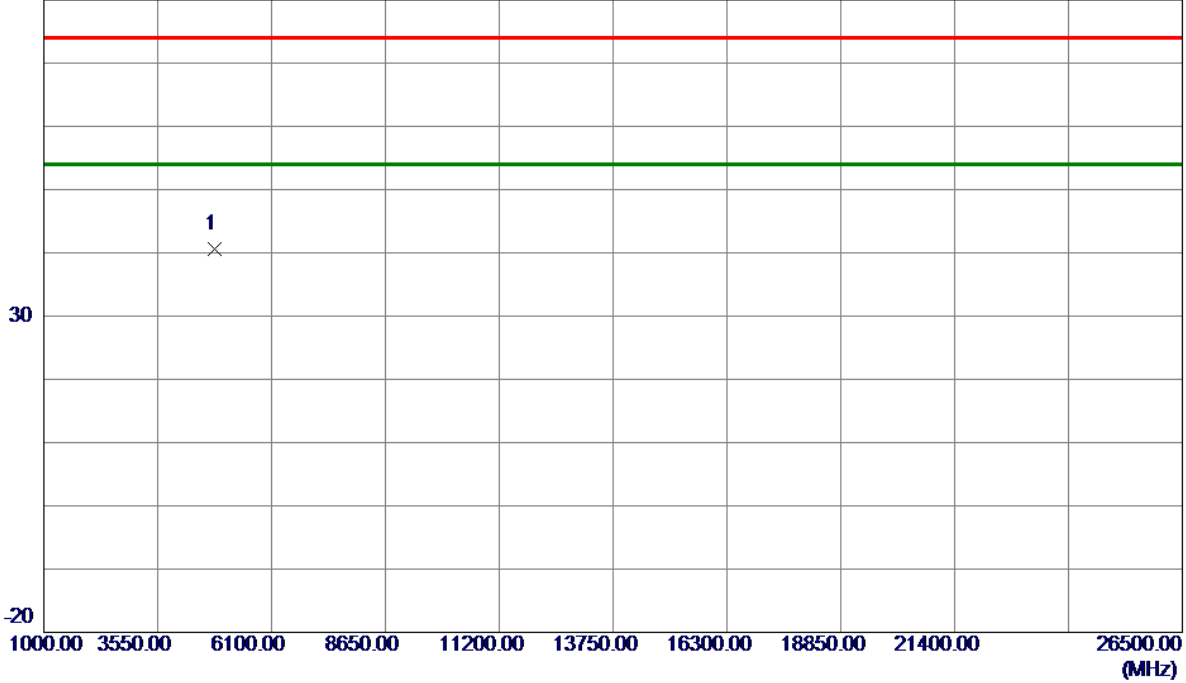

No.	Freq. MHz	Reading Level dBuV/m	Correct Factor dB	Measure ment dBuV/m	Limit dBuV/m	Margin dB	Detector	Comment
1 *	4824.5750	48.73	-8.22	40.51	74.00	-33.49	Peak	

REMARKS:

- (1) Measurement Value = Reading Level + Correct Factor.
- (2) Margin Level = Measurement Value - Limit Value.

Test Mode: TX G Mode 2437 MHz

Vertical

120 dBuV/m

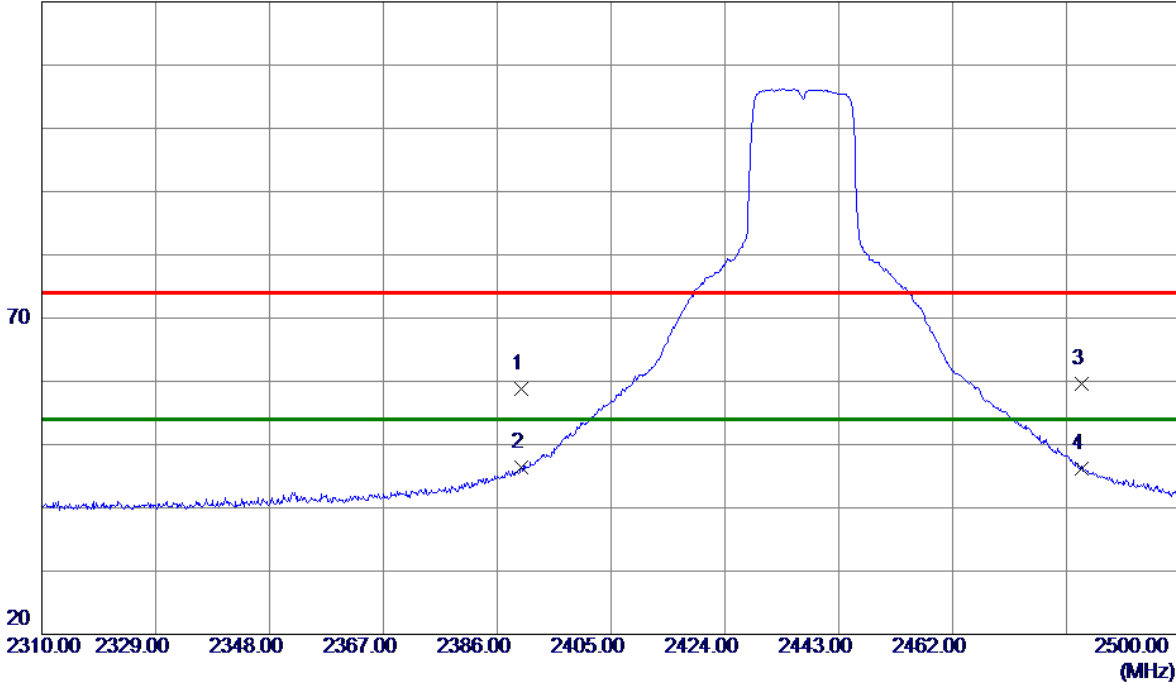

No.	Freq. MHz	Reading Level dBuV/m	Correct Factor dB	Measure ment dBuV/m	Limit dBuV/m	Margin dB	Detector	Comment
1	2390.0000	25.46	33.36	58.82	74.00	-15.18	Peak	
2 *	2390.0000	12.98	33.36	46.34	54.00	-7.66	AVG	
3	2483.5000	25.77	33.76	59.53	74.00	-14.47	Peak	
4	2483.5000	12.37	33.76	46.13	54.00	-7.87	AVG	

REMARKS:

(1) Measurement Value = Reading Level + Correct Factor.

(2) Margin Level = Measurement Value - Limit Value.

Test Mode: TX G Mode 2437 MHz

Vertical

80 dBuV/m

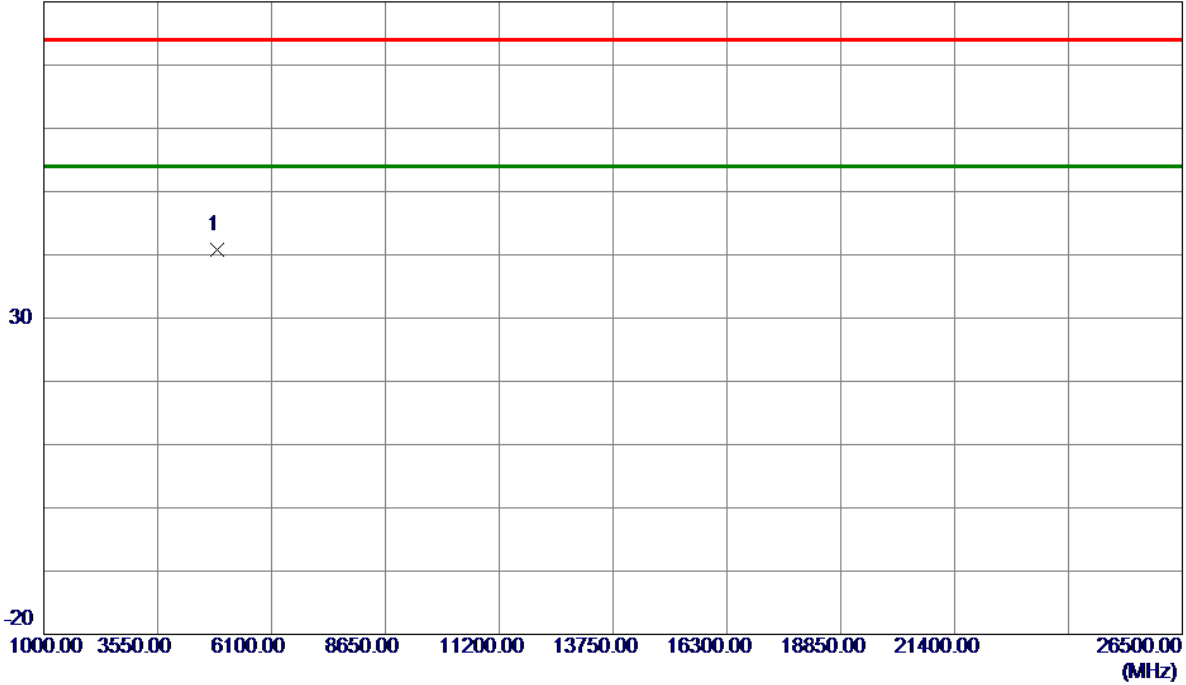

No.	Freq. MHz	Reading Level dBuV/m	Correct Factor dB	Measure ment dBuV/m	Limit dBuV/m	Margin dB	Detector	Comment
1 *	4874.7400	48.80	-8.07	40.73	74.00	-33.27	Peak	

REMARKS:

- (1) Measurement Value = Reading Level + Correct Factor.
- (2) Margin Level = Measurement Value - Limit Value.

Test Mode: TX G Mode 2437 MHz

Horizontal

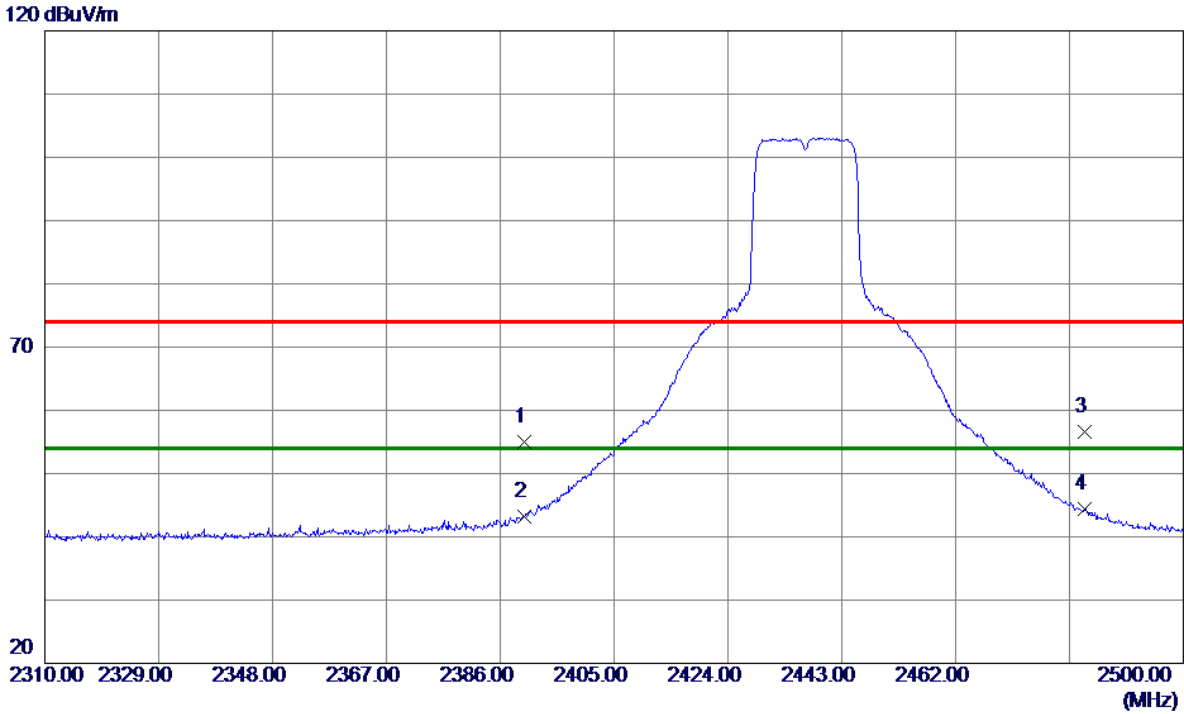

No.	Freq. MHz	Reading Level dBuV/m	Correct Factor dB	Measure ment dBuV/m	Limit dBuV/m	Margin dB	Detector	Comment
1	2390.0000	21.56	33.36	54.92	74.00	-19.08	Peak	
2 *	2390.0000	9.87	33.36	43.23	54.00	-10.77	AVG	
3	2483.5000	22.84	33.76	56.60	74.00	-17.40	Peak	
4	2483.5000	10.57	33.76	44.33	74.00	-29.67	Peak	

REMARKS:

(1) Measurement Value = Reading Level + Correct Factor.

(2) Margin Level = Measurement Value - Limit Value.

Test Mode: TX G Mode 2437 MHz

Horizontal

80 dBuV/m

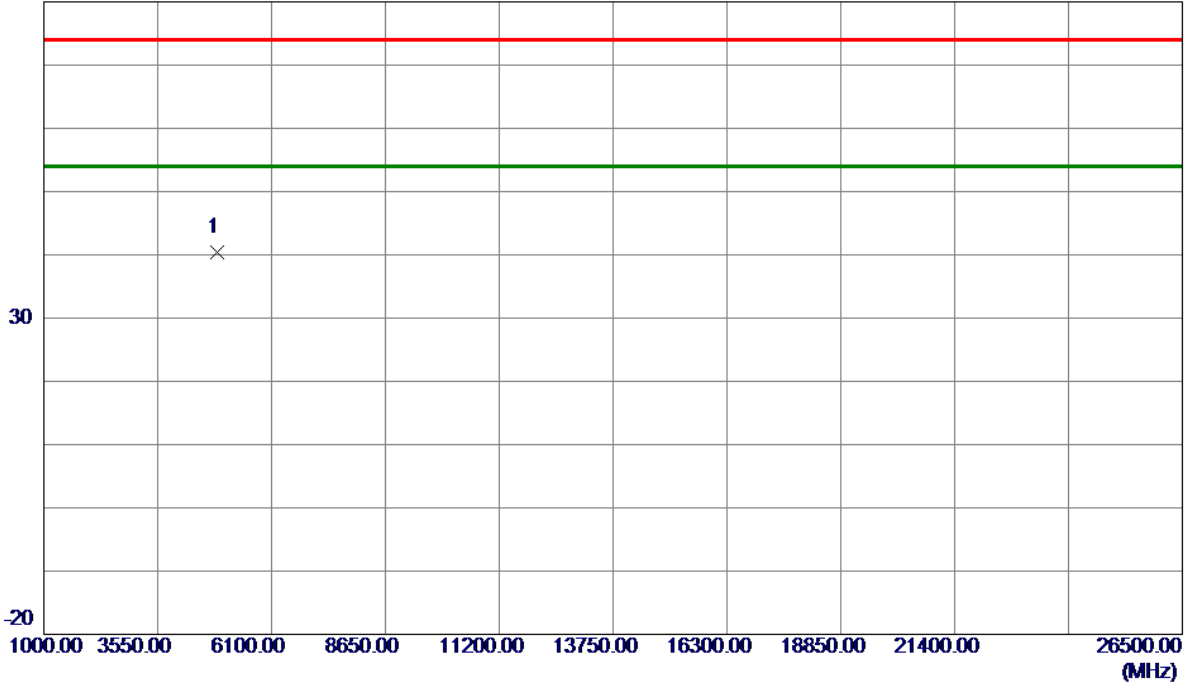

No.	Freq. MHz	Reading Level dBuV/m	Correct Factor dB	Measure ment dBuV/m	Limit dBuV/m	Margin dB	Detector	Comment
1 *	4875.7050	48.47	-8.06	40.41	74.00	-33.59	Peak	

REMARKS:

- (1) Measurement Value = Reading Level + Correct Factor.
- (2) Margin Level = Measurement Value - Limit Value.

Test Mode: TX G Mode 2462 MHz

Vertical

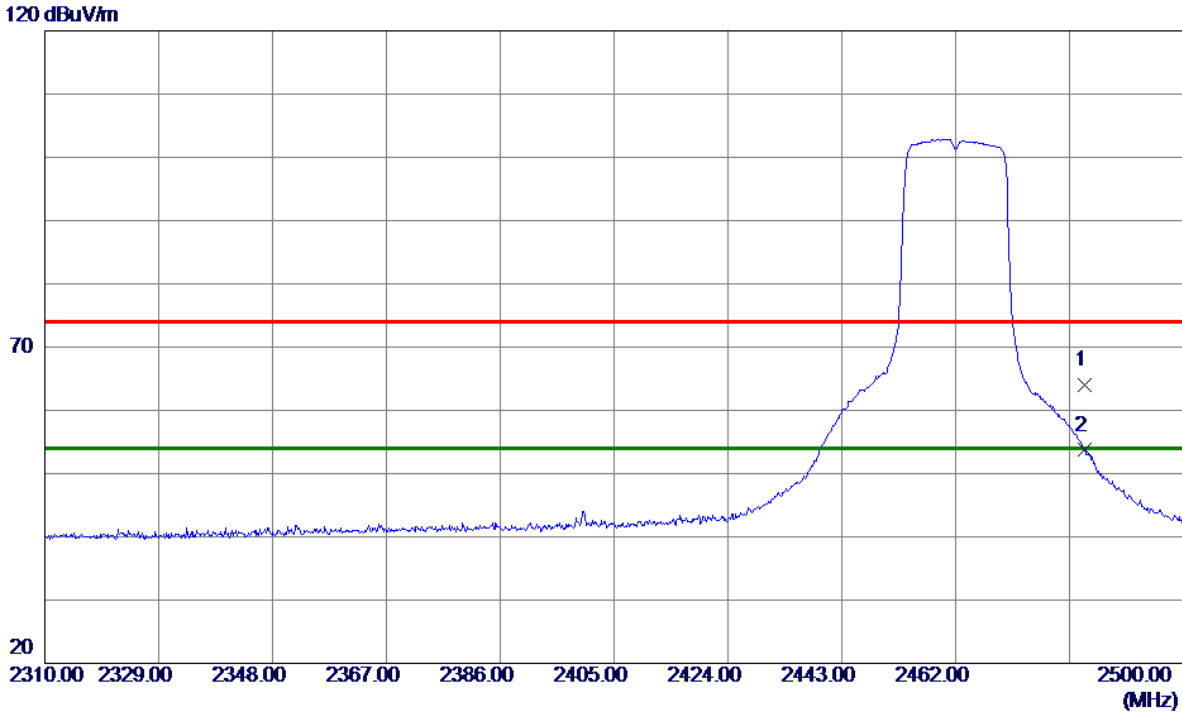

No.	Freq. MHz	Reading Level dBuV/m	Correct Factor dB	Measure ment dBuV/m	Limit dBuV/m	Margin dB	Detector	Comment
1	2483.5000	30.16	33.76	63.92	74.00	-10.08	Peak	
2 *	2483.5000	19.94	33.76	53.70	54.00	-0.30	AVG	

REMARKS:

(1) Measurement Value = Reading Level + Correct Factor.

(2) Margin Level = Measurement Value - Limit Value.

Test Mode: TX G Mode 2462 MHz

Vertical

80 dBuV/m

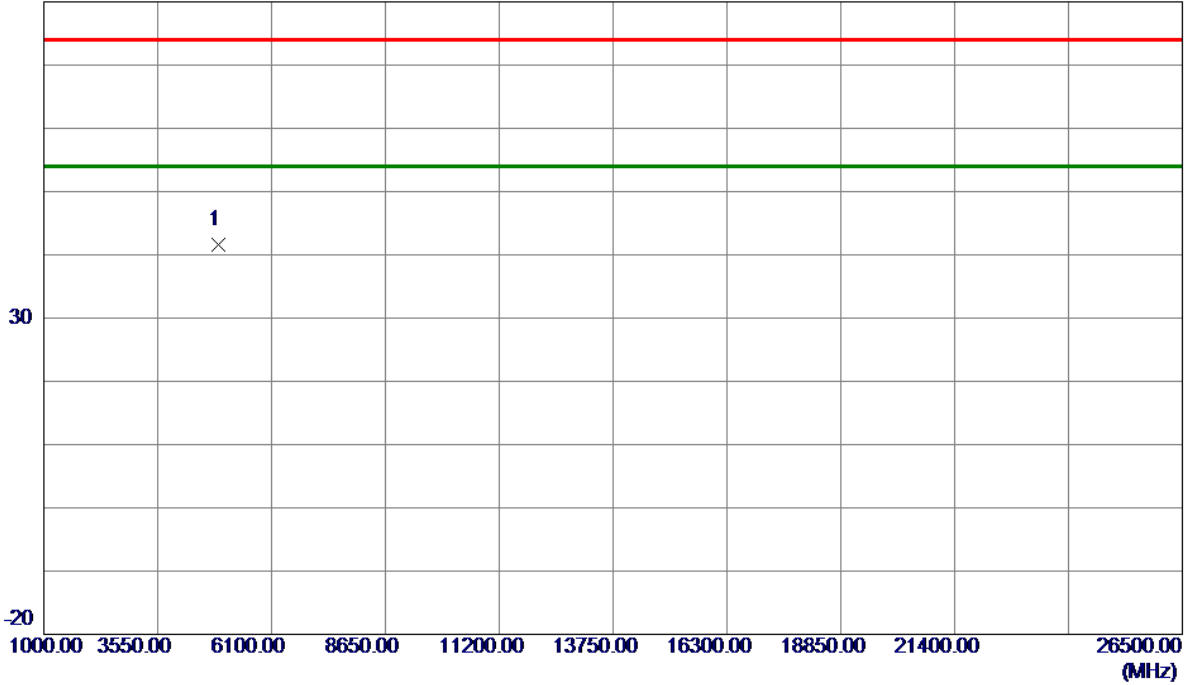

No.	Freq. MHz	Reading Level dBuV/m	Correct Factor dB	Measure ment dBuV/m	Limit dBuV/m	Margin dB	Detector	Comment
1 *	4923.6650	49.44	-7.92	41.52	74.00	-32.48	Peak	

REMARKS:

- (1) Measurement Value = Reading Level + Correct Factor.
- (2) Margin Level = Measurement Value - Limit Value.

Test Mode: TX G Mode 2462 MHz

Horizontal

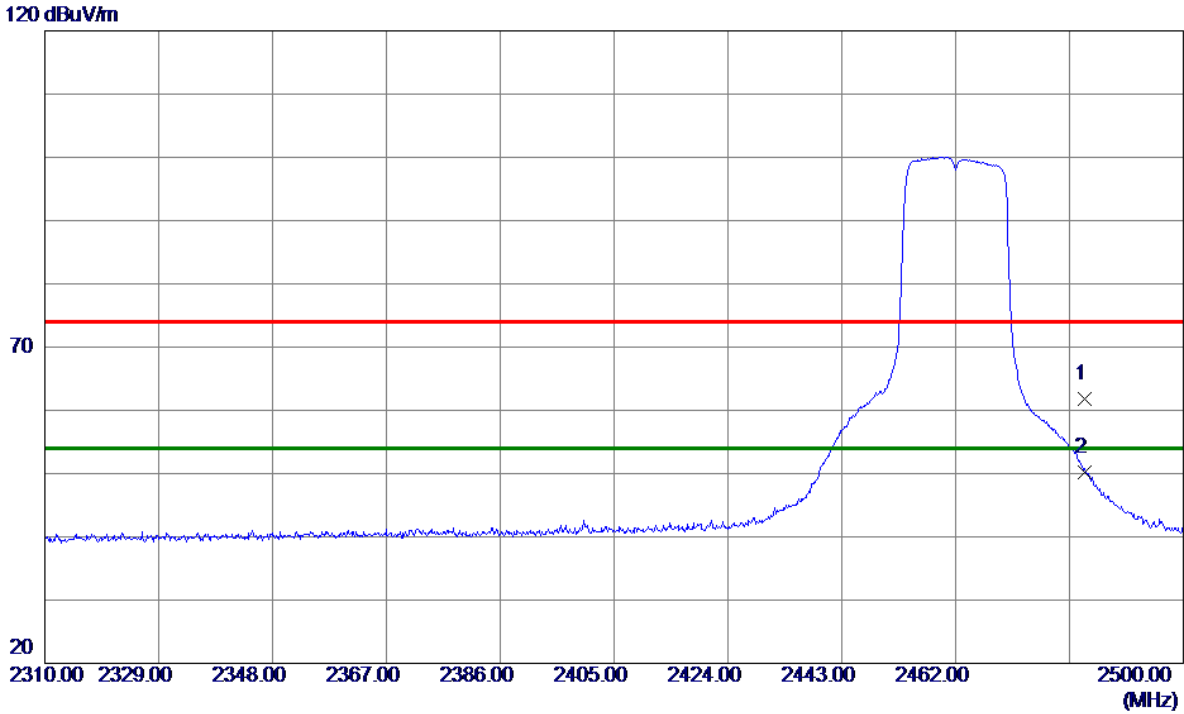

No.	Freq. MHz	Reading Level dBuV/m	Correct Factor dB	Measure ment dBuV/m	Limit dBuV/m	Margin dB	Detector	Comment
1	2483.5000	28.11	33.76	61.87	74.00	-12.13	Peak	
2 *	2483.5000	16.45	33.76	50.21	54.00	-3.79	AVG	

REMARKS:

(1) Measurement Value = Reading Level + Correct Factor.

(2) Margin Level = Measurement Value - Limit Value.

Test Mode: TX G Mode 2462 MHz

Horizontal

80 dBuV/m

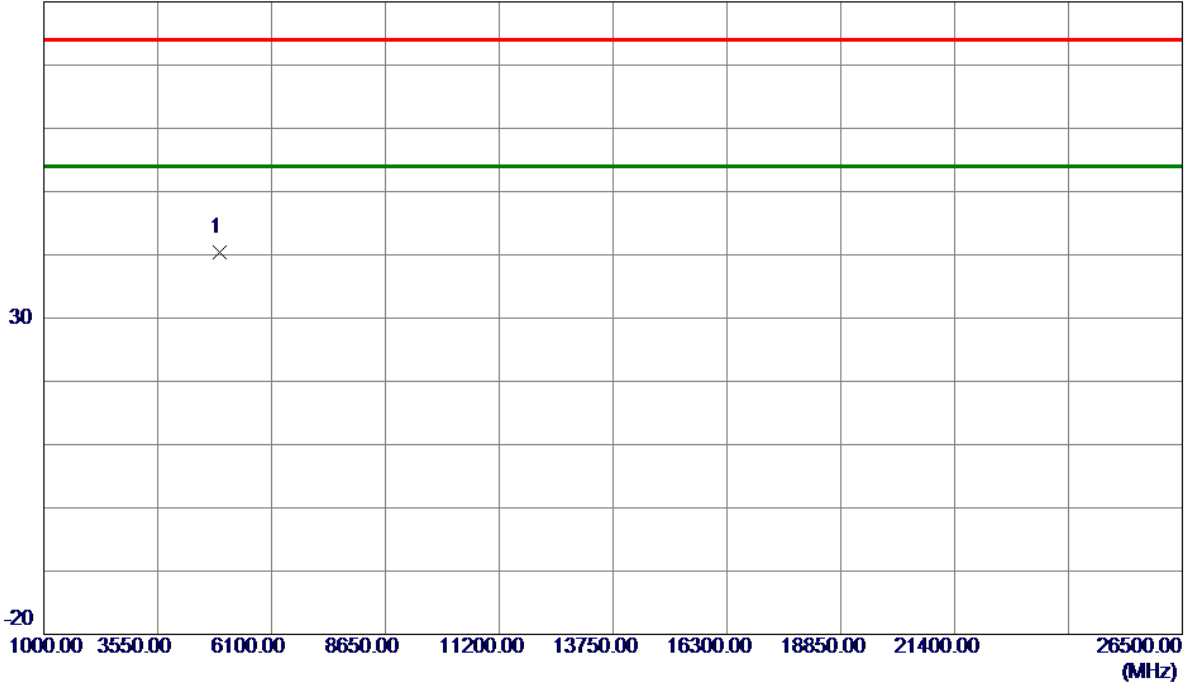

No.	Freq. MHz	Reading Level dBuV/m	Correct Factor dB	Measure ment dBuV/m	Limit dBuV/m	Margin dB	Detector	Comment
1 *	4925.8250	48.33	-7.91	40.42	74.00	-33.58	Peak	

REMARKS:

- (1) Measurement Value = Reading Level + Correct Factor.
- (2) Margin Level = Measurement Value - Limit Value.

Test Mode: TX N-20M Mode 2412 MHz

Vertical

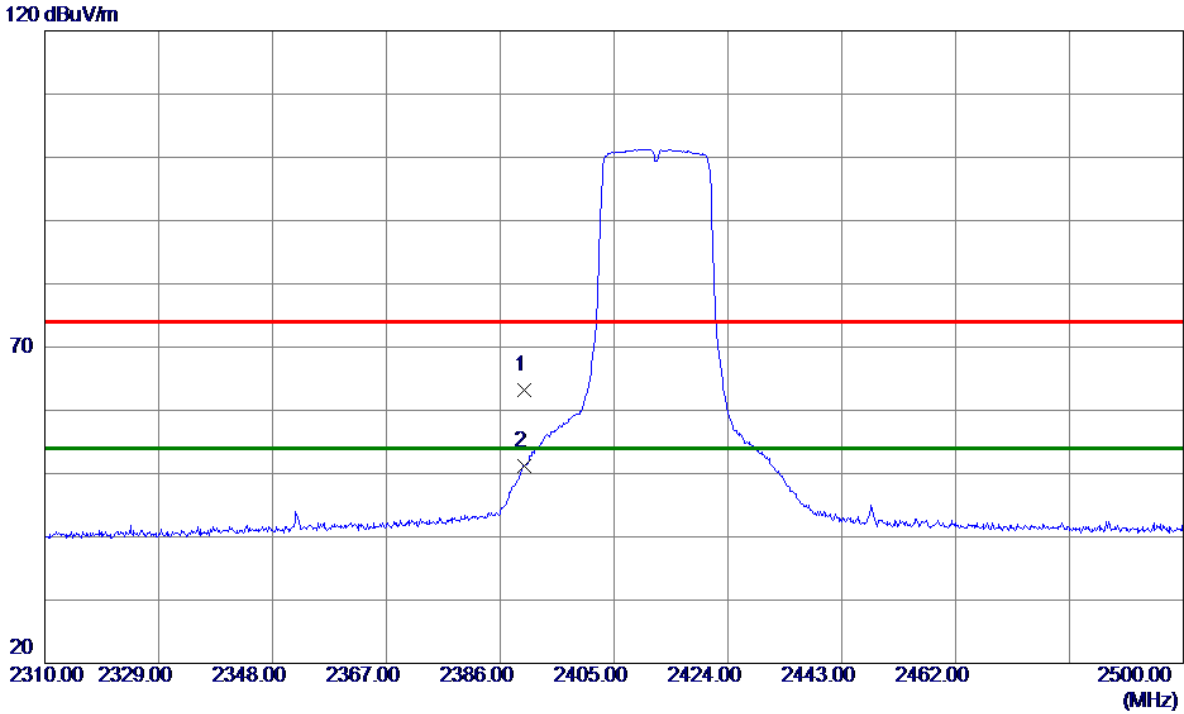

No.	Freq. MHz	Reading Level dBuV/m	Correct Factor dB	Measure ment dBuV/m	Limit dBuV/m	Margin dB	Detector	Comment
1	2390.0000	29.89	33.36	63.25	74.00	-10.75	Peak	
2 *	2390.0000	17.81	33.36	51.17	54.00	-2.83	AVG	

REMARKS:

(1) Measurement Value = Reading Level + Correct Factor.

(2) Margin Level = Measurement Value - Limit Value.

Test Mode: TX N-20M Mode 2412 MHz

Vertical

80 dBuV/m

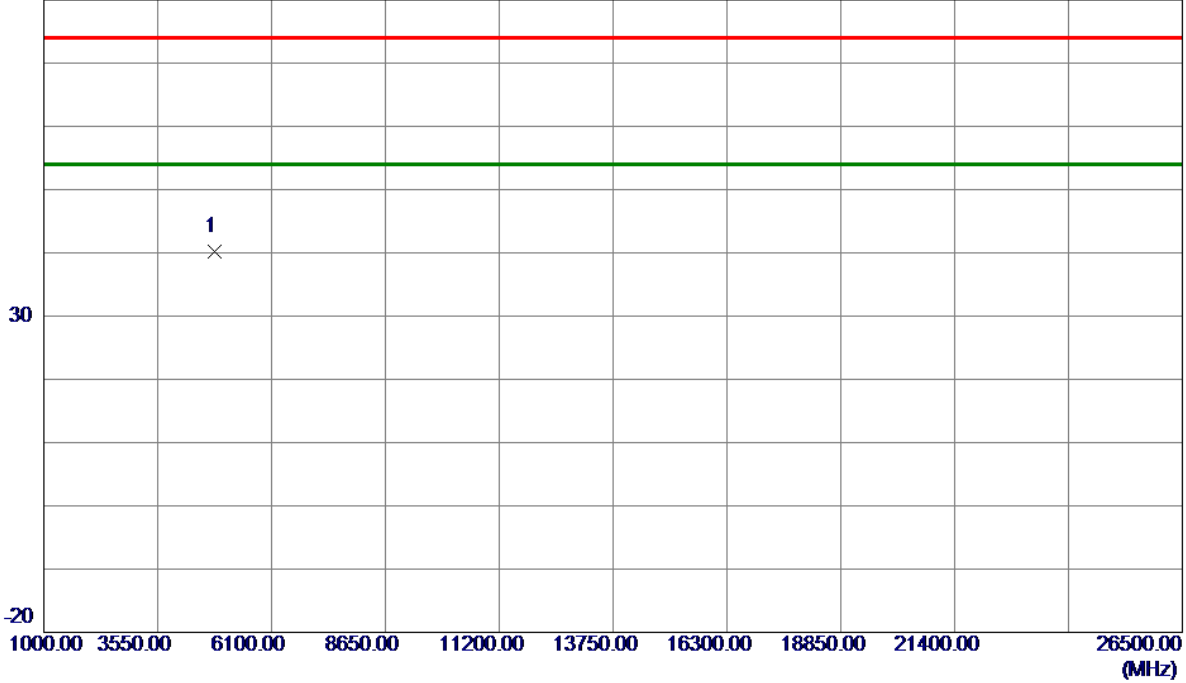

No.	Freq. MHz	Reading Level dBuV/m	Correct Factor dB	Measure ment dBuV/m	Limit dBuV/m	Margin dB	Detector	Comment
1 *	4823.6200	48.42	-8.22	40.20	74.00	-33.80	Peak	

REMARKS:

- (1) Measurement Value = Reading Level + Correct Factor.
- (2) Margin Level = Measurement Value - Limit Value.

Test Mode: TX N-20M Mode 2412 MHz

Horizontal

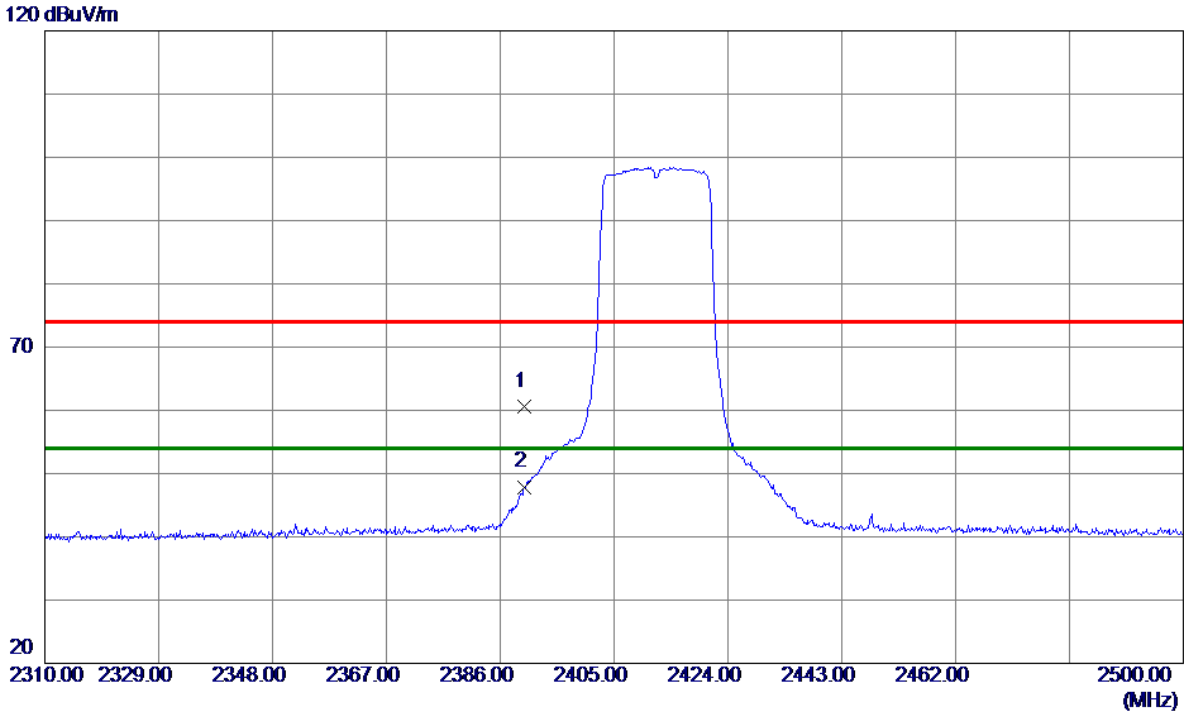

No.	Freq. MHz	Reading Level dBuV/m	Correct Factor dB	Measure ment dBuV/m	Limit dBuV/m	Margin dB	Detector	Comment
1	2390.0000	27.15	33.36	60.51	74.00	-13.49	Peak	
2 *	2390.0000	14.54	33.36	47.90	54.00	-6.10	AVG	

REMARKS:

(1) Measurement Value = Reading Level + Correct Factor.

(2) Margin Level = Measurement Value - Limit Value.

Test Mode: TX N-20M Mode 2412 MHz

Horizontal

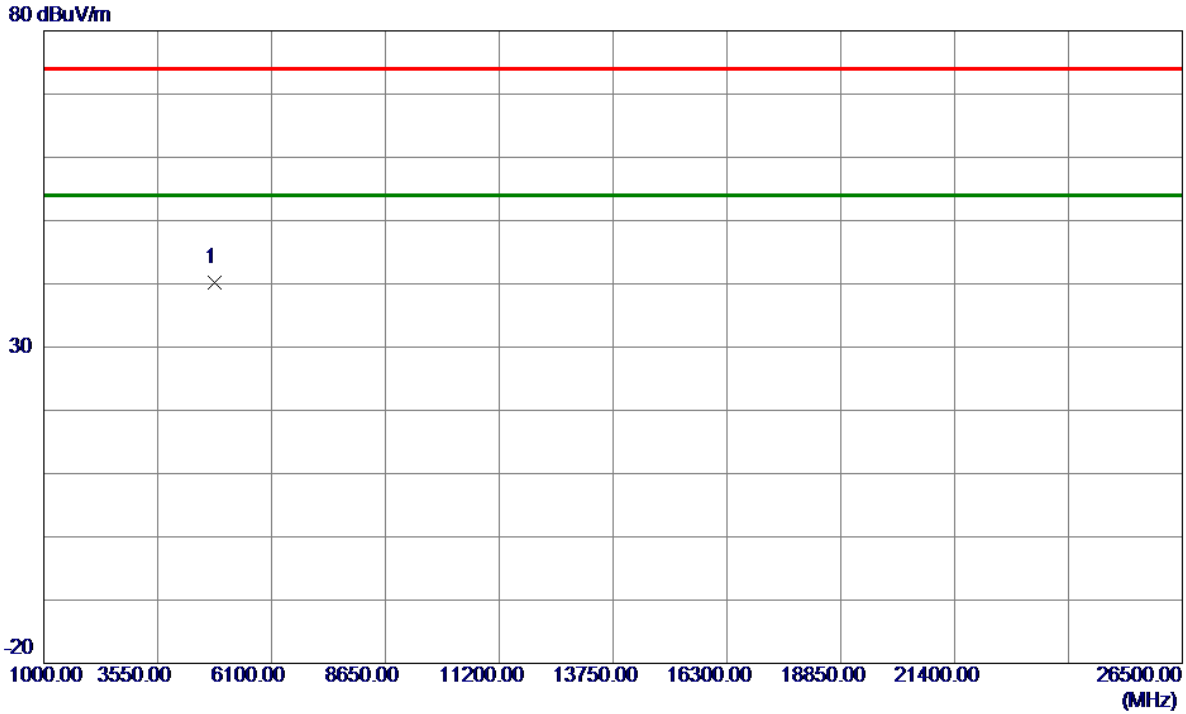

No.	Freq. MHz	Reading Level dBuV/m	Correct Factor dB	Measure ment dBuV/m	Limit dBuV/m	Margin dB	Detector	Comment
1 *	4825.3700	48.51	-8.22	40.29	74.00	-33.71	Peak	

REMARKS:

- (1) Measurement Value = Reading Level + Correct Factor.
- (2) Margin Level = Measurement Value - Limit Value.

Test Mode: TX N-20M Mode 2437 MHz

Vertical

120 dBuV/m

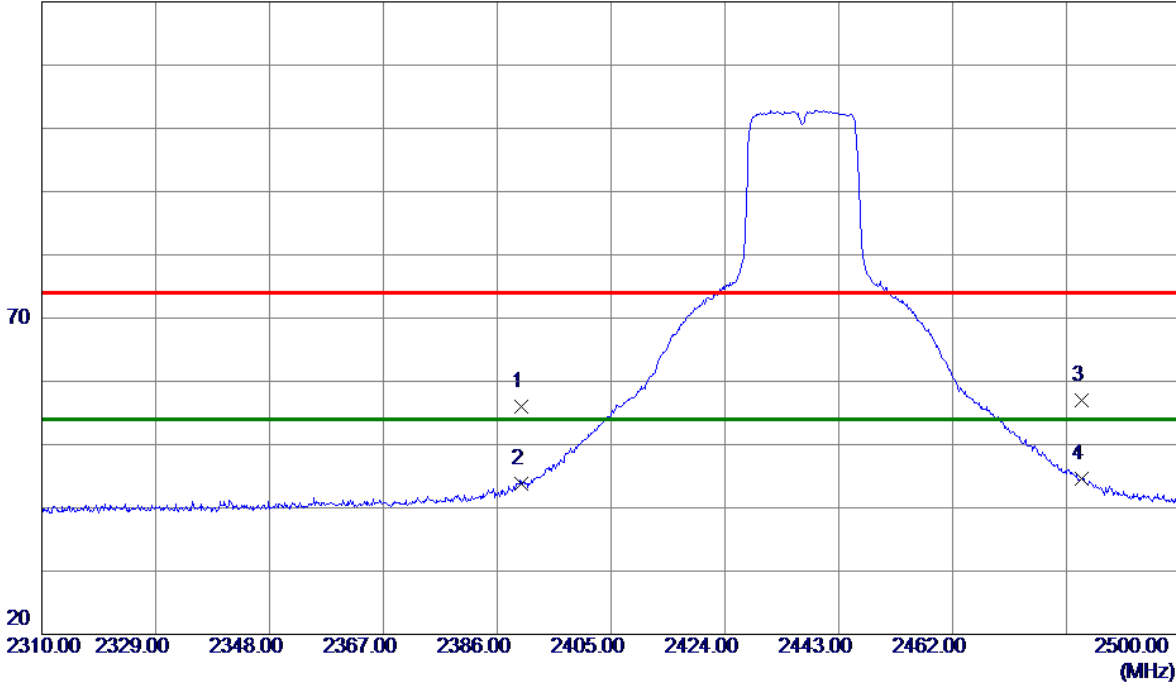

No.	Freq. MHz	Reading Level dBuV/m	Correct Factor dB	Measure ment dBuV/m	Limit dBuV/m	Margin dB	Detector	Comment
1	2390.0000	22.56	33.36	55.92	74.00	-18.08	Peak	
2	2390.0000	10.44	33.36	43.80	54.00	-10.20	AVG	
3	2483.5000	23.15	33.76	56.91	74.00	-17.09	Peak	
4 *	2483.5000	10.83	33.76	44.59	54.00	-9.41	AVG	

REMARKS:

(1) Measurement Value = Reading Level + Correct Factor.

(2) Margin Level = Measurement Value - Limit Value.

Test Mode: TX N-20M Mode 2437 MHz

Vertical

80 dBuV/m

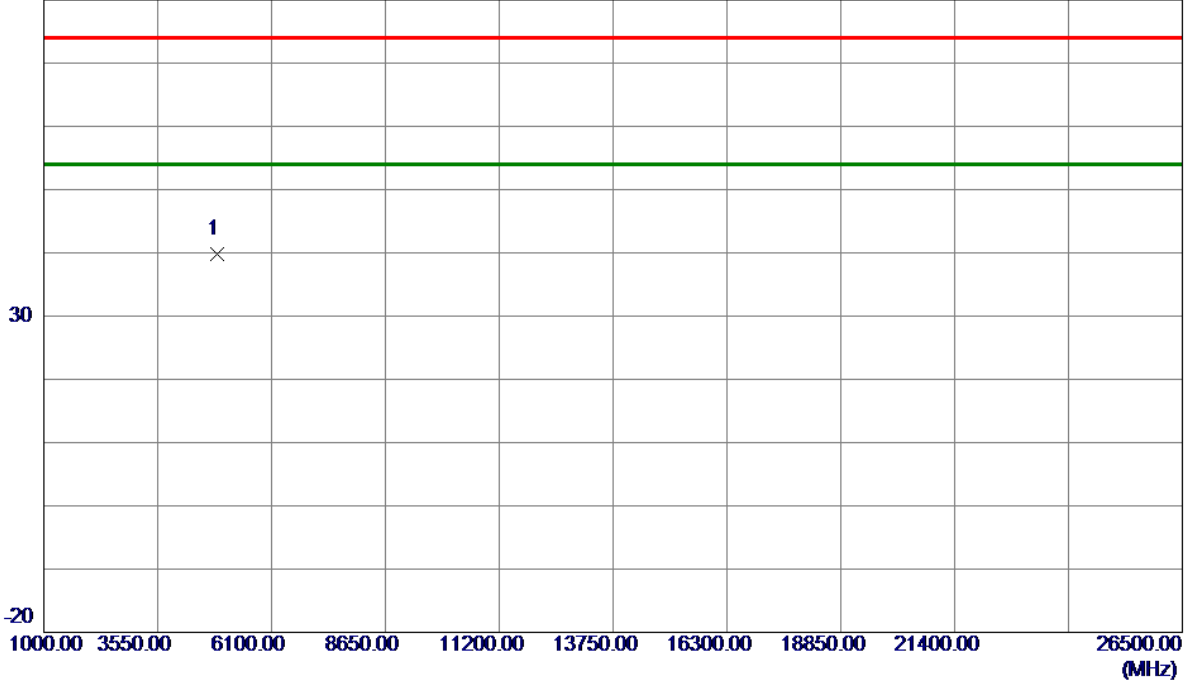

No.	Freq. MHz	Reading Level dBuV/m	Correct Factor dB	Measure ment dBuV/m	Limit dBuV/m	Margin dB	Detector	Comment
1 *	4875.7200	47.85	-8.06	39.79	74.00	-34.21	Peak	

REMARKS:

- (1) Measurement Value = Reading Level + Correct Factor.
- (2) Margin Level = Measurement Value - Limit Value.

Test Mode: TX N-20M Mode 2437 MHz

Horizontal

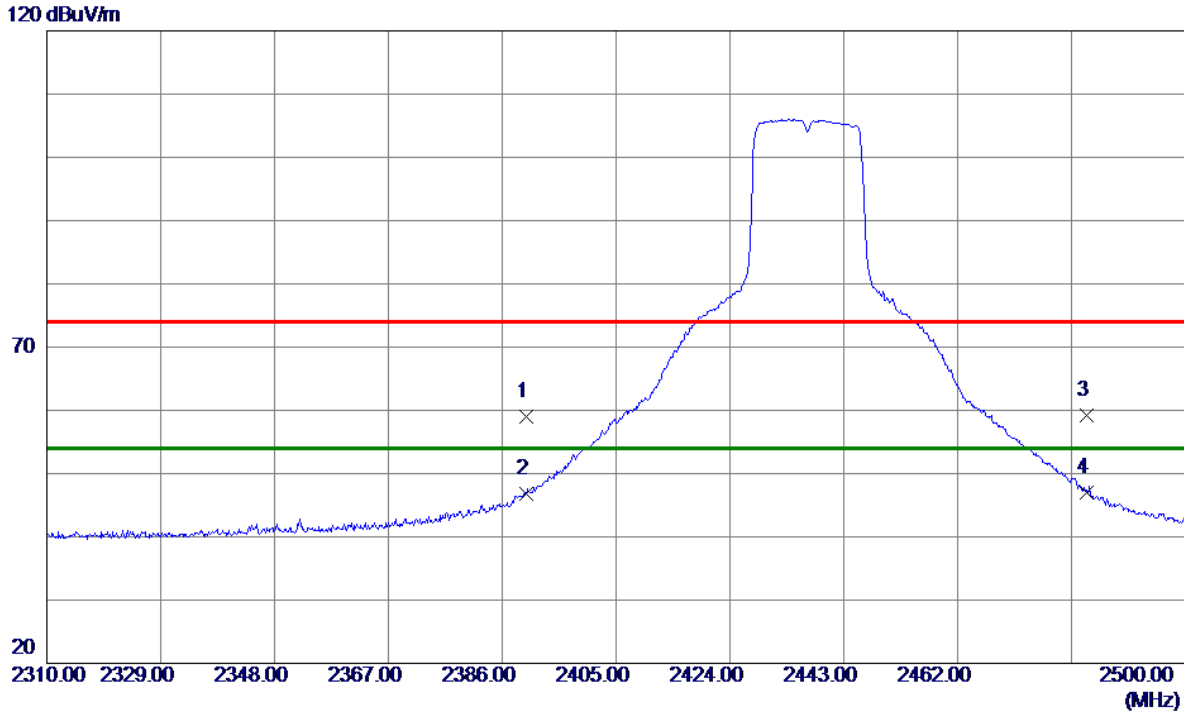

No.	Freq. MHz	Reading Level dBuV/m	Correct Factor dB	Measure ment dBuV/m	Limit dBuV/m	Margin dB	Detector	Comment
1	2390.0000	25.66	33.36	59.02	74.00	-14.98	Peak	
2	2390.0000	13.50	33.36	46.86	54.00	-7.14	AVG	
3	2483.5000	25.45	33.76	59.21	74.00	-14.79	Peak	
4 *	2483.5000	13.30	33.76	47.06	54.00	-6.94	AVG	

REMARKS:

(1) Measurement Value = Reading Level + Correct Factor.

(2) Margin Level = Measurement Value - Limit Value.

Test Mode: TX N-20M Mode 2437 MHz

Horizontal

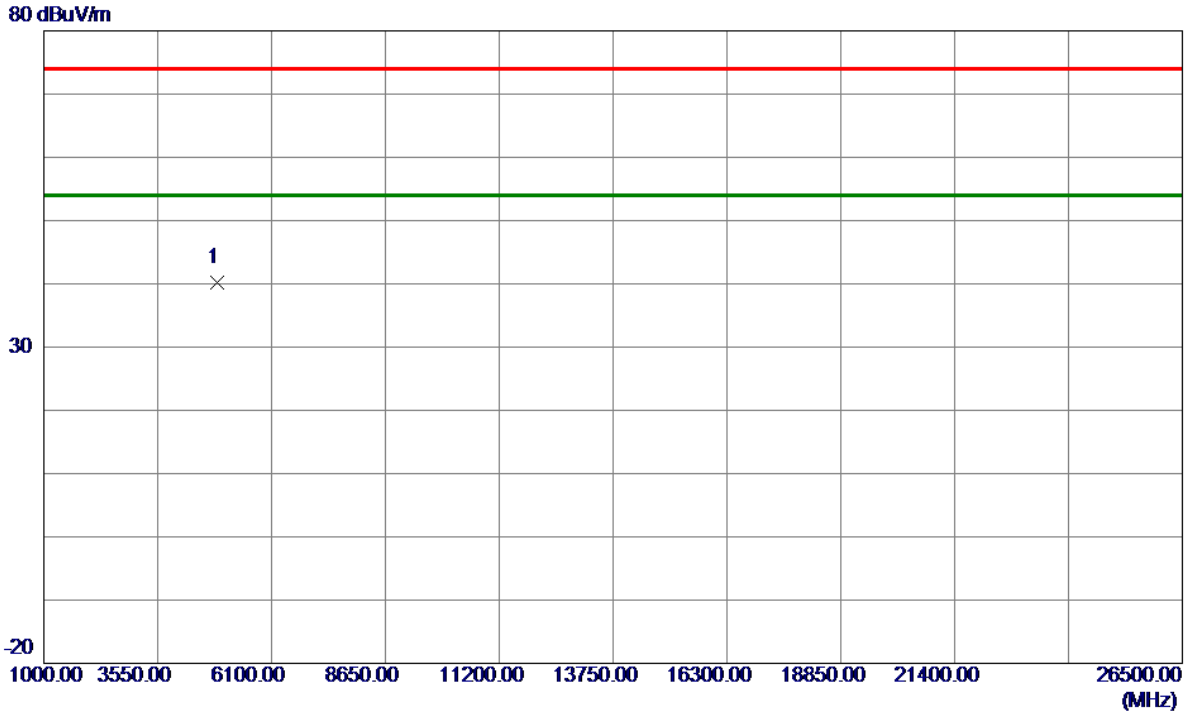

No.	Freq. MHz	Reading Level dBuV/m	Correct Factor dB	Measure ment dBuV/m	Limit dBuV/m	Margin dB	Detector	Comment
1 *	4873.9850	48.19	-8.07	40.12	74.00	-33.88	Peak	

REMARKS:

- (1) Measurement Value = Reading Level + Correct Factor.
- (2) Margin Level = Measurement Value - Limit Value.

Test Mode: TX N-20M Mode 2462 MHz

Vertical

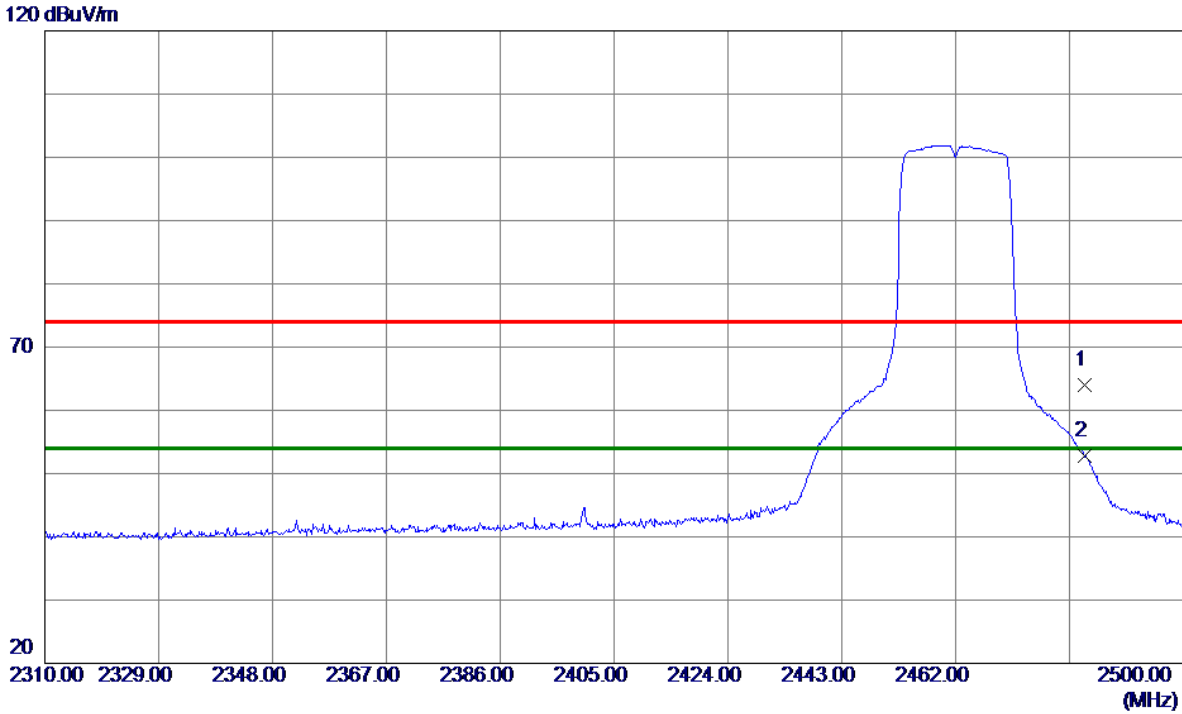

No.	Freq. MHz	Reading Level dBuV/m	Correct Factor dB	Measure ment dBuV/m	Limit dBuV/m	Margin dB	Detector	Comment
1	2483.5000	30.16	33.76	63.92	74.00	-10.08	Peak	
2 *	2483.5000	19.03	33.76	52.79	54.00	-1.21	AVG	

REMARKS:

(1) Measurement Value = Reading Level + Correct Factor.

(2) Margin Level = Measurement Value - Limit Value.

Test Mode: TX N-20M Mode 2462 MHz

Vertical

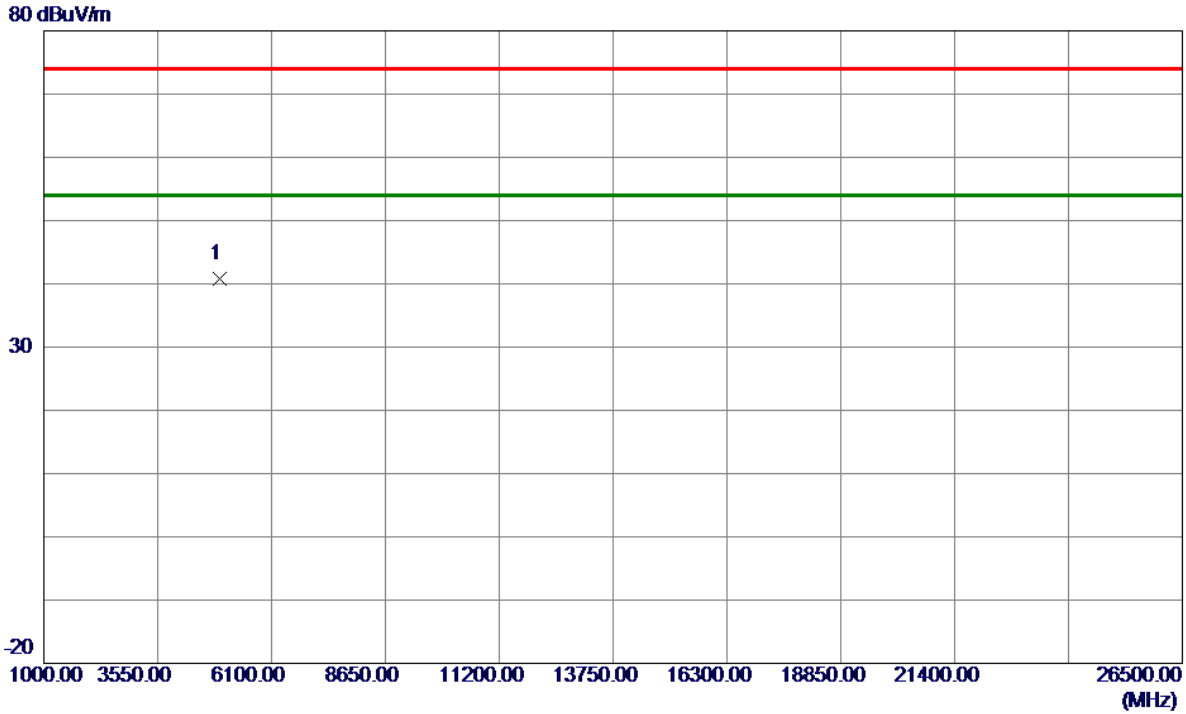

No.	Freq. MHz	Reading Level dBuV/m	Correct Factor dB	Measure ment dBuV/m	Limit dBuV/m	Margin dB	Detector	Comment
1 *	4926.4500	48.68	-7.91	40.77	74.00	-33.23	Peak	

REMARKS:

- (1) Measurement Value = Reading Level + Correct Factor.
- (2) Margin Level = Measurement Value - Limit Value.

Test Mode: TX N-20M Mode 2462 MHz

Horizontal

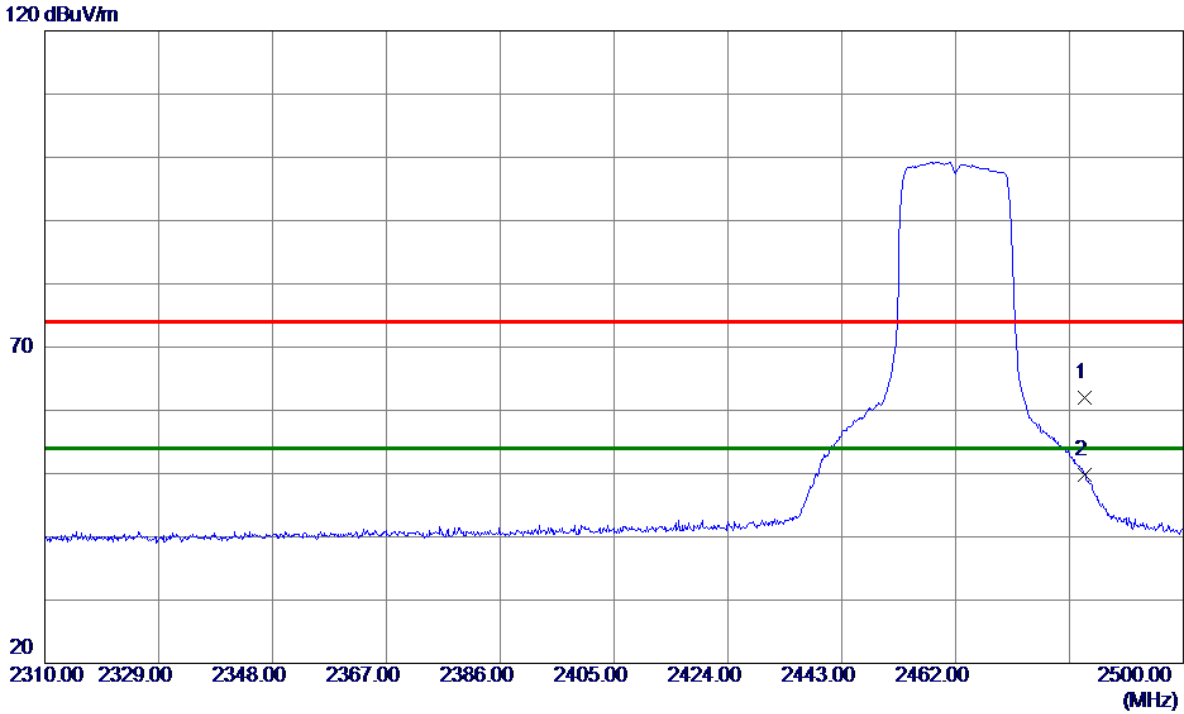

No.	Freq. MHz	Reading Level dBuV/m	Correct Factor dB	Measure ment dBuV/m	Limit dBuV/m	Margin dB	Detector	Comment
1	2483.5000	28.15	33.76	61.91	74.00	-12.09	Peak	
2 *	2483.5000	15.99	33.76	49.75	54.00	-4.25	AVG	

REMARKS:

- (1) Measurement Value = Reading Level + Correct Factor.
- (2) Margin Level = Measurement Value - Limit Value.

Test Mode: TX N-20M Mode 2462 MHz

Horizontal

80 dBuV/m

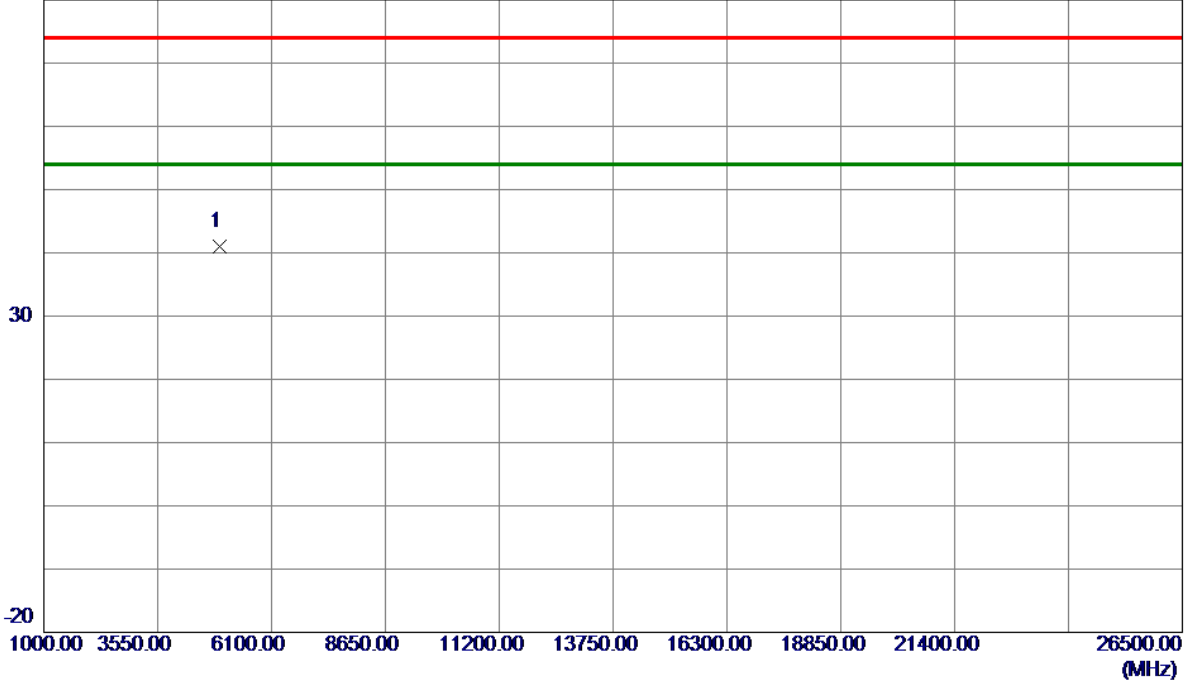

No.	Freq. MHz	Reading Level dBuV/m	Correct Factor dB	Measure ment dBuV/m	Limit dBuV/m	Margin dB	Detector	Comment
1 *	4924.2250	48.95	-7.91	41.04	74.00	-32.96	Peak	

REMARKS:

- (1) Measurement Value = Reading Level + Correct Factor.
- (2) Margin Level = Measurement Value - Limit Value.

Test Mode: TX N-40M Mode 2422MHz

Vertical

120 dBuV/m

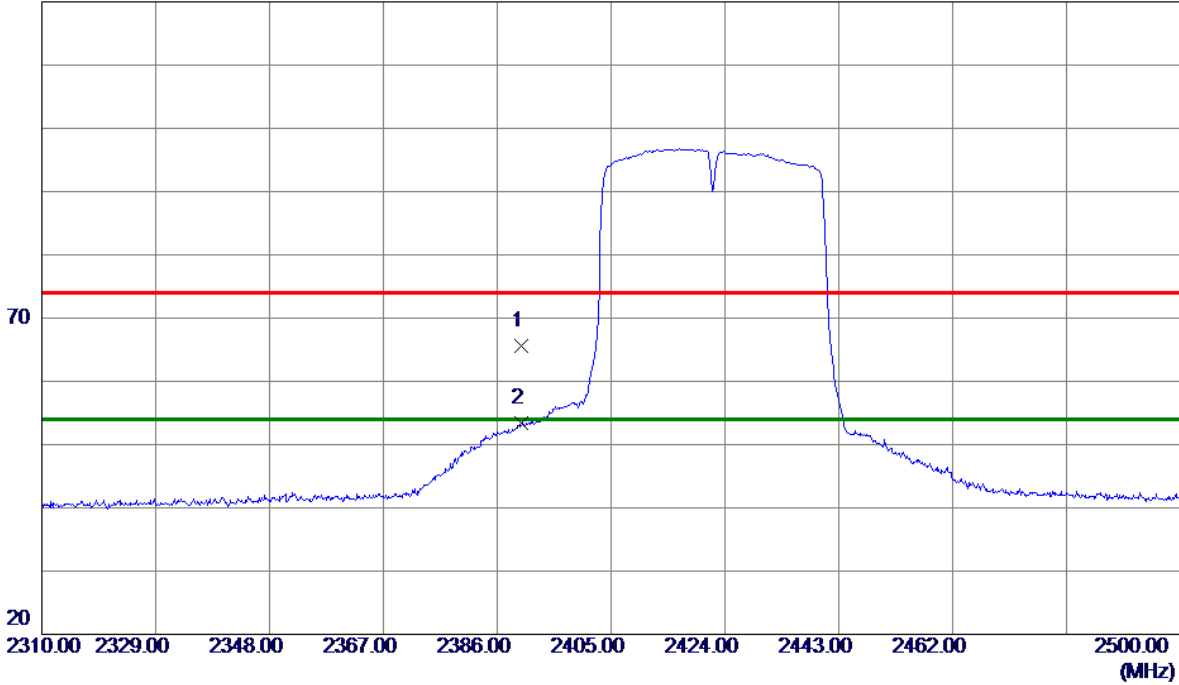

No.	Freq. MHz	Reading Level dBuV/m	Correct Factor dB	Measure ment dBuV/m	Limit dBuV/m	Margin dB	Detector	Comment
1	2390.0000	32.16	33.36	65.52	74.00	-8.48	Peak	
2 *	2390.0000	20.08	33.36	53.44	54.00	-0.56	AVG	

REMARKS:

(1) Measurement Value = Reading Level + Correct Factor.

(2) Margin Level = Measurement Value - Limit Value.

Test Mode: TX N-40M Mode 2422MHz

Vertical

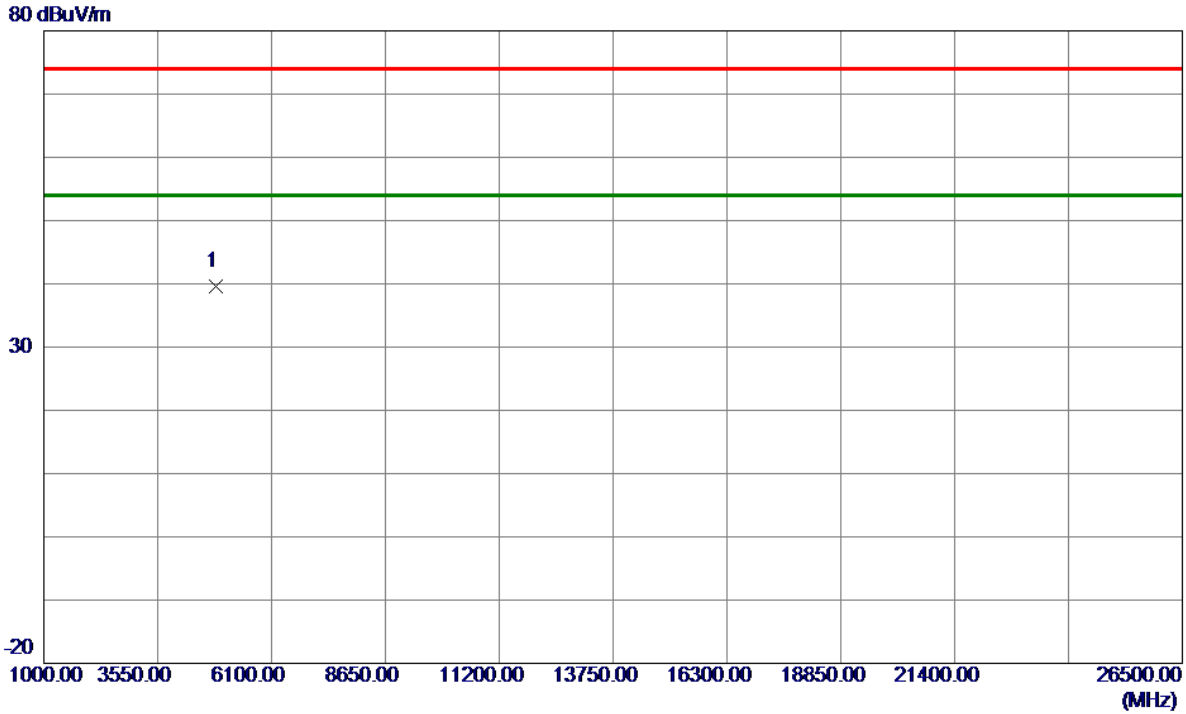

No.	Freq. MHz	Reading Level dBuV/m	Correct Factor dB	Measure ment dBuV/m	Limit dBuV/m	Margin dB	Detector	Comment
1 *	4843.2650	47.85	-8.16	39.69	74.00	-34.31	Peak	

REMARKS:

- (1) Measurement Value = Reading Level + Correct Factor.
- (2) Margin Level = Measurement Value - Limit Value.

Test Mode: TX N-40M Mode 2422MHz

Horizontal

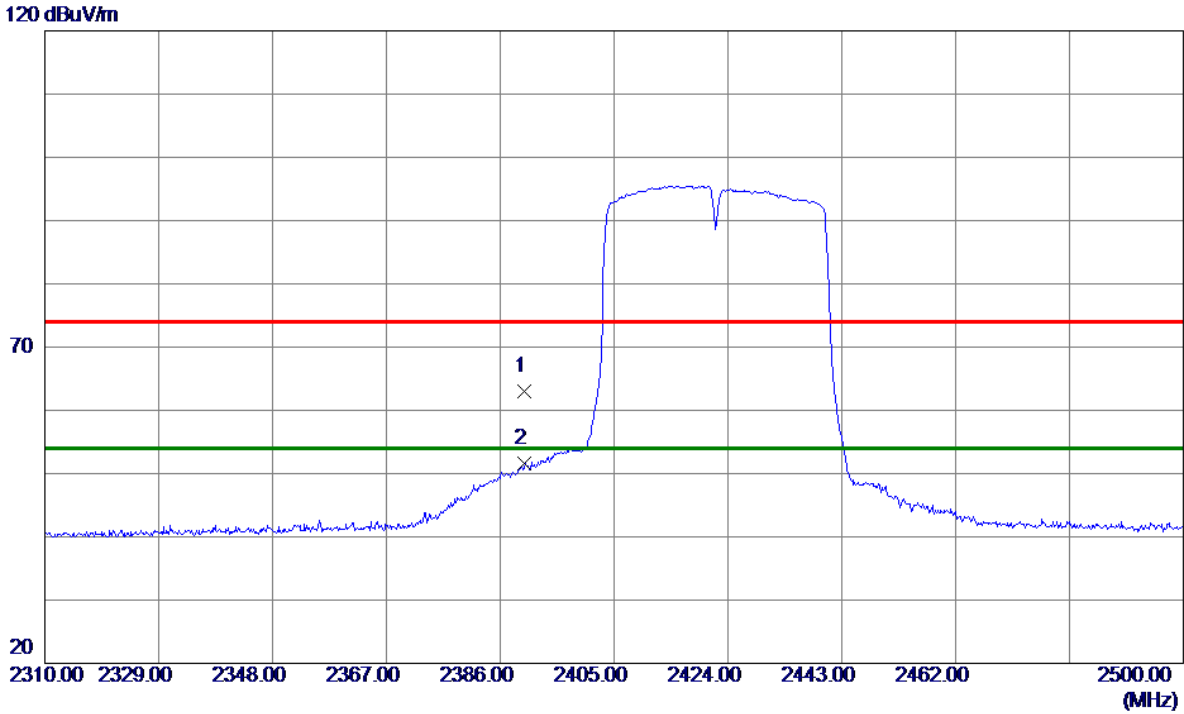

No.	Freq. MHz	Reading Level dBuV/m	Correct Factor dB	Measure ment dBuV/m	Limit dBuV/m	Margin dB	Detector	Comment
1	2390.0000	29.66	33.36	63.02	74.00	-10.98	Peak	
2 *	2390.0000	18.19	33.36	51.55	54.00	-2.45	AVG	

REMARKS:

(1) Measurement Value = Reading Level + Correct Factor.

(2) Margin Level = Measurement Value - Limit Value.

Test Mode: TX N-40M Mode 2422MHz

Horizontal

80 dBuV/m

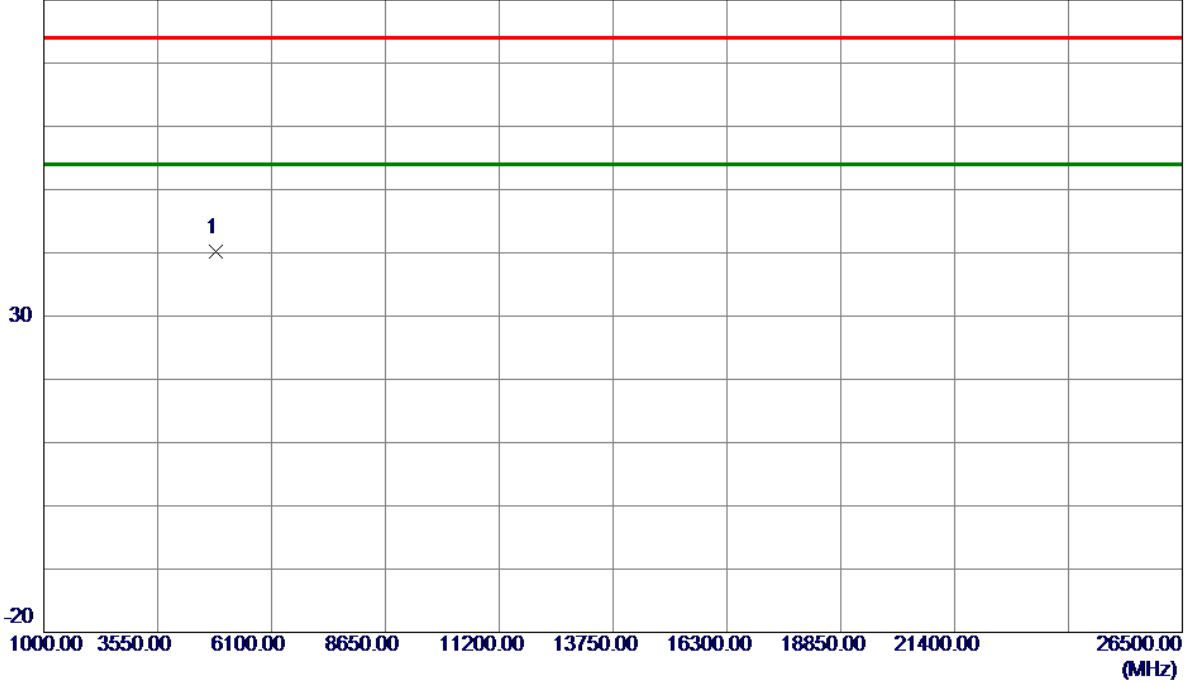

No.	Freq. MHz	Reading Level dBuV/m	Correct Factor dB	Measure ment dBuV/m	Limit dBuV/m	Margin dB	Detector	Comment
1 *	4844.5000	48.26	-8.16	40.10	74.00	-33.90	Peak	

REMARKS:

- (1) Measurement Value = Reading Level + Correct Factor.
- (2) Margin Level = Measurement Value - Limit Value.

Test Mode: TX N-40M Mode 2437 MHz

Vertical

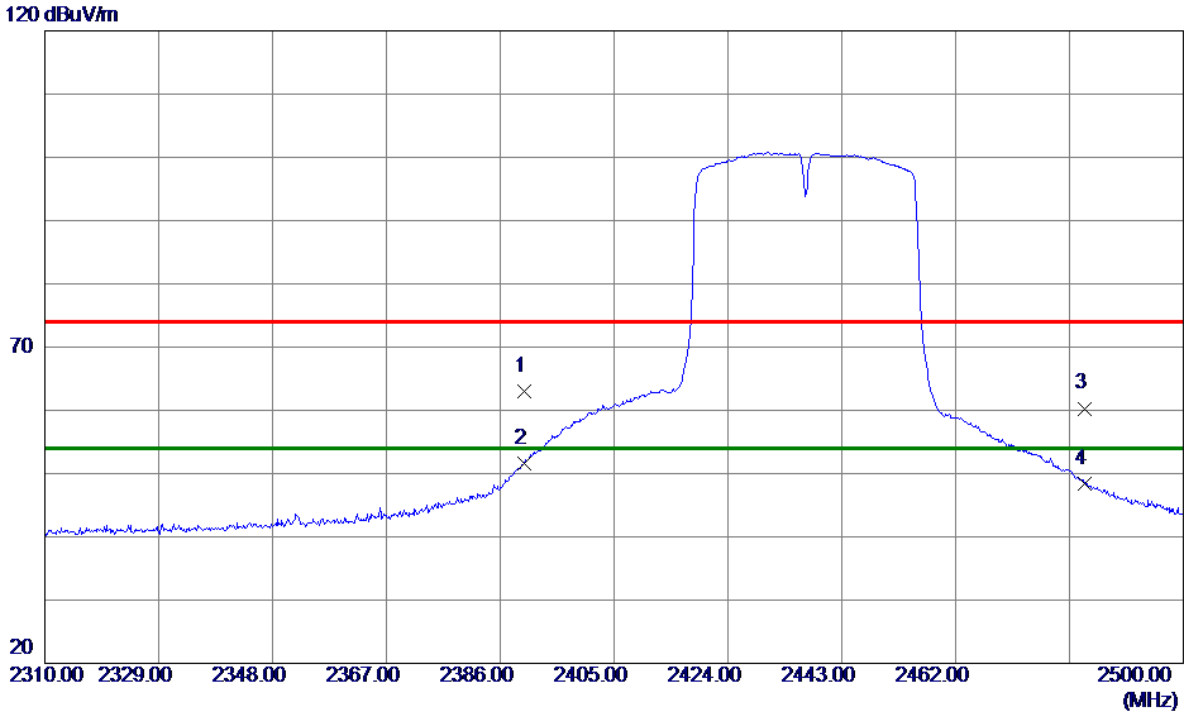

No.	Freq. MHz	Reading Level dBuV/m	Correct Factor dB	Measure ment dBuV/m	Limit dBuV/m	Margin dB	Detector	Comment
1	2390.0000	29.66	33.36	63.02	74.00	-10.98	Peak	
2 *	2390.0000	18.23	33.36	51.59	54.00	-2.41	AVG	
3	2483.5000	26.54	33.76	60.30	74.00	-13.70	Peak	
4	2483.5000	14.66	33.76	48.42	54.00	-5.58	AVG	

REMARKS:

- (1) Measurement Value = Reading Level + Correct Factor.
- (2) Margin Level = Measurement Value - Limit Value.

Test Mode: TX N-40M Mode 2437 MHz

Vertical

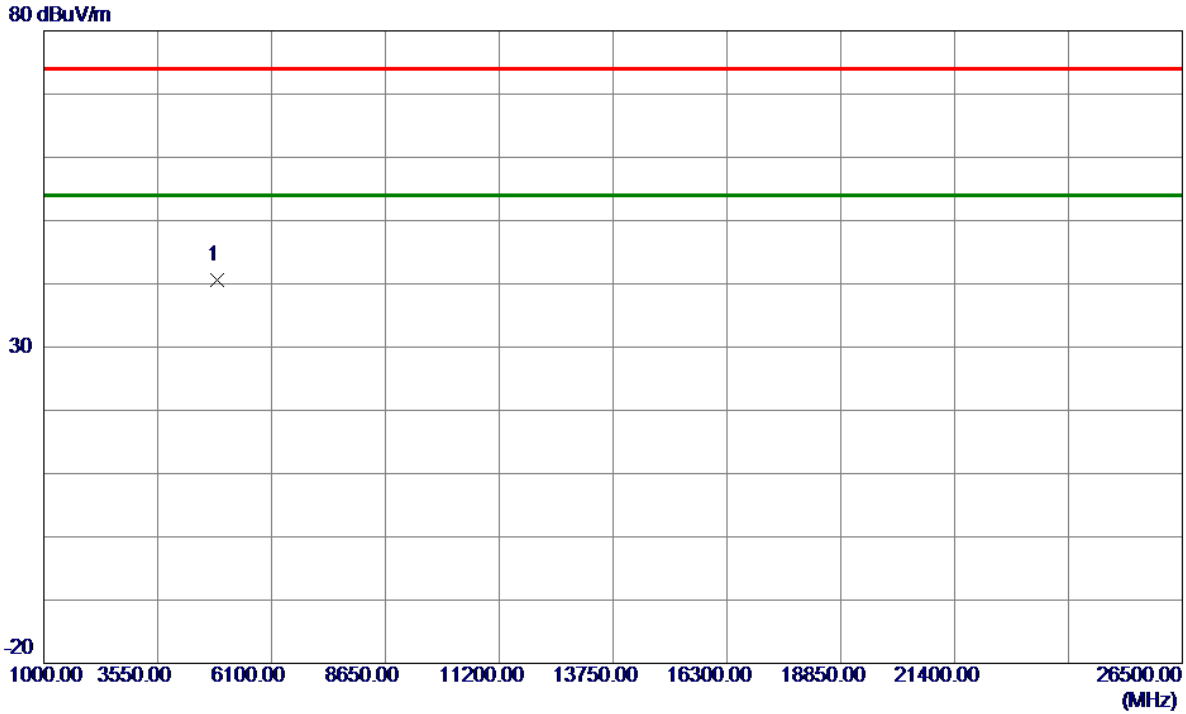

No.	Freq. MHz	Reading Level dBuV/m	Correct Factor dB	Measure ment dBuV/m	Limit dBuV/m	Margin dB	Detector	Comment
1 *	4871.6549	48.75	-8.08	40.67	74.00	-33.33	Peak	

REMARKS:

- (1) Measurement Value = Reading Level + Correct Factor.
- (2) Margin Level = Measurement Value - Limit Value.

Test Mode: TX N-40M Mode 2437 MHz

Horizontal

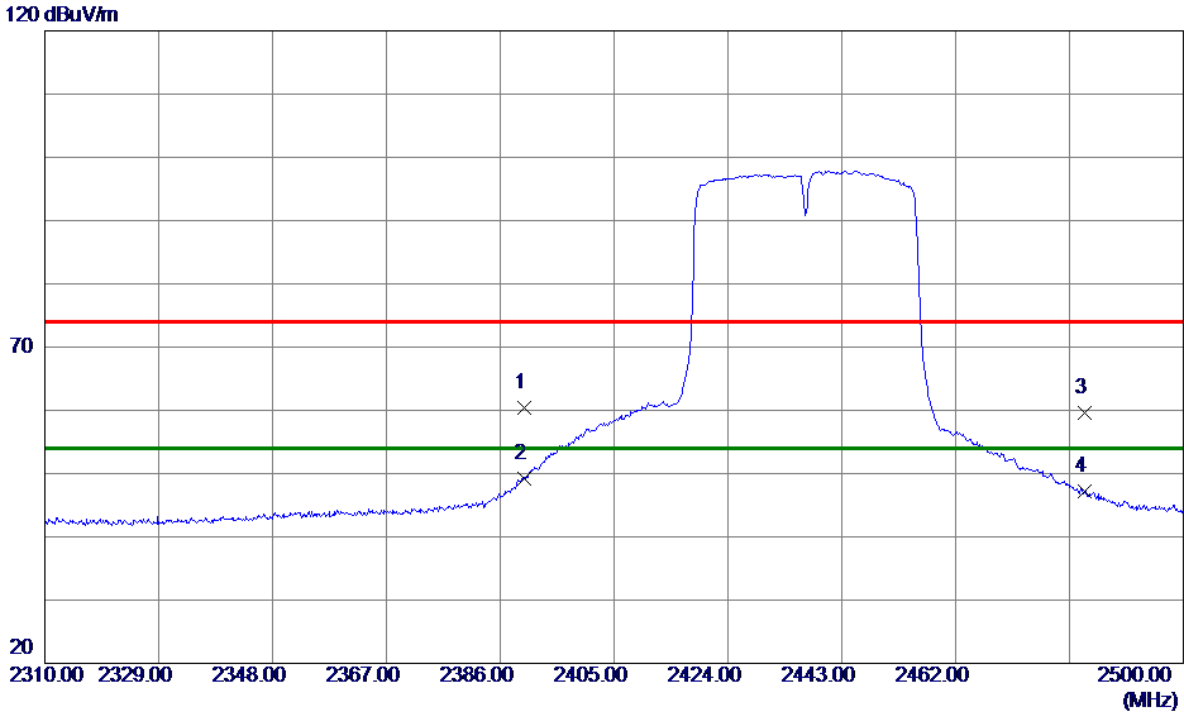

No.	Freq. MHz	Reading Level dBuV/m	Correct Factor dB	Measure ment dBuV/m	Limit dBuV/m	Margin dB	Detector	Comment
1	2390.0000	27.11	33.36	60.47	74.00	-13.53	Peak	
2 *	2390.0000	15.77	33.36	49.13	54.00	-4.87	AVG	
3	2483.5000	25.84	33.76	59.60	74.00	-14.40	Peak	
4	2483.5000	13.41	33.76	47.17	54.00	-6.83	AVG	

REMARKS:

(1) Measurement Value = Reading Level + Correct Factor.

(2) Margin Level = Measurement Value - Limit Value.

Test Mode: TX N-40M Mode 2437 MHz

Horizontal

80 dBuV/m

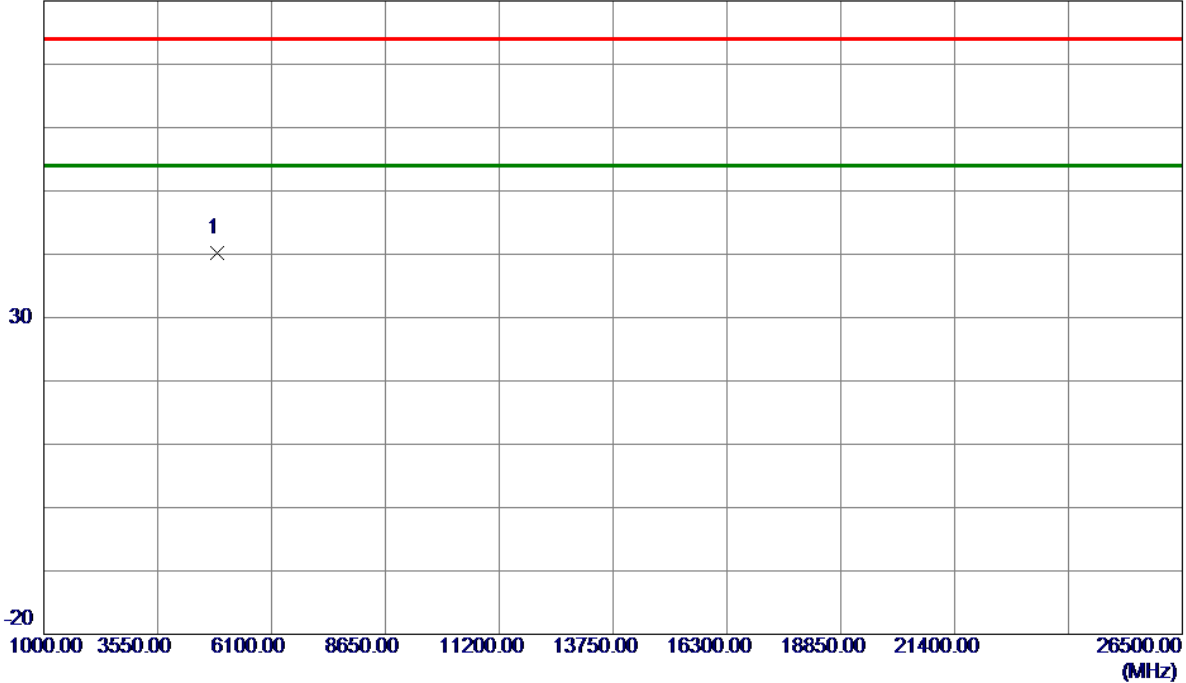

No.	Freq. MHz	Reading Level dBuV/m	Correct Factor dB	Measure ment dBuV/m	Limit dBuV/m	Margin dB	Detector	Comment
1 *	4871.9550	48.27	-8.07	40.20	74.00	-33.80	Peak	

REMARKS:

- (1) Measurement Value = Reading Level + Correct Factor.
- (2) Margin Level = Measurement Value - Limit Value.

Test Mode: TX N-40M Mode 2452 MHz

Vertical

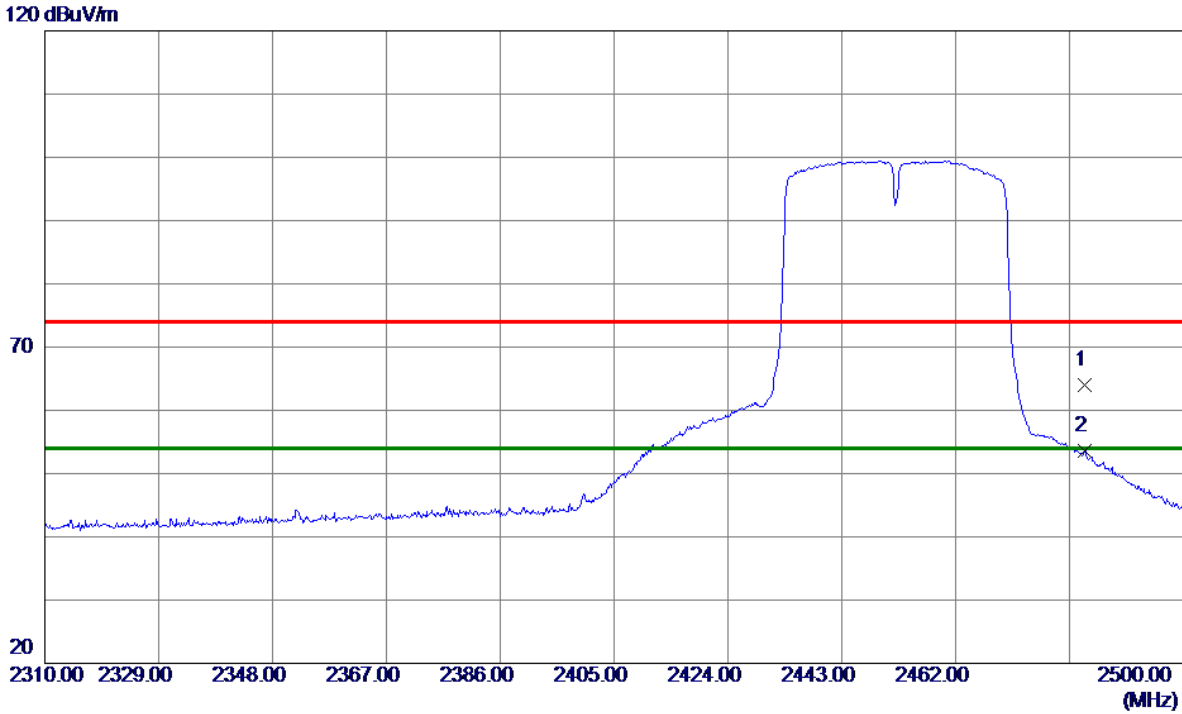

No.	Freq. MHz	Reading Level dBuV/m	Correct Factor dB	Measure ment dBuV/m	Limit dBuV/m	Margin dB	Detector	Comment
1	2483.5000	30.26	33.76	64.02	74.00	-9.98	Peak	
2 *	2483.5000	19.84	33.76	53.60	54.00	-0.40	AVG	

REMARKS:

(1) Measurement Value = Reading Level + Correct Factor.

(2) Margin Level = Measurement Value - Limit Value.

Test Mode: TX N-40M Mode 2452 MHz

Vertical

80 dBuV/m

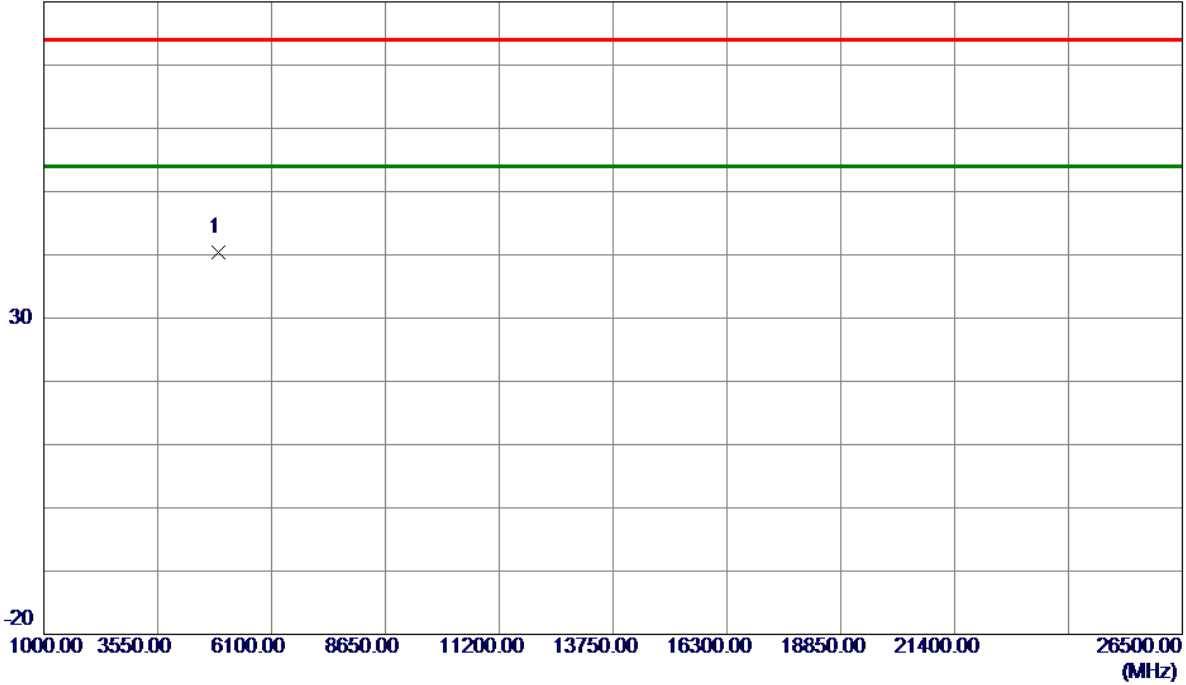

No.	Freq. MHz	Reading Level dBuV/m	Correct Factor dB	Measure ment dBuV/m	Limit dBuV/m	Margin dB	Detector	Comment
1 *	4901.9000	48.42	-7.98	40.44	74.00	-33.56	Peak	

REMARKS:

- (1) Measurement Value = Reading Level + Correct Factor.
- (2) Margin Level = Measurement Value - Limit Value.

Test Mode: TX N-40M Mode 2452 MHz

Horizontal

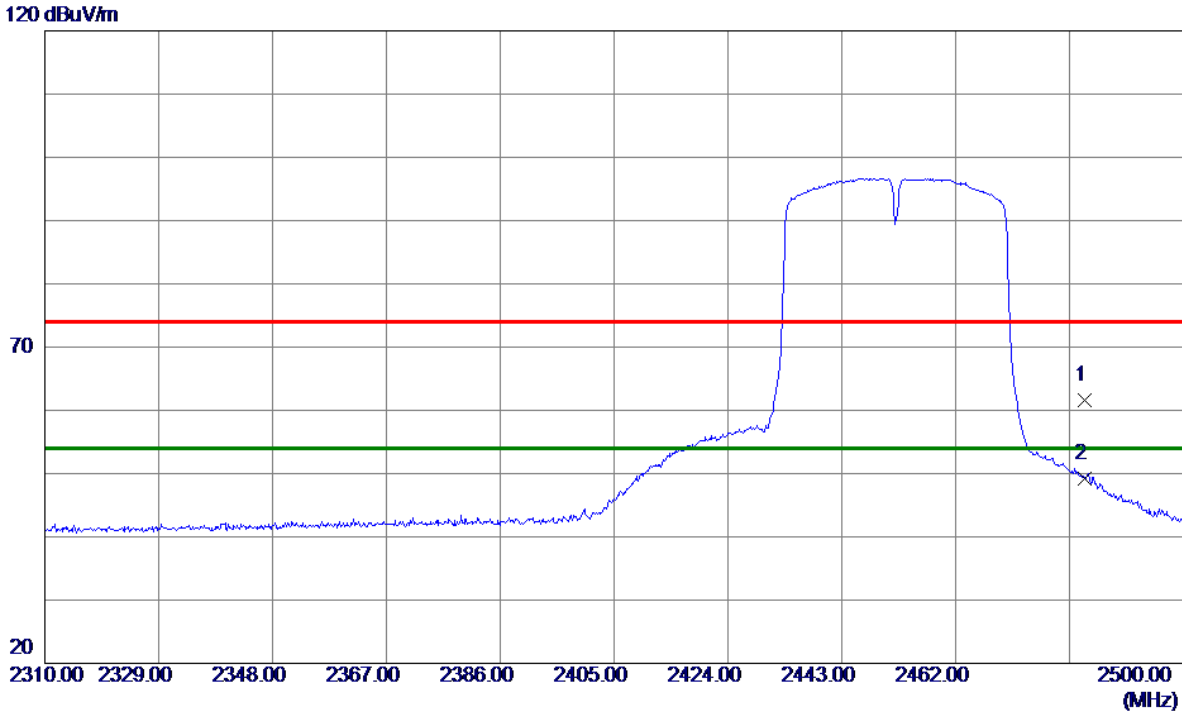

No.	Freq. MHz	Reading Level dBuV/m	Correct Factor dB	Measure ment dBuV/m	Limit dBuV/m	Margin dB	Detector	Comment
1	2483.5000	27.89	33.76	61.65	74.00	-12.35	Peak	
2 *	2483.5000	15.39	33.76	49.15	54.00	-4.85	AVG	

REMARKS:

(1) Measurement Value = Reading Level + Correct Factor.

(2) Margin Level = Measurement Value - Limit Value.

Test Mode: TX N-40M Mode 2452 MHz

Horizontal

80 dBuV/m

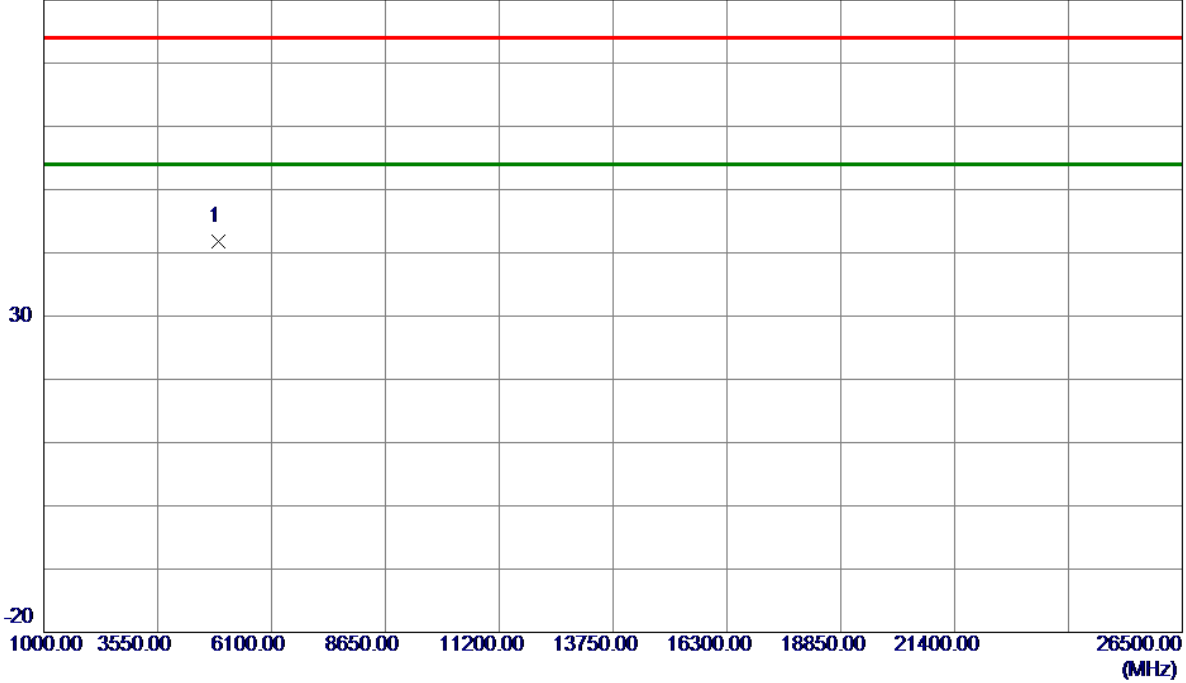

No.	Freq. MHz	Reading Level dBuV/m	Correct Factor dB	Measure ment dBuV/m	Limit dBuV/m	Margin dB	Detector	Comment
1 *	4901.7350	49.82	-7.98	41.84	74.00	-32.16	Peak	

REMARKS:

- (1) Measurement Value = Reading Level + Correct Factor.
- (2) Margin Level = Measurement Value - Limit Value.

Test Mode: TX AC-20M Mode 2412 MHz

Vertical

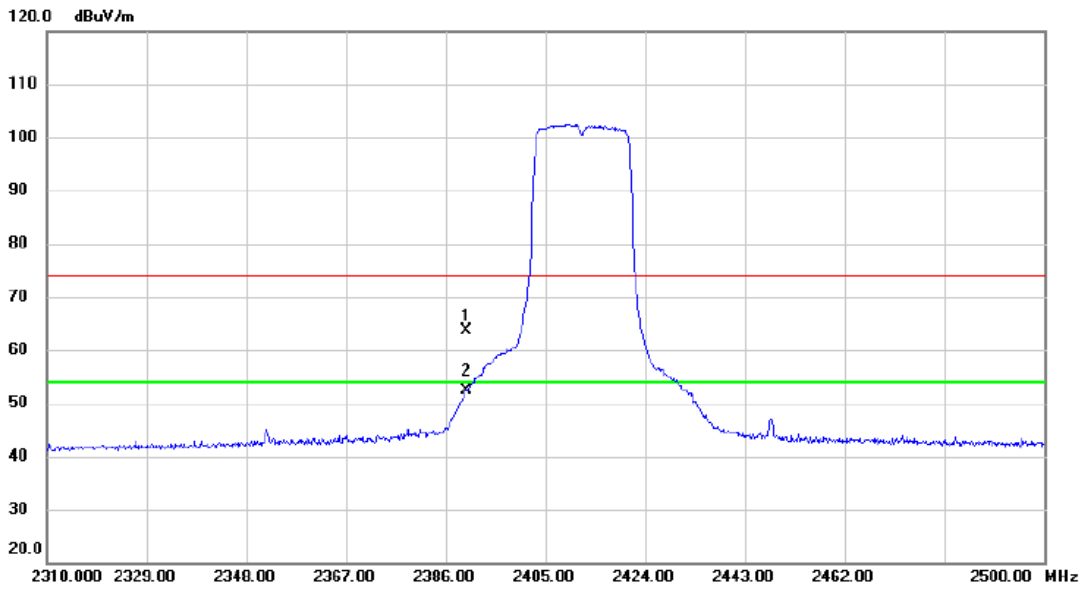

No.	Mk.	Freq. MHz	Reading Level dBuV	Correct Factor dB	Measure- ment dBuV/m	Limit dBuV/m	Margin dB	Detector	Comment
1		2390.000	30.16	33.36	63.52	74.00	-10.48	peak	
2	*	2390.000	19.04	33.36	52.40	54.00	-1.60	AVG	

REMARKS:

- (1) Measurement Value = Reading Level + Correct Factor.
- (2) Margin Level = Measurement Value - Limit Value.

Test Mode: TX AC-20M Mode 2412 MHz

Vertical

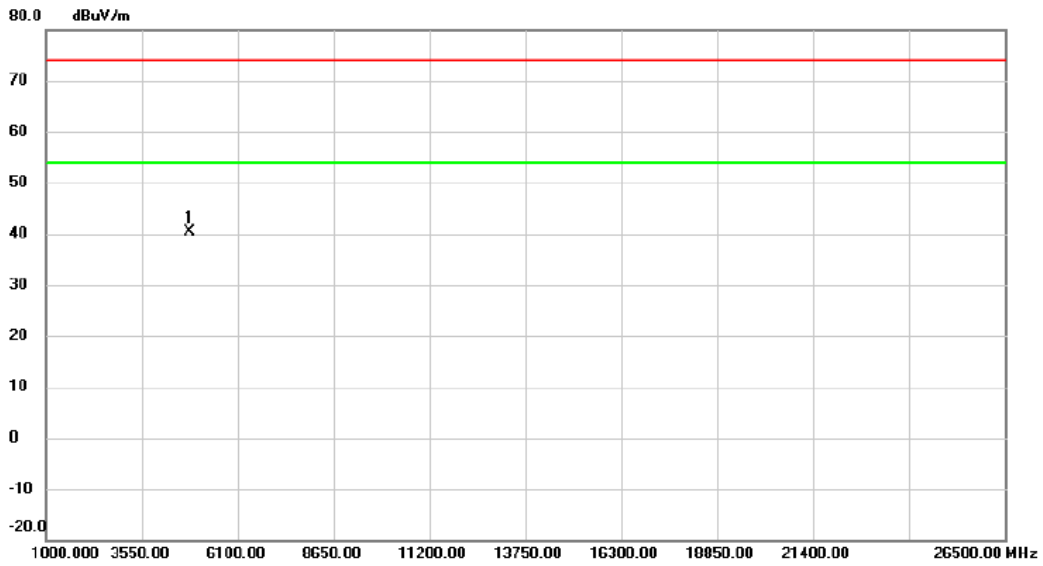

No.	Mk.	Freq.	Reading Level	Correct Factor	Measurement	Limit	Margin	Detector	Comment
		MHz	dBuV	dB	dBuV/m	dBuV/m	dB		
1	*	4825.410	48.51	-8.22	40.29	74.00	-33.71	peak	

REMARKS:

- (1) Measurement Value = Reading Level + Correct Factor.
- (2) Margin Level = Measurement Value - Limit Value.

Test Mode: TX AC-20M Mode 2412 MHz

Horizontal

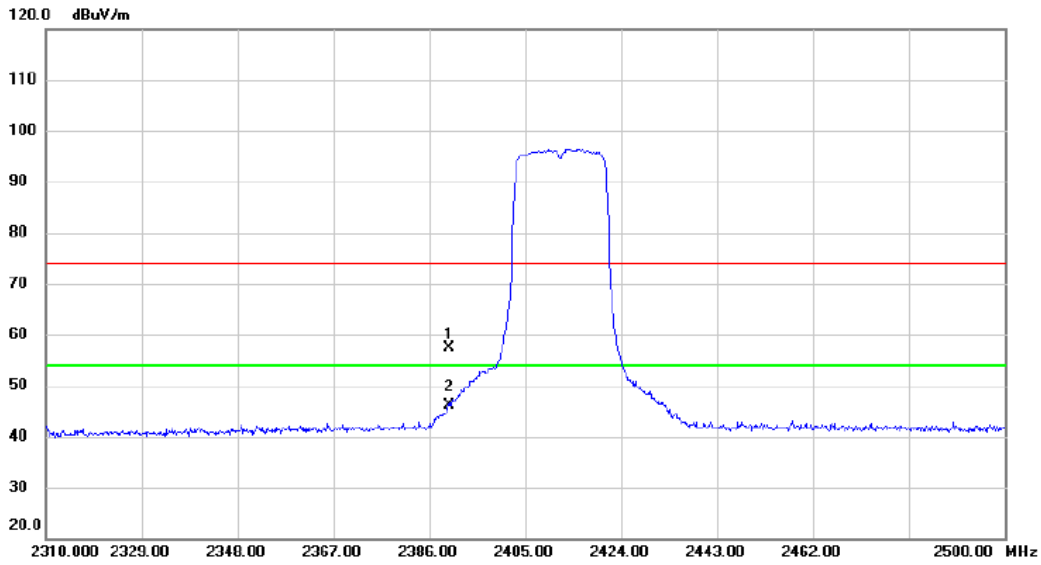

No. Mk.	Freq. MHz	Reading Level dBuV	Correct Factor dB	Measure- ment dBuV/m	Limit dBuV/m	Margin dB	Detector	Comment
1	2390.000	23.95	33.36	57.31	74.00	-16.69	peak	
2 *	2390.000	12.75	33.36	46.11	54.00	-7.89	AVG	

REMARKS:

(1) Measurement Value = Reading Level + Correct Factor.

(2) Margin Level = Measurement Value - Limit Value.

Test Mode: TX AC-20M Mode 2412 MHz

Horizontal

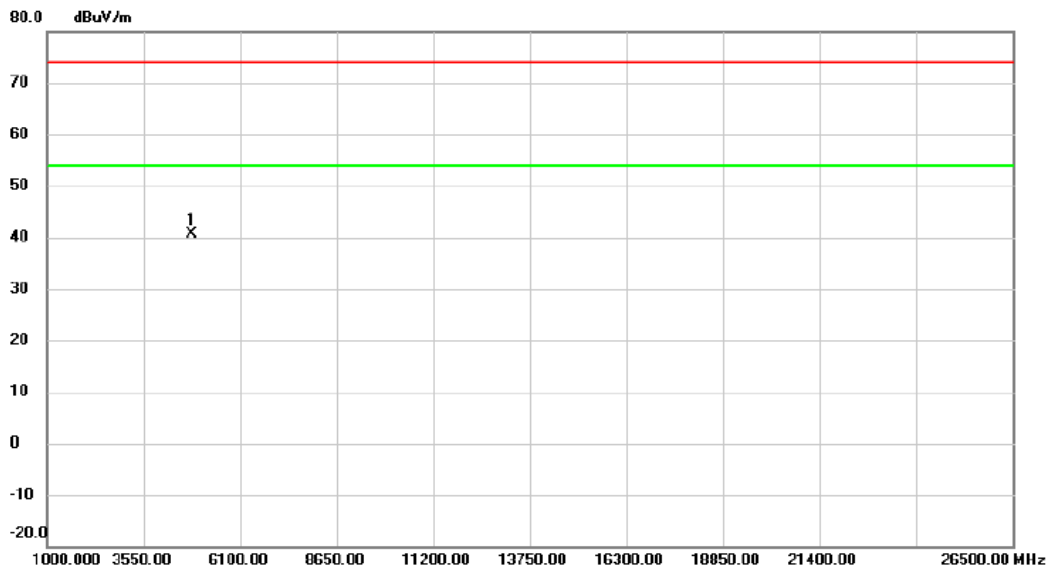

No.	Mk.	Freq. MHz	Reading Level dBuV	Correct Factor dB	Measure- ment dBuV/m	Limit dBuV/m	Margin dB	Detector	Comment
1	*	4823.250	48.90	-8.23	40.67	74.00	-33.33	peak	

REMARKS:

- (1) Measurement Value = Reading Level + Correct Factor.
- (2) Margin Level = Measurement Value - Limit Value.

Test Mode: TX AC-20M Mode 2437 MHz

Vertical

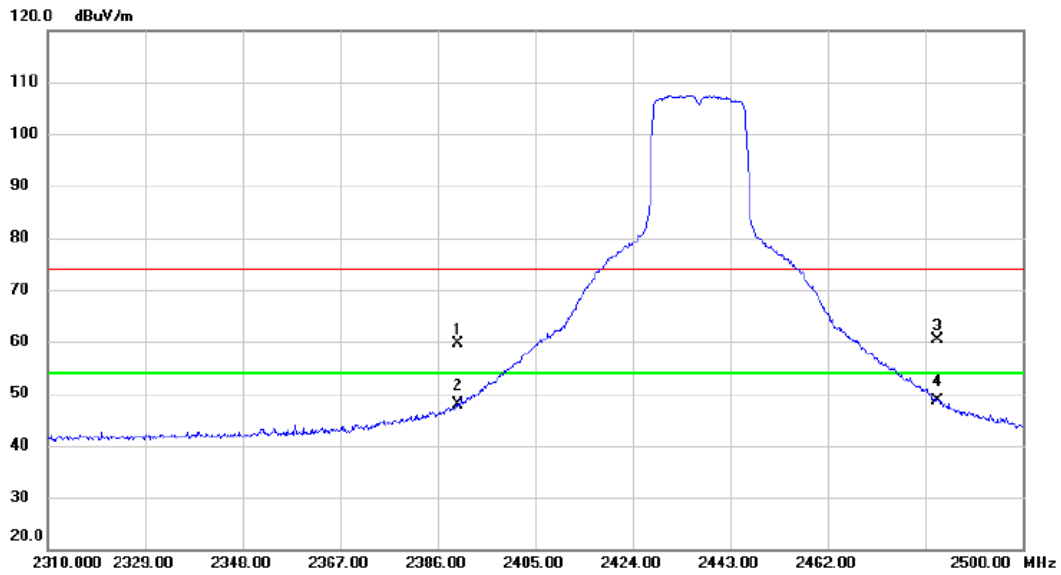

No.	Mk.	Freq. MHz	Reading Level dBuV	Correct Factor dB	Measure- ment dBuV/m	Limit dBuV/m	Margin dB	Detector	Comment
1		2390.000	26.15	33.36	59.51	74.00	-14.49	peak	
2		2390.000	14.43	33.36	47.79	54.00	-6.21	AVG	
3		2483.500	26.55	33.76	60.31	74.00	-13.69	peak	
4	*	2483.500	14.76	33.76	48.52	54.00	-5.48	AVG	

REMARKS:

- (1) Measurement Value = Reading Level + Correct Factor.
- (2) Margin Level = Measurement Value - Limit Value.

Test Mode: TX AC-20M Mode 2437 MHz

Vertical

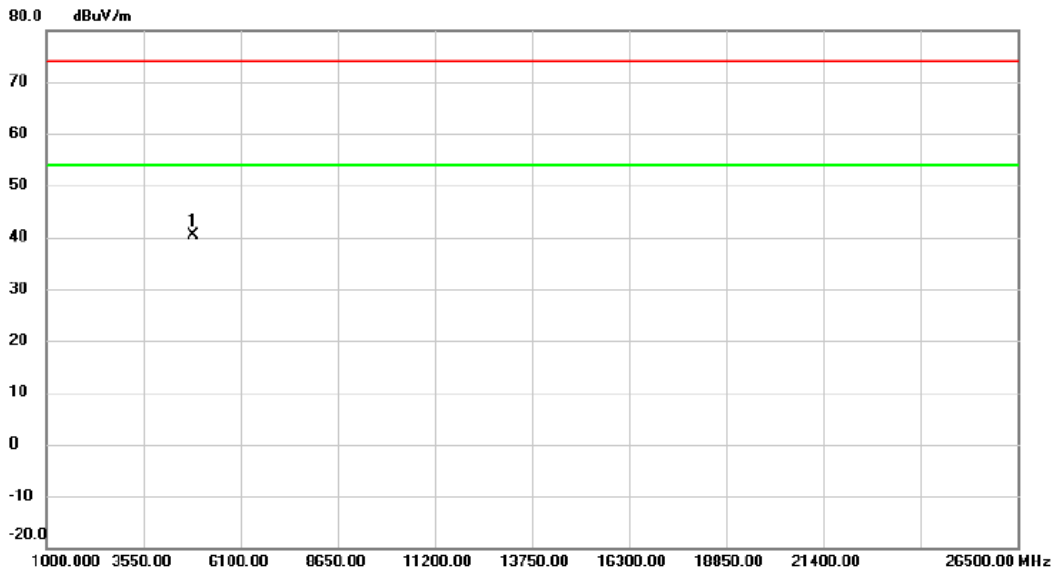

No.	Mk.	Freq. MHz	Reading Level dBuV	Correct Factor dB	Measure- ment dBuV/m	Limit dBuV/m	Margin dB	Detector	Comment
1	*	4872.925	48.38	-8.07	40.31	74.00	-33.69	peak	

REMARKS:

- (1) Measurement Value = Reading Level + Correct Factor.
- (2) Margin Level = Measurement Value - Limit Value.

Test Mode: TX AC-20M Mode 2437 MHz

Horizontal

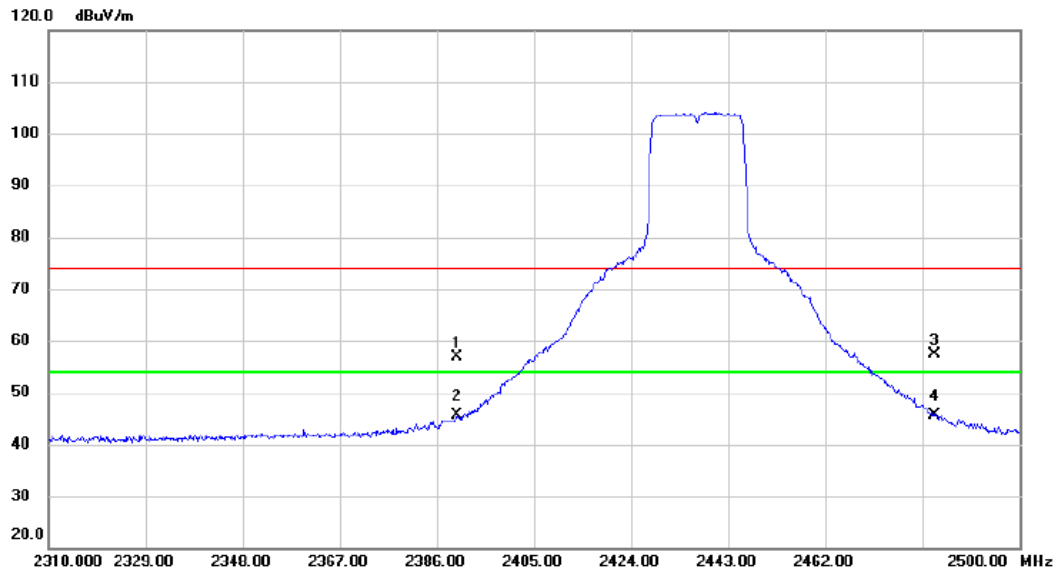

No.	Mk.	Freq. MHz	Reading Level dBuV	Correct Factor dB	Measure- ment dBuV/m	Limit dBuV/m	Margin dB	Detector	Comment
1		2390.000	23.56	33.36	56.92	74.00	-17.08	peak	
2		2390.000	12.18	33.36	45.54	54.00	-8.46	AVG	
3		2483.500	23.65	33.76	57.41	74.00	-16.59	peak	
4	*	2483.500	11.80	33.76	45.56	54.00	-8.44	AVG	

REMARKS:

- (1) Measurement Value = Reading Level + Correct Factor.
- (2) Margin Level = Measurement Value - Limit Value.

Test Mode: TX AC-20M Mode 2437 MHz

Horizontal

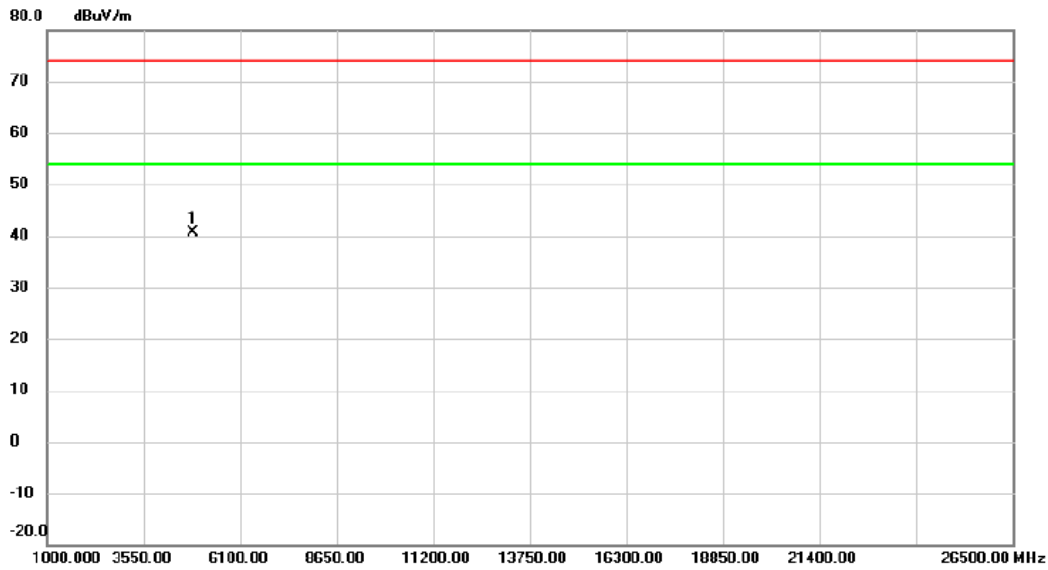

No.	Mk.	Freq. MHz	Reading Level dBuV	Correct Factor dB	Measure- ment dBuV/m	Limit dBuV/m	Margin dB	Detector	Comment
1	*	4872.915	48.78	-8.07	40.71	74.00	-33.29	peak	

REMARKS:

- (1) Measurement Value = Reading Level + Correct Factor.
- (2) Margin Level = Measurement Value - Limit Value.

Test Mode: TX AC-20M Mode 2462 MHz

Vertical

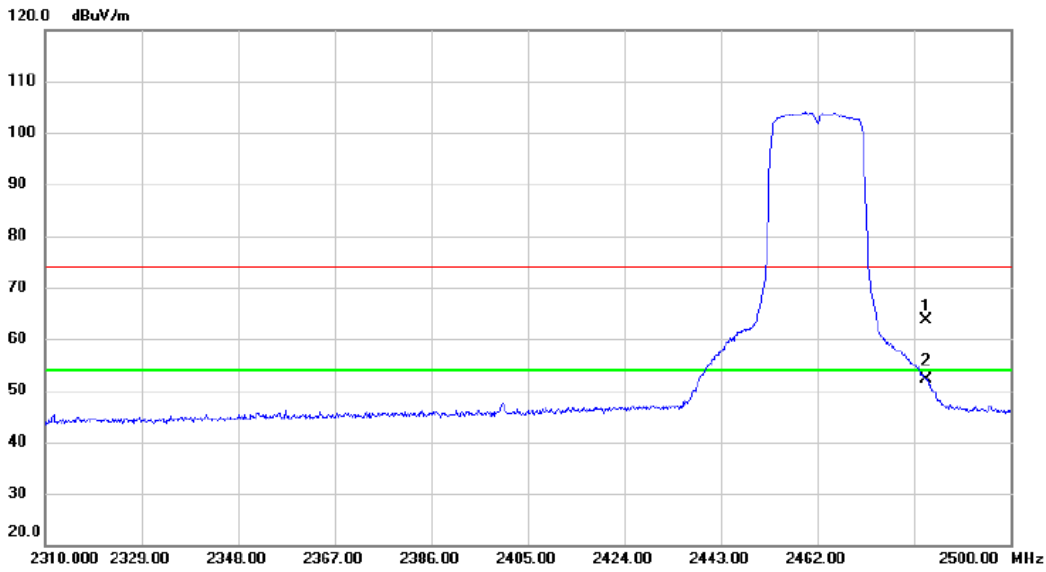

No.	Mk.	Freq. MHz	Reading Level dBuV	Correct Factor dB	Measure- ment dBuV/m	Limit dBuV/m	Margin dB	Detector	Comment
1		2483.500	29.99	33.76	63.75	74.00	-10.25	peak	
2	*	2483.500	18.26	33.76	52.02	54.00	-1.98	AVG	

REMARKS:

- (1) Measurement Value = Reading Level + Correct Factor.
- (2) Margin Level = Measurement Value - Limit Value.

Test Mode: TX AC-20M Mode 2462 MHz

Vertical

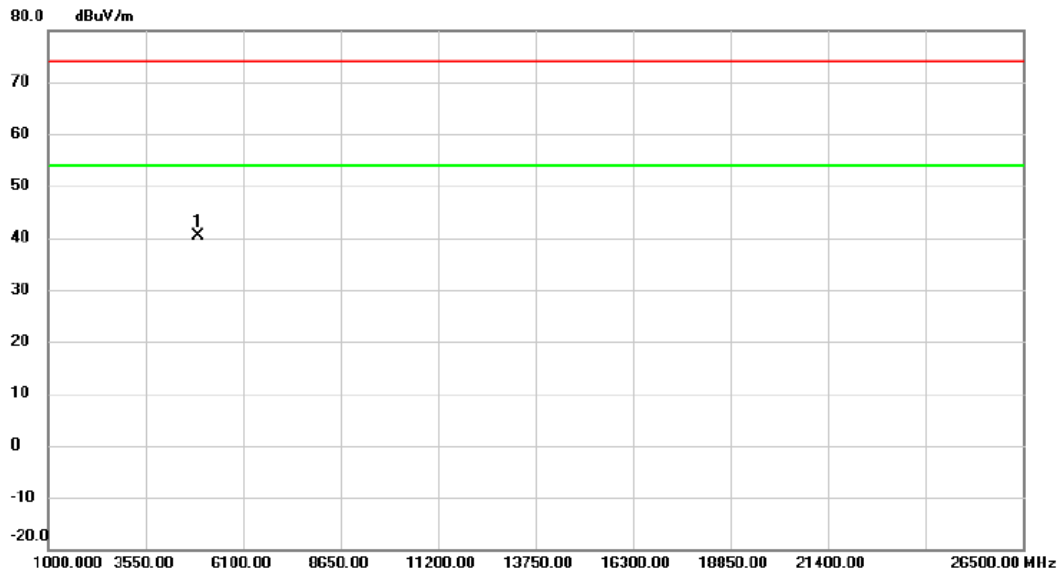

No.	Mk.	Freq. MHz	Reading Level dBuV	Correct Factor dB	Measure- ment dBuV/m	Limit dBuV/m	Margin dB	Detector	Comment
1	*	4923.020	48.38	-7.91	40.47	74.00	-33.53	peak	

REMARKS:

- (1) Measurement Value = Reading Level + Correct Factor.
- (2) Margin Level = Measurement Value - Limit Value.

Test Mode: TX AC-20M Mode 2462 MHz

Horizontal

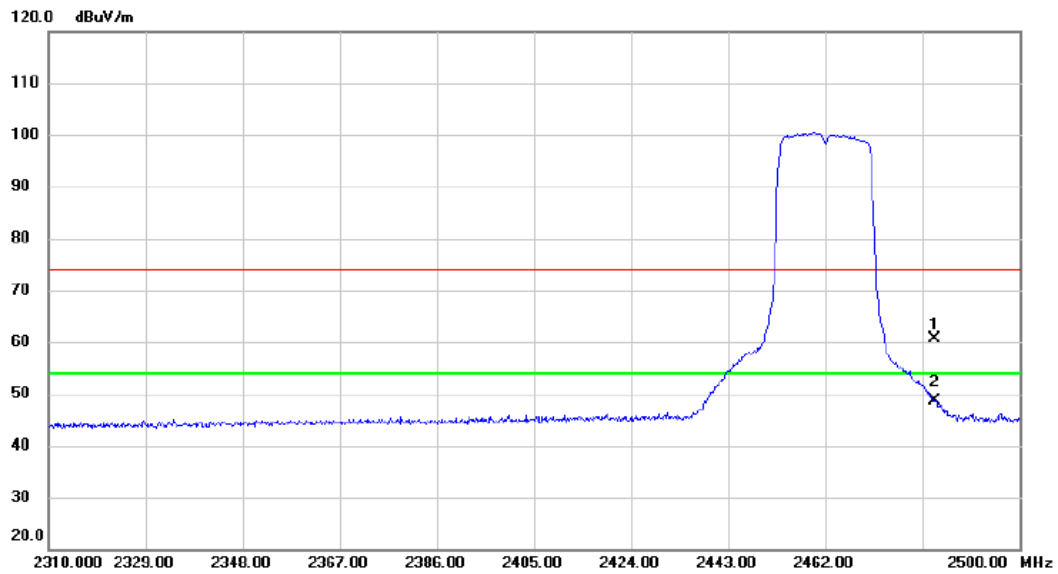

No.	Mk.	Freq. MHz	Reading Level dBuV	Correct Factor dB	Measure- ment dBuV/m	Limit dBuV/m	Margin dB	Detector	Comment
1		2483.500	26.84	33.76	60.60	74.00	-13.40	peak	
2	*	2483.500	14.75	33.76	48.51	54.00	-5.49	AVG	

REMARKS:

- (1) Measurement Value = Reading Level + Correct Factor.
- (2) Margin Level = Measurement Value - Limit Value.

Test Mode: TX AC-20M Mode 2462 MHz

Horizontal

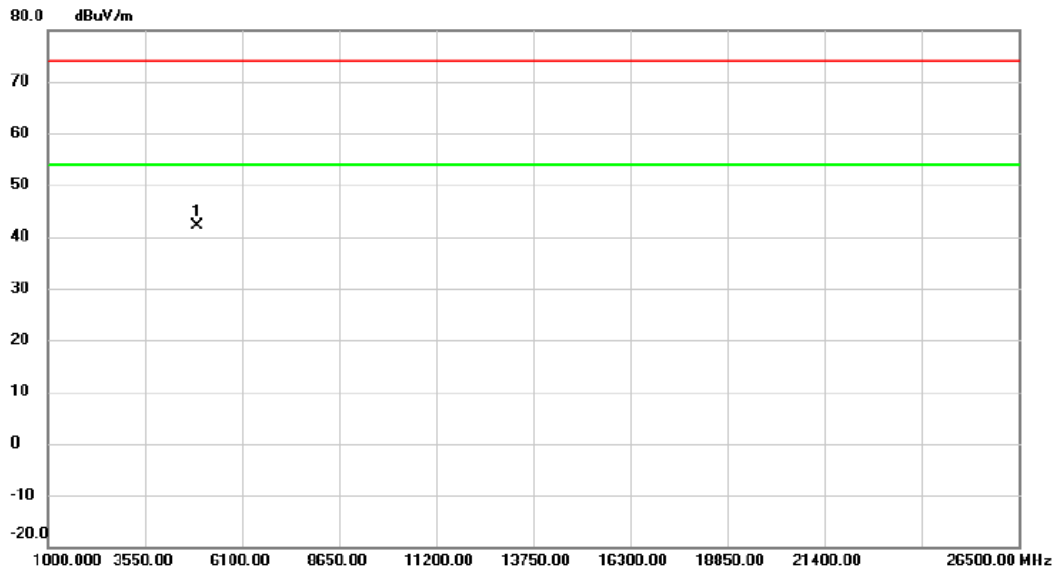

No.	Mk.	Freq. MHz	Reading Level dBuV	Correct Factor dB	Measure- ment dBuV/m	Limit dBuV/m	Margin dB	Detector	Comment
1	*	4923.100	49.97	-7.91	42.06	74.00	-31.94	peak	

REMARKS:

- (1) Measurement Value = Reading Level + Correct Factor.
- (2) Margin Level = Measurement Value - Limit Value.

Test Mode: TX AC-40M Mode 2422MHz

Vertical

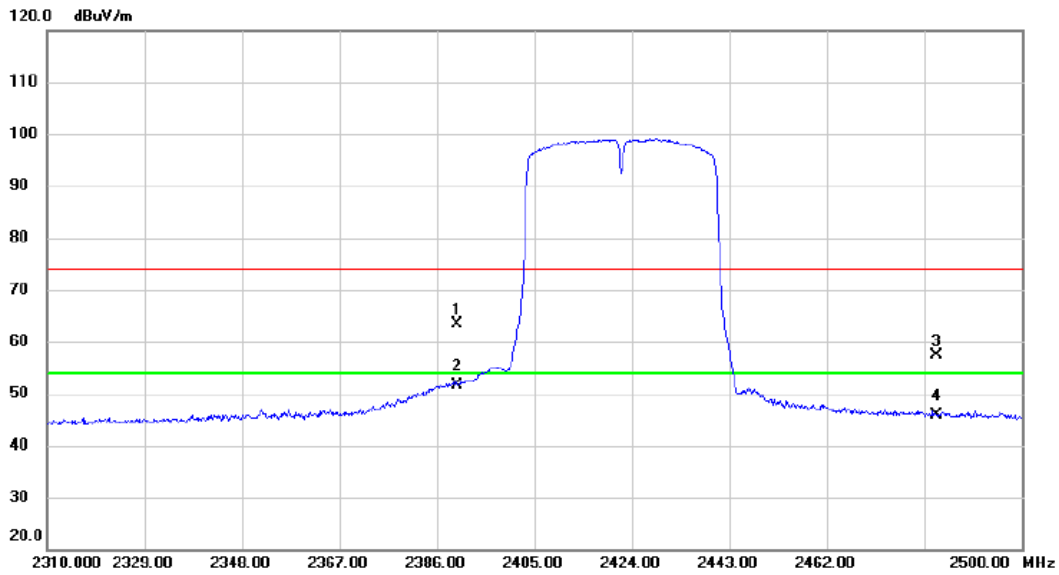

No.	Mk.	Freq. MHz	Reading Level dBuV	Correct Factor dB	Measure- ment dBuV/m	Limit dBuV/m	Margin dB	Detector	Comment
1		2390.000	29.99	33.36	63.35	74.00	-10.65	peak	
2	*	2390.000	18.38	33.36	51.74	54.00	-2.26	AVG	
3		2483.500	23.65	33.76	57.41	74.00	-16.59	peak	
4		2483.500	12.22	33.76	45.98	54.00	-8.02	AVG	

REMARKS:

- (1) Measurement Value = Reading Level + Correct Factor.
- (2) Margin Level = Measurement Value - Limit Value.

Test Mode: TX AC-40M Mode 2422MHz

Vertical

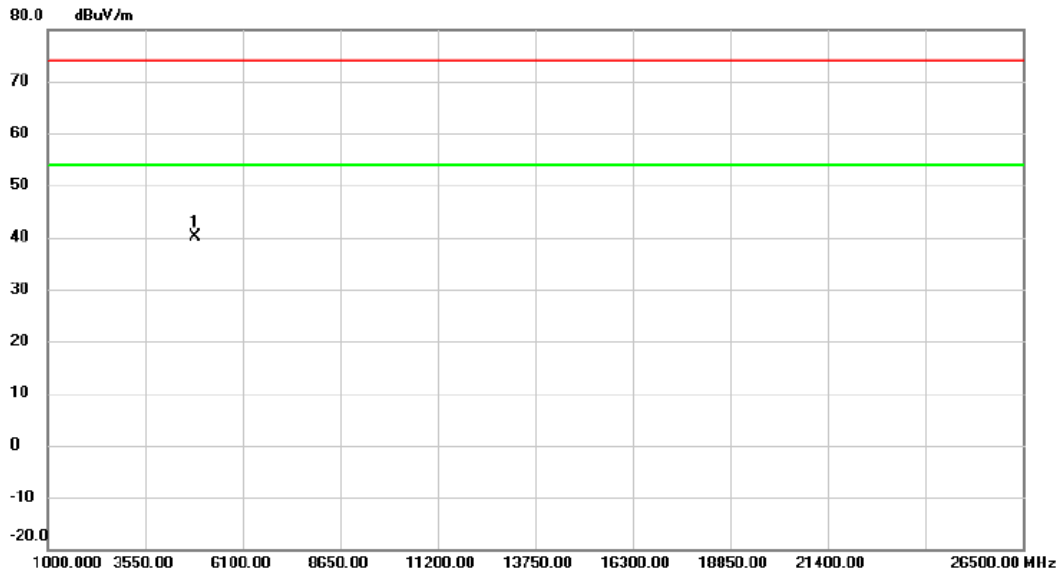

No.	Mk.	Freq.	Reading Level	Correct Factor	Measurement	Limit	Margin	Detector	Comment
		MHz	dBuV	dB	dBuV/m	dBuV/m	dB		
1	*	4842.335	48.41	-8.17	40.24	74.00	-33.76	peak	

REMARKS:

- (1) Measurement Value = Reading Level + Correct Factor.
- (2) Margin Level = Measurement Value - Limit Value.

Test Mode: TX AC-40M Mode 2422MHz

Horizontal

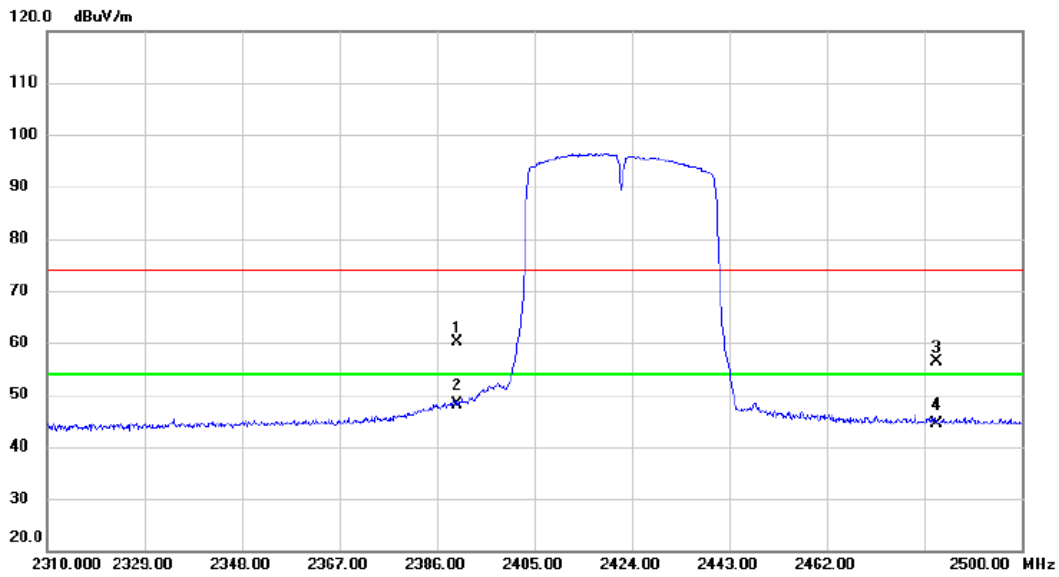

No.	Mk.	Freq. MHz	Reading Level dBuV	Correct Factor dB	Measure- ment dBuV/m	Limit dBuV/m	Margin dB	Detector	Comment
1		2390.000	26.84	33.36	60.20	74.00	-13.80	peak	
2	*	2390.000	14.82	33.36	48.18	54.00	-5.82	AVG	
3		2483.500	22.65	33.76	56.41	74.00	-17.59	peak	
4		2483.500	10.69	33.76	44.45	54.00	-9.55	AVG	

REMARKS:

- (1) Measurement Value = Reading Level + Correct Factor.
- (2) Margin Level = Measurement Value - Limit Value.

Test Mode: TX AC-40M Mode 2422MHz

Horizontal

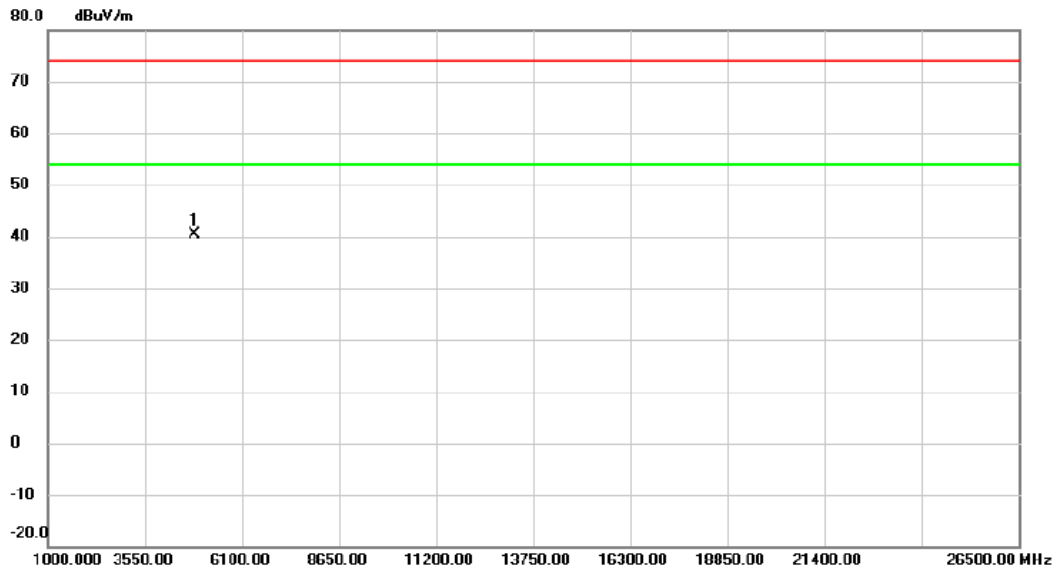

No.	Mk.	Freq. MHz	Reading Level dBuV	Correct Factor dB	Measure- ment dBuV/m	Limit dBuV/m	Margin dB	Detector	Comment
1	*	4842.715	48.49	-8.16	40.33	74.00	-33.67	peak	

REMARKS:

- (1) Measurement Value = Reading Level + Correct Factor.
- (2) Margin Level = Measurement Value - Limit Value.

Test Mode: TX AC-40M Mode 2437 MHz

Vertical

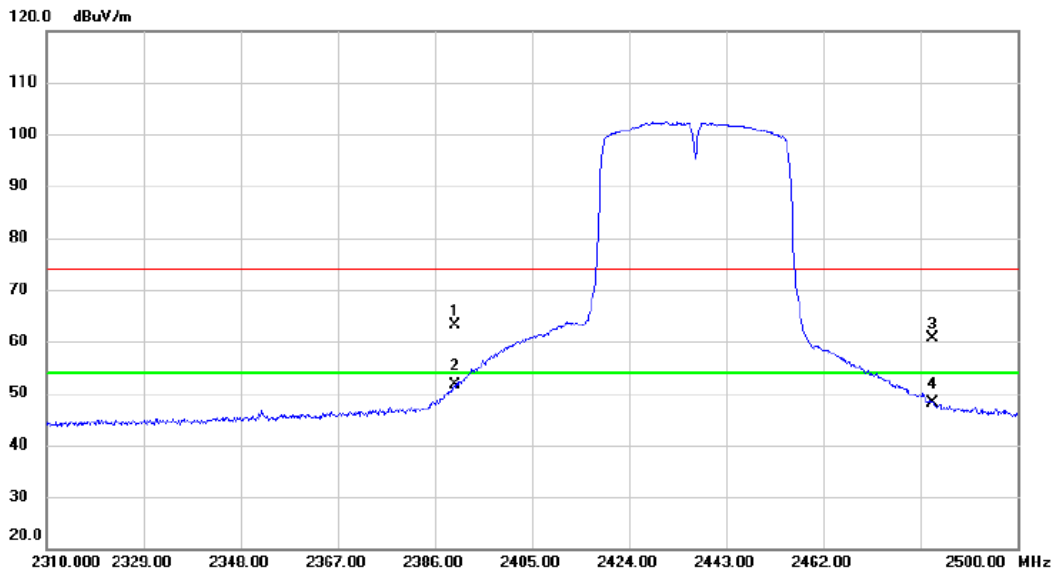

No.	Mk.	Freq. MHz	Reading Level dBuV	Correct Factor dB	Measure- ment dBuV/m	Limit dBuV/m	Margin dB	Detector	Comment
1		2390.000	29.66	33.36	63.02	74.00	-10.98	peak	
2	*	2390.000	18.26	33.36	51.62	54.00	-2.38	AVG	
3		2483.500	26.85	33.76	60.61	74.00	-13.39	peak	
4		2483.500	14.31	33.76	48.07	54.00	-5.93	AVG	

REMARKS:

- (1) Measurement Value = Reading Level + Correct Factor.
- (2) Margin Level = Measurement Value - Limit Value.

Test Mode: TX AC-40M Mode 2437 MHz

Vertical

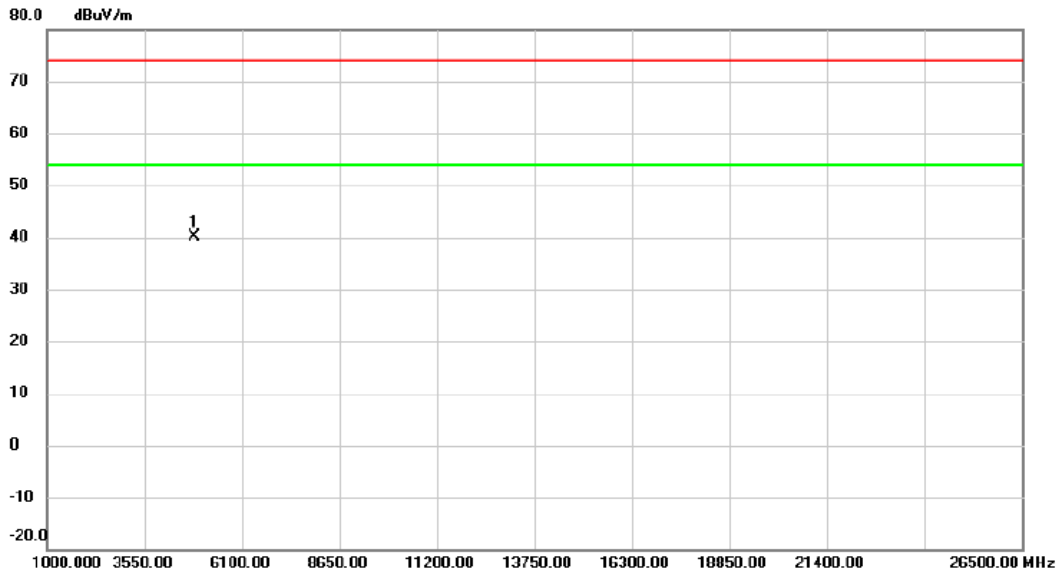

No.	Mk.	Freq. MHz	Reading Level dBuV	Correct Factor dB	Measure- ment dBuV/m	Limit dBuV/m	Margin dB	Detector	Comment
1	*	4875.660	48.23	-8.06	40.17	74.00	-33.83	peak	

REMARKS:

- (1) Measurement Value = Reading Level + Correct Factor.
- (2) Margin Level = Measurement Value - Limit Value.

Test Mode: TX AC-40M Mode 2437 MHz

Horizontal

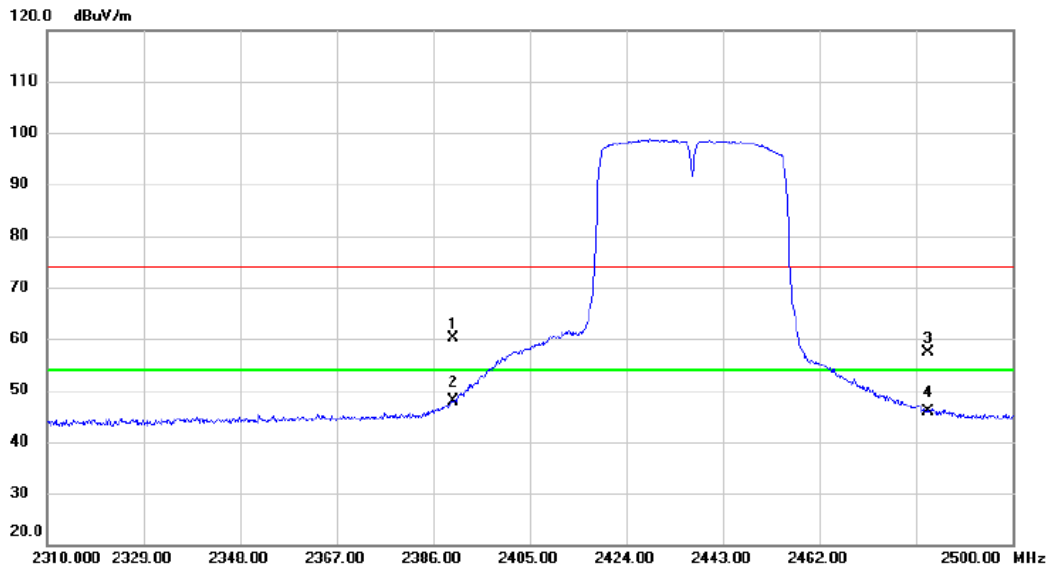

No.	Mk.	Freq. MHz	Reading Level dBuV	Correct Factor dB	Measure- ment dBuV/m	Limit dBuV/m	Margin dB	Detector	Comment
1		2390.000	26.84	33.36	60.20	74.00	-13.80	peak	
2	*	2390.000	14.51	33.36	47.87	54.00	-6.13	AVG	
3		2483.500	23.66	33.76	57.42	74.00	-16.58	peak	
4		2483.500	12.08	33.76	45.84	54.00	-8.16	AVG	

REMARKS:

- (1) Measurement Value = Reading Level + Correct Factor.
- (2) Margin Level = Measurement Value - Limit Value.

Test Mode: TX AC-40M Mode 2437 MHz

Horizontal

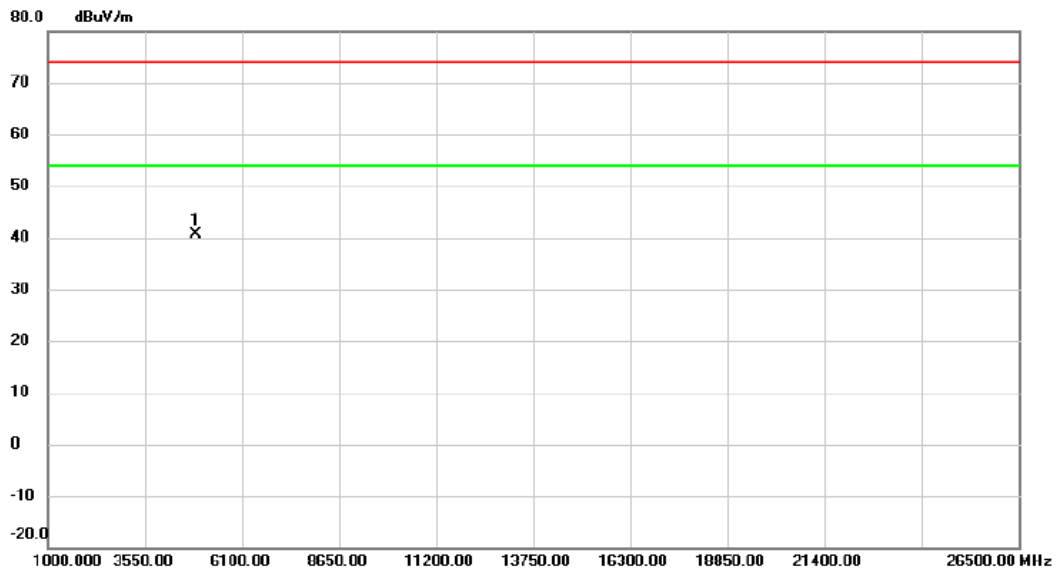

No.	Mk.	Freq. MHz	Reading Level dBuV	Correct Factor dB	Measure- ment dBuV/m	Limit dBuV/m	Margin dB	Detector	Comment
1	*	4876.145	48.72	-8.06	40.66	74.00	-33.34	peak	

REMARKS:

- (1) Measurement Value = Reading Level + Correct Factor.
- (2) Margin Level = Measurement Value - Limit Value.

Test Mode: TX AC-40M Mode 2452 MHz

Vertical

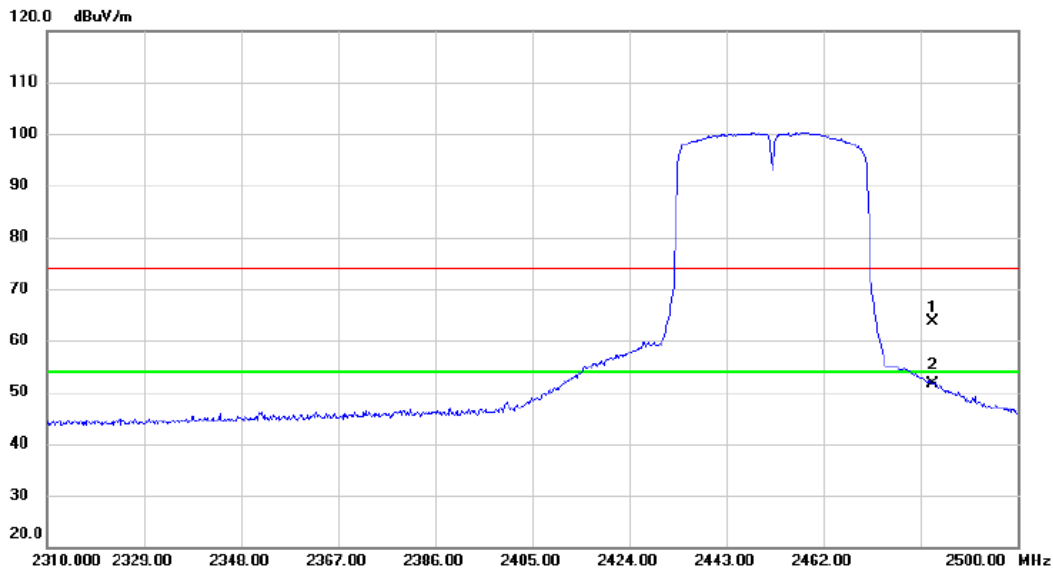

No.	Mk.	Freq. MHz	Reading Level dBuV	Correct Factor dB	Measure- ment dBuV/m	Limit dBuV/m	Margin dB	Detector	Comment
1		2483.500	29.88	33.76	63.64	74.00	-10.36	peak	
2	*	2483.500	17.80	33.76	51.56	54.00	-2.44	AVG	

REMARKS:

- (1) Measurement Value = Reading Level + Correct Factor.
- (2) Margin Level = Measurement Value - Limit Value.

Test Mode: TX AC-40M Mode 2452 MHz

Vertical

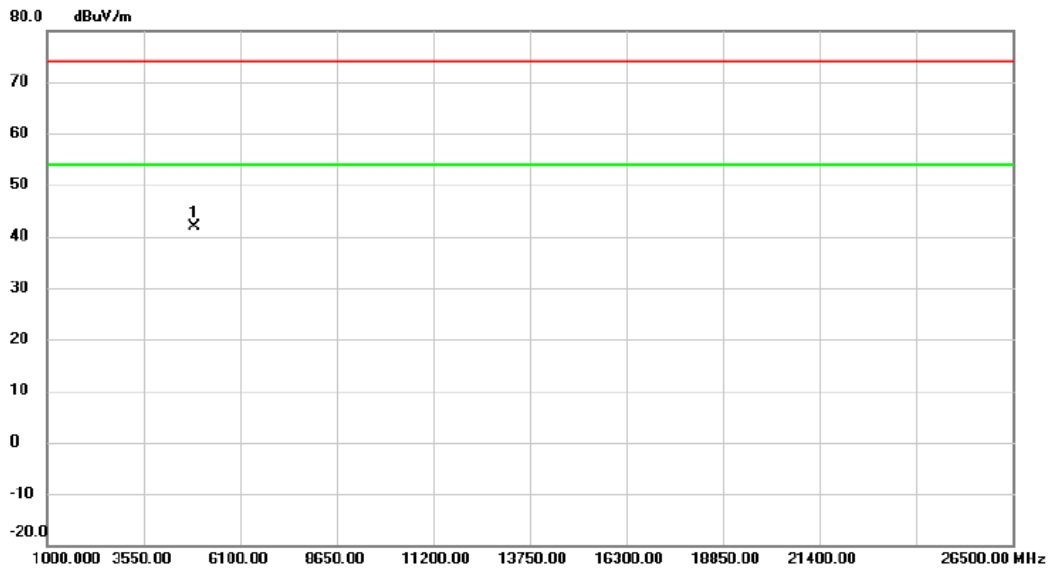

No.	Mk.	Freq. MHz	Reading Level dBuV	Correct Factor dB	Measure- ment dBuV/m	Limit dBuV/m	Margin dB	Detector	Comment
1	*	4903.405	49.83	-7.98	41.85	74.00	-32.15	peak	

REMARKS:

- (1) Measurement Value = Reading Level + Correct Factor.
- (2) Margin Level = Measurement Value - Limit Value.

Test Mode: TX AC-40M Mode 2452 MHz

Horizontal

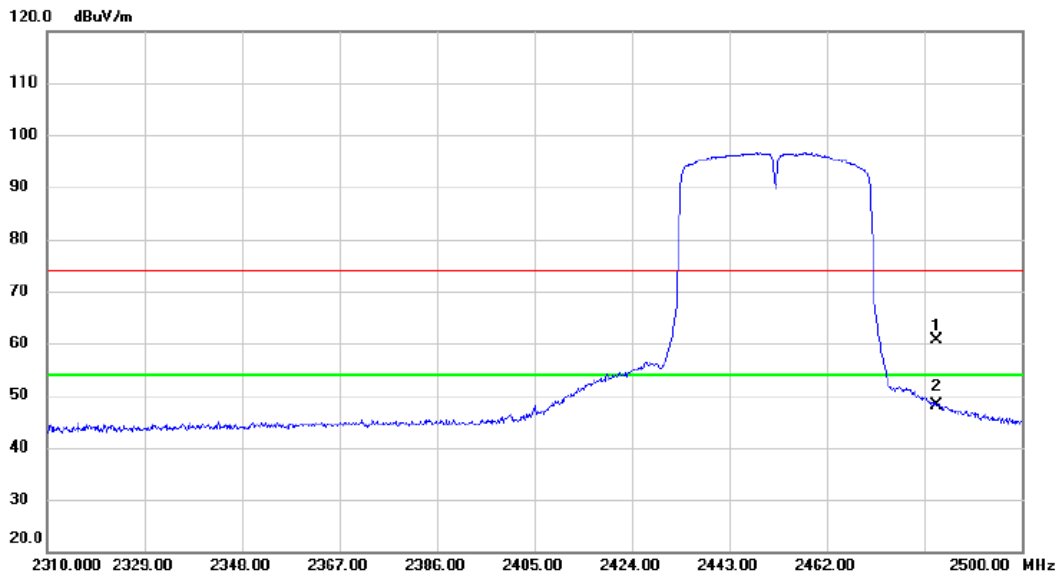

No.	Mk.	Freq. MHz	Reading Level dBuV	Correct Factor dB	Measure- ment dBuV/m	Limit dBuV/m	Margin dB	Detector	Comment
1		2483.500	26.89	33.76	60.65	74.00	-13.35	peak	
2	*	2483.500	14.49	33.76	48.25	54.00	-5.75	AVG	

REMARKS:

- (1) Measurement Value = Reading Level + Correct Factor.
- (2) Margin Level = Measurement Value - Limit Value.

Test Mode: TX AC-40M Mode 2452 MHz

Horizontal

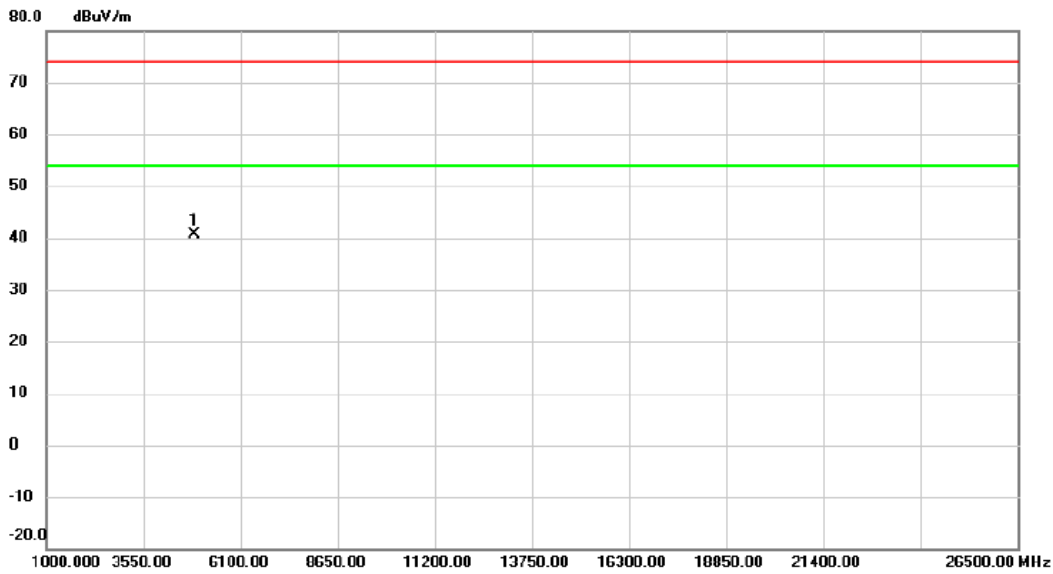

No.	Mk.	Freq.	Reading Level	Correct Factor	Measurement	Limit	Margin	Detector	Comment
		MHz	dBuV	dB	dBuV/m	dBuV/m	dB		
1	*	4905.815	48.58	-7.97	40.61	74.00	-33.39	peak	

REMARKS:

- (1) Measurement Value = Reading Level + Correct Factor.
- (2) Margin Level = Measurement Value - Limit Value.

For Ant. 2

Test Mode:	TX B Mode 2412 MHz
------------	--------------------

Vertical

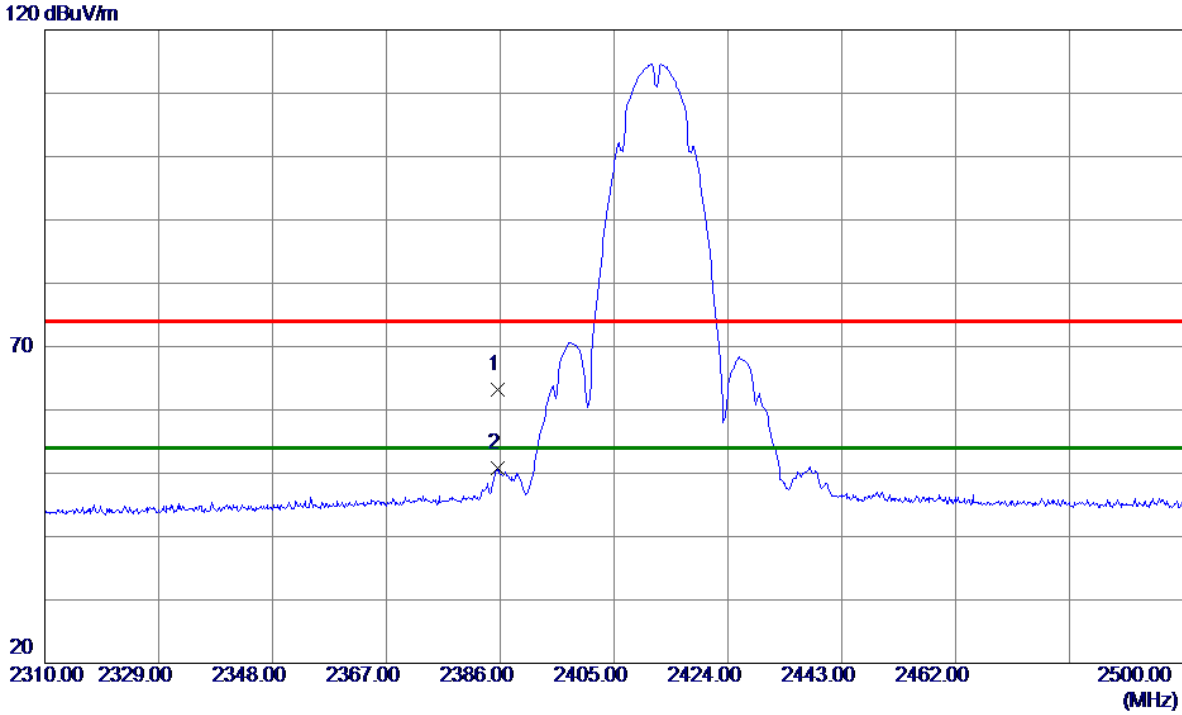

No.	Freq. MHz	Reading Level dBuV/m	Correct Factor dB	Measure ment dBuV/m	Limit dBuV/m	Margin dB	Detector	Comment
1	2385.6200	29.90	33.34	63.24	74.00	-10.76	Peak	
2 *	2385.6200	17.37	33.34	50.71	54.00	-3.29	AVG	

REMARKS:

- (1) Measurement Value = Reading Level + Correct Factor.
- (2) Margin Level = Measurement Value - Limit Value.

Test Mode: TX B Mode 2412 MHz

Vertical

80 dBuV/m

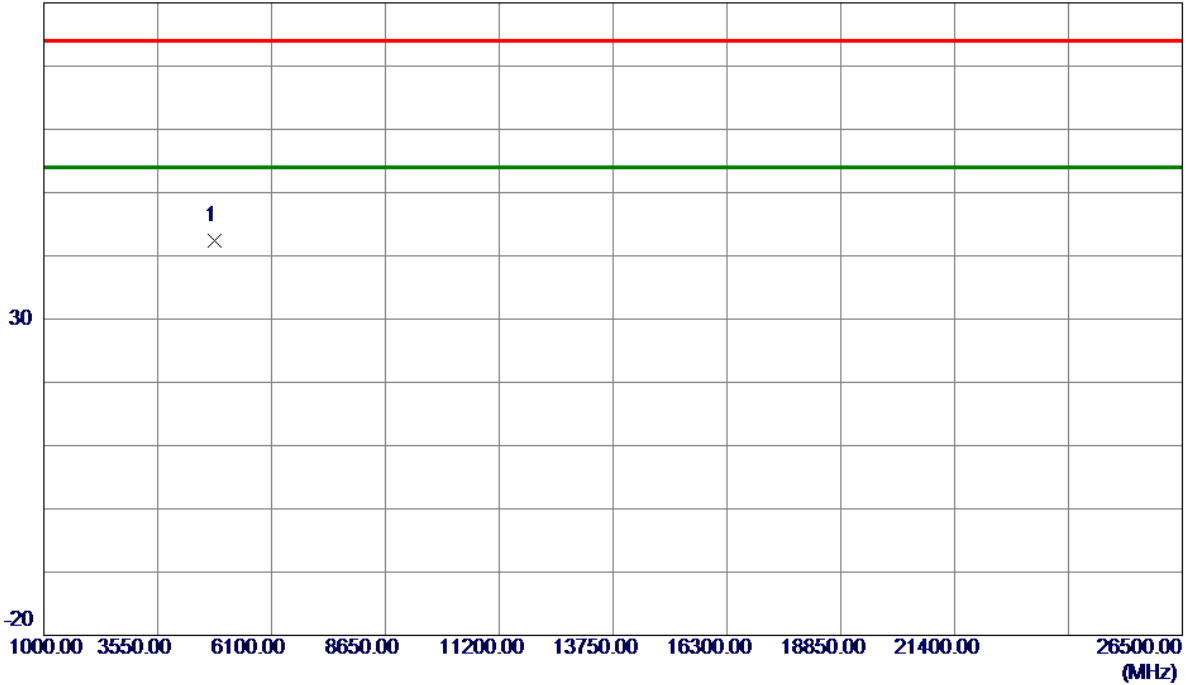

No.	Freq. MHz	Reading Level dBuV/m	Correct Factor dB	Measure ment dBuV/m	Limit dBuV/m	Margin dB	Detector	Comment
1 *	4824.0950	50.59	-8.22	42.37	74.00	-31.63	Peak	

REMARKS:

- (1) Measurement Value = Reading Level + Correct Factor.
- (2) Margin Level = Measurement Value - Limit Value.

Test Mode: TX B Mode 2412 MHz

Horizontal

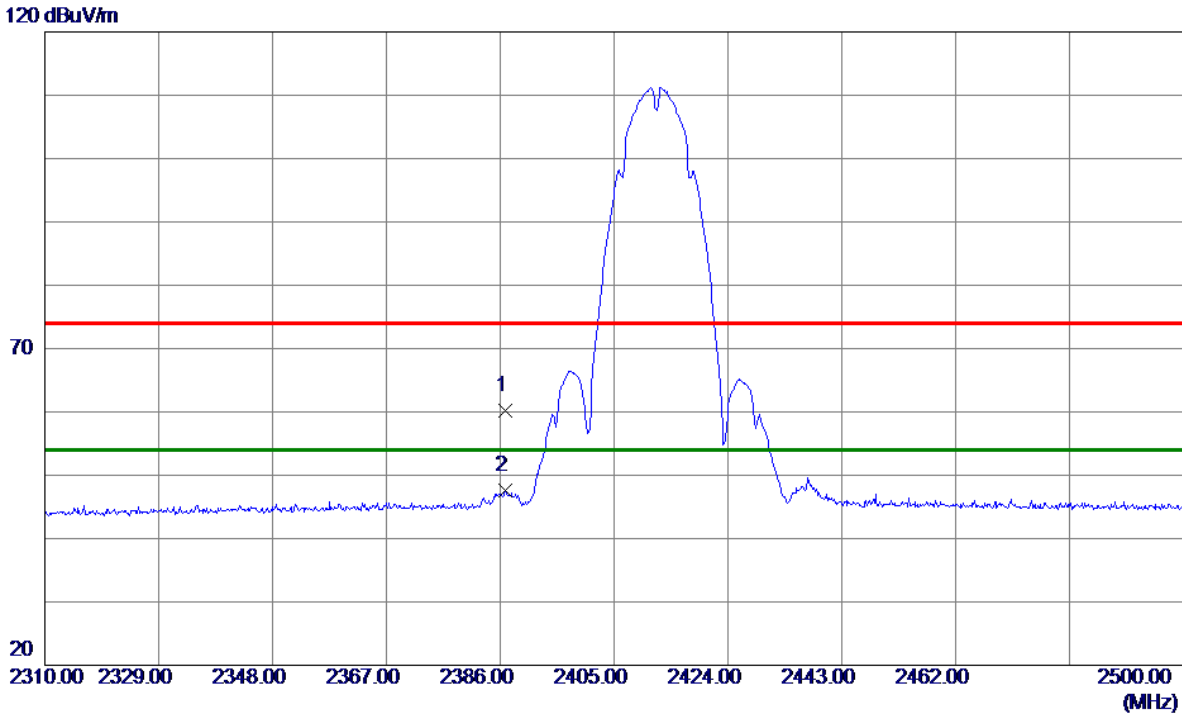

No.	Freq. MHz	Reading Level dBuV/m	Correct Factor dB	Measure ment dBuV/m	Limit dBuV/m	Margin dB	Detector	Comment
1	2386.7600	26.89	33.35	60.24	74.00	-13.76	Peak	
2 *	2386.7600	14.22	33.35	47.57	54.00	-6.43	AVG	

REMARKS:

(1) Measurement Value = Reading Level + Correct Factor.

(2) Margin Level = Measurement Value - Limit Value.

Test Mode: TX B Mode 2412 MHz

Horizontal

80 dBuV/m

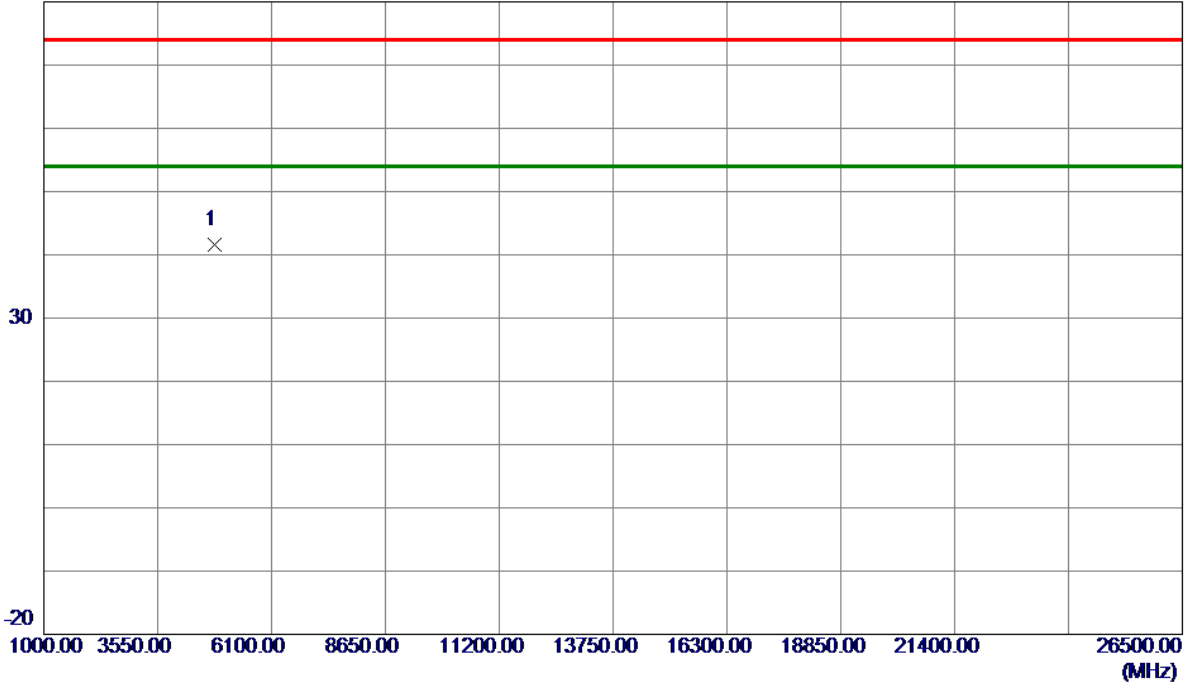

No.	Freq. MHz	Reading Level dBuV/m	Correct Factor dB	Measure ment dBuV/m	Limit dBuV/m	Margin dB	Detector	Comment
1 *	4824.2599	49.91	-8.22	41.69	74.00	-32.31	Peak	

REMARKS:

- (1) Measurement Value = Reading Level + Correct Factor.
- (2) Margin Level = Measurement Value - Limit Value.

Test Mode: TX B Mode 2437 MHz

Vertical

120 dBuV/m

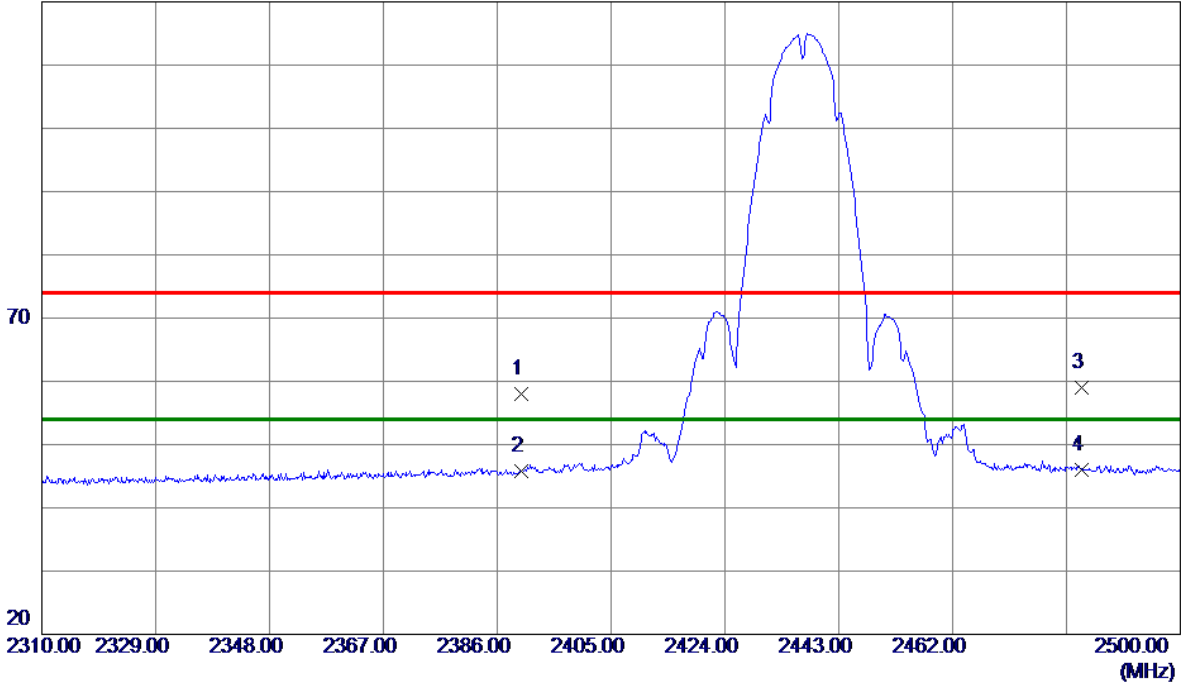

No.	Freq. MHz	Reading Level dBuV/m	Correct Factor dB	Measure ment dBuV/m	Limit dBuV/m	Margin dB	Detector	Comment
1	2390.0000	24.66	33.36	58.02	74.00	-15.98	Peak	
2	2390.0000	12.50	33.36	45.86	54.00	-8.14	AVG	
3	2483.5000	25.15	33.76	58.91	74.00	-15.09	Peak	
4 *	2483.5000	12.26	33.76	46.02	54.00	-7.98	AVG	

REMARKS:

(1) Measurement Value = Reading Level + Correct Factor.

(2) Margin Level = Measurement Value - Limit Value.

Test Mode: TX B Mode 2437 MHz

Vertical

80 dBuV/m

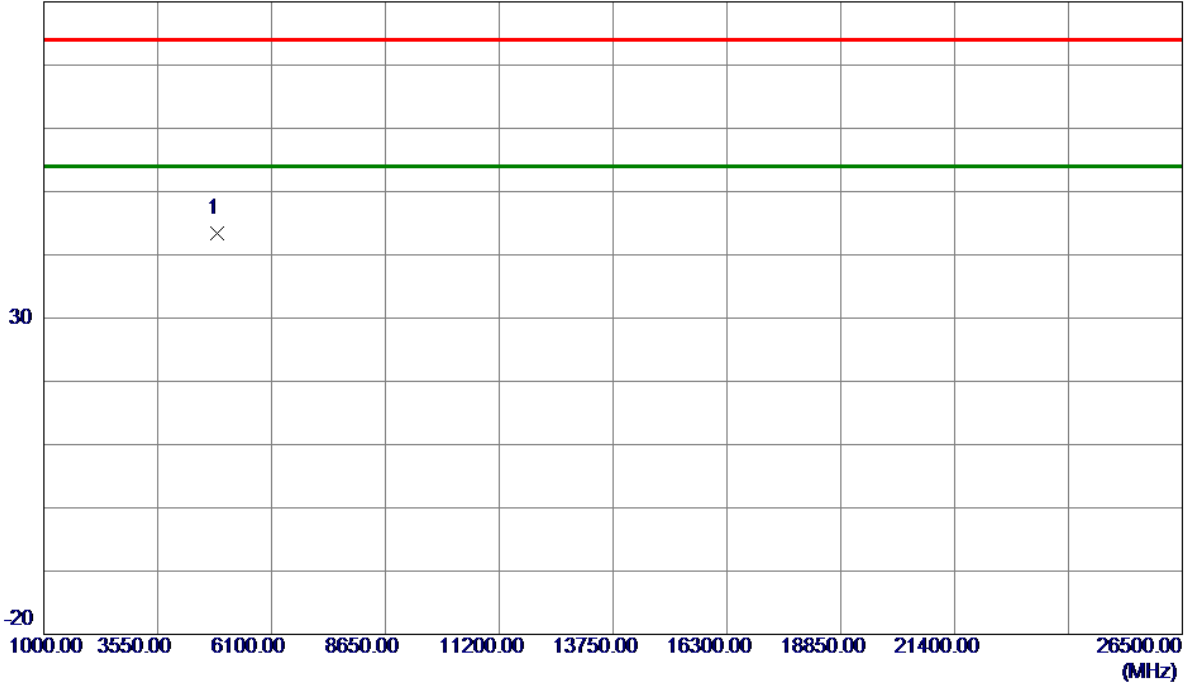

No.	Freq. MHz	Reading Level dBuV/m	Correct Factor dB	Measure ment dBuV/m	Limit dBuV/m	Margin dB	Detector	Comment
1 *	4873.9550	51.40	-8.07	43.33	74.00	-30.67	Peak	

REMARKS:

- (1) Measurement Value = Reading Level + Correct Factor.
- (2) Margin Level = Measurement Value - Limit Value.