

FCC Radio Test Report

FCC ID: 2ACFN-QMIRO201W

This report concerns: **Original Grant**

Project No. : 2004H039
Equipment : Tri-Band Mesh WiFi Satellite
Brand Name : QNAP
Test Model : QMiro-201W
Series Model : N/A
Applicant : QNAP Systems, Inc.
Address : 2F,No.22,Zhongxing Road,Xizhi District., New Taipei City,Taiwan, 221
Manufacturer : QNAP Systems, Inc.
Address : 2F,No.22,Zhongxing Rd,Xizhi Dist., New Taipei City,221,Taiwan
Factory : CIG Shanghai Co., Ltd., Shanghai Branch.
Address : F/2,3 Building 1,No. 505 Jiangyue Road, Minhang District, Shanghai,P.R.China
Date of Receipt : May. 25, 2020
Date of Test : May. 25, 2020~Jun. 17, 2020
Issued Date : Sep. 04, 2020
Report Version : R00
Test Sample : Engineering Sample No.: SH20200528127 for radiated; SH2020051457 for conducted; SH2020051457-1 for adapter.
Standard(s) : FCC Part15, Subpart E(15.407)
ANSI C63.10-2013
FCC KDB 789033 D02 General UNII Test Procedures New Rules v02r01
FCC KDB 662911 D01 Multiple Transmitter Output v02r01

The above equipment has been tested and found compliance with the requirement of the relative standards by BTL Inc.

Allen Wei

Prepared by : Allen Wei

Ryan Wang

Approved by : Ryan Wang



Certificate # 5123. 03

Add: No. 29, Jintang Road, Tangzhen Industry Park, Pudong New Area, Shanghai 201210,China

TEL: +86-021-61765666

Web: www.newbtl.com

Declaration

BTL represents to the client that testing is done in accordance with standard procedures as applicable and that test instruments used has been calibrated with standards traceable to international standard(s) and/or national standard(s).

BTL's reports apply only to the specific samples tested under conditions. It is manufacture's responsibility to ensure that additional production units of this model are manufactured with the identical electrical and mechanical components. **BTL** shall have no liability for any declarations, inferences or generalizations drawn by the client or others from **BTL** issued reports.

The report must not be used by the client to claim product certification, approval, or endorsement by NVLAP, NIST, A2LA, or any agency of the U.S. Government.

This report is the confidential property of the client. As a mutual protection to the clients, the public and ourselves, the test report shall not be reproduced, except in full, without our written approval.

BTL's laboratory quality assurance procedures are in compliance with the **ISO/IEC 17025** requirements, and accredited by the conformity assessment authorities listed in this test report.

BTL is not responsible for the sampling stage, so the results only apply to the sample as received.

The information, data and test plan are provided by manufacturer which may affect the validity of results, so it is manufacturer's responsibility to ensure that the apparatus meets the essential requirements of applied standards and in all the possible configurations as representative of its intended use.

Limitation

For the use of the authority's logo is limited unless the Test Standard(s)/Scope(s)/Item(s) mentioned in this test report is (are) included in the conformity assessment authorities acceptance respective.

Please note that the measurement uncertainty is provided for informational purpose only and are not use in determining the Pass/Fail results.

Table of Contents	Page
REPORT ISSUED HISTORY	6
1 . SUMMARY OF TEST RESULTS	7
1.1 TEST FACILITY	8
1.2 MEASUREMENT UNCERTAINTY	8
1.3 TEST ENVIRONMENT CONDITIONS	8
2 . GENERAL INFORMATION	9
2.1 GENERAL DESCRIPTION OF EUT	9
2.2 TEST MODES	15
2.3 PARAMETERS OF TEST SOFTWARE	18
2.4 DUTY CYCLE	22
2.5 BLOCK DIAGRAM SHOWING THE CONFIGURATION OF SYSTEM TESTED	24
2.6 SUPPORT UNITS	24
3 . AC POWER LINE CONDUCTED EMISSIONS TEST	25
3.1 LIMIT	25
3.2 TEST PROCEDURE	25
3.3 DEVIATION FROM TEST STANDARD	25
3.4 TEST SETUP	26
3.5 EUT OPERATION CONDITIONS	26
3.6 TEST RESULTS	26
4 . RADIATED EMISSIONS TEST	27
4.1 LIMIT	27
4.2 TEST PROCEDURE	28
4.3 DEVIATION FROM TEST STANDARD	28
4.4 TEST SETUP	29
4.5 EUT OPERATION CONDITIONS	31
4.6 TEST RESULTS - 9 KHZ to 30 MHZ	31
4.7 TEST RESULTS - 30 MHz TO 1000 MHz	31
4.8 TEST RESULTS - ABOVE 1000 MHz	31
5 . BANDWIDTH TEST	32
5.1 LIMIT	32
5.2 TEST PROCEDURE	32
5.3 TEST PROCEDURE	32

Table of Contents	Page
5.4 TEST SETUP	33
5.5 EUT OPERATION CONDITIONS	33
5.6 TEST RESULTS	33
6 . MAXIMUM OUTPUT POWER TEST	34
6.1 LIMIT	34
6.2 TEST PROCEDURE	34
6.3 DEVIATION FROM STANDARD	34
6.4 TEST SETUP	34
6.5 EUT OPERATION CONDITIONS	34
6.6 TEST RESULTS	34
7 . POWER SPECTRAL DENSITY TEST	35
7.1 LIMIT	35
7.2 TEST PROCEDURE	35
7.3 DEVIATION FROM STANDARD	35
7.4 TEST SETUP	36
7.5 EUT OPERATION CONDITIONS	36
7.6 TEST RESULTS	36
8 . FREQUENCY STABILITY MEASUREMENT	37
8.1 LIMIT	37
8.2 TEST PROCEDURE	37
8.3 DEVIATION FROM STANDARD	37
8.4 TEST SETUP	37
8.5 EUT OPERATION CONDITIONS	37
8.6 TEST RESULTS	37
9 . MEASUREMENT INSTRUMENTS LIST	38
10 . EUT TEST PHOTOS	40
APPENDIX A - AC POWER LINE CONDUCTED EMISSIONS	43
APPENDIX B - RADIATED EMISSION - 9 KHZ TO 30 MHZ	46
APPENDIX C - RADIATED EMISSION - 30 MHZ TO 1 GHZ	47
APPENDIX D - RADIATED EMISSION - ABOVE 1000 MHZ	50
APPENDIX E - BANDWIDTH	507

Table of Contents**Page****APPENDIX F - CONDUCTED OUTPUT POWER****517****APPENDIX G - POWER SPECTRAL DENSITY****582**

REPORT ISSUED HISTORY

Report Version	Description	Issued Date
R00	Original Issue.	Sep. 04, 2020

1. SUMMARY OF TEST RESULTS

Test procedures according to the technical standard(s):

FCC Part15, Subpart E(15.407)				
Standard(s) Section	Test Item	Test Result	Judgement	Remark
15.207 15.407(b)	AC Power Line Conducted Emissions	APPENDIX A	N/A	-----
15.407(b) 15.205(a) 15.209(a)	Radiated Emissions	APPENDIX B APPENDIX C APPENDIX D	PASS	-----
15.407(a) 15.407(e)	Spectrum Bandwidth	APPENDIX E	PASS	-----
15.407(a)	Maximum Output Power	APPENDIX F	PASS	-----
15.407(a)	Power Spectral Density	APPENDIX G	PASS	-----
15.407(g)	Frequency Stability	APPENDIX H	PASS	-----
15.203	Antenna Requirements	-----	PASS	NOTE (3)
15.407(c)	Automatically Discontinue Transmission	-----	PASS	NOTE (3)

Note:

- (1) "N/A" denotes test is not applicable in this test report.
- (2) The device what use a permanently attached antenna were considered sufficient to comply with the provisions of 15.203.
- (3) During no any information transmission, the EUT can automatically discontinue transmission and become standby mode for power saving. the EUT can detect the controlling signal of ACK message transmitting from remote device and verify whether it shall resend or discontinue transmission.
- (4) For UNII-1 this device was functioned as a
 Access point device Client device

1.1 TEST FACILITY

The test facilities used to collect the test data in this report is at the location of No. 29, Jintang Road, Tangzhen Industry Park, Pudong New Area, Shanghai 201210,China

BTL's Test Firm Registration Number for FCC: 476765

BTL's Designation Number for FCC: CN1241

1.2 MEASUREMENT UNCERTAINTY

ISO/IEC 17025 requires that an estimate of the measurement uncertainties associated with the emissions test results be included in the report. The measurement uncertainties given below are based on a 95% confidence level (based on a coverage factor (k=2))

The BTL measurement uncertainty as below table:

A. AC power line conducted emissions test:

Test Site	Method	Measurement Frequency Range	U, (dB)
SH-C01	CISPR	150 kHz ~ 30 MHz	2.70

B. Radiated emissions test:

Test Site	Method	Measurement Frequency Range	Ant. H / V	U, (dB)
SH-CB01	CISPR	9 KHz~30 MHz	V	3.79
		9 KHz~30 MHz	H	3.57
		30 MHz~200 MHz	V	4.04
		30 MHz~200 MHz	H	3.76
		200 MHz~1,000 MHz	V	4.24
		200 MHz~1,000 MHz	H	3.84
		1 GHz~18 GHz	V	4.46
		1 GHz~18 GHz	H	4.40
		18 GHz~40 GHz	V	3.95
		18 GHz~40 GHz	H	3.95

Note: Unless specifically mentioned, the uncertainty of measurement has not been taken into account to declare the compliance or non-compliance to the specification.

1.3 TEST ENVIRONMENT CONDITIONS

Test Item	Temperature	Humidity	Test Voltage	Tested By
AC Power Line Conducted Emissions	20°C	50%	AC 120V/60Hz	Vince Zong
Radiated Emissions-9K-30MHz	20°C	50%	AC 120V/60Hz	Vince Zong
Radiated Emissions-30 MHz to 1GHz	20°C	50%	AC 120V/60Hz	Vince Zong
Radiated Emissions-Above 1000 MHz	19°C	48%	AC 120V/60Hz	Bill Dong
Spectrum Bandwidth	19°C	48%	AC 120V/60Hz	Bill Dong
Maximum Output Power	19°C	48%	AC 120V/60Hz	Bill Dong
Power Spectral Density	20°C	50%	AC 120V/60Hz	Vince Zong
Frequency Stability	20°C	50%	AC 120V/60Hz	Vince Zong

2. GENERAL INFORMATION

2.1 GENERAL DESCRIPTION OF EUT

Equipment	Tri-Band Mesh WiFi Satellite
Brand Name	QNAP
Test Model	QMiro-201W
Series Model	N/A
Model Difference(s)	N/A
Power Source	DC voltage supplied from AC/DC adapter. #1: A124-2120207U #2:ADS0248T-W120200
Power Rating	/#1: I/P:100-240V ~, 50-60Hz 0.6A O/P: 12V 2.0A 24W /#1: I/P:100-240V ~, 50-60Hz 0.6A O/P: 12V 2.0A
Operation Frequency	UNII-1: 5150 MHz~5250 MHz UNII-2A: 5250 MHz~5350 MHz UNII-2C: 5470 MHz~5725 MHz UNII-3: 5725 MHz~5850 MHz
Modulation Type	OFDM
Bit Rate of Transmitter	Up to 866.6Mbps Mbps

Maximum Conducted Output Power for UNII-1 (2TX) CDD	<p> IEEE 802.11a: 21.09 dBm (0.1603 W) for Ant. 1 IEEE 802.11n (HT20): 20.81 dBm (0.1521 W) for Ant. 1 IEEE 802.11n (HT40): 21.33 dBm (0.1845 W) for Ant. 1 IEEE 802.11ac (VHT20): 20.85 dBm (0.1531 W) for Ant. 1 IEEE 802.11ac (VHT40): 21.53 dBm (0.1828 W) for Ant. 1 IEEE 802.11ac (VHT80): 15.58 dBm (0.0449 W) for Ant. 1 </p> <p> IEEE 802.11a: 23.32 dBm (0.1581 W) for Ant. 2 IEEE 802.11n (HT20): 22.99 dBm (0.1493 W) for Ant. 2 IEEE 802.11n (HT40): 21.43 dBm (0.1858 W) for Ant. 2 IEEE 802.11ac (VHT20): 23.09 dBm (0.1517 W) for Ant. 2 IEEE 802.11ac (VHT40): 21.53 dBm (0.1811 W) for Ant. 2 IEEE 802.11ac (VHT80): 17.90 dBm (0.0441 W) for Ant. 2 </p> <p> IEEE 802.11a: 24.85 dBm (0.3055 W) for Ant. 1 + Ant. 2 IEEE 802.11n (HT20): 24.37 dBm (0.2735 W) IEEE 802.11n (HT40): 25.37 dBm (0.3443 W) IEEE 802.11ac (VHT20): 24.46 dBm (0.2793 W) IEEE 802.11ac (VHT40): 25.50 dBm (0.3548 W) IEEE 802.11ac (VHT80): 19.78 dBm (0.0951 W) </p>
Maximum Conducted Output Power for UNII-2A (2TX) CDD	<p> IEEE 802.11a: 20.51 dBm (0.1596 W) for Ant. 1 IEEE 802.11n (HT20): 20.81 dBm (0.1556 W) for Ant. 1 IEEE 802.11n (HT40): 19.32 dBm (0.1462 W) for Ant. 1 IEEE 802.11ac (VHT20): 20.99 dBm (0.1479 W) for Ant. 1 IEEE 802.11ac (VHT40): 19.36 dBm (0.1786 W) for Ant. 1 IEEE 802.11ac (VHT80): 16.67 dBm (0.0390 W) for Ant. 1 </p> <p> IEEE 802.11a: 23.32 dBm (0.1578 W) for Ant. 2 IEEE 802.11n (HT20): 23.13 dBm (0.1560 W) for Ant. 2 IEEE 802.11n (HT40): 23.80 dBm (0.1820 W) for Ant. 2 IEEE 802.11ac (VHT20): 23.20 dBm (0.1493 W) for Ant. 2 IEEE 802.11ac (VHT40): 23.96 dBm (0.1791 W) for Ant. 2 IEEE 802.11ac (VHT80): 18.98 dBm (0.0610 W) for Ant. 2 </p> <p> IEEE 802.11a: 20.60 dBm (0.1148 W) IEEE 802.11n (HT20): 20.99 dBm (0.1256 W) IEEE 802.11n (HT40): 24.08 dBm (0.2559 W) IEEE 802.11ac (VHT20): 20.91 dBm (0.1233 W) IEEE 802.11ac (VHT40): 24.19 dBm (0.2624 W) IEEE 802.11ac (VHT80): 20.53 dBm (0.1130 W) </p>

Maximum Conducted Output Power for UNII-2C (2TX) CDD	<p> IEEE 802.11a: 22.02 dBm (0.1950 W) for Ant. 1 IEEE 802.11n (HT20): 21.82 dBm (0.1698 W) for Ant. 1 IEEE 802.11n (HT40): 22.22 dBm (0.2275 W) for Ant. 1 IEEE 802.11ac (VHT20): 21.96 dBm (0.1941 W) for Ant. 1 IEEE 802.11ac (VHT40): 22.30 dBm (0.2173 W) for Ant. 1 IEEE 802.11ac (VHT80): 21.61 dBm (0.0964 W) for Ant. 1 </p> <p> IEEE 802.11a: 22.84 dBm (0.1932 W) for Ant. 2 IEEE 802.11n (HT20): 22.46 dBm (0.1910 W) for Ant. 2 IEEE 802.11n (HT40): 23.91 dBm (0.2291 W) for Ant. 2 IEEE 802.11ac (VHT20): 22.49 dBm (0.1923 W) for Ant. 2 IEEE 802.11ac (VHT40): 23.12 dBm (0.2143 W) for Ant. 2 IEEE 802.11ac (VHT80): 19.28 dBm (0.0953 W) for Ant. 2 </p> <p> IEEE 802.11a: 20.03 dBm (0.1007 W) IEEE 802.11n (HT20): 24.27 dBm (0.2673 W) IEEE 802.11n (HT40): 24.40 dBm (0.2754 W) IEEE 802.11ac (VHT20): 24.28 dBm (0.2679 W) IEEE 802.11ac (VHT40): 24.02 dBm (0.2523 W) IEEE 802.11ac (VHT80): 24.00 dBm (0.2512 W) </p>
Maximum Conducted Output Power for UNII-3 (2TX) CDD	<p> IEEE 802.11a: 21.56 dBm (0.1880 W) for Ant. 1 IEEE 802.11n (HT20): 21.73 dBm (0.1807 W) for Ant. 1 IEEE 802.11n (HT40): 21.79 dBm (0.2014 W) for Ant. 1 IEEE 802.11ac (VHT20): 22.04 dBm (0.1824 W) for Ant. 1 IEEE 802.11ac (VHT40): 21.96 dBm (0.2023 W) for Ant. 1 IEEE 802.11ac (VHT80): 19.71 dBm (0.0207 W) for Ant. 1 </p> <p> IEEE 802.11a: 22.67 dBm (0.1845 W) for Ant. 2 IEEE 802.11n (HT20): 22.24dBm (0.1786 W) for Ant. 2 IEEE 802.11n (HT40): 22.29 dBm (0.0207 W) for Ant. 2 IEEE 802.11ac (VHT20): 22.32 dBm (0.1786 W) for Ant. 2 IEEE 802.11ac (VHT40): 22.45 dBm (0.2018 W) for Ant. 2 IEEE 802.11ac (VHT80): 18.48dBm (0.0662 W) for Ant. 2 </p> <p> IEEE 802.11a: 24.84 dBm (0.3048 W) IEEE 802.11n (HT20): 24.78 dBm (0.3006 W) IEEE 802.11n (HT40): 24.71 dBm (0.2958 W) IEEE 802.11ac (VHT20): 24.89 dBm (0.3083 W) IEEE 802.11ac (VHT40): 24.71 dBm (0.2958 W) IEEE 802.11ac (VHT80): 22.32 dBm (0.1706 W) </p>

Maximum Conducted Output Power for UNII-1 (2TX) Beamforming	IEEE 802.11a: 24.55 dBm (0.2851 W) IEEE 802.11n (HT20): 24.36 dBm (0.2729 W) IEEE 802.11n (HT40): 25.30 dBm (0.3388 W) IEEE 802.11ac (VHT20): 24.38 dBm (0.2742 W) IEEE 802.11ac (VHT40): 25.36 dBm (0.3436 W) IEEE 802.11ac (VHT80): 19.43 dBm (0.0877 W)
Maximum Conducted Output Power for UNII-2A (2TX) Beamforming	IEEE 802.11a: 20.28 dBm (0.1067 W) IEEE 802.11n (HT20): 20.73 dBm (0.1183 W) IEEE 802.11n (HT40): 20.56 dBm (0.1138 W) IEEE 802.11ac (VHT20): 20.78 dBm (0.1197 W) IEEE 802.11ac (VHT40): 20.70 dBm (0.1175 W) IEEE 802.11ac (VHT80): 20.46 dBm (0.1112 W)
Maximum Conducted Output Power for UNII-2C (2TX) Beamforming	IEEE 802.11a: 19.82 dBm (0.0959 W) IEEE 802.11n (HT20): 20.53 dBm (0.1130 W) IEEE 802.11n (HT40): 20.74 dBm (0.1186 W) IEEE 802.11ac (VHT20): 20.69 dBm (0.1172 W) IEEE 802.11ac (VHT40): 20.84 dBm (0.1213 W) IEEE 802.11ac (VHT80): 20.59 dBm (0.1146 W)
Maximum Conducted Output Power for UNII-3 (2TX) Beamforming	IEEE 802.11a: 24.75 dBm (0.2985 W) IEEE 802.11n (HT20): 24.56 dBm (0.2858 W) IEEE 802.11n (HT40): 24.61 dBm (0.2891 W) IEEE 802.11ac (VHT20): 24.75 dBm (0.2985 W) IEEE 802.11ac (VHT40): 24.65 dBm (0.2917 W) IEEE 802.11ac (VHT80): 22.21 dBm (0.1663 W)

Note:

1. For a more detailed features description, please refer to the manufacturer's specifications or the user's manual.

2. Channel List:



IEEE 802.11a IEEE 802.11n (HT20) IEEE 802.11ac (VHT20)		IEEE 802.11n (HT40) IEEE 802.11ac (VHT40)		IEEE 802.11ac (VHT80)	
UNII-1		UNII-1		UNII-1	
Channel	Frequency (MHz)	Channel	Frequency (MHz)	Channel	Frequency (MHz)
36	5180	38	5190	42	5210
40	5200	46	5230		
44	5220				
48	5240				

IEEE 802.11a IEEE 802.11n (HT20) IEEE 802.11ac (VHT20)		IEEE 802.11n (HT40) IEEE 802.11ac (VHT40)		IEEE 802.11ac (VHT80)	
UNII-2A		UNII-2A		UNII-2A	
Channel	Frequency (MHz)	Channel	Frequency (MHz)	Channel	Frequency (MHz)
52	5260	54	5270	58	5290
56	5280	62	5310		
60	5300				
64	5320				

IEEE 802.11a IEEE 802.11n (HT20) IEEE 802.11ac (VHT20)		IEEE 802.11n (HT40) IEEE 802.11ac (VHT40)		IEEE 802.11ac (VHT80)	
UNII-2C		UNII-2C		UNII-2C	
Channel	Frequency (MHz)	Channel	Frequency (MHz)	Channel	Frequency (MHz)
100	5500	102	5510	106	5530
104	5520	110	5550	122	5610
108	5540	118	5590		
112	5560	126	5630		
116	5580	134	5670		
120	5600				
124	5620				
128	5640				
132	5660				
136	5680				
140	5700				

IEEE 802.11a IEEE 802.11n (HT20) IEEE 802.11ac (VHT20)		IEEE 802.11n (HT40) IEEE 802.11ac (VHT40)		IEEE 802.11ac (VHT80)	
UNII-3		UNII-3		UNII-3	
Channel	Frequency (MHz)	Channel	Frequency (MHz)	Channel	Frequency (MHz)
149	5745	151	5755	155	5775
153	5765	159	5795		
157	5785				
161	5805				
165	5825				

For 2T2R
3. Antenna Specification:

Ant.	Brand	Model Name	Antenna Type	Connector	Gain (dBi)	Note
1		N/A	PCB	N/A	4.9	N/A
2		N/A	PCB	N/A	6	N/A

Note:

This EUT supports Beamforming and CDD, all antennas have unequal gains, any transmit signals are correlated with each other, so

1) Beamforming:

Directional gain = $10\log[(10^{G1/20}+10^{G2/20}+\dots+10^{GN/20})^2/N_{ANT}]dBi$,

that is Directional gain= $10\log[(10^{G1/20}+10^{G2/20}+\dots+10^{GN/20})^2/N_{ANT}]dBi = 8.48$;

Then, the UNII-1, UNII-3 output power limit is $30-8.48+6=27.52$, the UNII-2A, UNII-2C output power limit is $24-8.48+6=21.52$. The UNII-1 power spectral density limit is $17-8.48+6=14.52$, UNII-2A, UNII-2C power spectral density limit is $11-8.48+6=8.52$, the UNII-3 power spectral density limit is $30-8.48+6=27.52$.

2) CDD:

For power spectral density measurements, the Directional

gain= $10\log[(10^{G1/20}+10^{G2/20}+\dots+10^{GN/20})^2/N_{ANT}]dBi$,

that is Directional gain= $10\log[(10^{G1/20}+10^{G2/20}+\dots+10^{GN/20})^2/N_{ANT}]dBi = 8.48$;

Then, the UNII-1 power spectral density limited is $17-8.48+6=14.52$, UNII-2A, UNII-2C power spectral density limit is $11-8.48+6=8.52$, the UNII-3 power spectral density limit is $30-8.48+6=27.52$.

For power measurements, Directional gain= $G_{ANT\ MAX.}+Array\ Gain$. Array Gain= $0dB(N_{ANT}\leq 4)$, so the Directional gain= 6 .

4 Table for Antenna Configuration:

Operating Mode	Ant. 1	Ant. 2	Ant. 1+2
	TX Mode		
IEEE 802.11a	✓	✓	✓
IEEE 802.11 n (HT20)	✓	✓	✓
IEEE 802.11n (HT40)	✓	✓	✓
IEEE 802.11 ac (VHT20)	✓	✓	✓
IEEE 802.11ac (VHT40)	✓	✓	✓
IEEE 802.11ac (VHT80)	✓	✓	✓

2.2 TEST MODES

The test system was pre-tested based on the consideration of all possible combinations of EUT operation mode.

Pretest Mode	Description
Mode 1	TX A Mode / CH36, CH40, CH48 (UNII-1)
Mode 2	TX N (HT20) Mode / CH36, CH40, CH48 (UNII-1)
Mode 3	TX N (HT40) Mode / CH38, CH46 (UNII-1)
Mode 4	TX AC (VHT20) Mode / CH36, CH40, CH48 (UNII-1)
Mode 5	TX AC (VHT40) Mode / CH38, CH46 (UNII-1)
Mode 6	TX AC (VHT80) Mode / CH42 (UNII-1)
Mode 7	TX A Mode / CH52, CH60, CH64 (UNII-2A)
Mode 8	TX N (HT20) Mode / CH52, CH60, CH64 (UNII-2A)
Mode 9	TX N (HT40) Mode / CH54, CH62 (UNII-2A)
Mode 10	TX AC (VHT20) Mode / CH52, CH60, CH64 (UNII-2A)
Mode 11	TX AC (VHT40) Mode / CH54, CH62 (UNII-2A)
Mode 12	TX AC (VHT80) Mode / CH58 (UNII-2A)
Mode 13	TX A Mode / CH100, CH116, CH140 (UNII-2C)
Mode 14	TX N (HT20) Mode / CH100, CH116, CH140 (UNII-2C)
Mode 15	TX N (HT40) Mode / CH102, CH110, CH134 (UNII-2C)
Mode 16	TX AC (VHT20) Mode / CH100, CH116, CH140 (UNII-2C)
Mode 17	TX AC (VHT40) Mode / CH102, CH110, CH134 (UNII-2C)
Mode 18	TX AC (VHT80) Mode / CH106, CH122 (UNII-2C)
Mode 19	TX A Mode / CH149,CH157,CH165 (UNII-3)
Mode 20	TX N (HT20) Mode / CH149,CH157,CH165 (UNII-3)
Mode 21	TX N (HT40) Mode / CH151,CH159 (UNII-3)
Mode 22	TX AC (VHT20) Mode / CH149,CH157,CH165 (UNII-3)
Mode 23	TX AC (VHT40) Mode / CH151,CH159 (UNII-3)
Mode 24	TX AC (VHT80) Mode / CH155 (UNII-3)
Mode 25	TX AC(VHT40) Mode / CH146 (UNII-1)

Following mode(s) as (were) found to be the worst case(s) and selected for the final test.

AC power line conducted emissions test	
Final Test Mode	Description
Mode 25	TX AC(VHT40) Mode / CH146 (UNII-1)

Radiated emissions test	
Final Test Mode	Description
Mode 1	TX A Mode / CH36, CH40, CH48 (UNII-1)
Mode 2	TX AC (VHT20) Mode / CH36, CH40, CH48 (UNII-1)
Mode 3	TX AC (VHT40) Mode / CH38, CH46 (UNII-1)
Mode 4	TX AC (VHT80) Mode / CH42 (UNII-1)
Mode 5	TX A Mode / CH52, CH60, CH64 (UNII-2A)
Mode 6	TX AC (VHT20) Mode / CH52, CH60, CH64 (UNII-2A)
Mode 7	TX AC (VHT40) Mode / CH54, CH62 (UNII-2A)
Mode 8	TX AC (VHT80) Mode / CH58 (UNII-2A)
Mode 9	TX A Mode / CH100, CH116, CH140 (UNII-2C)
Mode 10	TX AC (VHT20) Mode / CH100, CH116, CH140 (UNII-2C)
Mode 11	TX AC (VHT40) Mode / CH102, CH110, CH134 (UNII-2C)
Mode 12	TX AC (VHT80) Mode / CH106, CH122 (UNII-2C)
Mode 13	TX A Mode / CH149,CH157,CH165 (UNII-3)
Mode 14	TX AC (VHT20) Mode / CH149,CH157,CH165 (UNII-3)
Mode 15	TX AC (VHT40) Mode / CH151,CH159 (UNII-3)
Mode 16	TX AC (VHT80) Mode / CH155 (UNII-3)

Conducted test	
Test Mode	Description
Mode 1	TX A Mode / CH36, CH40, CH48 (UNII-1)
Mode 4	TX AC (VHT20) Mode / CH36, CH40, CH48 (UNII-1)
Mode 5	TX AC (VHT40) Mode / CH38, CH46 (UNII-1)
Mode 6	TX AC (VHT80) Mode / CH42 (UNII-1)
Mode 7	TX A Mode / CH52, CH60, CH64 (UNII-2A)
Mode 10	TX AC (VHT20) Mode / CH52, CH60, CH64 (UNII-2A)
Mode 11	TX AC (VHT40) Mode / CH54, CH62 (UNII-2A)
Mode 12	TX AC (VHT80) Mode / CH58 (UNII-2A)
Mode 13	TX A Mode / CH100, CH116, CH140 (UNII-2C)
Mode 16	TX AC (VHT20) Mode / CH100, CH116, CH140 (UNII-2C)
Mode 17	TX AC (VHT40) Mode / CH102, CH110, CH134 (UNII-2C)
Mode 18	TX AC (VHT80) Mode / CH106, CH122 (UNII-2C)
Mode 19	TX A Mode / CH149,CH157,CH165 (UNII-3)
Mode 22	TX AC (VHT20) Mode / CH149,CH157,CH165 (UNII-3)
Mode 23	TX AC (VHT40) Mode / CH151,CH159 (UNII-3)
Mode 24	TX AC (VHT80) Mode / CH155 (UNII-3)

Note:

- (1) For radiated emission below 1 GHz test, the IEEE 802.11ac40 is found to be the worst case and recorded.
- (2) For radiated emission above 1 GHz test, 1GHz~26.5GHz and 26.5GHz~40GHz have been pre-tested and in this report only recorded the worst case. The remaining spurious points are all below the limit value of 20dB.
- (3) The measurements for RF Output Power were tested during Beamforming and CDD, the worst case was CDD, only worst case was documented for other test items.
- (4) The low frequency, which started from 9 kHz to 30MHz, was pre-scanned and the result which was 20dB lower than the limit line was not reported.

2.3 PARAMETERS OF TEST SOFTWARE
CDD

UNII-1 - 2TX			
Test Software	QRCT4		
Test Frequency (MHz)	5180	5200	5240
IEEE 802.11a	20.5	22	22
Test Frequency (MHz)	5180	5200	5240
IEEE 802.11n (HT20)	21	22	22
Test Frequency (MHz)	5190	5230	
IEEE 802.11n (HT40)	17	22	

UNII-2A - 2TX			
Test Software	QRCT4		
Test Frequency (MHz)	5260	5300	5320
IEEE 802.11a	17	17	17.5
Test Frequency (MHz)	5260	5300	5320
IEEE 802.11n (HT20)	17.5	17.5	17.5
Test Frequency (MHz)	5270	5310	
IEEE 802.11n (HT40)	20.5	21	

UNII-2C - 2TX			
Test Software	QRCT4		
Test Frequency (MHz)	5500	5580	5700
IEEE 802.11a	16.5	16.5	16.5
Test Frequency (MHz)	5500	5580	5700
IEEE 802.11n (HT20)	16.5	22	22
Test Frequency (MHz)	5510	5550	5670
IEEE 802.11n (HT40)	16.5	21	22

UNII-3 - 2TX			
Test Software	QRCT4		
Test Frequency (MHz)	5745	5785	5825
IEEE 802.11a	22	22	22
Test Frequency (MHz)	5745	5785	5825
IEEE 802.11n (HT20)	22	22	22
Test Frequency (MHz)	5755	5795	
IEEE 802.11n (HT40)	22	22	

UNII-1 - 2TX			
Test Software	QRCT4		
Test Frequency (MHz)	5180	5200	5240
IEEE 802.11ac (VHT20)	21	22	22
Test Frequency (MHz)	5190	5230	
IEEE 802.11ac (VHT40)	17	22	
Test Frequency (MHz)	5210		
IEEE 802.11ac (VHT80)	16		

UNII-2A - 2TX			
Test Software	QRCT4		
Test Frequency (MHz)	5260	5300	5320
IEEE 802.11ac (VHT20)	17.5	17.5	17.5
Test Frequency (MHz)	5270	5310	
IEEE 802.11ac (VHT40)	20.5	21	
Test Frequency (MHz)	5290		
IEEE 802.11ac (VHT80)	17		

UNII-2C - 2TX			
Test Software	QRCT4		
Test Frequency (MHz)	5500	5580	5700
IEEE 802.11ac (VHT20)	16.5	22	22
Test Frequency (MHz)	5510	5550	5670
IEEE 802.11ac (VHT40)	16.5	21	22
Test Frequency (MHz)	5530	5610	
IEEE 802.11ac (VHT80)	15.5	22	

UNII-3 - 2TX			
Test Software	QRCT4		
Test Frequency (MHz)	5745	5785	5825
IEEE 802.11ac (VHT20)	22	22	22
Test Frequency (MHz)	5755	5795	
IEEE 802.11ac (VHT40)	22	22	
Test Frequency (MHz)	5775		
IEEE 802.11ac (VHT80)	19		

Beamforming

UNII-1 - 2TX			
Test Software	QRCT		
Test Frequency (MHz)	5180	5200	5240
IEEE 802.11a	20.5	22	22
Test Frequency (MHz)	5180	5200	5240
IEEE 802.11n (HT20)	21	22	22
Test Frequency (MHz)	5190	5230	
IEEE 802.11n (HT40)	17	22	

UNII-2A - 2TX			
Test Software	QRCT		
Test Frequency (MHz)	5260	5300	5320
IEEE 802.11a	17	17	17.5
Test Frequency (MHz)	5260	5300	5320
IEEE 802.11n (HT20)	17.5	17.5	17.5
Test Frequency (MHz)	5270	5310	
IEEE 802.11n (HT40)	17	17	

UNII-2C - 2TX			
Test Software	QRCT		
Test Frequency (MHz)	5500	5580	5700
IEEE 802.11a	16.5	16.5	16.5
Test Frequency (MHz)	5500	5580	5700
IEEE 802.11n (HT20)	16.5	17.5	17.5
Test Frequency (MHz)	5510	5550	5670
IEEE 802.11n (HT40)	16.5	17.5	17.5

UNII-3 - 2TX			
Test Software	QRCT		
Test Frequency (MHz)	5745	5785	5825
IEEE 802.11a	22	22	22
Test Frequency (MHz)	5745	5785	5825
IEEE 802.11n (HT20)	22	22	22
Test Frequency (MHz)	5755	5795	
IEEE 802.11n (HT40)	22	22	

UNII-1 - 2TX			
Test Software	QRCT		
Test Frequency (MHz)	5180	5200	5240
IEEE 802.11ac (VHT20)	21	22	22
Test Frequency (MHz)	5190	5230	
IEEE 802.11ac (VHT40)	17	22	
Test Frequency (MHz)	5210		
IEEE 802.11ac (VHT80)	16		

UNII-2A - 2TX			
Test Software	QRCT		
Test Frequency (MHz)	5260	5300	5320
IEEE 802.11ac (VHT20)	17.5	17.5	17.5
Test Frequency (MHz)	5270	5310	
IEEE 802.11ac (VHT40)	17	17	
Test Frequency (MHz)	5290		
IEEE 802.11ac (VHT80)	17		

UNII-2C - 2TX			
Test Software	QRCT		
Test Frequency (MHz)	5500	5580	5700
IEEE 802.11ac (VHT20)	16.5	17.5	17.5
Test Frequency (MHz)	5510	5550	5670
IEEE 802.11ac (VHT40)	16.5	17.5	17.5
Test Frequency (MHz)	5530	5610	
IEEE 802.11ac (VHT80)	15.5	18	

UNII-3 - 2TX			
Test Software	QRCT		
Test Frequency (MHz)	5745	5785	5825
IEEE 802.11ac (VHT20)	22	22	22
Test Frequency (MHz)	5755	5795	
IEEE 802.11ac (VHT40)	22	22	
Test Frequency (MHz)	5775		
IEEE 802.11ac (VHT80)	19		

2.4 DUTY CYCLE

If duty cycle is $\geq 98\%$, duty factor is not required.
 If duty cycle is $< 98\%$, duty factor shall be considered.
 The output power = measured power + duty factor.

IEEE 802.11a

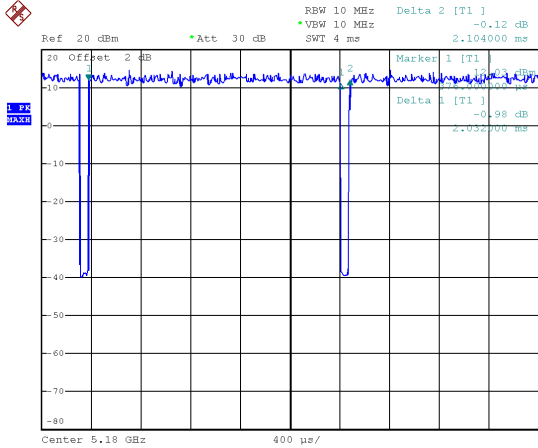

Date: 27.MAY.2020 12:31:44

Duty cycle = $2.032 \text{ ms} / 2.104 \text{ ms} = 96.58\%$
 Duty Factor = $10 * \log(1 / \text{Duty cycle}) = 0.15 \text{ dB}$

IEEE 802.11n (HT40)

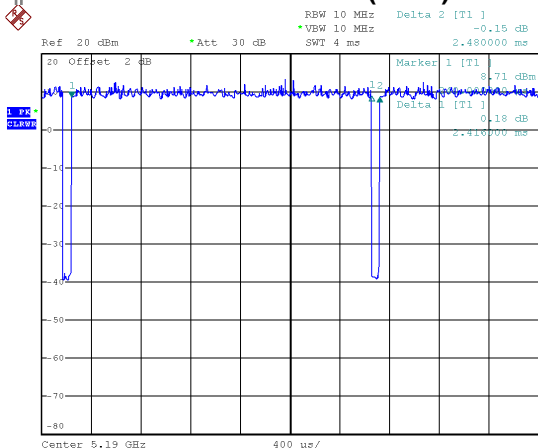

Date: 27.MAY.2020 13:41:56

Duty cycle = $2.416 \text{ ms} / 2.480 \text{ ms} = 97.42\%$
 Duty Factor = $10 * \log(1 / \text{Duty cycle}) = 0.11 \text{ dB}$

IEEE 802.11n (HT20)

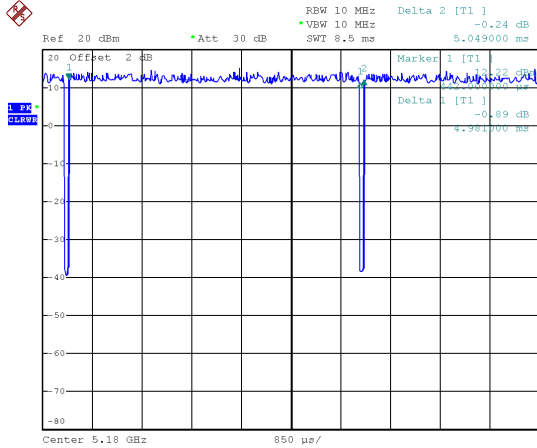

Date: 27.MAY.2020 12:32:31

Duty cycle = $4.981 \text{ ms} / 5.049 \text{ ms} = 98.65\%$
 Duty Factor = $10 * \log(1 / \text{Duty cycle}) = 0.00 \text{ dB}$

IEEE 802.11ac (VHT20)

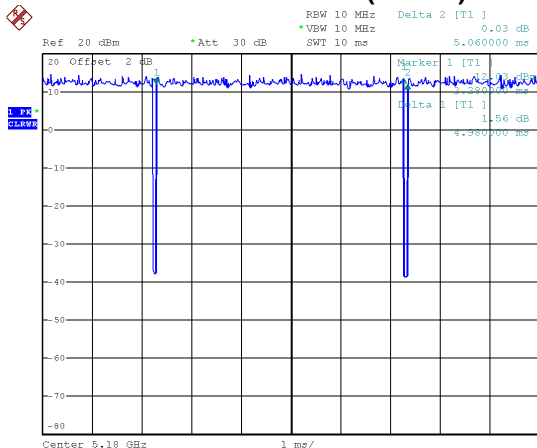

Date: 27.MAY.2020 12:33:53

Duty cycle = $4.980 \text{ ms} / 5.060 \text{ ms} = 98.42\%$
 Duty Factor = $10 * \log(1 / \text{Duty cycle}) = 0.00 \text{ dB}$

IEEE 802.11ac (VHT40)

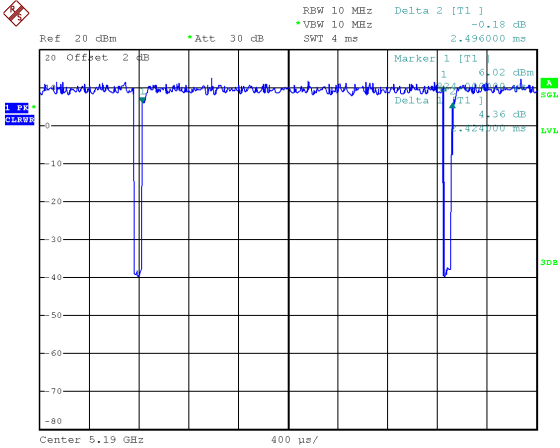

IEEE 802.11ac (VHT80)

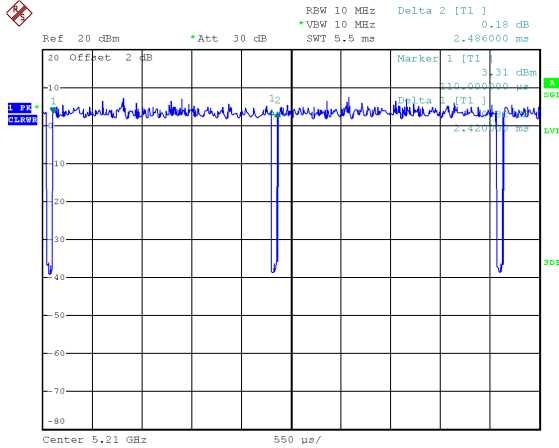

Date: 27.MAY.2020 13:42:44

Date: 27.MAY.2020 13:43:43

Duty cycle = 2.424 ms / 2.496 ms = 97.12%
 Duty Factor = 10 * log(1 / Duty cycle) = 0.13 dB

Duty cycle = 2.420 ms / 2.486 ms = 97.35%
 Duty Factor = 10 * log(1 / Duty cycle) = 0.12 dB

NOTE:

For IEEE 802.11a, IEEE 802.11n (HT20) and IEEE 802.11ac (VHT20):

For radiated emissions frequency above 1 GHz, the resolution bandwidth of test receiver/spectrum analyzer is 1 MHz and the video bandwidth is 1 kHz (Duty cycle < 98%).

For IEEE 802.11n (HT40) and IEEE 802.11ac (VHT40):

For radiated emissions frequency above 1 GHz, the resolution bandwidth of test receiver/spectrum analyzer is 1 MHz and the video bandwidth is 2 kHz (Duty cycle < 98%).

For IEEE 802.11ac (VHT80):

For radiated emissions frequency above 1 GHz, the resolution bandwidth of test receiver/spectrum analyzer is 1 MHz and the video bandwidth is 3 kHz (Duty cycle < 98%).

2.5 BLOCK DIAGRAM SHOWING THE CONFIGURATION OF SYSTEM TESTED

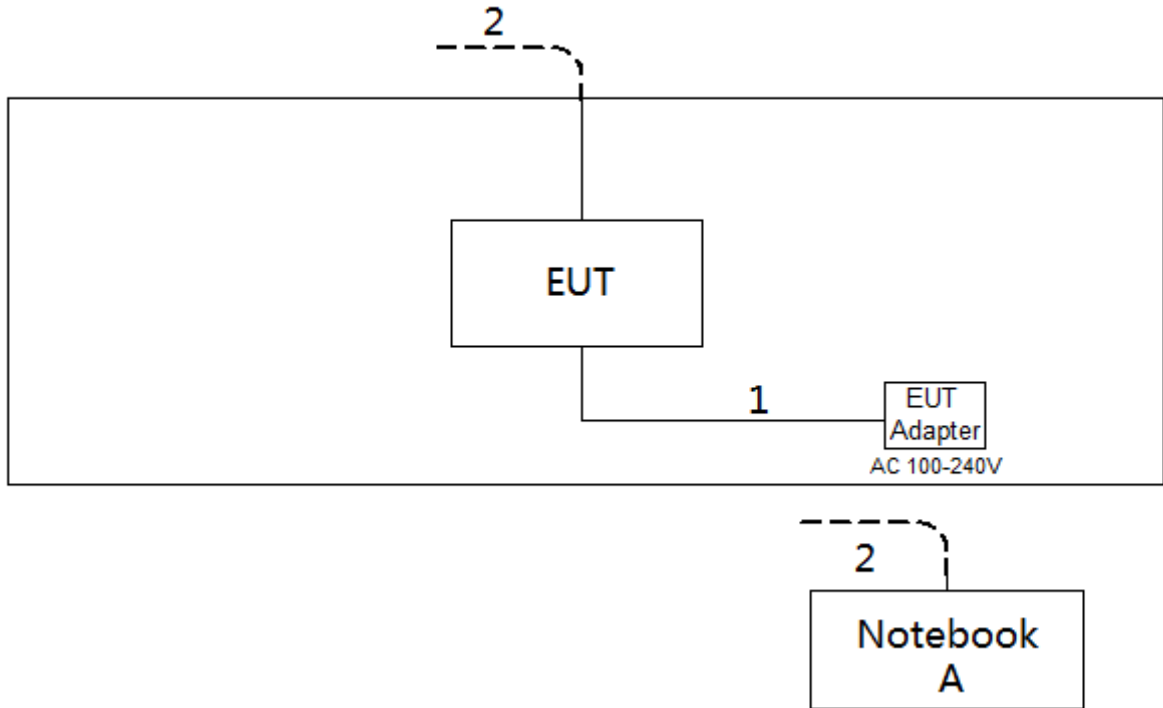

2.6 SUPPORT UNITS

Item	Equipment	Brand	Model No.	Series No.
A	Notebook	Dell	Inspiron 15-7559	N/A

Item	Cable Type	Shielded Type	Ferrite Core	Length
1	DC Cable	NO	NO	1.5m
2	RJ45 Cable	NO	NO	10m

3. AC POWER LINE CONDUCTED EMISSIONS TEST

3.1 LIMIT

Frequency (MHz)	Limit (dB μ V)	
	Quasi-peak	Average
0.15 - 0.5	66 to 56*	56 to 46*
0.50 - 5.0	56	46
5.0 - 30.0	60	50

NOTE:

- (1) The tighter limit applies at the band edges.
- (2) The limit of " * " marked band means the limitation decreases linearly with the logarithm of the frequency in the range.

The following table is the setting of the receiver

Receiver Parameter	Setting
Attenuation	10 dB
Start Frequency	0.15 MHz
Stop Frequency	30 MHz
IF Bandwidth	9 KHz

3.2 TEST PROCEDURE

- a. The EUT was placed 0.8 meters from the horizontal ground plane with EUT being connected to the power mains through a line impedance stabilization network (LISN). All other support equipment powered from additional LISN(s). The LISN provide 50 Ohm/ 50uH of coupling impedance for the measuring instrument.
- b. Interconnecting cables that hang closer than 40 cm to the ground plane shall be folded back and forth in the center forming a bundle 30 to 40 cm long.
- c. I/O cables that are not connected to a peripheral shall be bundled in the center. The end of the cable may be terminated, if required, using the correct terminating impedance. The overall length shall not exceed 1 m.
- d. LISN at least 80 cm from nearest part of EUT chassis.
- e. For the actual test configuration, please refer to the related Item -EUT Test Photos.

3.3 DEVIATION FROM TEST STANDARD

No deviation

3.4 TEST SETUP

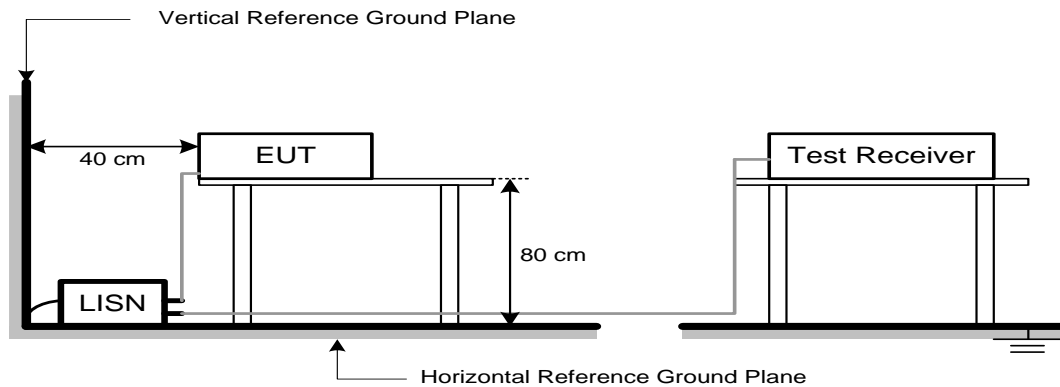

3.5 EUT OPERATION CONDITIONS

The EUT was configured for testing in a typical fashion (as a customer would normally use it). The EUT has been programmed to continuously transmit during test. This operating condition was tested and used to collect the included data.

The EUT was programmed to be in continuously transmitting/TX mode.

3.6 TEST RESULTS

Please refer to the APPENDIX A.

4. RADIATED EMISSIONS TEST

4.1 LIMIT

In case the emission fall within the restricted band specified on 15.205(a), then the 15.209(a) limit in the table below has to be followed.

LIMITS OF RADIATED EMISSIONS MEASUREMENT (9 kHz to 1000 MHz)

Frequency (MHz)	Field Strength (microvolts/meter)	Measurement Distance (meters)
0.009-0.490	2400/F(kHz)	300
0.490-1.705	24000/F(kHz)	30
1.705-30.0	30	30
30-88	100	3
88-216	150	3
216-960	200	3
Above 960	500	3

LIMITS OF UNWANTED EMISSION OUT OF THE RESTRICTED BANDS

Frequency (MHz)	EIRP Limit (dBm/MHz)	Equivalent Field Strength at 3m (dBμV/m)
5150-5250	-27	68.3
5250-5350	-27	68.3
5470-5725	-27	68.3
5725-5850	-27 NOTE (2)	68.3
	10 NOTE (2)	105.3
	15.6 NOTE (2)	110.9
	27 NOTE (2)	122.3

NOTE:

- (1) The following formula is used to convert the equipment isotropic radiated power (eirp) to field strength:

$$E = \frac{1000000\sqrt{30P}}{3} \mu\text{V/m, where P is the eirp (Watts)}$$

- (2) According to 15.407(b)(4)(i), all emissions shall be limited to a level of -27 dBm/MHz at 75 MHz or more above or below the band edge increasing linearly to 10 dBm/MHz at 25 MHz above or below the band edge, and from 25 MHz above or below the band edge increasing linearly to a level of 15.6 dBm/MHz at 5 MHz above or below the band edge, and from 5 MHz above or below the band edge increasing linearly to a level of 27 dBm/MHz at the band edge.

4.2 TEST PROCEDURE

- a. The measuring distance of 3 m shall be used for measurements. The EUT was placed on the top of a rotating table 0.8 meter above the ground at a 3 meter semi-anechoic chamber. The table was rotated 360 degrees to determine the position of the highest radiation.(below 1GHz)
- b. The measuring distance of 3 m shall be used for measurements. The EUT was placed on the top of a rotating table 1.5 meter above the ground at a 3 meter semi-anechoic chamber. The table was rotated 360 degrees to determine the position of the highest radiation.(above 1GHz)
- c. The height of the equipment or of the substitution antenna shall be 0.8m or 1.5m; the height of the test antenna shall vary between 1 m to 4 m. Both horizontal and vertical polarizations of the antenna are set to make the measurement.
- d. For each suspected emission, the EUT was arranged to its worst case and then the antenna was tuned to heights find the maximum reading (used Bore sight function).
- e. The receiver system was set to peak and average detect function and specified bandwidth with maximum hold mode when the test frequency is above 1 GHz.
- f. The initial step in collecting radiated emission data is a receiver peak detector mode pre-scanning the measurement frequency range. Significant peaks are then marked and then Quasi Peak detector mode re-measured.
- g. All readings are Peak unless otherwise stated QP in column of Note. Peak denotes that the Peak reading compliance with the QP Limits and then QP Mode measurement didn't perform. (below 1 GHz)
- h. All readings are Peak Mode value unless otherwise stated AVG in column of Note. If the Peak Mode Measured value compliance with the Peak Limits and lower than AVG Limits, the EUT shall be deemed to meet both Peak & AVG Limits and then only Peak Mode was measured, but AVG Mode didn't perform. (above 1 GHz)
- i. For the actual test configuration, please refer to the related Item –EUT Test Photos.

4.3 DEVIATION FROM TEST STANDARD

No deviation

4.4 TEST SETUP

9 kHz to 30 MHz

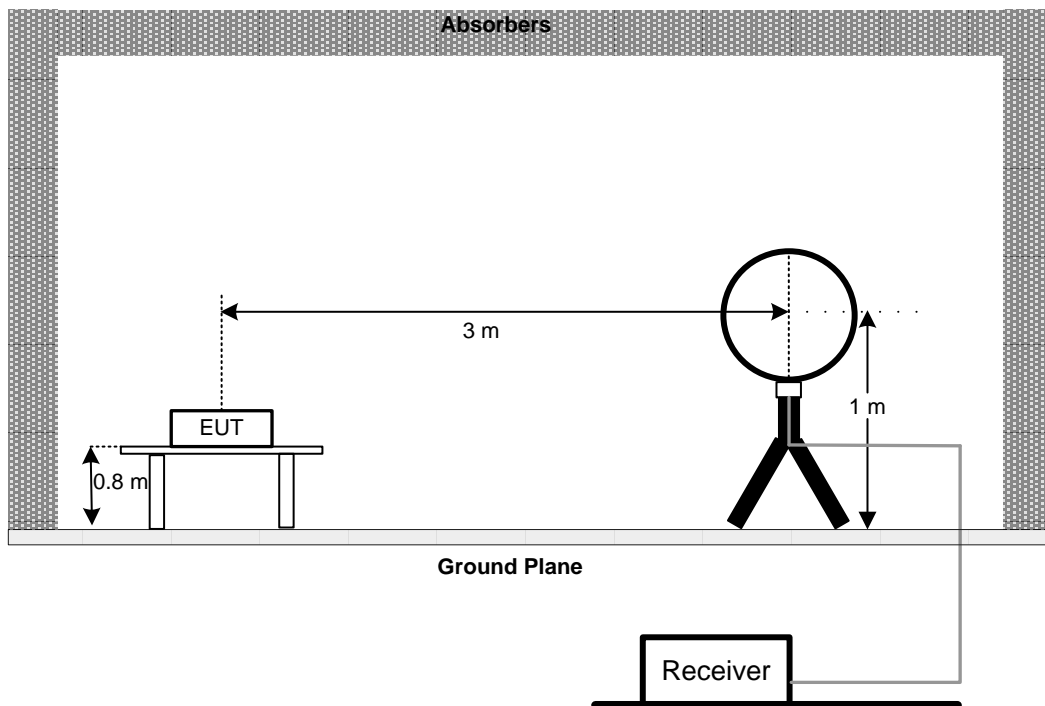

30 MHz to 1 GHz

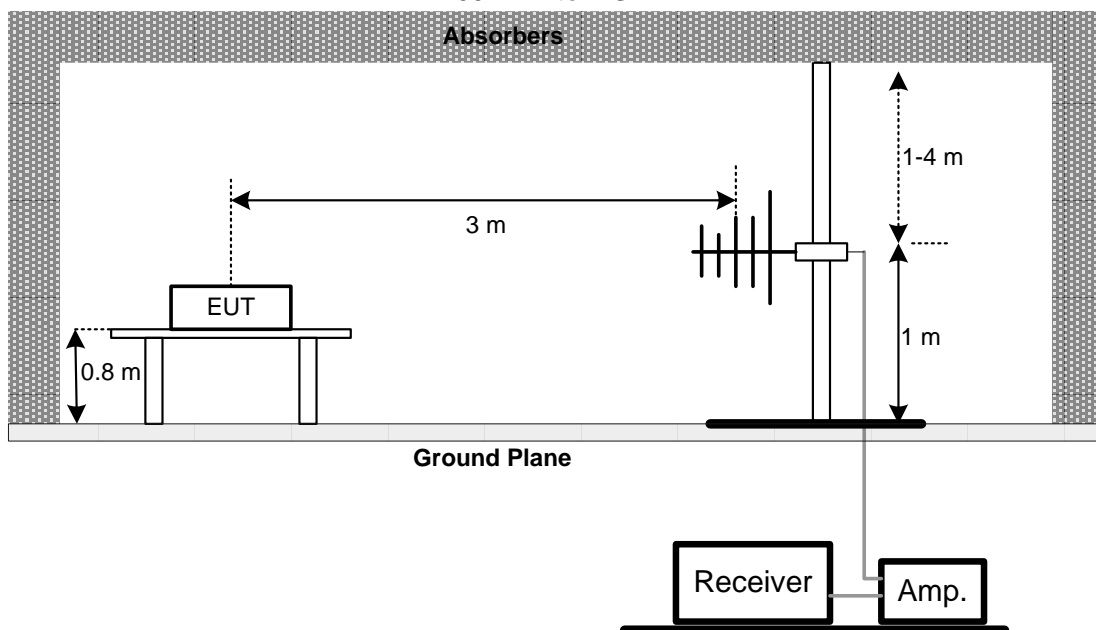

Above 1 GHz

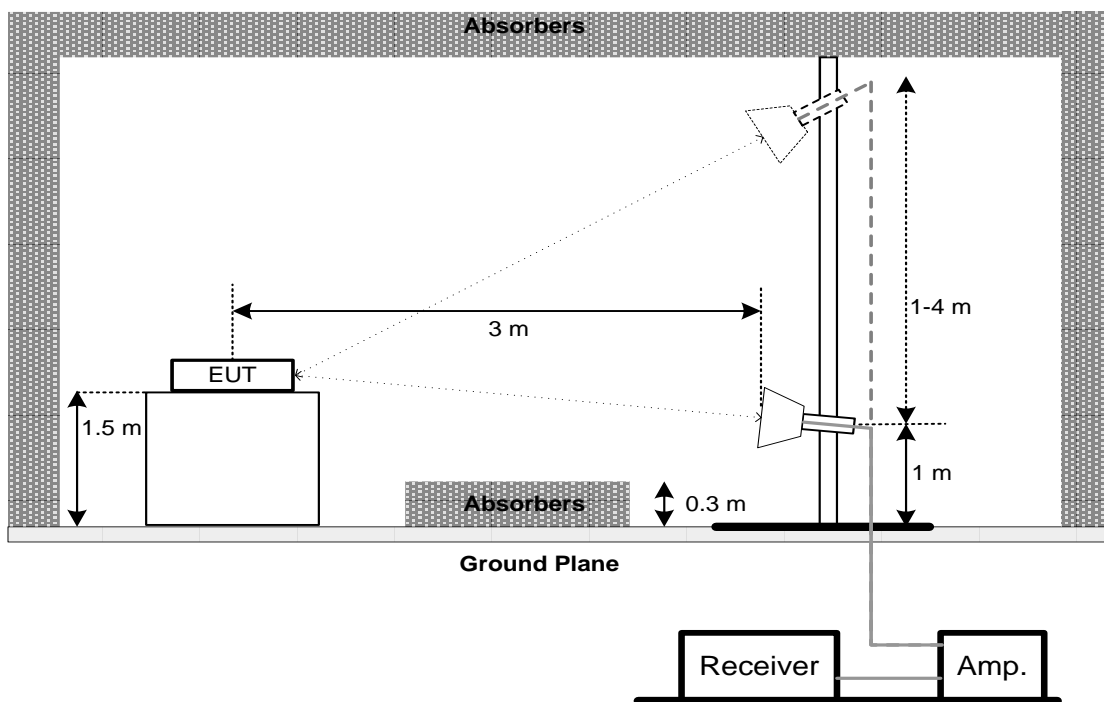

Above 1 GHz Band edge

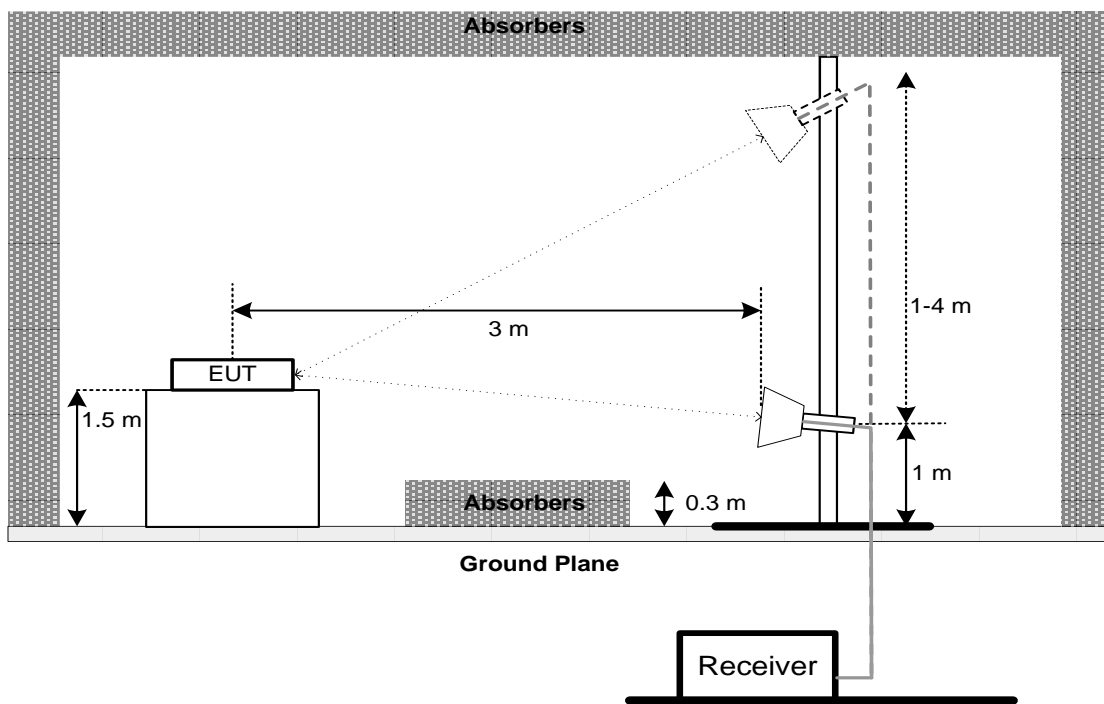

4.5 EUT OPERATION CONDITIONS

The EUT tested system was configured as the statements of 3.5 unless otherwise a special operating condition is specified in the follows during the testing.

4.6 TEST RESULTS - 9 KHZ to 30 MHZ

Please refer to the APPENDIX B

Remark:

- (1) The amplitude of spurious emissions which are attenuated by more than 20 dB below the permissible value has no need to be reported.
- (2) Distance extrapolation factor = $40 \log$ (specific distance / test distance) (dB).
- (3) Limit line = specific limits (dBuV) + distance extrapolation factor.

4.7 TEST RESULTS - 30 MHz TO 1000 MHz

Please refer to the APPENDIX C.

4.8 TEST RESULTS - ABOVE 1000 MHz

Please refer to the APPENDIX D.

Remark:

- (1) No limit: This is fundamental signal, the judgment is not applicable.
For fundamental signal judgment was referred to Peak output test.

5. BANDWIDTH TEST

5.1 LIMIT

FCC Part15, Subpart E (15.407)			
Section	Test Item	Limit	Frequency Range (MHz)
15.407(a) 15.407(e)	26 dB Bandwidth	-	5150-5250
	26 dB Bandwidth	-	5250-5350
	26 dB Bandwidth	-	5470-5725
	6 dB Bandwidth	Minimum 500 kHz	5725-5850

5.2 TEST PROCEDURE

- a. The EUT was directly connected to the spectrum analyzer and antenna output port as show in the block diagram below
- b. a. Spectrum Setting:
For UNII-1, UNII-2A, UNII-2C:

Spectrum Parameter	Setting
Attenuation	Auto
Span Frequency	> 26 dB Bandwidth
RBW	300 kHz (Bandwidth 20 MHz) 1 MHz (Bandwidth 40 MHz and 80 MHz)
VBW	1 MHz (Bandwidth 20 MHz) 3 MHz (Bandwidth 40 MHz and 80 MHz)
Detector	Peak
Trace	Max Hold
Sweep Time	Auto

For UNII-3:

Spectrum Parameter	Setting
Attenuation	Auto
Span Frequency	6 dB Bandwidth
RBW	100 kHz
VBW	300 kHz
Detector	Peak
Trace	Max Hold
Sweep Time	Auto

- c. Measured the spectrum width with power higher than 26 dB below carrier

5.3 TEST PROCEDURE

No deviation.

5.4 TEST SETUP**5.5 EUT OPERATION CONDITIONS**

The EUT was programmed to be in continuously transmitting mode.

5.6 TEST RESULTS

Please refer to the APPENDIX E.

6. MAXIMUM OUTPUT POWER TEST

6.1 LIMIT

FCC Part15, Subpart E (15.407)			
Section	Test Item	Limit	Frequency Range (MHz)
15.407(a)	Conducted Output Power	AP device: 1 Watt (30 dBm) Client device: 250 mW (24 dBm)	5150-5250
		250 mW (24 dBm)	5250-5350
		250 mW (24 dBm)	5470-5725
		1 Watt (30dBm)	5725-5850

Note:

For an indoor access point operating in the band 5.15-5.25 GHz, the maximum conducted output power over the frequency band of operation shall not exceed 1 W provided the maximum antenna gain does not exceed 6 dBi. In addition, the maximum power spectral density shall not exceed 17 dBm in any 1 megahertz band. If transmitting antennas of directional gain greater than 6 dBi are used, both the maximum conducted output power and the maximum power spectral density shall be reduced by the amount in dB that the directional gain of the antenna exceeds 6 dBi.

- b. For the 5.25-5.35 GHz and 5.47-5.725 GHz bands, the maximum conducted output power over the frequency bands of operation shall not exceed the lesser of 250 mW or 11 dBm + 10log B, where B is the 26dB Bandwidth in megahertz.

6.2 TEST PROCEDURE

- a. The EUT was directly connected to the power meter and antenna output port as show in the block diagram below.
- b. Test test was performed in accordance with method of FCC KDB 789033 D02 General UNII Test Procedures New Rules v02r01.

6.3 DEVIATION FROM STANDARD

No deviation.

6.4 TEST SETUP



6.5 EUT OPERATION CONDITIONS

The EUT was programmed to be in continuously transmitting mode.

6.6 TEST RESULTS

Please refer to the APPENDIX F.

7. POWER SPECTRAL DENSITY TEST

7.1 LIMIT

FCC Part15, Subpart E (15.407)			
Section	Test Item	Limit	Frequency Range (MHz)
15.407(a)	Power Spectral Density	AP device: 17 dBm/MHz Client device: 11 dBm/MHz	5150-5250
		11 dBm/MHz	5250-5350
		11 dBm/MHz	5470-5725
		30 dBm/500 kHz	5725-5850

7.2 TEST PROCEDURE

- a. The EUT was directly connected to the spectrum analyzer and antenna output port as show in the block diagram below.
- b. Spectrum Setting

Spectrum Parameter	Setting
Attenuation	Auto
Span Frequency	Encompass the entire emissions bandwidth (EBW) of the signal
RBW	= 1 MHz.
VBW	≥ 3 MHz.
Detector	RMS
Trace average	100 trace
Sweep Time	Auto

Note:

1. For UNII-3, according to KDB publication 789033 D02 General UNII Test Procedures New Rules v02r01, section II.F.5., it is acceptable to set RBW at 1 MHz and VBW at 3 MHz if the spectrum analyzer does not have 500 kHz RBW.
2. The value measured with RBW=1 MHz is to be added with $10\log(500\text{ kHz}/1\text{ MHz})$ which is -3 dB. For example, if the measured value is +10dBm using RBW=1 MHz (that is +10 dBm/MHz), then the converted value will be +7dBm/500kHz.

7.3 DEVIATION FROM STANDARD

No deviation.

7.4 TEST SETUP**7.5 EUT OPERATION CONDITIONS**

The EUT was programmed to be in continuously transmitting mode.

7.6 TEST RESULTS

Please refer to the APPENDIX G.

8. FREQUENCY STABILITY MEASUREMENT

8.1 LIMIT

FCC Part15, Subpart E (15.407)			
Section	Test Item	Limit	Frequency Range (MHz)
15.407(g)	Frequency Stability	An emission is maintained within the band of operation under all conditions of normal operation as specified in the users manual.	5150-5250
			5250-5350
			5470-5725
			5725-5850

8.2 TEST PROCEDURE

- The EUT was directly connected to the spectrum analyzer and antenna output port as show in the block diagram below.
- Spectrum Setting:

Spectrum Parameter	Setting
Attenuation	Auto
Span Frequency	Entire absence of modulation emissions bandwidth
RBW	10 kHz
VBW	10 kHz
Sweep Time	Auto

- The test extreme voltage is to change the primary supply voltage from 85 to 115 percent of the nominal value.
- User manual temperature is 0°C~40°C.

8.3 DEVIATION FROM STANDARD

No deviation.

8.4 TEST SETUP

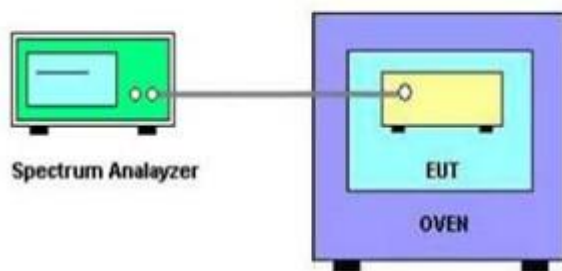

8.5 EUT OPERATION CONDITIONS

The EUT was programmed to be in continuously transmitting mode.

8.6 TEST RESULTS

Please refer to the APPENDIX H.

9. MEASUREMENT INSTRUMENTS LIST

AC Power Line Conducted Emissions					
Item	Kind of Equipment	Manufacturer	Type No.	Serial No.	Calibrated until
1	Line Impedance Stabilisation Network	Schwarzbeck	NNLK 8121	8121-822	Mar. 21, 2021
2	TWO-LINE V-NETWORK	R&S	ENV216	101340	Sep. 01, 2020
3	EMI Test Receiver	R&S	ESCI	100082	Mar. 21, 2021
4	50Ω coaxial switch	Anritsu	MP59B	6201750902	Mar. 21, 2021
5	Cable	10m	EMCRG400-BM-NM-10000	170628	Jul. 15, 2021
6	Measurement Software	Farad	EZ-EMC Ver.NB-03A1-01	N/A	N/A

Radiated Emissions - 9 kHz to 30 MHz					
Item	Kind of Equipment	Manufacturer	Type No.	Serial No.	Calibrated until
1	Loop Antenna	EMCI	EMCI LPA600	275	Apr. 02, 2021
2	Cable	N/A	EMCRG400-BM-NM-10000	170628	Jul. 15, 2021
3	MXE EMI Receiver	Keysight	N9038A	MY57150106	May. 06, 2021
4	Measurement Software	Farad	EZ-EMC Ver.BTL-2ANT-1	N/A	N/A

Radiated Emissions - 30 MHz to 1 GHz					
Item	Kind of Equipment	Manufacturer	Type No.	Serial No.	Calibrated until
1	TRILOG Broadband Antenna	Schwarzbeck	VULB 9168	719	Apr. 02, 2021
2	Pre-Amplifier	emci	EMC9135	980400	Mar. 21, 2021
3	MXE EMI Receiver	Keysight	N9038A	MY57150106	May. 06, 2021
4	Attenuator	emci	EMCI-N-6-06	AT-N0644	Mar. 21, 2021
5	Cable	7m	EMC104-SM-SM-7000	170330	Apr. 13, 2021
6	Cable	1m	EMC104-SM-SM-1000	170331	Apr. 13, 2021
7	Cable	3.5m	EMC104-SM-NM-3500	170621	Apr. 13, 2021
8	Measurement Software	Farad	EZ-EMC Ver.BTL-2ANT-1	N/A	N/A

Radiated Emissions - Above 1 GHz					
Item	Kind of Equipment	Manufacturer	Type No.	Serial No.	Calibrated until
1	Double-Ridged Waveguide Horn Antenna	Schwarzbeck	BBHA 9120D	9120D-1787	Mar. 21, 2021
2	Double-Ridged Waveguide Horn Antenna	ETS-Lindgren	3116C	00203919	Mar. 21, 2021
3	Pre-Amplifier	emci	EMC012645SE	980421	May. 11, 2021
4	Pre-Amplifier	emci	EMC184045SE	980409	Mar. 21, 2021
5	EXA Spectrum Analyzer	Keysight	N9010A	MY56480559	Mar. 21, 2021
6	MXE EMI Receiver	Keysight	N9038A	MY56400088	Mar. 21, 2021
7	Cable	7m	EMC104-SM-SM-7000	170330	Apr. 13, 2021
8	Cable	1m	EMC104-SM-SM-1000	170331	Apr. 13, 2021
9	Cable	3.5m	EMC104-SM-NM-3500	170621	Apr. 13, 2021
10	Cable	0.8m	EMC102-SM-SM-800	170335	Apr. 13, 2021
11	Cable	6m	EMC102-SM-SM-6000	170336	Apr. 13, 2021
12	Measurement Software	Farad	EZ-EMC Ver.NB-03A1-01	N/A	N/A

Bandwidth					
Item	Kind of Equipment	Manufacturer	Type No.	Serial No.	Calibrated until
1	Spectrum Analyzer	R&S	FSP40	100626	May. 06, 2021

Conducted Output Power					
Item	Kind of Equipment	Manufacturer	Type No.	Serial No.	Calibrated until
1	Spectrum Analyzer	R&S	FSP40	100626	May. 06, 2021

Power Spectral Density					
Item	Kind of Equipment	Manufacturer	Type No.	Serial No.	Calibrated until
1	Spectrum Analyzer	R&S	FSP40	100626	May. 06, 2021

Frequency Stability					
Item	Kind of Equipment	Manufacturer	Type No.	Serial No.	Calibrated until
1	Spectrum Analyzer	R&S	FSP40	100626	May. 06, 2021
2	Temperature And Humidity Box	Blue pand	BPHS-120B	170616454	Sep. 01, 2020

Remark: "N/A" denotes no model name, serial no. or calibration specified.

All calibration period of equipment list is one year.

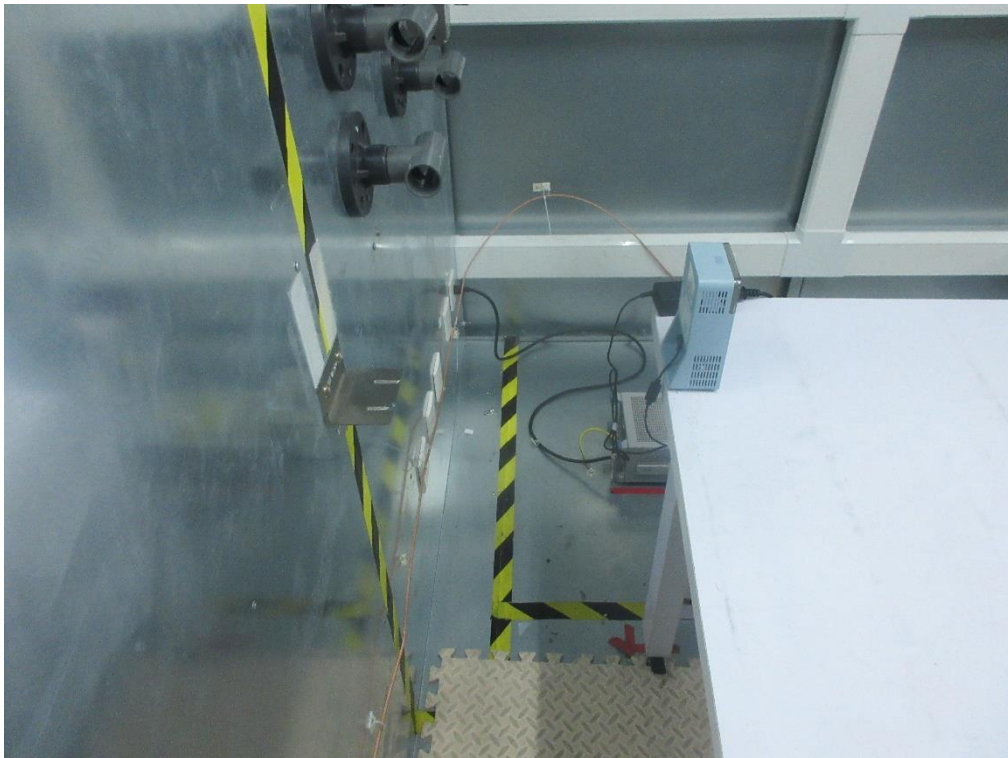
10. EUT TEST PHOTOS**Conducted Emissions Test Photos**

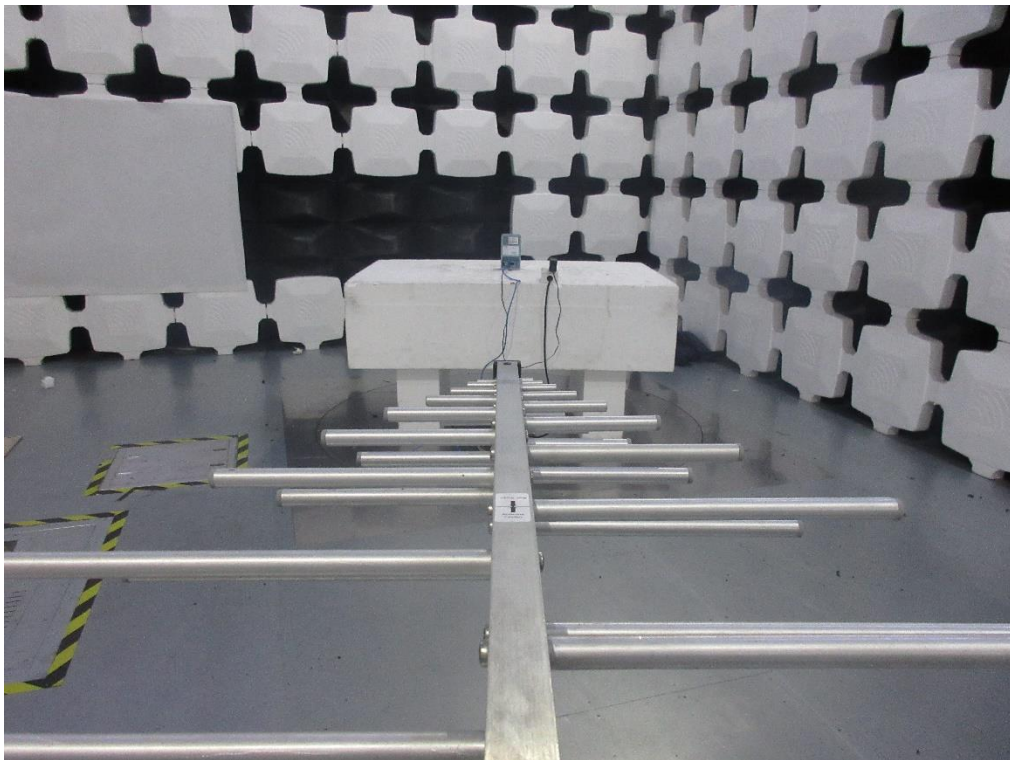
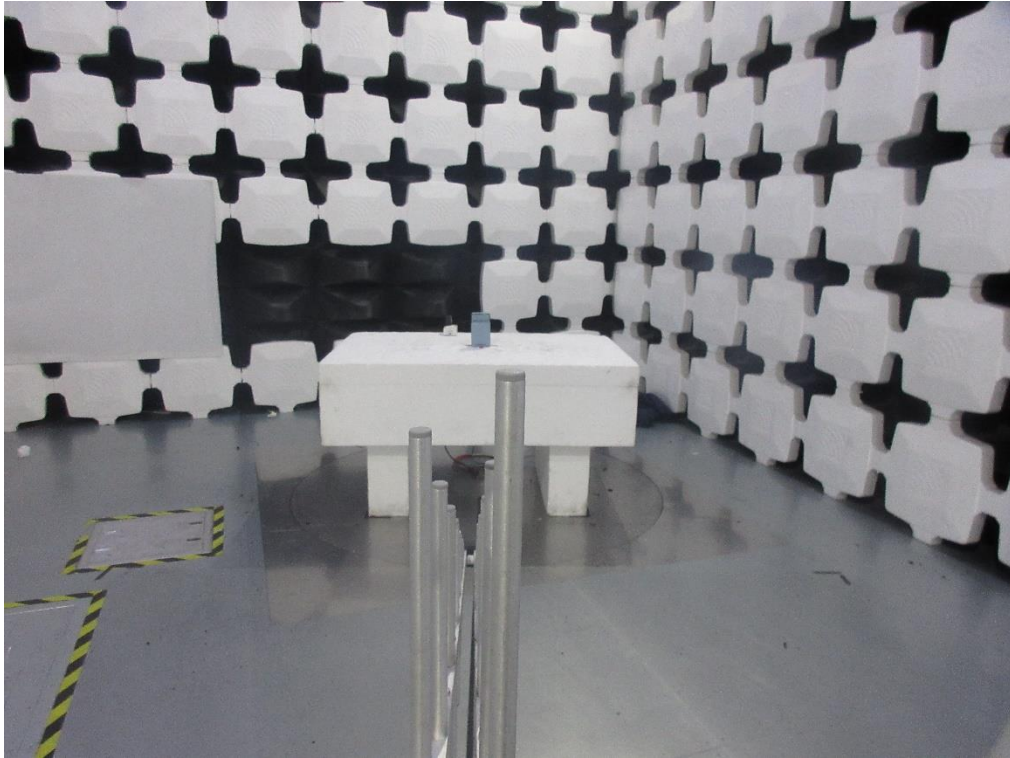
Radiated Emissions Test Photos**30 MHz to 1 GHz**

Radiated Emissions Test Photos

Above 1 GHz

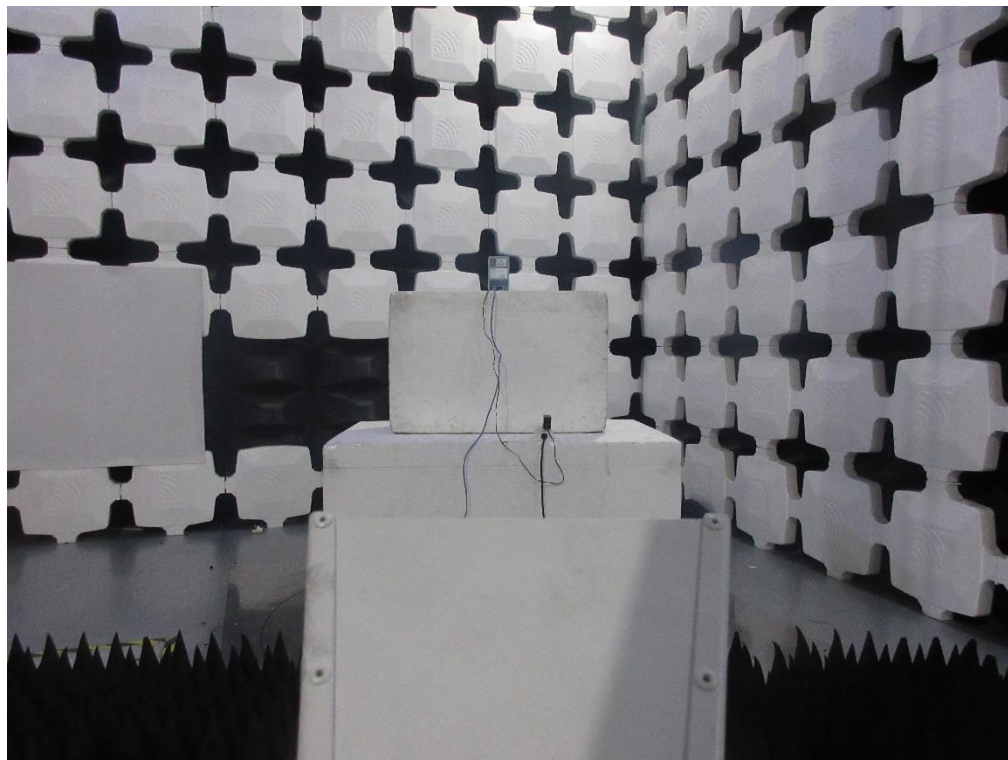

APPENDIX A - AC POWER LINE CONDUCTED EMISSIONS

Test Mode: TX ac(VHT40) Mode Channel 146

Line

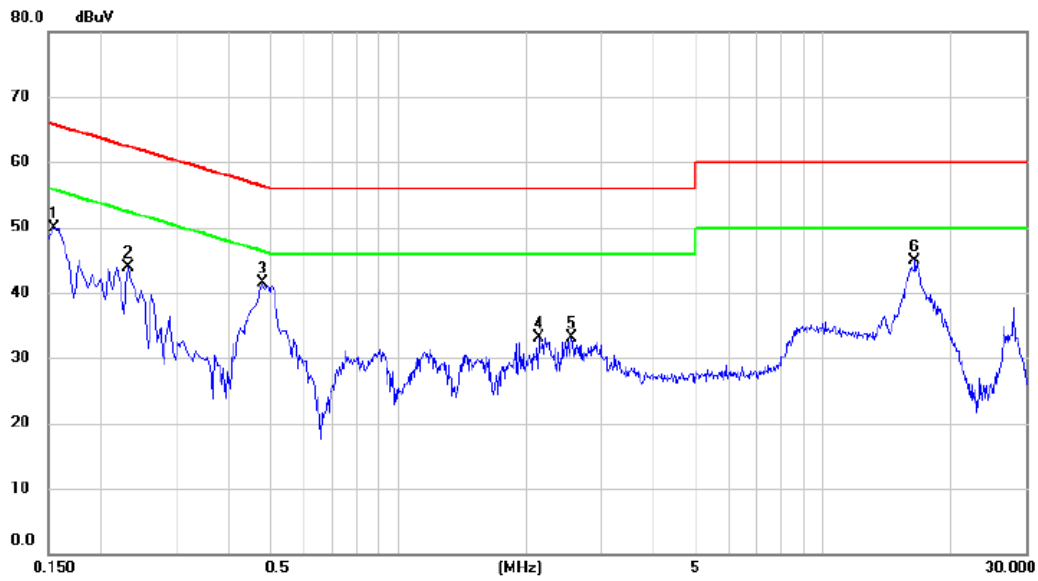

No.	Mk.	Freq. MHz	Reading Level dBuV	Correct Factor dB	Measure- ment dBuV	Limit dBuV	Margin dB	Detector	Comment
1		0.1545	40.16	9.73	49.89	65.75	-15.86	peak	
2		0.2310	34.16	9.79	43.95	62.41	-18.46	peak	
3	*	0.4785	31.66	9.89	41.55	56.37	-14.82	peak	
4		2.1435	23.37	9.80	33.17	56.00	-22.83	peak	
5		2.5620	23.18	9.83	33.01	56.00	-22.99	peak	
6		16.4310	34.70	10.30	45.00	60.00	-15.00	peak	

REMARKS:

- (1) Measurement Value = Reading Level + Correct Factor.
- (2) Margin Level = Measurement Value - Limit Value.

Test Mode: TX AC(VHT40) Mode Channel 146

Neutral

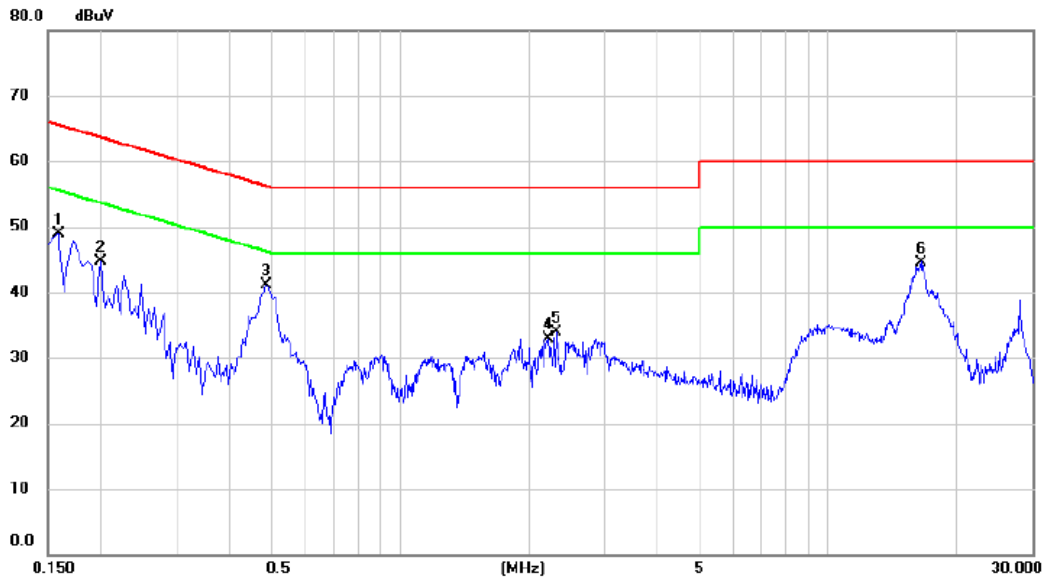

No.	Mk.	Freq. MHz	Reading Level dBuV	Correct Factor dB	Measure- ment dBuV	Limit dBuV	Margin dB	Detector	Comment
1		0.1590	39.26	9.61	48.87	65.52	-16.65	peak	
2		0.1995	35.02	9.63	44.65	63.63	-18.98	peak	
3	*	0.4875	31.32	9.69	41.01	56.21	-15.20	peak	
4		2.2244	23.10	9.81	32.91	56.00	-23.09	peak	
5		2.3145	24.14	9.81	33.95	56.00	-22.05	peak	
6		16.4805	34.36	10.24	44.60	60.00	-15.40	peak	

REMARKS:

(1) Measurement Value = Reading Level + Correct Factor.

(2) Margin Level = Measurement Value - Limit Value.

APPENDIX B - RADIATED EMISSION - 9 KHZ TO 30 MHZ

Note: Below 30MHz, The measured value have enough margin over 20dB than the limit, therefore they are not reported

APPENDIX C - RADIATED EMISSION - 30 MHZ TO 1 GHZ

Test Mode: TX AC40 MODE CHANNEL 146

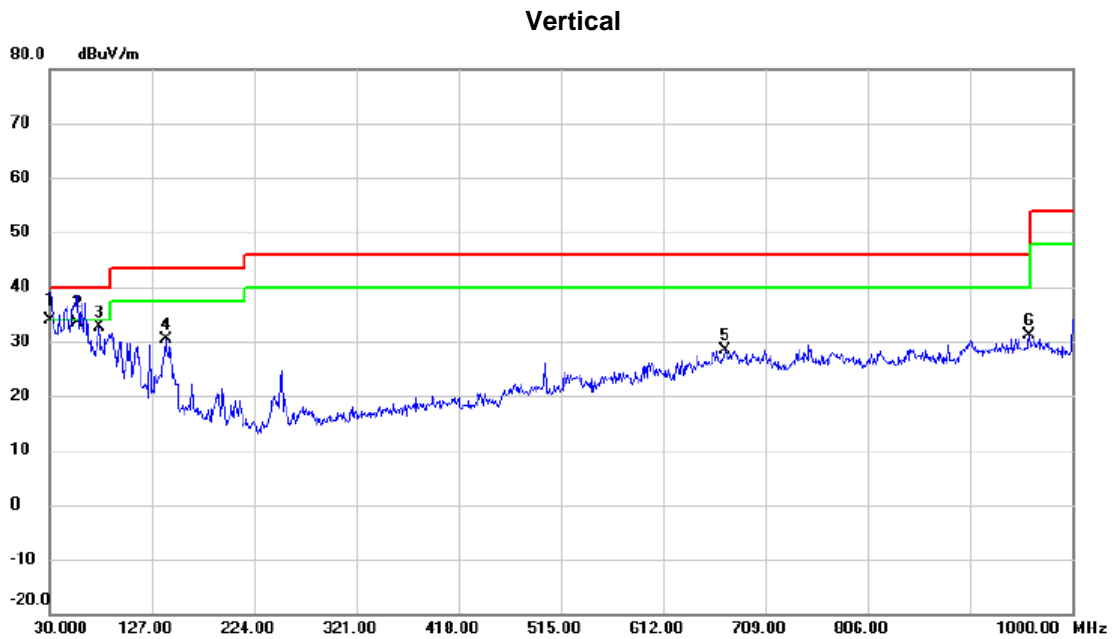

No.	Mk.	Freq. MHz	Reading Level dBuV	Correct Factor dB	Measure- ment dBuV/m	Limit dBuV/m	Margin dB	Detector	Comment
1	*	30.0000	52.12	-18.21	33.91	40.00	-6.09	QP	
2		56.1900	49.89	-16.63	33.26	40.00	-6.74	QP	
3		77.0450	52.35	-19.79	32.56	40.00	-7.44	peak	
4		140.0950	46.57	-16.31	30.26	43.50	-13.24	peak	
5		670.6850	35.50	-7.16	28.34	46.00	-17.66	peak	
6		959.7450	34.49	-3.45	31.04	46.00	-14.96	peak	

REMARKS:

- (1) Measurement Value = Reading Level + Correct Factor.
- (2) Margin Level = Measurement Value - Limit Value.

Test Mode: TX AC40 MODE CHANNEL 146

Horizontal

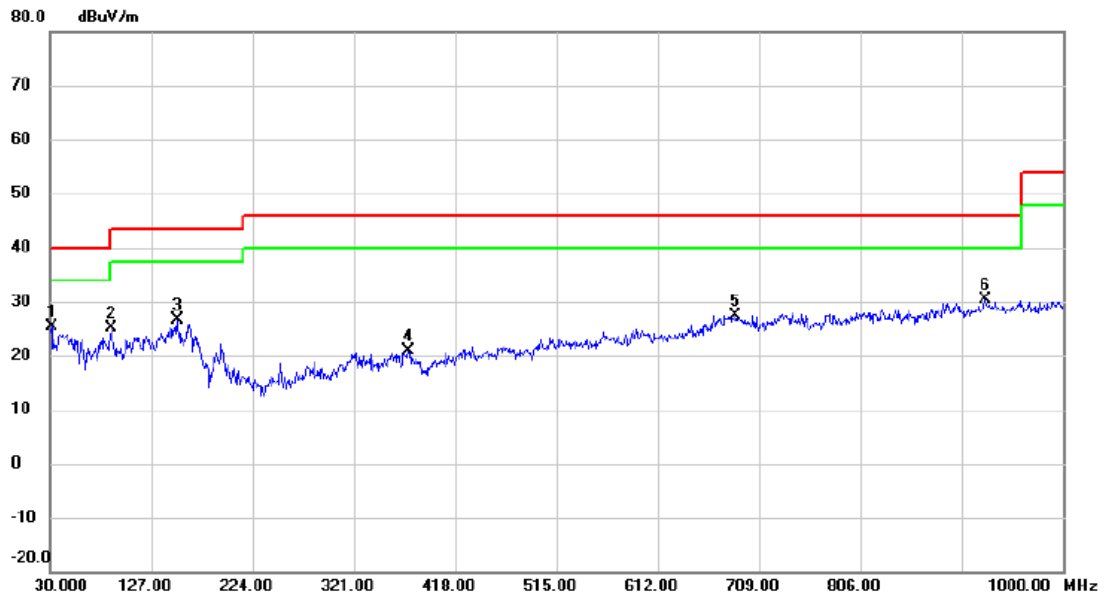

No.	Mk.	Freq. MHz	Reading Level dBuV	Correct Factor dB	Measure- ment dBuV/m	Limit dBuV/m	Margin dB	Detector	Comment
1	*	31.4550	43.43	-18.11	25.32	40.00	-14.68	peak	
2		88.6850	46.98	-21.76	25.22	43.50	-18.28	peak	
3		151.7350	42.45	-15.72	26.73	43.50	-16.77	peak	
4		373.8650	33.99	-13.14	20.85	46.00	-25.15	peak	
5		686.2050	34.42	-6.97	27.45	46.00	-18.55	peak	
6		925.3100	34.20	-3.93	30.27	46.00	-15.73	peak	

REMARKS:

- (1) Measurement Value = Reading Level + Correct Factor.
- (2) Margin Level = Measurement Value - Limit Value.

APPENDIX D - RADIATED EMISSION - ABOVE 1000 MHZ

ANT1+ANT2

Orthogonal Axis	X
Test Mode	UNII-1_TX A Mode 5180 MHz

Vertical

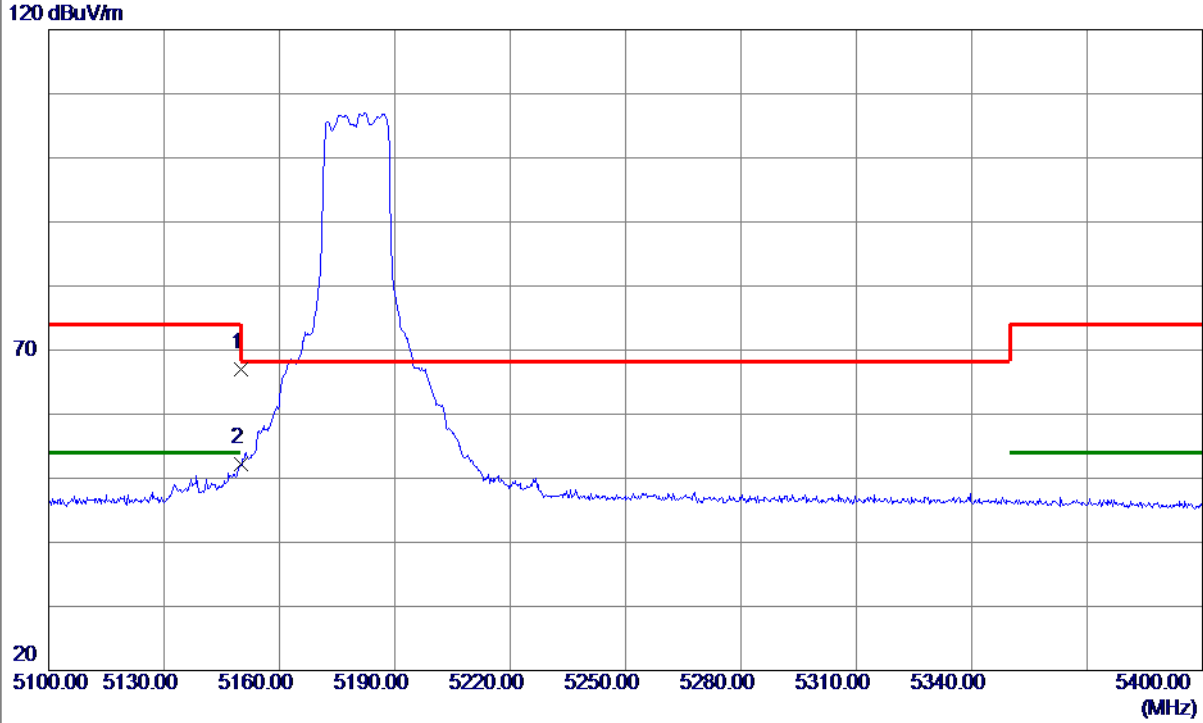

No.	Freq. MHz	Reading Level dBuV/m	Correct Factor dB	Measure ment dBuV/m	Limit dBuV/m	Margin dB	Detector	Comment
1	5150.0000	26.57	40.53	67.10	74.00	-6.90	Peak	
2 *	5150.0000	11.77	40.53	52.30	54.00	-1.70	AVG	

REMARKS:

- (1) Measurement Value = Reading Level + Correct Factor.
- (2) Margin Level = Measurement Value - Limit Value.

Orthogonal Axis	X
Test Mode	UNII-1_TX A Mode 5180 MHz

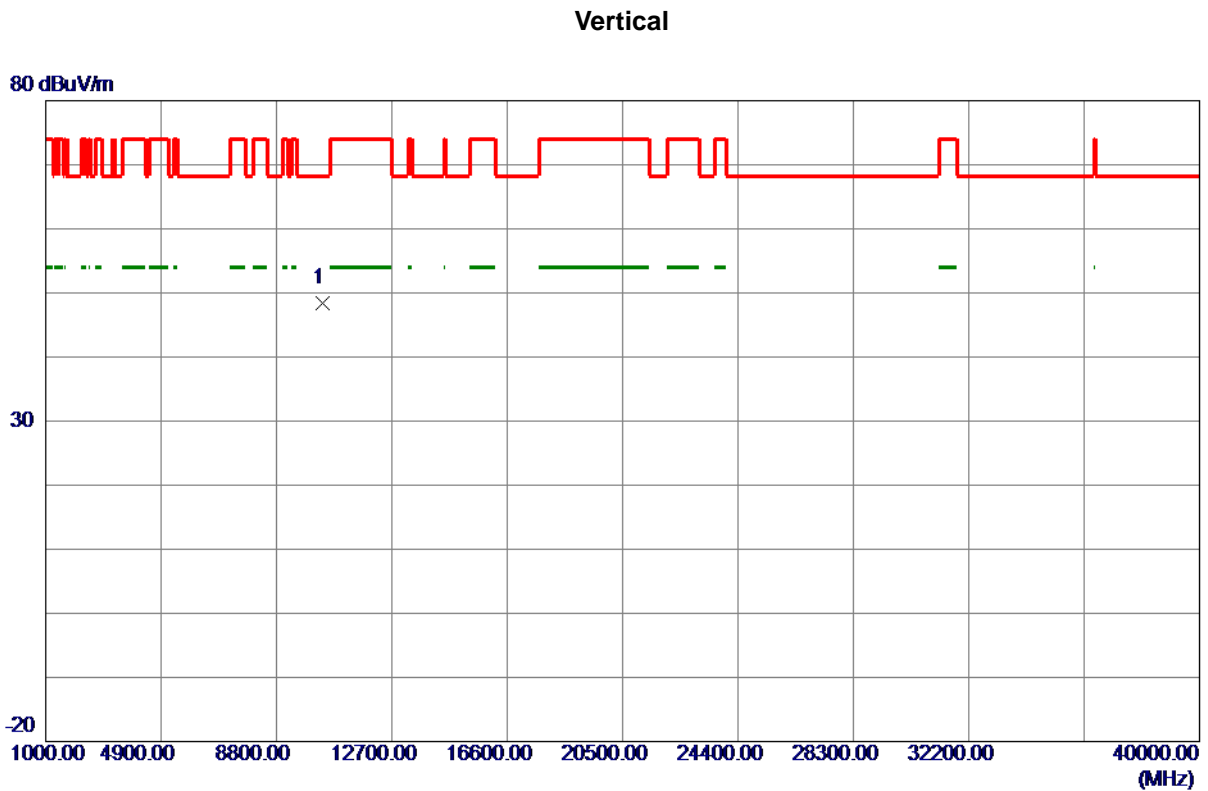

No.	Freq. MHz	Reading Level dBuV/m	Correct Factor dB	Measure ment dBuV/m	Limit dBuV/m	Margin dB	Detector	Comment
1 *	10360.0000	47.71	0.67	48.38	68.30	-19.92	Peak	

REMARKS:

- (1) Measurement Value = Reading Level + Correct Factor.
- (2) Margin Level = Measurement Value - Limit Value.

Orthogonal Axis	X
Test Mode	UNII-1_TX A Mode 5180 MHz

Horizontal

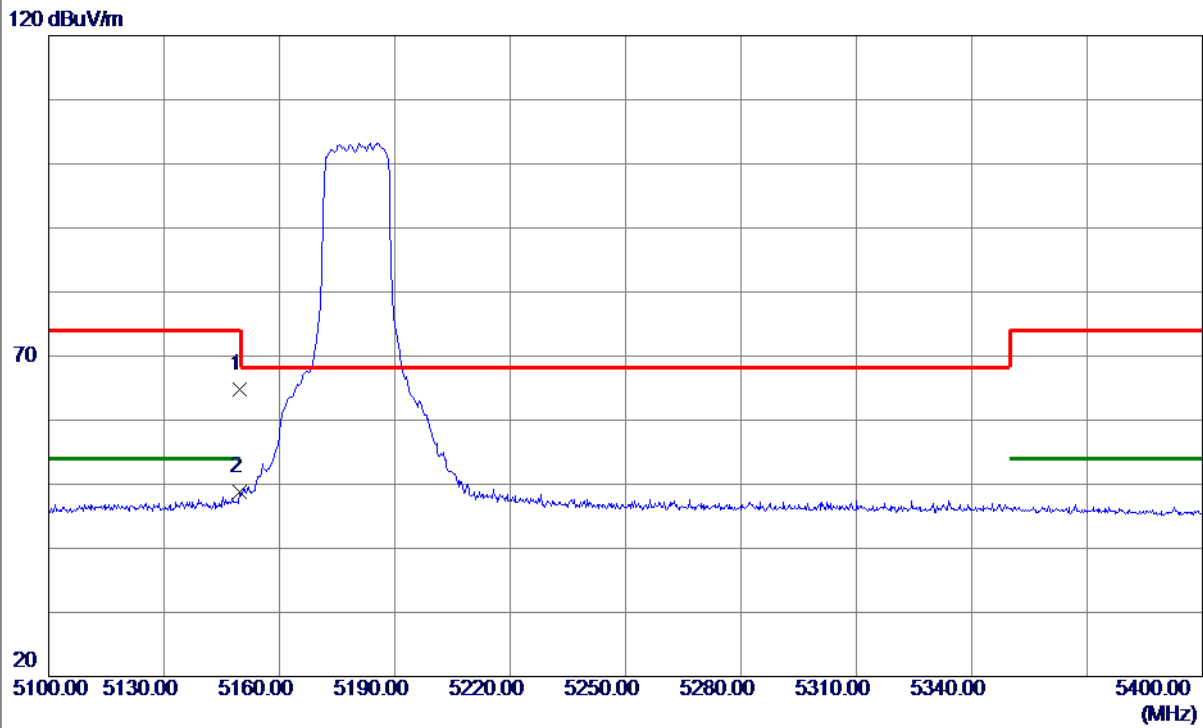

No.	Freq. MHz	Reading Level dBuV/m	Correct Factor dB	Measure ment dBuV/m	Limit dBuV/m	Margin dB	Detector	Comment
1	5149.6500	24.31	40.53	64.84	74.00	-9.16	Peak	
2 *	5149.6500	8.34	40.53	48.87	54.00	-5.13	AVG	

REMARKS:

- (1) Measurement Value = Reading Level + Correct Factor.
- (2) Margin Level = Measurement Value - Limit Value.

Orthogonal Axis	X
Test Mode	UNII-1_TX A Mode 5180 MHz

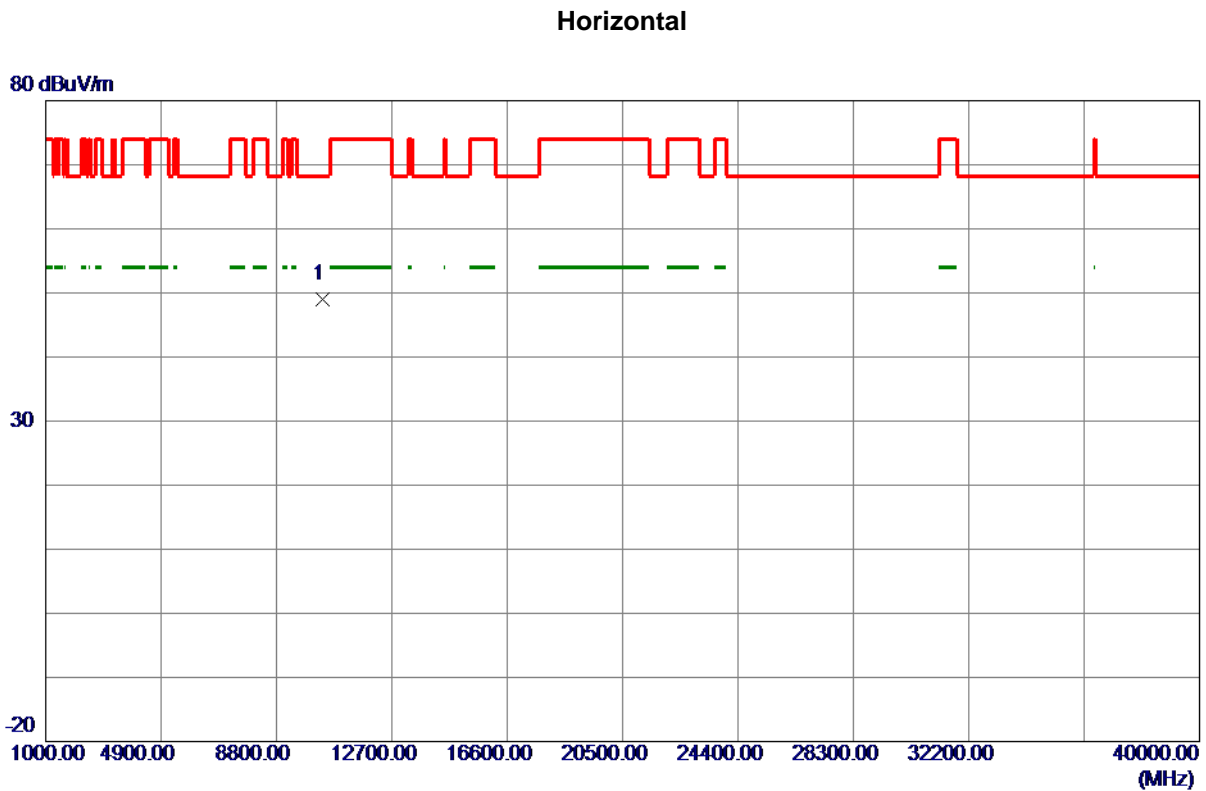

No.	Freq. MHz	Reading Level dBuV/m	Correct Factor dB	Measure ment dBuV/m	Limit dBuV/m	Margin dB	Detector	Comment
1 *	10360.0000	48.39	0.67	49.06	68.30	-19.24	Peak	

REMARKS:

- (1) Measurement Value = Reading Level + Correct Factor.
- (2) Margin Level = Measurement Value - Limit Value.

Orthogonal Axis	X
Test Mode	UNII-1_TX A Mode 5200 MHz

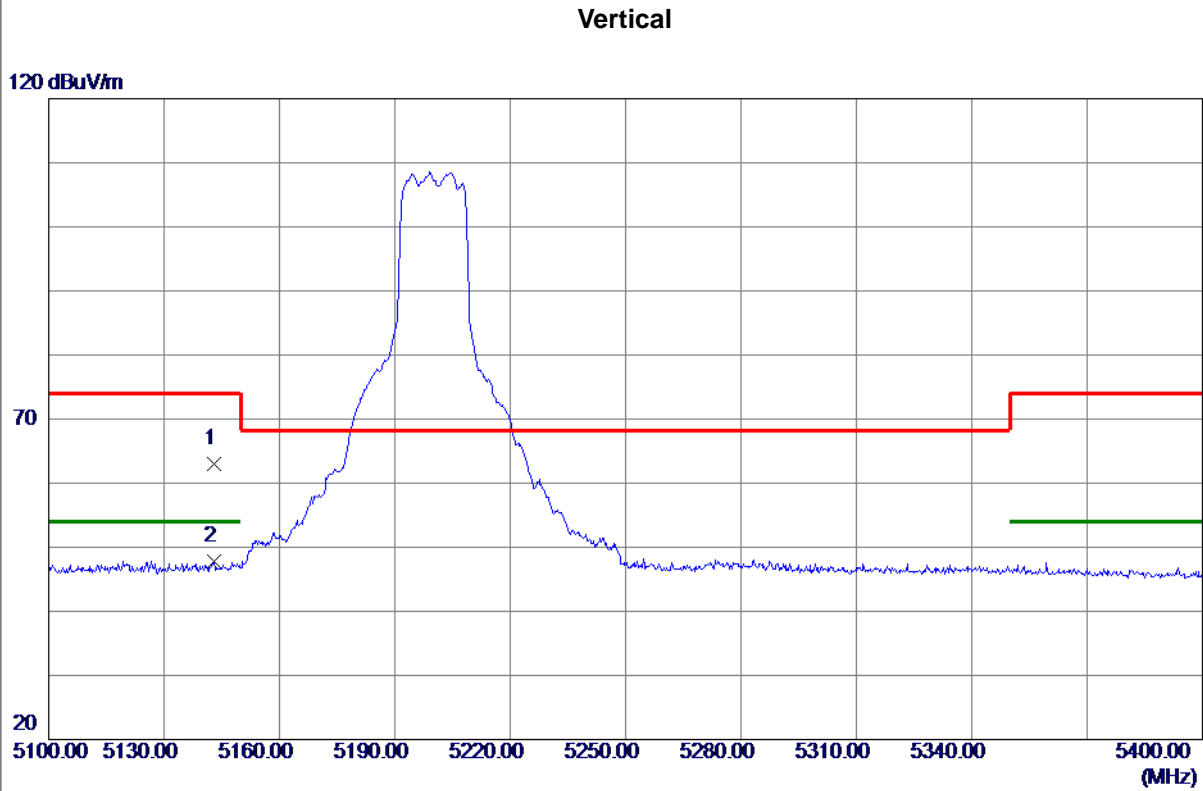

No.	Freq. MHz	Reading Level dBuV/m	Correct Factor dB	Measure ment dBuV/m	Limit dBuV/m	Margin dB	Detector	Comment
1	5143.0500	22.53	40.51	63.04	74.00	-10.96	Peak	
2 *	5143.0500	7.28	40.51	47.79	54.00	-6.21	AVG	

REMARKS:

- (1) Measurement Value = Reading Level + Correct Factor.
- (2) Margin Level = Measurement Value - Limit Value.

Orthogonal Axis	X
Test Mode	UNII-1_TX A Mode 5200 MHz

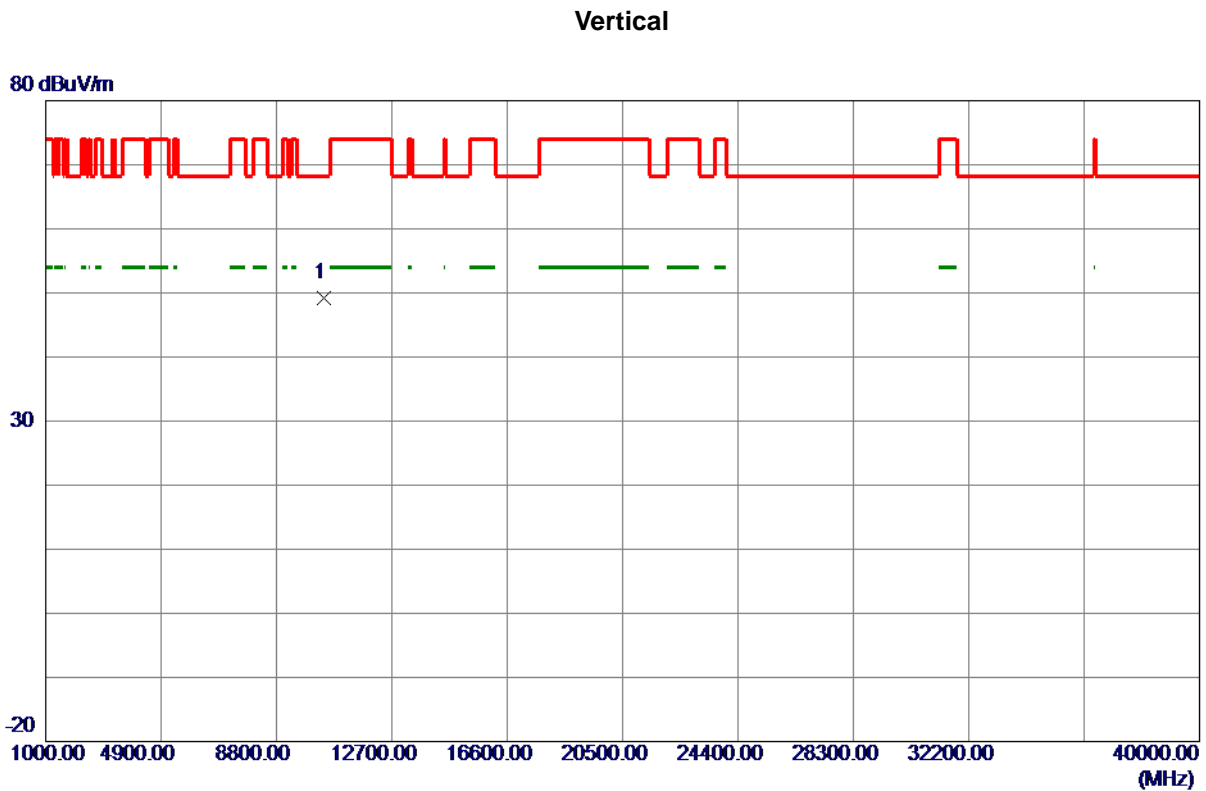

No.	Freq. MHz	Reading Level dBuV/m	Correct Factor dB	Measure ment dBuV/m	Limit dBuV/m	Margin dB	Detector	Comment
1 *	10400.0000	48.44	0.80	49.24	68.30	-19.06	Peak	

REMARKS:

- (1) Measurement Value = Reading Level + Correct Factor.
- (2) Margin Level = Measurement Value - Limit Value.

Orthogonal Axis	X
Test Mode	UNII-1_TX A Mode 5200 MHz

Horizontal

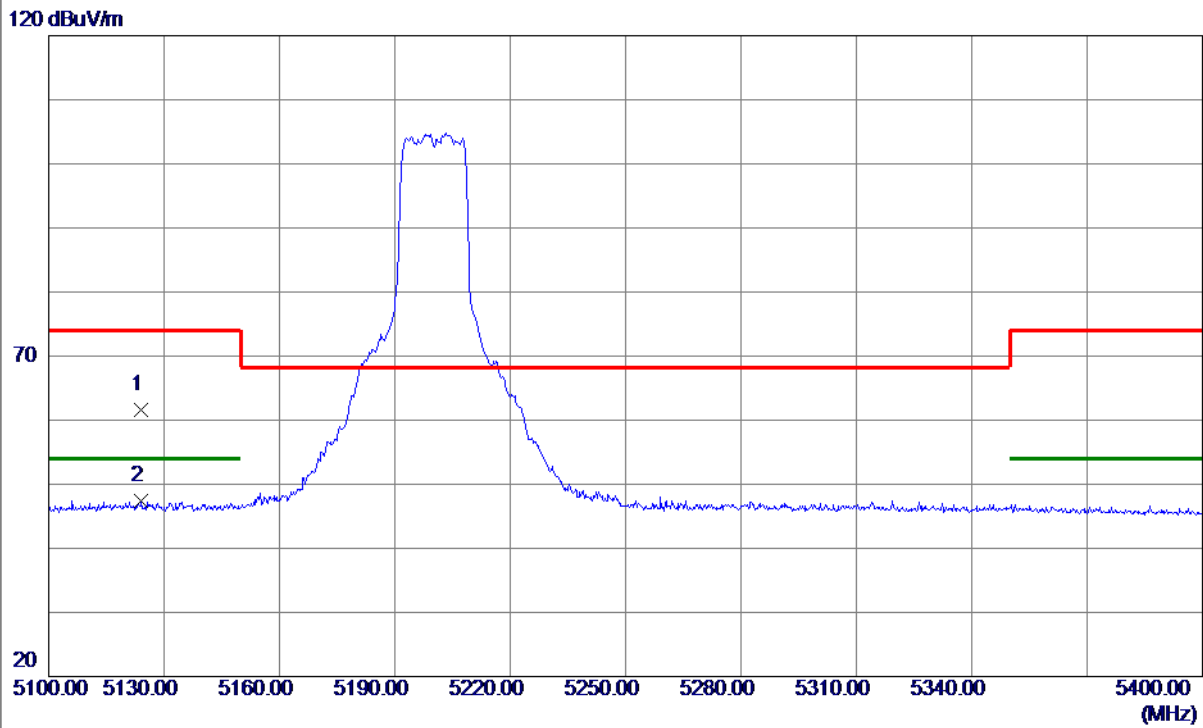

No.	Freq. MHz	Reading Level dBuV/m	Correct Factor dB	Measure ment dBuV/m	Limit dBuV/m	Margin dB	Detector	Comment
1	5124.0000	21.04	40.48	61.52	74.00	-12.48	Peak	
2 *	5124.0000	6.89	40.48	47.37	54.00	-6.63	AVG	

REMARKS:

- (1) Measurement Value = Reading Level + Correct Factor.
- (2) Margin Level = Measurement Value - Limit Value.

Orthogonal Axis	X
Test Mode	UNII-1_TX A Mode 5200 MHz

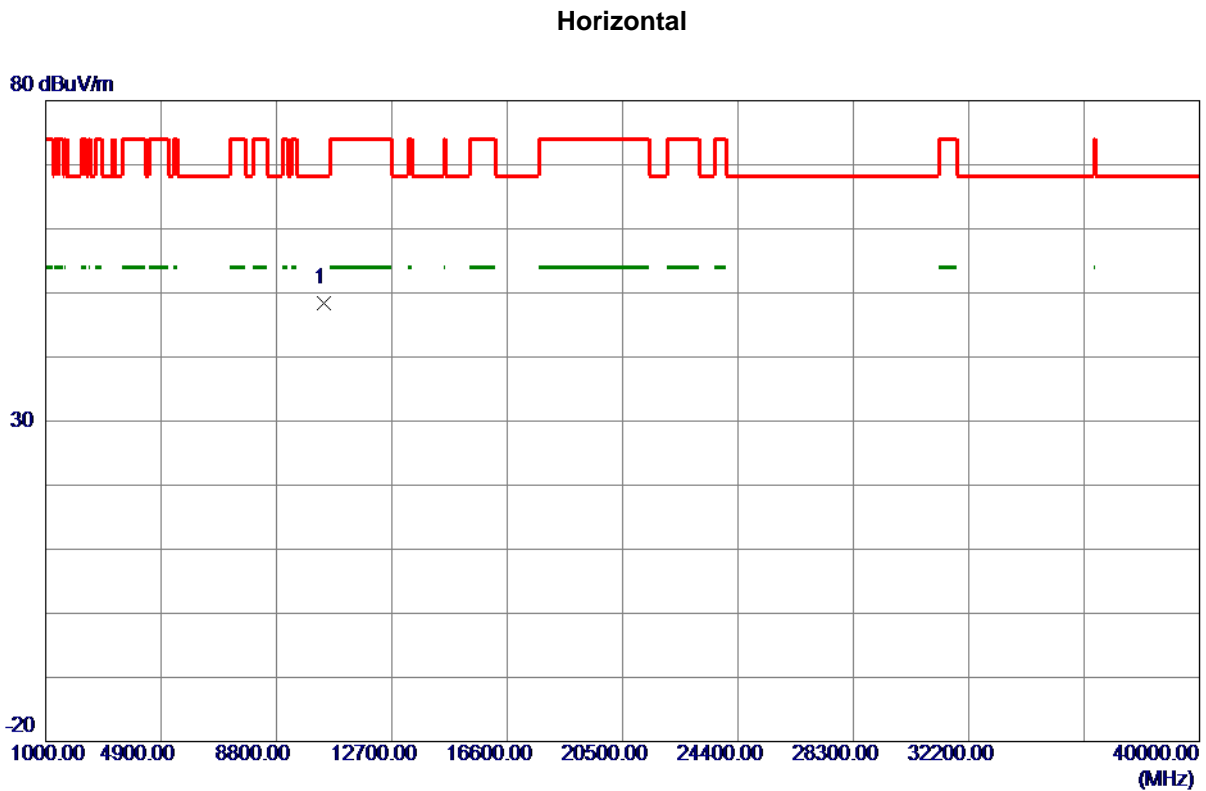

No.	Freq. MHz	Reading Level dBuV/m	Correct Factor dB	Measure ment dBuV/m	Limit dBuV/m	Margin dB	Detector	Comment
1 *	10400.0000	47.56	0.80	48.36	68.30	-19.94	Peak	

REMARKS:

- (1) Measurement Value = Reading Level + Correct Factor.
- (2) Margin Level = Measurement Value - Limit Value.

Orthogonal Axis	X
Test Mode	UNII-1_TX A Mode 5240 MHz

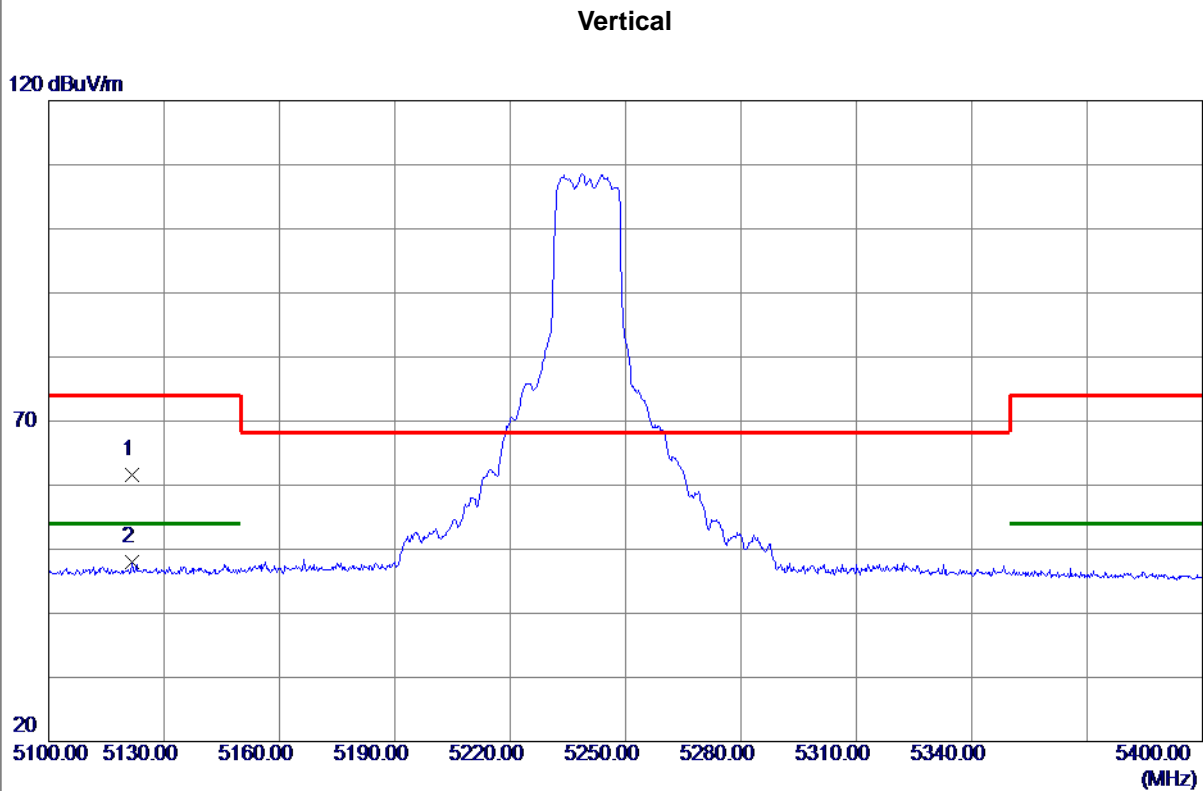

No.	Freq. MHz	Reading Level dBuV/m	Correct Factor dB	Measure ment dBuV/m	Limit dBuV/m	Margin dB	Detector	Comment
1	5121.7500	21.13	40.47	61.60	74.00	-12.40	Peak	
2 *	5121.7500	7.62	40.47	48.09	54.00	-5.91	AVG	

REMARKS:

- (1) Measurement Value = Reading Level + Correct Factor.
- (2) Margin Level = Measurement Value - Limit Value.

Orthogonal Axis	X
Test Mode	UNII-1_TX A Mode 5240 MHz

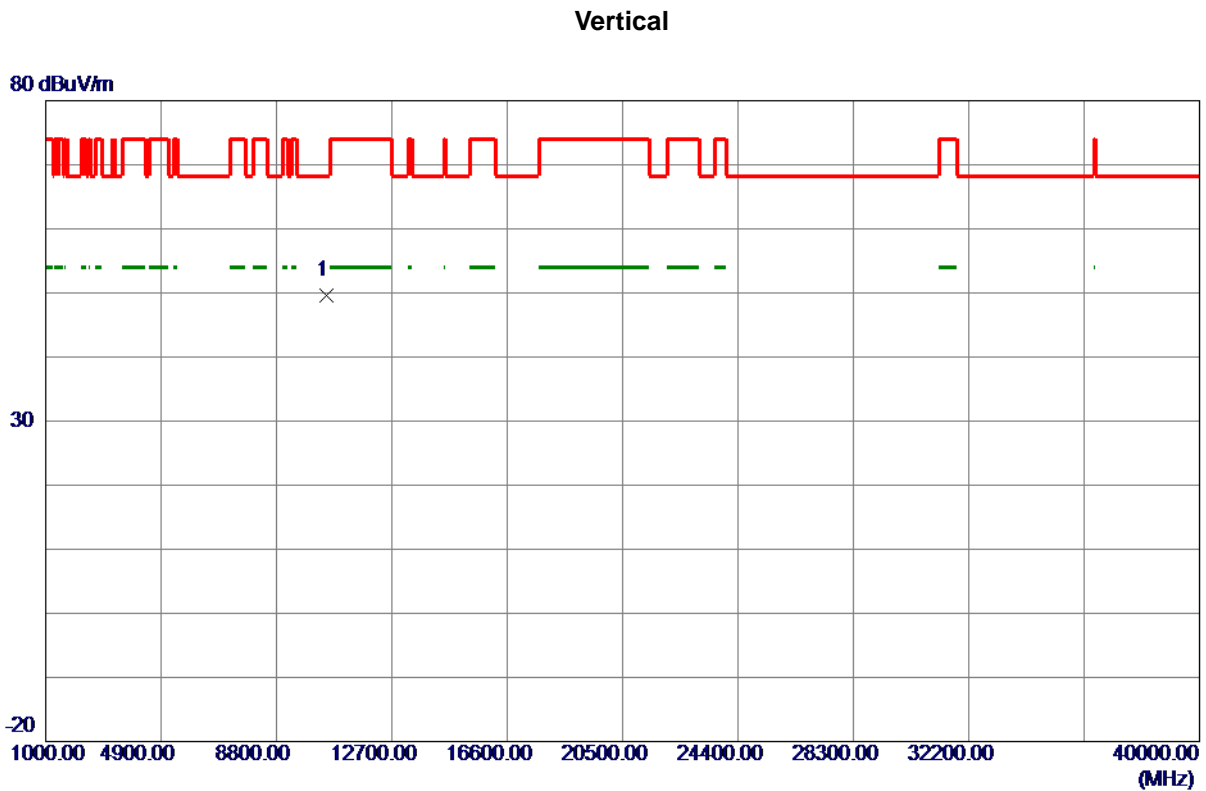

No.	Freq. MHz	Reading Level dBuV/m	Correct Factor dB	Measure ment dBuV/m	Limit dBuV/m	Margin dB	Detector	Comment
1 *	10480.0000	48.57	1.05	49.62	68.30	-18.68	Peak	

REMARKS:

- (1) Measurement Value = Reading Level + Correct Factor.
- (2) Margin Level = Measurement Value - Limit Value.

Orthogonal Axis	X
Test Mode	UNII-1_TX A Mode 5240 MHz

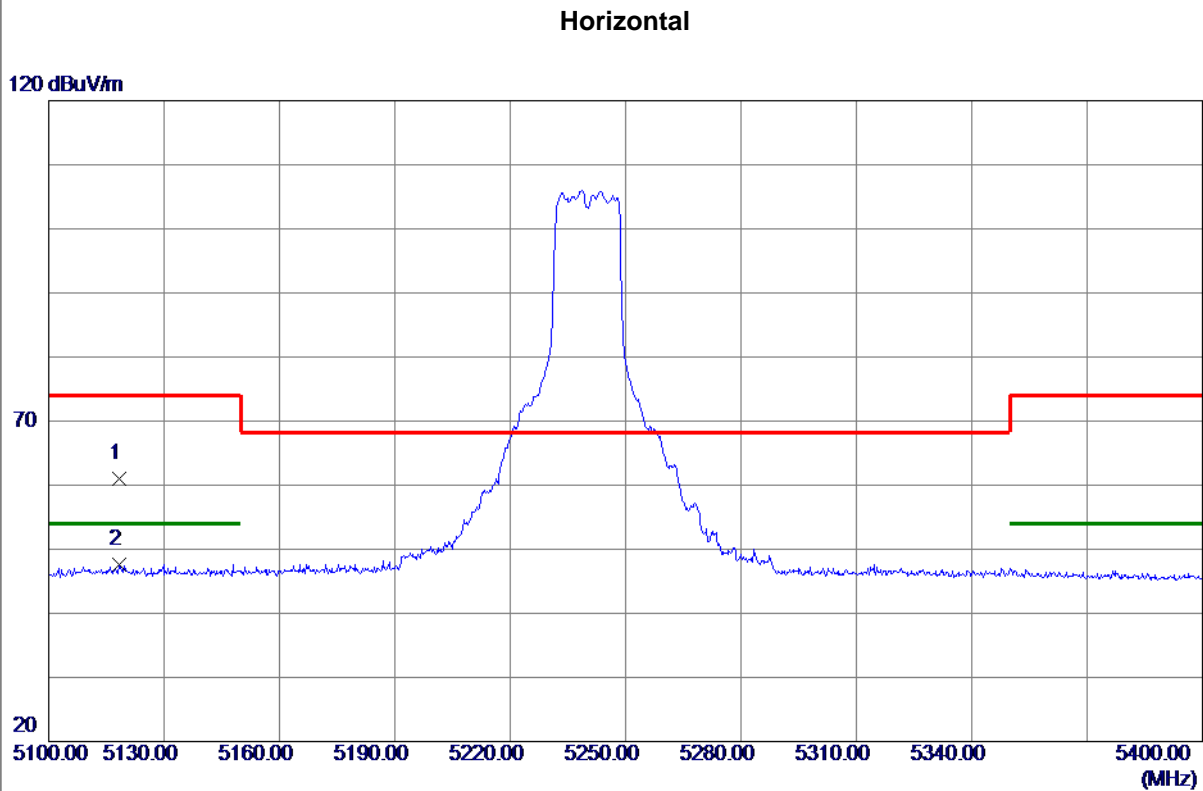

No.	Freq. MHz	Reading Level dBuV/m	Correct Factor dB	Measure ment dBuV/m	Limit dBuV/m	Margin dB	Detector	Comment
1	5118.4500	20.58	40.46	61.04	74.00	-12.96	Peak	
2 *	5118.4500	7.12	40.46	47.58	54.00	-6.42	AVG	

REMARKS:

- (1) Measurement Value = Reading Level + Correct Factor.
- (2) Margin Level = Measurement Value - Limit Value.

Orthogonal Axis	X
Test Mode	UNII-1_TX A Mode 5240 MHz

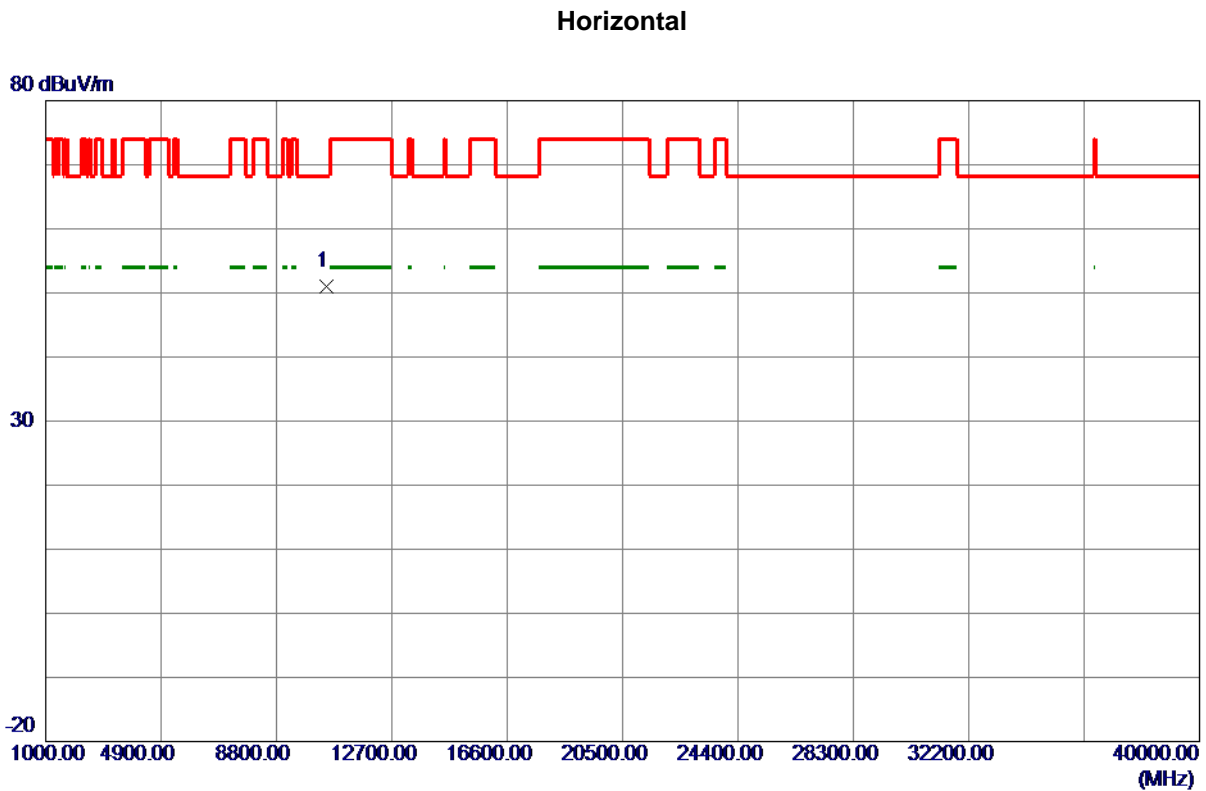

No.	Freq. MHz	Reading Level dBuV/m	Correct Factor dB	Measure ment dBuV/m	Limit dBuV/m	Margin dB	Detector	Comment
1 *	10480.0000	50.03	1.05	51.08	68.30	-17.22	Peak	

REMARKS:

- (1) Measurement Value = Reading Level + Correct Factor.
- (2) Margin Level = Measurement Value - Limit Value.

Orthogonal Axis	X
Test Mode	UNII-2A_TX A Mode 5260 MHz

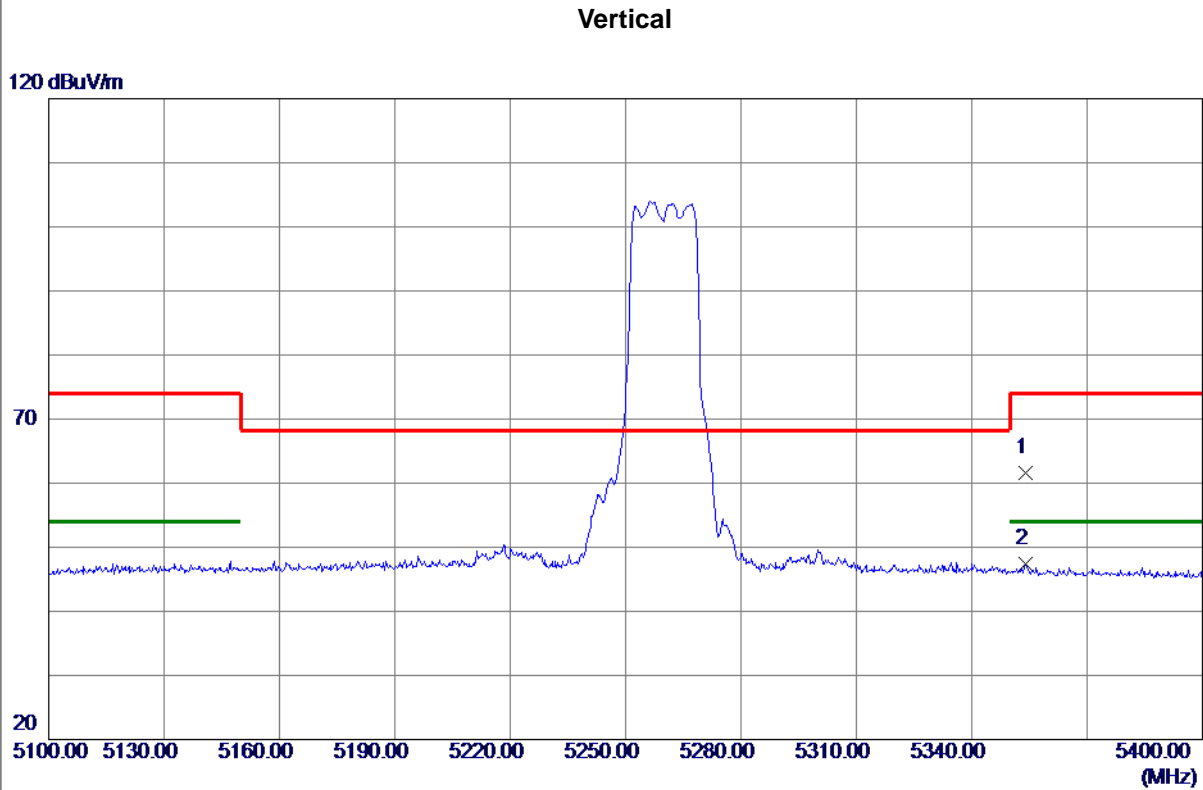

No.	Freq. MHz	Reading Level dBuV/m	Correct Factor dB	Measure ment dBuV/m	Limit dBuV/m	Margin dB	Detector	Comment
1	5353.9500	20.59	40.95	61.54	74.00	-12.46	Peak	
2 *	5353.9500	6.53	40.95	47.48	54.00	-6.52	AVG	

REMARKS:

- (1) Measurement Value = Reading Level + Correct Factor.
- (2) Margin Level = Measurement Value - Limit Value.

Orthogonal Axis	X
Test Mode	UNII-2A_TX A Mode 5260 MHz

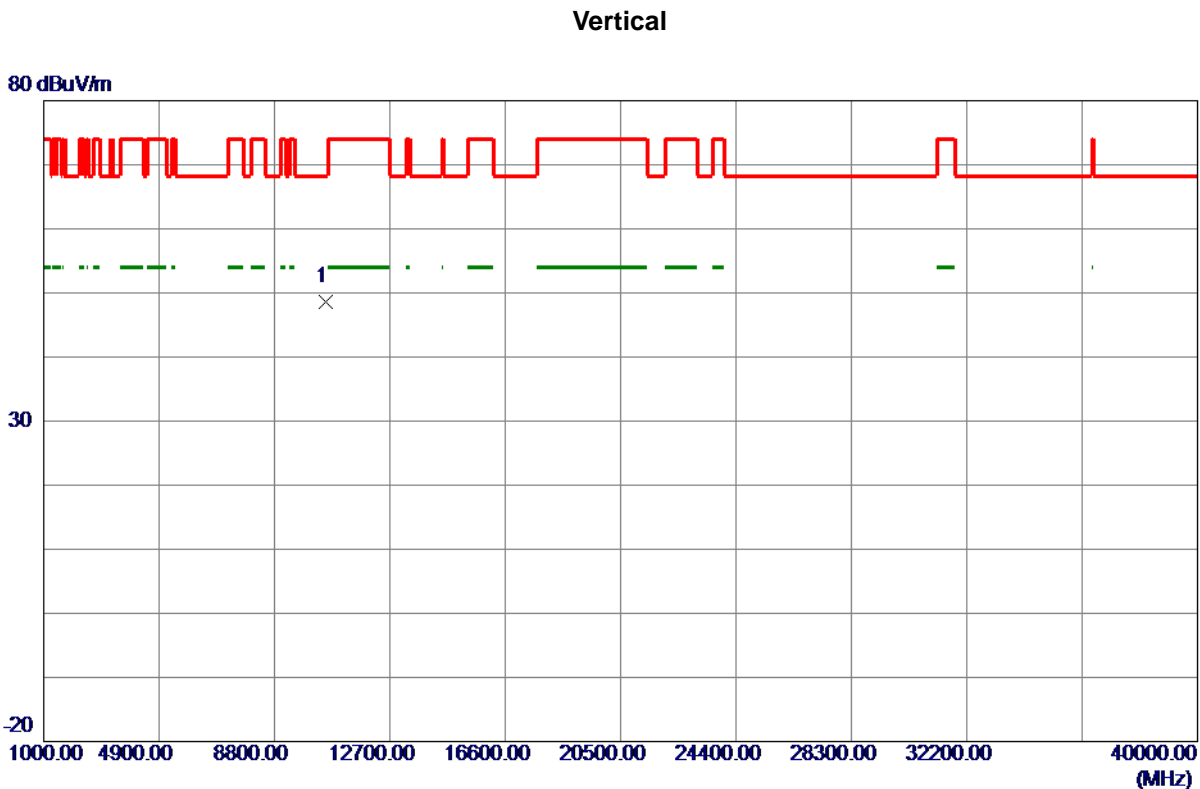

No.	Freq. MHz	Reading Level dBuV/m	Correct Factor dB	Measure ment dBuV/m	Limit dBuV/m	Margin dB	Detector	Comment
1 *	10520.0000	47.40	1.15	48.55	68.30	-19.75	Peak	

REMARKS:

- (1) Measurement Value = Reading Level + Correct Factor.
- (2) Margin Level = Measurement Value - Limit Value.

Orthogonal Axis	X
Test Mode	UNII-2A_TX A Mode 5260 MHz

Horizontal

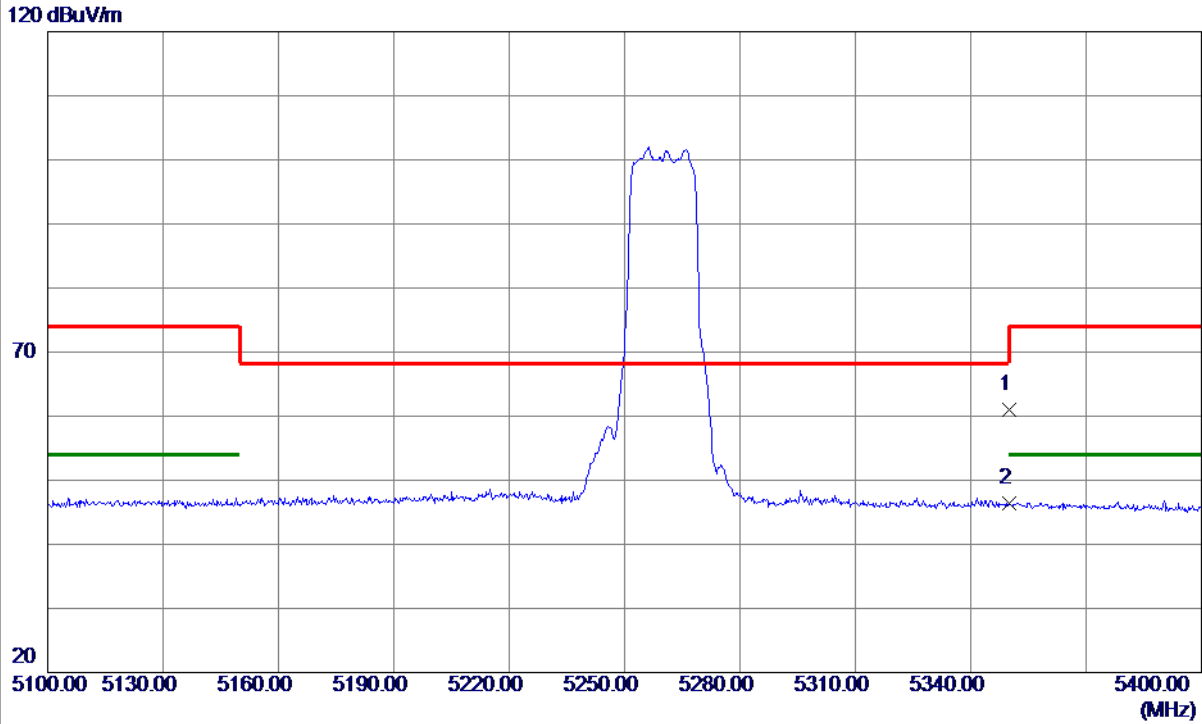

No.	Freq. MHz	Reading Level dBuV/m	Correct Factor dB	Measure ment dBuV/m	Limit dBuV/m	Margin dB	Detector	Comment
1	5350.0000	20.11	40.94	61.05	74.00	-12.95	Peak	
2 *	5350.0000	5.41	40.94	46.35	54.00	-7.65	AVG	

REMARKS:

- (1) Measurement Value = Reading Level + Correct Factor.
- (2) Margin Level = Measurement Value - Limit Value.

Orthogonal Axis	X
Test Mode	UNII-2A_TX A Mode 5260 MHz

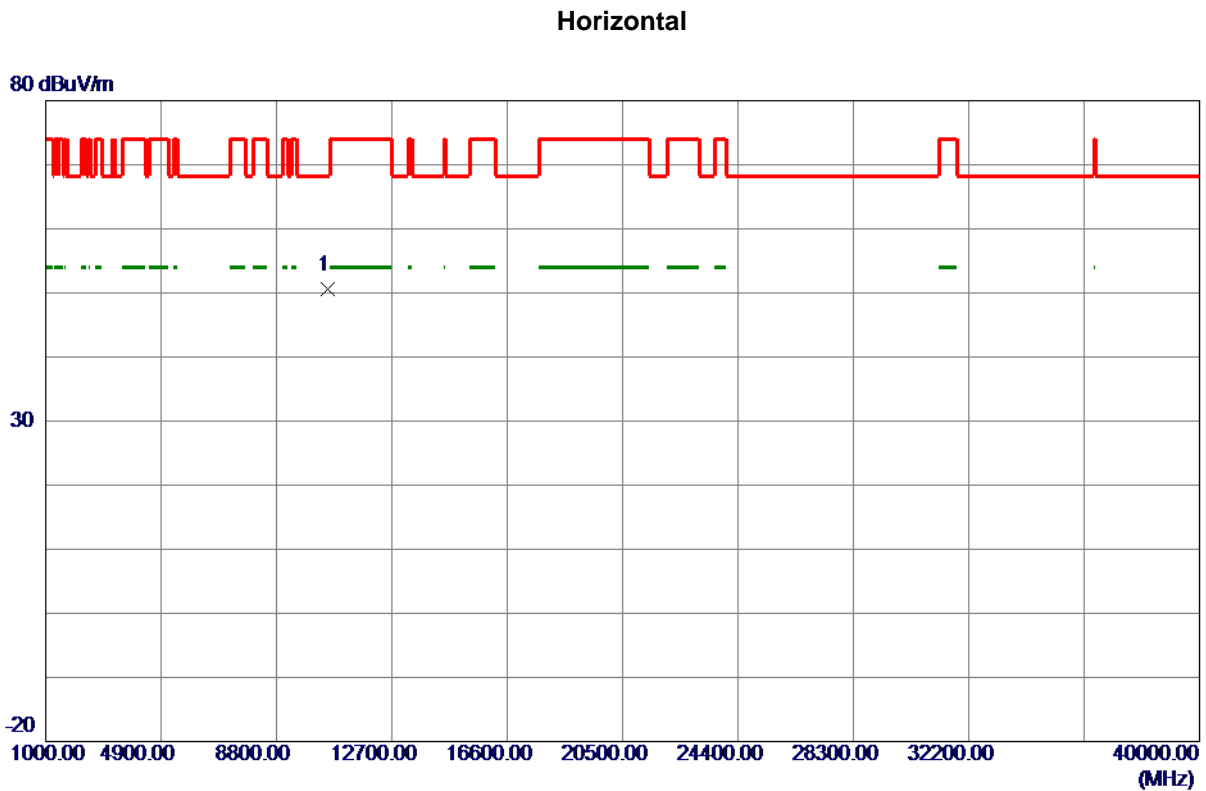

No.	Freq. MHz	Reading Level dBuV/m	Correct Factor dB	Measure ment dBuV/m	Limit dBuV/m	Margin dB	Detector	Comment
1 *	10520.0000	49.35	1.15	50.50	68.30	-17.80	Peak	

REMARKS:

- (1) Measurement Value = Reading Level + Correct Factor.
- (2) Margin Level = Measurement Value - Limit Value.

Orthogonal Axis	X
Test Mode	UNII-2A_TX A Mode 5300 MHz

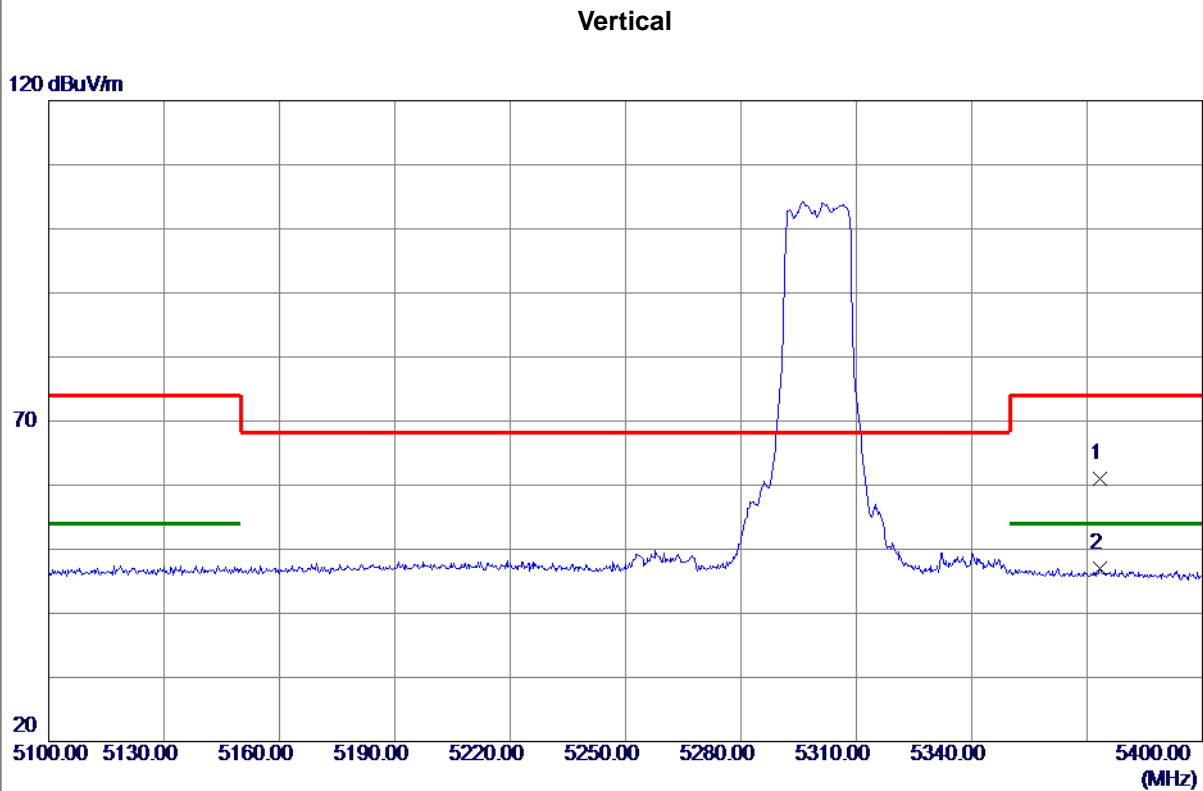

No.	Freq. MHz	Reading Level dBuV/m	Correct Factor dB	Measure ment dBuV/m	Limit dBuV/m	Margin dB	Detector	Comment
1	5373.3000	20.06	40.99	61.05	74.00	-12.95	Peak	
2 *	5373.3000	6.09	40.99	47.08	54.00	-6.92	AVG	

REMARKS:

- (1) Measurement Value = Reading Level + Correct Factor.
- (2) Margin Level = Measurement Value - Limit Value.

Orthogonal Axis	X
Test Mode	UNII-2A_TX A Mode 5300 MHz

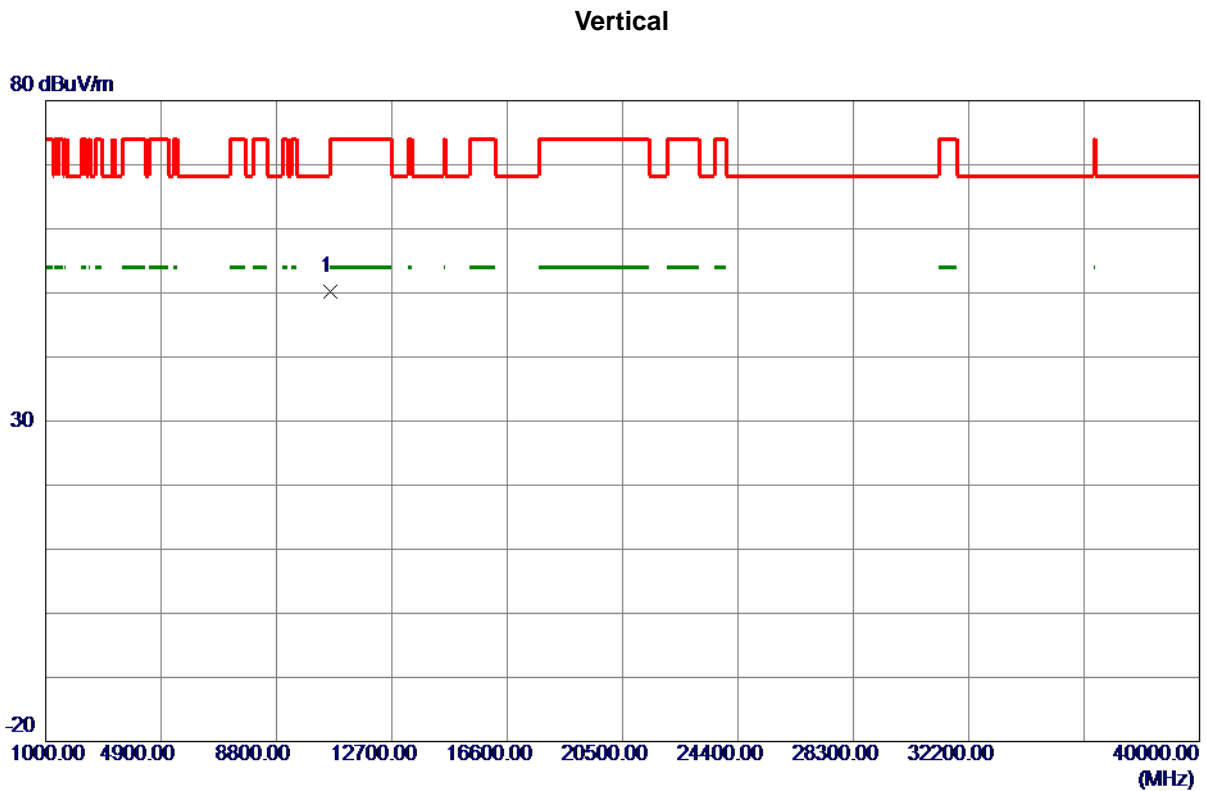

No.	Freq. MHz	Reading Level dBuV/m	Correct Factor dB	Measure ment dBuV/m	Limit dBuV/m	Margin dB	Detector	Comment
1 *	10600.0000	48.87	1.33	50.20	68.30	-18.10	Peak	

REMARKS:

- (1) Measurement Value = Reading Level + Correct Factor.
- (2) Margin Level = Measurement Value - Limit Value.

Orthogonal Axis	X
Test Mode	UNII-2A_TX A Mode 5300 MHz

Horizontal

120 dBuV/m

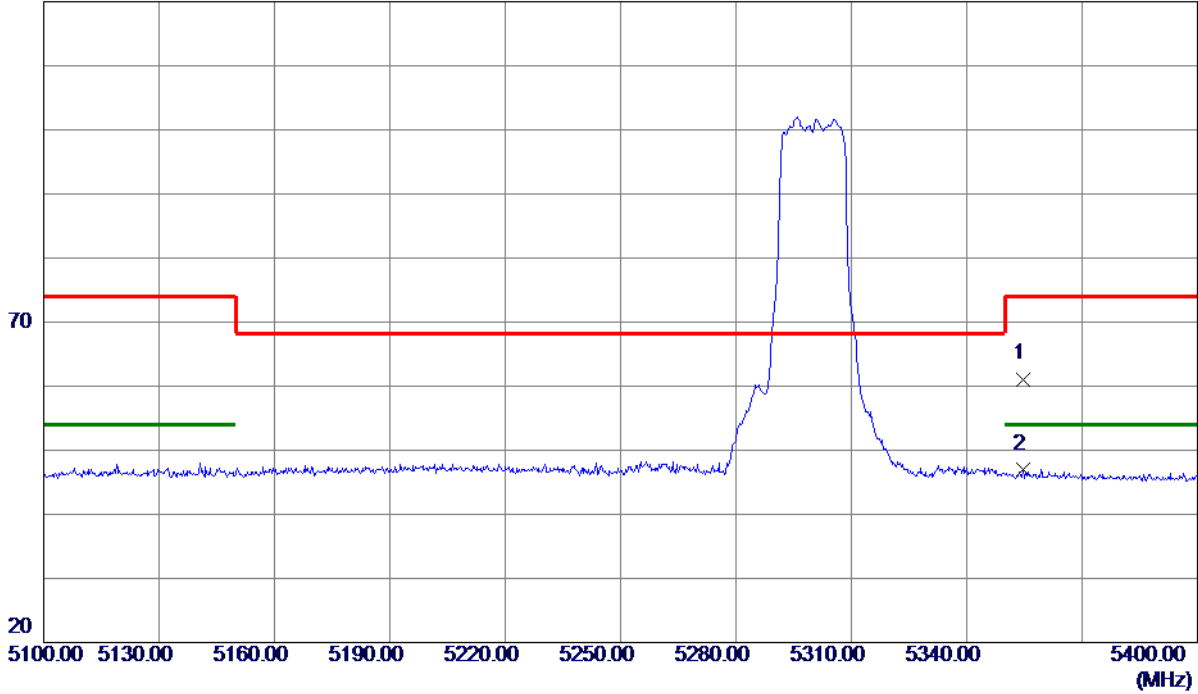

No.	Freq. MHz	Reading Level dBuV/m	Correct Factor dB	Measure ment dBuV/m	Limit dBuV/m	Margin dB	Detector	Comment
1	5354.5500	20.15	40.95	61.10	74.00	-12.90	Peak	
2 *	5354.5500	6.09	40.95	47.04	54.00	-6.96	AVG	

REMARKS:

- (1) Measurement Value = Reading Level + Correct Factor.
- (2) Margin Level = Measurement Value - Limit Value.

Orthogonal Axis	X
Test Mode	UNII-2A_TX A Mode 5300 MHz

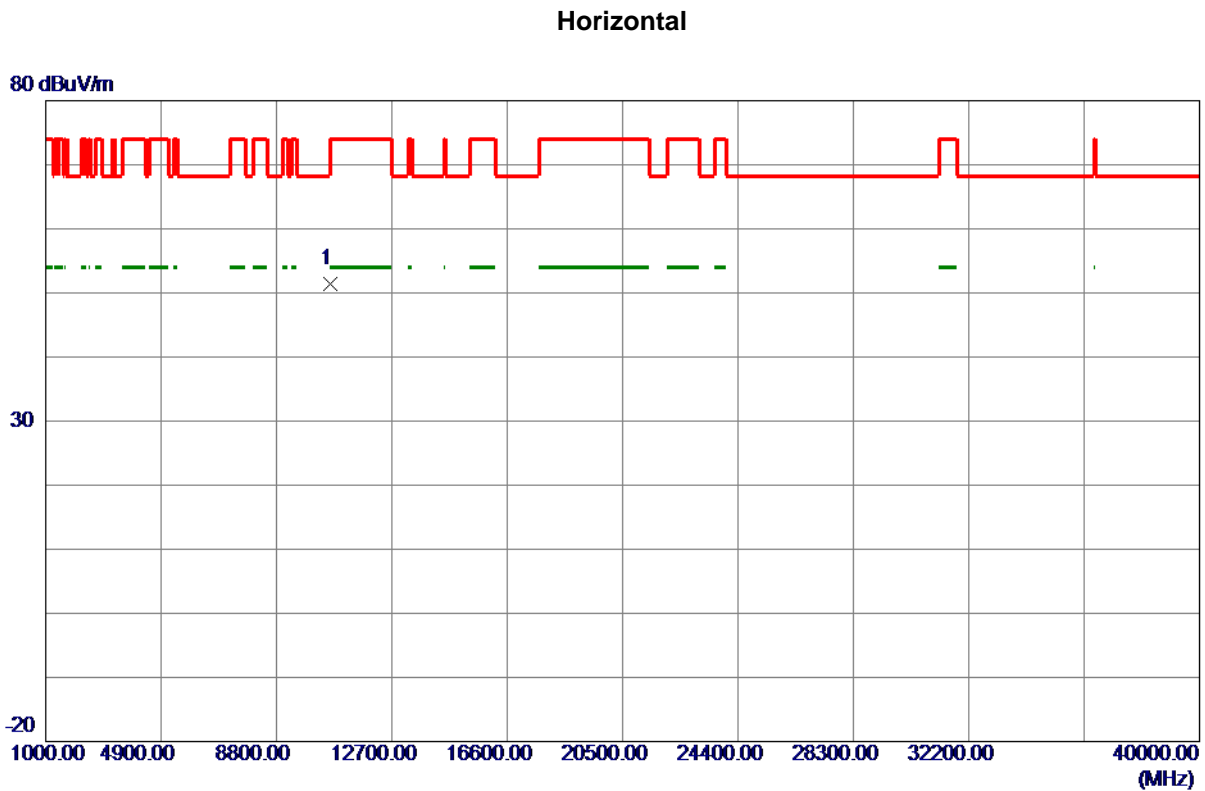

No.	Freq. MHz	Reading Level dBuV/m	Correct Factor dB	Measure ment dBuV/m	Limit dBuV/m	Margin dB	Detector	Comment
1 *	10600.0000	50.10	1.33	51.43	68.30	-16.87	Peak	

REMARKS:

- (1) Measurement Value = Reading Level + Correct Factor.
- (2) Margin Level = Measurement Value - Limit Value.

Orthogonal Axis	X
Test Mode	UNII-2A_TX A Mode 5320 MHz

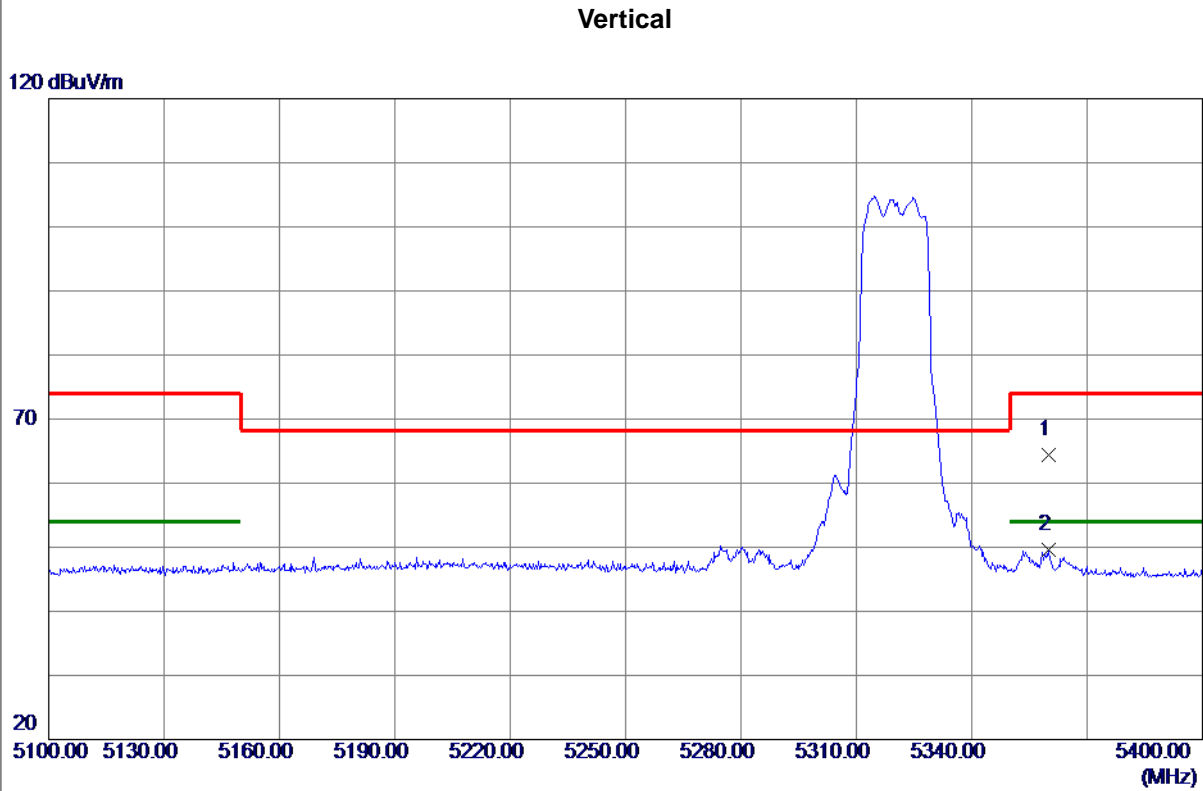

No.	Freq. MHz	Reading Level dBuV/m	Correct Factor dB	Measure ment dBuV/m	Limit dBuV/m	Margin dB	Detector	Comment
1	5359.9500	23.48	40.96	64.44	74.00	-9.56	Peak	
2 *	5359.9500	8.59	40.96	49.55	54.00	-4.45	AVG	

REMARKS:

- (1) Measurement Value = Reading Level + Correct Factor.
- (2) Margin Level = Measurement Value - Limit Value.

Orthogonal Axis	X
Test Mode	UNII-2A_TX A Mode 5320 MHz

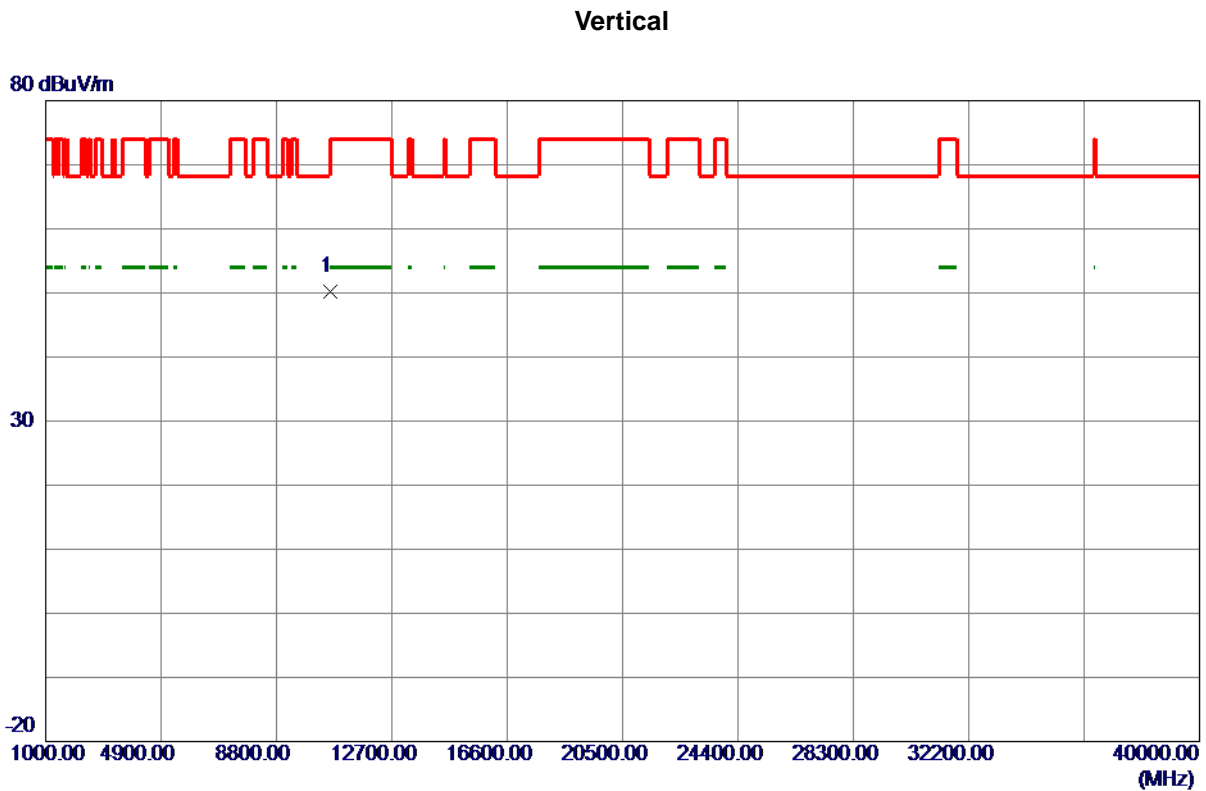

No.	Freq. MHz	Reading Level dBuV/m	Correct Factor dB	Measure ment dBuV/m	Limit dBuV/m	Margin dB	Detector	Comment
1 *	10640.0000	48.69	1.42	50.11	74.00	-23.89	Peak	

REMARKS:

- (1) Measurement Value = Reading Level + Correct Factor.
- (2) Margin Level = Measurement Value - Limit Value.

Orthogonal Axis	X
Test Mode	UNII-2A_TX A Mode 5320 MHz

Horizontal

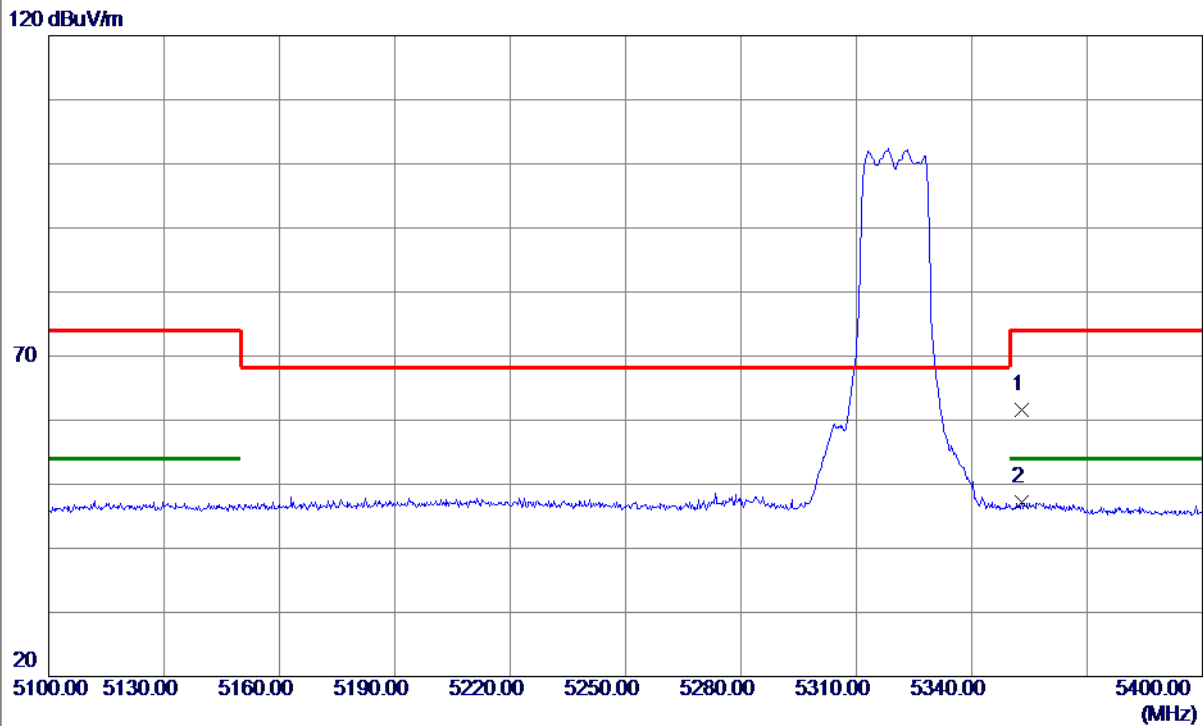

No.	Freq. MHz	Reading Level dBuV/m	Correct Factor dB	Measure ment dBuV/m	Limit dBuV/m	Margin dB	Detector	Comment
1	5353.0500	20.58	40.95	61.53	74.00	-12.47	Peak	
2 *	5353.0500	6.26	40.95	47.21	54.00	-6.79	AVG	

REMARKS:

- (1) Measurement Value = Reading Level + Correct Factor.
- (2) Margin Level = Measurement Value - Limit Value.

Orthogonal Axis	X
Test Mode	UNII-2A_TX A Mode 5320 MHz

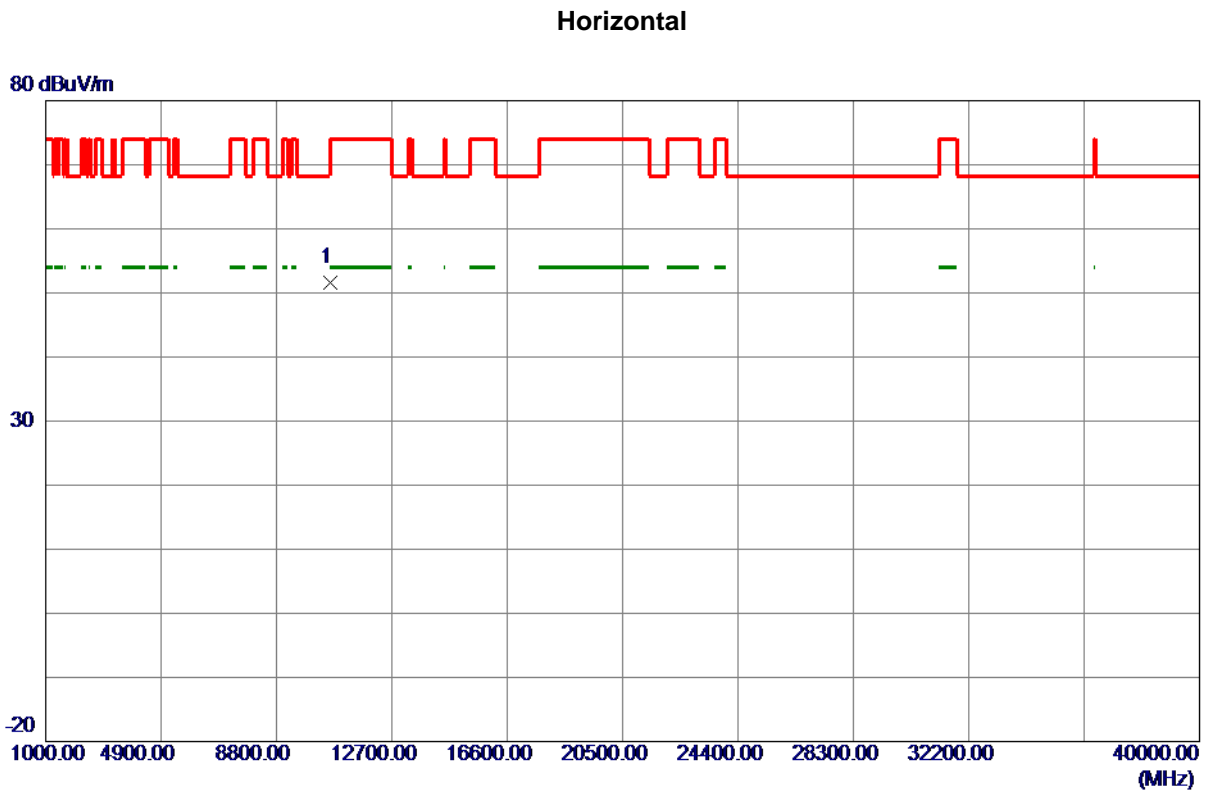

No.	Freq. MHz	Reading Level dBuV/m	Correct Factor dB	Measure ment dBuV/m	Limit dBuV/m	Margin dB	Detector	Comment
1 *	10640.0000	50.26	1.42	51.68	74.00	-22.32	Peak	

REMARKS:

- (1) Measurement Value = Reading Level + Correct Factor.
- (2) Margin Level = Measurement Value - Limit Value.

Orthogonal Axis	X
Test Mode	UNII-2C_TX A Mode 5500 MHz

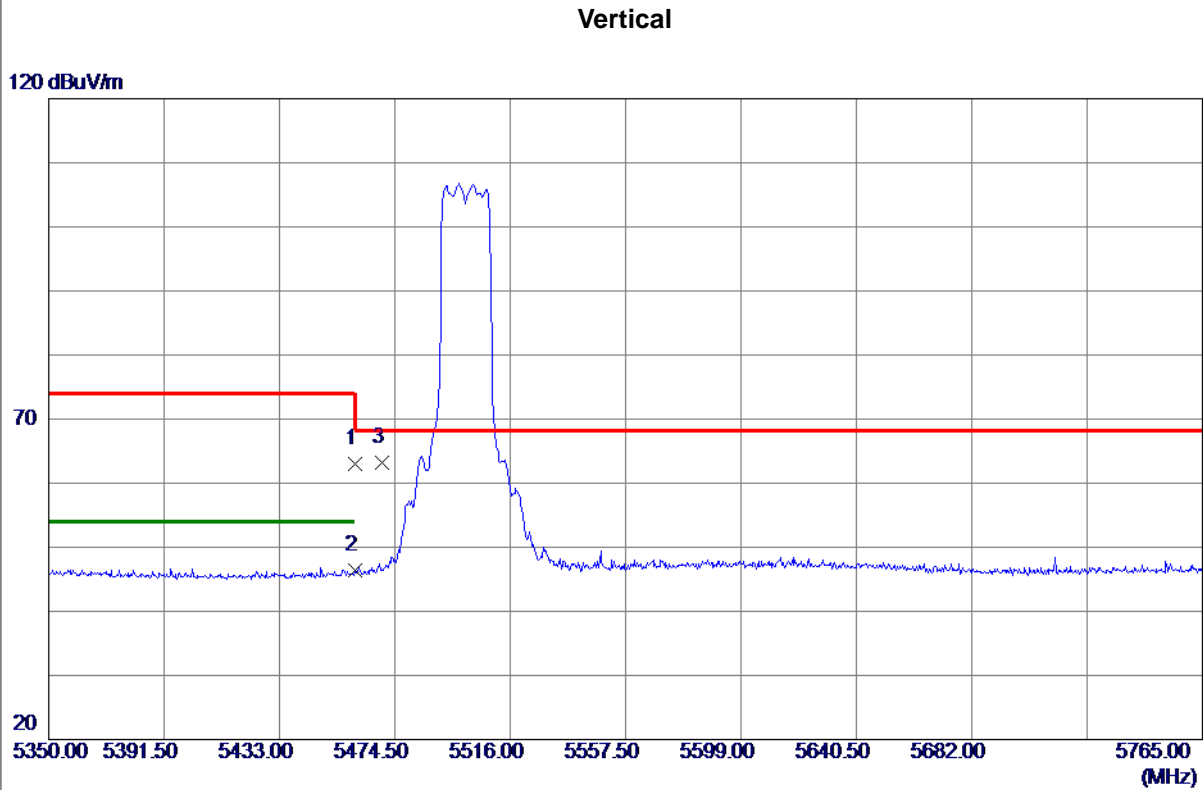

No.	Freq. MHz	Reading Level dBuV/m	Correct Factor dB	Measure ment dBuV/m	Limit dBuV/m	Margin dB	Detector	Comment
1	5460.0000	21.80	41.17	62.97	74.00	-11.03	Peak	
2	5460.0000	5.22	41.17	46.39	54.00	-7.61	AVG	
3 *	5470.0000	22.05	41.19	63.24	68.30	-5.06	Peak	

REMARKS:

- (1) Measurement Value = Reading Level + Correct Factor.
- (2) Margin Level = Measurement Value - Limit Value.

Orthogonal Axis	X
Test Mode	UNII-2C_TX A Mode 5500 MHz

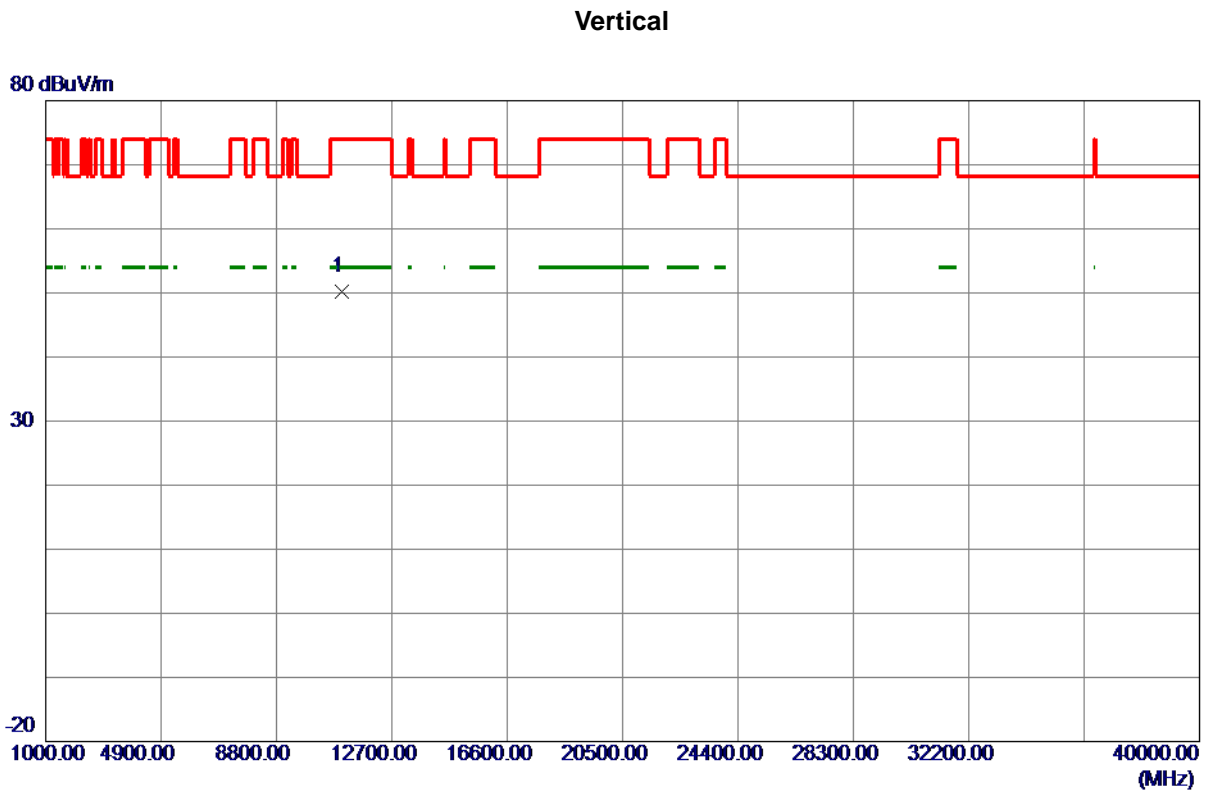

No.	Freq. MHz	Reading Level dBuV/m	Correct Factor dB	Measure ment dBuV/m	Limit dBuV/m	Margin dB	Detector	Comment
1 *	11000.0000	47.91	2.21	50.12	74.00	-23.88	Peak	

REMARKS:

- (1) Measurement Value = Reading Level + Correct Factor.
- (2) Margin Level = Measurement Value - Limit Value.

Orthogonal Axis	X
Test Mode	UNII-2C_TX A Mode 5500 MHz

Horizontal

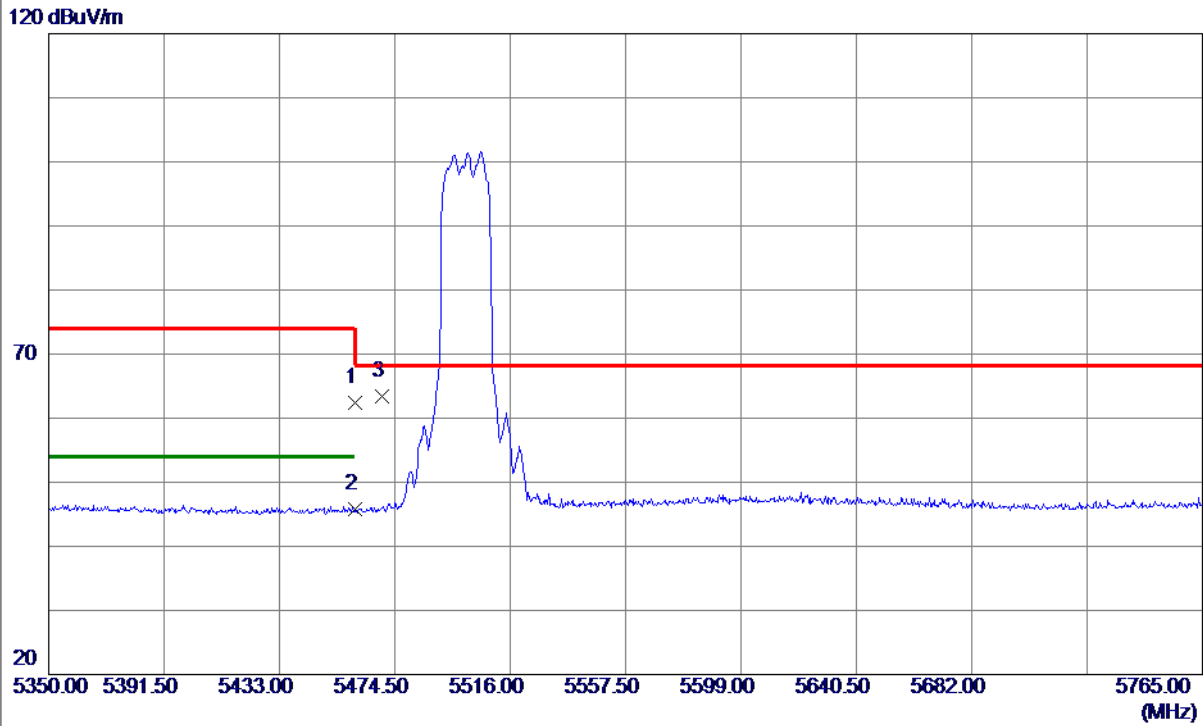

No.	Freq. MHz	Reading Level dBuV/m	Correct Factor dB	Measure ment dBuV/m	Limit dBuV/m	Margin dB	Detector	Comment
1	5460.0000	21.21	41.17	62.38	74.00	-11.62	Peak	
2	5460.0000	4.63	41.17	45.80	54.00	-8.20	AVG	
3 *	5470.0000	22.12	41.19	63.31	68.30	-4.99	Peak	

REMARKS:

- (1) Measurement Value = Reading Level + Correct Factor.
- (2) Margin Level = Measurement Value - Limit Value.

Orthogonal Axis	X
Test Mode	UNII-2C_TX A Mode 5500 MHz

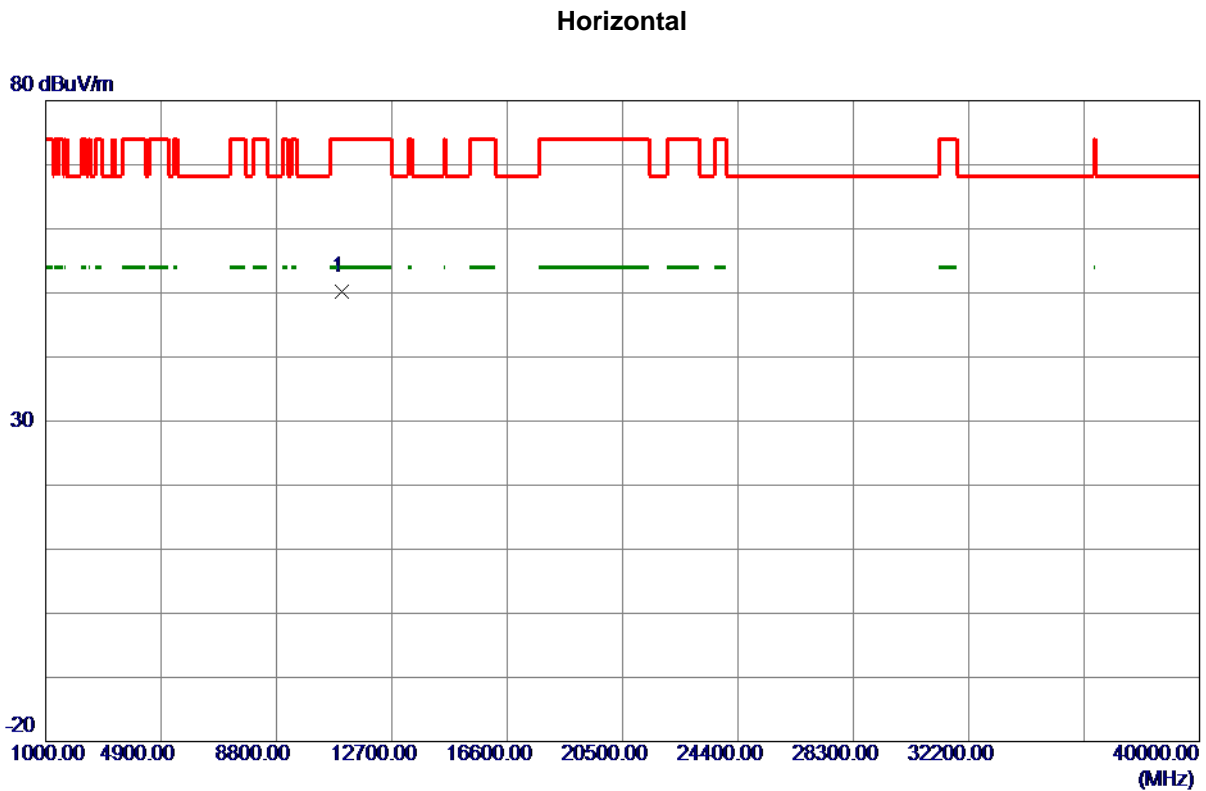

No.	Freq. MHz	Reading Level dBuV/m	Correct Factor dB	Measure ment dBuV/m	Limit dBuV/m	Margin dB	Detector	Comment
1 *	11000.0000	48.07	2.21	50.28	74.00	-23.72	Peak	

REMARKS:

- (1) Measurement Value = Reading Level + Correct Factor.
- (2) Margin Level = Measurement Value - Limit Value.

Orthogonal Axis	X
Test Mode	UNII-2C_TX A Mode 5580 MHz

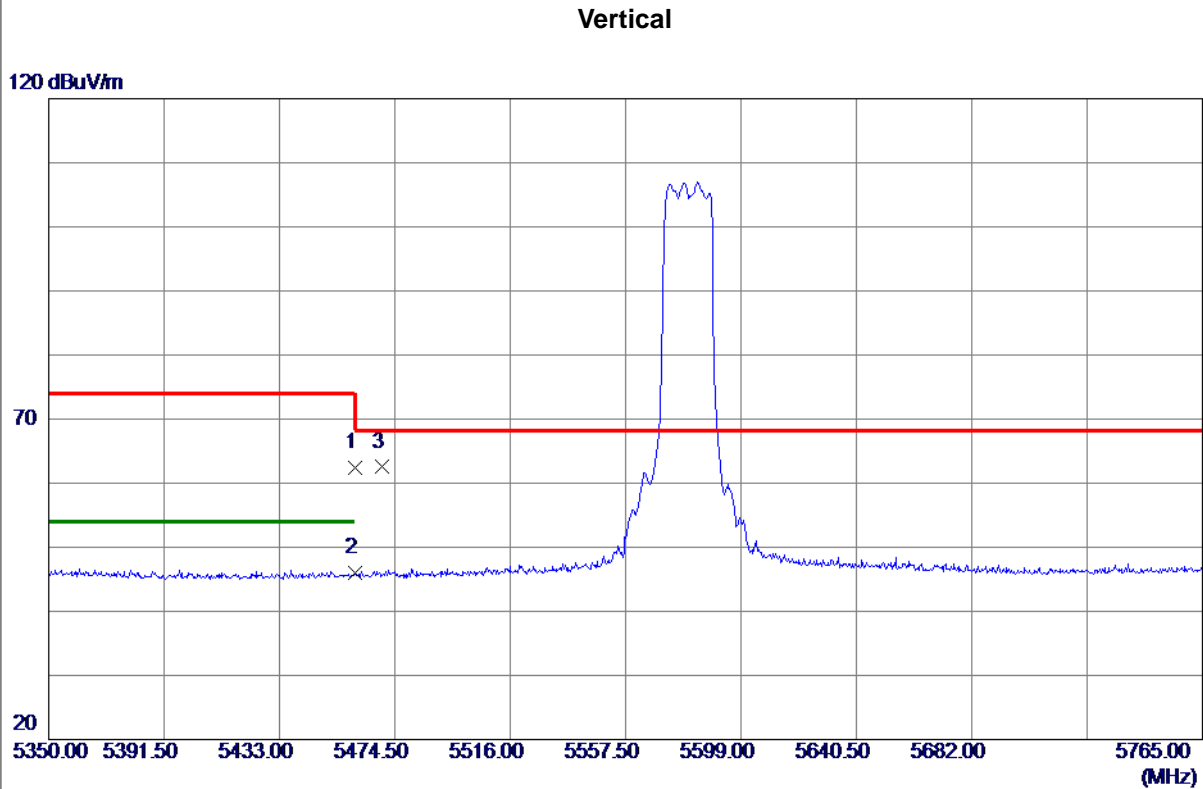

No.	Freq. MHz	Reading Level dBuV/m	Correct Factor dB	Measure ment dBuV/m	Limit dBuV/m	Margin dB	Detector	Comment
1	5460.0000	21.15	41.17	62.32	74.00	-11.68	Peak	
2	5460.0000	4.78	41.17	45.95	54.00	-8.05	AVG	
3 *	5470.0000	21.31	41.19	62.50	68.30	-5.80	Peak	

REMARKS:

- (1) Measurement Value = Reading Level + Correct Factor.
- (2) Margin Level = Measurement Value - Limit Value.

Orthogonal Axis	X
Test Mode	UNII-2C_TX A Mode 5580 MHz

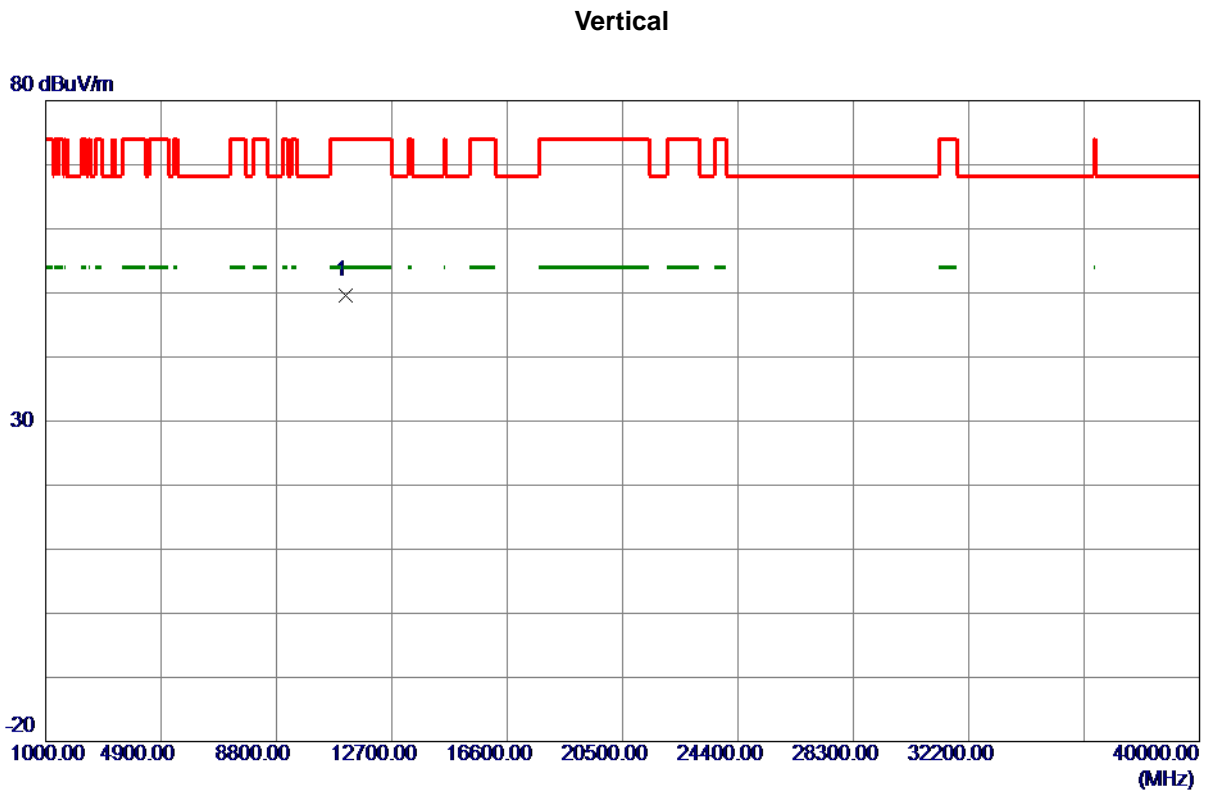

No.	Freq. MHz	Reading Level dBuV/m	Correct Factor dB	Measure ment dBuV/m	Limit dBuV/m	Margin dB	Detector	Comment
1 *	11160.0000	47.48	2.20	49.68	74.00	-24.32	Peak	

REMARKS:

- (1) Measurement Value = Reading Level + Correct Factor.
- (2) Margin Level = Measurement Value - Limit Value.

Orthogonal Axis	X
Test Mode	UNII-2C_TX A Mode 5580 MHz

Horizontal

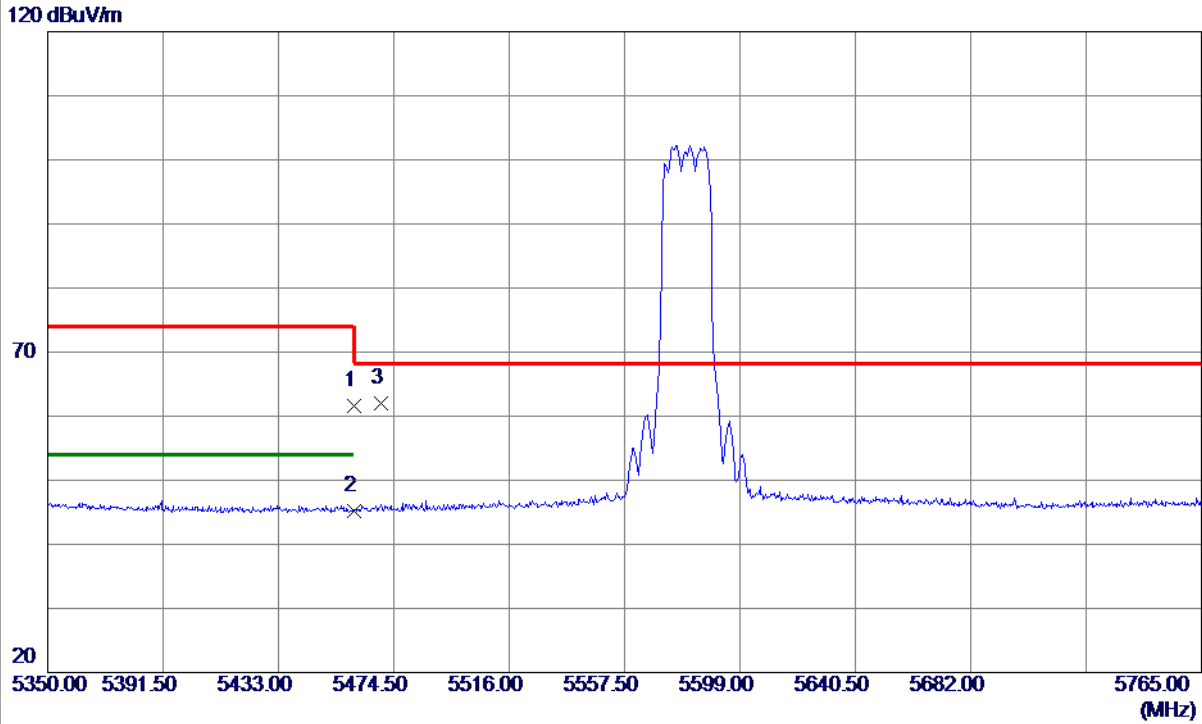

No.	Freq. MHz	Reading Level dBuV/m	Correct Factor dB	Measure ment dBuV/m	Limit dBuV/m	Margin dB	Detector	Comment
1	5460.0000	20.42	41.17	61.59	74.00	-12.41	Peak	
2	5460.0000	4.11	41.17	45.28	54.00	-8.72	AVG	
3 *	5470.0000	20.76	41.19	61.95	68.30	-6.35	Peak	

REMARKS:

- (1) Measurement Value = Reading Level + Correct Factor.
- (2) Margin Level = Measurement Value - Limit Value.

Orthogonal Axis	X
Test Mode	UNII-2C_TX A Mode 5580 MHz

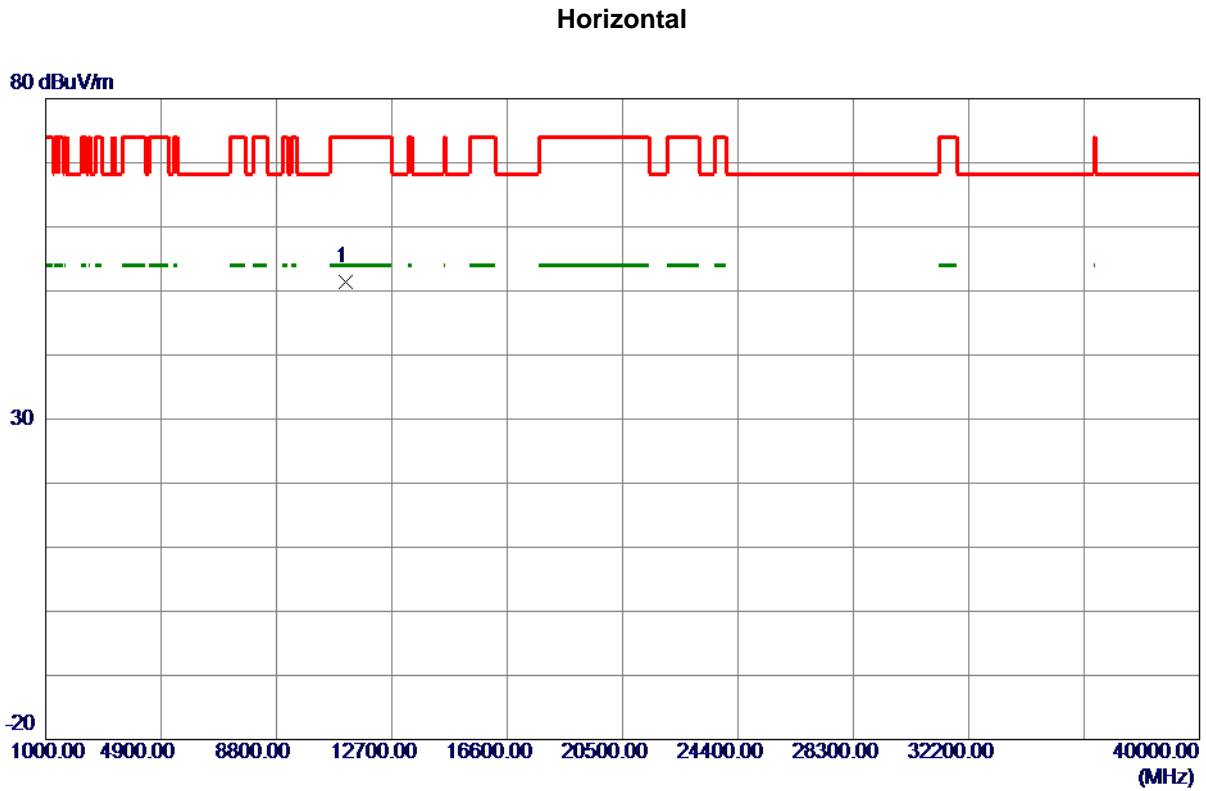

No.	Freq. MHz	Reading Level dBuV/m	Correct Factor dB	Measure ment dBuV/m	Limit dBuV/m	Margin dB	Detector	Comment
1 *	11160.0000	49.25	2.20	51.45	74.00	-22.55	Peak	

REMARKS:

- (1) Measurement Value = Reading Level + Correct Factor.
- (2) Margin Level = Measurement Value - Limit Value.

Orthogonal Axis	X
Test Mode	UNII-2C_TX A Mode 5700 MHz

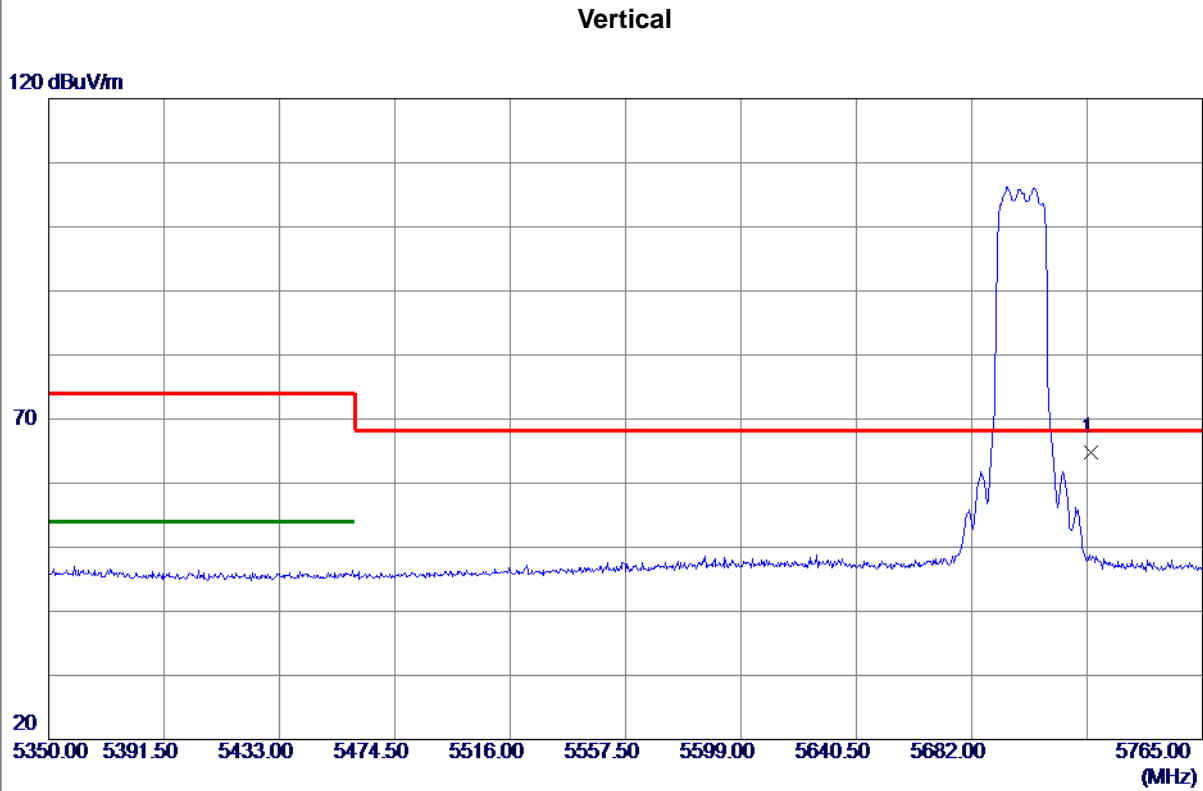

No.	Freq. MHz	Reading Level dBuV/m	Correct Factor dB	Measure ment dBuV/m	Limit dBuV/m	Margin dB	Detector	Comment
1 *	5725.0000	23.24	41.60	64.84	68.30	-3.46	Peak	

REMARKS:

- (1) Measurement Value = Reading Level + Correct Factor.
- (2) Margin Level = Measurement Value - Limit Value.

Orthogonal Axis	X
Test Mode	UNII-2C_TX A Mode 5700 MHz

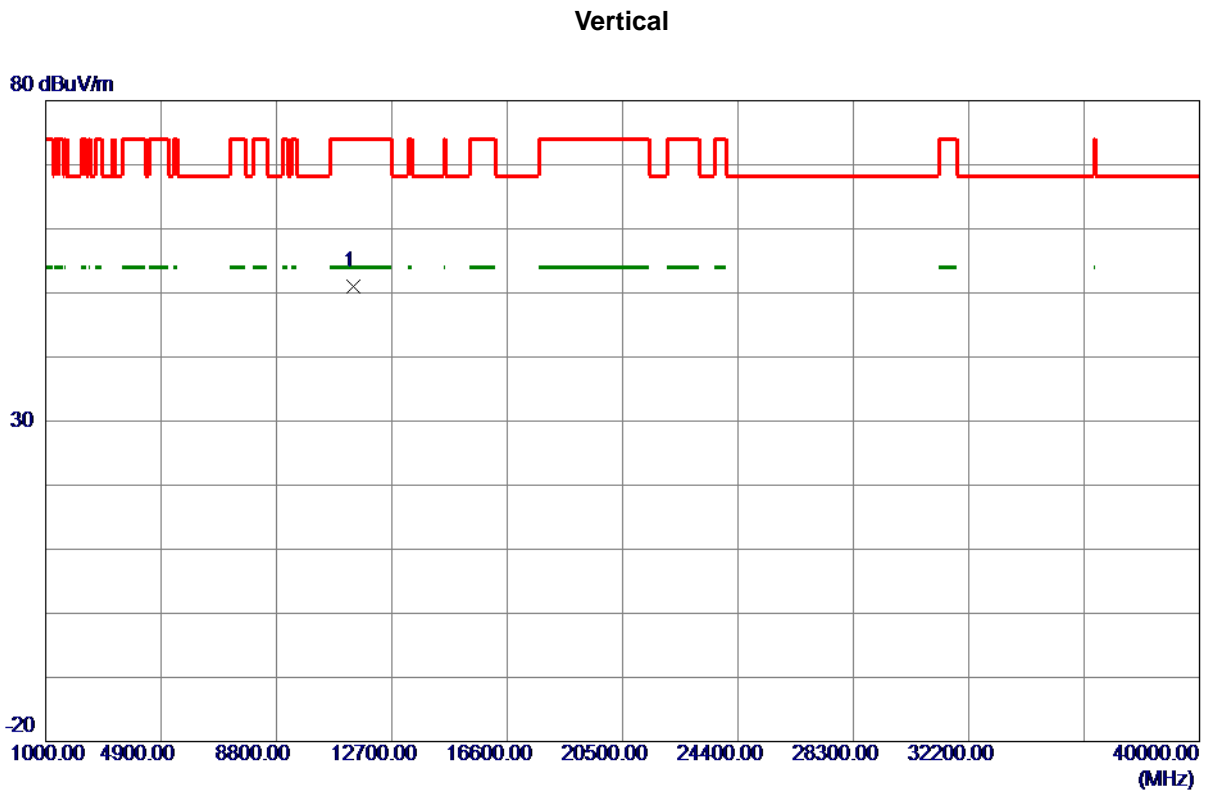

No.	Freq. MHz	Reading Level dBuV/m	Correct Factor dB	Measure ment dBuV/m	Limit dBuV/m	Margin dB	Detector	Comment
1 *	11400.0000	48.83	2.19	51.02	74.00	-22.98	Peak	

REMARKS:

- (1) Measurement Value = Reading Level + Correct Factor.
- (2) Margin Level = Measurement Value - Limit Value.

Orthogonal Axis	X
Test Mode	UNII-2C_TX A Mode 5700 MHz

Horizontal

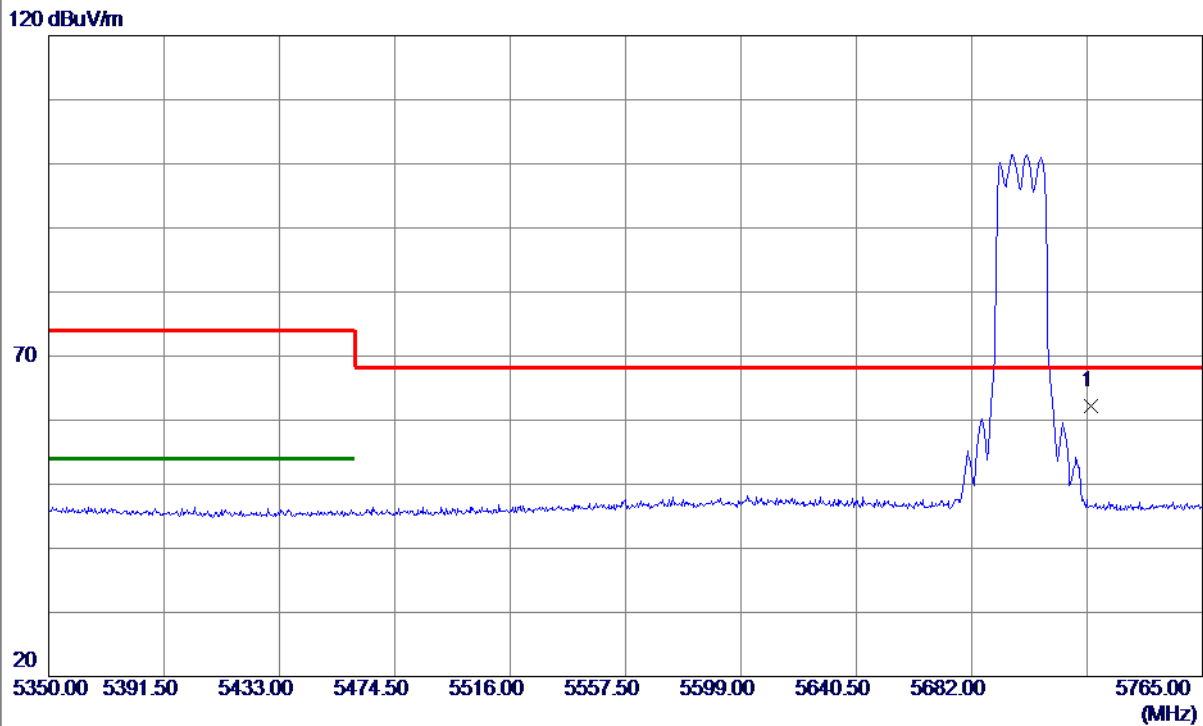

No.	Freq. MHz	Reading Level dBuV/m	Correct Factor dB	Measure ment dBuV/m	Limit dBuV/m	Margin dB	Detector	Comment
1 *	5725.0000	20.61	41.60	62.21	68.30	-6.09	Peak	

REMARKS:

- (1) Measurement Value = Reading Level + Correct Factor.
- (2) Margin Level = Measurement Value - Limit Value.

Orthogonal Axis	X
Test Mode	UNII-2C_TX A Mode 5700 MHz

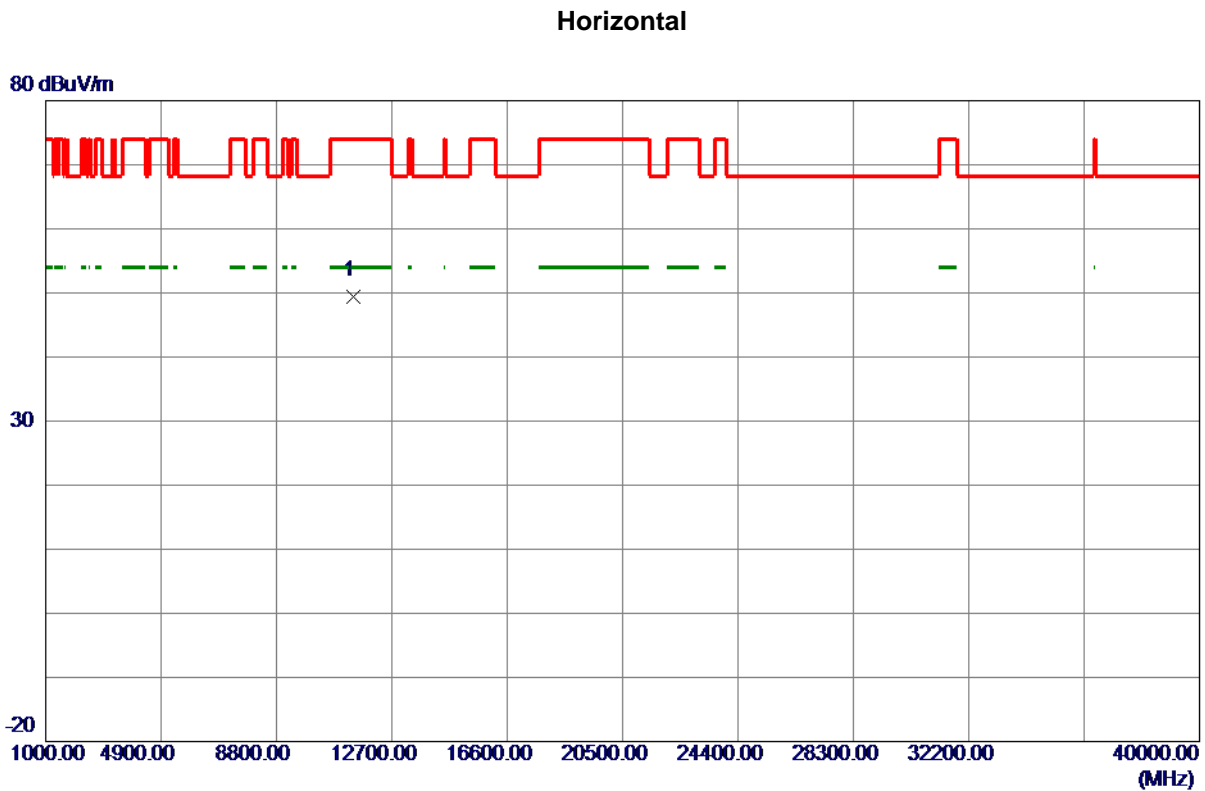

No.	Freq. MHz	Reading Level dBuV/m	Correct Factor dB	Measure ment dBuV/m	Limit dBuV/m	Margin dB	Detector	Comment
1 *	11400.0000	47.31	2.19	49.50	74.00	-24.50	Peak	

REMARKS:

- (1) Measurement Value = Reading Level + Correct Factor.
- (2) Margin Level = Measurement Value - Limit Value.

Orthogonal Axis	X
Test Mode	UNII-3_TX A Mode 5745 MHz

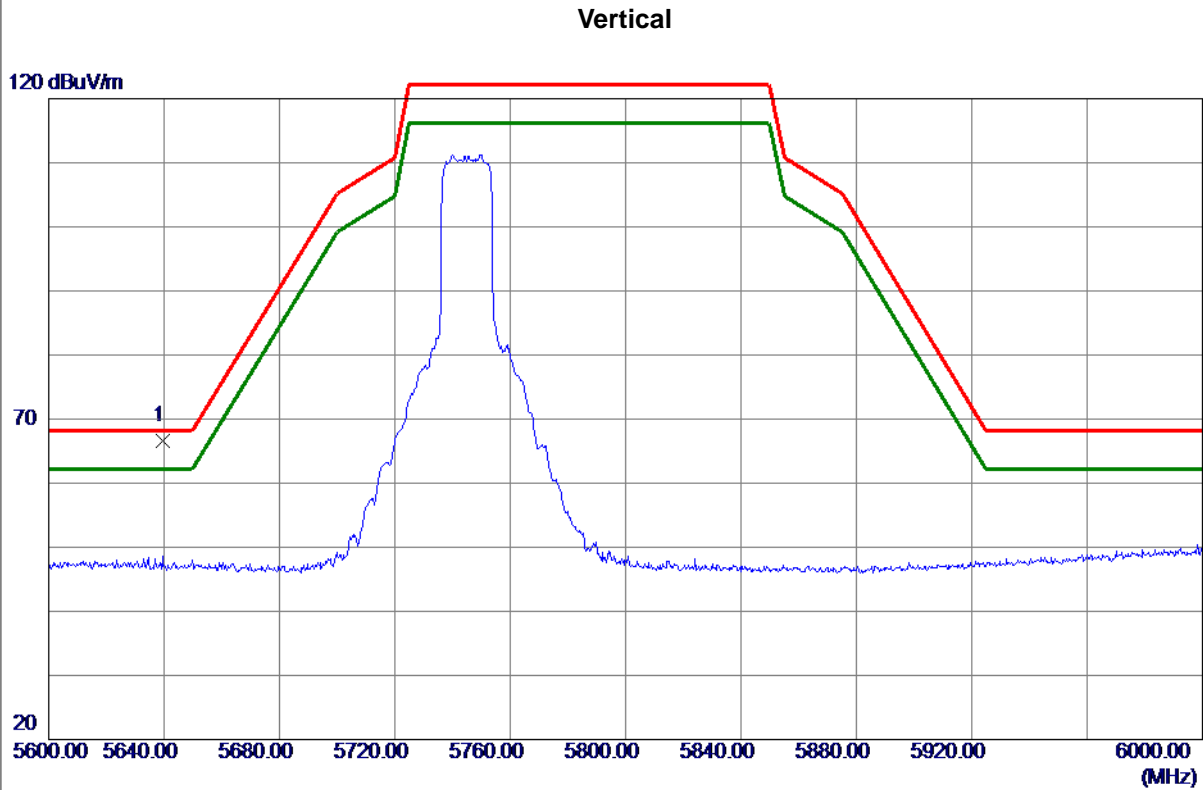

No.	Freq. MHz	Reading Level dBuV/m	Correct Factor dB	Measure ment dBuV/m	Limit dBuV/m	Margin dB	Detector	Comment
1 *	5639.4000	25.18	41.47	66.65	68.20	-1.55	Peak	

REMARKS:

- (1) Measurement Value = Reading Level + Correct Factor.
- (2) Margin Level = Measurement Value - Limit Value.

Orthogonal Axis	X
Test Mode	UNII-3_TX A Mode 5745 MHz

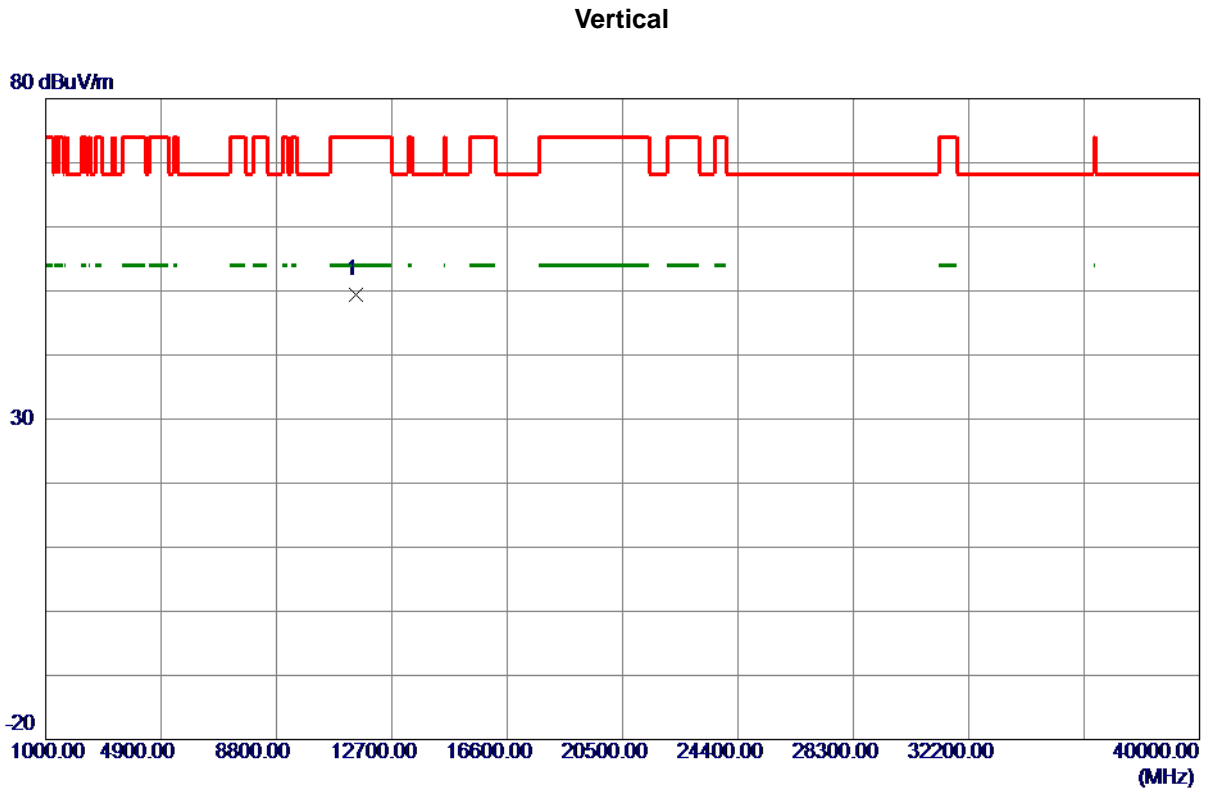

No.	Freq. MHz	Reading Level dBuV/m	Correct Factor dB	Measure ment dBuV/m	Limit dBuV/m	Margin dB	Detector	Comment
1 *	11490.0000	47.22	2.18	49.40	74.00	-24.60	Peak	

REMARKS:

- (1) Measurement Value = Reading Level + Correct Factor.
- (2) Margin Level = Measurement Value - Limit Value.

Orthogonal Axis	X
Test Mode	UNII-3_TX A Mode 5745 MHz

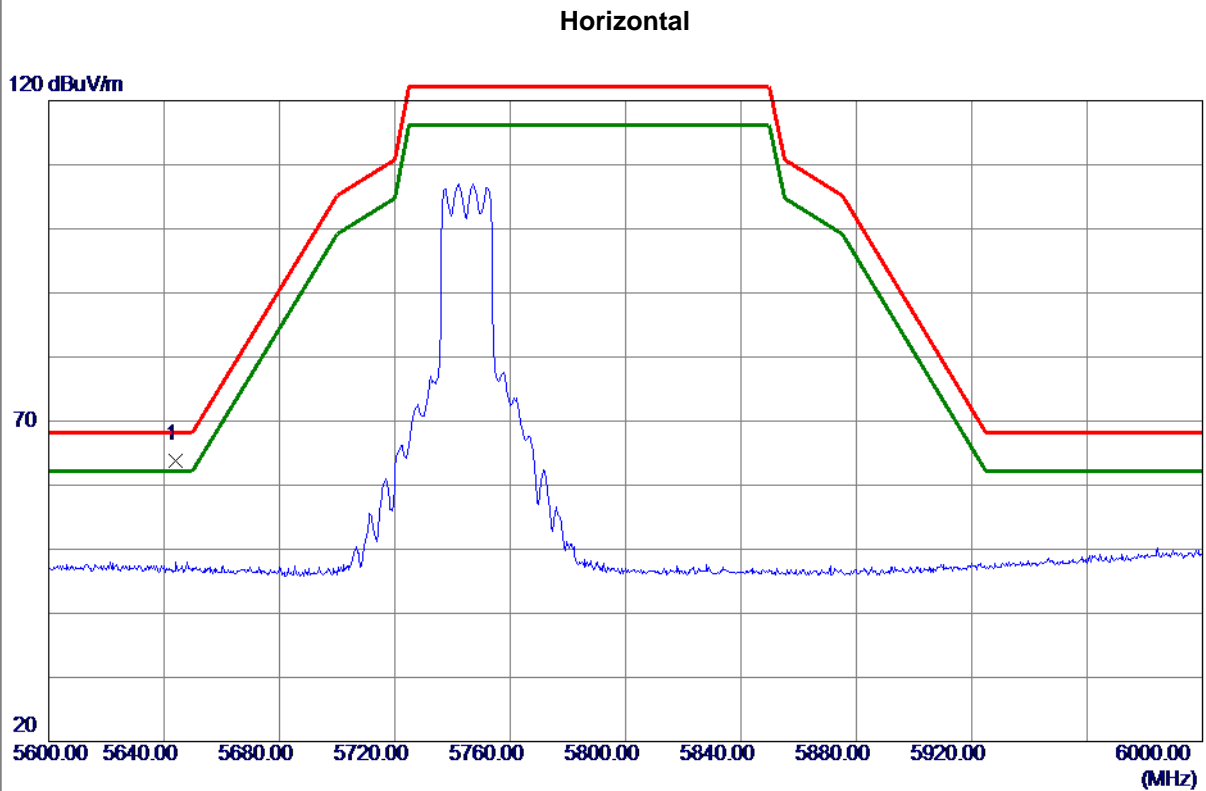

No.	Freq. MHz	Reading Level dBuV/m	Correct Factor dB	Measure ment dBuV/m	Limit dBuV/m	Margin dB	Detector	Comment
1 *	5644.2000	22.43	41.47	63.90	68.20	-4.30	Peak	

REMARKS:

- (1) Measurement Value = Reading Level + Correct Factor.
- (2) Margin Level = Measurement Value - Limit Value.

Orthogonal Axis	X
Test Mode	UNII-3_TX A Mode 5745 MHz

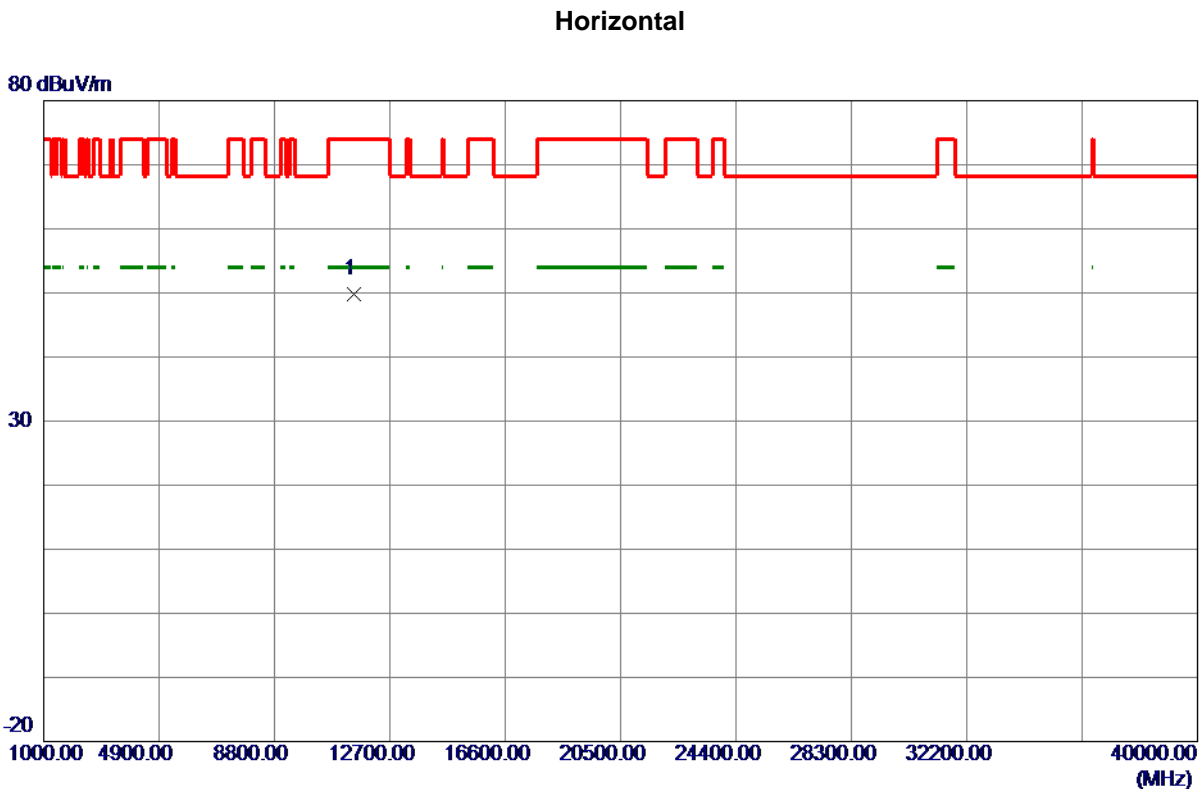

No.	Freq. MHz	Reading Level dBuV/m	Correct Factor dB	Measure ment dBuV/m	Limit dBuV/m	Margin dB	Detector	Comment
1 *	11490.0000	47.71	2.18	49.89	74.00	-24.11	Peak	

REMARKS:

- (1) Measurement Value = Reading Level + Correct Factor.
- (2) Margin Level = Measurement Value - Limit Value.

Orthogonal Axis	X
Test Mode	UNII-3_TX A Mode 5785 MHz

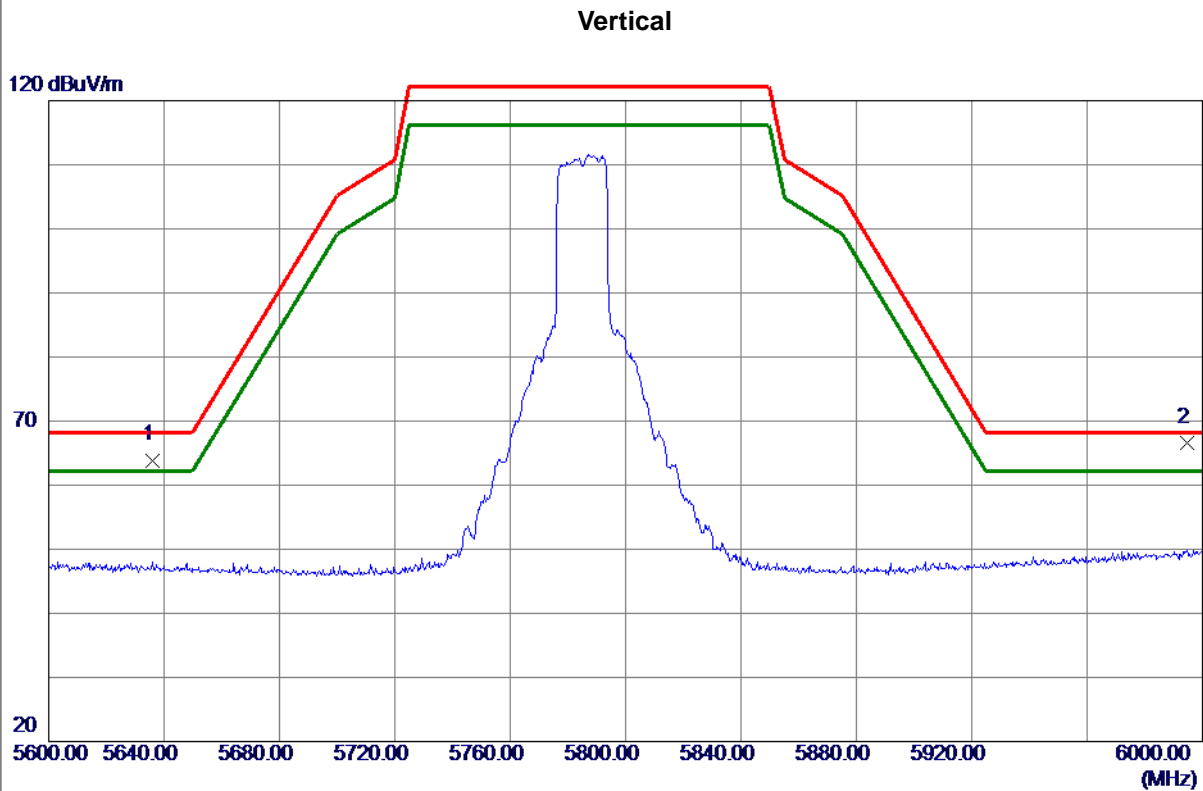

No.	Freq. MHz	Reading Level dBuV/m	Correct Factor dB	Measure ment dBuV/m	Limit dBuV/m	Margin dB	Detector	Comment
1	5635.8000	22.44	41.46	63.90	68.20	-4.30	Peak	
2 *	5994.6000	24.67	42.02	66.69	68.20	-1.51	Peak	

REMARKS:

- (1) Measurement Value = Reading Level + Correct Factor.
- (2) Margin Level = Measurement Value - Limit Value.

Orthogonal Axis	X
Test Mode	UNII-3_TX A Mode 5785 MHz

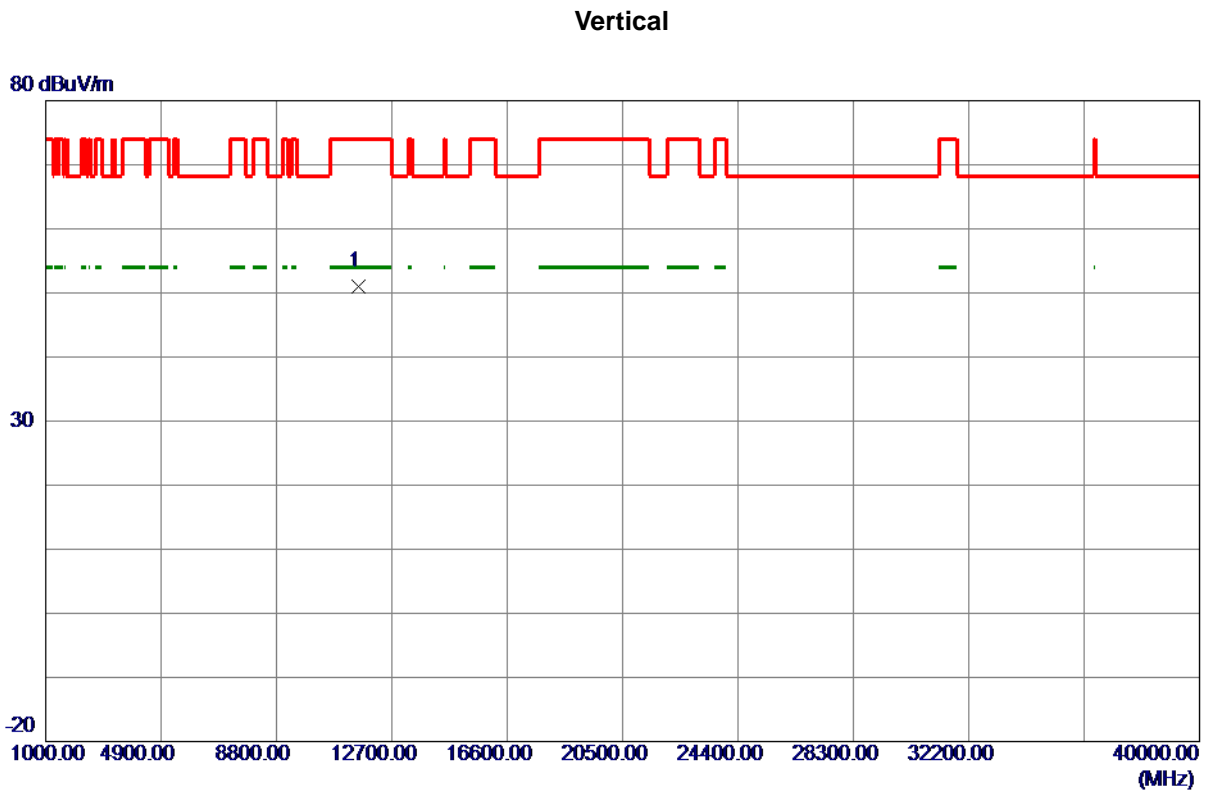

No.	Freq. MHz	Reading Level dBuV/m	Correct Factor dB	Measure ment dBuV/m	Limit dBuV/m	Margin dB	Detector	Comment
1 *	11570.0000	48.81	2.11	50.92	74.00	-23.08	Peak	

REMARKS:

- (1) Measurement Value = Reading Level + Correct Factor.
- (2) Margin Level = Measurement Value - Limit Value.

Orthogonal Axis	X
Test Mode	UNII-3_TX A Mode 5785 MHz

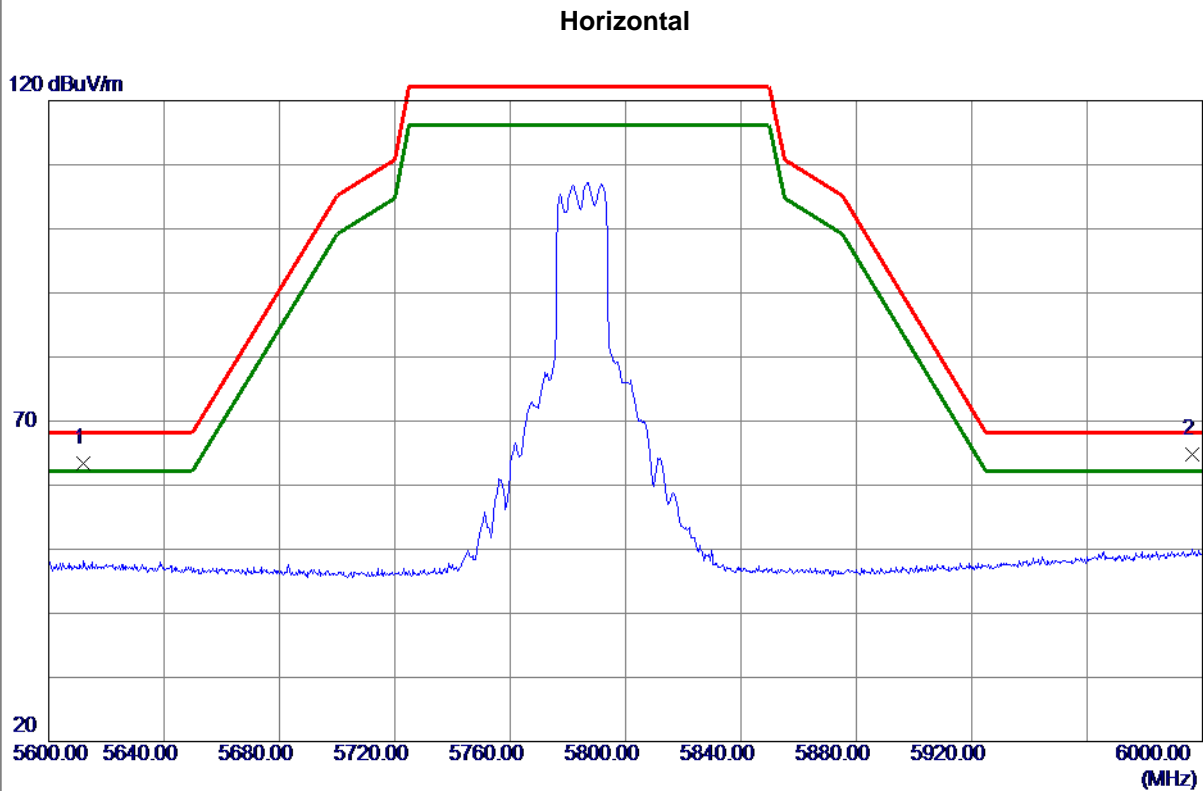

No.	Freq. MHz	Reading Level dBuV/m	Correct Factor dB	Measure ment dBuV/m	Limit dBuV/m	Margin dB	Detector	Comment
1	5612.2000	21.90	41.42	63.32	68.20	-4.88	Peak	
2 *	5996.6000	22.75	42.02	64.77	68.20	-3.43	Peak	

REMARKS:

- (1) Measurement Value = Reading Level + Correct Factor.
- (2) Margin Level = Measurement Value - Limit Value.

Orthogonal Axis	X
Test Mode	UNII-3_TX A Mode 5785 MHz

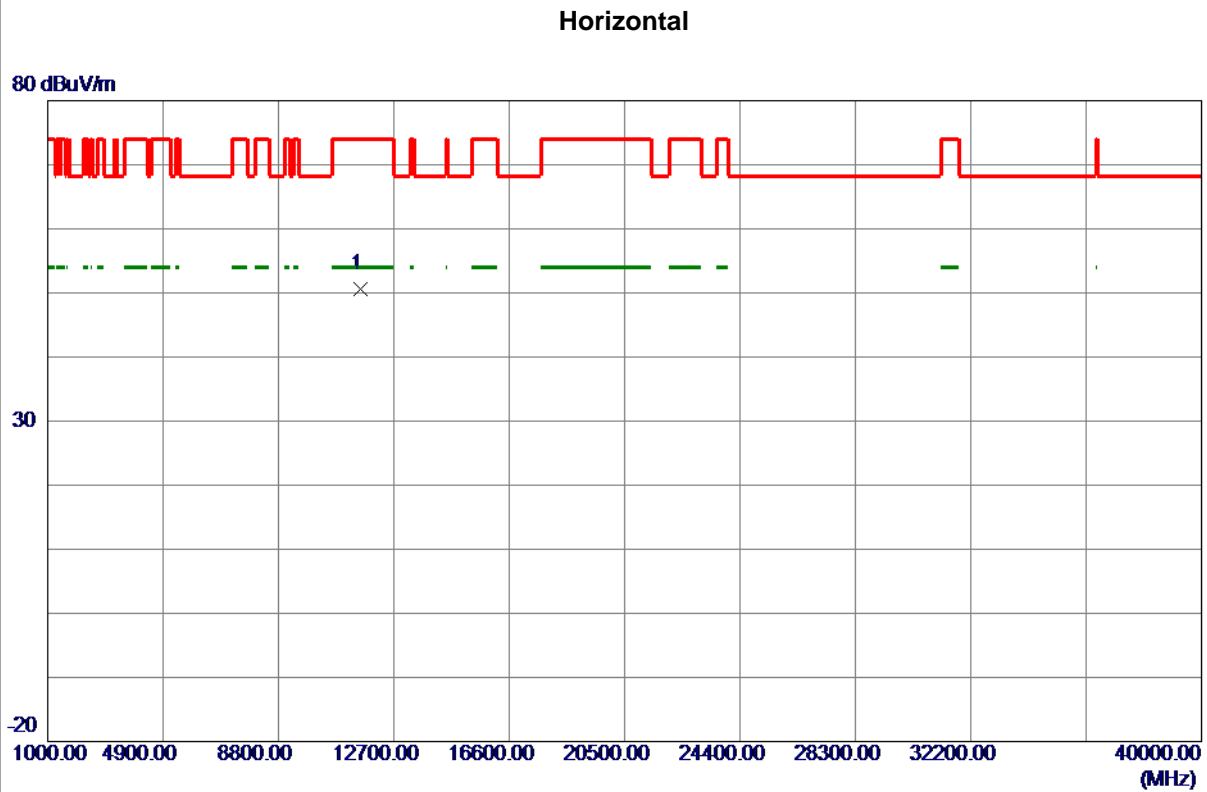

No.	Freq. MHz	Reading Level dBuV/m	Correct Factor dB	Measure ment dBuV/m	Limit dBuV/m	Margin dB	Detector	Comment
1 *	11570.0000	48.52	2.11	50.63	74.00	-23.37	Peak	

REMARKS:

- (1) Measurement Value = Reading Level + Correct Factor.
- (2) Margin Level = Measurement Value - Limit Value.

Orthogonal Axis	X
Test Mode	UNII-3_TX A Mode 5825 MHz

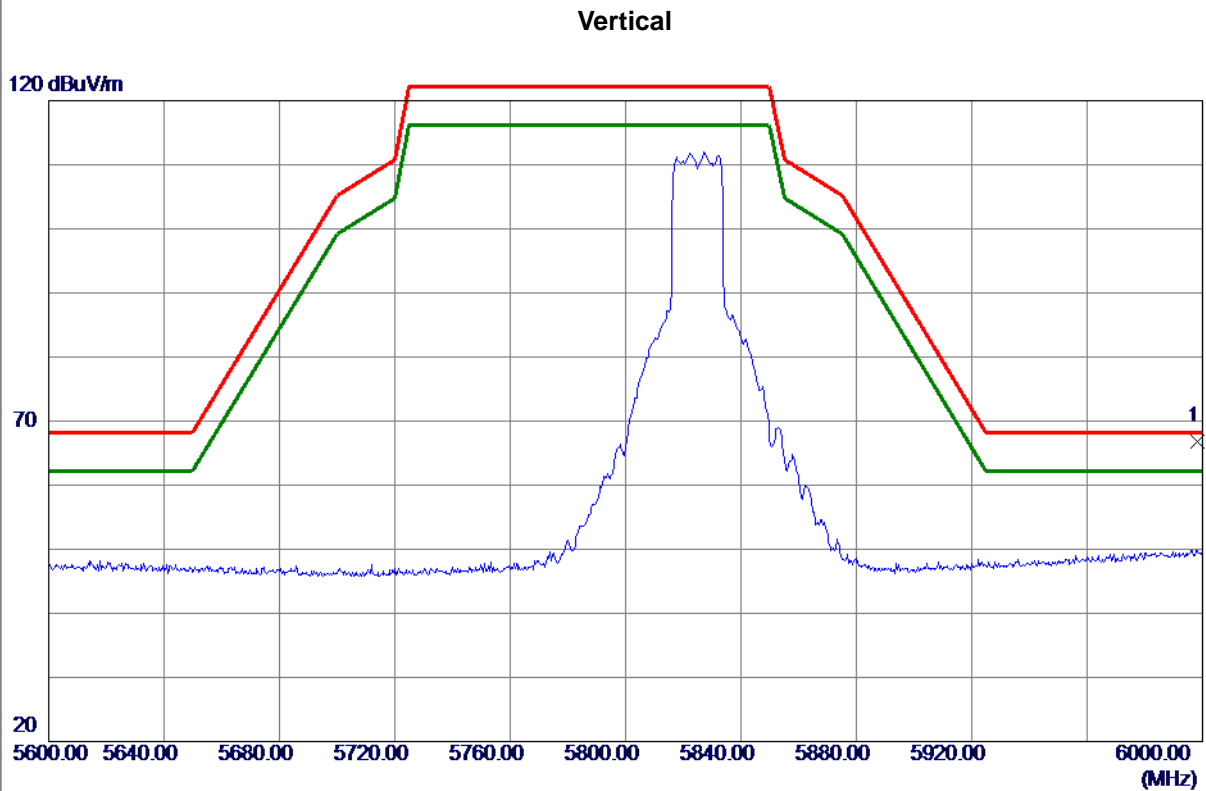

No.	Freq. MHz	Reading Level dBuV/m	Correct Factor dB	Measure ment dBuV/m	Limit dBuV/m	Margin dB	Detector	Comment
1 *	5998.4000	24.83	42.03	66.86	68.20	-1.34	Peak	

REMARKS:

- (1) Measurement Value = Reading Level + Correct Factor.
- (2) Margin Level = Measurement Value - Limit Value.

Orthogonal Axis	X
Test Mode	UNII-3_TX A Mode 5825 MHz

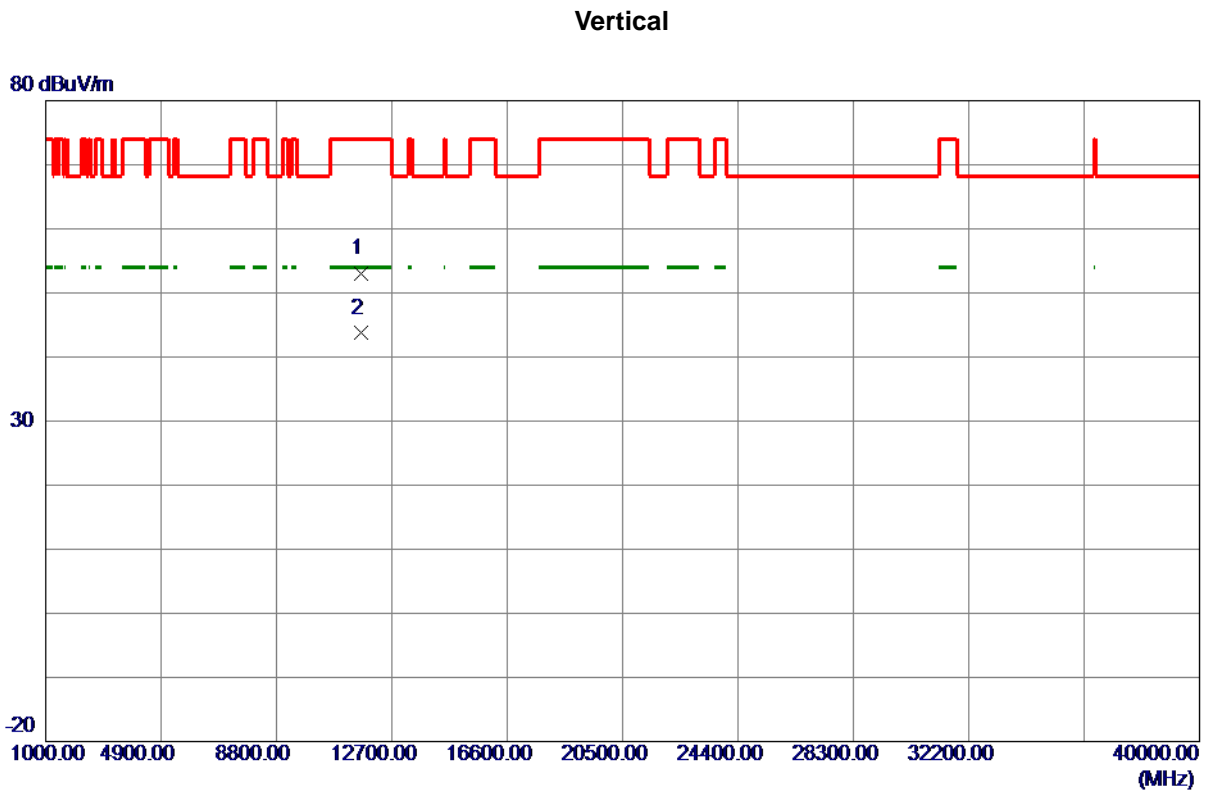

No.	Freq. MHz	Reading Level dBuV/m	Correct Factor dB	Measure ment dBuV/m	Limit dBuV/m	Margin dB	Detector	Comment
1	11650.0000	51.05	2.02	53.07	74.00	-20.93	Peak	
2 *	11650.0000	41.68	2.02	43.70	54.00	-10.30	AVG	

REMARKS:

- (1) Measurement Value = Reading Level + Correct Factor.
- (2) Margin Level = Measurement Value - Limit Value.

Orthogonal Axis	X
Test Mode	UNII-3_TX A Mode 5825 MHz

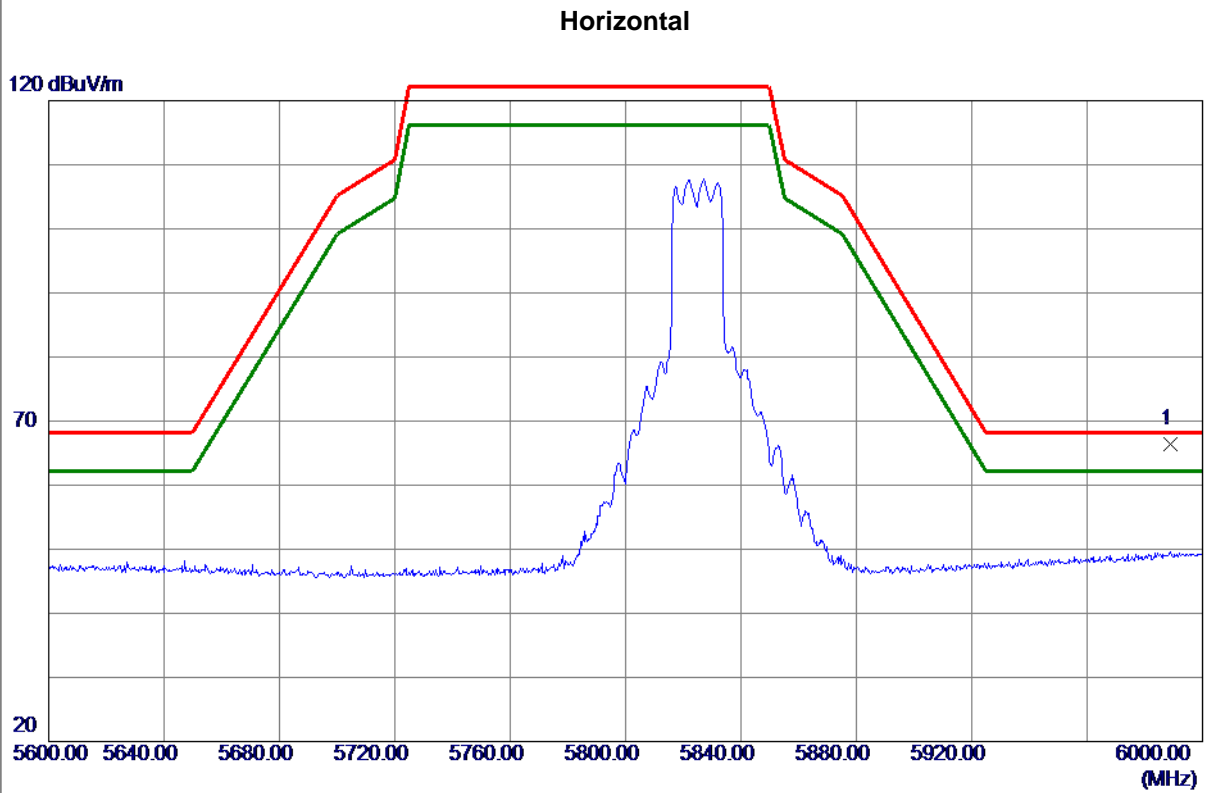

No.	Freq. MHz	Reading Level dBuV/m	Correct Factor dB	Measure ment dBuV/m	Limit dBuV/m	Margin dB	Detector	Comment
1 *	5989.0000	24.40	42.01	66.41	68.20	-1.79	Peak	

REMARKS:

- (1) Measurement Value = Reading Level + Correct Factor.
- (2) Margin Level = Measurement Value - Limit Value.

Orthogonal Axis	X
Test Mode	UNII-3_TX A Mode 5825 MHz

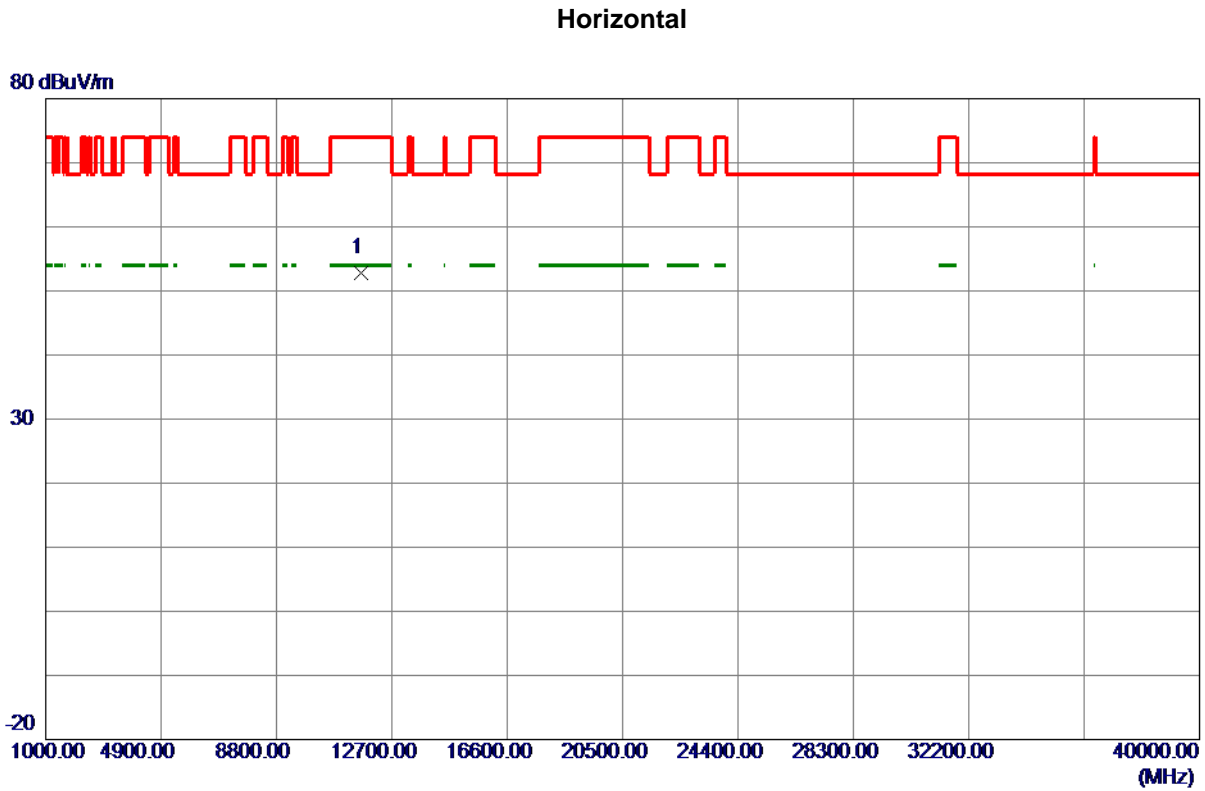

No.	Freq. MHz	Reading Level dBuV/m	Correct Factor dB	Measure ment dBuV/m	Limit dBuV/m	Margin dB	Detector	Comment
1 *	11650.0000	50.78	2.02	52.80	74.00	-21.20	Peak	

REMARKS:

- (1) Measurement Value = Reading Level + Correct Factor.
- (2) Margin Level = Measurement Value - Limit Value.

Orthogonal Axis	X
Test Mode	UNII-1_TX AC (VHT20) Mode 5180 MHz

Vertical

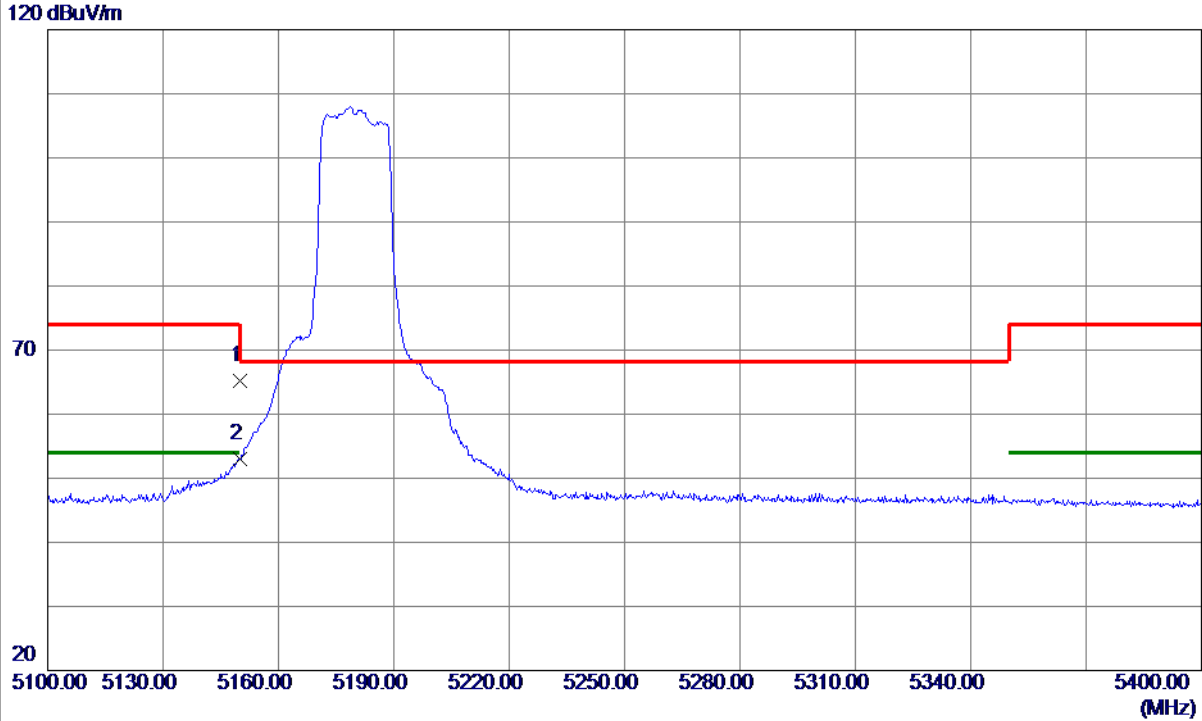

No.	Freq. MHz	Reading Level dBuV/m	Correct Factor dB	Measure ment dBuV/m	Limit dBuV/m	Margin dB	Detector	Comment
1	5150.0000	24.58	40.53	65.11	74.00	-8.89	Peak	
2 *	5150.0000	12.52	40.53	53.05	54.00	-0.95	AVG	

REMARKS:

- (1) Measurement Value = Reading Level + Correct Factor.
- (2) Margin Level = Measurement Value - Limit Value.

Orthogonal Axis	X
Test Mode	UNII-1_TX AC (VHT20) Mode 5180 MHz

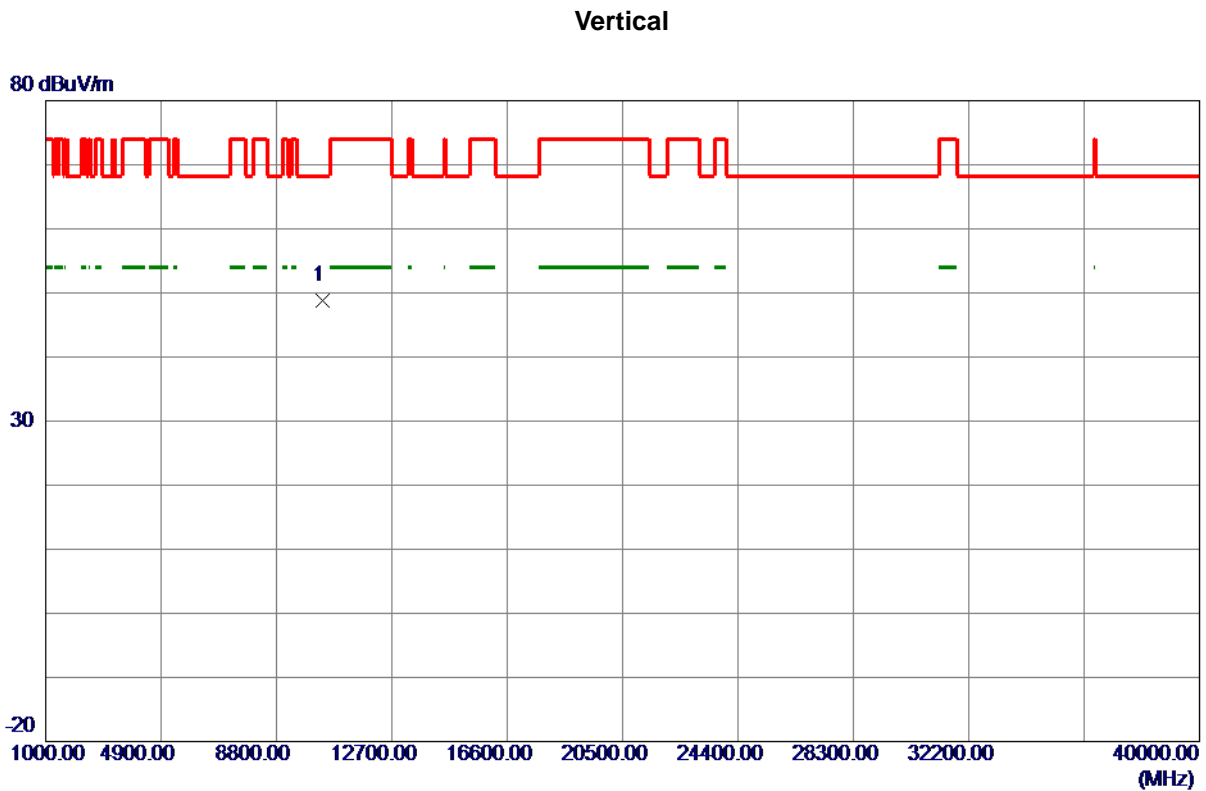

No.	Freq. MHz	Reading Level dBuV/m	Correct Factor dB	Measure ment dBuV/m	Limit dBuV/m	Margin dB	Detector	Comment
1 *	10360.0000	48.18	0.67	48.85	68.30	-19.45	Peak	

REMARKS:

- (1) Measurement Value = Reading Level + Correct Factor.
- (2) Margin Level = Measurement Value - Limit Value.

Orthogonal Axis	X
Test Mode	UNII-1_TX AC (VHT20) Mode 5180 MHz

Horizontal

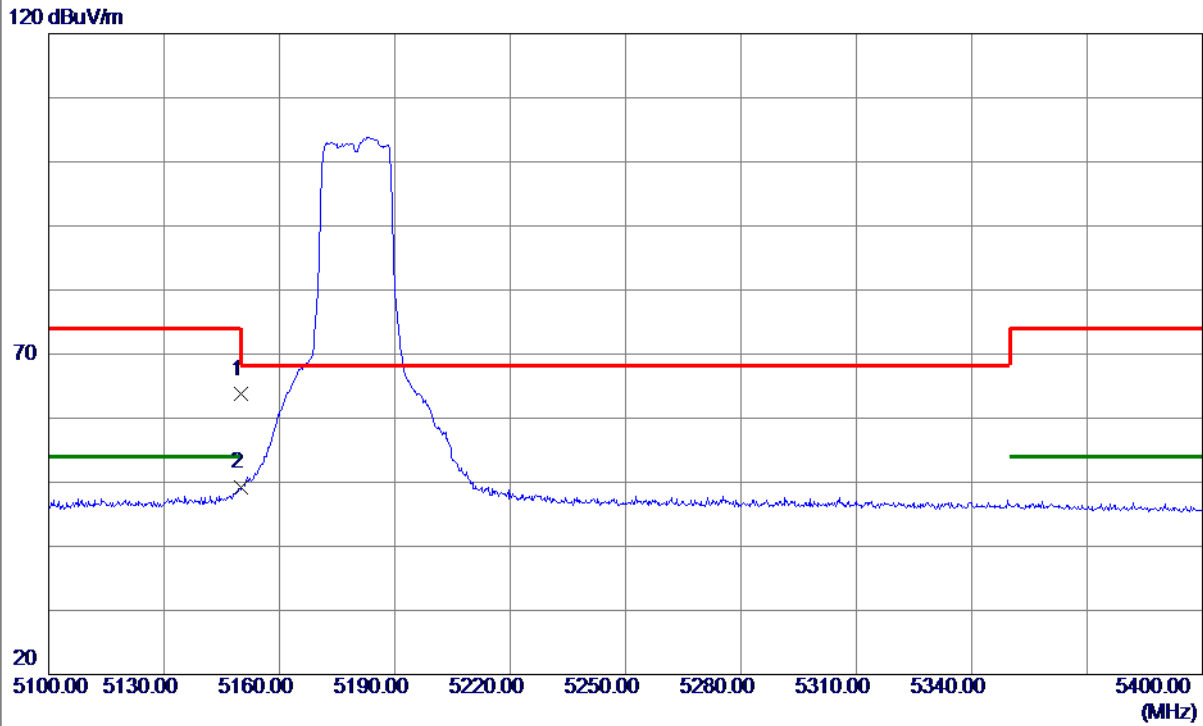

No.	Freq. MHz	Reading Level dBuV/m	Correct Factor dB	Measure ment dBuV/m	Limit dBuV/m	Margin dB	Detector	Comment
1	5150.0000	23.17	40.53	63.70	74.00	-10.30	Peak	
2 *	5150.0000	8.66	40.53	49.19	54.00	-4.81	AVG	

REMARKS:

- (1) Measurement Value = Reading Level + Correct Factor.
- (2) Margin Level = Measurement Value - Limit Value.

Orthogonal Axis	X
Test Mode	UNII-1_TX AC (VHT20) Mode 5180 MHz

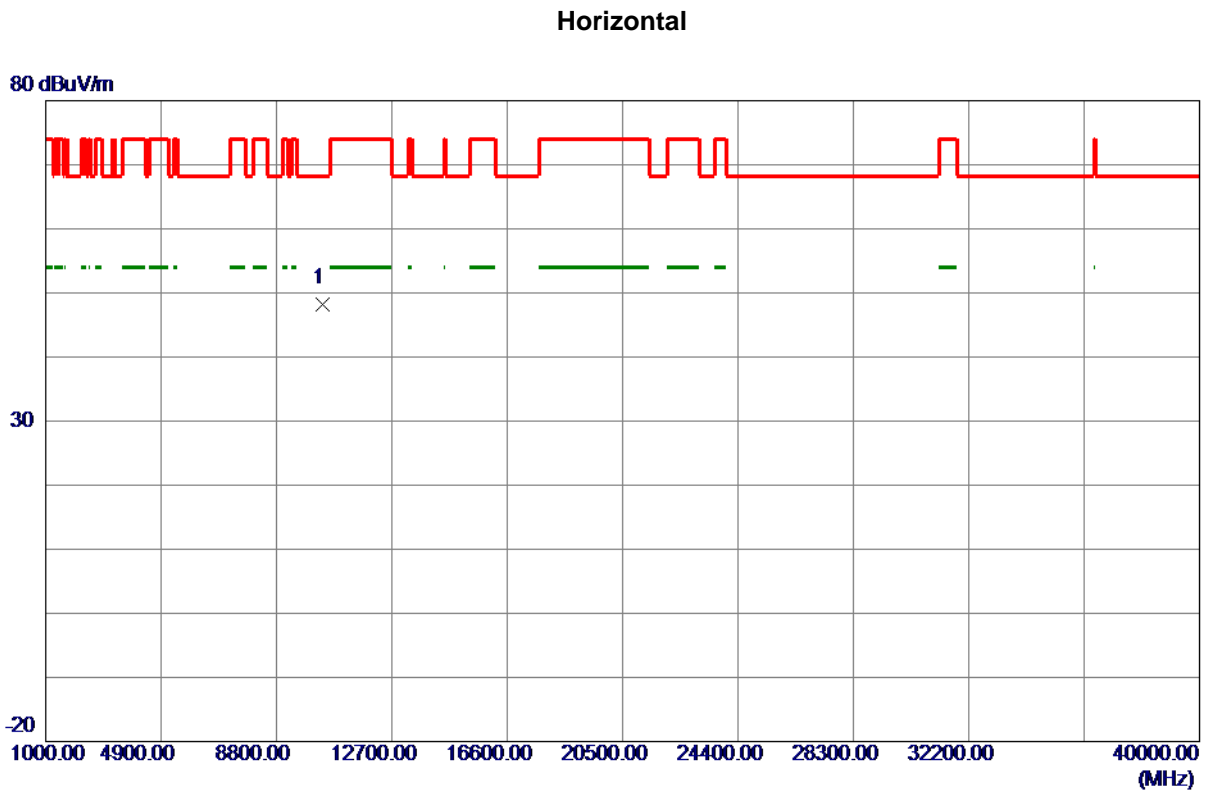

No.	Freq. MHz	Reading Level dBuV/m	Correct Factor dB	Measure ment dBuV/m	Limit dBuV/m	Margin dB	Detector	Comment
1 *	10360.0000	47.63	0.67	48.30	68.30	-20.00	Peak	

REMARKS:

- (1) Measurement Value = Reading Level + Correct Factor.
- (2) Margin Level = Measurement Value - Limit Value.

Orthogonal Axis	X
Test Mode	UNII-1_TX AC (VHT20) Mode 5200 MHz

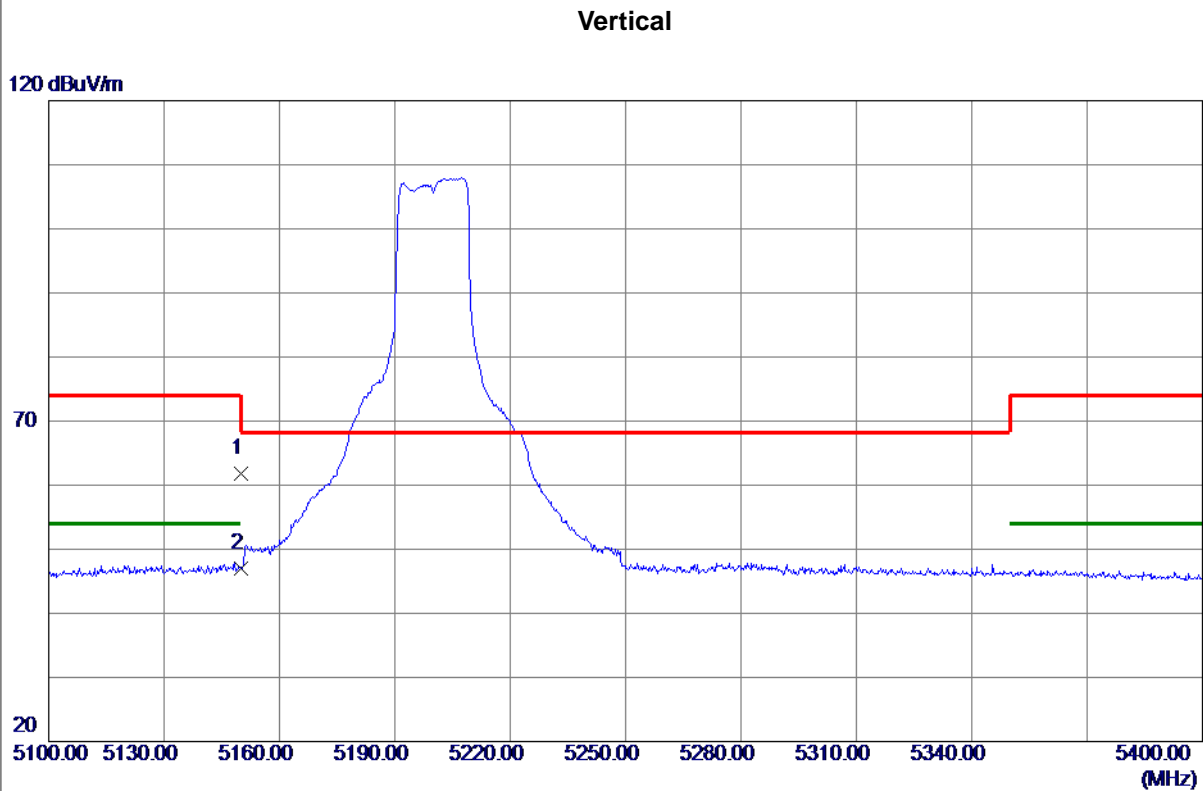

No.	Freq. MHz	Reading Level dBuV/m	Correct Factor dB	Measure ment dBuV/m	Limit dBuV/m	Margin dB	Detector	Comment
1	5150.0000	21.32	40.53	61.85	74.00	-12.15	Peak	
2 *	5150.0000	6.46	40.53	46.99	54.00	-7.01	AVG	

REMARKS:

- (1) Measurement Value = Reading Level + Correct Factor.
- (2) Margin Level = Measurement Value - Limit Value.

Orthogonal Axis	X
Test Mode	UNII-1_TX AC (VHT20) Mode 5200 MHz

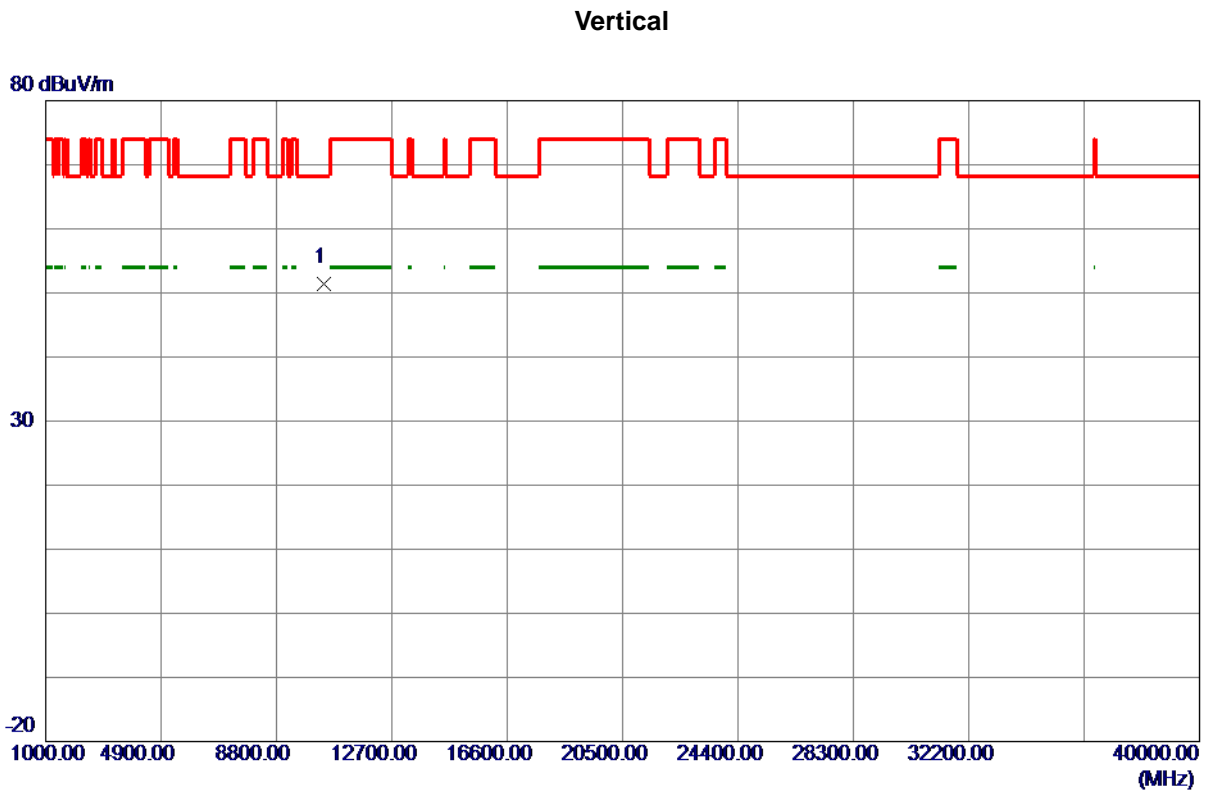

No.	Freq. MHz	Reading Level dBuV/m	Correct Factor dB	Measure ment dBuV/m	Limit dBuV/m	Margin dB	Detector	Comment
1 *	10400.0000	50.70	0.80	51.50	68.30	-16.80	Peak	

REMARKS:

- (1) Measurement Value = Reading Level + Correct Factor.
- (2) Margin Level = Measurement Value - Limit Value.

Orthogonal Axis	X
Test Mode	UNII-1_TX AC (VHT20) Mode 5200 MHz

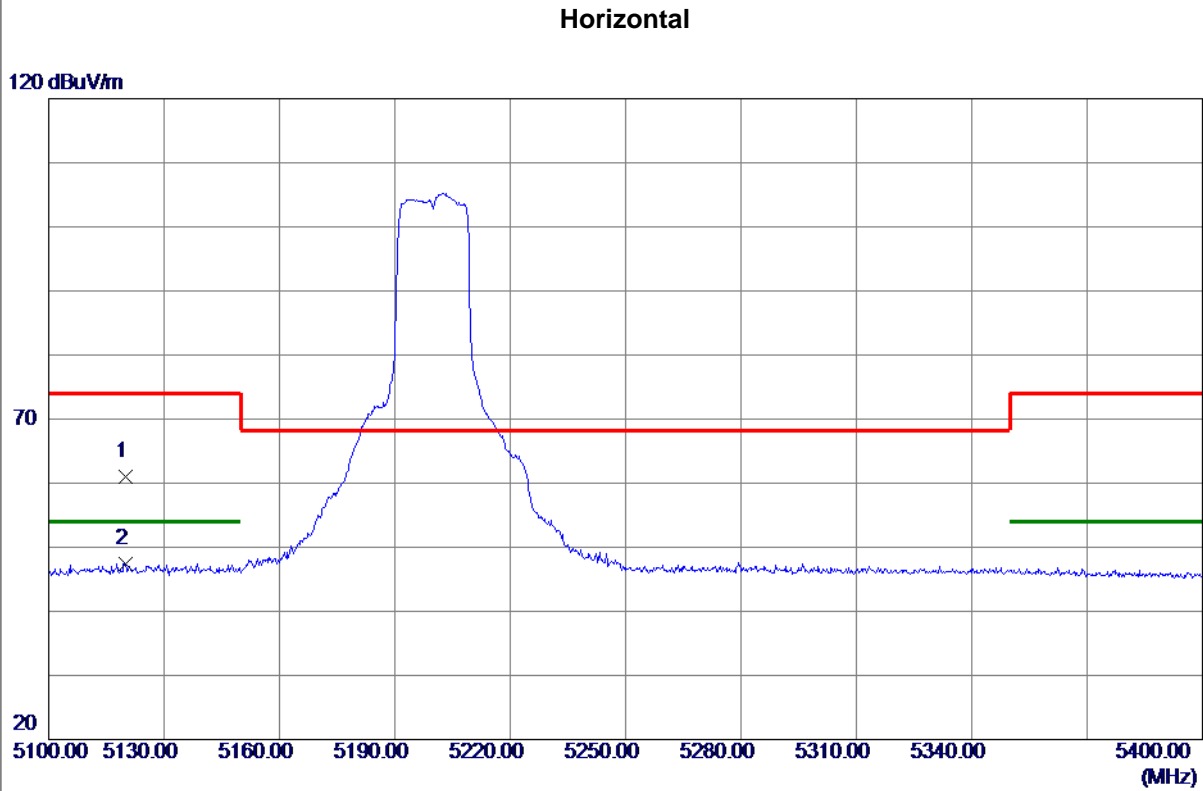

No.	Freq. MHz	Reading Level dBuV/m	Correct Factor dB	Measure ment dBuV/m	Limit dBuV/m	Margin dB	Detector	Comment
1	5119.9500	20.45	40.47	60.92	74.00	-13.08	Peak	
2 *	5119.9500	6.98	40.47	47.45	54.00	-6.55	AVG	

REMARKS:

- (1) Measurement Value = Reading Level + Correct Factor.
- (2) Margin Level = Measurement Value - Limit Value.

Orthogonal Axis	X
Test Mode	UNII-1_TX AC (VHT20) Mode 5200 MHz

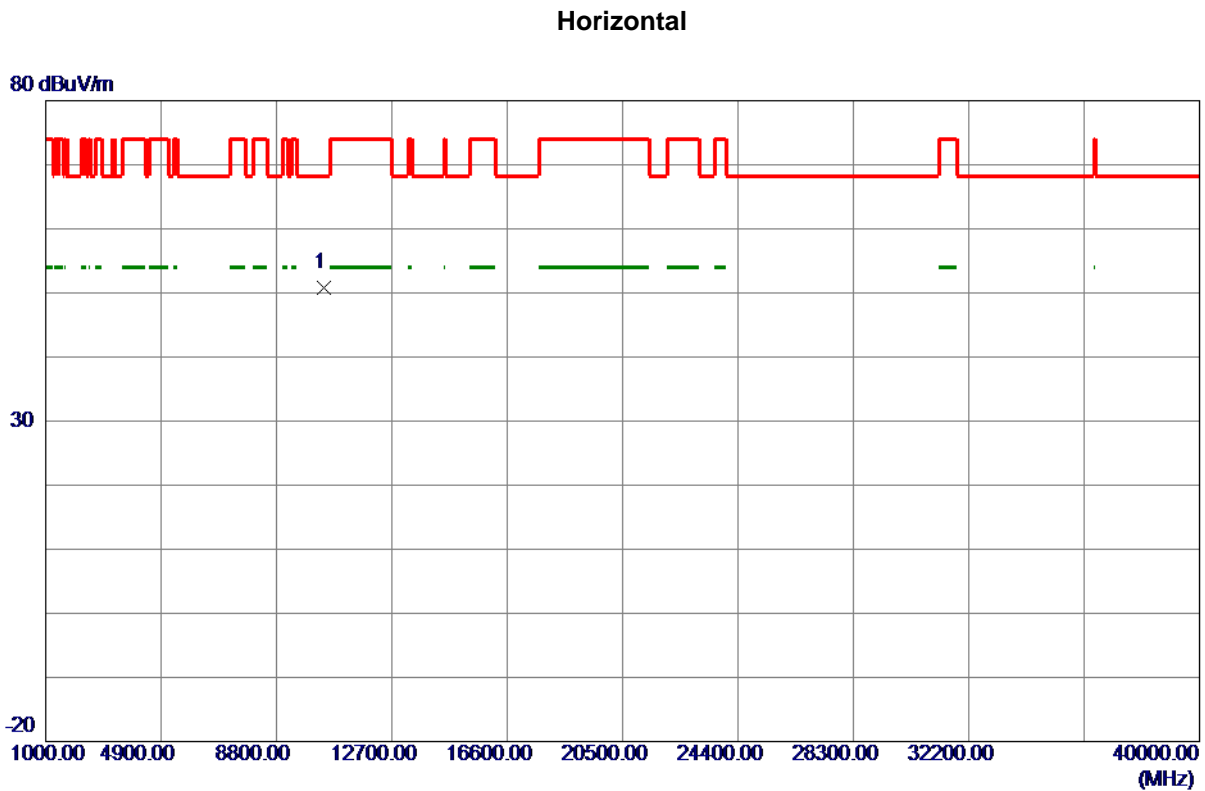

No.	Freq. MHz	Reading Level dBuV/m	Correct Factor dB	Measure ment dBuV/m	Limit dBuV/m	Margin dB	Detector	Comment
1 *	10400.0000	49.95	0.80	50.75	68.30	-17.55	Peak	

REMARKS:

- (1) Measurement Value = Reading Level + Correct Factor.
- (2) Margin Level = Measurement Value - Limit Value.

Orthogonal Axis	X
Test Mode	UNII-1_TX AC (VHT20) Mode 5240 MHz

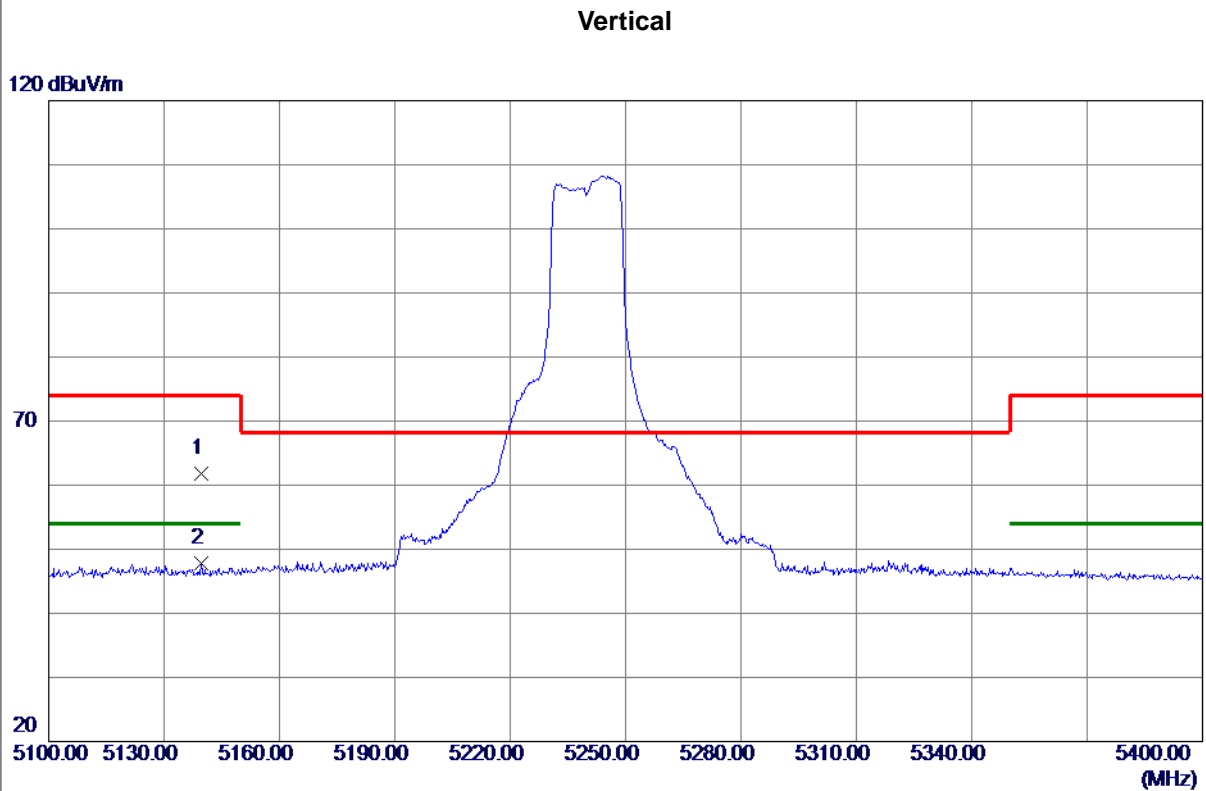

No.	Freq. MHz	Reading Level dBuV/m	Correct Factor dB	Measure ment dBuV/m	Limit dBuV/m	Margin dB	Detector	Comment
1	5139.6000	21.37	40.51	61.88	74.00	-12.12	Peak	
2 *	5139.6000	7.28	40.51	47.79	54.00	-6.21	AVG	

REMARKS:

- (1) Measurement Value = Reading Level + Correct Factor.
- (2) Margin Level = Measurement Value - Limit Value.

Orthogonal Axis	X
Test Mode	UNII-1_TX AC (VHT20) Mode 5240 MHz

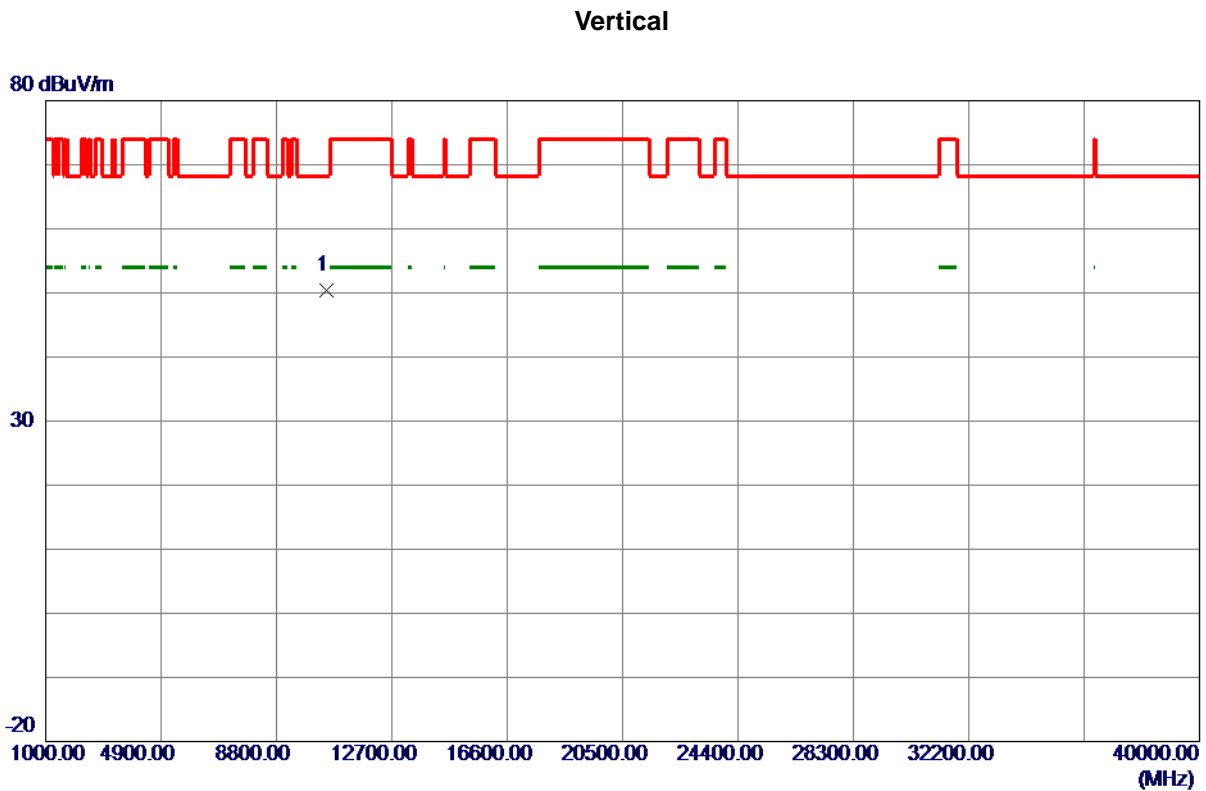

No.	Freq. MHz	Reading Level dBuV/m	Correct Factor dB	Measure ment dBuV/m	Limit dBuV/m	Margin dB	Detector	Comment
1 *	10480.0000	49.34	1.05	50.39	68.30	-17.91	Peak	

REMARKS:

- (1) Measurement Value = Reading Level + Correct Factor.
- (2) Margin Level = Measurement Value - Limit Value.

Orthogonal Axis	X
Test Mode	UNII-1_TX AC (VHT20) Mode 5240 MHz

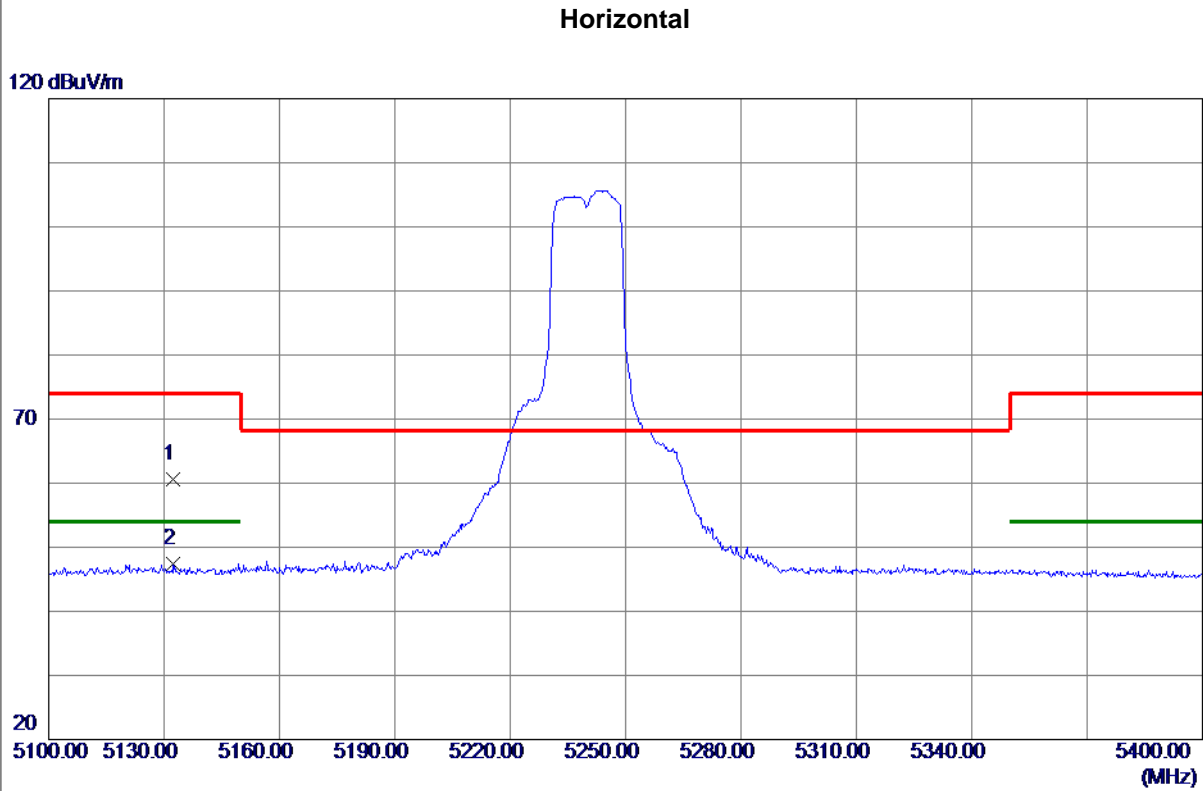

No.	Freq. MHz	Reading Level dBuV/m	Correct Factor dB	Measure ment dBuV/m	Limit dBuV/m	Margin dB	Detector	Comment
1	5132.4000	20.10	40.49	60.59	74.00	-13.41	Peak	
2 *	5132.4000	6.87	40.49	47.36	54.00	-6.64	AVG	

REMARKS:

- (1) Measurement Value = Reading Level + Correct Factor.
- (2) Margin Level = Measurement Value - Limit Value.

Orthogonal Axis	X
Test Mode	UNII-1_TX AC (VHT20) Mode 5240 MHz

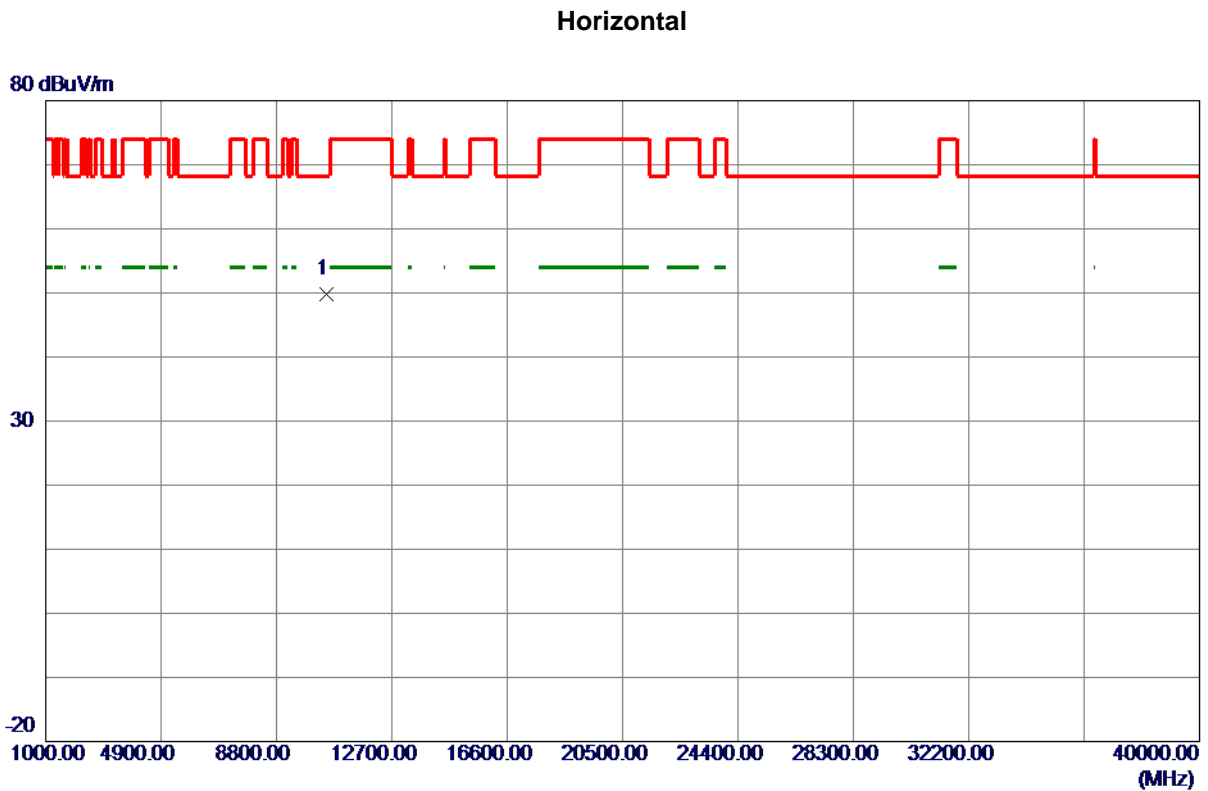

No.	Freq. MHz	Reading Level dBuV/m	Correct Factor dB	Measure ment dBuV/m	Limit dBuV/m	Margin dB	Detector	Comment
1 *	10480.0000	48.69	1.05	49.74	68.30	-18.56	Peak	

REMARKS:

- (1) Measurement Value = Reading Level + Correct Factor.
- (2) Margin Level = Measurement Value - Limit Value.

Orthogonal Axis	X
Test Mode	UNII-1_TX AC (VHT40) Mode 5190 MHz

Vertical

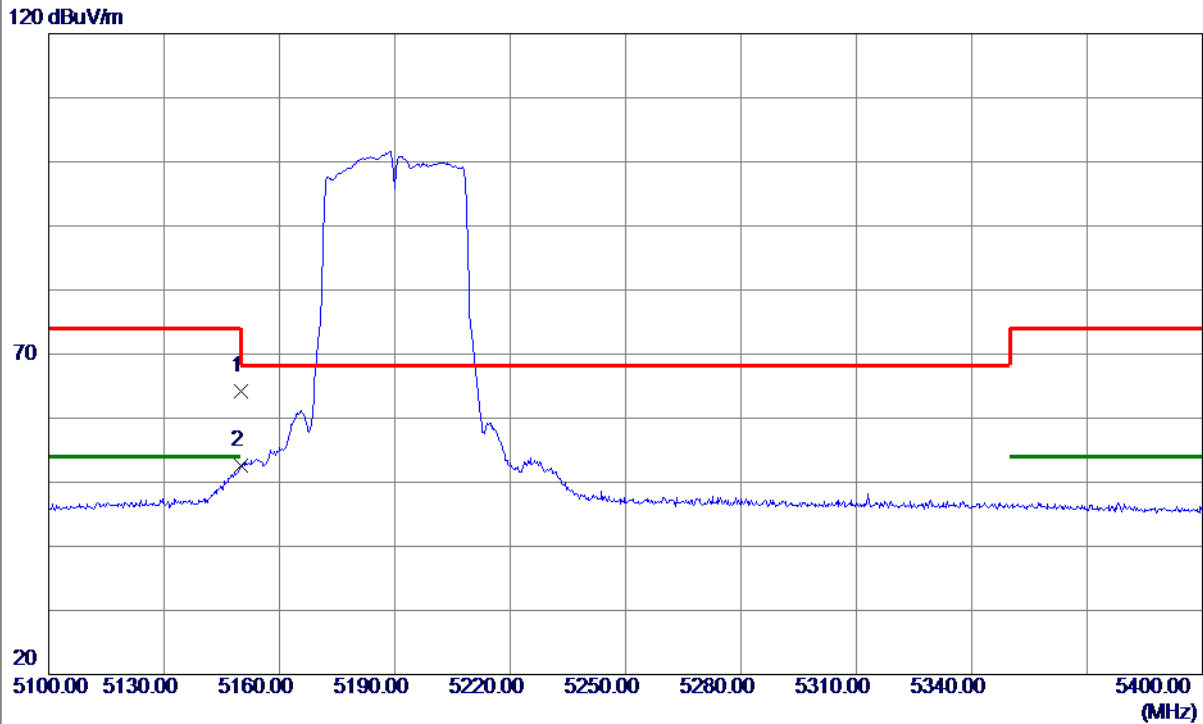

No.	Freq. MHz	Reading Level dBuV/m	Correct Factor dB	Measure ment dBuV/m	Limit dBuV/m	Margin dB	Detector	Comment
1	5150.0000	23.72	40.53	64.25	74.00	-9.75	Peak	
2 *	5150.0000	12.10	40.53	52.63	54.00	-1.37	AVG	

REMARKS:

- (1) Measurement Value = Reading Level + Correct Factor.
- (2) Margin Level = Measurement Value - Limit Value.

Orthogonal Axis	X
Test Mode	UNII-1_TX AC (VHT40) Mode 5190 MHz

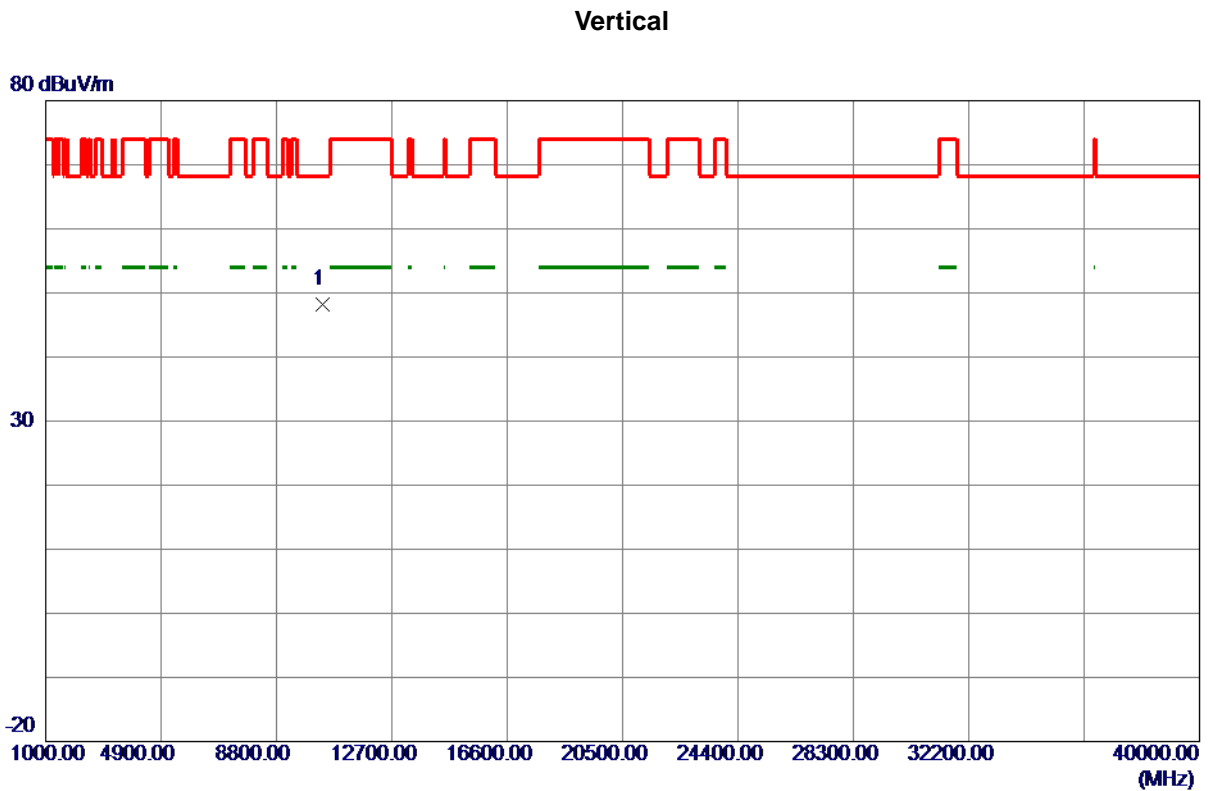

No.	Freq. MHz	Reading Level dBuV/m	Correct Factor dB	Measure ment dBuV/m	Limit dBuV/m	Margin dB	Detector	Comment
1 *	10380.0000	47.42	0.73	48.15	68.30	-20.15	Peak	

REMARKS:

- (1) Measurement Value = Reading Level + Correct Factor.
- (2) Margin Level = Measurement Value - Limit Value.

Orthogonal Axis	X
Test Mode	UNII-1_TX AC (VHT40) Mode 5190 MHz

Horizontal

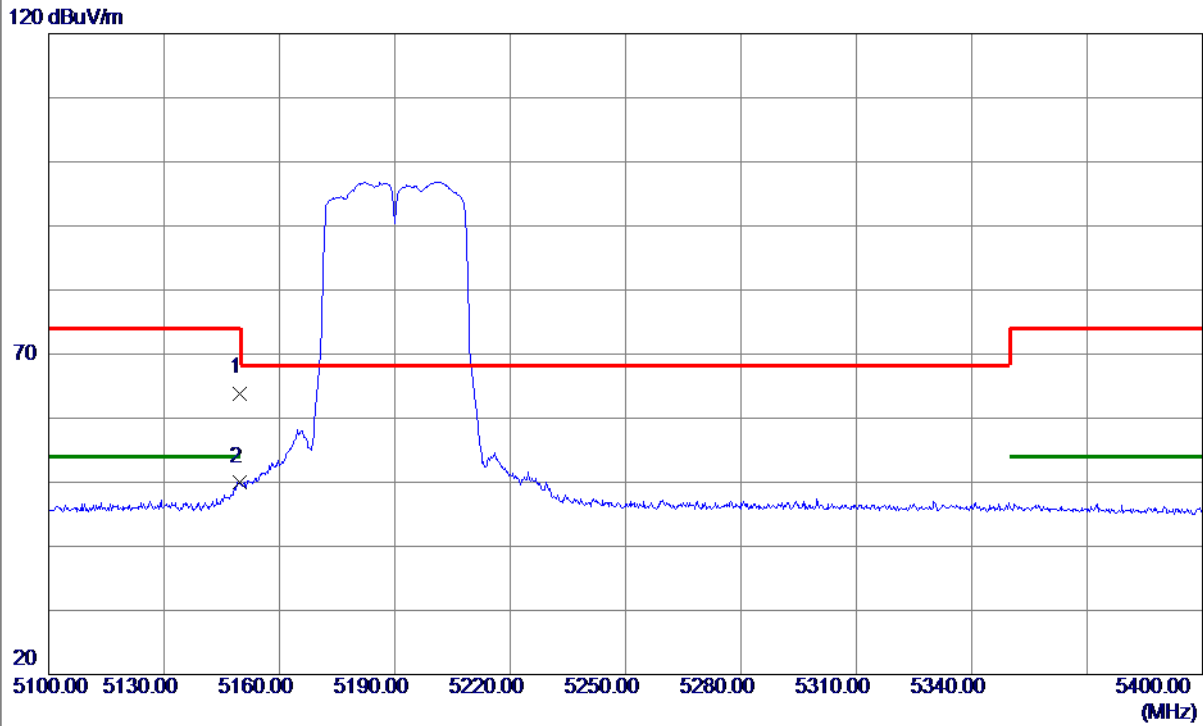

No.	Freq. MHz	Reading Level dBuV/m	Correct Factor dB	Measure ment dBuV/m	Limit dBuV/m	Margin dB	Detector	Comment
1	5149.8000	23.37	40.53	63.90	74.00	-10.10	Peak	
2 *	5149.8000	9.54	40.53	50.07	54.00	-3.93	AVG	

REMARKS:

- (1) Measurement Value = Reading Level + Correct Factor.
- (2) Margin Level = Measurement Value - Limit Value.

Orthogonal Axis	X
Test Mode	UNII-1_TX AC (VHT40) Mode 5190 MHz

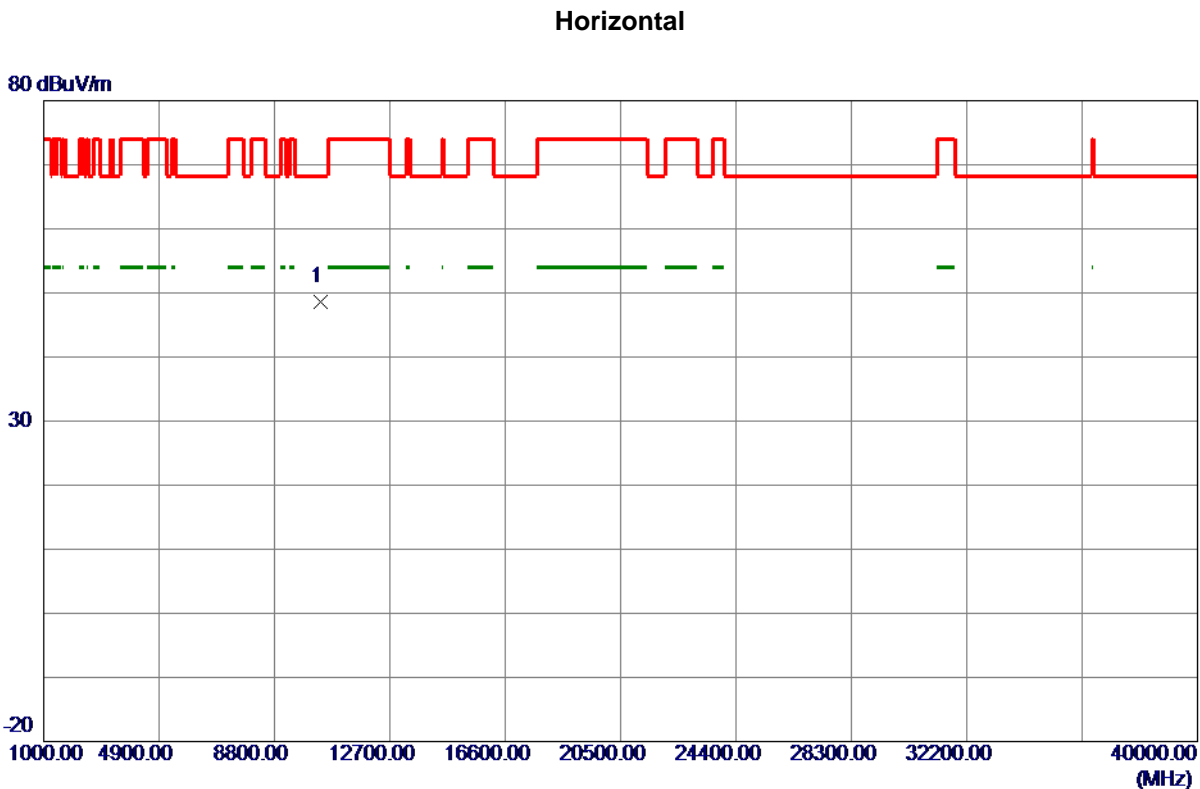

No.	Freq. MHz	Reading Level dBuV/m	Correct Factor dB	Measure ment dBuV/m	Limit dBuV/m	Margin dB	Detector	Comment
1 *	10380.0000	47.87	0.73	48.60	68.30	-19.70	Peak	

REMARKS:

- (1) Measurement Value = Reading Level + Correct Factor.
- (2) Margin Level = Measurement Value - Limit Value.

Orthogonal Axis	X
Test Mode	UNII-1_TX AC (VHT40) Mode 5230 MHz

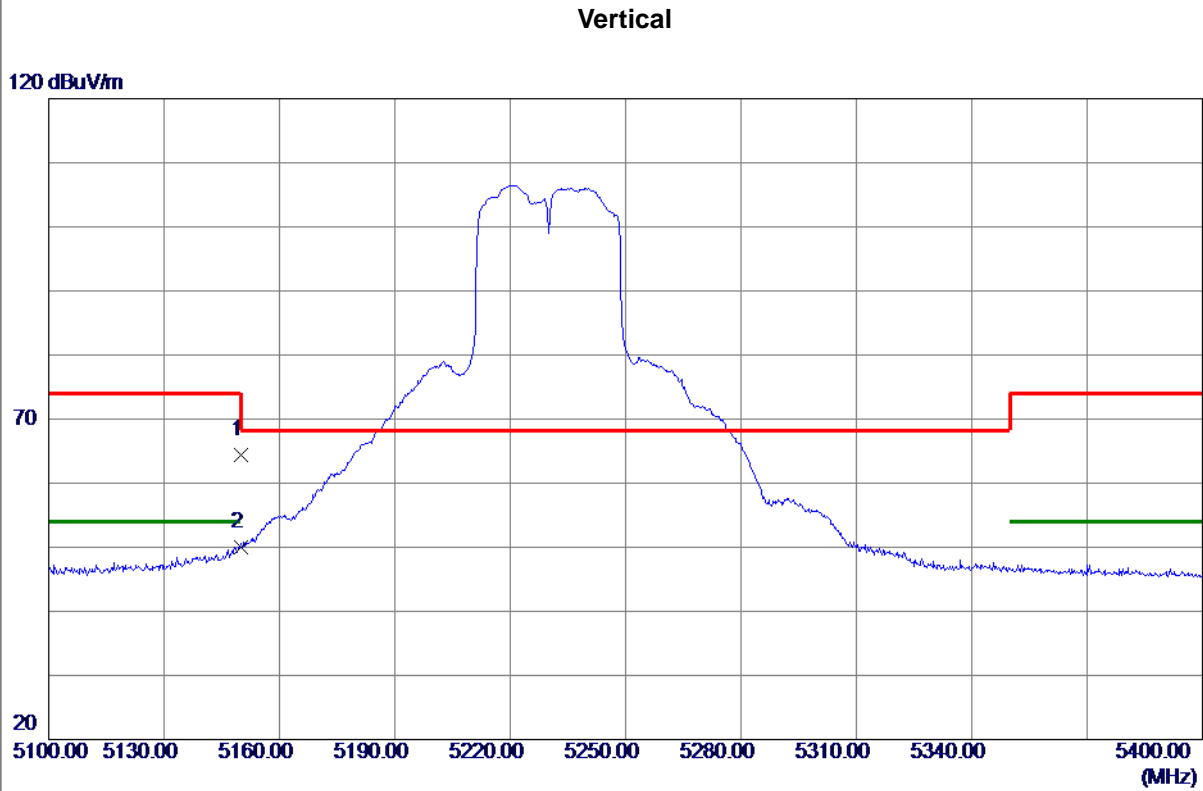

No.	Freq. MHz	Reading Level dBuV/m	Correct Factor dB	Measure ment dBuV/m	Limit dBuV/m	Margin dB	Detector	Comment
1	5150.0000	23.90	40.53	64.43	74.00	-9.57	Peak	
2 *	5150.0000	9.50	40.53	50.03	54.00	-3.97	AVG	

REMARKS:

- (1) Measurement Value = Reading Level + Correct Factor.
- (2) Margin Level = Measurement Value - Limit Value.

Orthogonal Axis	X
Test Mode	UNII-1_TX AC (VHT40) Mode 5230 MHz

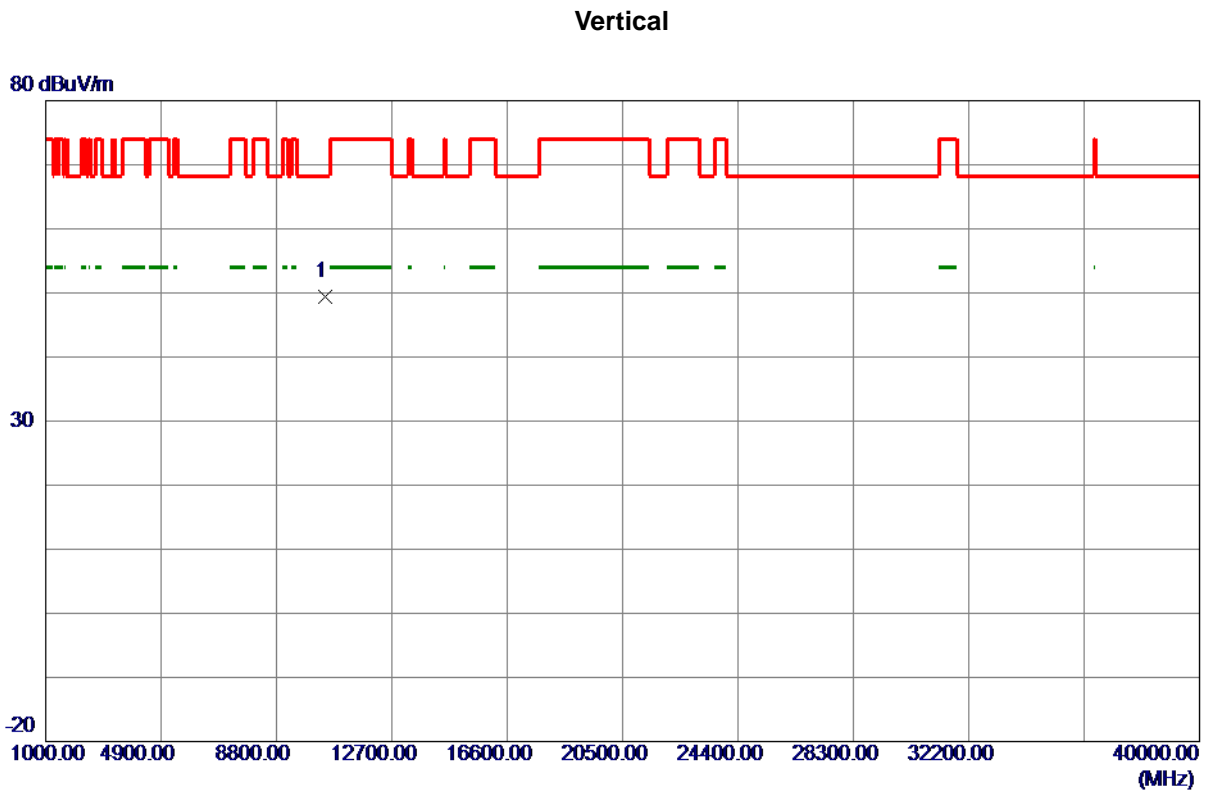

No.	Freq. MHz	Reading Level dBuV/m	Correct Factor dB	Measure ment dBuV/m	Limit dBuV/m	Margin dB	Detector	Comment
1 *	10460.0000	48.36	0.98	49.34	68.30	-18.96	Peak	

REMARKS:

- (1) Measurement Value = Reading Level + Correct Factor.
- (2) Margin Level = Measurement Value - Limit Value.