

# FCC Radio Test Report

## FCC ID: 2ACFN-QMIRO201W

This report concerns: Original Grant

**Project No.** : 2004H039  
**Equipment** : Tri-Band Mesh WiFi Satellite  
**Brand Name** : QNAP  
**Test Model** : QMiro-201W  
**Series Model** : N/A  
**Applicant** : QNAP Systems, Inc.  
**Address** : 2F, No.22, Zhongxing Road, Xizhi Distrit., New Taipei City, 221, Taiwan  
**Manufacturer** : QNAP System, Inc.  
**Address** : 2F, No.22, Zhongxing Rd, Xizhi Dist., New Taipei City, 221, Taiwan  
**Factory** : CIG Shanghai Co., Ltd., Shanghai Branch.  
**Address** : F/2,3 Building 1, No. 505 Jianguyue Road, Minhang District, Shanghai, P.R.China  
**Date of Receipt** : May. 25, 2020  
**Date of Test** : May. 25, 2020~Jun. 17, 2020  
**Issued Date** : Sep. 04, 2020  
**Report Version** : R00  
**Test Sample** : Engineering Sample No.: SH20200528127 for radiated; SH2020051457 for conducted; SH2020051457-1 for adapter  
**Standard(s)** : FCC Part15, Subpart C (15.247)  
ANSI C63.10-2013  
KDB 558074 D01 15.247 Meas Guidance v05r02

The above equipment has been tested and found compliance with the requirement of the relative standards by BTL Inc.

*Allen Wei*

Prepared by : Allen Wei

*Ryan Wang*

Approved by : Ryan Wang



Certificate # 5123. 03

Add: No. 29, Jintang Road, Tangzhen Industry Park, Pudong New Area, Shanghai 201210, China

TEL: +86-021-61765666

Web: www.newbtl.com

**Declaration**

**BTL** represents to the client that testing is done in accordance with standard procedures as applicable and that test instruments used has been calibrated with standards traceable to international standard(s) and/or national standard(s).

**BTL's** reports apply only to the specific samples tested under conditions. It is manufacture's responsibility to ensure that additional production units of this model are manufactured with the identical electrical and mechanical components. **BTL** shall have no liability for any declarations, inferences or generalizations drawn by the client or others from **BTL** issued reports.

The report must not be used by the client to claim product certification, approval, or endorsement by NVLAP, NIST, A2LA, or any agency of the U.S. Government.

This report is the confidential property of the client. As a mutual protection to the clients, the public and ourselves, the test report shall not be reproduced, except in full, without our written approval.

**BTL's** laboratory quality assurance procedures are in compliance with the **ISO/IEC 17025** requirements, and accredited by the conformity assessment authorities listed in this test report.

**BTL** is not responsible for the sampling stage, so the results only apply to the sample as received.

The information, data and test plan are provided by manufacturer which may affect the validity of results, so it is manufacturer's responsibility to ensure that the apparatus meets the essential requirements of applied standards and in all the possible configurations as representative of its intended use.

**Limitation**

For the use of the authority's logo is limited unless the Test Standard(s)/Scope(s)/Item(s) mentioned in this test report is (are) included in the conformity assessment authorities acceptance respective.

Please note that the measurement uncertainty is provided for informational purpose only and are not use in determining the Pass/Fail results.

<b>Table of Contents</b>	<b>Page</b>
<b>REPORT ISSUED HISTORY</b>	<b>6</b>
<b>1 . SUMMARY OF TEST RESULTS</b>	<b>7</b>
1.1 TEST FACILITY	8
1.2 MEASUREMENT UNCERTAINTY	8
1.3 TEST ENVIRONMENT CONDITIONS	8
<b>2 . GENERAL INFORMATION</b>	<b>9</b>
2.1 GENERAL DESCRIPTION OF EUT	9
2.2 DESCRIPTION OF TEST MODES	11
2.3 PARAMETERS OF TEST SOFTWARE	14
2.4 DUTY CYCLE	15
2.5 BLOCK DIAGRAM SHOWING THE CONFIGURATION OF SYSTEM TESTED	17
2.6 SUPPORT UNITS	17
<b>3 . AC POWER LINE CONDUCTED EMISSIONS TEST</b>	<b>18</b>
3.1 LIMIT	18
3.2 TEST PROCEDURE	18
3.3 DEVIATION FROM TEST STANDARD	18
3.4 TEST SETUP	19
3.5 EUT OPERATION CONDITIONS	19
3.6 TEST RESULTS	19
<b>4 . RADIATED EMISSIONS TEST</b>	<b>20</b>
4.1 LIMIT	20
4.2 TEST PROCEDURE	21
4.3 DEVIATION FROM TEST STANDARD	21
4.4 TEST SETUP	22
4.5 EUT OPERATION CONDITIONS	23
4.6 TEST RESULTS - 9 KHZ TO 30 MHZ	23
4.7 TEST RESULTS - 30 MHZ TO 1000 MHZ	23
4.8 TEST RESULTS - ABOVE 1000 MHZ	23
<b>5 . BANDWIDTH TEST</b>	<b>24</b>
5.1 LIMIT	24
5.2 TEST PROCEDURE	24
5.3 DEVIATION FROM STANDARD	24
5.4 TEST SETUP	24

<b>Table of Contents</b>	<b>Page</b>
5.5 EUT OPERATION CONDITIONS	24
5.6 TEST RESULTS	24
<b>6 . MAXIMUM OUTPUT POWER TEST</b>	<b>25</b>
6.1 LIMIT	25
6.2 TEST PROCEDURE	25
6.3 DEVIATION FROM STANDARD	25
6.4 TEST SETUP	25
6.5 EUT OPERATION CONDITIONS	25
6.6 TEST RESULTS	25
<b>7 . CONDUCTED SPURIOUS EMISSIONS</b>	<b>26</b>
7.1 LIMIT	26
7.2 TEST PROCEDURE	26
7.3 DEVIATION FROM STANDARD	26
7.4 TEST SETUP	26
7.5 EUT OPERATION CONDITIONS	26
7.6 TEST RESULTS	26
<b>8 . POWER SPECTRAL DENSITY TEST</b>	<b>27</b>
8.1 LIMIT	27
8.2 TEST PROCEDURE	27
8.3 DEVIATION FROM STANDARD	27
8.4 TEST SETUP	27
8.5 EUT OPERATION CONDITIONS	27
8.6 TEST RESULTS	27
<b>9 . MEASUREMENT INSTRUMENTS LIST</b>	<b>28</b>
<b>10 . EUT TEST PHOTO</b>	<b>30</b>
<b>APPENDIX A - AC POWER LINE CONDUCTED EMISSIONS</b>	<b>33</b>
<b>APPENDIX B - RADIATED EMISSION - 9 MHZ TO 30 MHZ</b>	<b>36</b>
<b>APPENDIX D - RADIATED EMISSION- ABOVE 1000 MHZ</b>	<b>40</b>
<b>APPENDIX E - BANDWIDTH</b>	<b>257</b>
<b>APPENDIX F - MAXIMUM OUTPUT POWER</b>	<b>264</b>
<b>APPENDIX G - CONDUCTED SPURIOUS EMISSIONS</b>	<b>279</b>

**Table of Contents****Page****APPENDIX H - POWER SPECTRAL DENSITY****292**

**REPORT ISSUED HISTORY**

Report Version	Description	Issued Date
R00	Original Issue.	Sep. 04, 2020

## 1. SUMMARY OF TEST RESULTS

Test procedures according to the technical standard(s):

FCC Part15, Subpart C (15.247)				
Standard(s) Section	Test Item	Test Result	Judgment	Remark
15.207	AC Power Line Conducted Emissions	APPENDIX A	N/A	-----
15.247(d) 15.205(a) 15.209(a)	Radiated Emissions	APPENDIX B APPENDIX C APPENDIX D	PASS	-----
15.247(a)(2)	Bandwidth	APPENDIX E	PASS	-----
15.247(b)(3)	Maximum Output Power	APPENDIX F	PASS	-----
15.247(d)	Conducted Spurious Emissions	APPENDIX G	PASS	-----
15.247(e)	Power Spectral Density	APPENDIX H	PASS	-----
15.203	Antenna Requirement	-----	PASS	Note(2)

Note:

- (1) "N/A" denotes test is not applicable in this test report.
- (2) The device what use a permanently attached antenna were considered sufficient to comply with the provisions of 15.203.

### 1.1 TEST FACILITY

The test facilities used to collect the test data in this report is at the location of No. 29, Jintang Road, Tangzhen Industry Park, Pudong New Area, Shanghai 201210,China  
 BTL's Test Firm Registration Number for FCC: 476765  
 BTL's Designation Number for FCC: CN1241

### 1.2 MEASUREMENT UNCERTAINTY

ISO/IEC 17025 requires that an estimate of the measurement uncertainties associated with the emissions test results be included in the report. The measurement uncertainties given below are based on a 95% confidence level (based on a coverage factor (k=2))  
 The BTL measurement uncertainty as below table:

A. Radiated emissions test:

Test Site	Method	Measurement Frequency Range	Ant. H / V	U, (dB)
SH-CB01	CISPR	9 KHz~30 MHz	V	3.79
		9 KHz~30 MHz	H	3.57
		30 MHz~200 MHz	V	4.04
		30 MHz~200 MHz	H	3.76
		200 MHz~1,000 MHz	V	4.24
		200 MHz~1,000 MHz	H	3.84
		1 GHz~18 GHz	V	4.46
		1 GHz~18 GHz	H	4.40
		18 GHz~40 GHz	V	3.95
		18 GHz~40 GHz	H	3.95

Note: Unless specifically mentioned, the uncertainty of measurement has not been taken into account to declare the compliance or non-compliance to the specification.

### 1.3 TEST ENVIRONMENT CONDITIONS

Test Item	Temperature	Humidity	Test Voltage	Tested By
AC Power Line Conducted Emissions	24°C	58%	AC 120V/60Hz	Vince Zong
Radiated Emissions-30 MHz to 1GHz	24°C	58%	AC 120V/60Hz	Vince Zong
Radiated Emissions-Above 1000 MHz	24°C	58%	AC 120V/60Hz	Bill Dong
Bandwidth	25°C	59%	AC 120V/60Hz	Bill Dong
Maximum output power & e.i.r.p.	25°C	59%	AC 120V/60Hz	Bill Dong
Conducted Spurious Emissions	25°C	59%	AC 120V/60Hz	Bill Dong
Power Spectral Density	25°C	59%	AC 120V/60Hz	Vince Zong



## 2. GENERAL INFORMATION

### 2.1 GENERAL DESCRIPTION OF EUT



Equipment	Tri-Band Mesh WiFi Satellite
Brand Name	QNAP
Test Model	QMiro-201W
Series Model	N/A
Model Difference(s)	N/A
Power Source	DC voltage supplied from AC/DC adapter. #1: A124-2120207U #2:ADS0248T-W120200
Power Rating	/#1: I/P:100-240V ~, 50-60Hz 0.6A O/P: 12V 2.0A 24W /#1: I/P:100-240V ~, 50-60Hz 0.6A O/P: 12V 2.0A
Operation Frequency	2412 MHz ~ 2462 MHz
Modulation Type	IEEE 802.11b: DSSS IEEE 802.11g: OFDM IEEE 802.11n: OFDM IEEE 802.11ac: OFDM
Bit Rate of Transmitter	IEEE 802.11b: 11/5.5/2/1 Mbps IEEE 802.11g: 54/48/36/24/18/12/9/6 Mbps IEEE 802.11n: up to 300 Mbps IEEE 802.11ac: up to 800 Mbps
Maximum Output Power CDD	IEEE 802.11b: 27.45 dBm (0.5559 W) IEEE 802.11g: 25.98 dBm (0.3963 W) IEEE 802.11n (HT20): 26.15 dBm (0.4121 W) IEEE 802.11n (HT40): 21.38 dBm (0.1374 W) IEEE 802.11ac (VHT20): 26.12 dBm (0.4100 W) IEEE 802.11ac (VHT40): 22.37 dBm (0.1726 W)
Maximum Output Power Beamforming	IEEE 802.11b: 27.35 dBm (0.5433 W) IEEE 802.11g: 25.90 dBm (0.3890 W) IEEE 802.11n (HT20): 26.03 dBm (0.4009 W) IEEE 802.11n (HT40): 21.27 dBm (0.1340 W) IEEE 802.11ac (VHT20): 26.28 dBm (0.4246 W) IEEE 802.11ac (VHT40): 24.03 dBm (0.2529 W)

Note:

- For a more detailed features description, please refer to the manufacturer's specifications or the user's manual.
- Channel List:

CH01 - CH11 for IEEE 802.11b, IEEE 802.11g, IEEE 802.11n (HT20) CH03 - CH09 for IEEE 802.11n (HT40)							
Channel	Frequency (MHz)	Channel	Frequency (MHz)	Channel	Frequency (MHz)	Channel	Frequency (MHz)
01	2412	04	2427	07	2442	10	2457
02	2417	05	2432	08	2447	11	2462
03	2422	06	2437	09	2452		

## 3. Antenna Specification:

Ant.	Brand	Model Name	Antenna Type	Connector	Gain (dBi)	Note
1		N/A	PCB	N/A	4.6	N/A
2		N/A	PCB	N/A	2.7	N/A

Note:

This EUT supports Beamforming and CDD, all antennas have the same gain, any transmit signals are correlated with each other, so

## 1) Beamforming:

$$\text{Directional gain} = 10\log[(10^{G1/20} + 10^{G2/20} + \dots + 10^{GN/20})^2 / N_{\text{ANT}}] \text{dBi},$$

that is Directional gain =  $10\log[(10^{G1/20} + 10^{G2/20} + \dots + 10^{GN/20})^2 / N_{\text{ANT}}] \text{dBi} = 6.71$ ;

So output power limit is  $30 - 6.71 + 6 = 29.29$ , the power spectral density limit is  $8 - 6.71 + 6 = 7.29$ .

## 2) CDD:

For power spectral density measurements,

$$\text{Directional gain} = 10\log[(10^{G1/20} + 10^{G2/20} + \dots + 10^{GN/20})^2 / N_{\text{ANT}}] \text{dBi},$$

that is Directional gain =  $10\log[(10^{G1/20} + 10^{G2/20} + \dots + 10^{GN/20})^2 / N_{\text{ANT}}] \text{dBi} = 6.71$ ;

So power spectral density limit is  $8 - 6.71 + 6 = 7.29$ .

For power measurements, Directional gain =  $G_{\text{ANT MAX.}} + \text{Array Gain}$ , Array Gain =  $0\text{dB} (N_{\text{ANT}} \leq 4)$ , so the Directional gain =  $4.6$ .

## 4. Table for Antenna Configuration:

Operating Mode TX Mode	Ant. 1	Ant. 2	Ant. 1+2
	IEEE 802.11b	✓	✓
IEEE 802.11g	✓	✓	✓
IEEE 802.11n (HT20)	✓	✓	✓
IEEE 802.11n (HT40)	✓	✓	✓
IEEE 802.11ac (VHT20)	✓	✓	✓
IEEE 802.11ac (VHT40)	✓	✓	✓

## 2.2 DESCRIPTION OF TEST MODES

The test system was pre-tested based on the consideration of all possible combinations of EUT operation mode.

Pretest Mode	Description
Mode 1	TX B Mode Channel 01/06/11
Mode 2	TX G Mode Channel 01/06/11
Mode 3	TX N-20 MHz Mode Channel 01/06/11
Mode 4	TX N-40 MHz Mode Channel 03/06/09
Mode 5	TX AC-20 MHz Mode Channel 01/06/11
Mode 6	TX AC-40 MHz Mode Channel 03/06/09
Mode 7	TX B Mode Channel 06

Following mode(s) as (were) found to be the worst case(s) and selected for the final test.

<b>AC power line conducted emissions test</b>	
Final Test Mode:	Description
Mode 5	TX B Mode Channel 06

<b>Radiated emissions test - Below 1GHz</b>	
Final Test Mode:	Description
Mode 5	TX B Mode Channel 06

<b>Radiated emissions test- Above 1GHz</b>	
Final Test Mode:	Description
Mode 1	TX B Mode Channel 01/06/11
Mode 2	TX G Mode Channel 01/06/11
Mode 3	TX N-20 MHz Mode Channel 01/06/11
Mode 4	TX N-40 MHz Mode Channel 03/06/09
Mode 5	TX AC-20 MHz Mode Channel 01/06/11
Mode 6	TX AC-40 MHz Mode Channel 03/06/09

<b>Conducted test</b>	
Final Test Mode:	Description
Mode 1	TX B Mode Channel 01/06/11
Mode 2	TX G Mode Channel 01/06/11
Mode 3	TX N-20 MHz Mode Channel 01/06/11
Mode 4	TX N-40 MHz Mode Channel 03/06/09
Mode 5	TX AC-20 MHz Mode Channel 01/06/11
Mode 6	TX AC-40 MHz Mode Channel 03/06/09

**NOTE:**

- (1) The measurements are performed at the high, middle, low available channels.
- (2) 802.11b mode: CCK (1 Mbps)  
802.11g mode: OFDM (6 Mbps)  
802.11n HT20 mode : BPSK (13 Mbps)  
802.11n HT40 mode : BPSK (27 Mbps)  
For radiated emission tests, the highest output powers were set for final test.
- (3) For radiated emission below 1 GHz test, the IEEE 802.11b Channel 06 is found to be the worst case and recorded.
- (4) For radiated emission above 1 GHz test, 1GHz~26.5GHz have been pre-tested and in this report only recorded the worst case. The remaining spurious points are all below the limit value of 20dB.

### 2.3 PARAMETERS OF TEST SOFTWARE

#### CDD

Test Software	QRCT		
Frequency (MHz)	2412	2437	2462
IEEE 802.11b	23	24	23
IEEE 802.11g	17	23	17
IEEE 802.11n (HT20)	15.5	23	16.5
IEEE 802.11 ac (VHT20)	16	23	17
Frequency (MHz)	2422	2437	2452
IEEE 802.11n (HT40)	14.5	18	15
IEEE 802.11 ac (VHT40)	14	19	16

#### Beamforming

Test Software	QRCT		
Frequency (MHz)	2412	2437	2462
IEEE 802.11b	23	24	23
IEEE 802.11g	17	23	17
IEEE 802.11n (HT20)	15.5	23	16.5
IEEE 802.11 ac (VHT20)	16	23	17
Frequency (MHz)	2422	2437	2452
IEEE 802.11n (HT40)	14.5	18	15
IEEE 802.11 ac (VHT40)	14	19	16

## 2.4 DUTY CYCLE

If duty cycle is  $\geq 98\%$ , duty factor is not required.  
 If duty cycle is  $< 98\%$ , duty factor shall be considered.  
 The output power = measured power + duty factor.

**IEEE 802.11b**

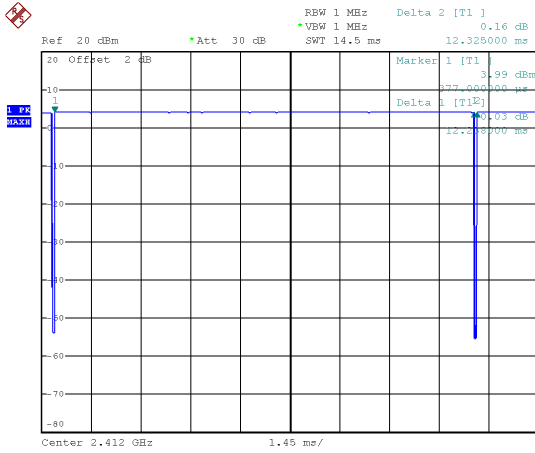

**IEEE 802.11g**

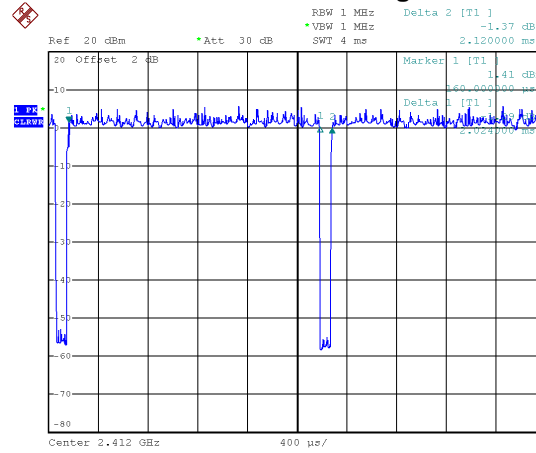

Date: 27.MAY.2020 17:14:59

Duty cycle =  $12.238 \text{ ms} / 12.325 \text{ ms} = 99.29\%$   
 Duty Factor =  $10 \log(1/\text{Duty cycle}) = 0.00$

Date: 27.MAY.2020 17:15:43

Duty cycle =  $2.024 \text{ ms} / 2.120 \text{ ms} = 95.47\%$   
 Duty Factor =  $10 \log(1/\text{Duty cycle}) = 0.20$

**IEEE 802.11n (HT20)**

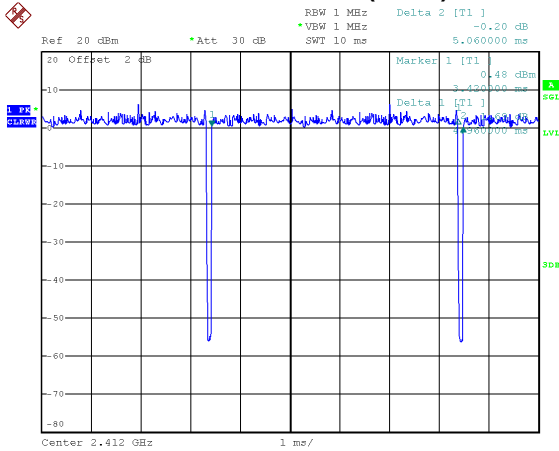

**IEEE 802.11n (HT40)**

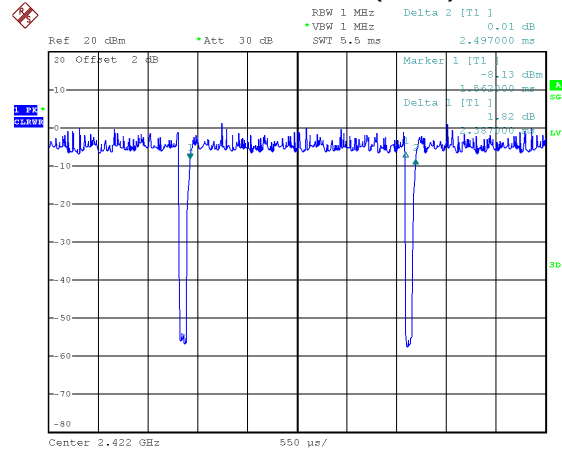

Date: 27.MAY.2020 17:16:20

Duty cycle =  $4.960 \text{ ms} / 5.060 \text{ ms} = 98.02\%$   
 Duty Factor =  $10 \log(1/\text{Duty cycle}) = 0.00$

Date: 27.MAY.2020 17:16:56

Duty cycle =  $2.387 \text{ ms} / 2.497 \text{ ms} = 95.59\%$   
 Duty Factor =  $10 \log(1/\text{Duty cycle}) = 0.20$

## IEEE 802.11ac (HT20)

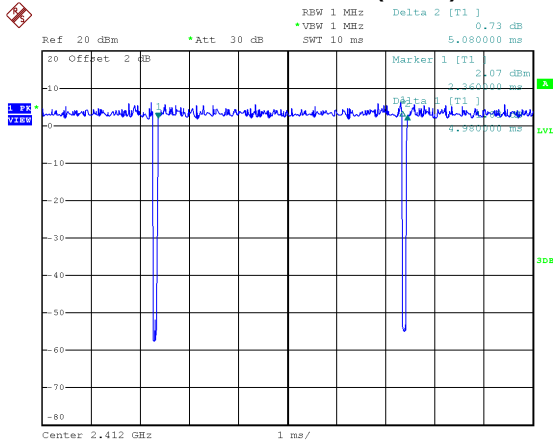

## IEEE 802.11 ac (HT20)

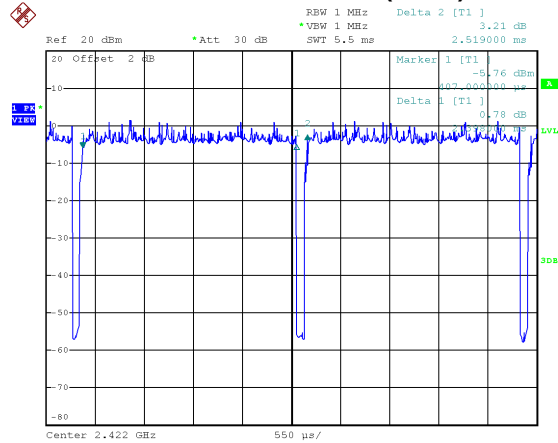

Date: 18.JUN.2020 14:02:02

Duty cycle = 4.980 ms / 5.080 ms = 98.03%  
 Duty Factor = 10 log(1/Duty cycle) = 0.00,

Date: 18.JUN.2020 14:06:41

Duty cycle = 2.398 ms / 2.519 ms = 95.20%  
 Duty Factor = 10 log(1/Duty cycle) = 0.214,

**NOTE:**

For IEEE 802.11g and IEEE 802.11n (HT20):

For radiated emissions frequency above 1 GHz, the resolution bandwidth of test receiver/spectrum analyzer is 1 MHz and the video bandwidth is 1 kHz (Duty cycle < 98%).

For IEEE 802.11n (HT40):

For radiated emissions frequency above 1 GHz, the resolution bandwidth of test receiver/spectrum analyzer is 1 MHz and the video bandwidth is 2 kHz (Duty cycle < 98%).



## 2.5 BLOCK DIAGRAM SHOWING THE CONFIGURATION OF SYSTEM TESTED

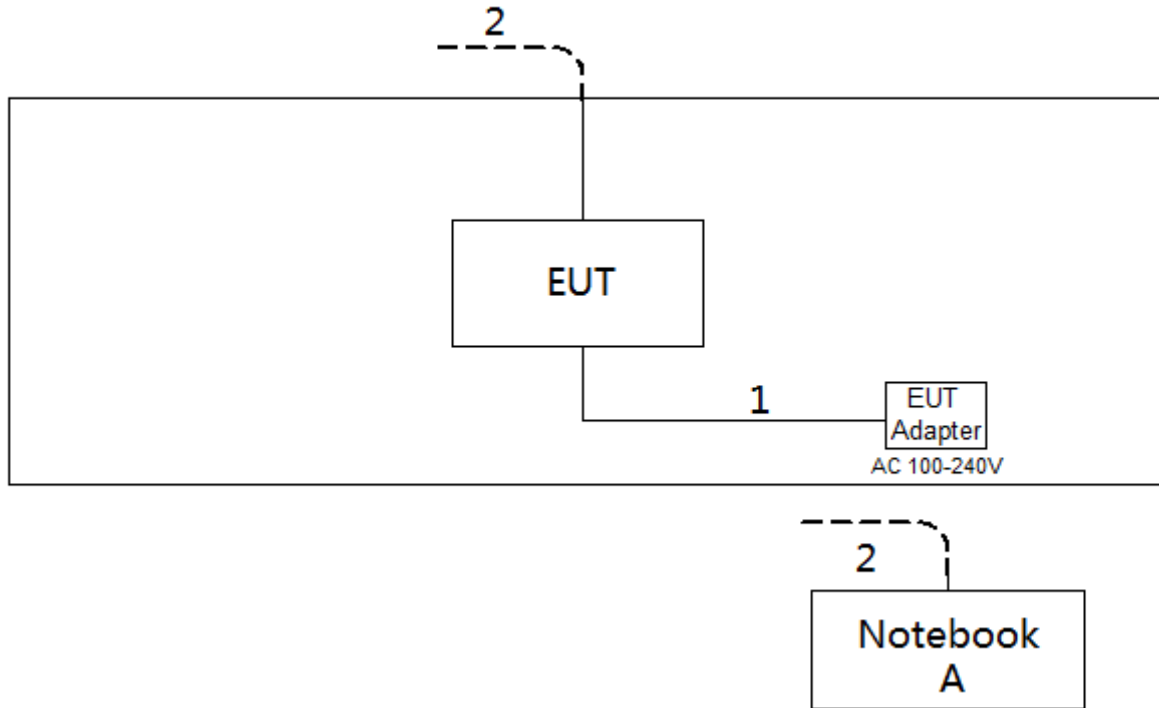

## 2.6 SUPPORT UNITS

Item	Equipment	Brand	Model No.	Series No.
A	Notebook	Dell	Inspiron 15-7559	N/A

Item	Cable Type	Shielded Type	Ferrite Core	Length
1	DC Cable	NO	NO	1.5m
2	RJ45 Cable	NO	NO	10m

### 3. AC POWER LINE CONDUCTED EMISSIONS TEST

#### 3.1 LIMIT

Frequency of Emission (MHz)	Limit (dB $\mu$ V)	
	Quasi-peak	Average
0.15 - 0.50	66 to 56*	56 to 46*
0.50 - 5.0	56	46
5.0 - 30.0	60	50

**NOTE:**

- (1) The tighter limit applies at the band edges.
- (2) The limit of " \* " marked band means the limitation decreases linearly with the logarithm of the frequency in the range.

The following table is the setting of the receiver

Receiver Parameters	Setting
Attenuation	10 dB
Start Frequency	0.15 MHz
Stop Frequency	30 MHz
IF Bandwidth	9 kHz

#### 3.2 TEST PROCEDURE

- a. The EUT was placed 0.8 meters from the horizontal ground plane with EUT being connected to the power mains through a line impedance stabilization network (LISN). All other support equipment powered from additional LISN(s). The LISN provide 50 Ohm/ 50uH of coupling impedance for the measuring instrument.
- b. Interconnecting cables that hang closer than 40 cm to the ground plane shall be folded back and forth in the center forming a bundle 30 to 40 cm long.
- c. I/O cables that are not connected to a peripheral shall be bundled in the center. The end of the cable may be terminated, if required, using the correct terminating impedance. The overall length shall not exceed 1 m.
- d. LISN at least 80 cm from nearest part of EUT chassis.
- e. For the actual test configuration, please refer to the related Item -EUT Test Photos.

#### 3.3 DEVIATION FROM TEST STANDARD

No deviation

### 3.4 TEST SETUP

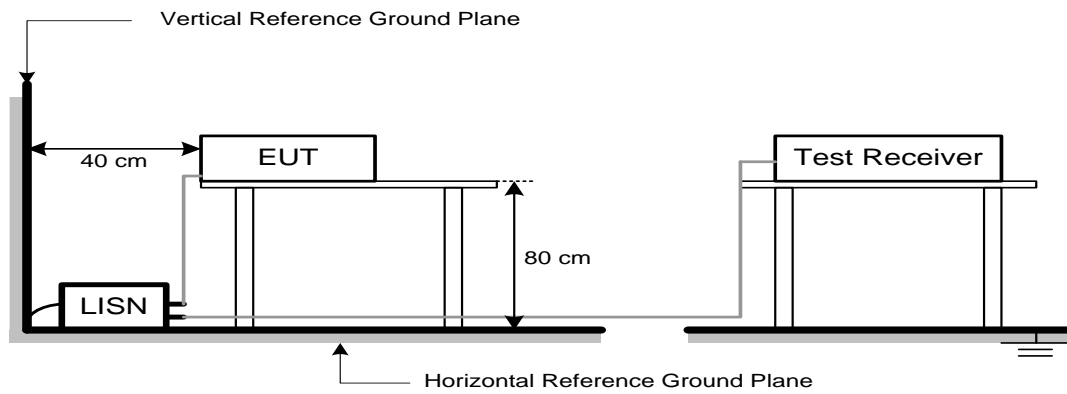

### 3.5 EUT OPERATION CONDITIONS

EUT was programmed to be in continuously transmitting mode.

### 3.6 TEST RESULTS

Please refer to the APPENDIX A.

## 4. RADIATED EMISSIONS TEST

### 4.1 LIMIT

In case the emission fall within the restricted band specified on 15.205(a), then the 15.209(a) limit in the table below has to be followed.

#### LIMITS OF RADIATED EMISSION MEASUREMENT (9 kHz-1000 MHz)

Frequency (MHz)	Field Strength (microvolts/meter)	Measurement Distance (meters)
0.009-0.490	2400/F(kHz)	300
0.490-1.705	24000/F(kHz)	30
1.705-30.0	30	30
30-88	100	3
88-216	150	3
216-960	200	3
Above 960	500	3

#### LIMITS OF RADIATED EMISSION MEASUREMENT (Above 1000 MHz)

Frequency (MHz)	Band edge/ Harmonic at 3m (dB $\mu$ V/m)	
	Peak	Average
Above 1000	74	54

#### NOTE:

- (1) The limit for radiated test was performed according to FCC PART 15C.
- (2) The tighter limit applies at the band edges.
- (3) Emission level (dB $\mu$ V/m)=20log Emission level (uV/m).
- (4) The test result calculated as following:  
 Measurement Value = Reading Level + Correct Factor  
 Correct Factor = Antenna Factor + Cable Loss - Amplifier Gain(if use)  
 Margin Level = Measurement Value - Limit Value

Spectrum Parameter	Setting
Attenuation	Auto
Start Frequency	1000 MHz
Stop Frequency	10th carrier harmonic
RBW / VBW (Emission in restricted band)	1 MHz / 3 MHz for Peak, 1 MHz / 1/T for Average

Receiver Parameter	Setting
Attenuation	Auto
Start ~ Stop Frequency	9 kHz~90 kHz for PK/AVG detector
Start ~ Stop Frequency	90 kHz~110 kHz for QP detector
Start ~ Stop Frequency	110 kHz~490 kHz for PK/AVG detector
Start ~ Stop Frequency	490 kHz~30 MHz for QP detector
Start ~ Stop Frequency	30 MHz~1000 MHz for QP detector

#### 4.2 TEST PROCEDURE

- a. The measuring distance of 3 m shall be used for measurements. The EUT was placed on the top of a rotating table 0.8 meter above the ground at a 3 meter semi-anechoic chamber. The table was rotated 360 degrees to determine the position of the highest radiation.(below 1 GHz)
- b. The measuring distance of 3 m or 1.5m shall be used for measurements. The EUT was placed on the top of a rotating table 1.5 meter above the ground at a 3 meter semi-anechoic chamber. The table was rotated 360 degrees to determine the position of the highest radiation.(above 1GHz)
- c. The height of the equipment or of the substitution antenna shall be 0.8m or 1.5m; the height of the test antenna shall vary between 1 m to 4 m. Both horizontal and vertical polarizations of the antenna are set to make the measurement.
- d. For each suspected emission, the EUT was arranged to its worst case and then the antenna was tuned to heights find the maximum reading (used Bore sight function).
- e. The receiver system was set to peak and average detect function and specified bandwidth with maximum hold mode when the test frequency is above 1 GHz.
- f. The initial step in collecting radiated emission data is a receiver peak detector mode pre-scanning the measurement frequency range. Significant peaks are then marked and then Quasi Peak detector mode re-measured.
- g. All readings are Peak unless otherwise stated QP in column of Note. Peak denotes that the Peak reading compliance with the QP Limits and then QP Mode measurement didn't perform.  
(below 1 GHz)
- h. All readings are Peak Mode value unless otherwise stated AVG in column of Note. If the Peak Mode Measured value compliance with the Peak Limits and lower than AVG Limits, the EUT shall be deemed to meet both Peak & AVG Limits and then only Peak Mode was measured, but AVG Mode didn't perform. (above 1 GHz)
- i. For the actual test configuration, please refer to the related Item -EUT Test Photos.

#### 4.3 DEVIATION FROM TEST STANDARD

No deviation

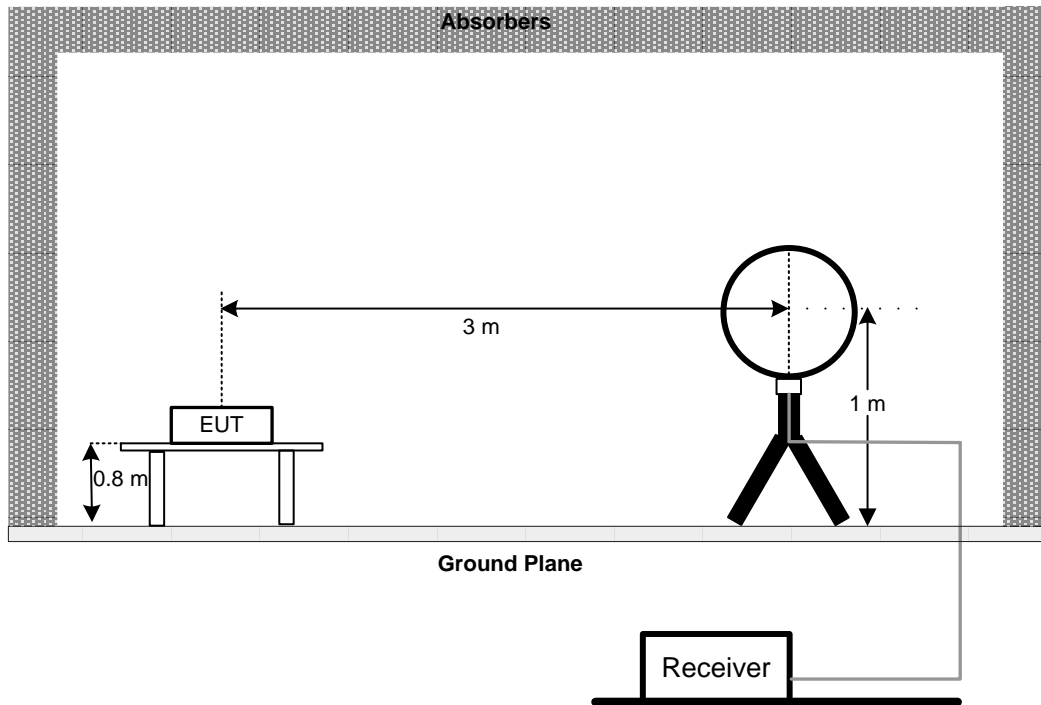
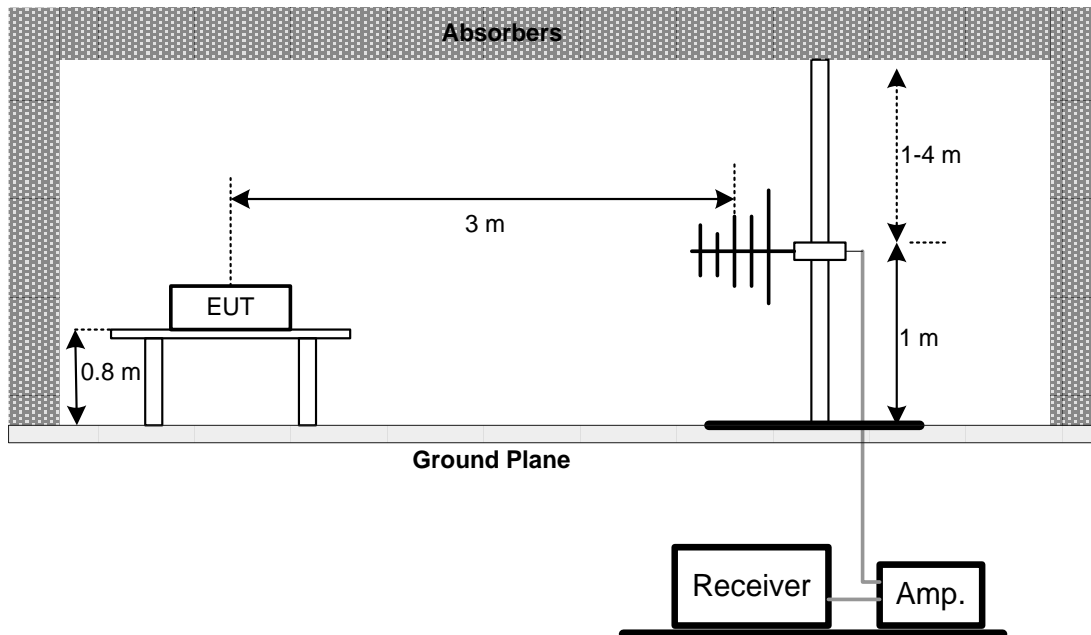
**4.4 TEST SETUP****9 kHz-30 MHz****30 MHz to 1 GHz**

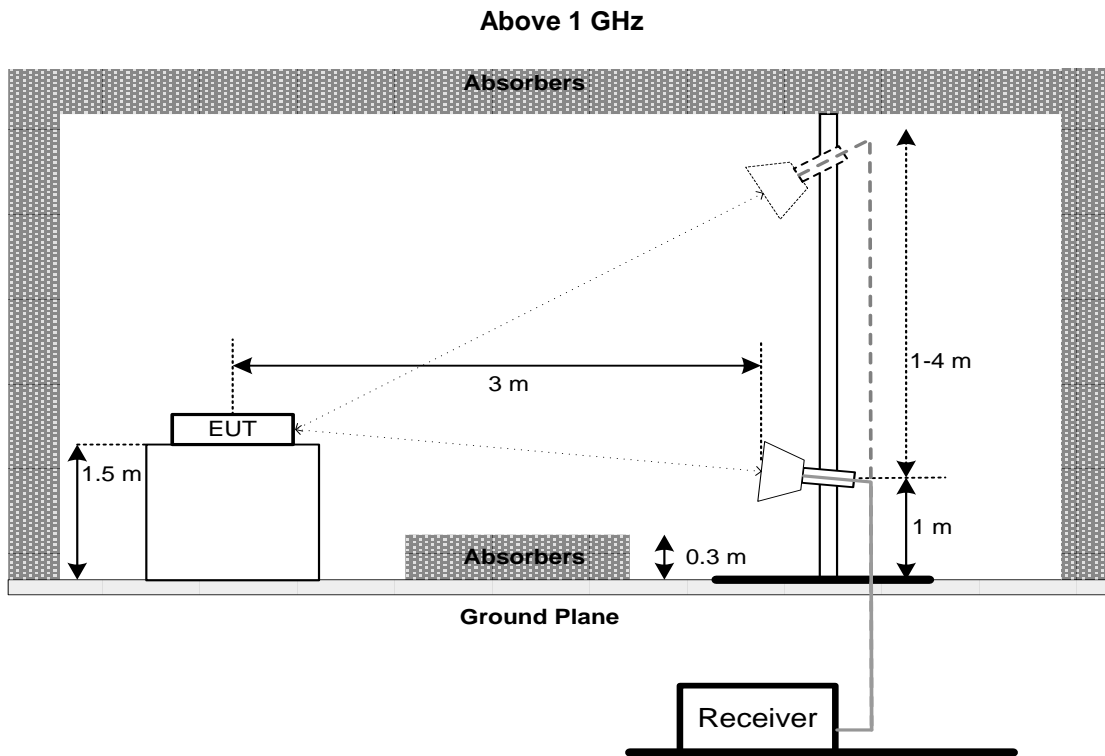

#### 4.5 EUT OPERATION CONDITIONS

The EUT was programmed to be in continuously transmitting mode.

#### 4.6 TEST RESULTS - 9 KHZ TO 30 MHZ

Please refer to the APPENDIX B

Remark:

- (1) Distance extrapolation factor =  $40 \log (\text{specific distance} / \text{test distance})$  (dB).
- (2) Limit line = specific limits (dBuV) + distance extrapolation factor.

#### 4.7 TEST RESULTS - 30 MHZ TO 1000 MHZ

Please refer to the APPENDIX C.

#### 4.8 TEST RESULTS - ABOVE 1000 MHZ

Please refer to the APPENDIX D.

Remark:

- (1) No limit: This is fundamental signal, the judgment is not applicable.  
For fundamental signal judgment was referred to Peak output test.

## 5. BANDWIDTH TEST

### 5.1 LIMIT

FCC Part15, Subpart C (15.247)		
Section	Test Item	Limit
15.247(a)(2)	6 dB Bandwidth	Minimum 500 kHz
	99% Emission Bandwidth	-

### 5.2 TEST PROCEDURE

- a. The EUT was directly connected to the spectrum analyzer and antenna output port as show in the block diagram below.
- b. Spectrum Setting:
  - For 6 dB Bandwidth : RBW= 100 kHz, VBW=300 kHz, Sweep time = auto.
  - For 99% Emission Bandwidth B/G/N-20 Mode: RBW= 300 KHz, VBW=1 MHz, Sweep time = 2.5 ms.
  - For 99% Emission Bandwidth N-40 Mode: RBW= 1 MHz, VBW=3 MHz, Sweep time = 2.5 ms.
- c. The bandwidth was performed in accordance with method 11.8.1 of ANSI C63.10-2013.

### 5.3 DEVIATION FROM STANDARD

No deviation.

### 5.4 TEST SETUP



### 5.5 EUT OPERATION CONDITIONS

The EUT was programmed to be in continuously transmitting mode.

### 5.6 TEST RESULTS

Please refer to the APPENDIX E.



## 6. MAXIMUM OUTPUT POWER TEST

### 6.1 LIMIT

FCC Part15, Subpart C (15.247)		
Section	Test Item	Limit
15.247(b)(3)	Maximum Output Power	1 Watt or 30dBm

### 6.2 TEST PROCEDURE

- The EUT was directly connected to the power meter and antenna output port as show in the block diagram below.
- The maximum conducted output power was performed in accordance with method 11.9.1.3 (for peak power) or 11.9.2.3.1 (for AVG power) of ANSI C63.10-2013 and FCC KDB 662911 D01 v02r01 Multiple Transmitter Output.

### 6.3 DEVIATION FROM STANDARD

No deviation.

### 6.4 TEST SETUP



### 6.5 EUT OPERATION CONDITIONS

The EUT was programmed to be in continuously transmitting mode.

### 6.6 TEST RESULTS

Please refer to the APPENDIX F.

## 7. CONDUCTED SPURIOUS EMISSIONS

### 7.1 LIMIT

In any 100 kHz bandwidth outside the frequency band in which the spread spectrum or digitally modulated intentional radiator is operating, the radio frequency power that is produced by the intentional radiator shall be at least 20 dB below that in the 100 kHz bandwidth within the band that contains the highest level of the desired power, based on either an RF conducted or a radiated measurement, provided the transmitter demonstrates compliance with the peak Output Power limits. If the transmitter complies with the Output Power limits based on the use of RMS averaging over a time interval, as permitted under paragraph (b)(3) of this section, the attenuation required under this paragraph shall be 30 dB instead of 20 dB. Attenuation below the general limits specified in Section 15.209(a) is not required.

### 7.2 TEST PROCEDURE

- a. The EUT was directly connected to the spectrum analyzer and antenna output port as show in the block diagram below.
- b. Spectrum Setting: RBW= 100 kHz, VBW=300 kHz, Sweep time = Auto.

### 7.3 DEVIATION FROM STANDARD

No deviation.

### 7.4 TEST SETUP

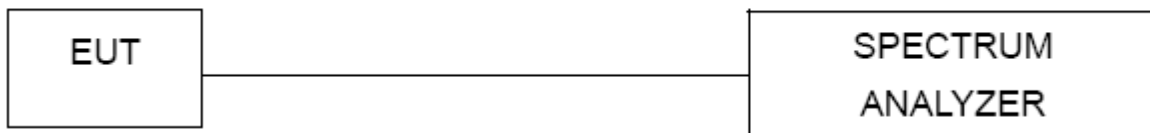

### 7.5 EUT OPERATION CONDITIONS

The EUT was programmed to be in continuously transmitting mode.

### 7.6 TEST RESULTS

Please refer to the APPENDIX G.

## 8. POWER SPECTRAL DENSITY TEST

### 8.1 LIMIT

FCC Part15, Subpart C (15.247)		
Section	Test Item	Limit
15.247(e)	Power Spectral Density	8 dBm (in any 3 kHz)

### 8.2 TEST PROCEDURE

- The EUT was directly connected to the spectrum analyzer and antenna output port as show in the block diagram below.
- Spectrum Setting: RBW=3 kHz, VBW=10 kHz, Sweep time = Auto.
- The Power Spectral Density was performed in accordance with method 11.10.2 of ANSI C63.10-2013.

### 8.3 DEVIATION FROM STANDARD

No deviation.

### 8.4 TEST SETUP

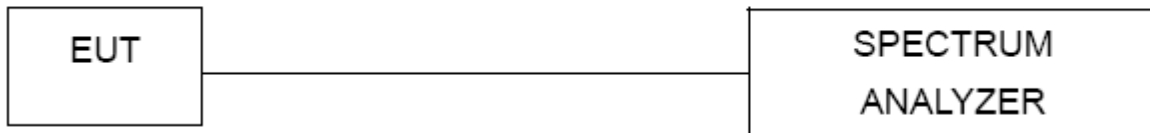

### 8.5 EUT OPERATION CONDITIONS

The EUT was programmed to be in continuously transmitting mode.

### 8.6 TEST RESULTS

Please refer to the APPENDIX H.

## 9. MEASUREMENT INSTRUMENTS LIST

AC Power Line Conducted Emissions					
Item	Kind of Equipment	Manufacturer	Type No.	Serial No.	Calibrated until
1	Line Impedance Stabilisation Network	Schwarzbeck	NNLK 8121	8121-822	Mar. 21, 2021
2	TWO-LINE V-NETWORK	R&S	ENV216	101340	Sep. 01, 2020
3	Test Cable	emci	EMCRG400-BM-NM-10000	170628	Jul. 15, 2021
4	EMI Test Receiver	R&S	ESCI	100082	Mar. 21, 2021
5	50Ω Terminator	SHX	TF2-1G-A	17051602	Mar. 21, 2021
6	50Ω coaxial switch	Anritsu	MP59B	6201750902	Mar. 21, 2021
7	Measurement Software	Farad	EZ-EMC Ver.NB-03A1-01	N/A	N/A

Radiated Emissions - 9 kHz to 30 MHz					
Item	Kind of Equipment	Manufacturer	Type No.	Serial No.	Calibrated until
1	Loop Antenna	EMCI	EMCI LPA600	275	Apr. 02, 2021
2	EMI Test Receiver	R&S	ESCI	100082	Mar. 21, 2021
3	Measurement Software	Farad	EZ-EMC Ver.NB-03A1-01	N/A	N/A

Radiated Emissions - 30 MHz to 1 GHz					
Item	Kind of Equipment	Manufacturer	Type No.	Serial No.	Calibrated until
1	TRILOG Broadband Antenna	Schwarzbeck	VULB 9168	719	Apr. 02, 2021
2	Pre-Amplifier	emci	EMC9135	980400	Mar. 21, 2021
3	MXE EMI Receiver	Keysight	N9038A	MY57150106	May. 06, 2021
4	Test Cable	emci	EMC104-SM-SM-7000	170330	Apr. 13, 2021
5	Test Cable	emci	EMC104-SM-SM-1000	170331	Apr. 13, 2021
6	Test Cable	emci	EMC104-SM-NM-3500	170621	Apr. 13, 2021
7	Measurement Software	Farad	EZ-EMC Ver.NB-03A1-01	N/A	N/A

Radiated Emissions - Above 1 GHz					
Item	Kind of Equipment	Manufacturer	Type No.	Serial No.	Calibrated until
1	Double-Ridged Waveguide Horn Antenna	ETS-Lindgren	9120D	00206960	Apr. 02, 2021
2	Pre-Amplifier	emci	EMC012645SE	980421	May. 11, 2021
3	EXA Spectrum Analyzer	Keysight	N9010A	MY56480545	Mar. 21, 2021
4	Test Cable	emci	EMC104-SM-SM-7000	170330	Apr. 13, 2021
5	Test Cable	emci	EMC104-SM-SM-1000	170331	Apr. 13, 2021
6	Test Cable	emci	EMC104-SM-NM-3500	170621	Apr. 13, 2021
7	Measurement Software	Farad	EZ-EMC Ver.NB-03A1-01	N/A	N/A
8	MXE EMI Receiver	Keysight	N9038A	MY57150106	May. 06, 2021
9	Double-Ridged Waveguide Horn Antenna	ETS-Lindgren	3116C	00203919	Mar. 21, 2021
10	Pre-Amplifier	emci	EMC184045SE	980409	Mar. 21, 2021
11	EXA Spectrum Analyzer	Keysight	N9010A	MY56480579	Mar. 21, 2021
12	Test Cable	emci	EMC102-KM-KM-800	170654	Mar. 21, 2021
13	Test Cable	emci	Super Reliable-40G-SS11-7000	W0030860001	Mar. 21, 2021
14	Measurement Software	Farad	EZ-EMC Ver.NB-03A1-01	N/A	N/A

Bandwidth					
Item	Kind of Equipment	Manufacturer	Type No.	Serial No.	Calibrated until
1	Spectrum Analyzer	R&S	FSP40	100626	Mar. 06, 2021

Maximum Output Power					
Item	Kind of Equipment	Manufacturer	Type No.	Serial No.	Calibrated until
1	Peak Power Analyze	Keysight	8990B	MY51000507	Mar. 21, 2021
2	Wideband Power Sensor	Keysight	N9123A	MY58310003	Mar. 21, 2021

Antenna Conducted Spurious Emissions					
Item	Kind of Equipment	Manufacturer	Type No.	Serial No.	Calibrated until
1	Spectrum Analyzer	R&S	FSP40	100626	Mar. 06, 2021

Power Spectral Density					
Item	Kind of Equipment	Manufacturer	Type No.	Serial No.	Calibrated until
1	Spectrum Analyzer	R&S	FSP40	100626	Mar. 06 2021

Remark: "N/A" denotes no model name, serial no. or calibration specified.

All calibration period of equipment list is one year.

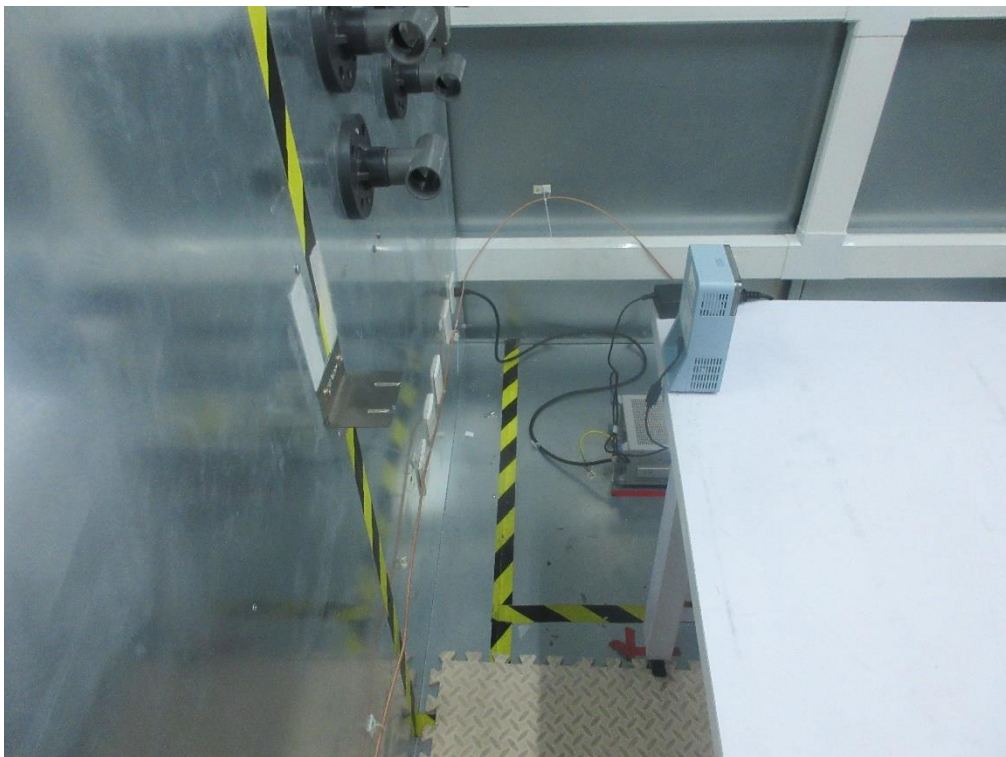
**10. EUT TEST PHOTO****Conducted Emissions Test Photos**

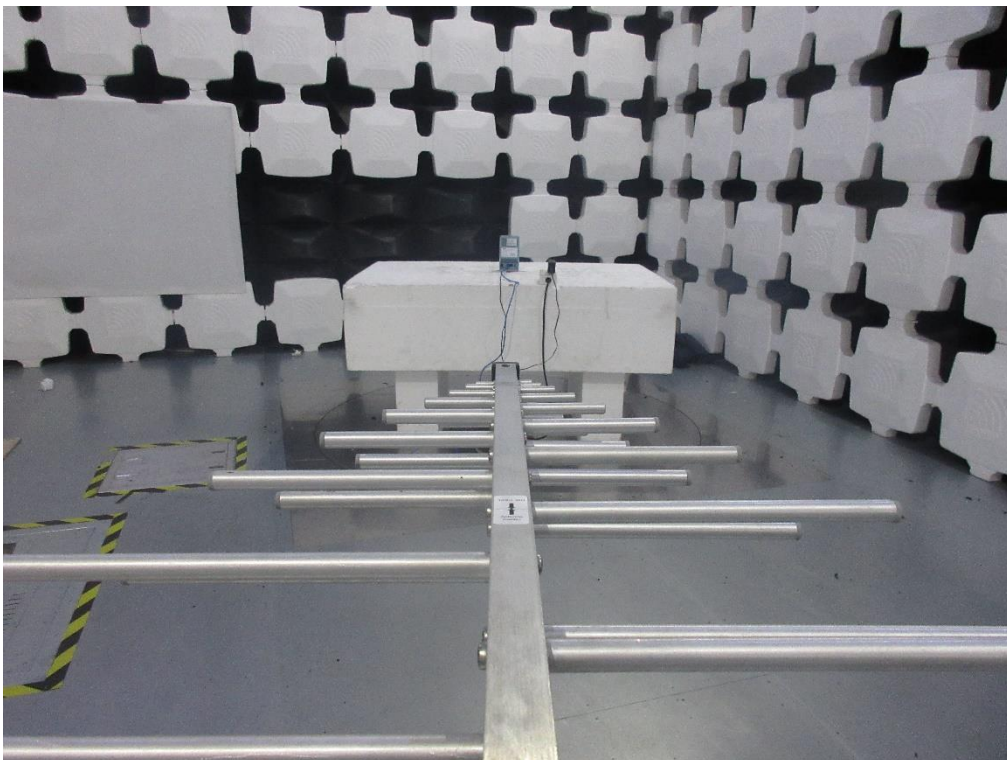
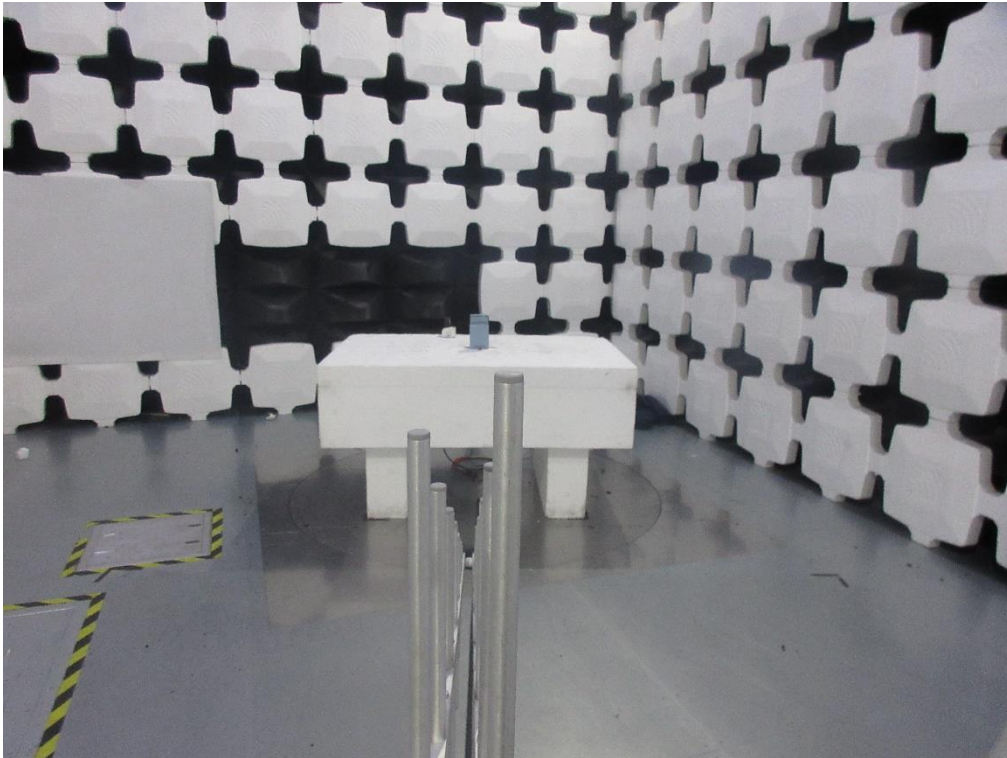
**Radiated Emissions Test Photos****30 MHz to 1 GHz**

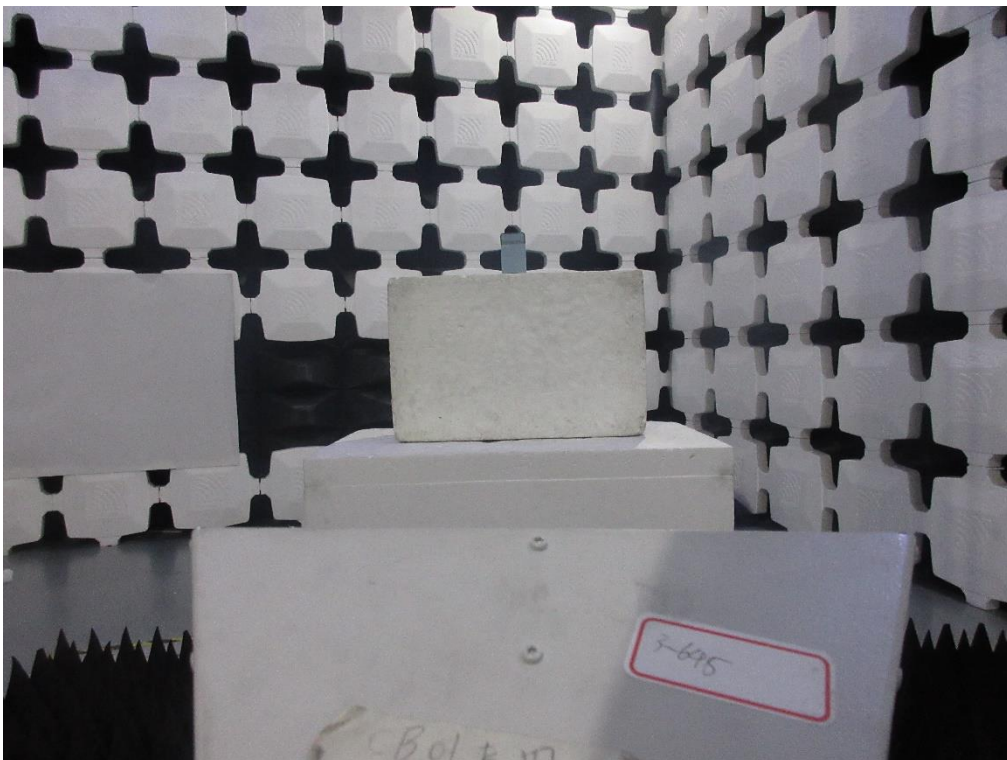
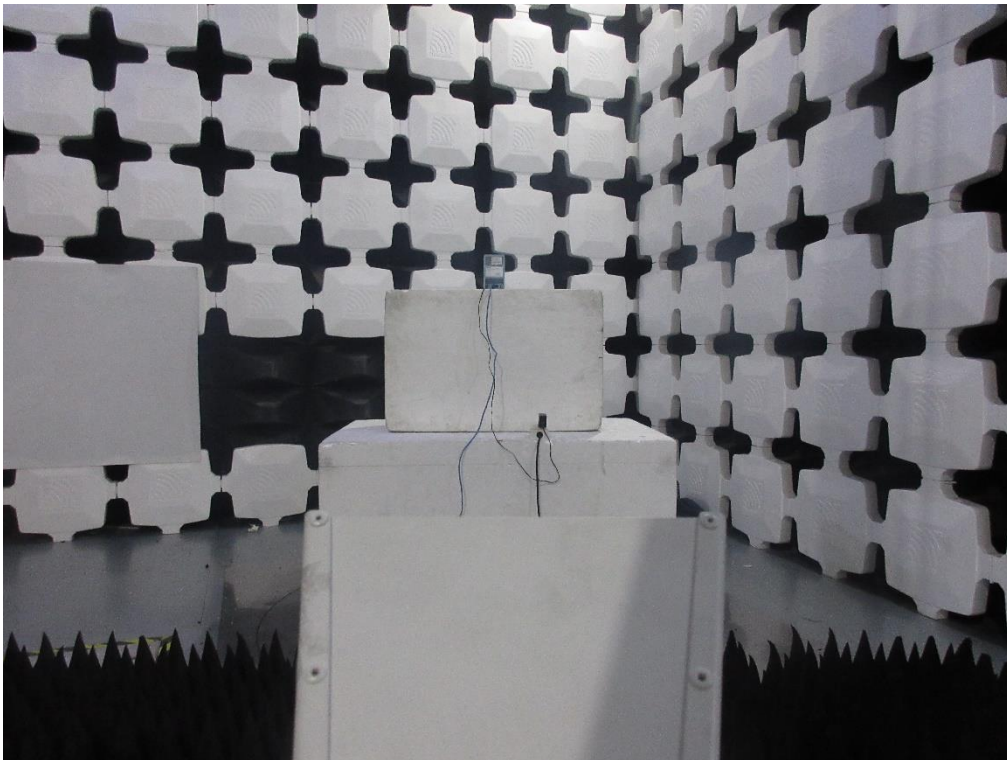
**Radiated Emissions Test Photos****Above 1 GHz**



## APPENDIX A - AC POWER LINE CONDUCTED EMISSIONS

Test Mode: TX B Mode Channel 06

## Line

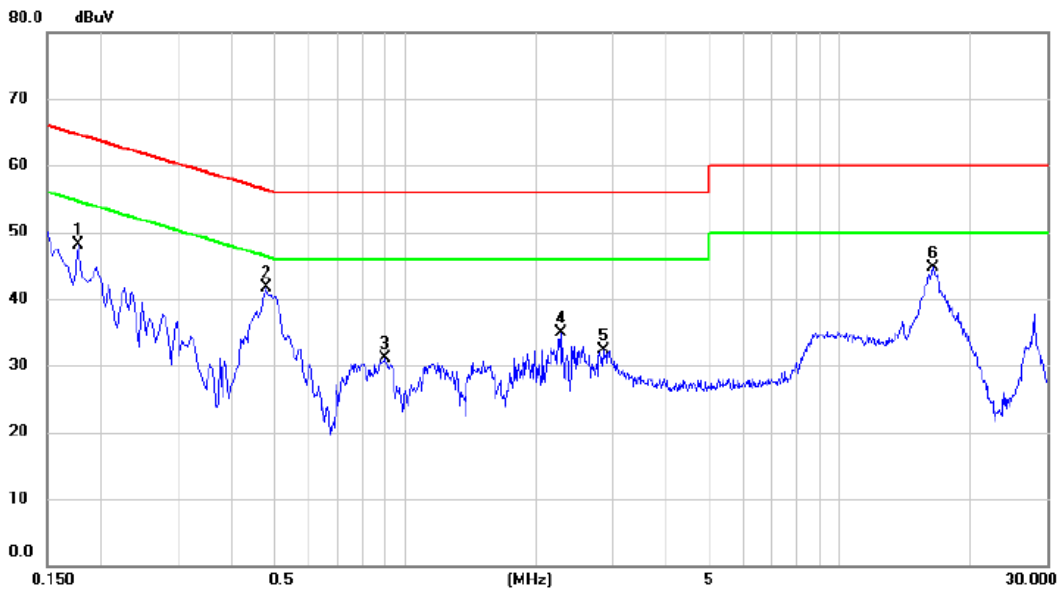

No. Mk.	Freq. MHz	Reading Level dBuV	Correct Factor dB	Measure- ment dBuV	Limit dBuV	Margin dB	Detector	Comment
1	0.1770	38.32	9.76	48.08	64.63	-16.55	peak	
2 *	0.4785	31.85	9.89	41.74	56.37	-14.63	peak	
3	0.9015	21.31	9.78	31.09	56.00	-24.91	peak	
4	2.2785	25.09	9.82	34.91	56.00	-21.09	peak	
5	2.8590	22.52	9.85	32.37	56.00	-23.63	peak	
6	16.4355	34.31	10.30	44.61	60.00	-15.39	peak	

### REMARKS:

- (1) Measurement Value = Reading Level + Correct Factor.
- (2) Margin Level = Measurement Value - Limit Value.

Test Mode: TX B Mode Channel 06

## Neutral

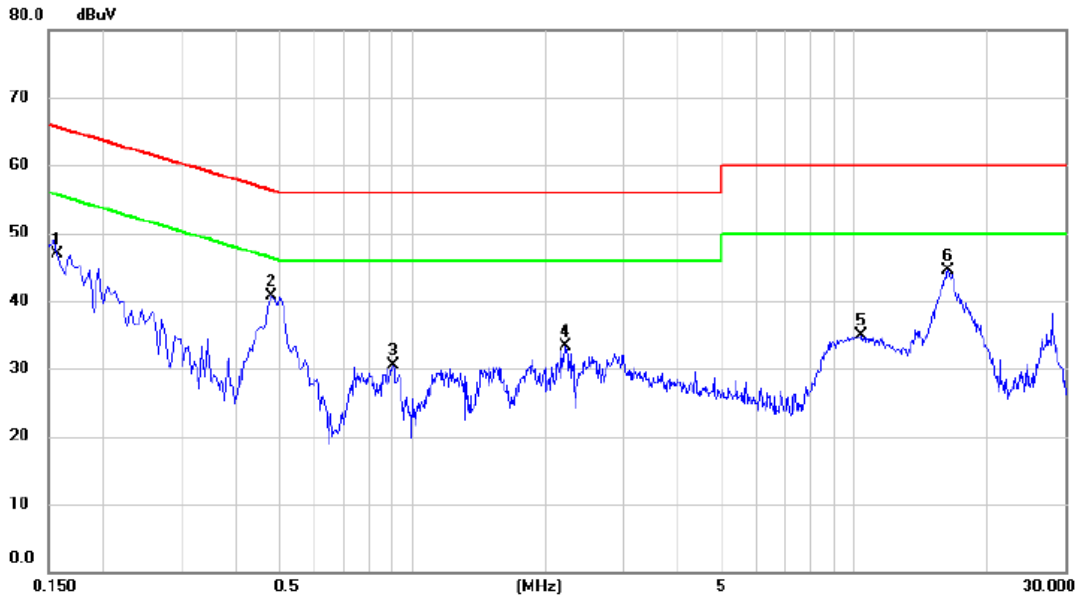

No.	Mk.	Freq. MHz	Reading Level dBuV	Correct Factor dB	Measure- ment dBuV	Limit dBuV	Margin dB	Detector	Comment
1		0.1573	37.34	9.61	46.95	65.61	-18.66	peak	
2		0.4785	31.11	9.69	40.80	56.37	-15.57	peak	
3		0.9060	20.86	9.72	30.58	56.00	-25.42	peak	
4		2.2200	23.42	9.81	33.23	56.00	-22.77	peak	
5		10.3650	24.66	10.15	34.81	60.00	-25.19	peak	
6	*	16.2645	34.36	10.23	44.59	60.00	-15.41	peak	

**REMARKS:**

- (1) Measurement Value = Reading Level + Correct Factor.
- (2) Margin Level = Measurement Value - Limit Value.

## **APPENDIX B - RADIATED EMISSION - 9 MHZ TO 30 MHZ**

Note: Below 30MHz, The measured value have enough margin over 20dB than the limit, therefore they are not reported

## APPENDIX C - RADIATED EMISSION - 30 MHz TO 1000 MHz

Test Mode: TX B Mode Channel 06

### Horizontal

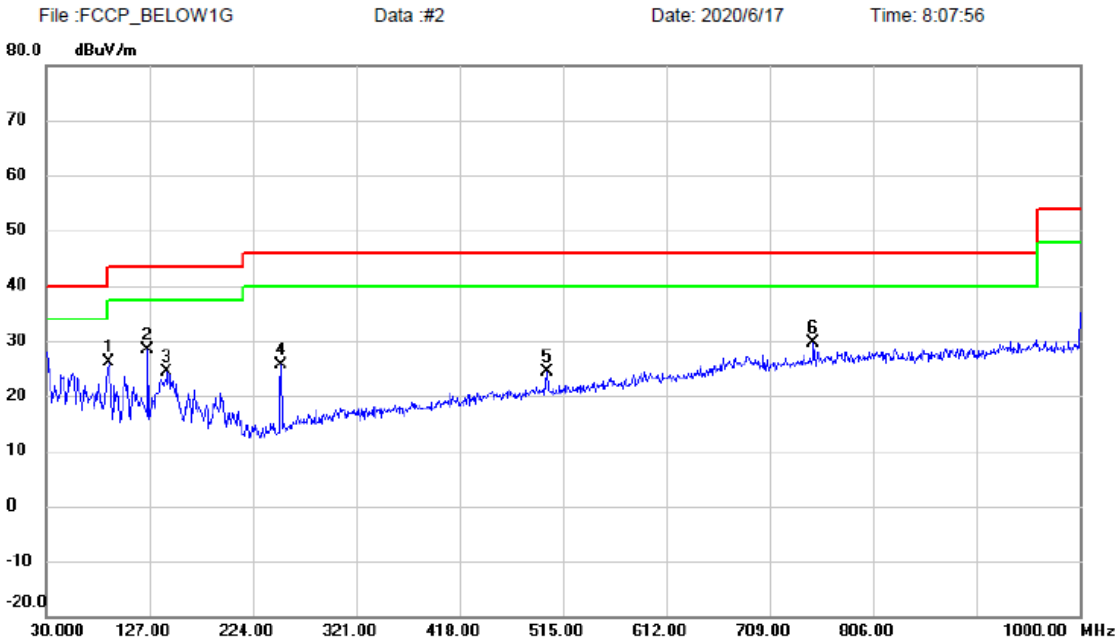

No.	Mk.	Freq. MHz	Reading Level dBuV	Correct Factor dB	Measure- ment dBuV/m	Limit dBuV/m	Margin dB	Detector	Comment
1		88.6850	47.98	-21.76	26.22	43.50	-17.28	peak	
2	*	125.0600	46.04	-17.69	28.35	43.50	-15.15	peak	
3		143.4900	40.49	-16.11	24.38	43.50	-19.12	peak	
4		250.1900	42.22	-16.67	25.55	46.00	-20.45	peak	
5		499.9650	34.80	-10.32	24.48	46.00	-21.52	peak	
6		750.2250	35.41	-5.82	29.59	46.00	-16.41	peak	

**REMARKS:**

- (1) Measurement Value = Reading Level + Correct Factor.
- (2) Margin Level = Measurement Value - Limit Value.

Test Mode: TX B Mode Channel 06

### Vertical

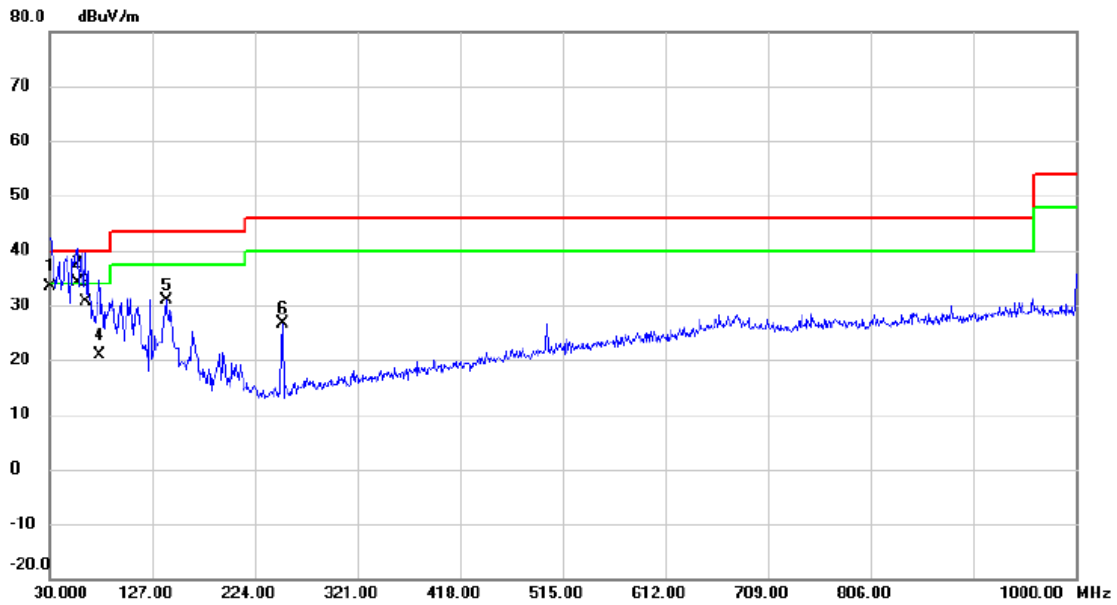

No.	Mk.	Freq. MHz	Reading Level dBuV	Correct Factor dB	Measure- ment dBuV/m	Limit dBuV/m	Margin dB	Detector	Comment
1		30.0000	51.50	-18.21	33.29	40.00	-6.71	QP	
2	*	56.1900	50.88	-16.63	34.25	40.00	-5.75	QP	
3		63.9500	48.01	-17.28	30.73	40.00	-9.27	QP	
4		77.0450	40.69	-19.79	20.90	40.00	-19.10	QP	
5		140.0950	47.07	-16.31	30.76	43.50	-12.74	peak	
6		250.1900	43.39	-16.67	26.72	46.00	-19.28	peak	

**REMARKS:**

- (1) Measurement Value = Reading Level + Correct Factor.
- (2) Margin Level = Measurement Value - Limit Value.

**APPENDIX D - RADIATED EMISSION- ABOVE 1000 MHZ**



ANT1+ANT2

Test Mode: TX B Mode 2412 MHz

Vertical

120 dBuV/m

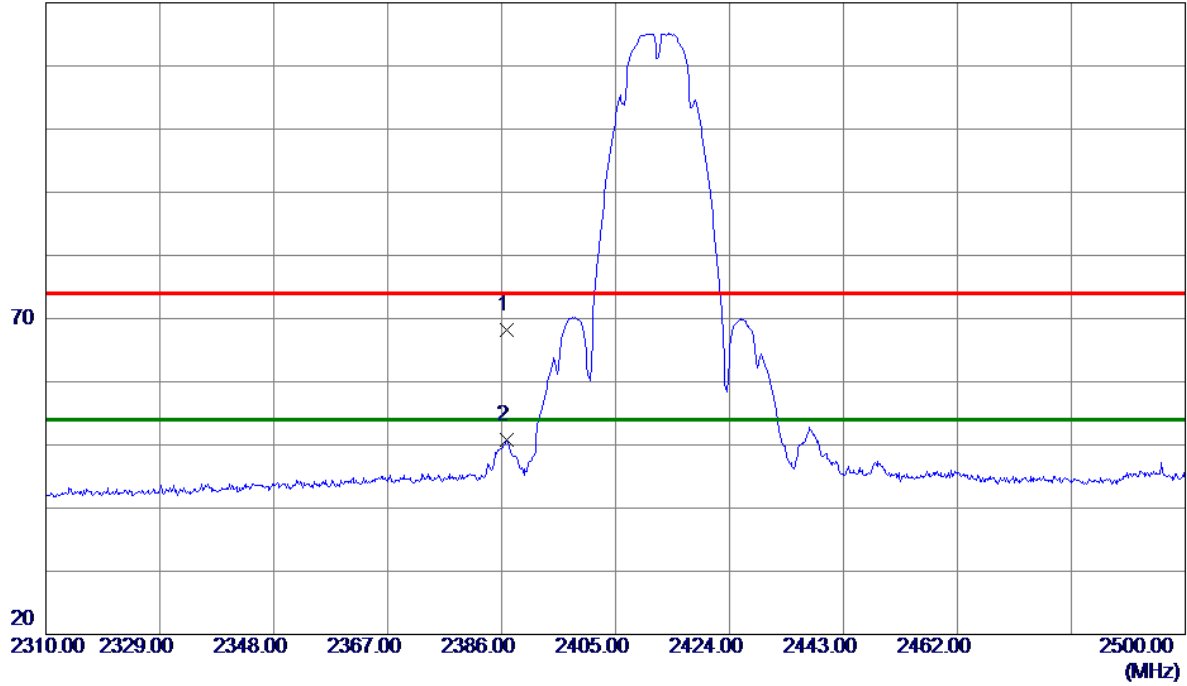

No.	Freq. MHz	Reading Level dBuV/m	Correct Factor dB	Measure ment dBuV/m	Limit dBuV/m	Margin dB	Detector	Comment
1	2386.8550	34.76	33.35	68.11	74.00	-5.89	Peak	
2 *	2386.8550	17.42	33.35	50.77	54.00	-3.23	AVG	

REMARKS:

- (1) Measurement Value = Reading Level + Correct Factor.
- (2) Margin Level = Measurement Value - Limit Value.

Test Mode: TX B Mode 2412 MHz

### Vertical

80 dBuV/m

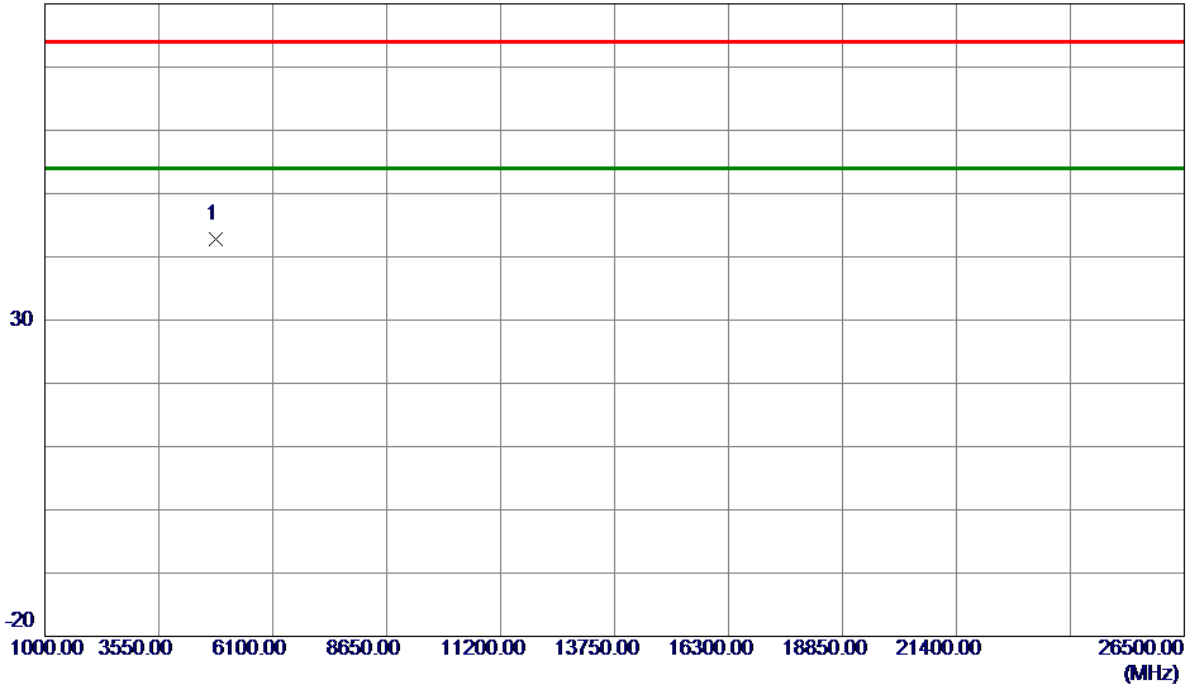

No.	Freq. MHz	Reading Level dBuV/m	Correct Factor dB	Measure ment dBuV/m	Limit dBuV/m	Margin dB	Detector	Comment
1 *	4825.0000	55.75	-13.02	42.73	74.00	-31.27	Peak	

**REMARKS:**

- (1) Measurement Value = Reading Level + Correct Factor.
- (2) Margin Level = Measurement Value - Limit Value.

Test Mode: TX B Mode 2412 MHz

### Horizontal

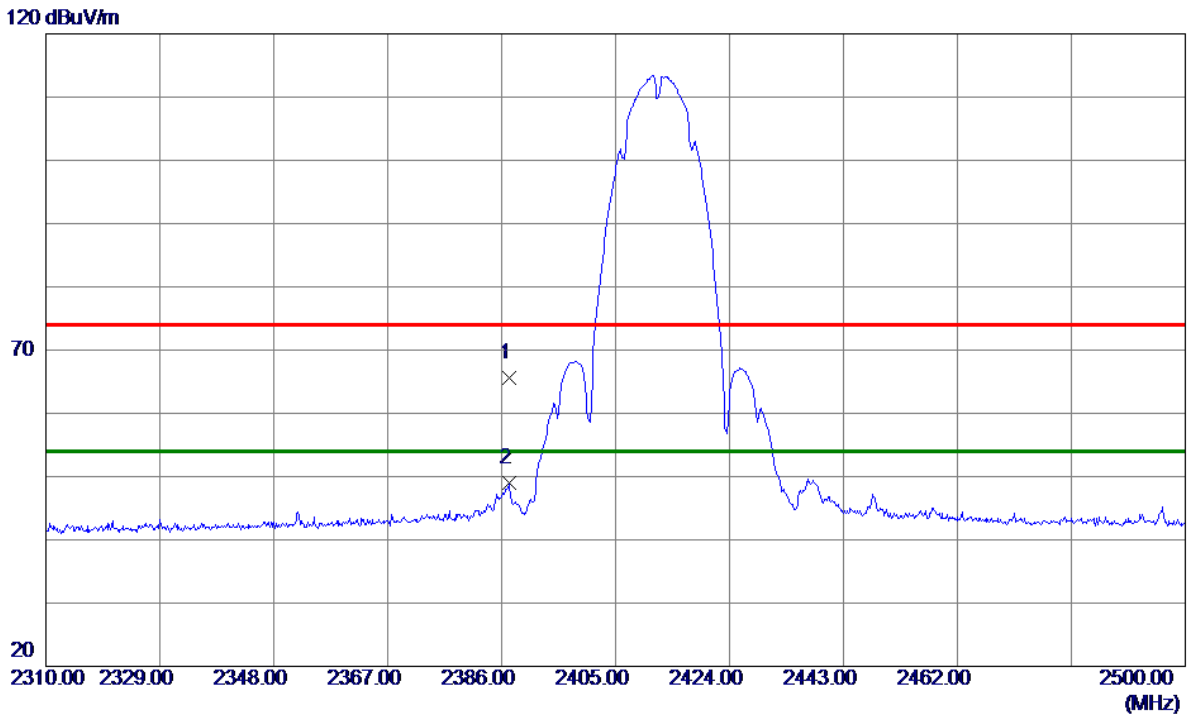

No.	Freq. MHz	Reading Level dBuV/m	Correct Factor dB	Measure ment dBuV/m	Limit dBuV/m	Margin dB	Detector	Comment
1	2387.2350	32.16	33.35	65.51	74.00	-8.49	Peak	
2 *	2387.2350	15.74	33.35	49.09	54.00	-4.91	AVG	

**REMARKS:**

- (1) Measurement Value = Reading Level + Correct Factor.
- (2) Margin Level = Measurement Value - Limit Value.

Test Mode: TX B Mode 2412 MHz

### Horizontal

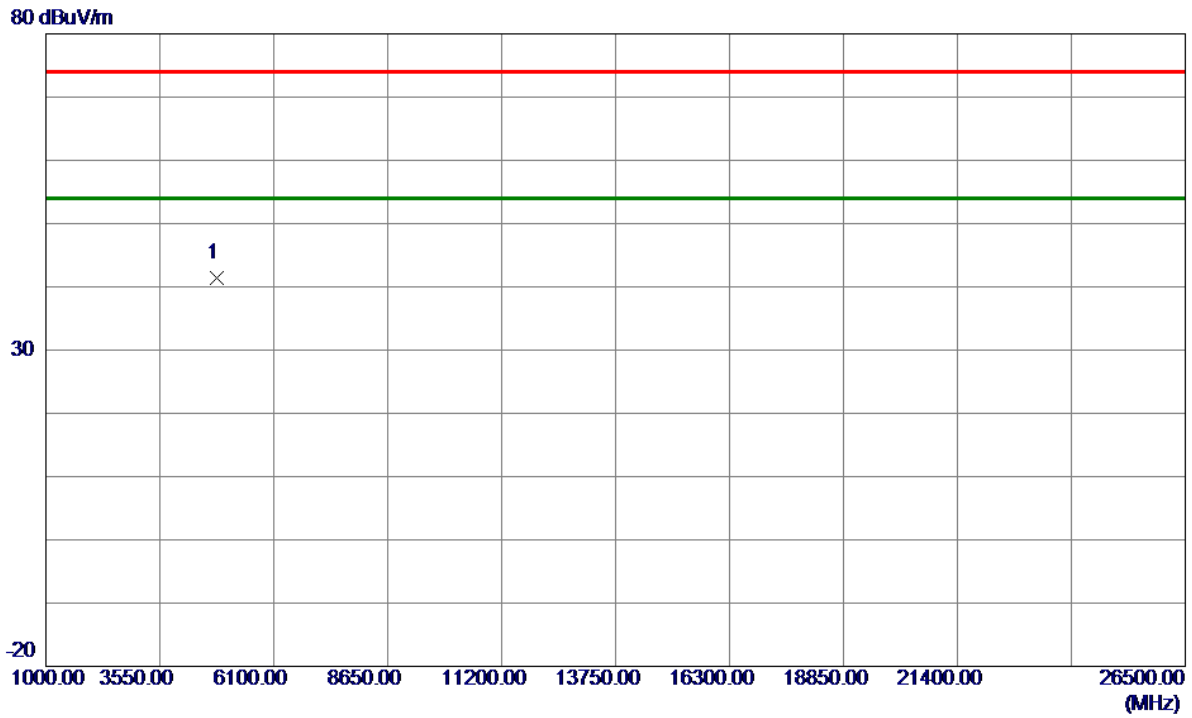

No.	Freq. MHz	Reading Level dBuV/m	Correct Factor dB	Measure ment dBuV/m	Limit dBuV/m	Margin dB	Detector	Comment
1 *	4825.0000	54.47	-13.02	41.45	74.00	-32.55	Peak	

**REMARKS:**

- (1) Measurement Value = Reading Level + Correct Factor.
- (2) Margin Level = Measurement Value - Limit Value.

Test Mode: TX B Mode 2437 MHz

### Vertical

120 dBuV/m

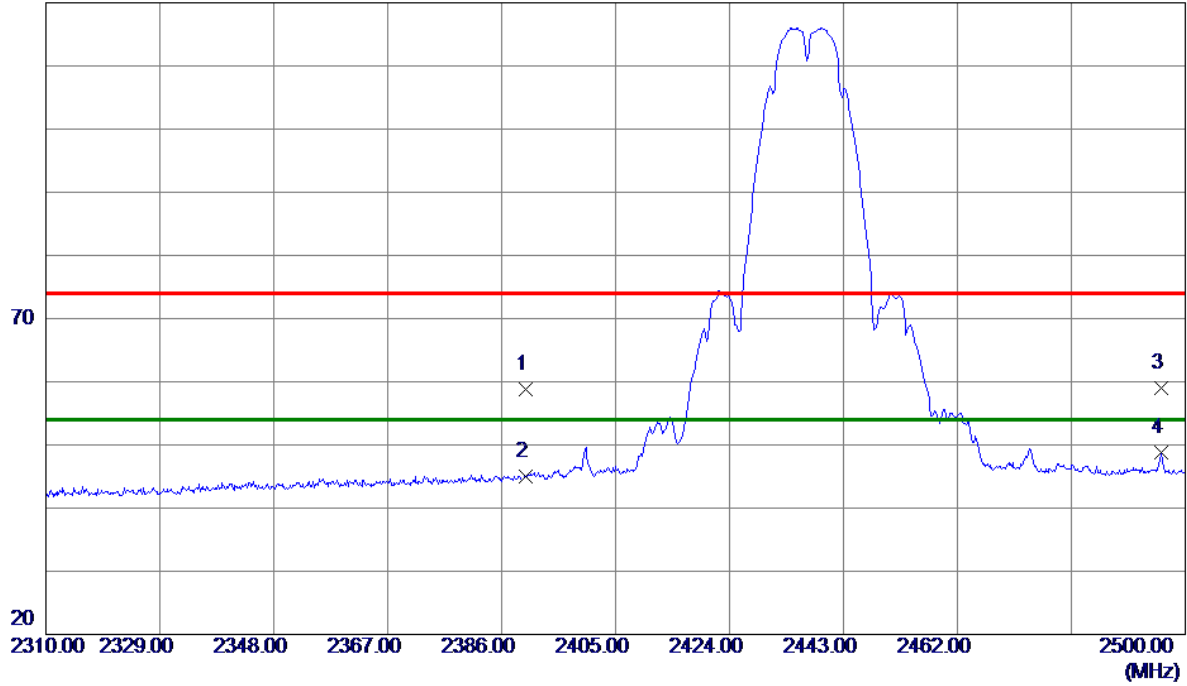

No.	Freq. MHz	Reading Level dBuV/m	Correct Factor dB	Measure ment dBuV/m	Limit dBuV/m	Margin dB	Detector	Comment
1	2390.0000	25.42	33.36	58.78	74.00	-15.22	Peak	
2	2390.0000	11.63	33.36	44.99	54.00	-9.01	AVG	
3	2496.0100	25.16	33.81	58.97	74.00	-15.03	Peak	
4 *	2496.0100	15.05	33.81	48.86	54.00	-5.14	AVG	

**REMARKS:**

- (1) Measurement Value = Reading Level + Correct Factor.
- (2) Margin Level = Measurement Value - Limit Value.

Test Mode: TX B Mode 2437 MHz

### Vertical

80 dBuV/m

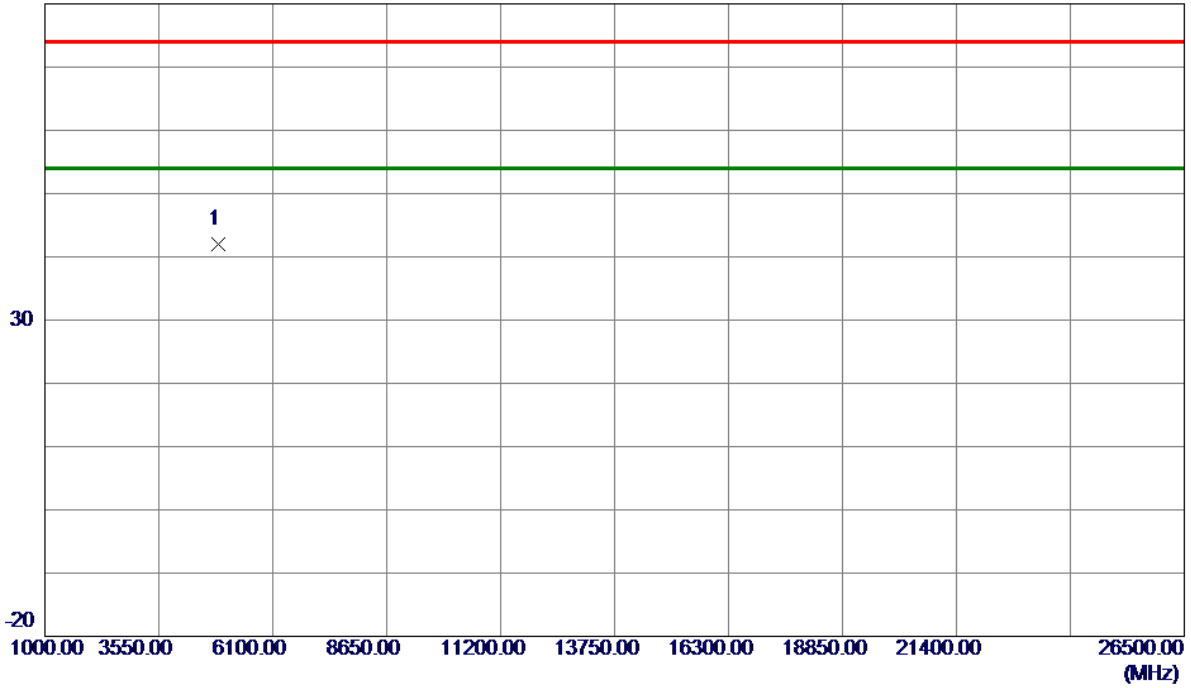

No.	Freq. MHz	Reading Level dBuV/m	Correct Factor dB	Measure ment dBuV/m	Limit dBuV/m	Margin dB	Detector	Comment
1 *	4873.4500	54.95	-12.87	42.08	74.00	-31.92	Peak	

**REMARKS:**

- (1) Measurement Value = Reading Level + Correct Factor.
- (2) Margin Level = Measurement Value - Limit Value.

Test Mode: TX B Mode 2437 MHz

### Horizontal

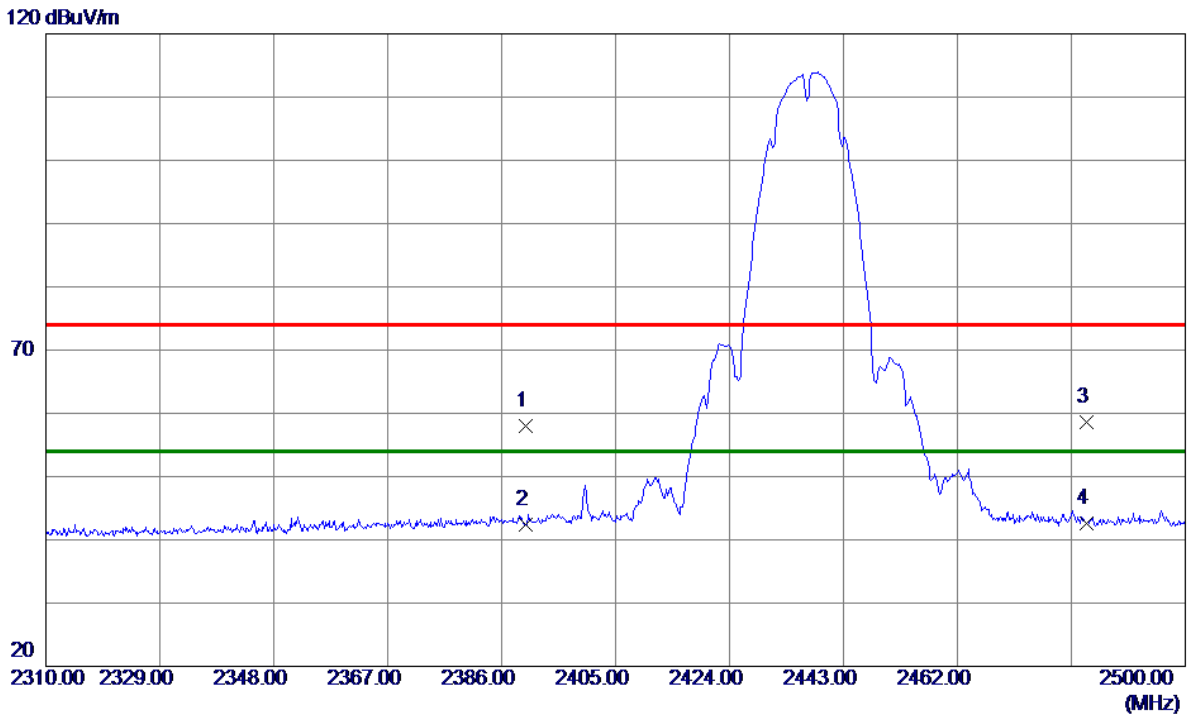

No.	Freq. MHz	Reading Level dBuV/m	Correct Factor dB	Measure ment dBuV/m	Limit dBuV/m	Margin dB	Detector	Comment
1	2390.0000	24.55	33.36	57.91	74.00	-16.09	Peak	
2	2390.0000	9.12	33.36	42.48	54.00	-11.52	AVG	
3	2483.5000	24.83	33.76	58.59	74.00	-15.41	Peak	
4 *	2483.5000	8.76	33.76	42.52	54.00	-11.48	AVG	

**REMARKS:**

- (1) Measurement Value = Reading Level + Correct Factor.
- (2) Margin Level = Measurement Value - Limit Value.

Test Mode: TX B Mode 2437 MHz

### Horizontal

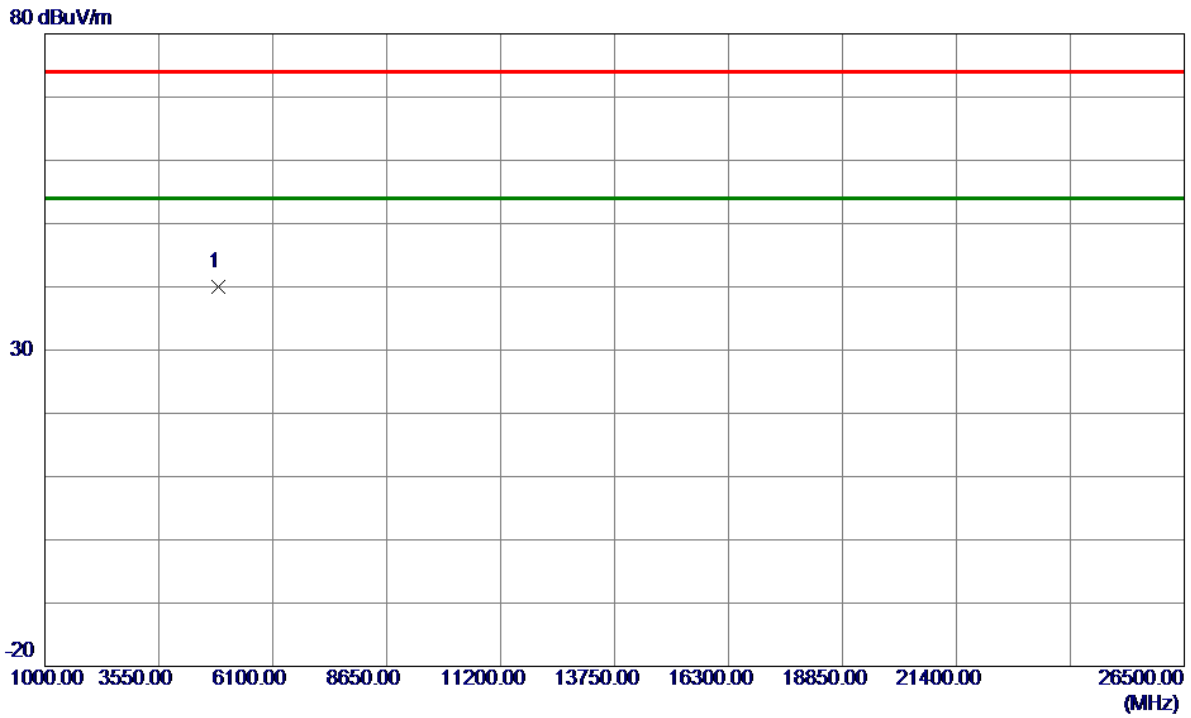

No.	Freq. MHz	Reading Level dBuV/m	Correct Factor dB	Measure ment dBuV/m	Limit dBuV/m	Margin dB	Detector	Comment
1 *	4873.4500	52.87	-12.87	40.00	74.00	-34.00	Peak	

**REMARKS:**

- (1) Measurement Value = Reading Level + Correct Factor.
- (2) Margin Level = Measurement Value - Limit Value.



Test Mode: TX B Mode 2462 MHz

**Vertical**

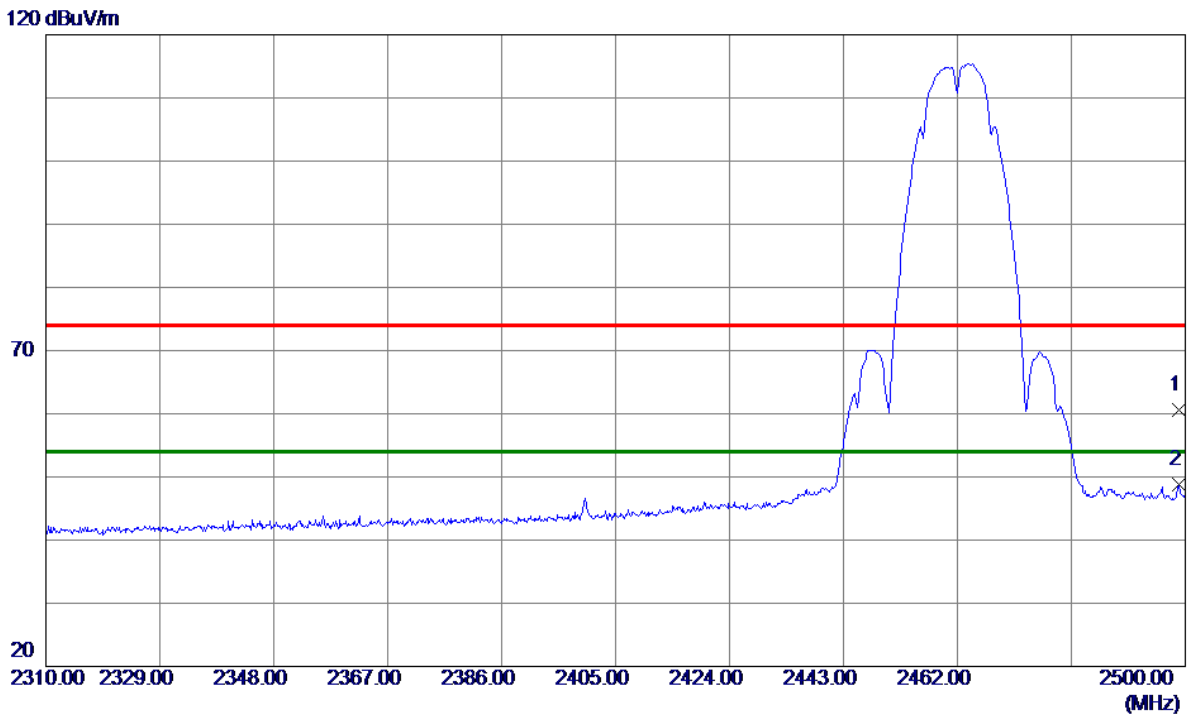

No.	Freq. MHz	Reading Level dBuV/m	Correct Factor dB	Measure ment dBuV/m	Limit dBuV/m	Margin dB	Detector	Comment
1	2498.8600	26.79	33.83	60.62	74.00	-13.38	Peak	
2 *	2498.8600	14.90	33.83	48.73	54.00	-5.27	AVG	

**REMARKS:**

- (1) Measurement Value = Reading Level + Correct Factor.
- (2) Margin Level = Measurement Value - Limit Value.

Test Mode: TX B Mode 2462 MHz

### Vertical

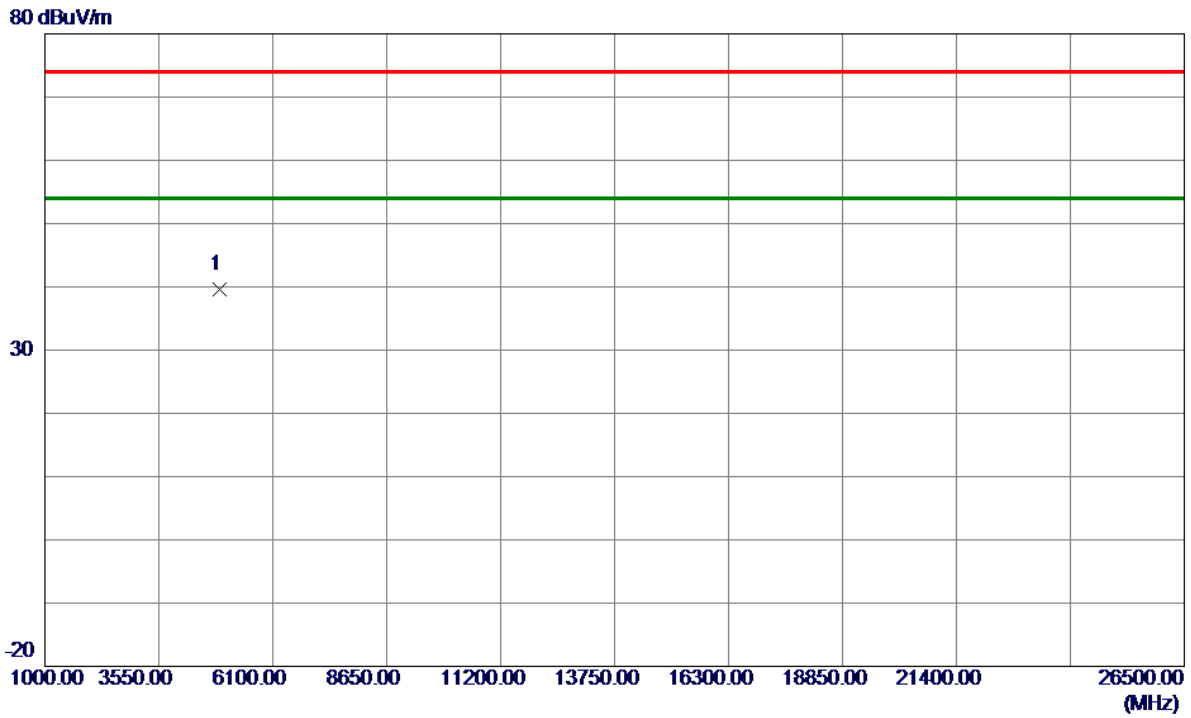

No.	Freq. MHz	Reading Level dBuV/m	Correct Factor dB	Measure ment dBuV/m	Limit dBuV/m	Margin dB	Detector	Comment
1 *	4924.0000	52.26	-12.71	39.55	74.00	-34.45	Peak	

**REMARKS:**

- (1) Measurement Value = Reading Level + Correct Factor.
- (2) Margin Level = Measurement Value - Limit Value.

Test Mode: TX B Mode 2462 MHz

### Horizontal

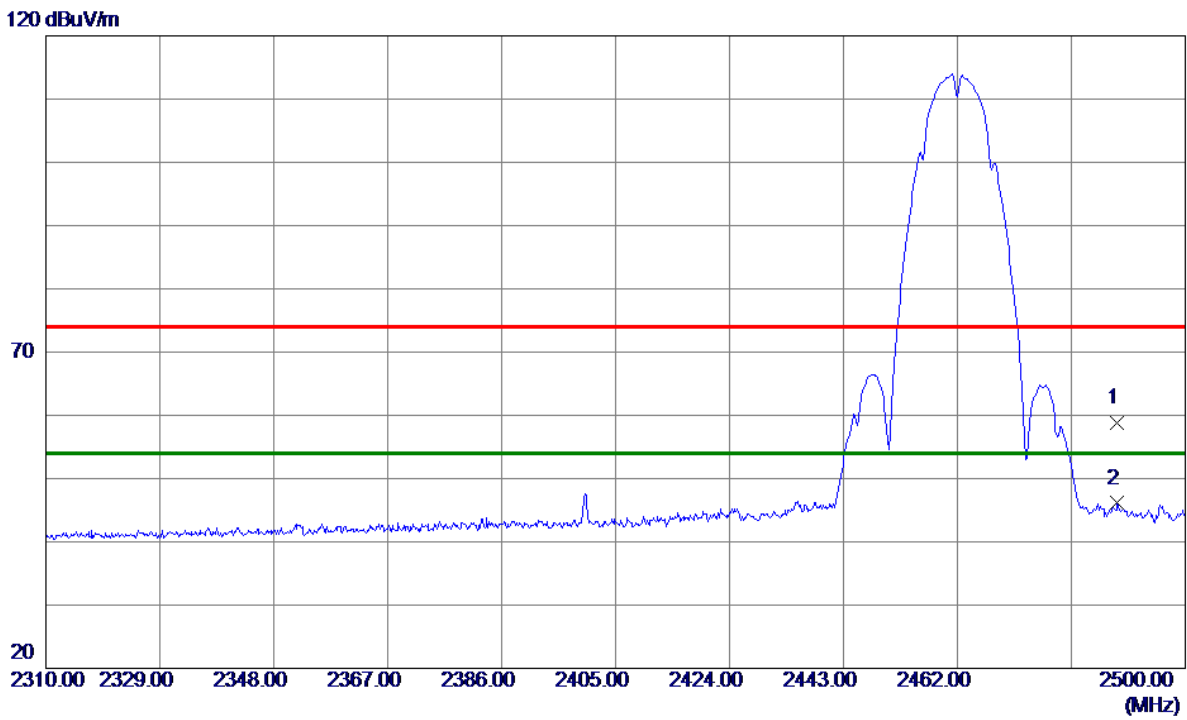

No.	Freq. MHz	Reading Level dBuV/m	Correct Factor dB	Measure ment dBuV/m	Limit dBuV/m	Margin dB	Detector	Comment
1	2488.6950	25.02	33.78	58.80	74.00	-15.20	Peak	
2 *	2488.6950	12.32	33.78	46.10	54.00	-7.90	AVG	

**REMARKS:**

- (1) Measurement Value = Reading Level + Correct Factor.
- (2) Margin Level = Measurement Value - Limit Value.

Test Mode: TX B Mode 2462 MHz

### Horizontal

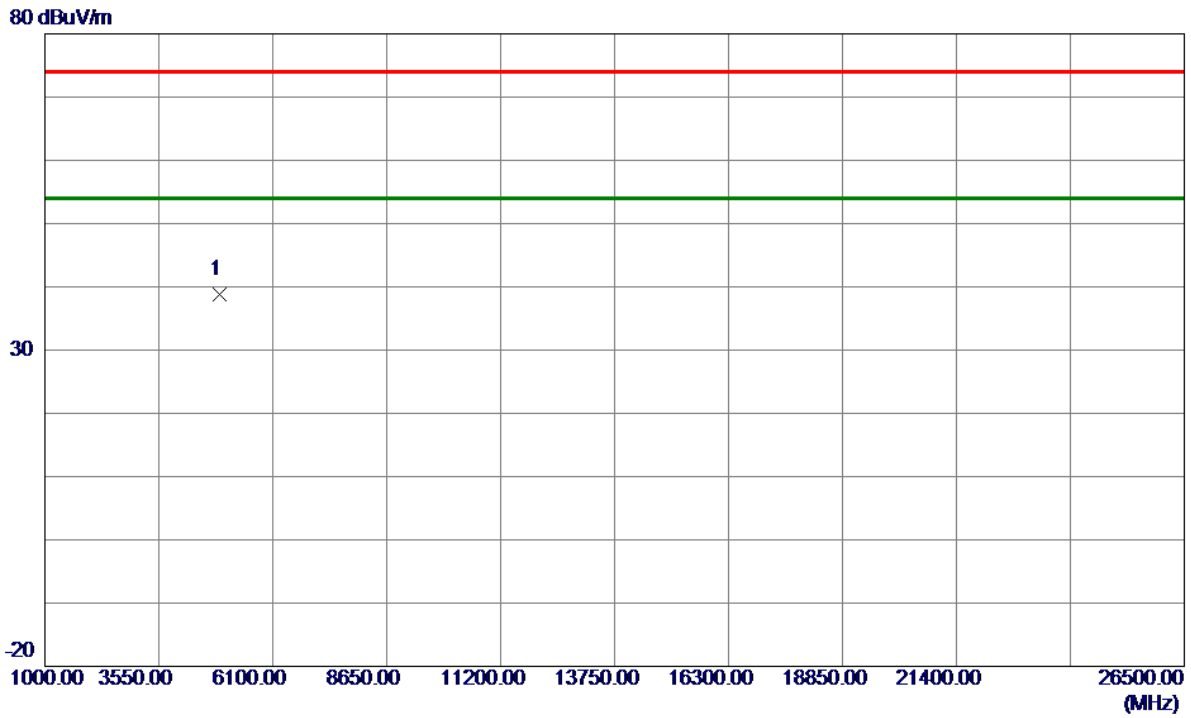

No.	Freq. MHz	Reading Level dBuV/m	Correct Factor dB	Measure ment dBuV/m	Limit dBuV/m	Margin dB	Detector	Comment
1 *	4924.0000	51.56	-12.71	38.85	74.00	-35.15	Peak	

**REMARKS:**

- (1) Measurement Value = Reading Level + Correct Factor.
- (2) Margin Level = Measurement Value - Limit Value.

Test Mode: TX G Mode 2412 MHz

### Vertical

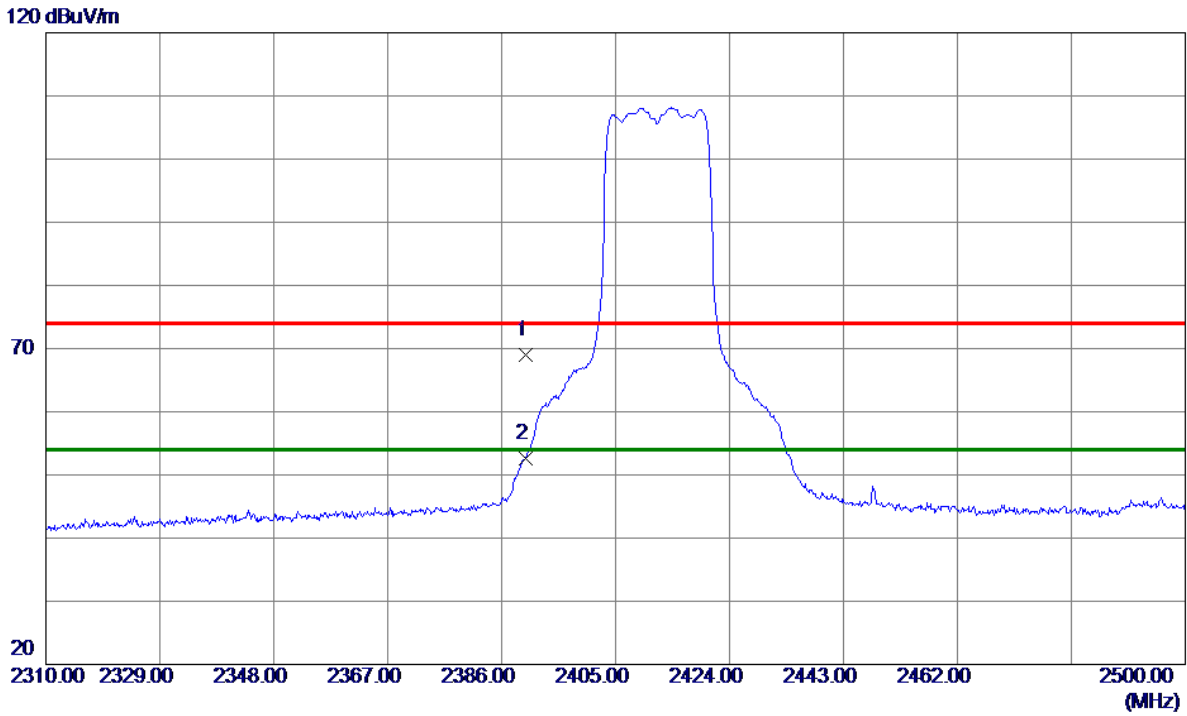

No.	Freq. MHz	Reading Level dBuV/m	Correct Factor dB	Measure ment dBuV/m	Limit dBuV/m	Margin dB	Detector	Comment
1	2390.0000	35.68	33.36	69.04	74.00	-4.96	Peak	
2 *	2390.0000	19.31	33.36	52.67	54.00	-1.33	AVG	

**REMARKS:**

- (1) Measurement Value = Reading Level + Correct Factor.
- (2) Margin Level = Measurement Value - Limit Value.

Test Mode: TX G Mode 2412 MHz

### Vertical

80 dBuV/m

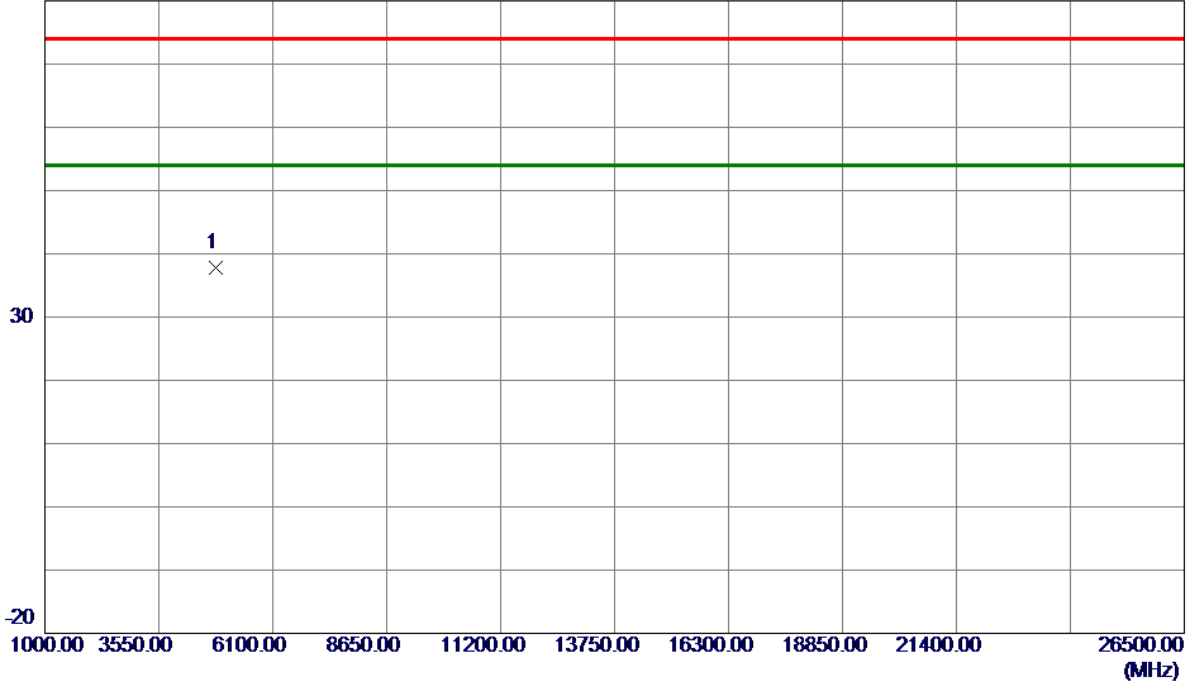

No.	Freq. MHz	Reading Level dBuV/m	Correct Factor dB	Measure ment dBuV/m	Limit dBuV/m	Margin dB	Detector	Comment
1 *	4824.0000	50.90	-13.02	37.88	74.00	-36.12	Peak	

**REMARKS:**

- (1) Measurement Value = Reading Level + Correct Factor.
- (2) Margin Level = Measurement Value - Limit Value.

Test Mode: TX G Mode 2412 MHz

### Horizontal

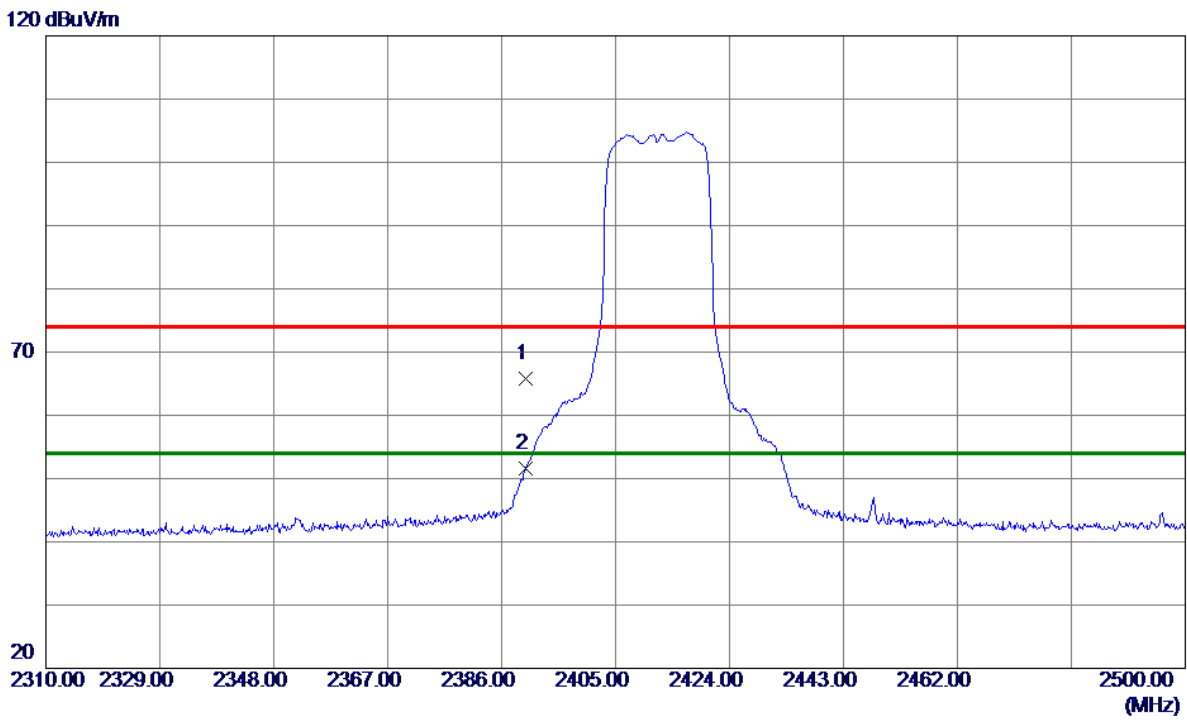

No.	Freq. MHz	Reading Level dBuV/m	Correct Factor dB	Measure ment dBuV/m	Limit dBuV/m	Margin dB	Detector	Comment
1	2390.0000	32.46	33.36	65.82	74.00	-8.18	Peak	
2 *	2390.0000	18.31	33.36	51.67	54.00	-2.33	AVG	

**REMARKS:**

- (1) Measurement Value = Reading Level + Correct Factor.
- (2) Margin Level = Measurement Value - Limit Value.

Test Mode: TX G Mode 2412 MHz

### Horizontal

80 dBuV/m

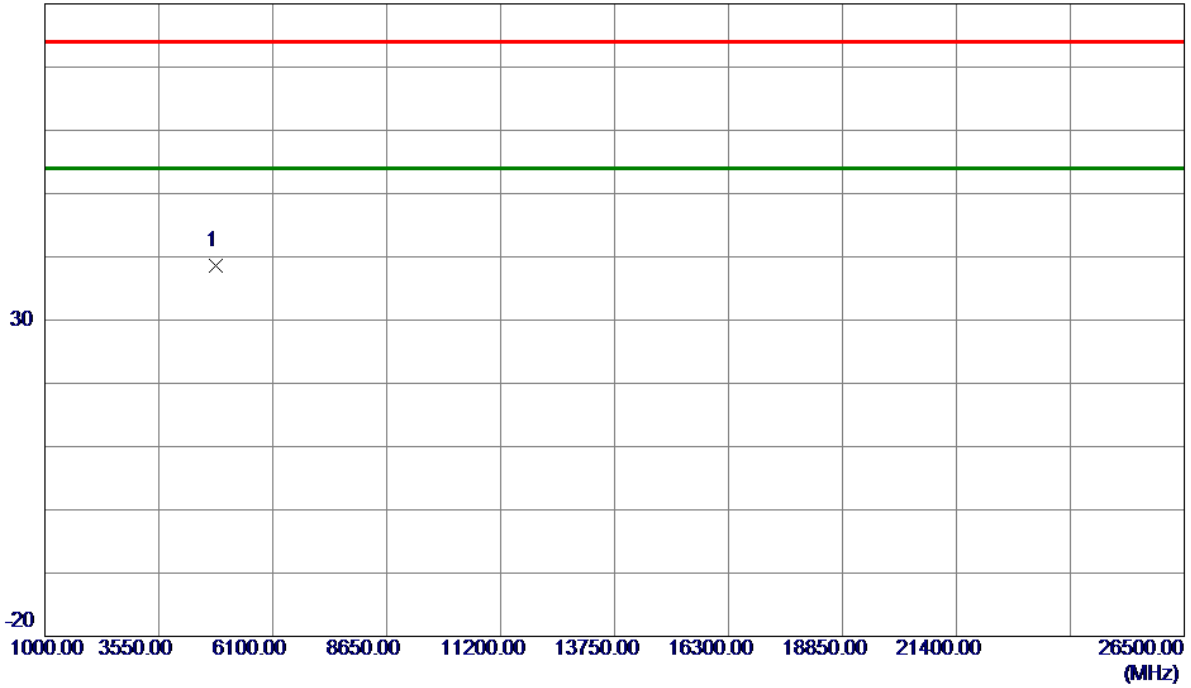

No.	Freq. MHz	Reading Level dBuV/m	Correct Factor dB	Measure ment dBuV/m	Limit dBuV/m	Margin dB	Detector	Comment
1 *	4824.0000	51.59	-13.02	38.57	74.00	-35.43	Peak	

**REMARKS:**

- (1) Measurement Value = Reading Level + Correct Factor.
- (2) Margin Level = Measurement Value - Limit Value.



Test Mode: TX G Mode 2437 MHz

### Vertical

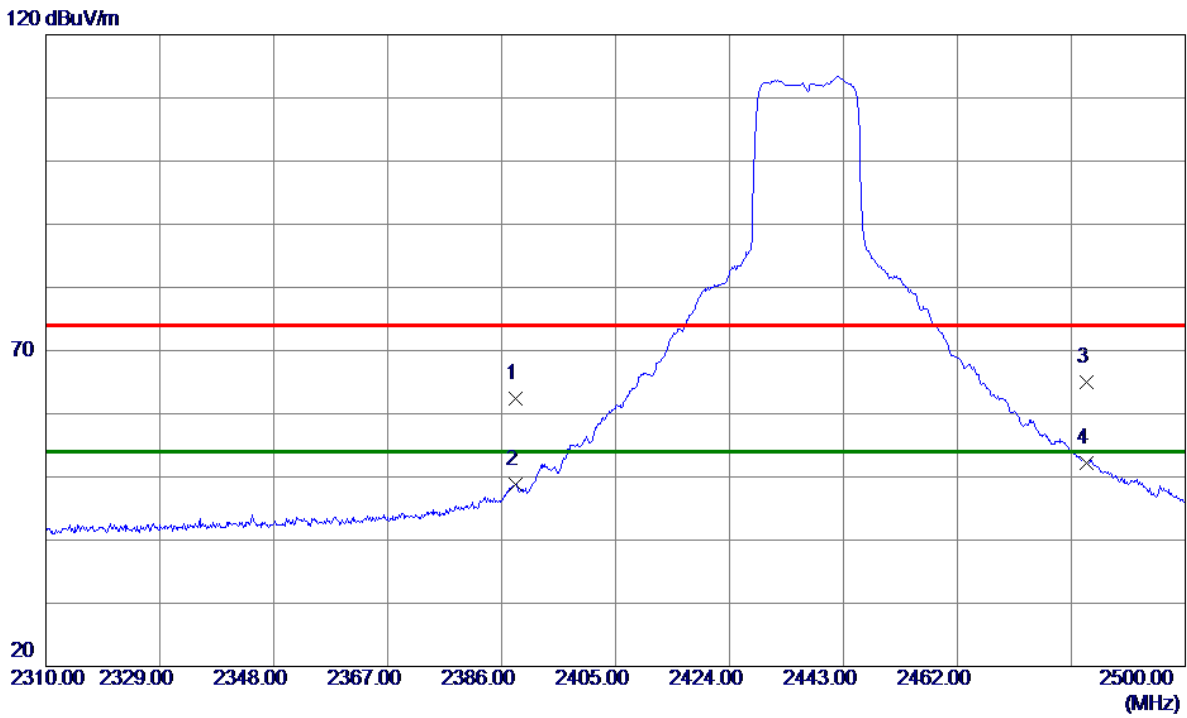

No.	Freq. MHz	Reading Level dBuV/m	Correct Factor dB	Measure ment dBuV/m	Limit dBuV/m	Margin dB	Detector	Comment
1	2388.3750	29.02	33.35	62.37	74.00	-11.63	Peak	
2	2388.3750	15.42	33.35	48.77	54.00	-5.23	AVG	
3	2483.5000	31.16	33.76	64.92	74.00	-9.08	Peak	
4 *	2483.5000	18.42	33.76	52.18	54.00	-1.82	AVG	

**REMARKS:**

- (1) Measurement Value = Reading Level + Correct Factor.
- (2) Margin Level = Measurement Value - Limit Value.

Test Mode: TX G Mode 2437 MHz

### Vertical

80 dBuV/m

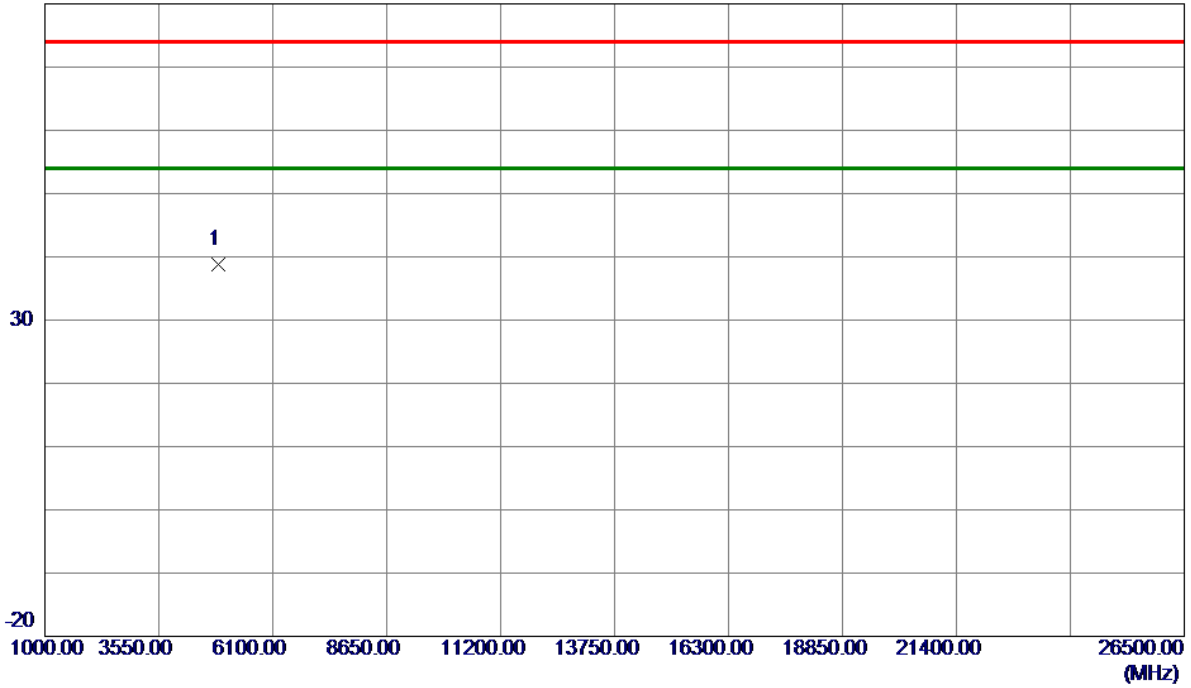

No.	Freq. MHz	Reading Level dBuV/m	Correct Factor dB	Measure ment dBuV/m	Limit dBuV/m	Margin dB	Detector	Comment
1 *	4874.0000	51.67	-12.87	38.80	74.00	-35.20	Peak	

**REMARKS:**

- (1) Measurement Value = Reading Level + Correct Factor.
- (2) Margin Level = Measurement Value - Limit Value.

Test Mode: TX G Mode 2437 MHz

### Horizontal

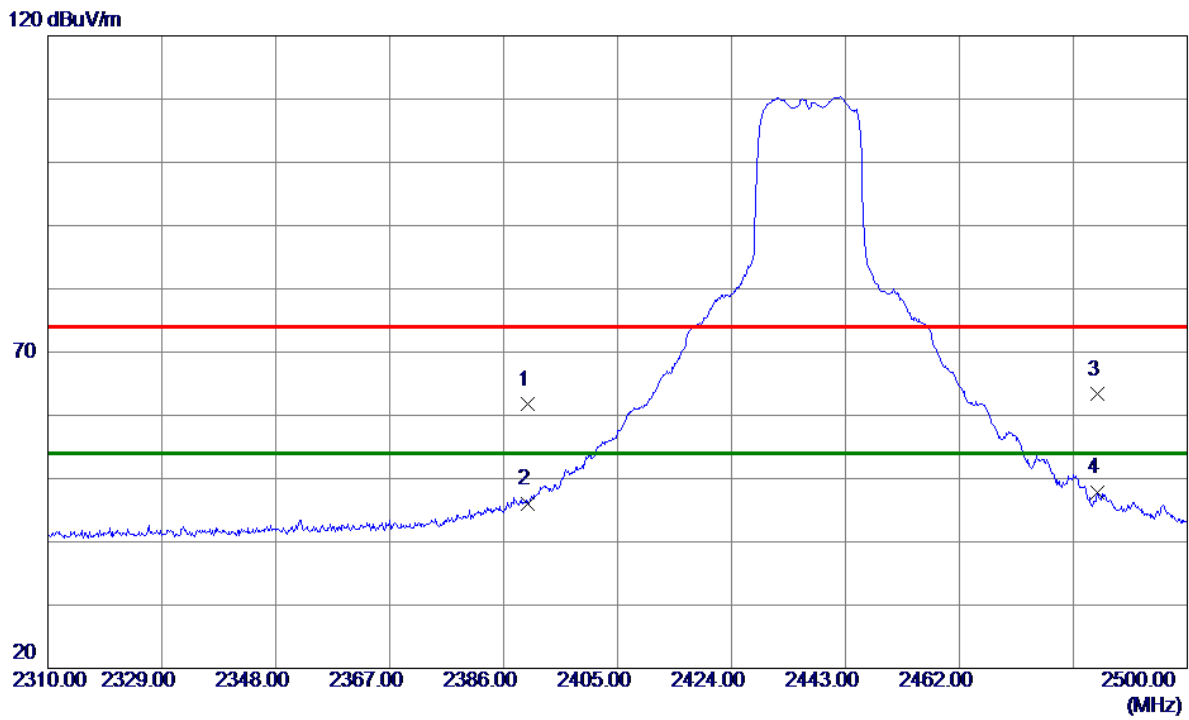

No.	Freq. MHz	Reading Level dBuV/m	Correct Factor dB	Measure ment dBuV/m	Limit dBuV/m	Margin dB	Detector	Comment
1	2390.0000	28.34	33.36	61.70	74.00	-12.30	Peak	
2	2390.0000	12.71	33.36	46.07	54.00	-7.93	AVG	
3	2484.9900	29.53	33.77	63.30	74.00	-10.70	Peak	
4 *	2484.9900	14.03	33.77	47.80	54.00	-6.20	AVG	

**REMARKS:**

- (1) Measurement Value = Reading Level + Correct Factor.
- (2) Margin Level = Measurement Value - Limit Value.

Test Mode: TX G Mode 2437 MHz

### Horizontal

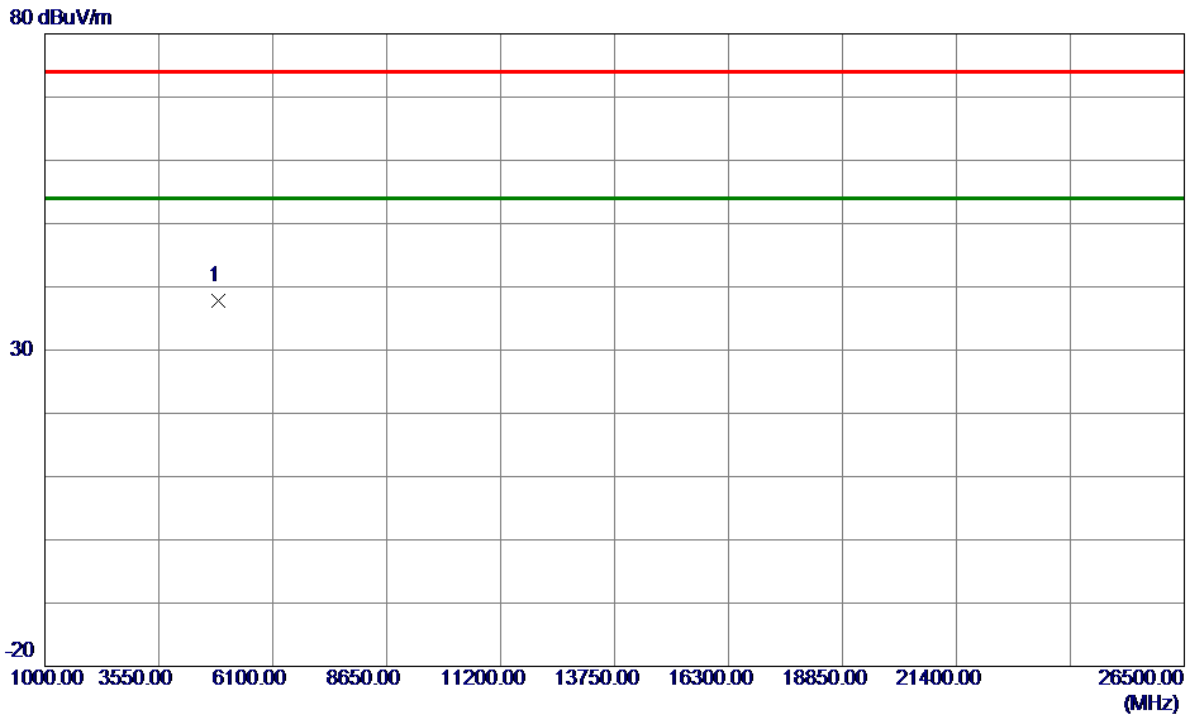

No.	Freq. MHz	Reading Level dBuV/m	Correct Factor dB	Measure ment dBuV/m	Limit dBuV/m	Margin dB	Detector	Comment
1 *	4874.0000	50.64	-12.87	37.77	74.00	-36.23	Peak	

**REMARKS:**

- (1) Measurement Value = Reading Level + Correct Factor.
- (2) Margin Level = Measurement Value - Limit Value.

Test Mode: TX G Mode 2462 MHz

### Vertical

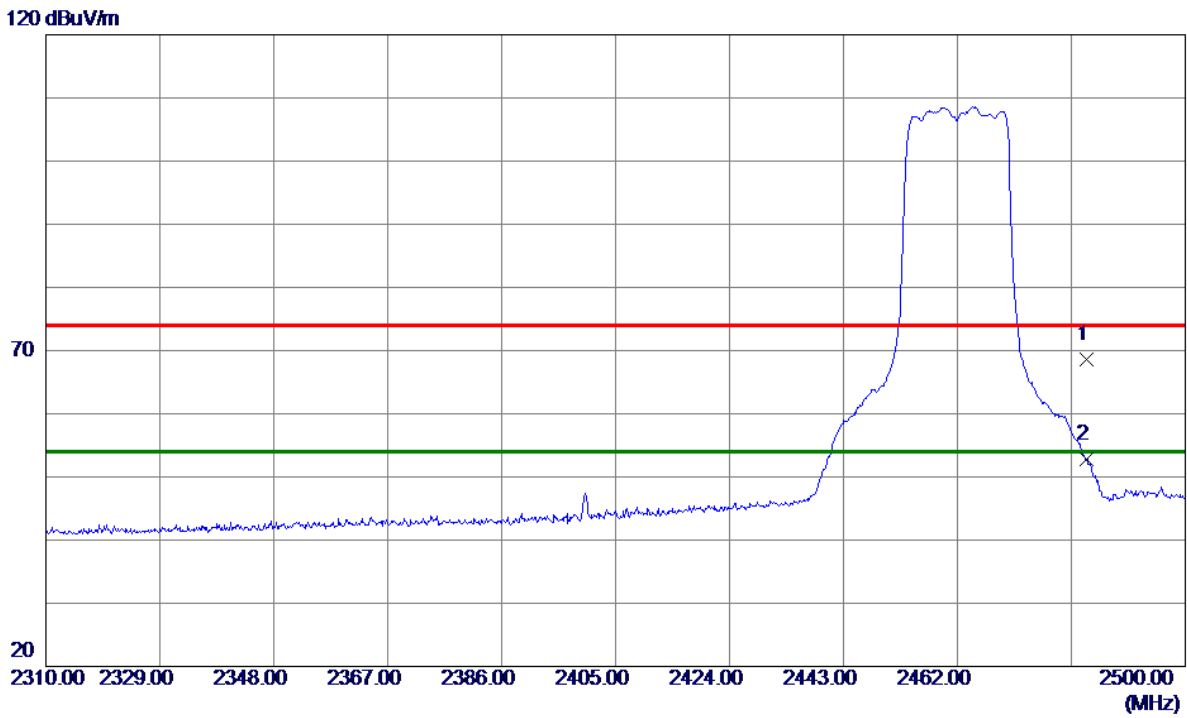

No.	Freq. MHz	Reading Level dBuV/m	Correct Factor dB	Measure ment dBuV/m	Limit dBuV/m	Margin dB	Detector	Comment
1	2483.5000	34.85	33.76	68.61	74.00	-5.39	Peak	
2 *	2483.5000	19.08	33.76	52.84	54.00	-1.16	AVG	

**REMARKS:**

- (1) Measurement Value = Reading Level + Correct Factor.
- (2) Margin Level = Measurement Value - Limit Value.

Test Mode: TX G Mode 2462 MHz

### Vertical

80 dBuV/m

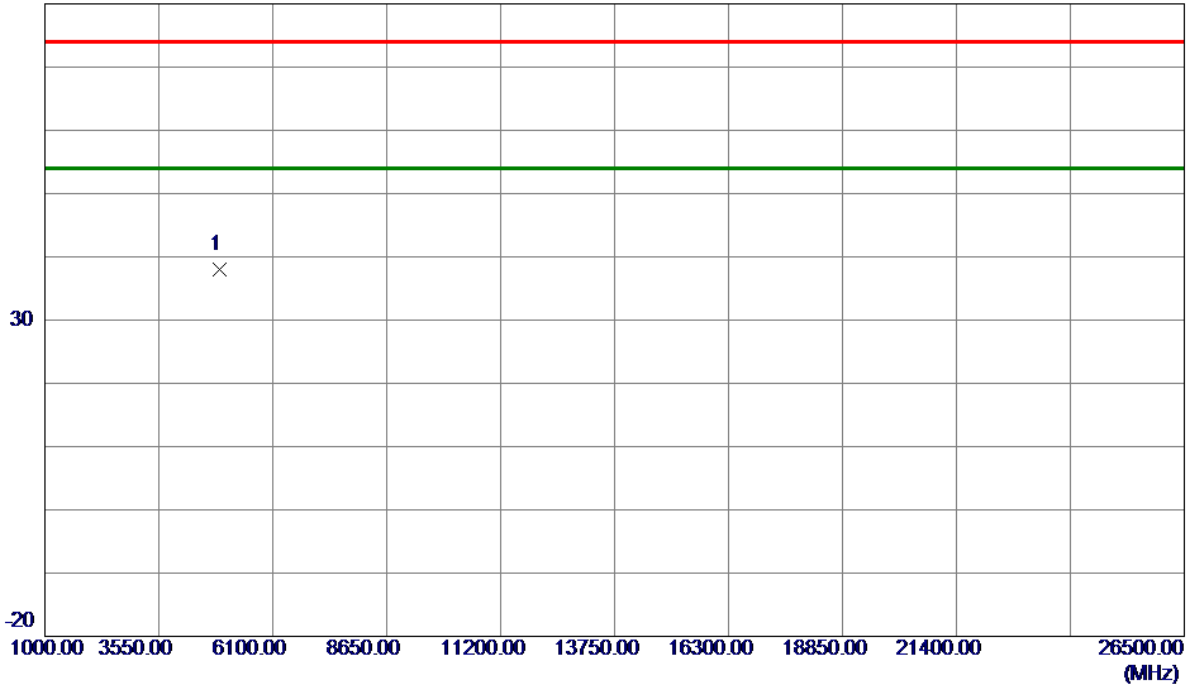

No.	Freq. MHz	Reading Level dBuV/m	Correct Factor dB	Measure ment dBuV/m	Limit dBuV/m	Margin dB	Detector	Comment
1 *	4924.0000	50.80	-12.71	38.09	74.00	-35.91	Peak	

**REMARKS:**

- (1) Measurement Value = Reading Level + Correct Factor.
- (2) Margin Level = Measurement Value - Limit Value.

Test Mode: TX G Mode 2462 MHz

### Horizontal

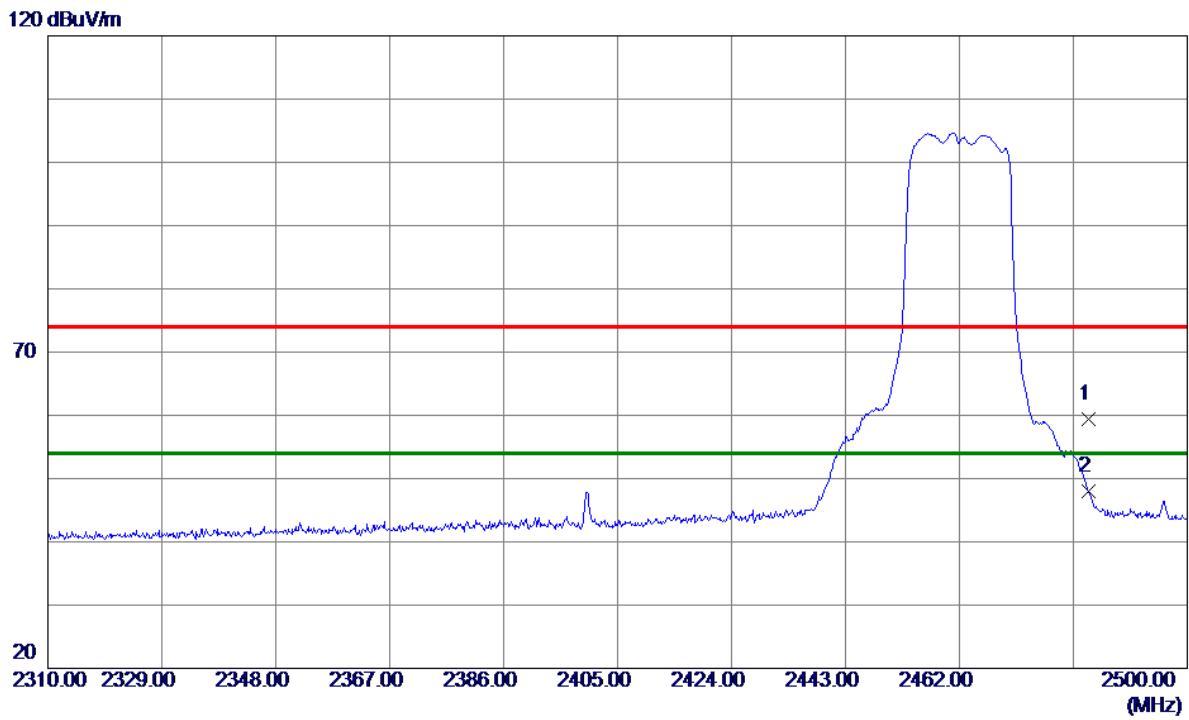

No.	Freq. MHz	Reading Level dBuV/m	Correct Factor dB	Measure ment dBuV/m	Limit dBuV/m	Margin dB	Detector	Comment
1	2483.5000	25.64	33.76	59.40	74.00	-14.60	Peak	
2 *	2483.5000	14.18	33.76	47.94	54.00	-6.06	AVG	

**REMARKS:**

- (1) Measurement Value = Reading Level + Correct Factor.
- (2) Margin Level = Measurement Value - Limit Value.

Test Mode: TX G Mode 2462 MHz

### Horizontal

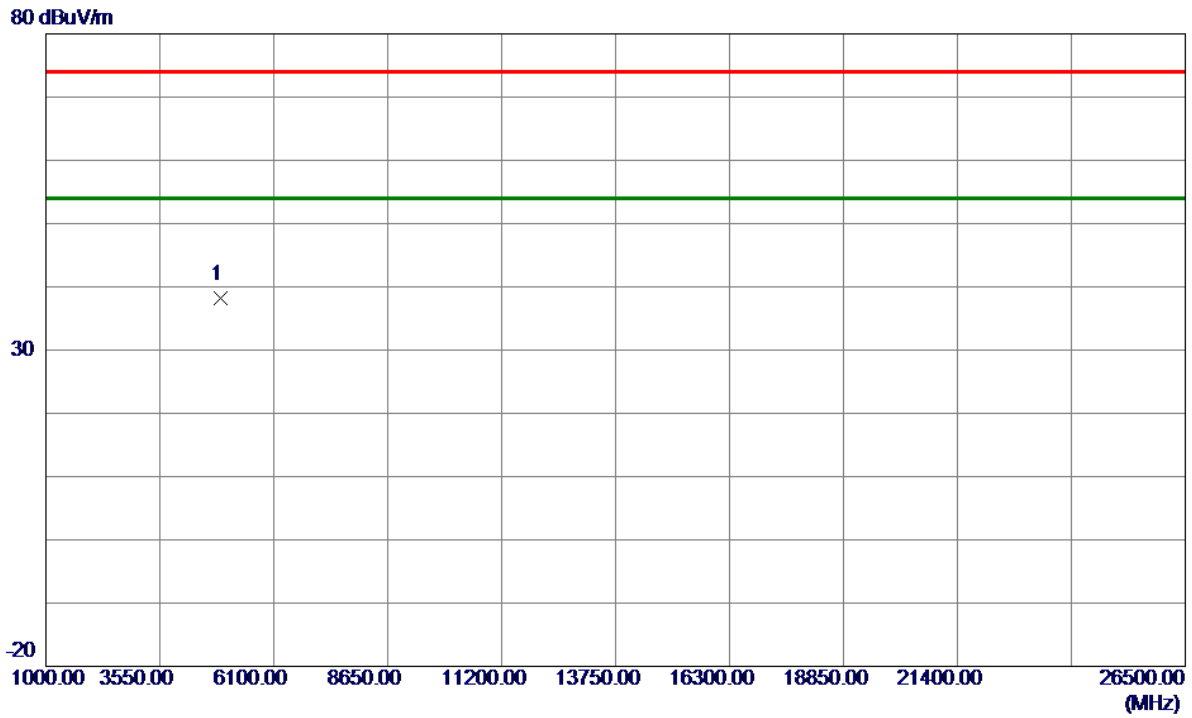

No.	Freq. MHz	Reading Level dBuV/m	Correct Factor dB	Measure ment dBuV/m	Limit dBuV/m	Margin dB	Detector	Comment
1 *	4924.0000	50.81	-12.71	38.10	74.00	-35.90	Peak	

**REMARKS:**

- (1) Measurement Value = Reading Level + Correct Factor.
- (2) Margin Level = Measurement Value - Limit Value.



Test Mode: TX N-20M Mode 2412 MHz

### Vertical

120 dBuV/m

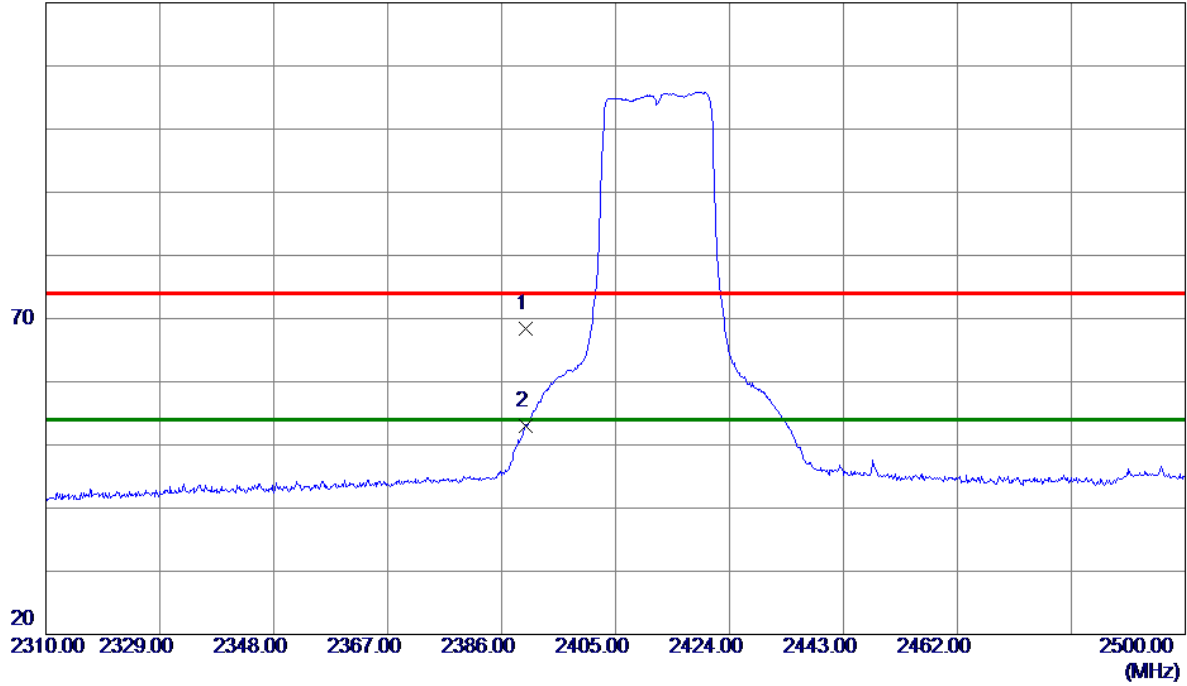

No.	Freq. MHz	Reading Level dBuV/m	Correct Factor dB	Measure ment dBuV/m	Limit dBuV/m	Margin dB	Detector	Comment
1	2390.0000	35.12	33.36	68.48	74.00	-5.52	Peak	
2 *	2390.0000	19.65	33.36	53.01	54.00	-0.99	AVG	

**REMARKS:**

- (1) Measurement Value = Reading Level + Correct Factor.
- (2) Margin Level = Measurement Value - Limit Value.

Test Mode: TX N-20M Mode 2412 MHz

### Vertical

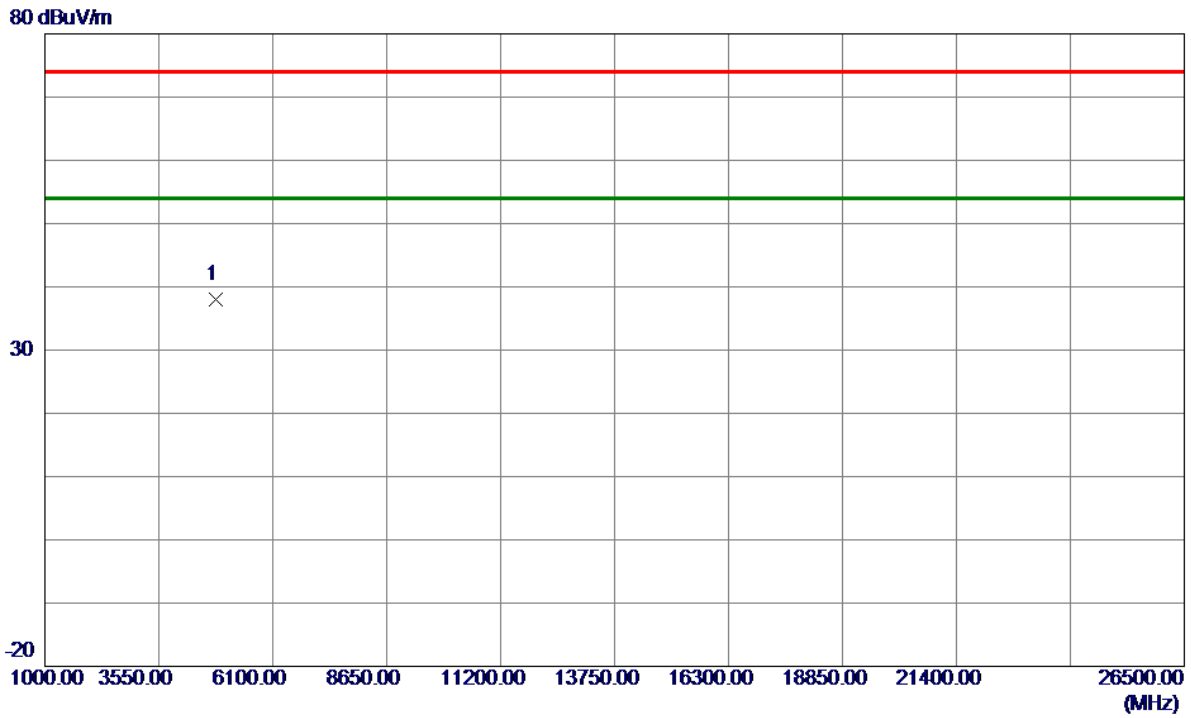

No.	Freq. MHz	Reading Level dBuV/m	Correct Factor dB	Measure ment dBuV/m	Limit dBuV/m	Margin dB	Detector	Comment
1 *	4824.0000	51.08	-13.02	38.06	74.00	-35.94	Peak	

**REMARKS:**

- (1) Measurement Value = Reading Level + Correct Factor.
- (2) Margin Level = Measurement Value - Limit Value.

Test Mode: TX N-20M Mode 2412 MHz

### Horizontal

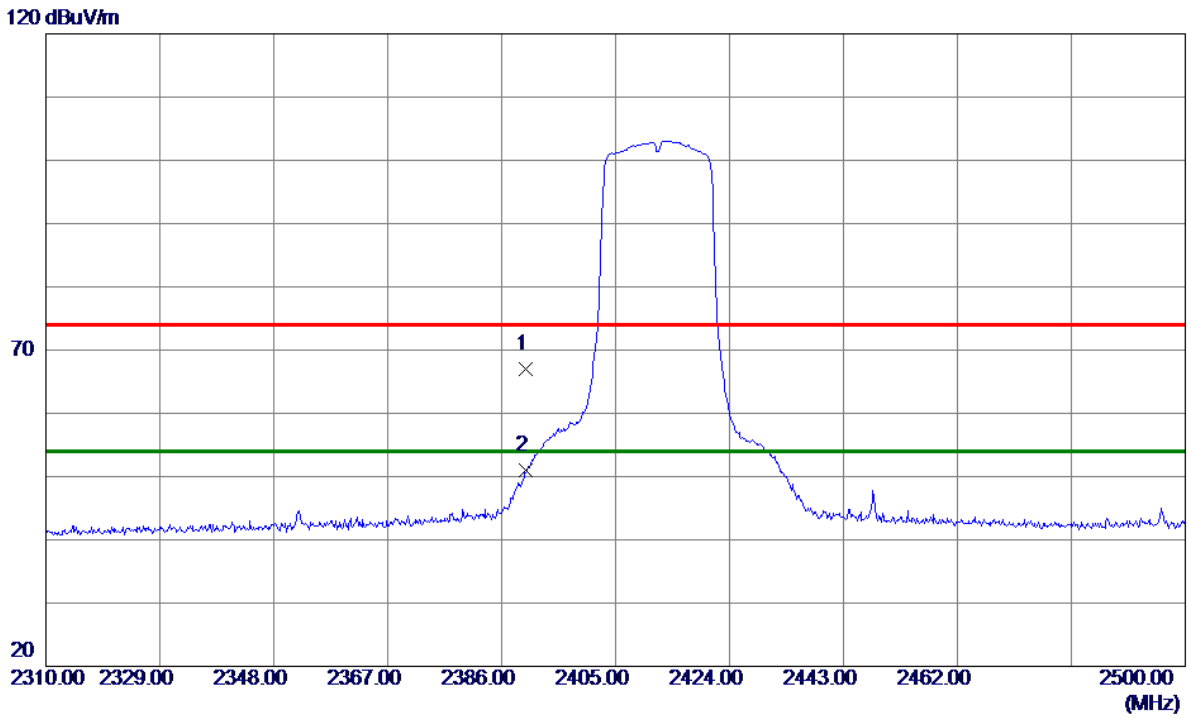

No.	Freq. MHz	Reading Level dBuV/m	Correct Factor dB	Measure ment dBuV/m	Limit dBuV/m	Margin dB	Detector	Comment
1	2390.0000	33.70	33.36	67.06	74.00	-6.94	Peak	
2 *	2390.0000	17.70	33.36	51.06	54.00	-2.94	AVG	

**REMARKS:**

- (1) Measurement Value = Reading Level + Correct Factor.
- (2) Margin Level = Measurement Value - Limit Value.

Test Mode: TX N-20M Mode 2412 MHz

### Horizontal

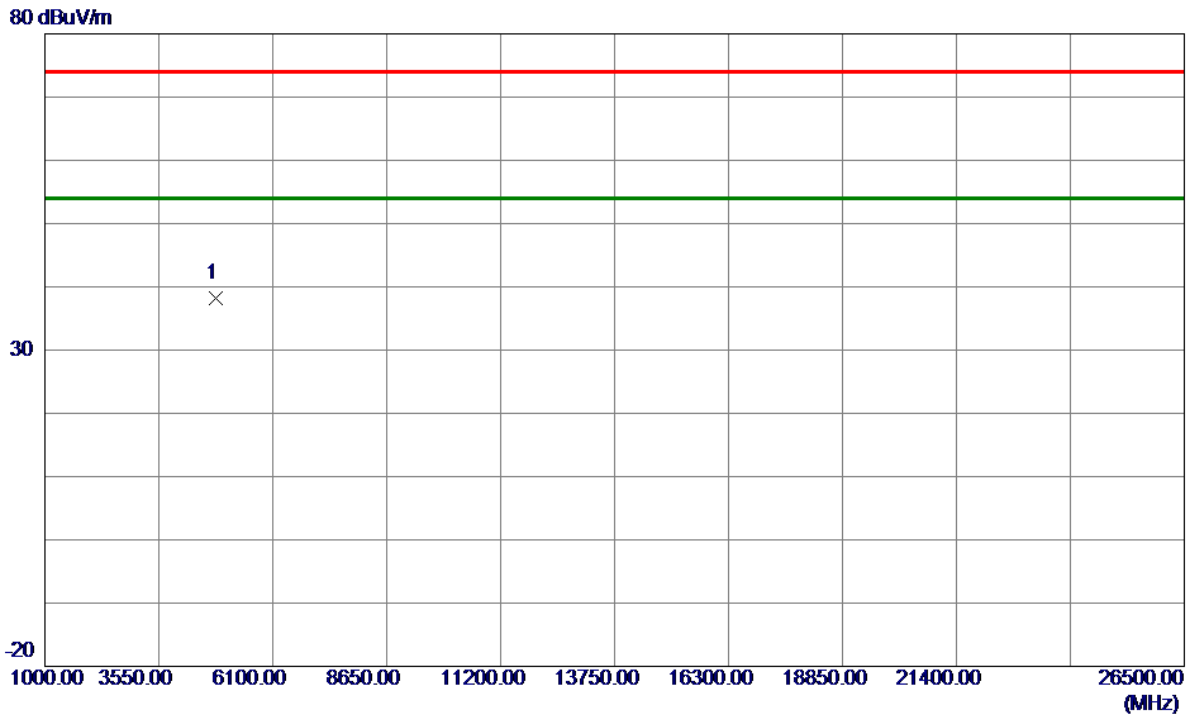

No.	Freq. MHz	Reading Level dBuV/m	Correct Factor dB	Measure ment dBuV/m	Limit dBuV/m	Margin dB	Detector	Comment
1 *	4824.0000	51.22	-13.02	38.20	74.00	-35.80	Peak	

**REMARKS:**

- (1) Measurement Value = Reading Level + Correct Factor.
- (2) Margin Level = Measurement Value - Limit Value.

Test Mode: TX N-20M Mode 2437 MHz

### Vertical

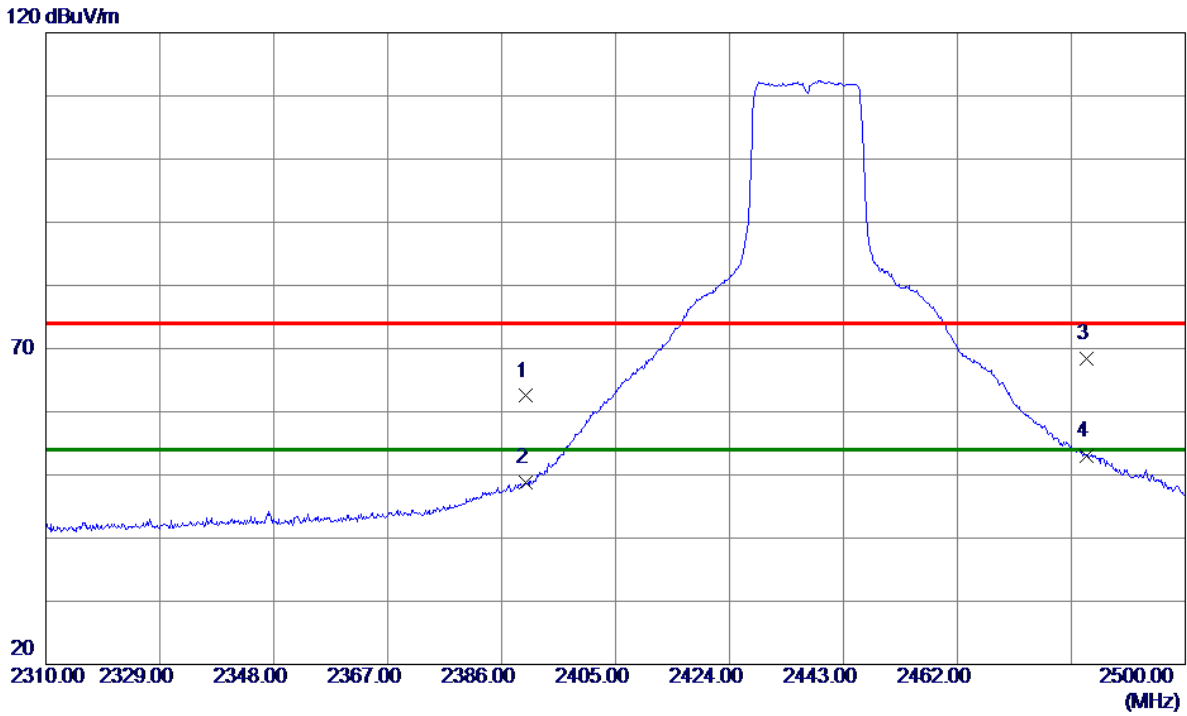

No.	Freq. MHz	Reading Level dBuV/m	Correct Factor dB	Measure ment dBuV/m	Limit dBuV/m	Margin dB	Detector	Comment
1	2390.0000	29.14	33.36	62.50	74.00	-11.50	Peak	
2	2390.0000	15.46	33.36	48.82	54.00	-5.18	AVG	
3	2483.5000	34.65	33.76	68.41	74.00	-5.59	Peak	
4 *	2483.5000	19.15	33.76	52.91	54.00	-1.09	AVG	

**REMARKS:**

- (1) Measurement Value = Reading Level + Correct Factor.
- (2) Margin Level = Measurement Value - Limit Value.

Test Mode: TX N-20M Mode 2437 MHz

### Vertical

80 dBuV/m

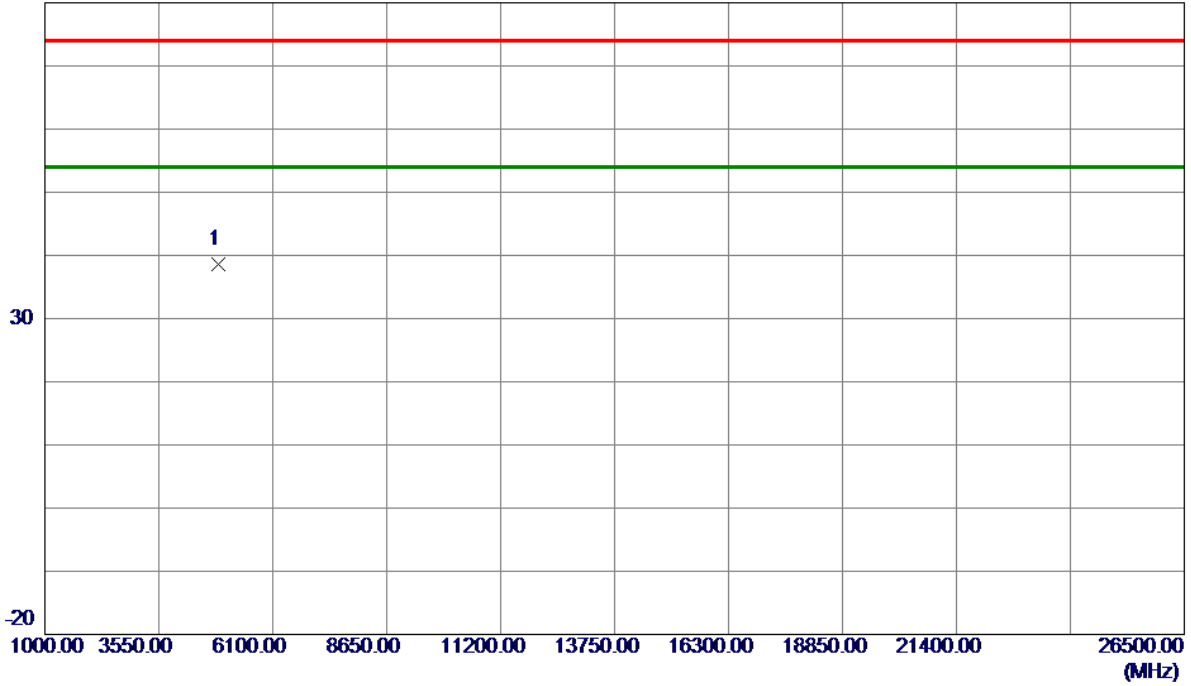

No.	Freq. MHz	Reading Level dBuV/m	Correct Factor dB	Measure ment dBuV/m	Limit dBuV/m	Margin dB	Detector	Comment
1 *	4874.0000	51.38	-12.87	38.51	74.00	-35.49	Peak	

**REMARKS:**

- (1) Measurement Value = Reading Level + Correct Factor.
- (2) Margin Level = Measurement Value - Limit Value.

Test Mode: TX N-20M Mode 2437 MHz

### Horizontal

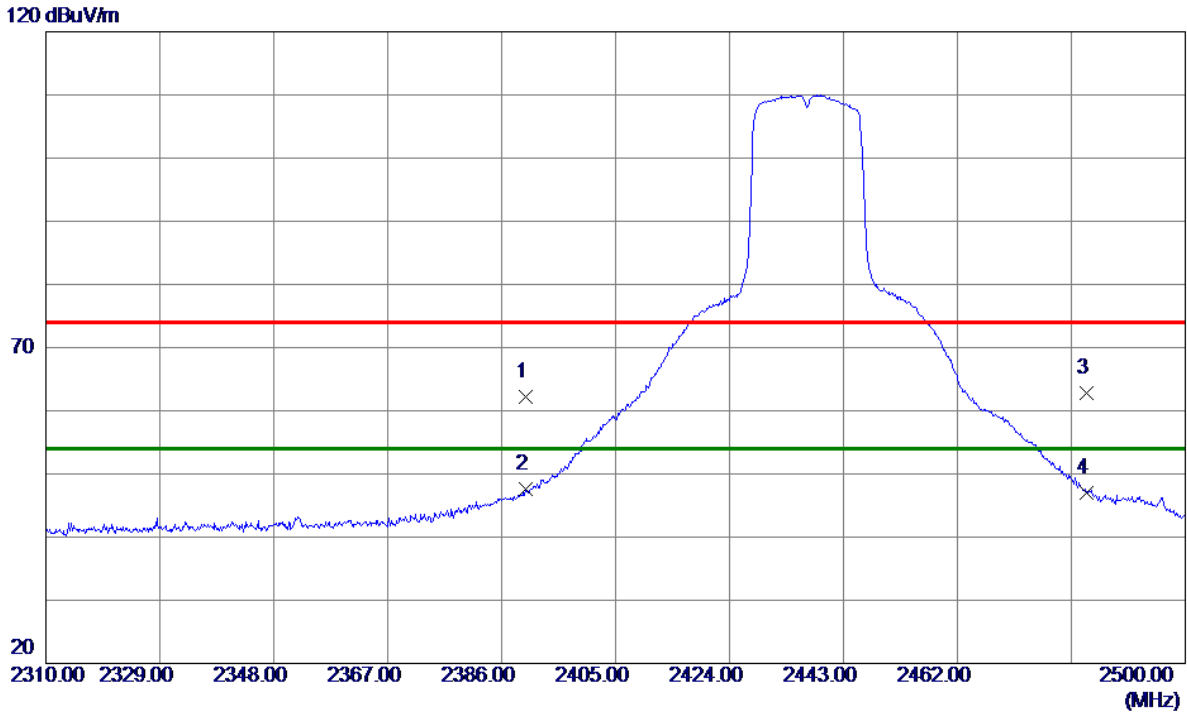

No.	Freq. MHz	Reading Level dBuV/m	Correct Factor dB	Measure ment dBuV/m	Limit dBuV/m	Margin dB	Detector	Comment
1	2390.0000	28.75	33.36	62.11	74.00	-11.89	Peak	
2 *	2390.0000	14.19	33.36	47.55	54.00	-6.45	AVG	
3	2483.5000	29.13	33.76	62.89	74.00	-11.11	Peak	
4	2483.5000	13.29	33.76	47.05	54.00	-6.95	AVG	

**REMARKS:**

- (1) Measurement Value = Reading Level + Correct Factor.
- (2) Margin Level = Measurement Value - Limit Value.

Test Mode: TX N-20M Mode 2437 MHz

### Horizontal

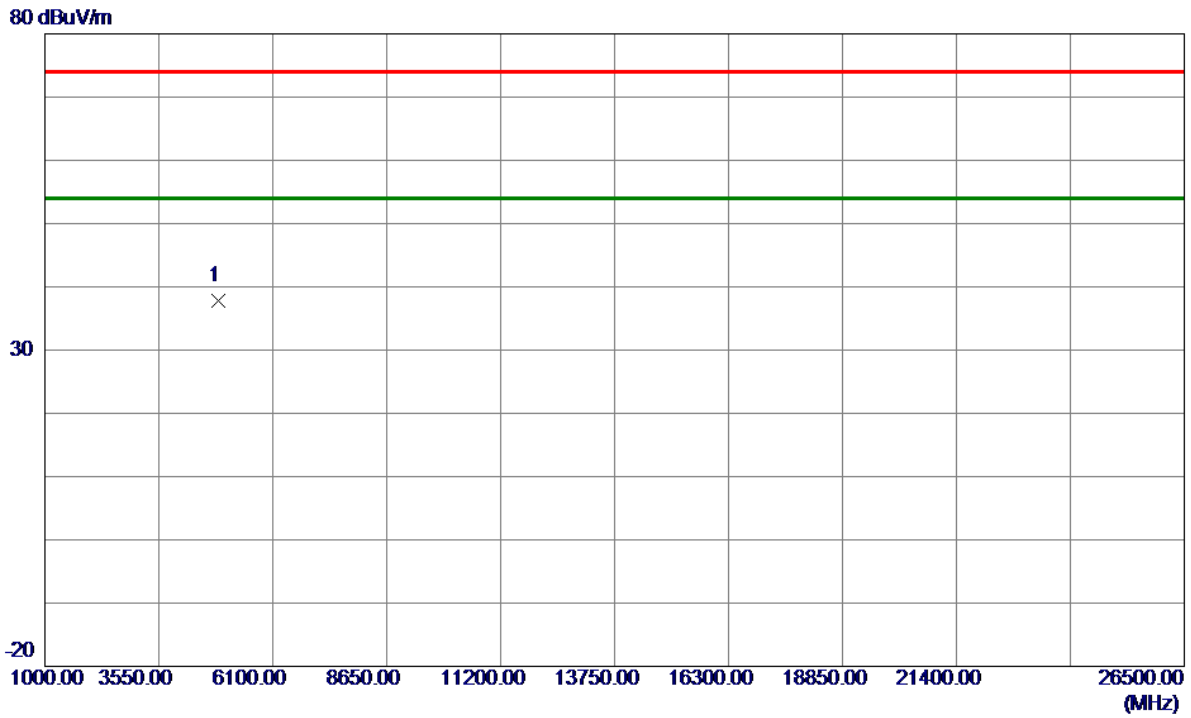

No.	Freq. MHz	Reading Level dBuV/m	Correct Factor dB	Measure ment dBuV/m	Limit dBuV/m	Margin dB	Detector	Comment
1 *	4874.0000	50.69	-12.87	37.82	74.00	-36.18	Peak	

**REMARKS:**

- (1) Measurement Value = Reading Level + Correct Factor.
- (2) Margin Level = Measurement Value - Limit Value.



Test Mode: TX N-20M Mode 2462 MHz

### Vertical

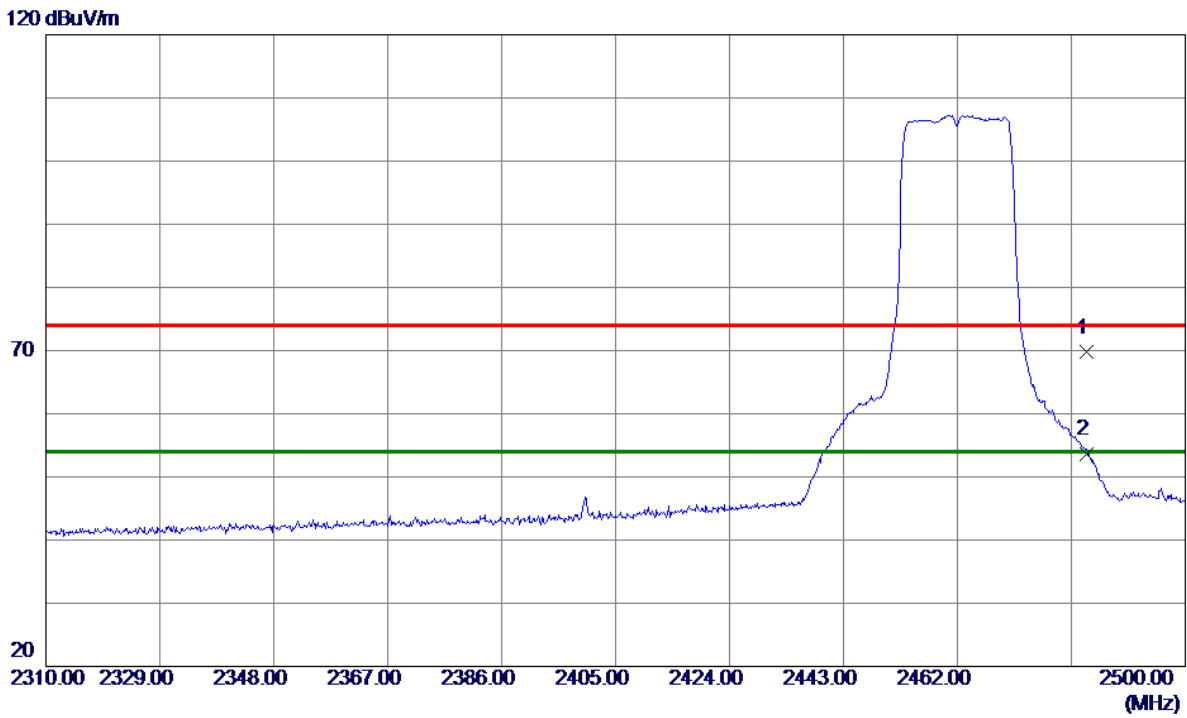

No.	Freq. MHz	Reading Level dBuV/m	Correct Factor dB	Measure ment dBuV/m	Limit dBuV/m	Margin dB	Detector	Comment
1	2483.5000	35.94	33.76	69.70	74.00	-4.30	Peak	
2 *	2483.5000	19.91	33.76	53.67	54.00	-0.33	AVG	

**REMARKS:**

- (1) Measurement Value = Reading Level + Correct Factor.
- (2) Margin Level = Measurement Value - Limit Value.

Test Mode: TX N-20M Mode 2462 MHz

### Vertical

80 dBuV/m

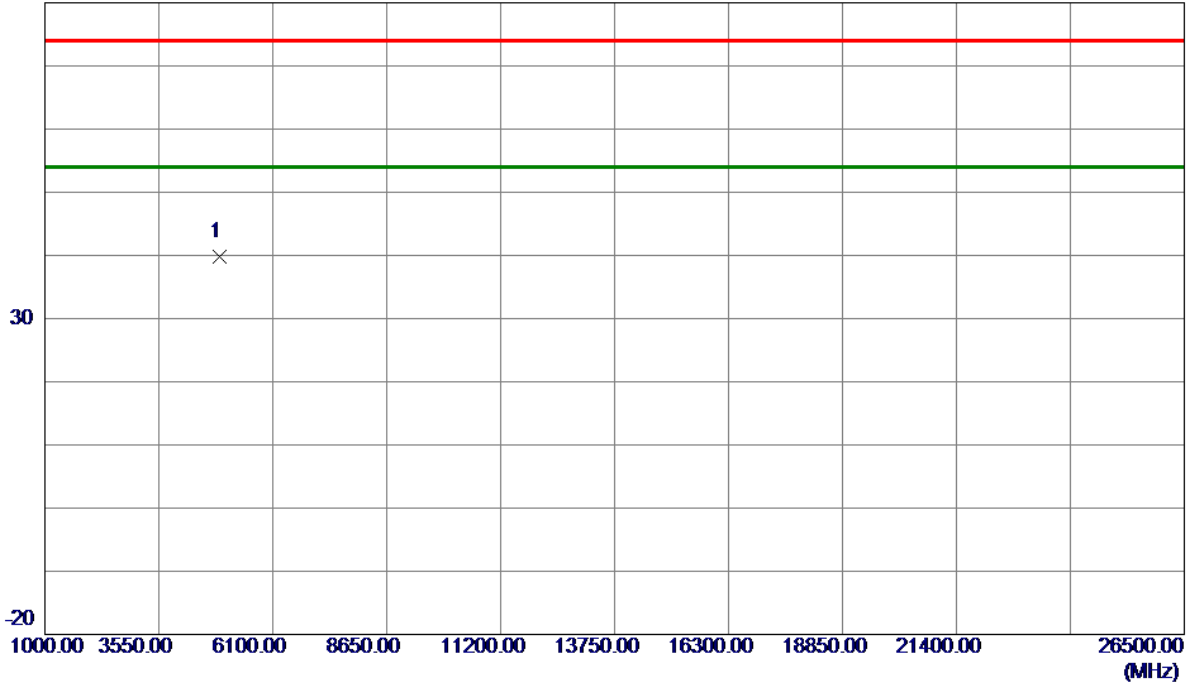

No.	Freq. MHz	Reading Level dBuV/m	Correct Factor dB	Measure ment dBuV/m	Limit dBuV/m	Margin dB	Detector	Comment
1 *	4924.0000	52.43	-12.71	39.72	74.00	-34.28	Peak	

**REMARKS:**

- (1) Measurement Value = Reading Level + Correct Factor.
- (2) Margin Level = Measurement Value - Limit Value.

Test Mode: TX N-20M Mode 2462 MHz

### Horizontal

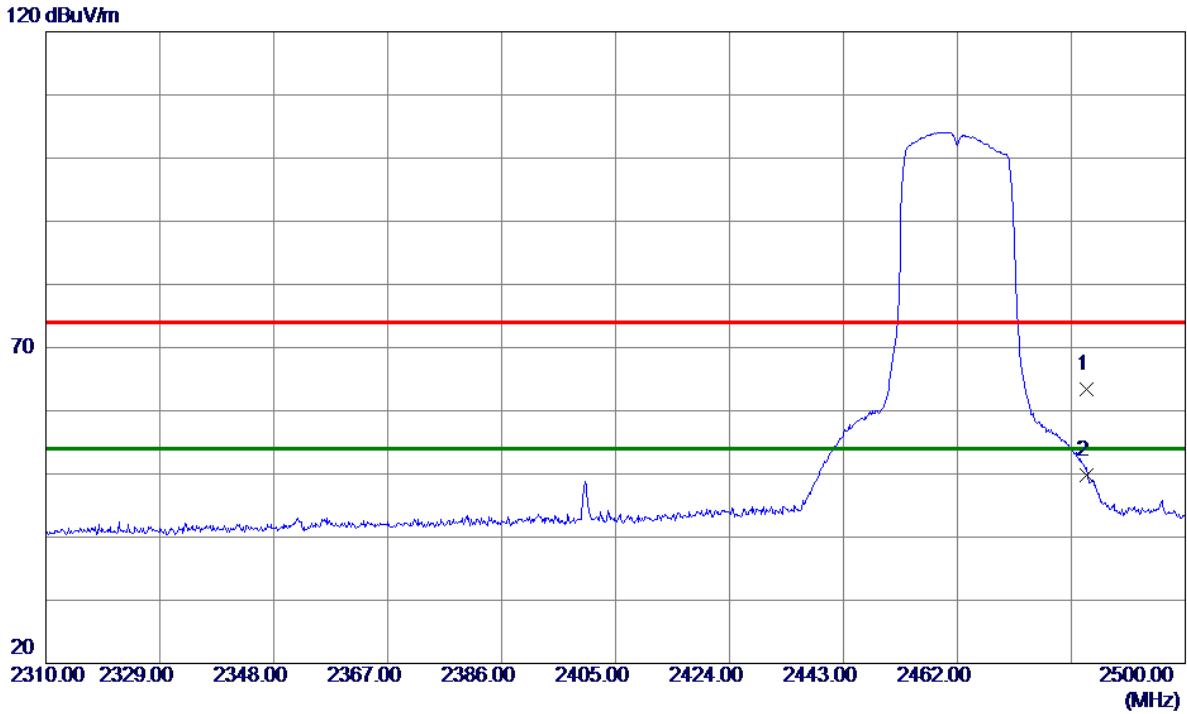

No.	Freq. MHz	Reading Level dBuV/m	Correct Factor dB	Measure ment dBuV/m	Limit dBuV/m	Margin dB	Detector	Comment
1	2483.5000	29.71	33.76	63.47	74.00	-10.53	Peak	
2 *	2483.5000	16.13	33.76	49.89	54.00	-4.11	AVG	

**REMARKS:**

- (1) Measurement Value = Reading Level + Correct Factor.
- (2) Margin Level = Measurement Value - Limit Value.

Test Mode: TX N-20M Mode 2462 MHz

### Horizontal

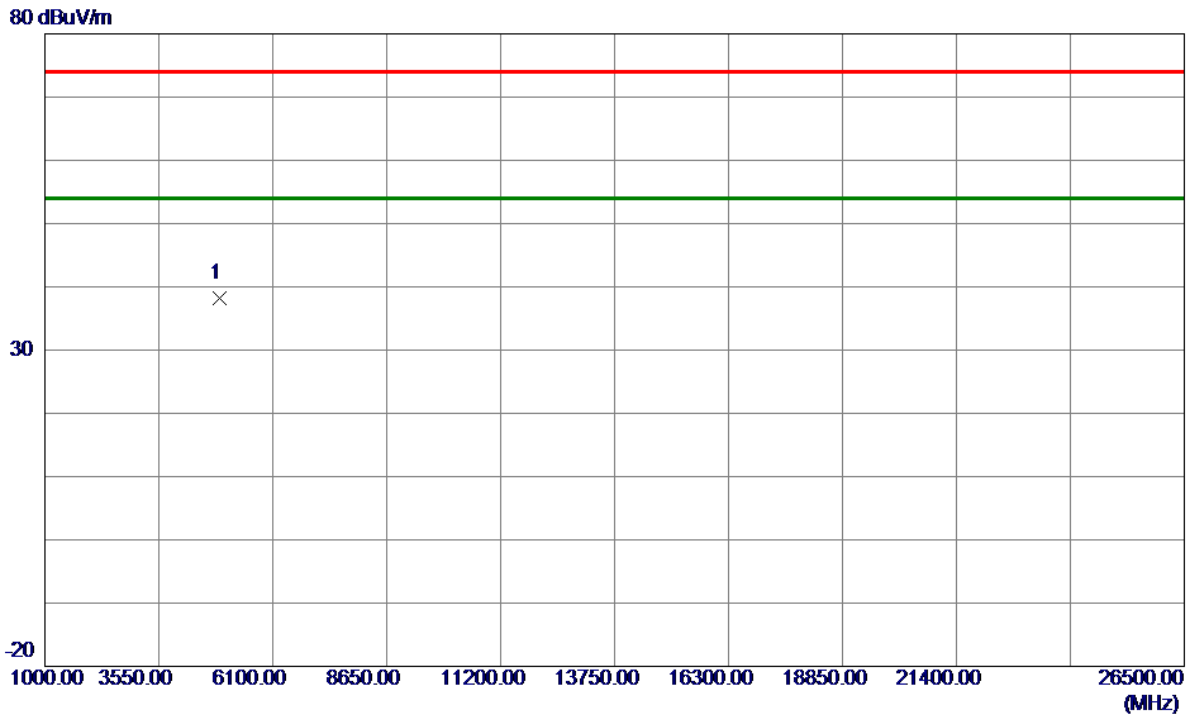

No.	Freq. MHz	Reading Level dBuV/m	Correct Factor dB	Measure ment dBuV/m	Limit dBuV/m	Margin dB	Detector	Comment
1 *	4924.0000	50.90	-12.71	38.19	74.00	-35.81	Peak	

**REMARKS:**

- (1) Measurement Value = Reading Level + Correct Factor.
- (2) Margin Level = Measurement Value - Limit Value.

Test Mode: TX N-40M Mode 2422MHz

### Vertical

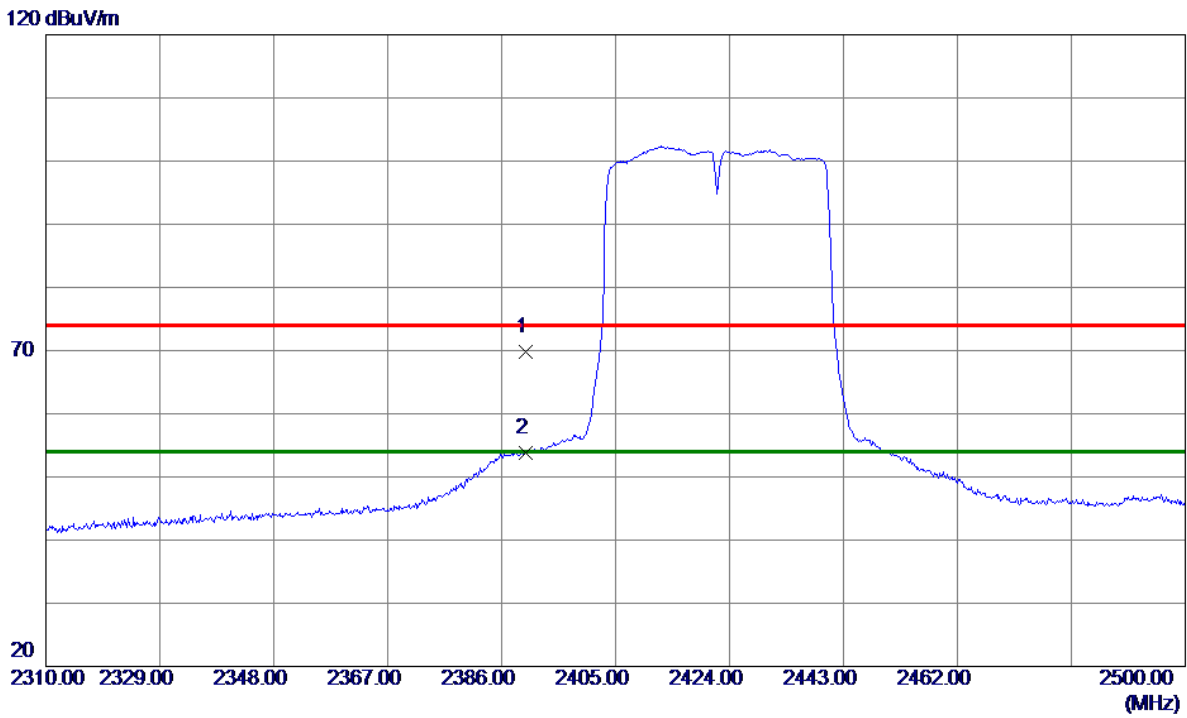

No.	Freq. MHz	Reading Level dBuV/m	Correct Factor dB	Measure ment dBuV/m	Limit dBuV/m	Margin dB	Detector	Comment
1	2390.0000	36.48	33.36	69.84	74.00	-4.16	Peak	
2 *	2390.0000	20.43	33.36	53.79	54.00	-0.21	AVG	

**REMARKS:**

- (1) Measurement Value = Reading Level + Correct Factor.
- (2) Margin Level = Measurement Value - Limit Value.

Test Mode: TX N-40M Mode 2422MHz

### Vertical

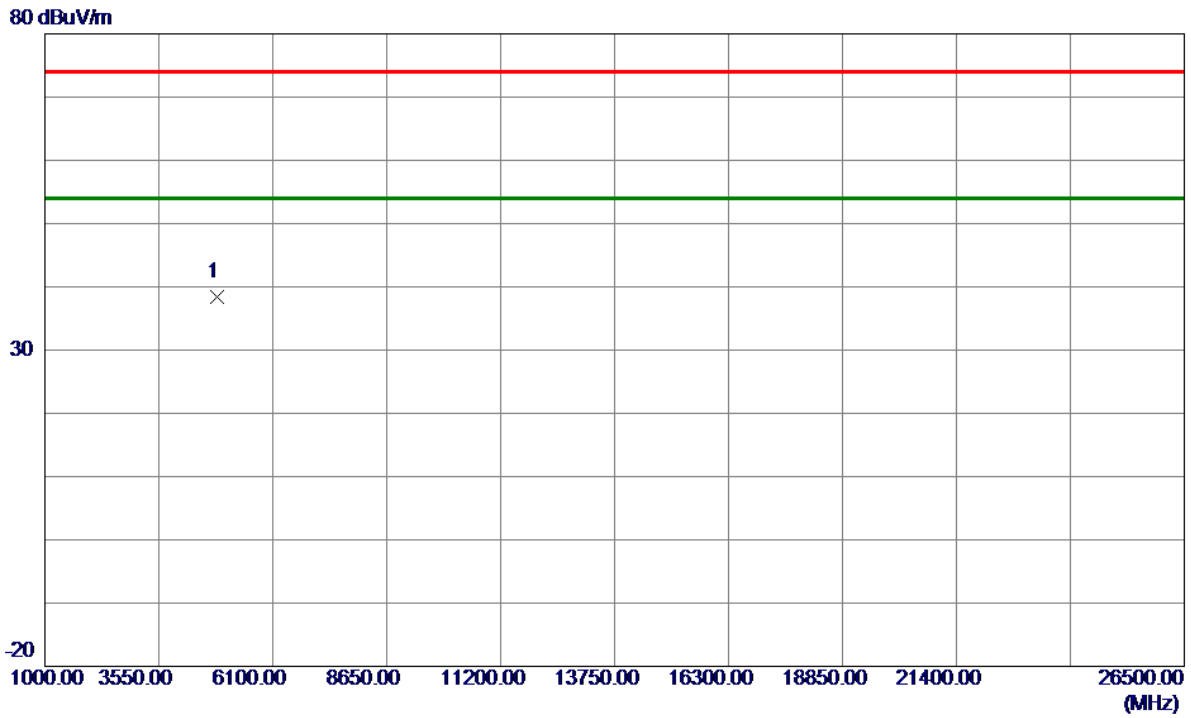

No.	Freq. MHz	Reading Level dBuV/m	Correct Factor dB	Measure ment dBuV/m	Limit dBuV/m	Margin dB	Detector	Comment
1 *	4844.0000	51.34	-12.96	38.38	74.00	-35.62	Peak	

**REMARKS:**

- (1) Measurement Value = Reading Level + Correct Factor.
- (2) Margin Level = Measurement Value - Limit Value.

Test Mode: TX N-40M Mode 2422MHz

### Horizontal

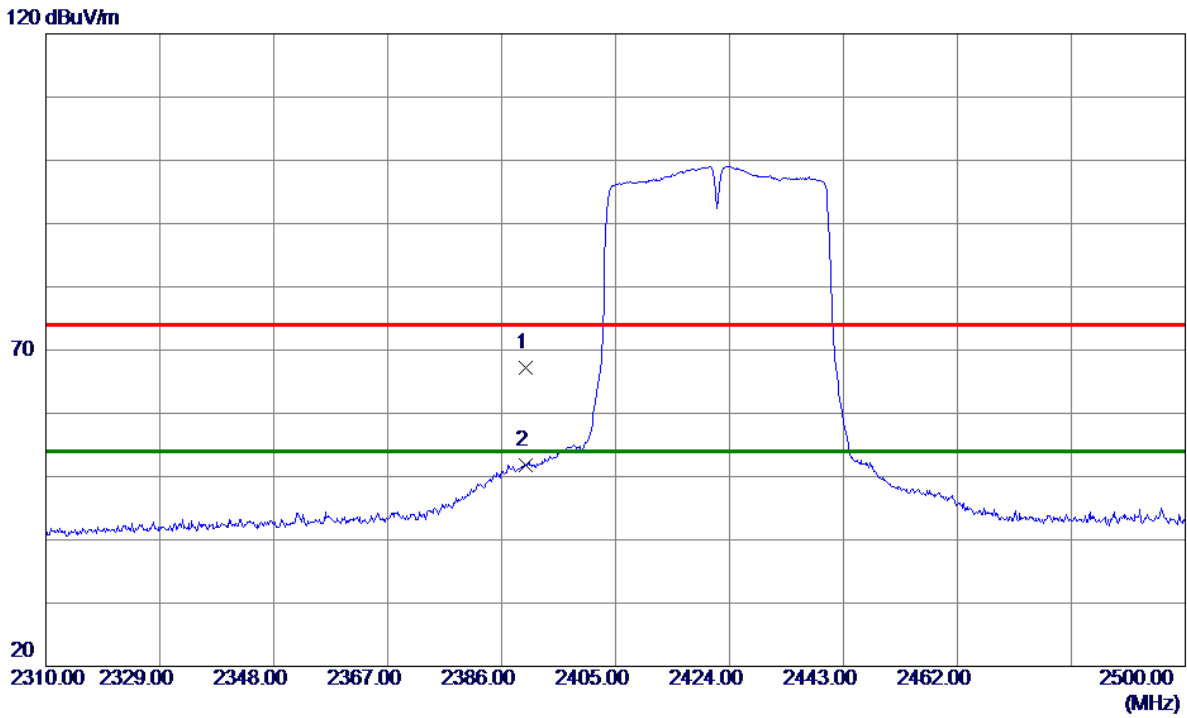

No.	Freq. MHz	Reading Level dBuV/m	Correct Factor dB	Measure ment dBuV/m	Limit dBuV/m	Margin dB	Detector	Comment
1	2390.0000	33.77	33.36	67.13	74.00	-6.87	Peak	
2 *	2390.0000	18.36	33.36	51.72	54.00	-2.28	AVG	

**REMARKS:**

- (1) Measurement Value = Reading Level + Correct Factor.
- (2) Margin Level = Measurement Value - Limit Value.

Test Mode: TX N-40M Mode 2422MHz

### Horizontal

80 dBuV/m

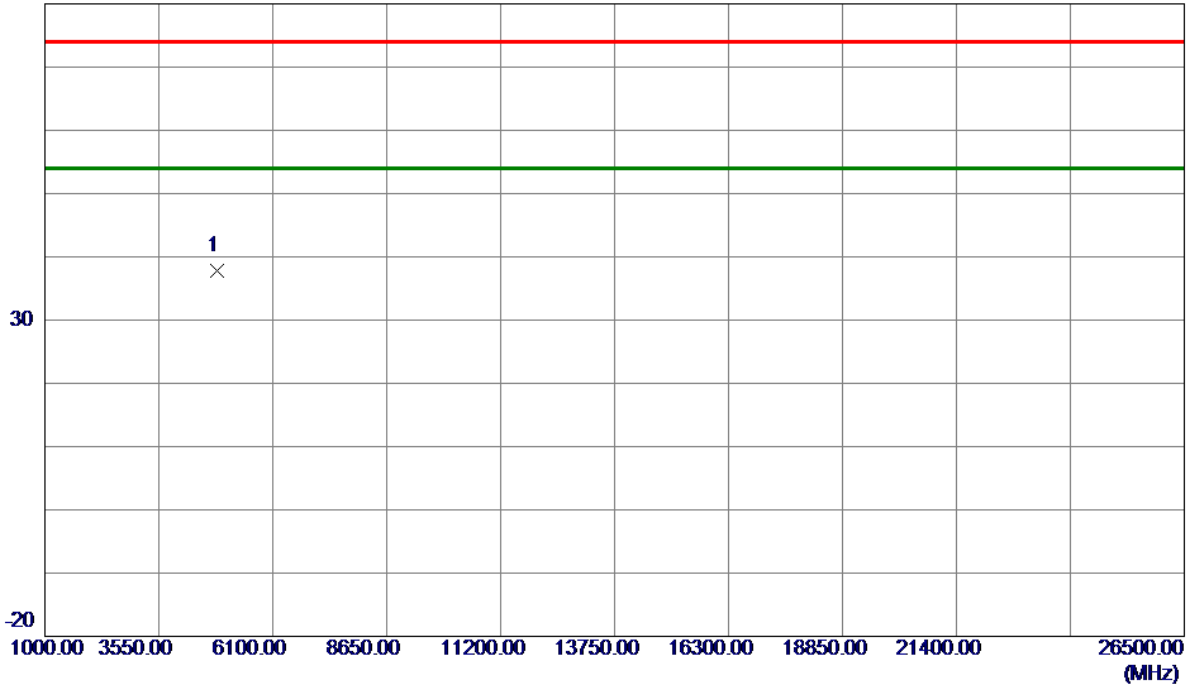

No.	Freq. MHz	Reading Level dBuV/m	Correct Factor dB	Measure ment dBuV/m	Limit dBuV/m	Margin dB	Detector	Comment
1 *	4844.0000	50.76	-12.96	37.80	74.00	-36.20	Peak	

**REMARKS:**

- (1) Measurement Value = Reading Level + Correct Factor.
- (2) Margin Level = Measurement Value - Limit Value.



Test Mode: TX N-40M Mode 2437 MHz

### Vertical

120 dBuV/m

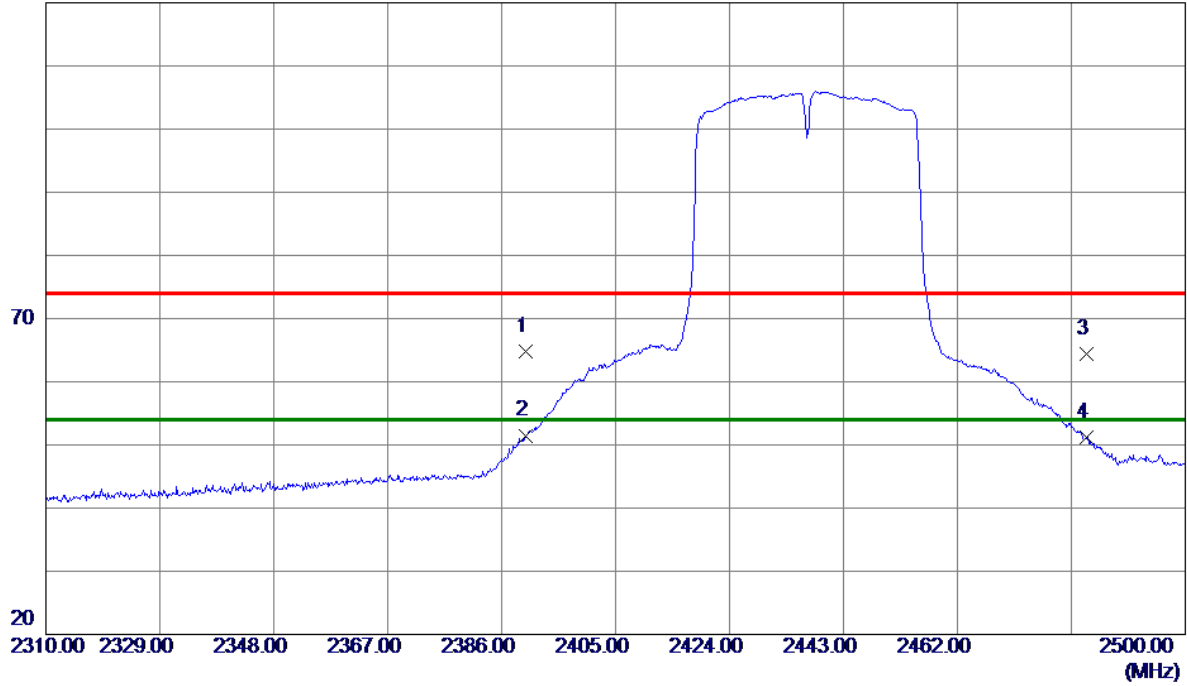

No.	Freq. MHz	Reading Level dBuV/m	Correct Factor dB	Measure ment dBuV/m	Limit dBuV/m	Margin dB	Detector	Comment
1	2390.0000	31.45	33.36	64.81	74.00	-9.19	Peak	
2 *	2390.0000	18.14	33.36	51.50	54.00	-2.50	AVG	
3	2483.5000	30.59	33.76	64.35	74.00	-9.65	Peak	
4	2483.5000	17.50	33.76	51.26	54.00	-2.74	AVG	

**REMARKS:**

- (1) Measurement Value = Reading Level + Correct Factor.
- (2) Margin Level = Measurement Value - Limit Value.

Test Mode: TX N-40M Mode 2437 MHz

### Vertical

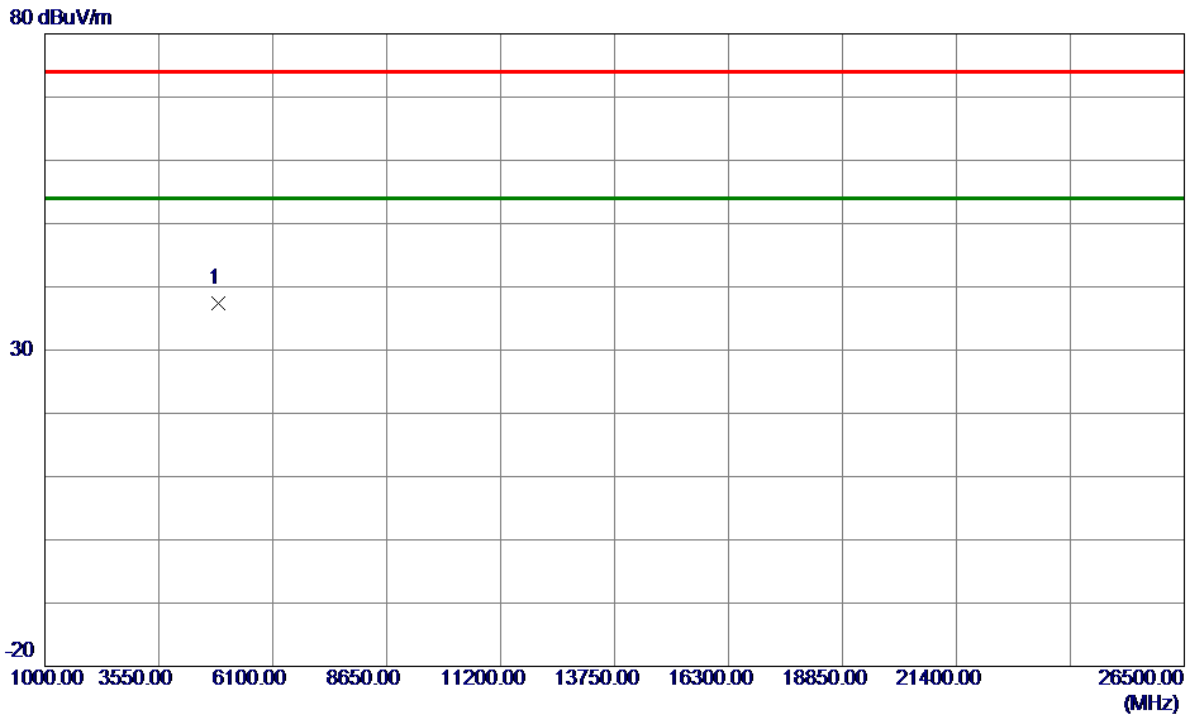

No.	Freq. MHz	Reading Level dBuV/m	Correct Factor dB	Measure ment dBuV/m	Limit dBuV/m	Margin dB	Detector	Comment
1 *	4874.0000	50.29	-12.87	37.42	74.00	-36.58	Peak	

**REMARKS:**

- (1) Measurement Value = Reading Level + Correct Factor.
- (2) Margin Level = Measurement Value - Limit Value.

Test Mode: TX N-40M Mode 2437 MHz

### Horizontal

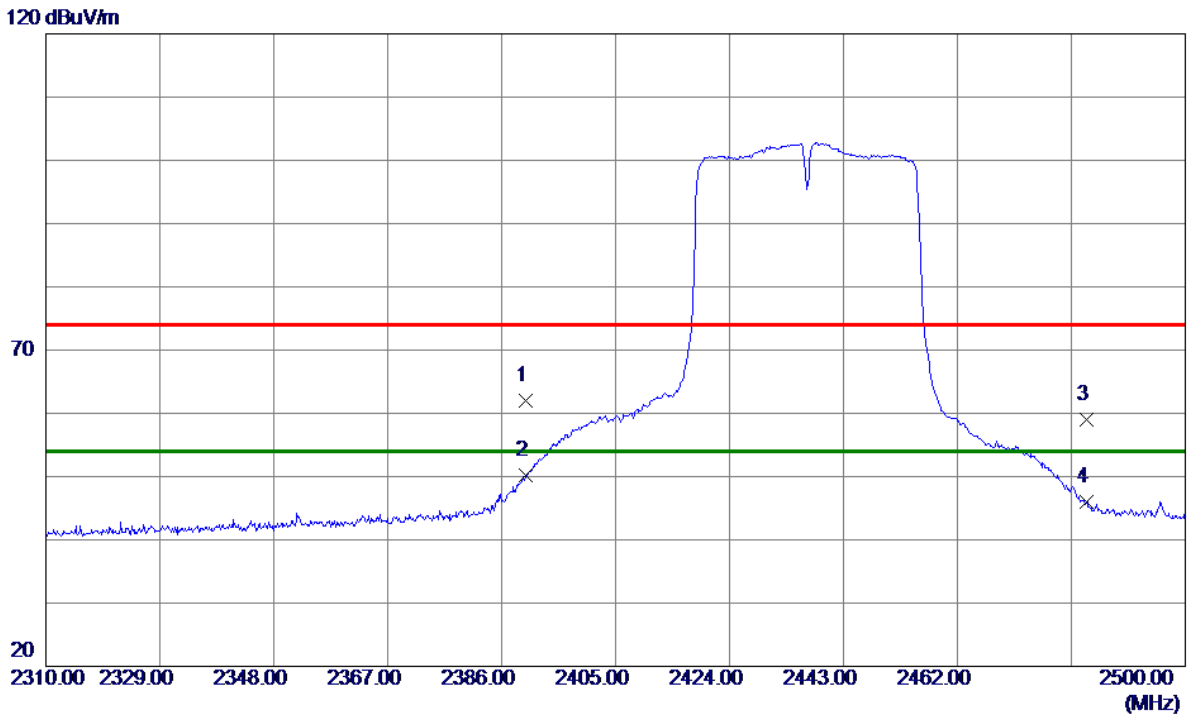

No.	Freq. MHz	Reading Level dBuV/m	Correct Factor dB	Measure ment dBuV/m	Limit dBuV/m	Margin dB	Detector	Comment
1	2390.0000	28.64	33.36	62.00	74.00	-12.00	Peak	
2 *	2390.0000	16.79	33.36	50.15	54.00	-3.85	AVG	
3	2483.5000	25.18	33.76	58.94	74.00	-15.06	Peak	
4	2483.5000	12.18	33.76	45.94	54.00	-8.06	AVG	

**REMARKS:**

- (1) Measurement Value = Reading Level + Correct Factor.
- (2) Margin Level = Measurement Value - Limit Value.

Test Mode: TX N-40M Mode 2437 MHz

### Horizontal

80 dBuV/m

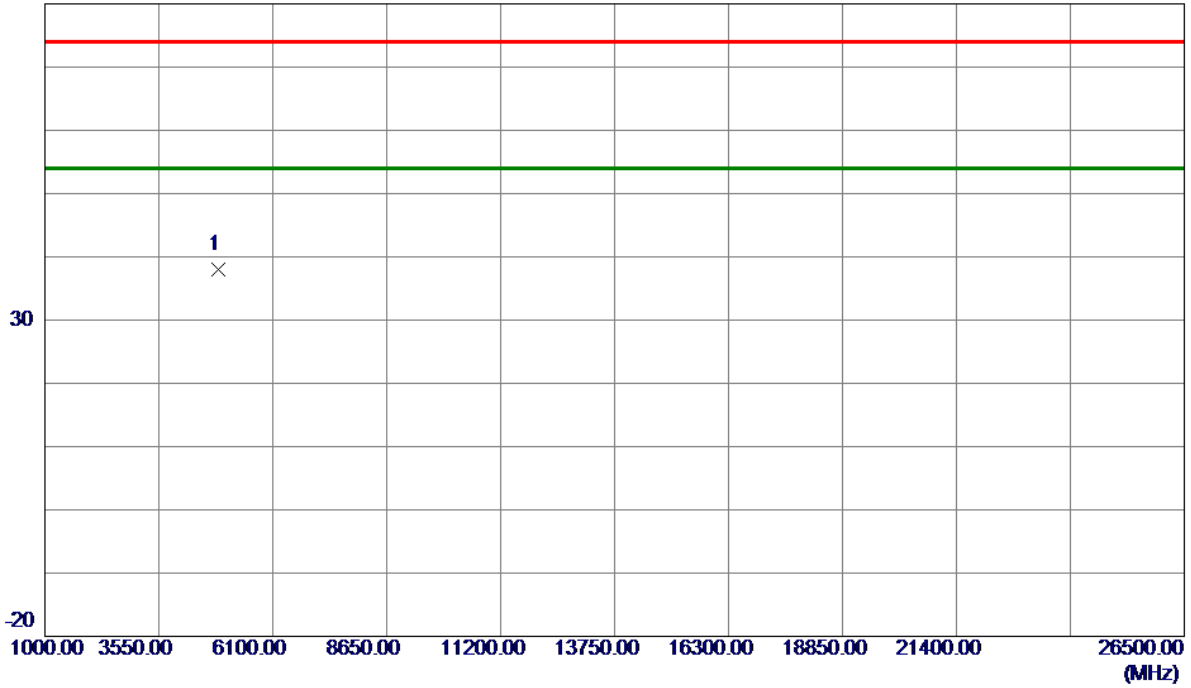

No.	Freq. MHz	Reading Level dBuV/m	Correct Factor dB	Measure ment dBuV/m	Limit dBuV/m	Margin dB	Detector	Comment
1 *	4874.0000	50.89	-12.87	38.02	74.00	-35.98	Peak	

**REMARKS:**

- (1) Measurement Value = Reading Level + Correct Factor.
- (2) Margin Level = Measurement Value - Limit Value.

Test Mode: TX N-40M Mode 2452 MHz

### Vertical

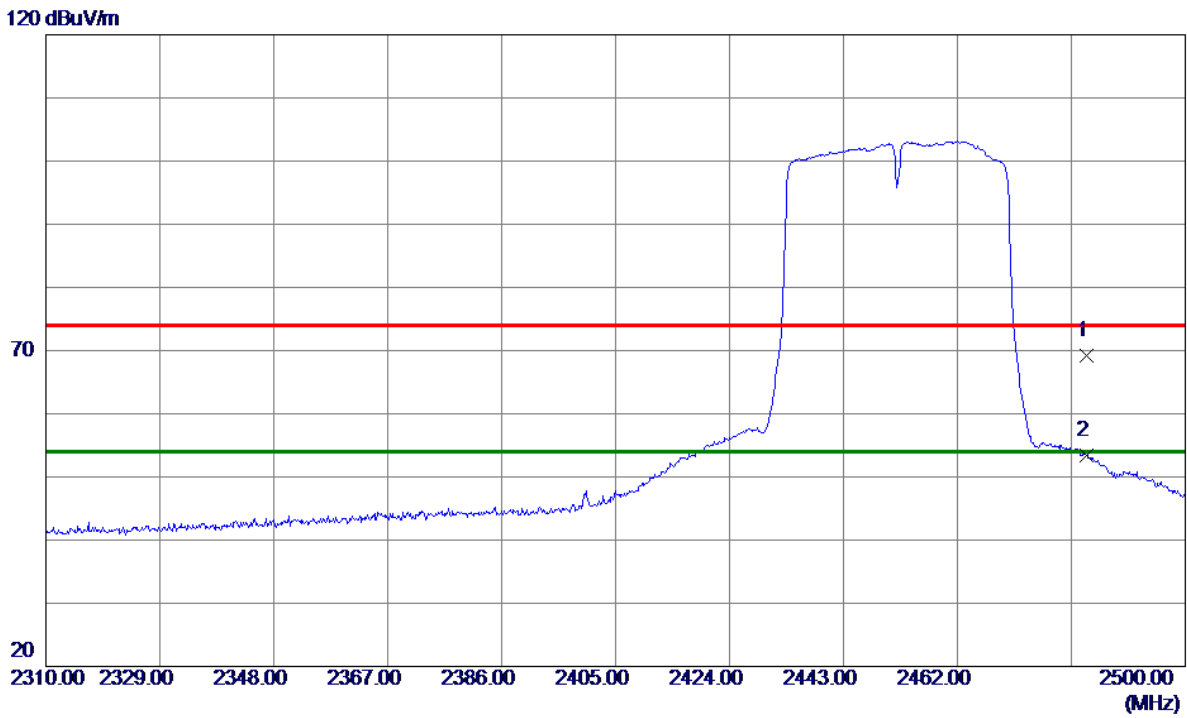

No.	Freq. MHz	Reading Level dBuV/m	Correct Factor dB	Measure ment dBuV/m	Limit dBuV/m	Margin dB	Detector	Comment
1	2483.5000	35.46	33.76	69.22	74.00	-4.78	Peak	
2 *	2483.5000	19.55	33.76	53.31	54.00	-0.69	AVG	

**REMARKS:**

- (1) Measurement Value = Reading Level + Correct Factor.
- (2) Margin Level = Measurement Value - Limit Value.

Test Mode: TX N-40M Mode 2452 MHz

### Vertical

80 dBuV/m

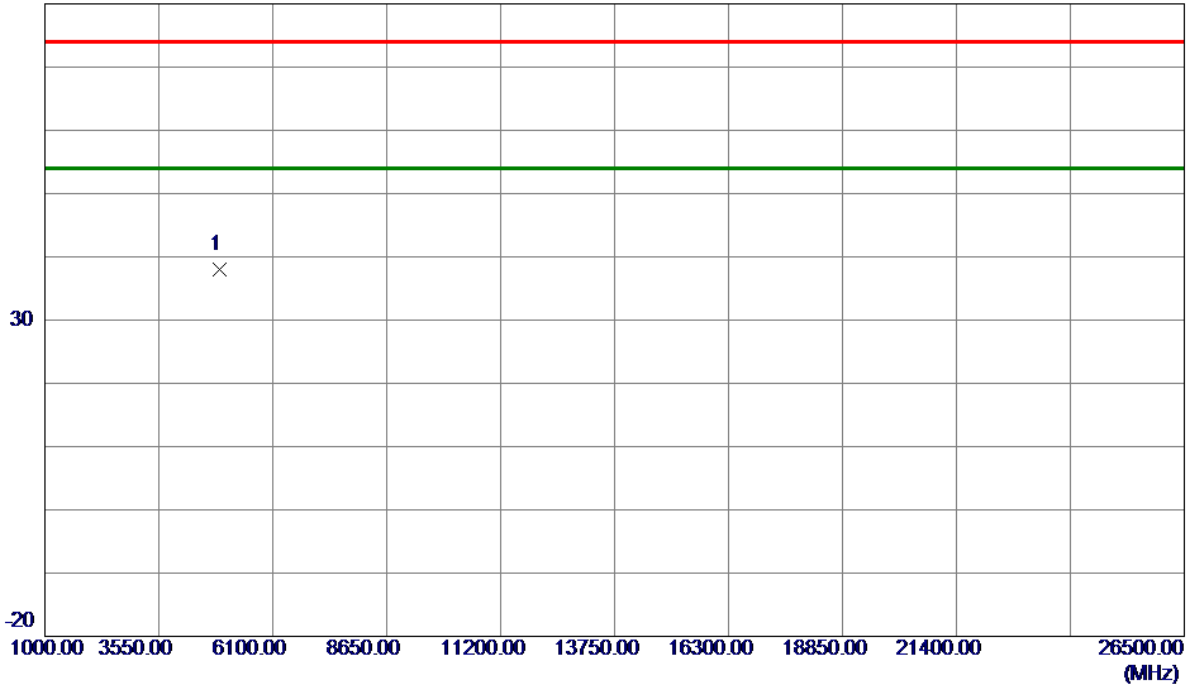

No.	Freq. MHz	Reading Level dBuV/m	Correct Factor dB	Measure ment dBuV/m	Limit dBuV/m	Margin dB	Detector	Comment
1 *	4904.0000	50.72	-12.78	37.94	74.00	-36.06	Peak	

**REMARKS:**

- (1) Measurement Value = Reading Level + Correct Factor.
- (2) Margin Level = Measurement Value - Limit Value.

Test Mode: TX N-40M Mode 2452 MHz

### Horizontal

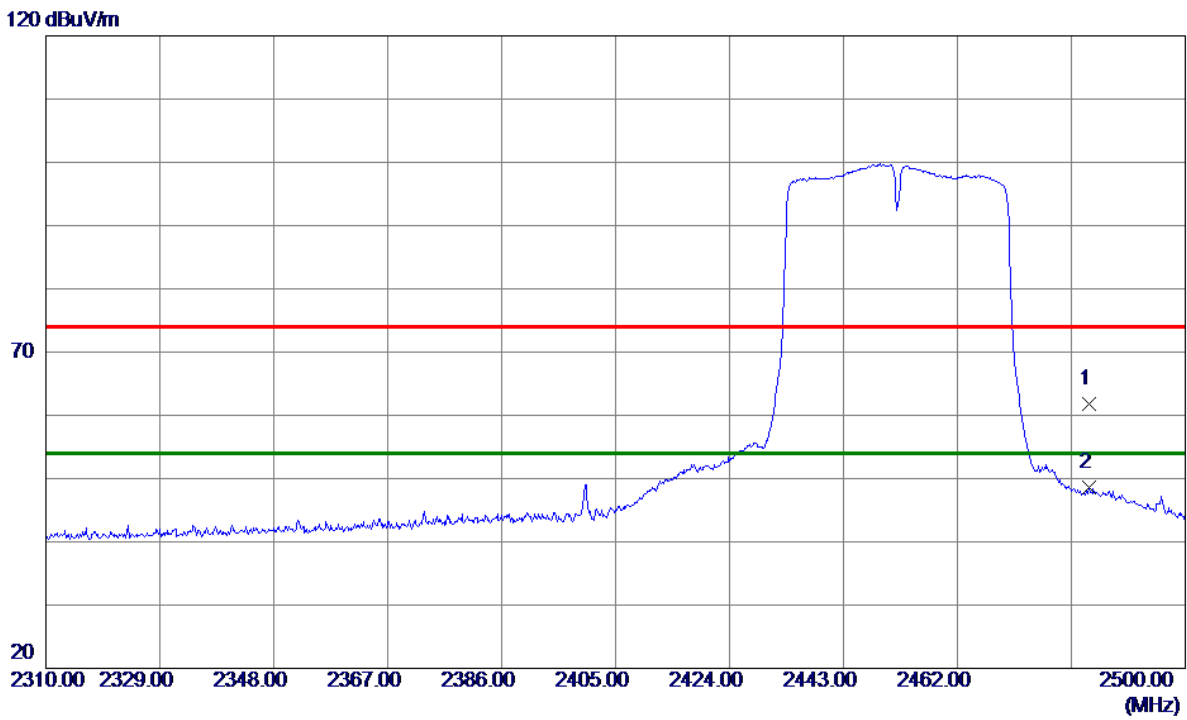

No.	Freq. MHz	Reading Level dBuV/m	Correct Factor dB	Measure ment dBuV/m	Limit dBuV/m	Margin dB	Detector	Comment
1	2484.0400	28.13	33.76	61.89	74.00	-12.11	Peak	
2 *	2484.0400	14.75	33.76	48.51	54.00	-5.49	AVG	

**REMARKS:**

- (1) Measurement Value = Reading Level + Correct Factor.
- (2) Margin Level = Measurement Value - Limit Value.

Test Mode: TX N-40M Mode 2452 MHz

### Horizontal

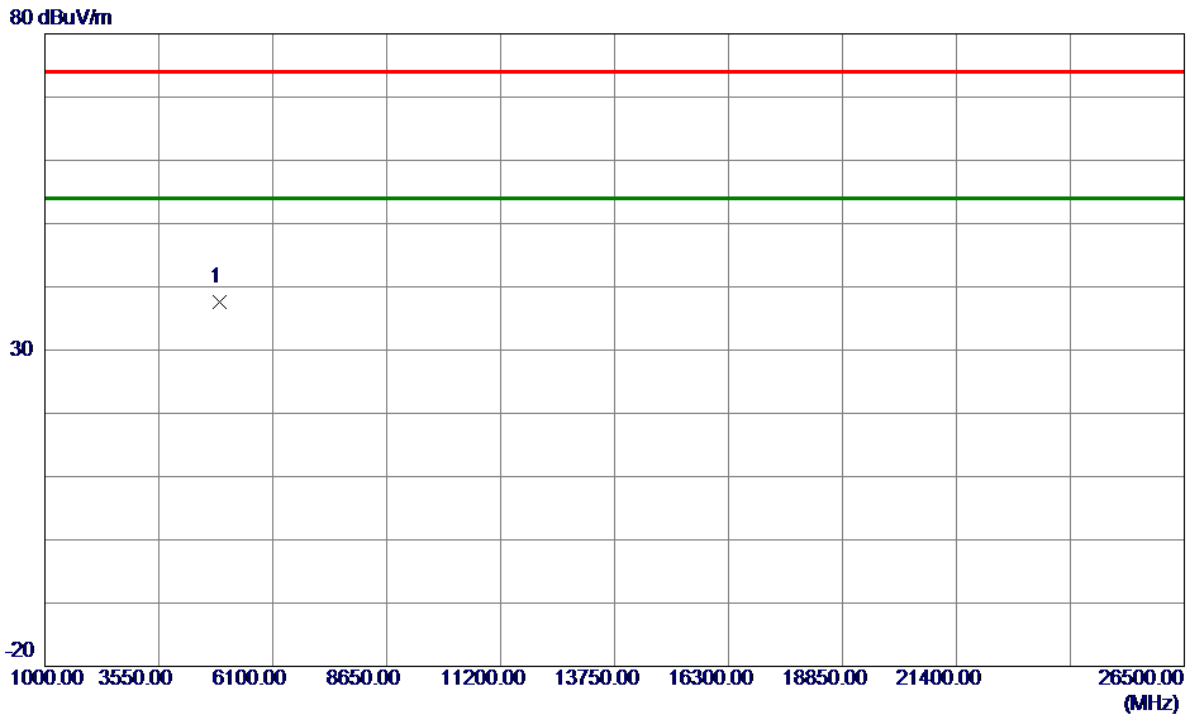

No.	Freq. MHz	Reading Level dBuV/m	Correct Factor dB	Measure ment dBuV/m	Limit dBuV/m	Margin dB	Detector	Comment
1 *	4904.0000	50.29	-12.78	37.51	74.00	-36.49	Peak	

**REMARKS:**

- (1) Measurement Value = Reading Level + Correct Factor.
- (2) Margin Level = Measurement Value - Limit Value.



Test Mode: TX AC-20M Mode 2412 MHz

## Vertical

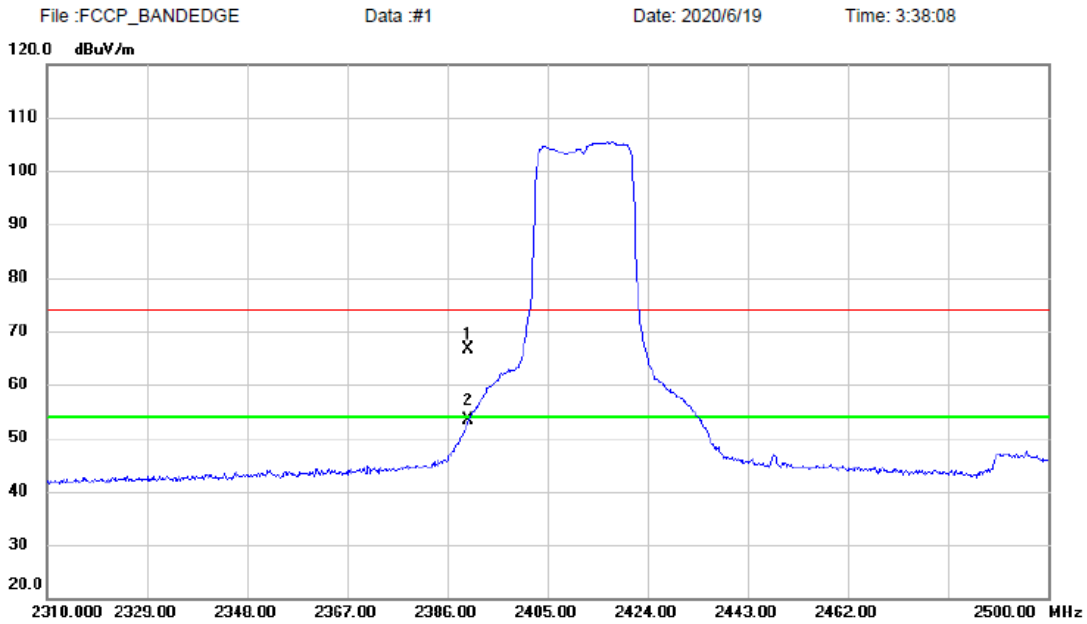

No.	Mk.	Freq.	Reading Level	Correct Factor	Measurement	Limit	Margin	Detector	Comment
		MHz	dBuV	dB	dBuV/m	dBuV/m	dB		
1		2390.000	33.36	33.36	66.72	74.00	-7.28	peak	
2	*	2390.000	19.91	33.36	53.27	54.00	-0.73	AVG	

### REMARKS:

- (1) Measurement Value = Reading Level + Correct Factor.
- (2) Margin Level = Measurement Value - Limit Value.

Test Mode: TX AC-20M Mode 2412 MHz

### Vertical

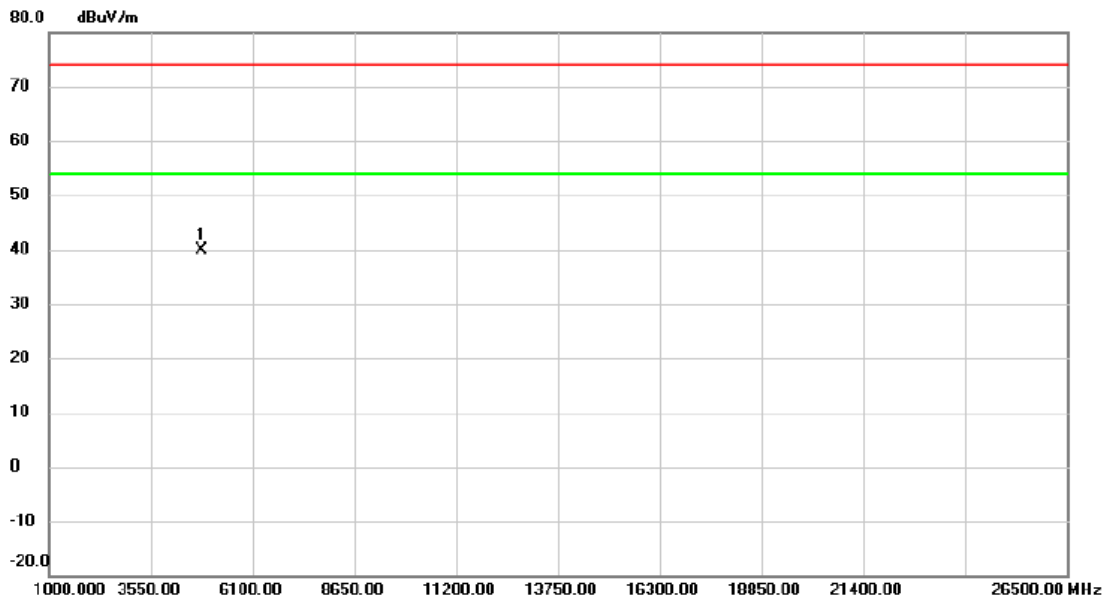

No.	Mk.	Freq.	Reading Level	Correct Factor	Measurement	Limit	Margin	Detector	Comment
		MHz	dBuV	dB	dBuV/m	dBuV/m	dB		
1	*	4825.215	52.80	-13.02	39.78	74.00	-34.22	peak	

REMARKS:  
 (1) Measurement Value = Reading Level + Correct Factor.  
 (2) Margin Level = Measurement Value - Limit Value.

Test Mode: TX AC-20M Mode 2412 MHz

### Horizontal

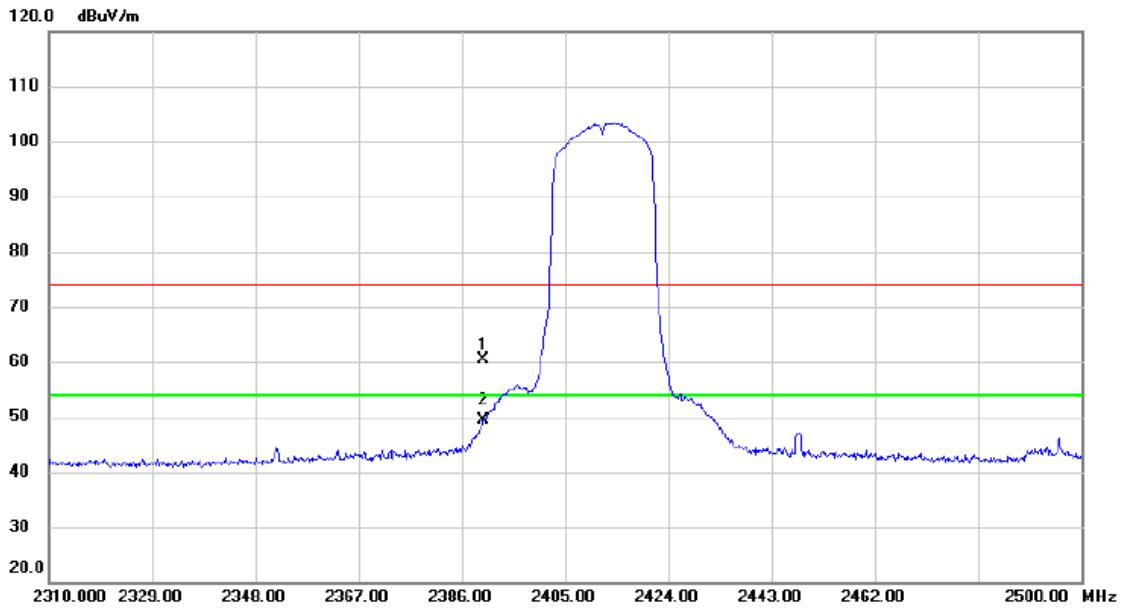

No.	Mk.	Freq. MHz	Reading Level dBuV	Correct Factor dB	Measure- ment dBuV/m	Limit dBuV/m	Margin dB	Detector	Comment
1		2390.000	27.10	33.36	60.46	74.00	-13.54	peak	
2	*	2390.000	16.03	33.36	49.39	54.00	-4.61	AVG	

REMARKS:  
 (1) Measurement Value = Reading Level + Correct Factor.  
 (2) Margin Level = Measurement Value - Limit Value.

Test Mode: TX AC-20M Mode 2412 MHz

### Horizontal

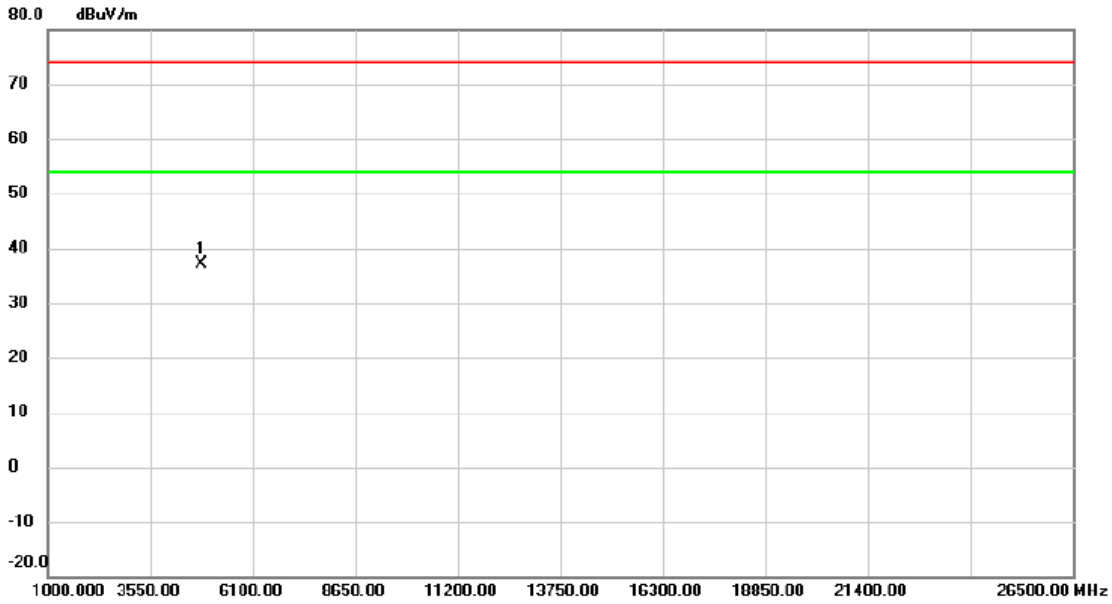

No.	Mk.	Freq.	Reading Level	Correct Factor	Measure-ment	Limit	Margin	Detector	Comment
		MHz	dBuV	dB	dBuV/m	dBuV/m	dB		
1	*	4824.000	50.19	-13.03	37.16	74.00	-36.84	peak	

**REMARKS:**

- (1) Measurement Value = Reading Level + Correct Factor.
- (2) Margin Level = Measurement Value - Limit Value.

Test Mode: TX AC-20 Mode 2437 MHz

### Vertical

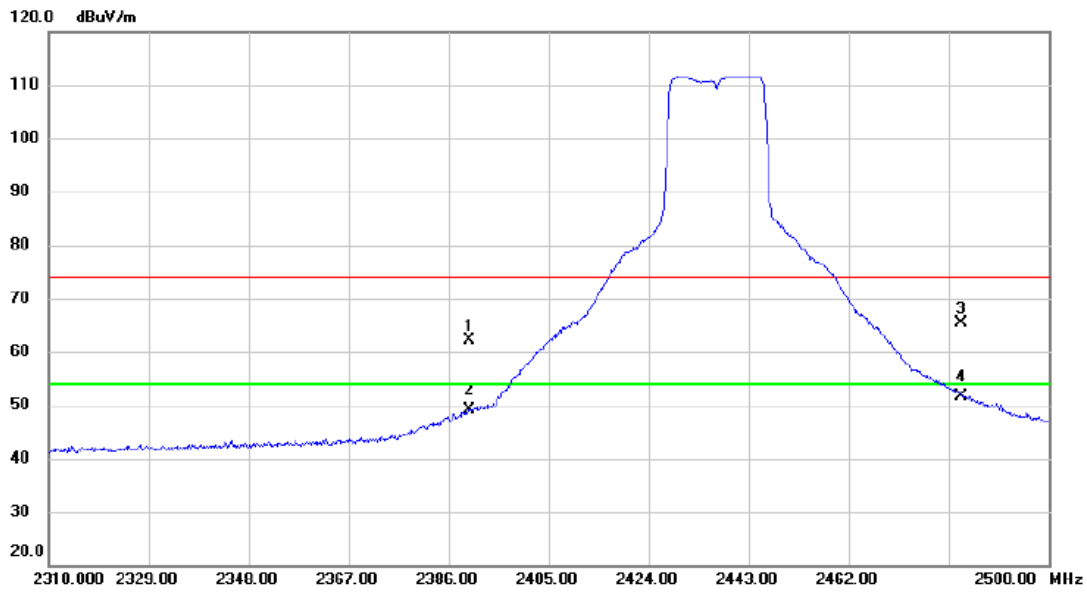

No.	Mk.	Freq. MHz	Reading Level dBuV	Correct Factor dB	Measure- ment dBuV/m	Limit dBuV/m	Margin dB	Detector	Comment
1		2390.000	28.66	33.36	62.02	74.00	-11.98	peak	
2		2390.000	15.65	33.36	49.01	54.00	-4.99	AVG	
3		2483.500	31.63	33.76	65.39	74.00	-8.61	peak	
4	*	2483.500	17.88	33.76	51.64	54.00	-2.36	AVG	

**REMARKS:**

- (1) Measurement Value = Reading Level + Correct Factor.
- (2) Margin Level = Measurement Value - Limit Value.

Test Mode: TX AC-20 Mode 2437 MHz

## Vertical

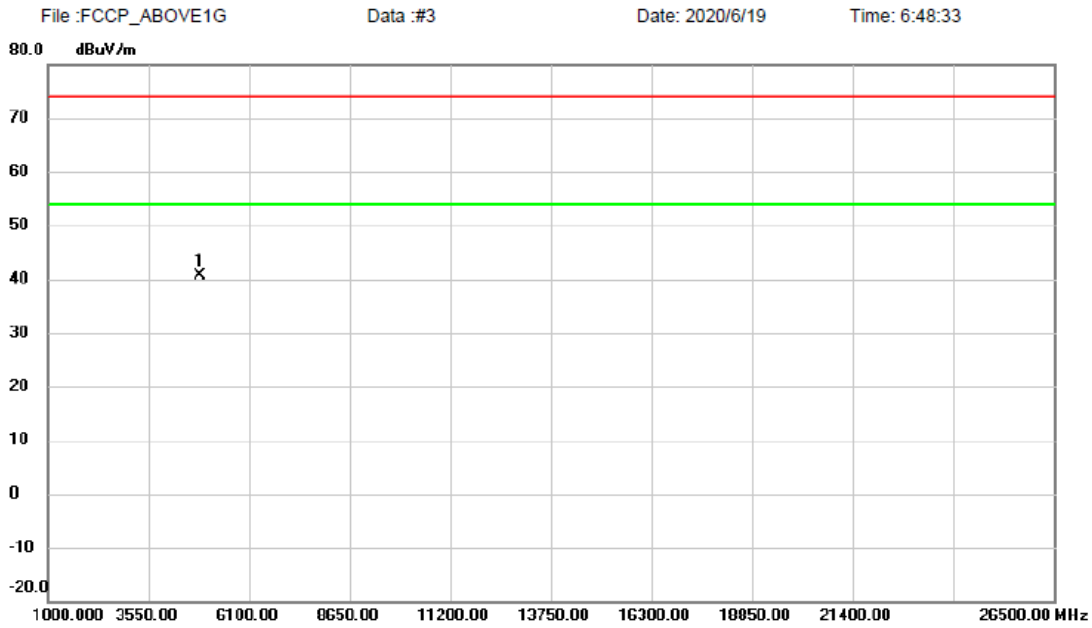

No.	Mk.	Freq.	Reading Level	Correct Factor	Measurement	Limit	Margin	Detector	Comment
		MHz	dBuV	dB	dBuV/m	dBuV/m	dB		
1	*	4872.175	53.50	-12.88	40.62	74.00	-33.38	peak	

### REMARKS:

- (1) Measurement Value = Reading Level + Correct Factor.
- (2) Margin Level = Measurement Value - Limit Value.

Test Mode: TX AC-20 Mode 2437 MHz

### Horizontal

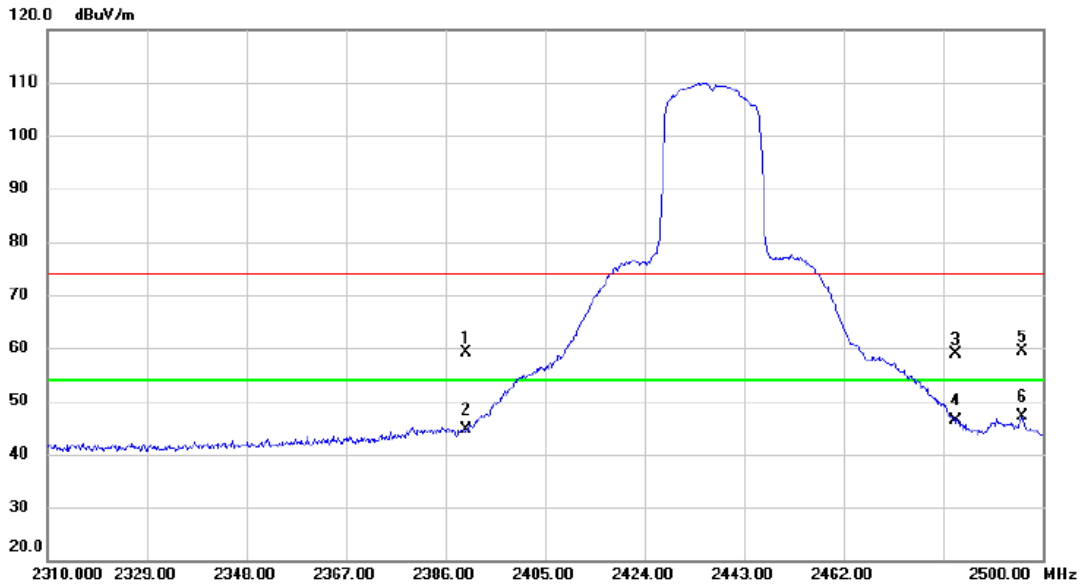

No.	Mk.	Freq. MHz	Reading Level dBuV	Correct Factor dB	Measure- ment dBuV/m	Limit dBuV/m	Margin dB	Detector	Comment
1		2390.000	25.67	33.36	59.03	74.00	-14.97	peak	
2		2390.000	11.30	33.36	44.66	54.00	-9.34	AVG	
3		2483.500	25.12	33.76	58.88	74.00	-15.12	peak	
4		2483.500	12.63	33.76	46.39	54.00	-7.61	AVG	
5		2496.200	25.60	33.81	59.41	74.00	-14.59	peak	
6	*	2496.200	13.37	33.81	47.18	54.00	-6.82	AVG	

**REMARKS:**

- (1) Measurement Value = Reading Level + Correct Factor.
- (2) Margin Level = Measurement Value - Limit Value.

Test Mode: TX AC-20 Mode 2437 MHz

### Horizontal

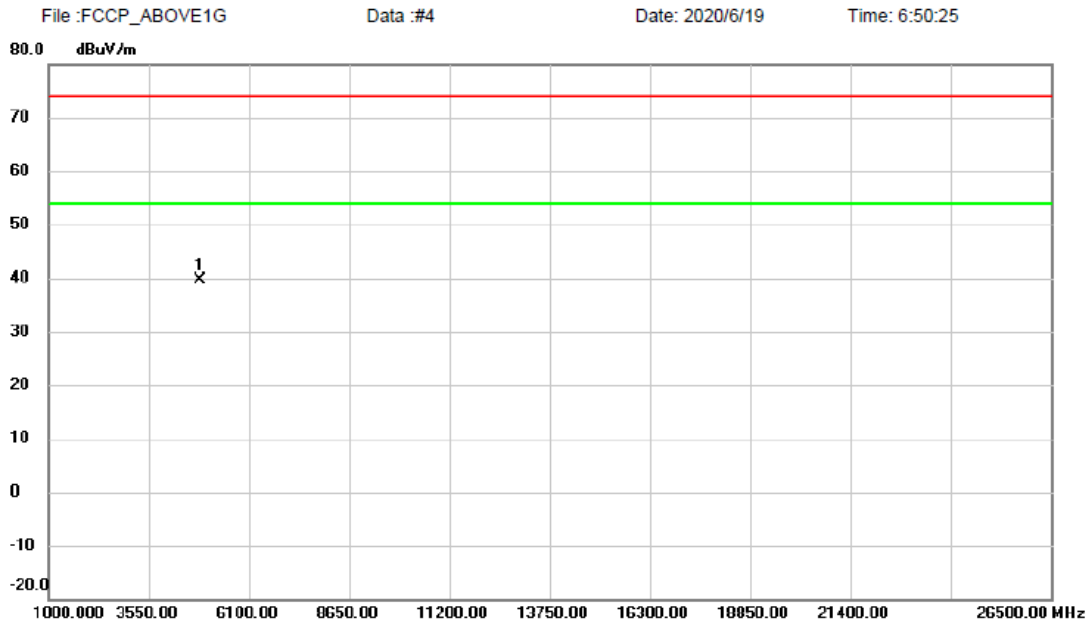

No.	Mk.	Freq.	Reading Level	Correct Factor	Measurement	Limit	Margin	Detector	Comment
		MHz	dBuV	dB	dBuV/m	dBuV/m	dB		
1	*	4873.340	52.42	-12.87	39.55	74.00	-34.45	peak	

**REMARKS:**

- (1) Measurement Value = Reading Level + Correct Factor.
- (2) Margin Level = Measurement Value - Limit Value.



Test Mode: TX AC-20 Mode 2462 MHz

### Vertical

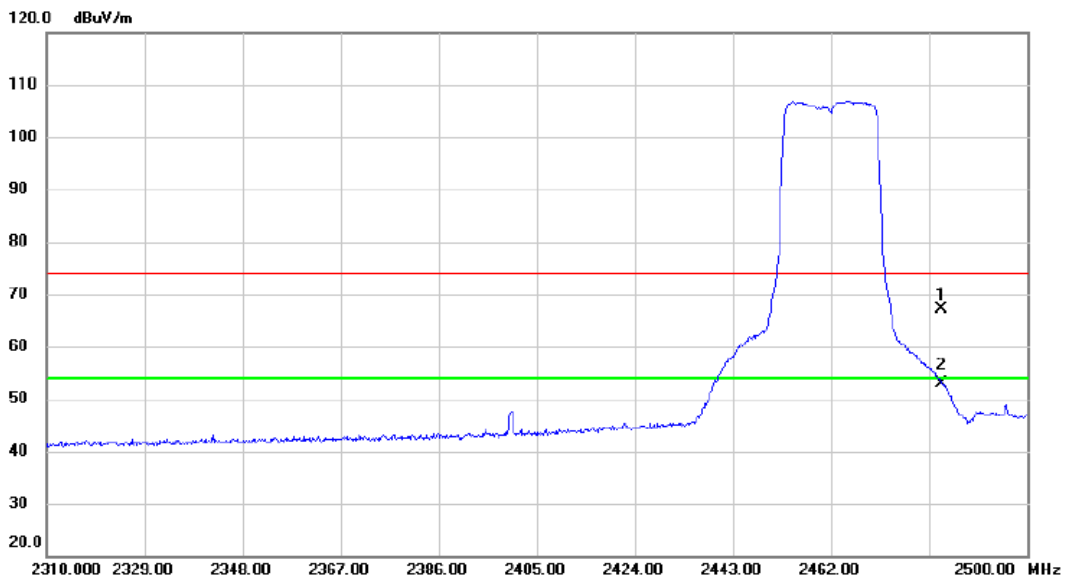

No.	Mk.	Freq. MHz	Reading Level dBuV	Correct Factor dB	Measure- ment dBuV/m	Limit dBuV/m	Margin dB	Detector	Comment
1		2483.500	33.27	33.76	67.03	74.00	-6.97	peak	
2	*	2483.500	19.10	33.76	52.86	54.00	-1.14	AVG	

**REMARKS:**

- (1) Measurement Value = Reading Level + Correct Factor.
- (2) Margin Level = Measurement Value - Limit Value.

Test Mode: TX AC-20 Mode 2462 MHz

### Vertical

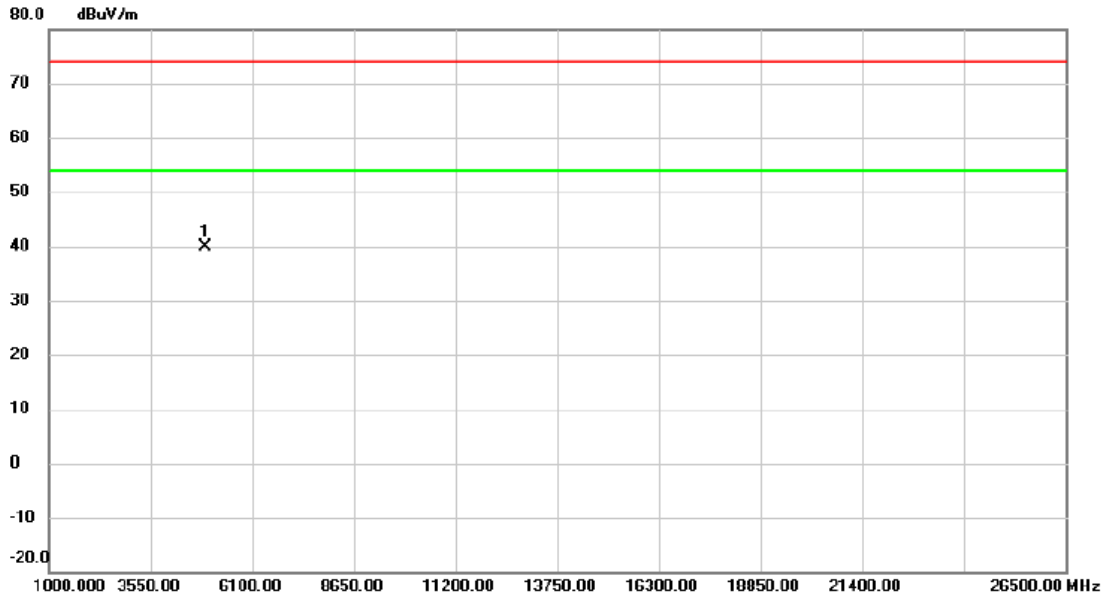

No.	Mk.	Freq.	Reading Level	Correct Factor	Measurement	Limit	Margin	Detector	Comment
		MHz	dBuV	dB	dBuV/m	dBuV/m	dB		
1	*	4921.525	52.64	-12.72	39.92	74.00	-34.08	peak	

**REMARKS:**

- (1) Measurement Value = Reading Level + Correct Factor.
- (2) Margin Level = Measurement Value - Limit Value.

Test Mode: TX AC-20 Mode 2462 MHz

### Horizontal

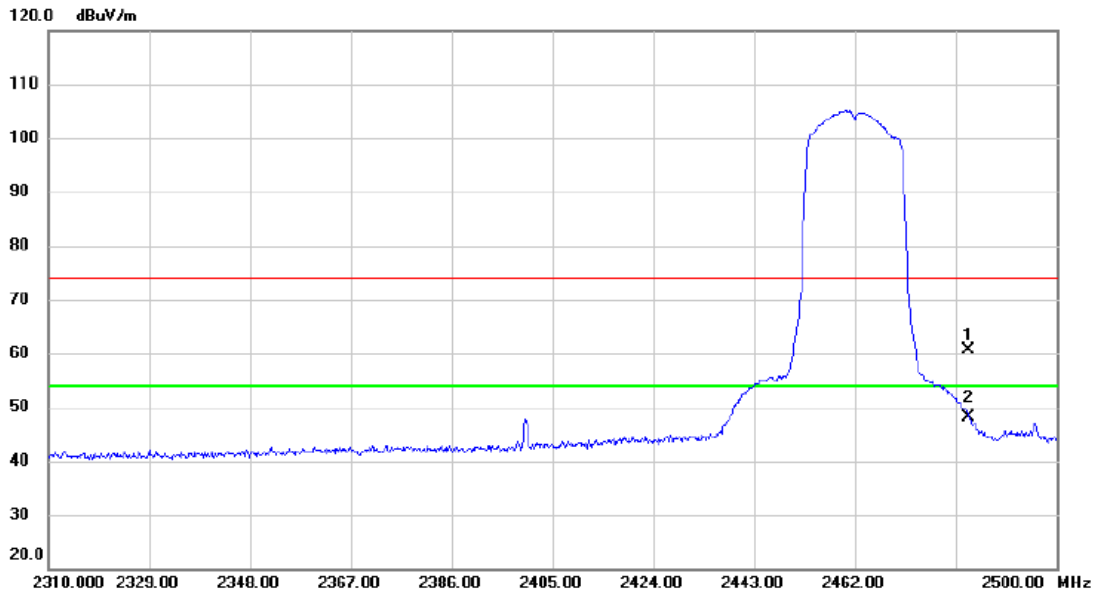

No.	Mk.	Freq. MHz	Reading Level dBuV	Correct Factor dB	Measure- ment dBuV/m	Limit dBuV/m	Margin dB	Detector	Comment
1		2483.500	26.77	33.76	60.53	74.00	-13.47	peak	
2	*	2483.500	14.35	33.76	48.11	54.00	-5.89	AVG	

**REMARKS:**

- (1) Measurement Value = Reading Level + Correct Factor.
- (2) Margin Level = Measurement Value - Limit Value.

Test Mode: TX AC-20 Mode 2462 MHz

### Horizontal

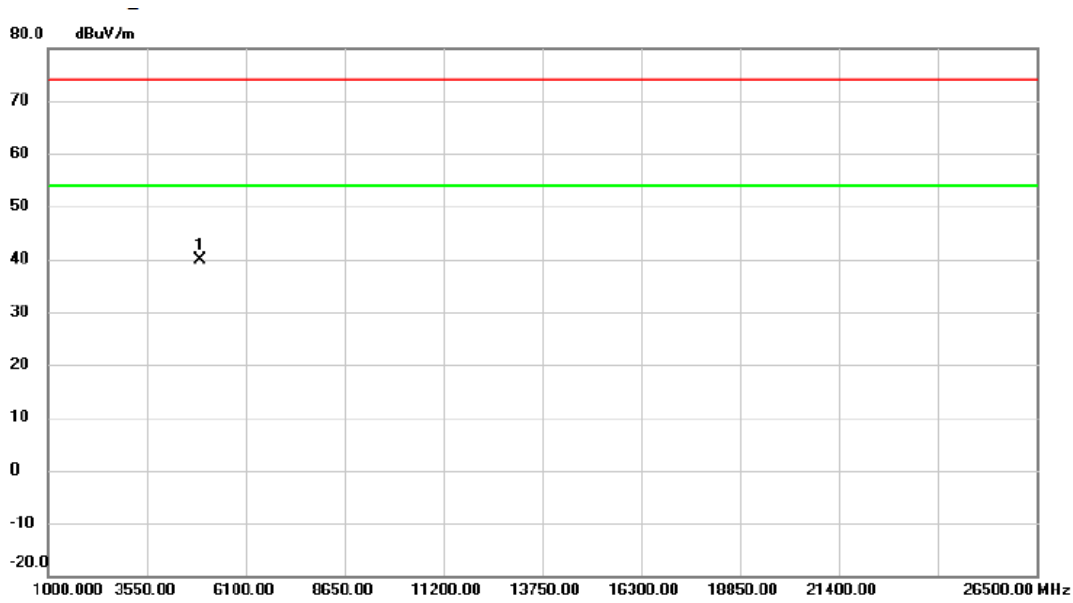

No.	Mk.	Freq.	Reading Level	Correct Factor	Measurement	Limit	Margin	Detector	Comment
		MHz	dBuV	dB	dBuV/m	dBuV/m	dB		
1	*	4922.140	52.49	-12.72	39.77	74.00	-34.23	peak	

**REMARKS:**

- (1) Measurement Value = Reading Level + Correct Factor.
- (2) Margin Level = Measurement Value - Limit Value.

Test Mode: TX AC-40M Mode 2422 MHz

### Vertical

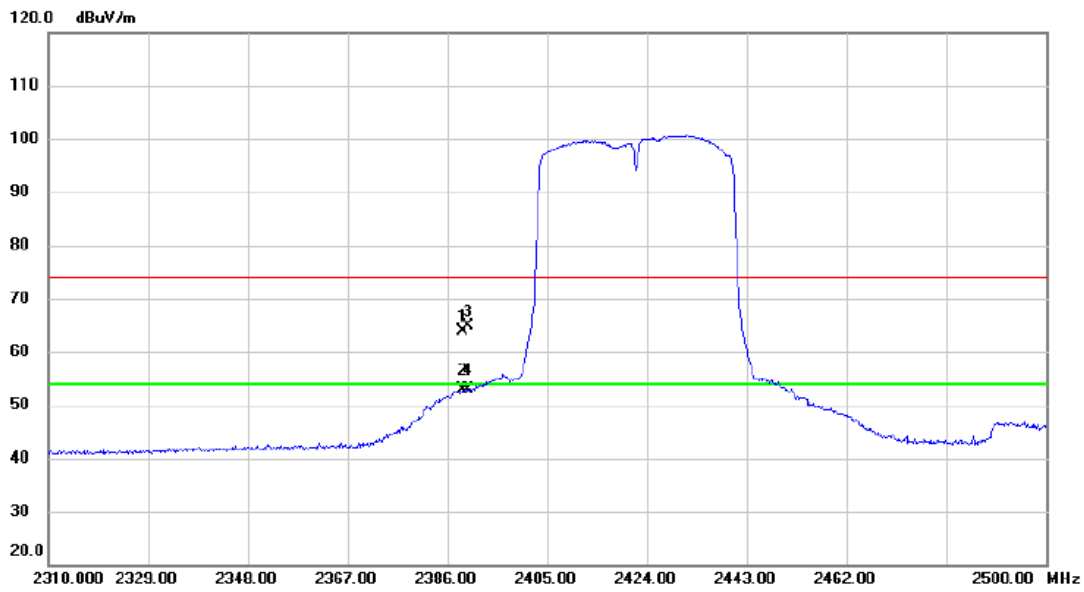

No.	Mk.	Freq. MHz	Reading Level dBuV	Correct Factor dB	Measure- ment dBuV/m	Limit dBuV/m	Margin dB	Detector	Comment
1		2389.040	30.53	33.35	63.88	74.00	-10.12	peak	
2	*	2389.040	19.52	33.35	52.87	54.00	-1.13	AVG	
3		2390.000	31.57	33.36	64.93	74.00	-9.07	peak	
4		2390.000	19.50	33.36	52.86	54.00	-1.14	AVG	

**REMARKS:**

- (1) Measurement Value = Reading Level + Correct Factor.
- (2) Margin Level = Measurement Value - Limit Value.

Test Mode: TX AC-40M Mode 2422 MHz

### Vertical

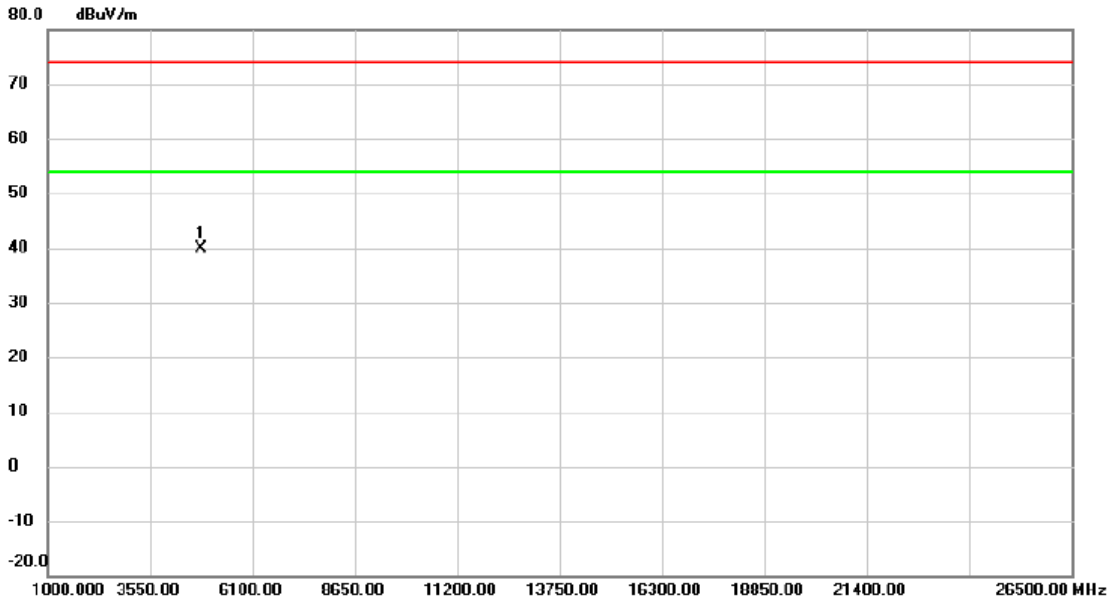

No.	Mk.	Freq.	Reading Level	Correct Factor	Measurement	Limit	Margin	Detector	Comment
		MHz	dBuV	dB	dBuV/m	dBuV/m	dB		
1	*	4841.795	52.92	-12.97	39.95	74.00	-34.05	peak	

**REMARKS:**

- (1) Measurement Value = Reading Level + Correct Factor.
- (2) Margin Level = Measurement Value - Limit Value.

Test Mode: TX AC-40M Mode 2422 MHz

### Horizontal

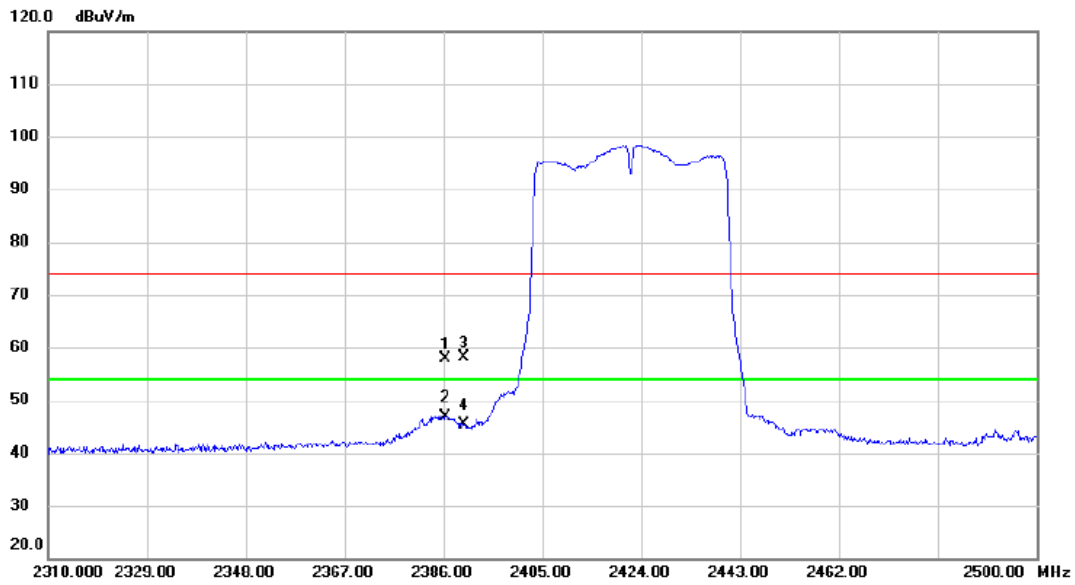

No.	Mk.	Freq. MHz	Reading Level dBuV	Correct Factor dB	Measure- ment dBuV/m	Limit dBuV/m	Margin dB	Detector	Comment
1		2386.380	24.51	33.35	57.86	74.00	-16.14	peak	
2	*	2386.380	13.63	33.35	46.98	54.00	-7.02	AVG	
3		2390.000	24.76	33.36	58.12	74.00	-15.88	peak	
4		2390.000	11.96	33.36	45.32	54.00	-8.68	AVG	

**REMARKS:**

- (1) Measurement Value = Reading Level + Correct Factor.
- (2) Margin Level = Measurement Value - Limit Value.

Test Mode: TX AC-40M Mode 2422 MHz

### Horizontal

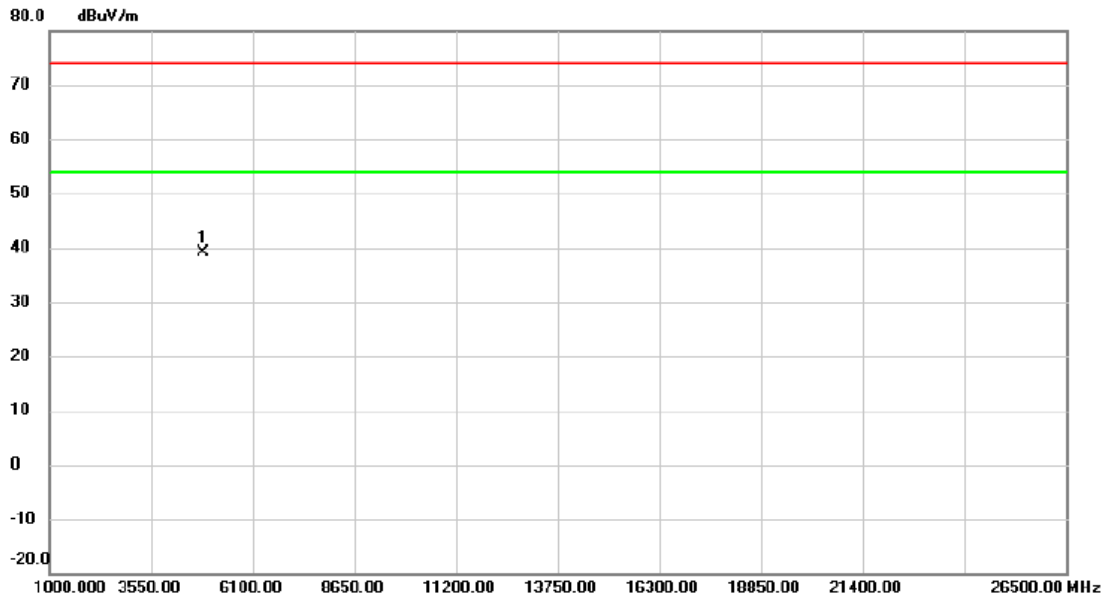

No.	Mk.	Freq.	Reading Level	Correct Factor	Measurement	Limit	Margin	Detector	Comment
		MHz	dBuV	dB	dBuV/m	dBuV/m	dB		
1	*	4845.685	52.12	-12.95	39.17	74.00	-34.83	peak	

**REMARKS:**

- (1) Measurement Value = Reading Level + Correct Factor.
- (2) Margin Level = Measurement Value - Limit Value.



Test Mode: TX AC-40M Mode 2437 MHz

### Vertical

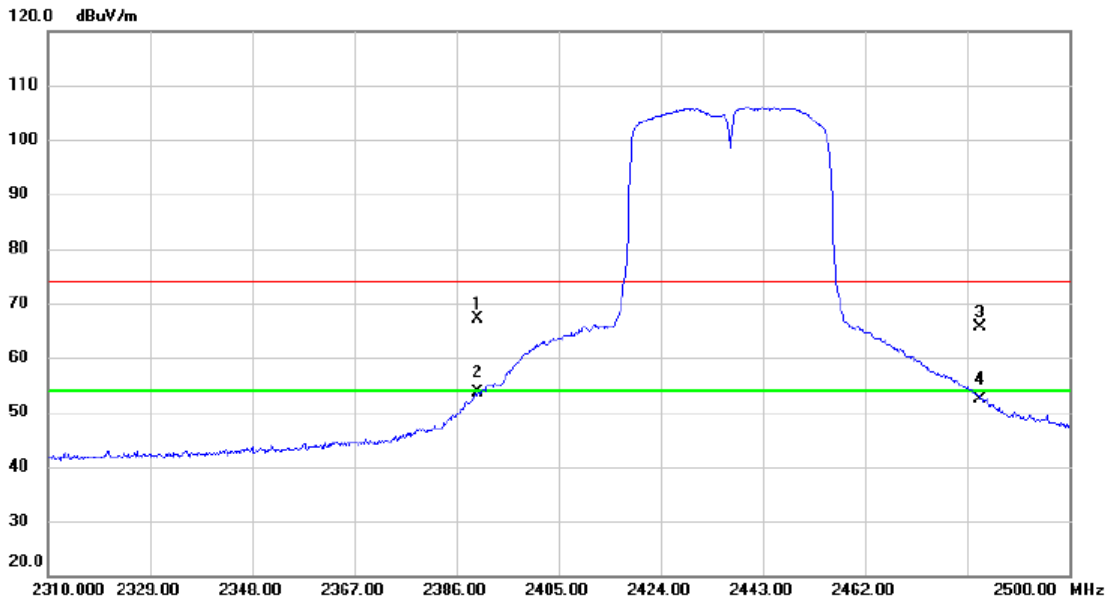

No.	Mk.	Freq. MHz	Reading Level dBuV	Correct Factor dB	Measure- ment dBuV/m	Limit dBuV/m	Margin dB	Detector	Comment
1		2390.000	33.73	33.36	67.09	74.00	-6.91	peak	
2	*	2390.000	20.16	33.36	53.52	54.00	-0.48	AVG	
3		2483.500	31.99	33.76	65.75	74.00	-8.25	peak	
4		2483.500	18.67	33.76	52.43	54.00	-1.57	AVG	

**REMARKS:**

- (1) Measurement Value = Reading Level + Correct Factor.
- (2) Margin Level = Measurement Value - Limit Value.

Test Mode: TX AC-40M Mode 2437 MHz

### Vertical

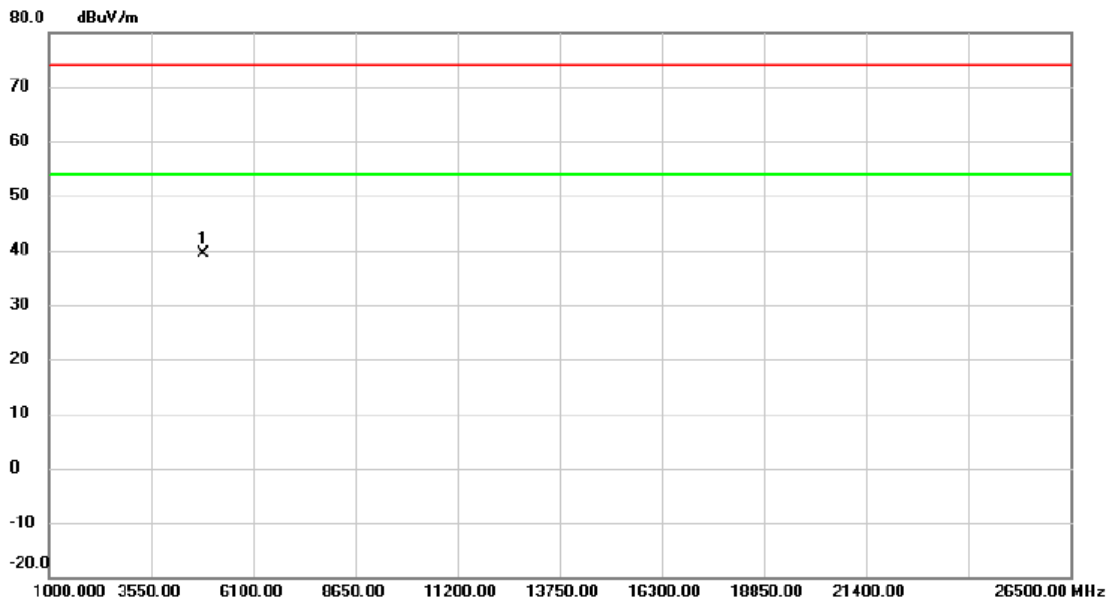

No.	Mk.	Freq.	Reading Level	Correct Factor	Measurement	Limit	Margin	Detector	Comment
		MHz	dBuV	dB	dBuV/m	dBuV/m	dB		
1	*	4872.440	52.23	-12.88	39.35	74.00	-34.65	peak	

**REMARKS:**

- (1) Measurement Value = Reading Level + Correct Factor.
- (2) Margin Level = Measurement Value - Limit Value.

Test Mode: TX AC-40M Mode 2437 MHz

### Horizontal

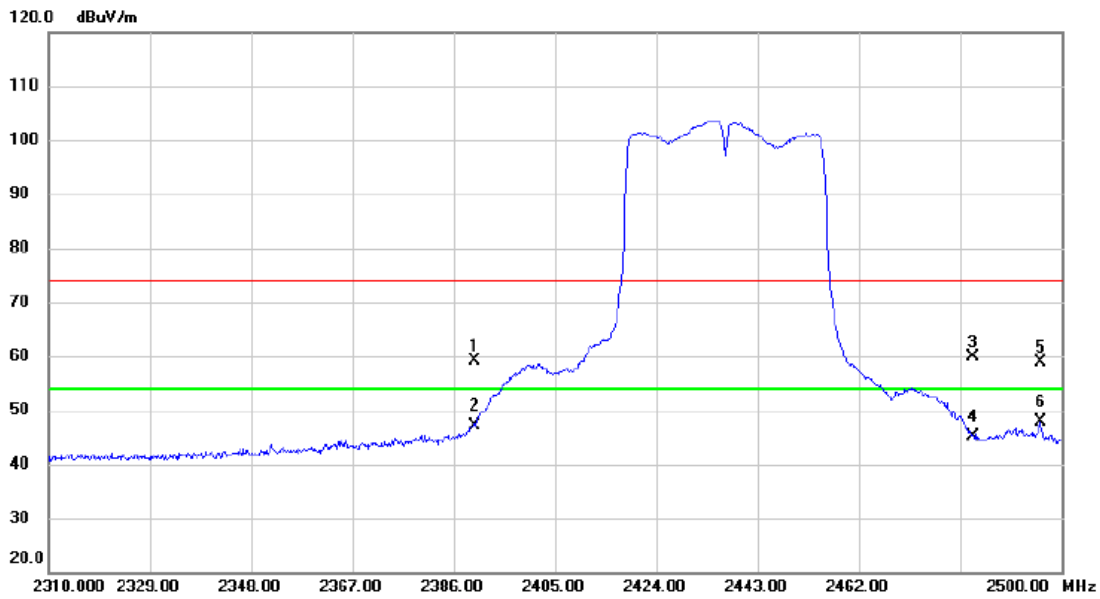

No.	Mk.	Freq. MHz	Reading Level dBuV	Correct Factor dB	Measure- ment dBuV/m	Limit dBuV/m	Margin dB	Detector	Comment
1		2390.000	25.76	33.36	59.12	74.00	-14.88	peak	
2		2390.000	13.84	33.36	47.20	54.00	-6.80	AVG	
3		2483.500	26.03	33.76	59.79	74.00	-14.21	peak	
4		2483.500	11.28	33.76	45.04	54.00	-8.96	AVG	
5		2496.010	25.04	33.81	58.85	74.00	-15.15	peak	
6	*	2496.010	14.03	33.81	47.84	54.00	-6.16	AVG	

**REMARKS:**

- (1) Measurement Value = Reading Level + Correct Factor.
- (2) Margin Level = Measurement Value - Limit Value.

Test Mode: TX AC-40M Mode 2437 MHz

### Horizontal

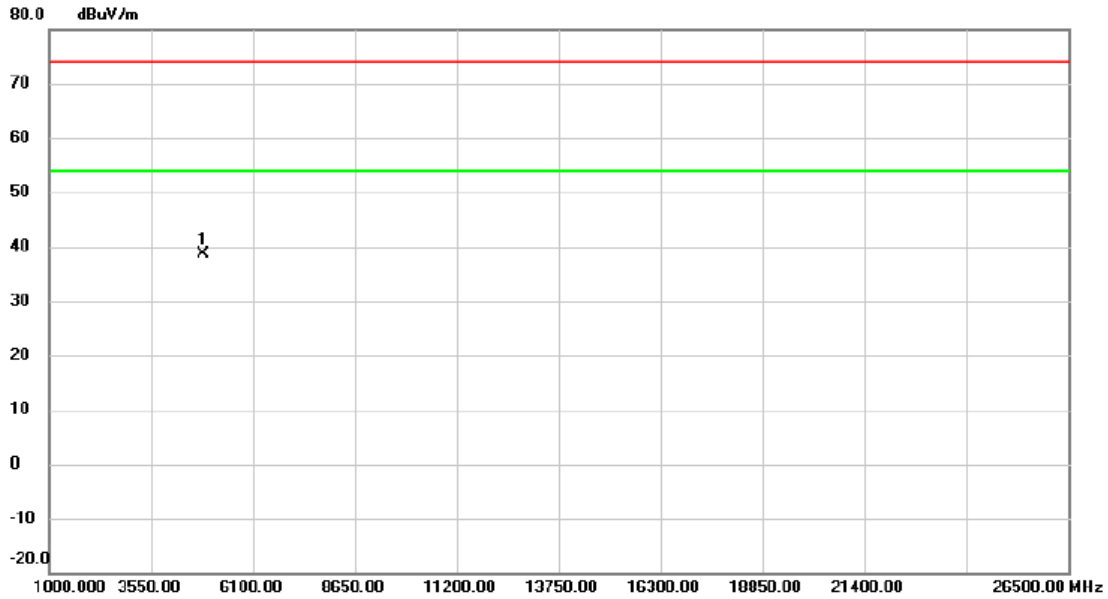

No.	Mk.	Freq.	Reading Level	Correct Factor	Measurement	Limit	Margin	Detector	Comment
		MHz	dBuV	dB	dBuV/m	dBuV/m	dB		
1	*	4873.905	51.59	-12.86	38.73	74.00	-35.27	peak	

**REMARKS:**

- (1) Measurement Value = Reading Level + Correct Factor.
- (2) Margin Level = Measurement Value - Limit Value.

Test Mode: TX AC-40M Mode 2452 MHz

### Vertical

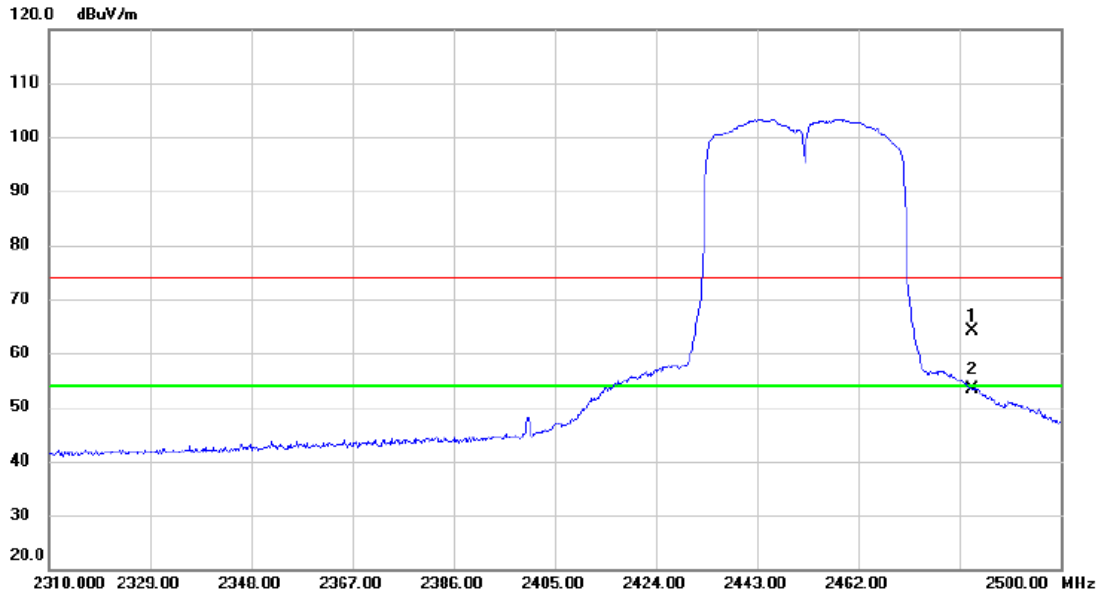

No.	Mk.	Freq. MHz	Reading Level dBuV	Correct Factor dB	Measure- ment dBuV/m	Limit dBuV/m	Margin dB	Detector	Comment
1		2483.500	30.38	33.76	64.14	74.00	-9.86	peak	
2	*	2483.500	19.71	33.76	53.47	54.00	-0.53	AVG	

**REMARKS:**

- (1) Measurement Value = Reading Level + Correct Factor.
- (2) Margin Level = Measurement Value - Limit Value.

Test Mode: TX AC-40M Mode 2452 MHz

### Vertical

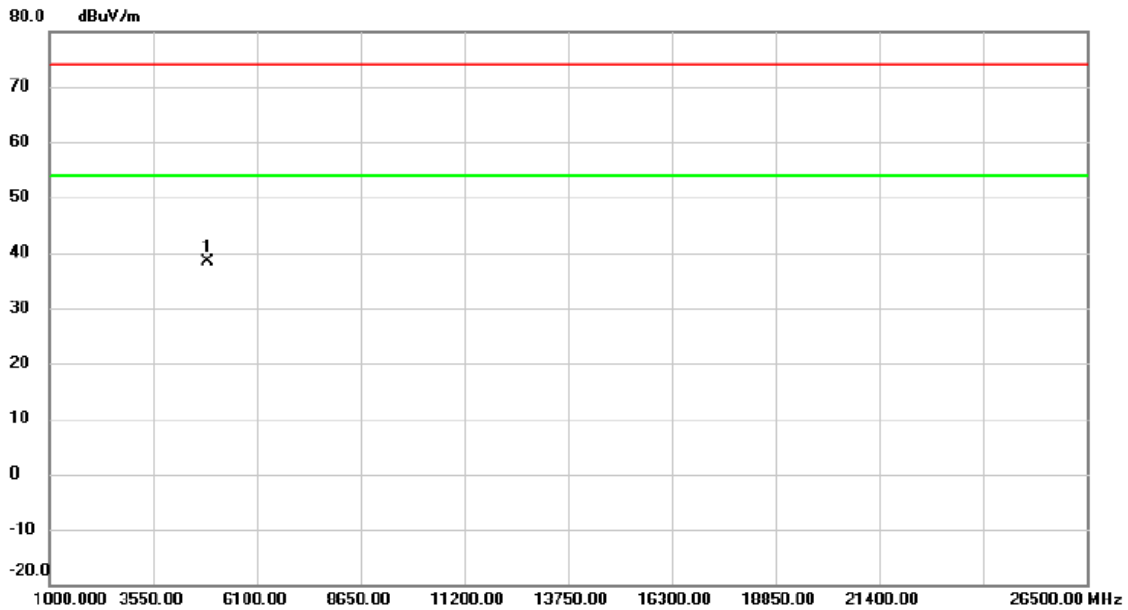

No.	Mk.	Freq. MHz	Reading Level dBuV	Correct Factor dB	Measure- ment dBuV/m	Limit dBuV/m	Margin dB	Detector	Comment
1	*	4903.905	51.15	-12.78	38.37	74.00	-35.63	peak	

**REMARKS:**

- (1) Measurement Value = Reading Level + Correct Factor.
- (2) Margin Level = Measurement Value - Limit Value.

Test Mode: TX AC-40M Mode 2452 MHz

### Horizontal

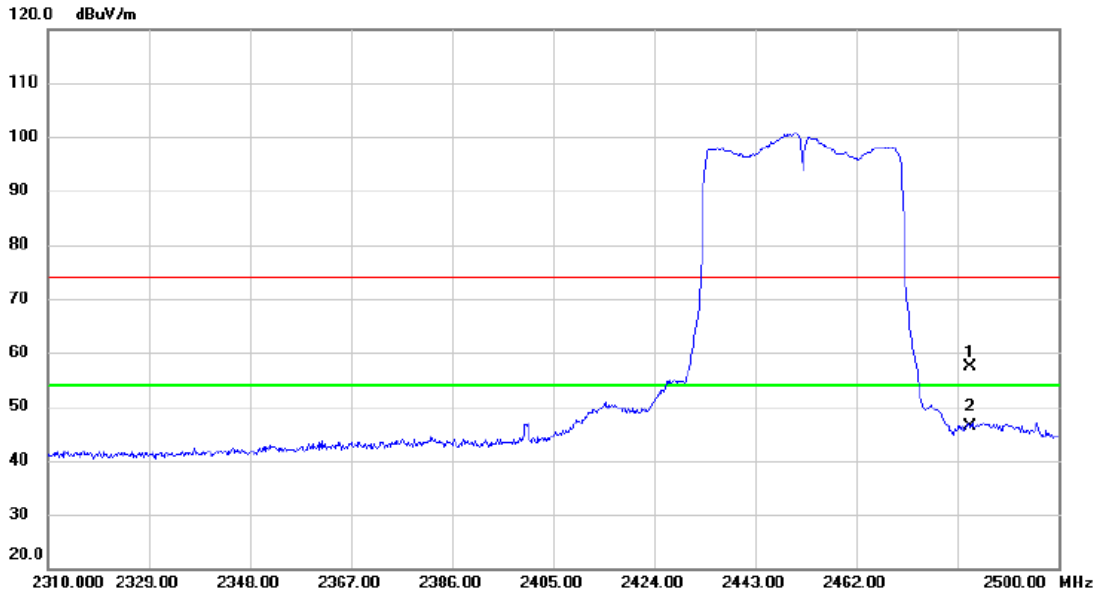

No.	Mk.	Freq. MHz	Reading Level dBuV	Correct Factor dB	Measure- ment dBuV/m	Limit dBuV/m	Margin dB	Detector	Comment
1		2483.500	23.73	33.76	57.49	74.00	-16.51	peak	
2	*	2483.500	12.65	33.76	46.41	54.00	-7.59	AVG	

**REMARKS:**

- (1) Measurement Value = Reading Level + Correct Factor.
- (2) Margin Level = Measurement Value - Limit Value.

Test Mode: TX AC-40M Mode 2452 MHz

### Horizontal

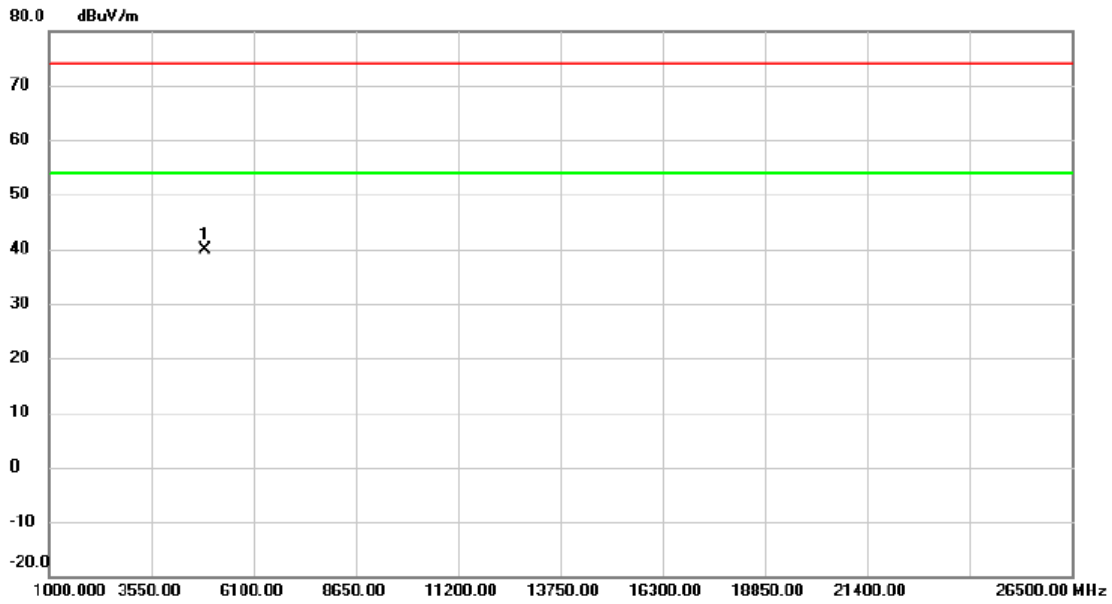

No.	Mk.	Freq.	Reading Level	Correct Factor	Measurement	Limit	Margin	Detector	Comment
		MHz	dBuV	dB	dBuV/m	dBuV/m	dB		
1	*	4901.515	52.62	-12.78	39.84	74.00	-34.16	peak	

**REMARKS:**

- (1) Measurement Value = Reading Level + Correct Factor.
- (2) Margin Level = Measurement Value - Limit Value.



ANT1

Test Mode: TX B Mode 2412 MHz

Vertical

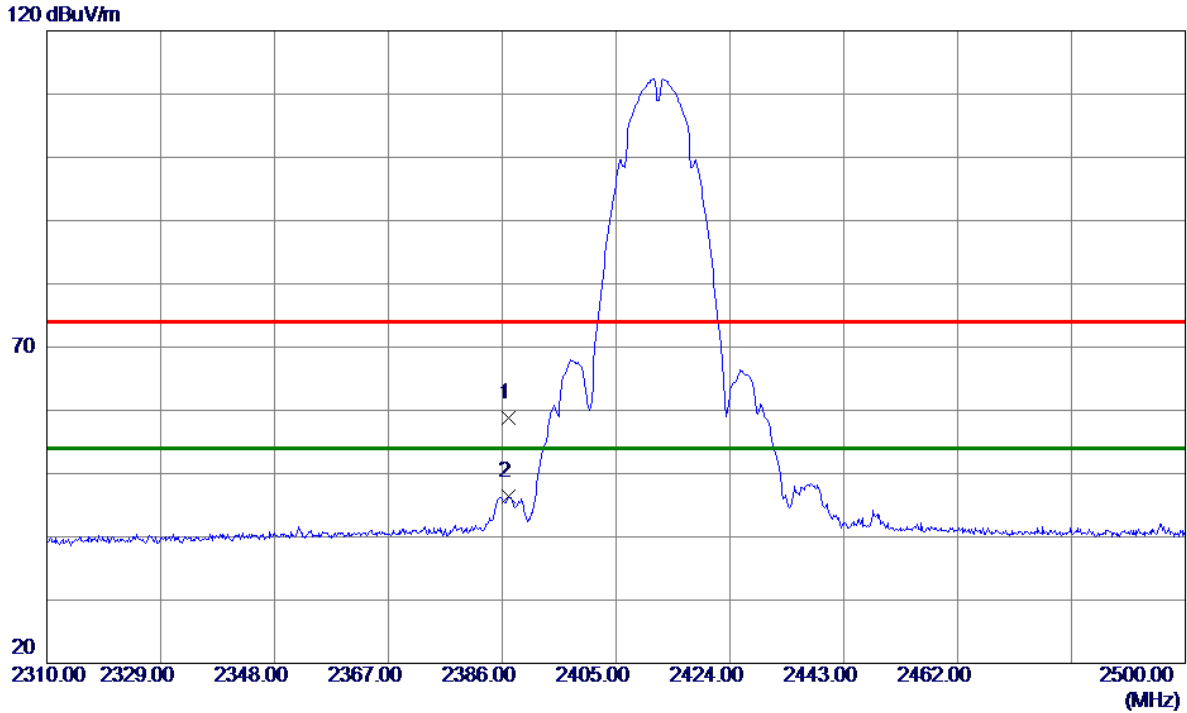

No.	Freq. MHz	Reading Level dBuV/m	Correct Factor dB	Measure ment dBuV/m	Limit dBuV/m	Margin dB	Detector	Comment
1	2387.0450	25.52	33.35	58.87	74.00	-15.13	Peak	
2 *	2387.0450	13.11	33.35	46.46	54.00	-7.54	AVG	

REMARKS:

(1) Measurement Value = Reading Level + Correct Factor.

(2) Margin Level = Measurement Value - Limit Value.

Test Mode: TX B Mode 2412 MHz

### Vertical

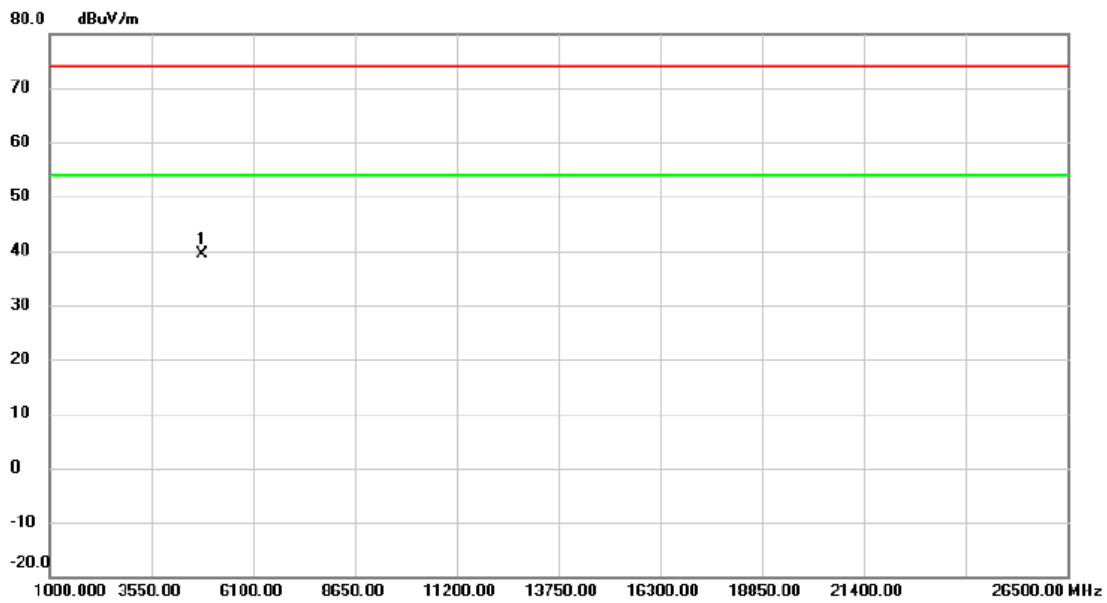

No.	Mk.	Freq.	Reading Level	Correct Factor	Measurement	Limit	Margin	Detector	Comment
		MHz	dBuV	dB	dBuV/m	dBuV/m	dB		
1	*	4824.000	52.46	-13.03	39.43	74.00	-34.57	peak	

**REMARKS:**

- (1) Measurement Value = Reading Level + Correct Factor.
- (2) Margin Level = Measurement Value - Limit Value.

Test Mode: TX B Mode 2412 MHz

### Horizontal

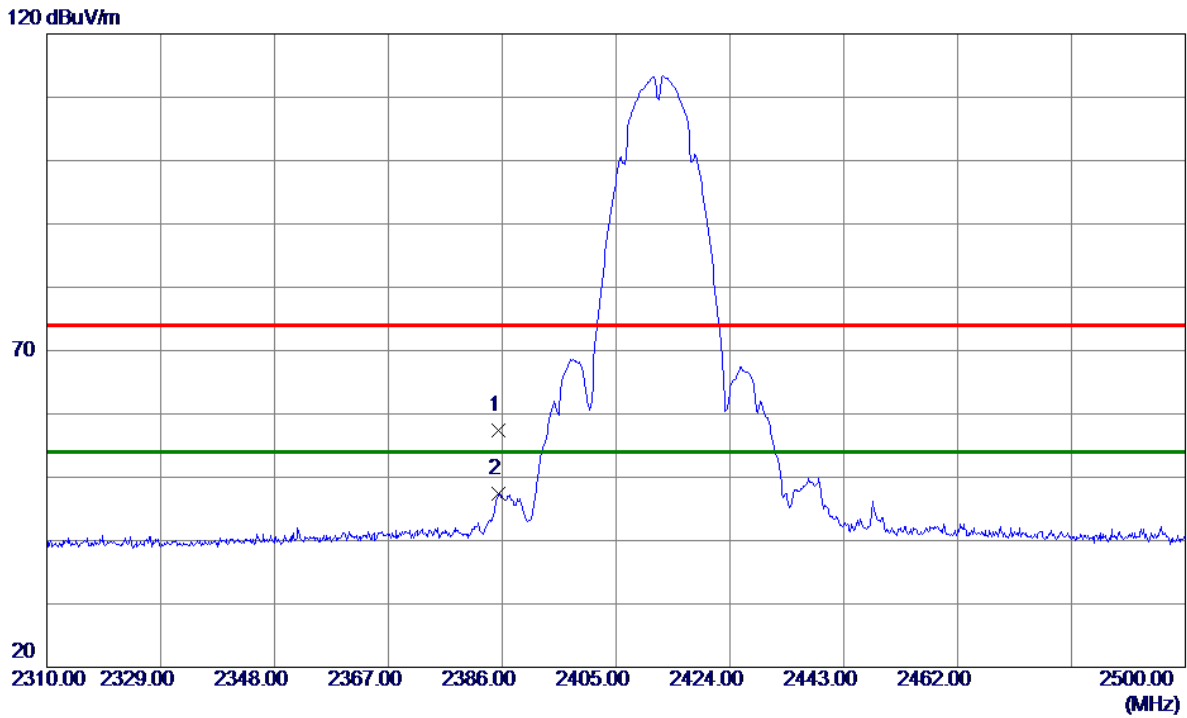

No.	Freq. MHz	Reading Level dBuV/m	Correct Factor dB	Measure ment dBuV/m	Limit dBuV/m	Margin dB	Detector	Comment
1	2385.4300	24.11	33.34	57.45	74.00	-16.55	Peak	
2 *	2385.4300	14.13	33.34	47.47	54.00	-6.53	AVG	

**REMARKS:**

- (1) Measurement Value = Reading Level + Correct Factor.
- (2) Margin Level = Measurement Value - Limit Value.

Test Mode: TX B Mode 2412 MHz

### Horizontal

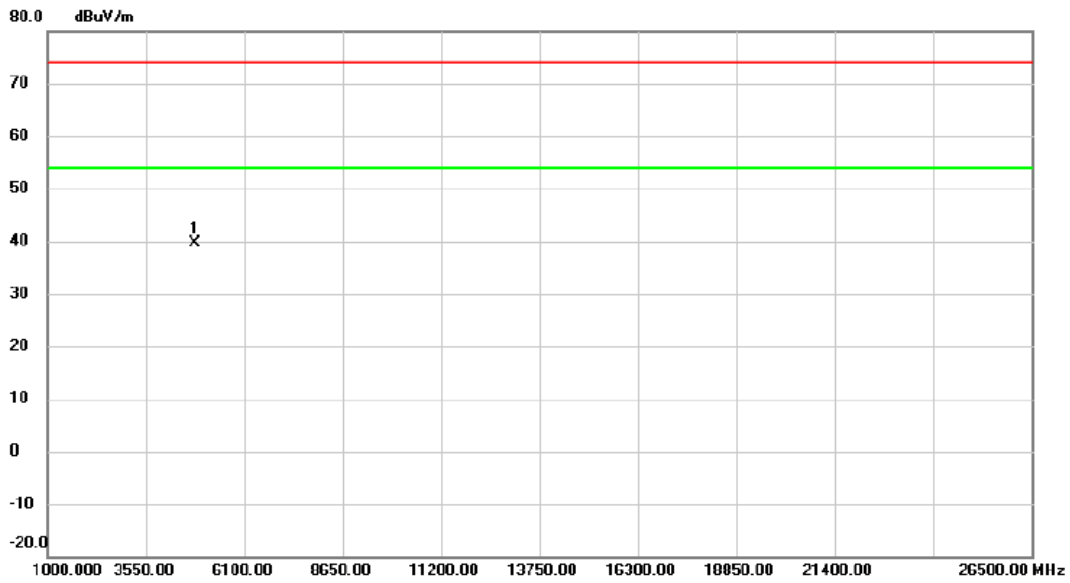

No.	Mk.	Freq. MHz	Reading Level dBuV	Correct Factor dB	Measure- ment dBuV/m	Limit dBuV/m	Margin dB	Detector	Comment
1	*	4824.000	52.73	-13.03	39.70	74.00	-34.30	peak	

**REMARKS:**

- (1) Measurement Value = Reading Level + Correct Factor.
- (2) Margin Level = Measurement Value - Limit Value.

Test Mode: TX B Mode 2437 MHz

### Vertical

120 dBuV/m

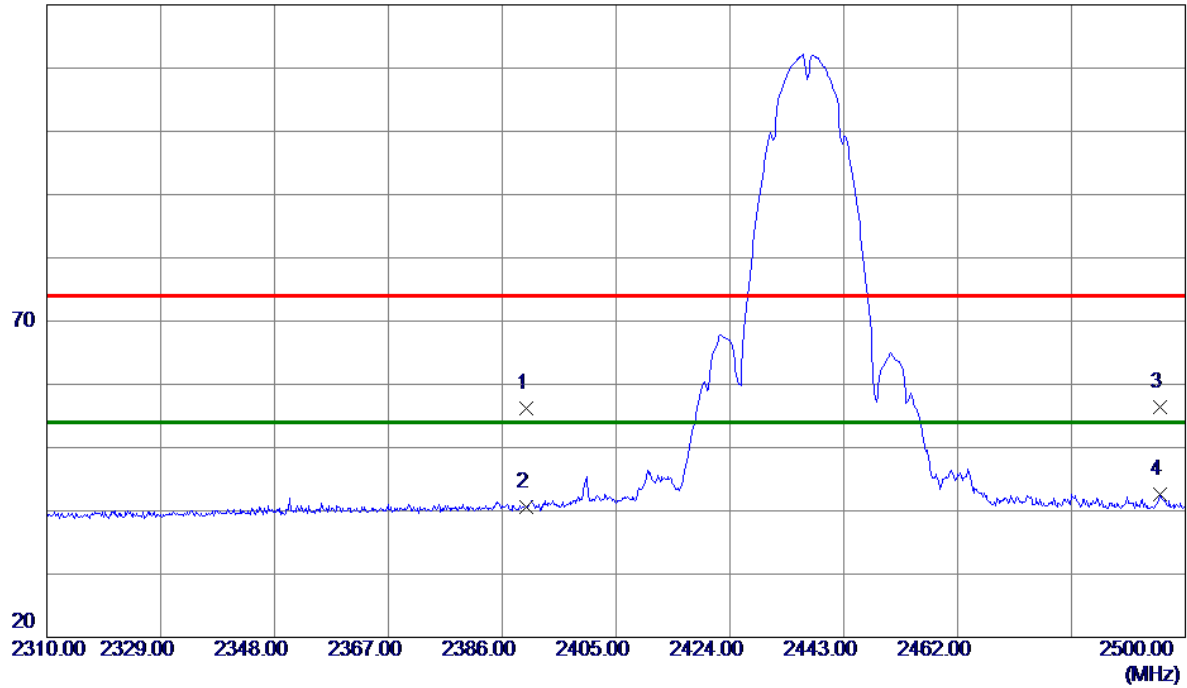

No.	Freq. MHz	Reading Level dBuV/m	Correct Factor dB	Measure ment dBuV/m	Limit dBuV/m	Margin dB	Detector	Comment
1	2390.0000	22.88	33.36	56.24	74.00	-17.76	Peak	
2	2390.0000	7.27	33.36	40.63	54.00	-13.37	AVG	
3	2495.7250	22.61	33.81	56.42	74.00	-17.58	Peak	
4 *	2495.7250	8.81	33.81	42.62	54.00	-11.38	AVG	

**REMARKS:**

- (1) Measurement Value = Reading Level + Correct Factor.
- (2) Margin Level = Measurement Value - Limit Value.

Test Mode: TX B Mode 2437 MHz

### Vertical

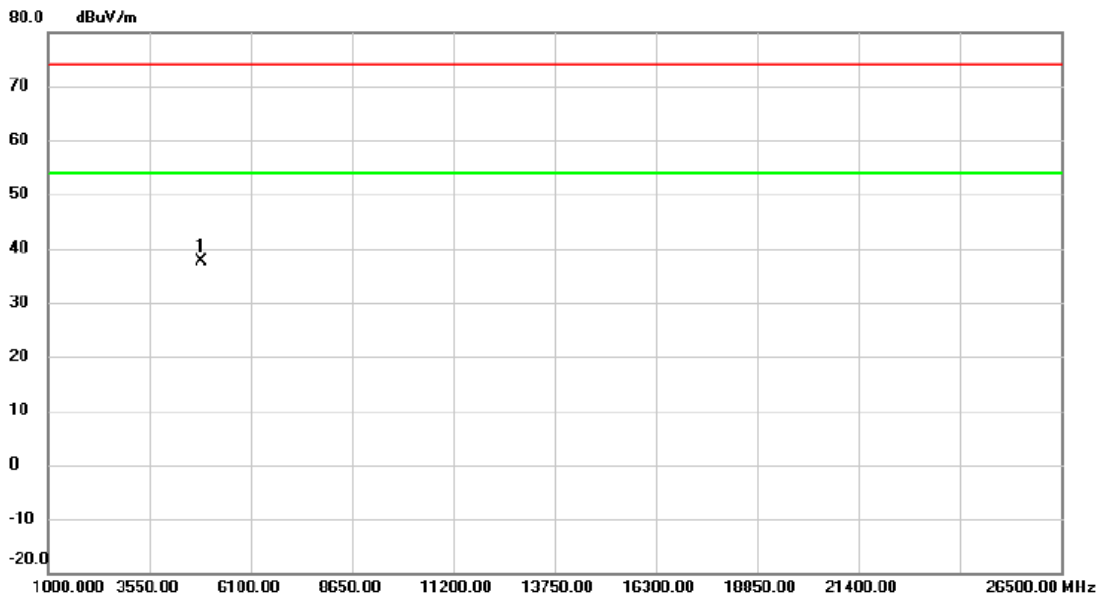

No.	Mk.	Freq. MHz	Reading Level dBuV	Correct Factor dB	Measure- ment dBuV/m	Limit dBuV/m	Margin dB	Detector	Comment
1	*	4874.000	50.47	-12.86	37.61	74.00	-36.39	peak	

**REMARKS:**

- (1) Measurement Value = Reading Level + Correct Factor.
- (2) Margin Level = Measurement Value - Limit Value.

Test Mode: TX B Mode 2437 MHz

### Horizontal

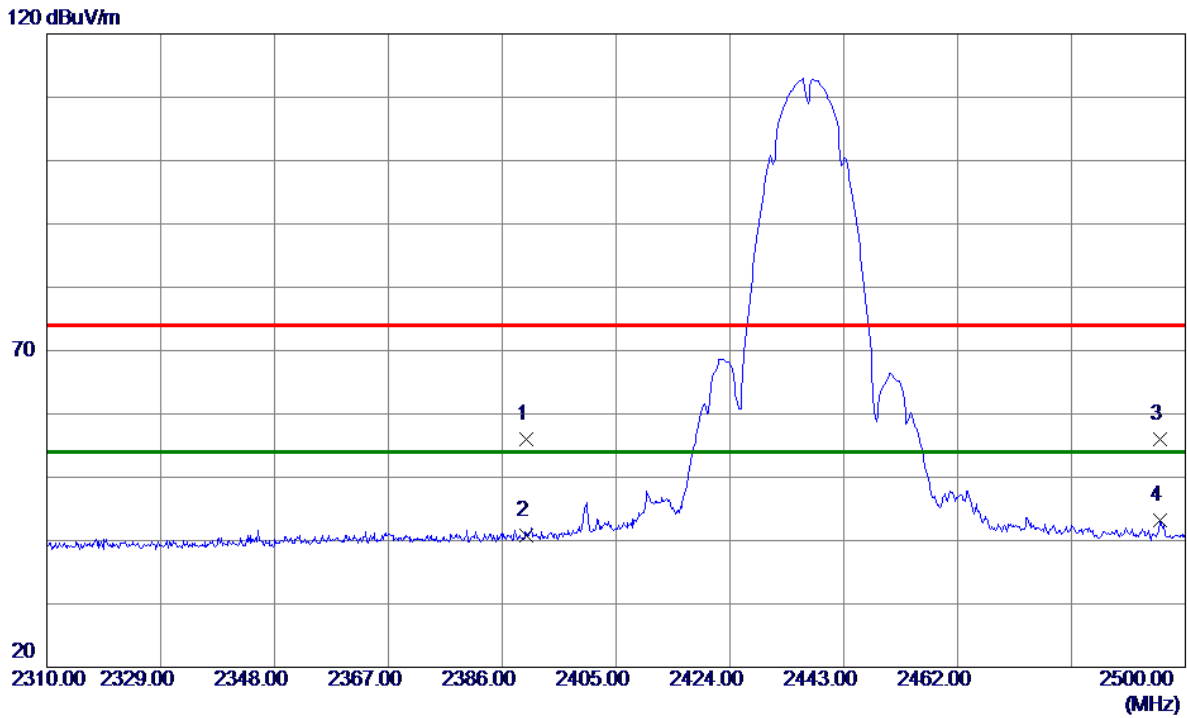

No.	Freq. MHz	Reading Level dBuV/m	Correct Factor dB	Measure ment dBuV/m	Limit dBuV/m	Margin dB	Detector	Comment
1	2390.0000	22.66	33.36	56.02	74.00	-17.98	Peak	
2	2390.0000	7.40	33.36	40.76	54.00	-13.24	AVG	
3	2495.7250	22.16	33.81	55.97	74.00	-18.03	Peak	
4 *	2495.7250	9.45	33.81	43.26	54.00	-10.74	AVG	

**REMARKS:**

- (1) Measurement Value = Reading Level + Correct Factor.
- (2) Margin Level = Measurement Value - Limit Value.

Test Mode: TX B Mode 2437 MHz

### Horizontal

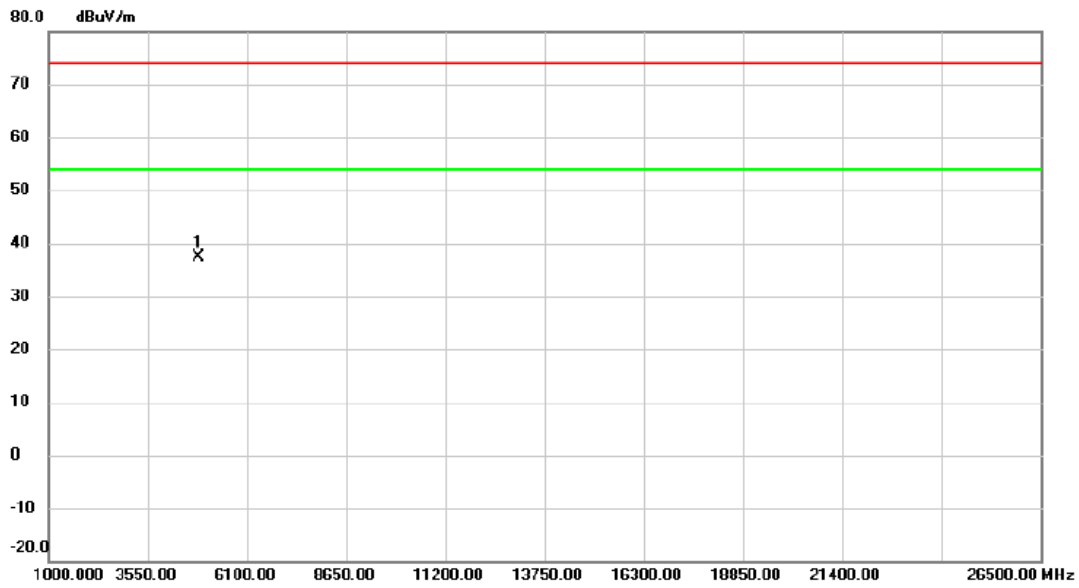

No.	Mk.	Freq. MHz	Reading Level dBuV	Correct Factor dB	Measure- ment dBuV/m	Limit dBuV/m	Margin dB	Detector	Comment
1	*	4874.000	50.21	-12.86	37.35	74.00	-36.65	peak	

**REMARKS:**

- (1) Measurement Value = Reading Level + Correct Factor.
- (2) Margin Level = Measurement Value - Limit Value.



Test Mode: TX B Mode 2462 MHz

### Vertical

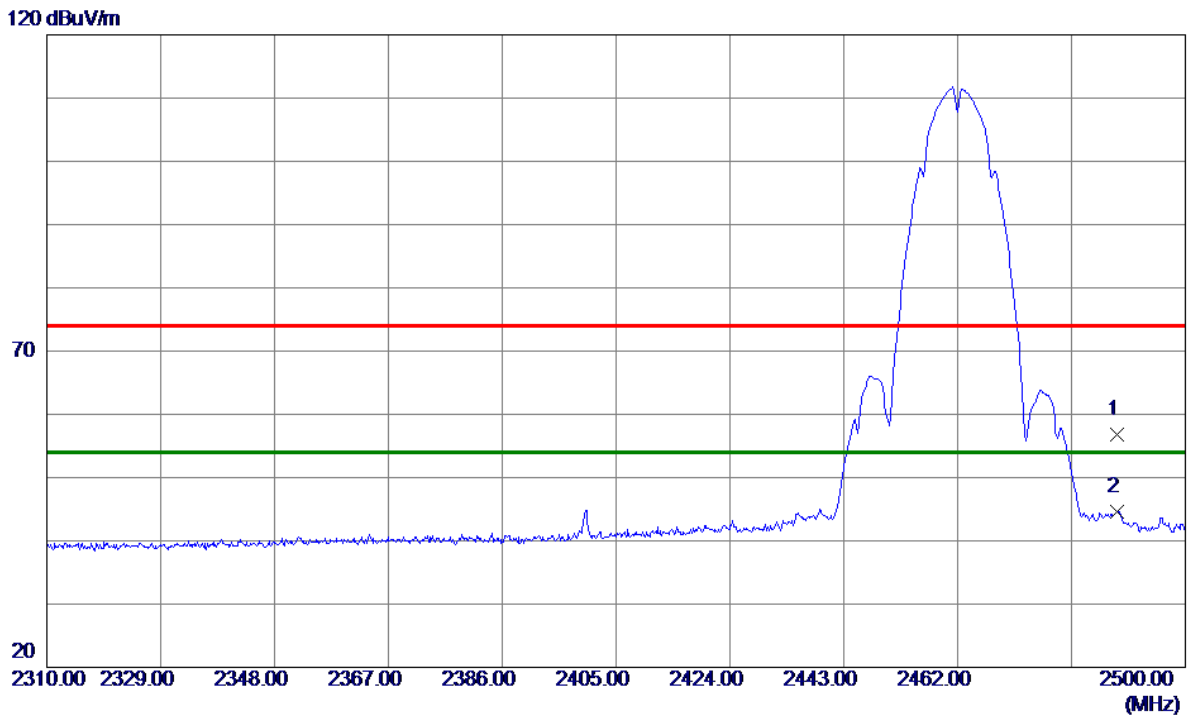

No.	Freq. MHz	Reading Level dBuV/m	Correct Factor dB	Measure ment dBuV/m	Limit dBuV/m	Margin dB	Detector	Comment
1	2488.5049	23.07	33.78	56.85	74.00	-17.15	Peak	
2 *	2488.5049	10.90	33.78	44.68	54.00	-9.32	AVG	

**REMARKS:**

- (1) Measurement Value = Reading Level + Correct Factor.
- (2) Margin Level = Measurement Value - Limit Value.