



f870x

Car Camcorder

User Manual

# Contents

About this Guide .....	5
FCC Statement .....	5
Prohibition of co-location .....	6
Important note.....	6
WEEE Notice .....	6
CE Regulatory Notice.....	7
Battery Warning .....	7
Notes on Installation.....	8
Caution .....	9
<b>1 Introduction.....</b>	<b>13</b>
1.1 Features .....	13
1.2 Package Contents .....	13
1.3 Product Overview .....	14

<b>2</b>	<b>Getting Started .....</b>	<b>16</b>
2.1	Storage Media.....	16
2.1.1	Insert the Memory Card .....	16
2.1.2	Remove the Memory Card.....	16
2.2	Installing in Vehicles.....	18
2.2.1	Mount to Windshield .....	18
2.2.2	Adjust the device position .....	19
2.3	Connecting to Power.....	21
2.4	LED Indicator .....	24
2.5	Powering the Camcorder On / Off .....	25
2.5.1	Auto Power On/Off .....	25
2.5.2	Manual Power On/Off .....	25
2.5.3	Reset.....	25
2.6	Initial Settings.....	26
2.6.1	Set Time Zone .....	26
2.6.2	Set the Date / Time.....	27
<b>3</b>	<b>Using the Car Camcorder.....</b>	<b>29</b>
3.1	Automatic Record.....	29
3.1.1	The Recording Screen.....	30
3.1.2	Emergency Recording .....	33
3.2	Add Speed Point .....	33
3.3	Picture in Video.....	34
3.4	Driving Safety.....	35

3.4.1	Speed Cam Alert.....	36
3.4.2	Speed Limit Alert.....	36
3.5	Parking Mode .....	38
3.5.1	Using embedded battery of car camcorder.....	38
3.5.2	Using car's battery with ACC cable connected. ....	41
3.5.3	Connect with power bank.....	41
3.5.4	Collision Detection .....	42
3.5.5	Driver Fatigue Alert.....	42
3.5.6	LDWS .....	44
3.5.7	FCWS.....	45
3.5.8	2 GRID FUNCTION CHART .....	47
3.6	Playback Videos and Photos .....	47
3.7	The Playback Screen .....	48
3.8	Deleting Files.....	50
<b>4</b>	<b>Initial set up Pixi Car application.....</b>	<b>52</b>
<b>5</b>	<b>Using the Pixi Car application .....</b>	<b>55</b>
5.1	Camera and Wi-Fi Setting .....	56
5.1.1	Wi-Fi Setting .....	56
5.1.2	Camera Setting.....	57
5.2	Camera preview, record, snapshot.....	59
5.3	Playback, delete, download .....	61
5.4	Local album.....	64

<b>6</b>	<b>Adjusting the Settings .....</b>	<b>66</b>
6.1	Using the Menu .....	66
6.2	Menu Items .....	66
<b>7</b>	<b>Connecting to Other Devices .....</b>	<b>72</b>
7.1	Connecting to the Computer .....	72
7.2	Connecting to TV .....	73
<b>8</b>	<b>Installing the Software .....</b>	<b>74</b>
<b>9</b>	<b>SuperCar .....</b>	<b>75</b>
<b>10</b>	<b>Specifications .....</b>	<b>77</b>

## About this Guide

The content in this document is for information purpose and is subject to change without prior notice. We have made every effort to ensure that this User Guide is accurate and complete.

However, no liability is assumed for any errors or omissions that may have occurred.

The manufacturer reserves the right to change the technical specifications without prior notice.

## FCC Statement

This equipment has been tested and found to comply with the limits for a Class B digital device, pursuant to Part 15 of the FCC Rules. These limits are designed to provide reasonable protection against harmful interference in a residential installation. This equipment generate, uses and can radiate radio frequency energy and, if not installed and used in accordance with the instructions, may cause harmful interference to radio communications. However, there is no guarantee that interference will not occur in a particular installation. If this equipment does cause harmful interference to radio or television reception, which can be determined by turning the equipment off and on, the user is encouraged to try to correct the interference by one or more of the following measures:

- Reorient or relocate the receiving antenna.
- Increase the separation between the equipment and receiver.

- Connect the equipment into an outlet on a circuit different from that to which the receiver is connected.
- Consult the dealer or an experienced radio/TV technician for help.

This device complies with Part 15 of the FCC Rules. Operation is subject to the following two conditions: (1) This device may not cause harmful interference, and (2) this device must accept any interference received, including interference that may cause undesired operation.

FCC Caution: Any changes or modifications not expressly approved by the party responsible for compliance could void the user's authority to operate this equipment.

## **Prohibition of co-location**

This device and its antenna(s) must not be co-located or operated in conjunction with any other antenna or transmitter.

## **Important note**

Radiation Exposure Statement: This equipment complies with FCC radiation exposure limits set forth for an uncontrolled environment. End users must follow the specific operating instructions for satisfying RF exposure compliance. This equipment should be installed and operated with minimum distance 20cm between the radiator & your body. To maintain compliance with FCC exposure compliance requirements, please follow the operating instructions as documented in this manual.

## **WEEE Notice**

**Disposal of Waste Electrical and Electronic Equipment and/or Battery by users in private households in the European Union**



WEEE



Battery

This symbol on the product or on the packaging indicates that this cannot be disposed of as a household waste. You must dispose of your waste equipment and/or battery by handling it over to the applicable take-back scheme for the recycling of electrical and electronic equipment and/or battery. For more information about recycling of this equipment and/or battery, please contact your city office, the shop where you purchased the equipment or your household waste disposal service. The recycling of materials will help to conserve natural resources and ensure that it is recycled in a manner that protects human health and environment.

## CE Regulatory Notice

The product herewith complies with the requirements of the battery directive 2006/66/EC, The 2014/53/EU RED-Directive, The 2009/125/EU ErP Directive and the RoHS Directive 2011/65/EC.

EU Health Protection: This equipment should be installed and operated with minimum distance 20cm between the radiator & your body.

## Battery Warning

- ❖ Never dismantle, crush, or pierce the battery, or allow the battery to short-circuit. Do not expose battery being placed in high temperature environment, if battery leaks or bulges, stop continue to use.



- ❖ Always charge using the system. Risk of explosion if battery is replaced by an incorrect type.
- ❖ Keep the battery out of reach of children.
- ❖ Batteries may explode if exposed to open fire. Never dispose of batteries in a fire.
- ❖ **Never replace the battery on your own; have the dealer do it for you.**
- ❖ Disposed of used batteries observing local regulations.

## Notes on Installation

1. Please measure the front windshield viewing area, make sure not to block driver's front view, install the camcorder below the rearview mirror (the central, higher right position of the front windshield). And we recommend that the sky and the land occupied by the screen 50%, fix the car holder and then adjust the camcorder so that the lane is aligned with the screen. Proper installation enables the camcorder to maximize the efficiency also can enhance the accuracy of LDWS.
2. Make sure that the lens is within the wiping range of the windscreen wiper to ensure a clear view even when it rains.
3. Do not touch the lens with your fingers. Finger grease may be left on the lens and will result in unclear videos or pictures. Clean the lens on a regular basis.
4. Do not install the camcorder on a tinted window. Doing so may damage the tint film.

5. Make sure that the installation position is not hindered by the tinted window.
6. This product is suitable for light windshield or light color heat-resistant film windows , it will affect video quality if install it on the dark windows or dark heat-resistant film windows.
7. Use the products of the attached power charger only, please do not use other brand power charger, in order to avoid equipment burn or cause the battery explosion.
8. **We have provided 2 mounting brackets with this HP Car Camcorder. The suction cup bracket is designed for temporary mounting and will require periodic re-installation. The adhesive bracket is designed for one time and long term installation. We recommend using the adhesive bracket if permanent installation is desired. Please install the bracket on the best open-field view. Do NOT install the bracket in a location that may obstruct your field of view and impact driving safety. HP or our authorized HP partners are NOT liable for any damages or data loss due to improper bracket mounting or suction cup bracket losing seal and dropping.**

## Caution

- ❖ Due to local laws and vehicles safety considerations, do not operate the camcorder while driving.
- ❖ Set up time zone, time and date accurately before you use this camcorder.
- ❖ Please use SuperCar software under the condition that Electronic Map are functioning normally.

- ❖ The firmware function in the camcorder is for reference only, drivers are advised to exercise discretion based on actual road conditions.
- ❖ The results of GPS positioning are only for reference, and should not affect the actual driving situation. The camcorder also cannot ensure the positioning accuracy.
- ❖ GPS positioning accuracy may differ depending on weather and location such as high buildings, tunnels, undergrounds, or forests. GPS satellite signals cannot pass through solid materials (except glass). Tinted window will also affect the performance of the GPS satellite reception.
- ❖ GPS reception performance on each camcorder may differ. The camcorder cannot determine the accuracy of the positioning results from different hardware.
- ❖ The values displayed in this camcorder, such as speed and position, may be inaccurate due to the influence of surrounding environment. They are for your reference only.
- ❖ This product is used only for non-commercial use, within the maximum limits permitted by applicable law. We do not take any responsibilities for the loss of use of the product.
- ❖ This camcorder gets warm when in use; this is normal.
- ❖ Improper use or operation of the product may result in damage of the product or its accessories and void the warranty.
- ❖ Wi-Fi Signals are unable to pass through the building. The upper limit of signal transmission is 5m.
- ❖ Wi-Fi Operation Channels List: Ch1~Ch13.

- ❖ The product employs wireless data communication which may interfere, or be interfered by, a near-by camcorder.
- ❖ Never use this camcorder in the vicinity of a microwave oven or at places where there is radio interference.
- ❖ Radio wave reception may be worsened in specific environments.
- ❖ Please be advised that if another camcorder is also using the same 2.4GHz band as this product, the processing speed of both camcorders may slow down.
- ❖ This product gets warm when in use; this is normal.
- ❖ Improper use or operation of the product may result in damage of the product or its accessories and void the warranty.
- ❖ The radio frequency (RF) generated by this RF electronic camcorder may cause adverse effects on the operation of other electronic camcorders and result in malfunctioning. Wireless transmitters and circuitry may also interfere with other electronic camcorders. Therefore, do observe the following precautions:
  - Aircraft: Never use a radio transmitter when you are in an airplane. Please switch off the Wi-Fi function of the camcorder.
  - Vehicle: The radio frequency transmitted by this camcorder may affect the electronic system in a motorized vehicle. Please consult the manufacturer or dealer of your vehicle on the possible effect.
  - Pacemaker: In order to prevent any potential interference to a pacemaker, anyone who uses a pacemaker should be advised, that, when using this camcorder, a minimum

distance of 15cm (6 inch) should be kept between the camcorder and the pacemaker; and never put this camcorder in a chest pocket. In case of any doubt of interference, switch off the camcorder immediately.

- **Medical Camcorder:** If you use a personal medical camcorder, consult the camcorder manufacturer or your physician to confirm if your camcorder is sufficiently shielded from the RF transmission of this camcorder.
- **Medical Facilities:** Hospitals and medical institutes may use facilities that are sensitive to an external RF energy. Observe such instructions when the medical care personnel or any posted sign requests you to switch off any camcorder that may interfere the radio frequency.
- ❖ **Explosion sites or any location with a posted sign:** In order to prevent interfering with an explosion activity, observe all the signage and instructions in the Explosion Area or in a zone with a “Switch Off 2-way Radios” sign by switching off camcorders that may interfere with the radio frequency.
- ❖ **HP Inc. is NOT responsible for the loss of any data/content during operation.**

**Before you start using the system, it is assumed that you**

# 1 Introduction



Thank you for purchasing this advanced Car Camcorder. This product is specifically designed for real time video recording when driving. It also supports a HP rear camera. You might ask distributor for further information.

## 1.1 Features

- SONY Sensor, low light enhancement
- Full HD 1920\*1080
- 3.0" TFT-LCD color screen
- 155° Wide angle lens
- Collision Detection, when a collision is detected, the camcorder will automatically trigger the emergency recording
- Parking Mode (Motion detection, Vibration detection)
- Multifunction traffic safety reminder

## 1.2 Package Contents

The package contains the following items. In case there is any missing or damaged item, contact your dealer immediately.

Car camcorder	Bracket X 2	CD-ROM
		
Quick start guide	Car charger	Rear Camera

		(option)

**Note:**





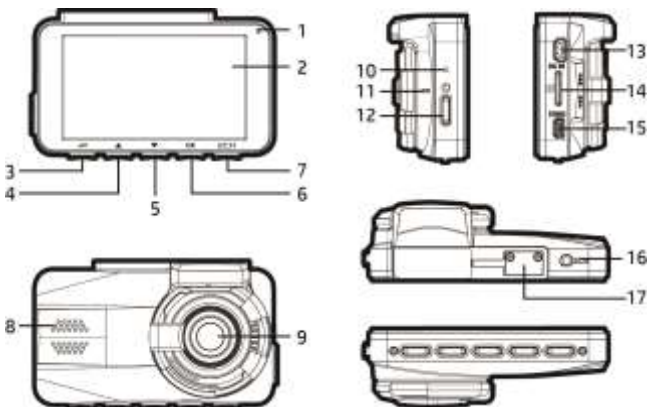



We recommend using the adhesive bracket if permanent installation is desired. Do NOT install the bracket in a location that may obstruct your field of view and impact driving safety. HP or our authorized HP partners are NOT liable for any damages or data loss due to improper bracket mounting or bracket losing seal and dropping.

## 1.3 Product Overview



No.	Item
1	LED Indicator

No.	Item
9	Wide Angle Lens

2	LCD Color Screen
3	Menu / Back Button (  /  )
4	Playback / Up Button (  /  )
5	Snapshot / Down Button (  /  )
6	Emergency Recording / Confirm Button (  /  )
7	Switch Camera Button (  <b>2CH</b> )
8	Speaker

10	Reset
11	Microphone
12	Power Switch
13	Power Connector Port
14	Memory Card Slot
15	HDMI Connector Port
16	Rear camera connector port (option)
17	Bracket Socket

Note:

Please press the button (3~7) according to the diagram notice shown on screen.



## 2 Getting Started

### 2.1 Storage Media

#### 2.1.1 Insert the Memory Card

Insert memory card with the pins facing forward and the screen of the camcorder facing forward too, see the picture as below:



#### 2.1.2 Remove the Memory Card

If the camcorder is power on, please power off first and wait for the procedure of switching off the camcorder completed before removing the memory card.

**Note:**

1. Do not remove or insert the memory card when the camcorder is turned on. This may damage the memory card.
2. Support SDHC class 10 and memory storage 8GB or above (support up to 32GB).

3. Please format the micro SD cards before the initial use. The formatted file type for this camcorder is FAT32 file.

## 2.2 Installing in Vehicles

### 2.2.1 Mount to Windshield

1. Push the mount into mount slot on top of device, until a click sound is heard.



2. Peel off the protective plastic sheet from the adhesive bracket.



3. Place and press down the bracket firmly onto your windshield.  
Make sure the base is  
securely locked in place.

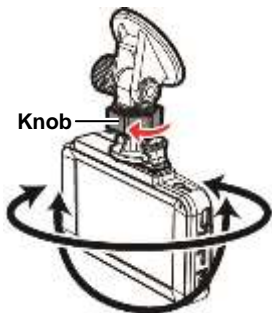

### 2.2.2 Adjust the device position

1. Loosen the knob to swivel the device vertically or horizontally.

2. Then tighten the knob to make sure the device is securely locked in place.

## 2.3 Connecting to Power

Use only the supplied car charger to power up the camcorder and charge the built-in battery.

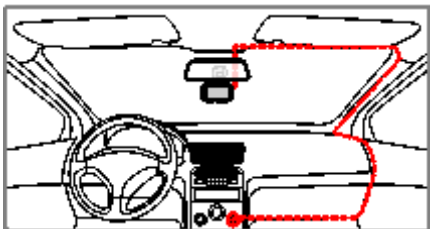







1. Connect one end of the car charger to the USB connector of the camcorder. USB port input: DC 5V / 1A.
2. Plug the other end of the car charger to the cigarette lighter socket of your vehicle. Once the vehicle engine is started, the camcorder automatically powers on. Car charger input: DC 12 / 24V.

**Note:**

Please take note if the environment temperature reaches 45°C or above, the car charger still can supply power to camcorder, but it may not charge the battery. This is characteristic of Lithium polymer battery and is not a malfunction.

## Battery Status Indicator:

Icon	Description
	Full battery power.
	2/3 battery power.
	1/3 battery power.
	Out of battery power.
	Battery is charging.
	Connect the car charger to charge the battery, battery is fully charged.

### Note:

1. Use the products of the attached car charger only, please do not use other brand car charger, in order to avoid equipment burn or cause the battery explosion.
2. Please take note if the environment temperature reaches 45°C or above, the car charger can still supply power to camcorder, but it will not charge the Lithium-ion battery. This is the characteristic of Li-polymer and is not a malfunction.

## Low Voltage:



### Note:

If the camcorder is connected to the car charger and turned on, and the screen displays a charging reminder symbol such as the image above, it means that the available voltage is too low. Please

wait for a few minutes until the charging reminder symbol disappears before entering the video recording mode to prevent invalid recording or file damage.



## 2.4 LED Indicator

Status Explanation	LED Indicator Color
Power off, battery charging	Red
Power off, battery full charged	LED light off
Power on, battery charging	Red
Power on, battery full charged	Green
Standby / Standby and screen off	Green
Recording/ Recording and screen off	Flash red

## 2.5 Powering the Camcorder On / Off

### 2.5.1 Auto Power On/Off

If the camcorder is connected to the vehicle power supply, once start the car engine, the camcorder will automatically power on and start recording.

Once the vehicle engine shuts down, the camcorder automatically saves the recording and turns off the power within 10 seconds.

### 2.5.2 Manual Power On/Off

To manually turn on the power, press the **POWER** button.

To turn off, press and hold the **POWER** button for at least 2 seconds.



### 2.5.3 Reset

Use a pin or paper clip to insert and hold the Reset hole for 5 seconds to reset the device.



## 2.6 Initial Settings









Before using the camcorder, we recommend you setup the correct **Time zone, Date and Time**.

Note:



Please note that if you press the  button during recording, the system will stop recording and enter OSD menu. Make sure the recording is already stopped then continue operating the menu.

### 2.6.1 Set Time Zone

To set the time zone, do the following:

1. Press the  button to enter the OSD menu.
2. Press the  or  button to select **Set Time Zone**, and then press the  button for entering function menu.
3. Press the  or  button to set the current time zone, and then press the  button to complete setting.
4. Press the  button to return to recording screen.



3. Press the  or  button to adjust the value, and then press the  button to set the next field.
4. Repeat step 3 until the date and time setting is completed.

Note:

To ensure the accuracy of the video file time, please reset the date and time when the battery power runs out or when not in use over 7 days.

## 3 Using the Car Camcorder

### 3.1 Automatic Record

Once start the car engine, the camcorder will automatically power on and start recording.

Recording will automatically stop when the engine is switched off.

Note:

1. Some vehicle power supply would not turn on / off automatically with the car engine start, if the camcorder cannot automatically power on/off with the car engine, please manually connect the power supply with the vehicle power, and then power on, or manually power off the camcorder and then release the connector with the car power supply.
2. It can be configured to save a video file for every 30 seconds, 1 or 3 minutes of recording.
3. All the videos and photos are saved in the memory card, if memory card is full, loop recording will generally overwrite the oldest video file.









### 3.1.1 The Recording Screen



No.	Icon	Item	Description
1		Recording Duration	Indicates the video current duration.

2		Date / Time	Indicates the current recording date and time.
3		Menu Button	During video recording, press the  button to enter the OSD menu.
4		Add Speed Point Button	During video recording, press the  button to add a speed cam point.
5		PIV (Picture in Video) Button	Press  to capture video screen shots from the front camera.
6		Emergency Recording Button	During video recording, press the  button to enter emergency recording mode.
7		Switch Camera Button	Press  to switch VIV screen. (Rear Camera is not included in standard package. Please contact distributor for further information.)
8		Satellite Positioning icon	Indicates the strength of satellite positioning. If the icon shows in red on screen, it indicates that the camcorder cannot complete the satellite positioning.
9		Speed	Current driving speed.
10		Voice Record icon	Indicates voice recording sets as off, the sound will not be recorded.



11		Resolution icon	Indicates the video resolution.
12		TF Card	When a compatible micro SD memory card is inserted, the LCD displays  . If no memory card is inserted or if the memory card is damaged / incompatible, the LCD displays  .
13		Battery Power icon	Indicates battery or camcorder charging status.
14		VIV (Video in Video)	Indicates rear camera recording screen. (Rear Camera is not included in standard package. Please contact distributor for further information.)
15		Wi-Fi	 Wi-Fi on  Wi-Fi off

## 3.1.2 Emergency Recording

To Start the Emergency Recording, do the following:

1. During Video Recording, press the  button to enter emergency recording mode, the “**Emergency**” message will be shown immediately on the upper left corner of the screen, and the recorded file will be protected.
2. The emergency video recording length is same as the recording interval setting. When the emergency recording length reaches the setting, the system will return to the general recording mode.



Note:

1. If the *Collision Detection* function is enabled and a collision is detected, the camcorder will automatically trigger the emergency recording.
2. The emergency file is created as a new file and save in Event folder, which will be protected to avoid being overwritten by normal loop recording. The emergency video folder will occupy 40% of available memory card capacity. For example, if you use 8GB memory card, about 3.2GB memory space will be saved for emergency files. When the emergency video folder is full, the oldest emergency file will be automatically deleted by the newest emergency file.

## 3.2 Add Speed Point

You may customize speed cam positions in this product.

1. When the GPS positioning is completed , press  $\triangle$  to update speed camera points.
2. This product features a capacity of 200 speed cam positions. In case you are trying to add more than that the system prompts with message "**Speed Position is full**".

Note:

You may delete custom speed cam positions by selecting the *Delete Last Position* or *Delete All Position* option from the *Speed Position Management* menu. Please note that all of your existing speed cam positions are deleted once the *Delete All Position* option is selected. Make sure you are ready to recreate your custom speed cam positions before running this option.

### 3.3 Picture in Video

You can also use this camcorder to take snapshots of the current scene.

1. In recording status, press  $\nabla$  to capture recording screen shots from the front lens.
2. When the icon  shows in the central of screen, it means the screenshots is completed.



Note:

1. The screen shots image resolution quality is depending on the video resolution setting.
  2. The picture resolution is limited by the speed of the target object and changes in ambient lighting.
- The photograph function is better used for taking still pictures in accident scenes or when the car is stopped to wait for a traffic light.

3. It is available only for the front camera if user wants to take pictures during recording.

## 3.4 Driving Safety

The following driving safety function is for reference only. Drivers are advised to exercise discretion based on actual road conditions.







Note:

1. The *Driving Safety* function is limited to triggering no more than two alarms at the same time. If a voice and alert message have been triggered, any other alarm will be ignored until either of the two is settled.
2. Satellite positioning must be completed before functions such as *Speed Cam Alert*, *Speed Position Management*, *Speed Limit Alert*, *LDWS* and *FCWS* to be enabled. Be sure to check that Satellite positioning has been completed prior to using the product.
3. The detections of *LDWS* and *FCWS* may be inaccurate when used in rain, at night or in environments of insufficient lighting. Drivers are advised to exercise discretion based on actual road conditions.

### 3.4.1 Speed Cam Alert

If the **Speed Cam Alert** function is enabled, once your car's location is determined by GPS and approaches a speed cam, this product produces audible alert and screen message.

To enable the Speed Cam Alert, do the following:

1. Press the  button to enter the OSD menu.
2. Press the  button to select **Speed Cam Alert**, and then press the  button for entering function menu.
3. Press the  button to select **On**, and then press the  button to enable the function.
4. Press the  button to return recording screen.
5. The alarm screen turns red to remind you to slow down if you are driving faster than the speed limit.



#### Note:

The speed cam alert function must have the speed cam datum from the country you use. The function will be void if the product is used in any other countries. Please consult with the shop you purchased if the function is void. There is no guarantee the speed cam datum will be included for the worldwide countries.







### 3.4.2 Speed Limit Alert

If the **Speed Limit Alert** function is enabled, this product produces audible alert and screen message once your car's location is



determined by GPS and its running speed exceeds the set limit.









To set the Speed Limit Alert, do the following:

1. Press the  button to enter the OSD menu.
2. Press the / button to select **Speed Limit Alert**, and then press the  button for entering function menu.
3. Press the  button to set up a Speed Limit Alert to trigger this product's alarm [Off / 50 ~ 200 km/h (30~125 mph)], and then press the  button to complete setting.
4. Press the  button to return recording screen.
5. The alarm screen turns red to remind you to slow down if you are driving faster than the speed limit.

## 3.5 Parking Mode

To monitor the vehicle when it is parked, you can activate **Motion Detection**, or **Vibration Detection**.

Follow the steps below to change the settings for Parking Mode:

1. Press the  button to enter the main menu.
2. Press the  or  button to select **Parking Mode**, and then press the  button to confirm.
3. Press the  or  button to configure Parking Mode (Motion Detection / Vibration Detection / Off), and then press the  button to complete setting.
4. Press the  button to return to recording screen.



### 3.5.1 Using embedded battery of car camcorder

- **Motion Detection:**

- If disconnected external power supply when the camcorder is powered on, the system alert message "***Press OK to power off or enter Parking mode after 10 sec.***" This means the system will enter Motion Detection automatically in 10 seconds, and then LCD screen turns off (the camcorder will turn off the screen temporarily, but still in standby detection status. Press any

button to turn on the operation screen and resume to normal loop recording).

- In the Motion Detection mode, when the camcorder detects any motion in front of lens, the automatic record will be activated.
- In this mode, when the camcorder detects any motion in front of lens, the video recording will be triggered and the event will be recorded for 10 seconds (per file). If the event lasts more than 10 seconds, the camcorder will keep recording up to 2 minutes.
- In this mode, the camcorder is in standby mode until event happens. This mode will consume more battery power.
- To disable this function, in the standby mode or motion detection recording, press any key to wake up the screen, and resume to normal loop recording; or when the car engineer is started again, it will be back to normal loop recording.

● **Vibration Detection:**

- If disconnected external power supply when the camcorder is powered on, the system alert message "***Press OK to power off or enter Vibration Detection after 10 sec.***" This means the system will power off and enter Vibration Detection automatically in 10 seconds.
- Once Vibration Detection Mode is triggered, when the camcorder detects any vibration, it will automatically power on and start recording, the event will be recorded for 60 seconds (per file).
- In this mode, car camcorder is powered off until event happens. This mode is more power saving.



- To disable this function, in the vibration detection recording, press any key to wake up the screen, and resume to normal loop recording; or when the car engineer is started again, it will be back to normal loop recording.

**Note:**

1. When *Motion Detection* or *Vibration Detection* triggers, the camcorder records events taken by front camera only.
2. If battery in a fully charged condition and Wi-Fi is off, it can record about 30 minutes video in *Motion Detection* mode. As the camcorder is used, the battery storage capacity will decrease gradually. This is a normal phenomenon for the battery.
3. The video files taken in Motion Detection mode will be saved in normal recording folder.
4. The video files taken in Vibration Detection mode will be saved in Event recording folder, which will not be overwritten by normal video files.

### 3.5.2 Using car's battery with ACC cable connected.

- **Motion Detection:**

- In normal loop recording mode, press and hold POWER for 3 seconds, The screen will show message "***Press OK to power off or enter Motion Detection after 10 sec.***"
- To disable this function, press any key to wake up the screen, and resume to normal loop recording; or when the car engine is started again, manually power off and power on the car camcorder, it will be back to normal loop recording.

- **Vibration Detection:**

- Not available for this function

### 3.5.3 Connect with power bank

- **Motion Detection:**







- In normal loop recording mode, unplug car adapter and connect power bank, press and hold POWER key for 3 seconds, The screen will show message "***Press OK to power off or enter Motion Detection after 10 sec.***"
- To disable this function, press any key to wake up the screen, and resume to normal loop recording; or when the car engine is started again, unplug the power bank, and connect car adapter, it will be back to normal loop recording.

- **Vibration Detection:**

- Not available for this function

### 3.5.4 Collision Detection







If the **Collision Detection** function is enabled, this camcorder begins emergency recording once it detects any collision. Sensitivity of the Collision Detection function is set to Normal by default, if user wants to change the settings of Collision Detection, do the following:

1. Press the  button to enter the OSD menu.
2. Press the  button to select **Collision Detection**, and then press the  button for entering function menu.
3. Press the  button to change the sensitivity of this camcorder's collision detection (High Sensitivity / Normal Sensitivity / Low Sensitivity / Off), and then press the  button for entering function menu.
4. Press the  button return to recording screen.

### 3.5.5 Driver Fatigue Alert

If the **Driver Fatigue Alert** function is enabled, this product produces audible alert and screen message one hour after it has begun recording and repeats the alerts every half hour afterwards.







To enable the Driver Fatigue Alert, do the following:

1. Press the  button to enter the OSD menu.
2. Press the  button to select **Driver Fatigue Alert**, and then press the  button for entering function menu.
3. Press the  button to select **On**, and then press the  button to enable the function.
4. Press the  button return to recording screen.
5. This product produces audible alert and screen message when **Driver Fatigue Alert** activates.



### 3.5.6 LDWS

Once your car's location is determined by GPS and the **LDWS** function is enabled, this camcorder produces audible alert and screen message when you drive off of or change lanes at speeds over 70 km/h (43 mph). To set the LDWS (Lane Departure Warning Systems), do the following:

1. Press the  button to enter the OSD menu.
2. Press the  button to select **LDWS**, and then press the  button for entering function menu.
3. Press the  button to select **On**, and then press the  button to enable the function.
4. Press the  button to return to recording screen.
5. After enabling **LDWS**, the screen will display traffic lane align icon  , please adjust the camcorder so that the horizontal line and the eye level are overlapped and the slash lines are centered in the driving lane.

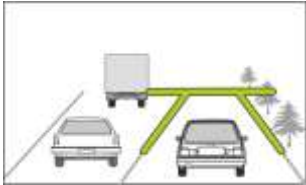

6. This product produces audible alert and screen message when **LDWS** is activates.









Note:

1. Please measure front windshield viewing area, do not block the driver's forward field of vision, and install the camcorder below rearview mirror (upper central of the front windshield). We recommend that the sky and the ground occupied 50 % of the video screen, install the bracket then adjust the camcorder to make the lane is aligned to the lane alignment icon. Correct installation makes the camcorder to maximize the efficiency and improve the accuracy of LDWS.
2. Make sure that traffic lane align icon will not be obscured other things (e.g. hood). It may cause misjudgment if the endpoint is obscured.

### 3.5.7 FCWS

Once your car's location is determined by GPS and the **FCWS** function is enabled, this camcorder produces audible alert and screen message when you drive at speeds over 60 km/h (37 mph) and are less than 20 m away from the car in front of you. If the camcorder not completes the satellite positioning, and the leading vehicle distance below 20 meters, it will also produce a warning screen and beep reminder.



To set the FCWS (Forward Collision Warning System), do the following:

1. Press the  button to enter the OSD menu.
2. Press the  button to select **FCWS**, and then press the  button for entering function menu.
3. Press the  button to select **On**, and then press the  button to enable the function.
4. Press the  button to return recording screen.

5. This product produces audible alert and screen message when **FCWS** is activates.



## 3.5.8 2 GRID FUNCTION CHART

When the camcorder is recording, press  Power button will enter 2 GRID FUNCTION CHART in the LCD screen, users can check vehicular informations here. Press  Power button once again will go back into your recording.





No.	Item
1	Driving Speed

No.	Item
2	Driving direction

Note:

Driving Speed and Driving Direction are only applicable when satellite positioning of the camcorder is ready; otherwise, they will be displayed in gray scale only. Satellite positioning function is dependent on the model purchased.







## 3.6 Playback Videos and Photos

1. If recording is in progress, press the  /  button













to stop recording and enter the playback menu.

2. Press the  or  button to select the file category that you want to browse and press the  button to display thumbnail images of the recorded video or photo files.
3. Use the  or  to select the video or photo you want to playback, and press  button to confirm your selection.

### 3.7 The Playback Screen













No.	Item	Description
1	File name	File name
2	Duration/ Total recorded time	Indicates the video elapse time/ Indicates total recorded time
3	Return	Press the  button to return preview screen of video or picture. Press the  button repetitively to return recording screen.
4	Previous File Button	Press  button to view previous file.
5	Next File Button	Press  button to view next file.
6	Playback/	Press the  button to play or pause the video.

	Pause button	
7	Lens Switch Button	In playback mode, press  button to switch files with dual lens recording file. (Rear Camera is optional.)
8	Stamp print	Indicates date and time stamp
9	File	Current file / total file number
10	TF Card	When a compatible micro SD memory card is inserted, the LCD displays  . If no memory card is inserted or if the memory card is damaged / incompatible, the LCD displays  .
11	Battery	Indicates the estimated remaining battery power.
12	Date and time	Date and time of photo taking

## 3.8 Deleting Files

To delete file(s), perform the following steps:

1. Press the  button to stop recording and enter the main Menu.
2. Press the  or  button to select File Deletion and press the  button to confirm.
3. Press the  or  button to select folder and press the  button to confirm.
4. Use the  or  to select the video or photo you want to delete, and press  button to confirm your selection.



Item	Description
Delete One	Delete the current selected file.
Delete All	Deletes all files in this folder.

5. Press the  button to confirm deletion.

**Note:**

1. Deleted files CANNOT be recovered. Ensure the files you wish to preserve are backup before deletion.
2. If the file is taken by front camera and rear camera at the same time, no matter you delete video or picture from Front camera folder or Rear camera folder, both front camera file and rear camera file will be deleted.

## 4 Initial set up Pixi Car application

### 4.1 Camcorder application installation

The camcorder allows you to connect to the mobile devices via the App. When using for the first time, install the **[Pixi Car]** App for your mobile device.

1. Download **Pixi Car** App  from Google Play or App Store.
2. Install the App.

APP layout and features may be changed subject to different software versions. Please refer to Google Play or

## 4.2 Wi-Fi connecting

1. Press the **Power** button to switch on the camcorder.
2. Enter Menu and go to **Wi-Fi** option; choose “ON” to activate the wireless network.
3. The camcorder’s screen will display Wi-Fi Device ID and Password. Using the Wi-Fi function of your mobile device, search for the camcorder ID “hp\_f870x\_12345” from the list (last 5 numbers are system random numbers). Enter default password 00000000.



4. There is a Wi-Fi icon on the camcorder's screen. Once the icon is blue, your connection has been successfully established.

5.



**Note:**

1. The mobile device shall be within a maximum of a 5m distance from the camcorder without any buildings in between.
2. When the Wi-Fi function of the camcorder is ON but not yet connecting with your mobile device, or the connection is disconnected, the Wi-Fi icon on camcorder's screen will be white, and you will need to re-activate the Wi-Fi and re-pair with your mobile device.
3. After connecting the mobile device with the camcorder, and activate app feature "Camera Preview", all the button operation of the camcorder will be disable; all the operations shall be carried out via the Pixi Car App.
4. The language of the Pixi Car App will be consistent with your mobile device, beyond the language options, the App will be activated with default language.

## 5 Using the Pixi Car application

Touch [Pixi Car]  icon to activate the application. The main screen will pop up. Follow the below instruction to operate this application.





## 5.1 Camera and Wi-Fi Setting

### 5.1.1 Wi-Fi Setting

You can use this feature to set up new Wi-Fi ID and password.

1. Touch icon  [Camera & WiFi Setting].
2. Touch [WiFi Setting].
3. Enter new Wi-Fi ID and password, and touch [Update] to re-new setting.



- Using the Wi-Fi function of your mobile device, search for new Wi-Fi ID from the list and enter new password. The Wi-Fi icon on the camcorder's screen will turn to green, and your connection has been successfully established.

## 5.1.2 Camera Setting

You can use this feature to set up your car camcorder.

- Touch icon  [Camera & WiFi Setting].
- Touch [Camera Setting].
- Refer to the below table for details of menu items and available menu options.

Menu option	Description	Available option
Resolution	Set the desired video resolution.	1080P / 30 fps, 1080P/ 27.5 fps, 720P / 30 fps, 720P/ 55 fps
Collision Detection	If Collision Detection is activated, this camcorder starts emergency recording once it detects any collision.	Off/Low Sensitivity/ Normal Sensitivity/ High Sensitivity
Anti-flicker	Domestic power supply varies by area. It is recommended that you should check the "Table of voltage and frequency	50Hz / 60Hz



Menu option	Description	Available option
	of different countries" for the correct setting.	
EV	Setting of exposure value.	+2 ~ -2
Date/Time	Synchronize car camcorder's date/time with mobile device	
Firmware Version	Indicates the current car camcorder's firmware version.	
App Version	Indicates the current application version.	

## 5.2 Camera preview, record, snapshot

You can use this feature to preview, record or take snapshot.

1. Touch icon  [Camera Preview] ,
2. The mobile device will display camcorder's preview screen. The camcorder will lose control and screen will show "Network Streaming". Please use Pixi Car app to operate the camcorder.



	icon	Description
1		Start/stop recording
2		Snapshot (no matter in front camcorder or rear camcorder preview, once you touch this icon, both of front and rear camcorder will take photo.)
3		Switch front and rear camcorder preview

**Note:** [Camera Preview] is subject to car camcorder in recording mode.



## 5.3 Playback, delete, download



You can use this feature to playback or delete the file saved in camcorder, or to download the file from camcorder to your mobile device.



4. Touch icon [Camera Playback].
5. The files saved in the camcorder will be displayed on your mobile device. Camcorder will stop recording for a few seconds until your mobile device finishes reading the saved files from camcorder, and screen will show "Network Playback".
6. Pick up the file that you want to playback, delete or download, and touch below icon to execute.



	Icon	Description
1		Playback
2		Delete
3		Download the file from camcorder to your mobile device

4		Switch front and rear camcorder
5		File folder option: Event, Video, Photo

**Note:**

1. If you find the video playback without audio, please check if you turn on Voice Record on the menu. If you do turn it on, it means the mobile device itself doesn't support the video decoding. It's not the problem of the file. We recommend you to install a free app software such as VLC to playback the file.
2. Deleted files cannot be recovered. Ensure the files have been backed-up before deletion.
3. Picture and video files could be downloaded to the internal memory of your mobile device. Use the application program in your mobile device to view the file.





## 5.4 Local album

You can use this feature to playback or delete the file that you download to your mobile device.

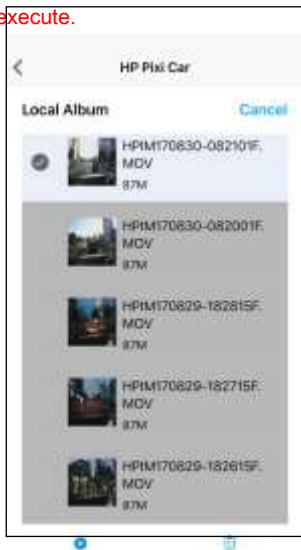
1. Touch icon  [Local Album] .
2. Pick up the file that you want to playback or delete, and touch below icon to execute.



	Icon	Description
1		Playback
2		Delete







Note:

1. Deleted files cannot be recovered. Ensure the files have been backed-up before deletion.
2. If you find the downloaded files could not be played or without audio, which means the mobile device itself does not support the video decoding. It's not the problem of the file. We recommend you to install a free App software such as VLC to playback the file.

# 6 Adjusting the Settings

## 6.1 Using the Menu

You can customize the general settings via the on-screen display (OSD) menus.





1. Press the  button to enter the OSD menu.
2. Press the  button to select menu item, and then press the  button for entering function menu.
3. Press the  button to select or adjust the value, and then press the  button to confirm setting.
4. Press the  button to return recording screen.

## 6.2 Menu Items

Refer to the below table for details of main menu and function list.

Menu option	Description	Available option
Rear Cam Setting	select the type of rear camera	None/ RC3 (1080p)/ H42 & H2 (720p)
Playback	Select the file category that you want to view.	Video (Front camera) Video (Rear camera) Event (Front camera) Event (Rear camera) Picture (Front camera) Picture (Rear camera)
Wi-Fi	Set up Wi-Fi linkage of a mobile phone.	On / Off
Satellite Status	Displays the current state of the satellite reception.	

Menu option	Description	Available option
Satellite Synchronization	If the satellite time is enabled, the car camcorder clock will synchronize according to the satellite time zone you set. When you turn on this feature, it will display the satellite time preferentially, and cannot be manually changed.	On / Off
Speed Unit	The system displays the speed setting unit.	KM/H / MPH
Speed Cam Alert	If the Speed Cam Alert function is enabled, once your car's location is determined by GPS and approaches a speed cam, this product produces audible alert and screen message.	On / Off
Speed Position Management	<p><b>Add Speed Point:</b> The satellite positioning will manually add speed camera location. You can add up to 200 speed camera locations to the built-in system.</p> <p><b>Delete Last Position:</b> Delete the last speed camera point.</p> <p><b>Delete All Position:</b> Delete all speed camera point.</p>	Add Speed Point / Delete Last Position / Delete All Position

Menu option	Description	Available option
Speed Limit Alert	Set a customized maximum speed limit. When the vehicle speed exceeds the maximum, an audible alert is automatically triggered and a warning message is displayed on the screen.	Press the  button to set the speed limit. You can set the off, or set speed limit from 50 to 200km/h (30 to 125mph)
Set Time Zone	Set the time zone you are in.	Press the  button to set the satellite time. You may customize it between GMT -12:00 ~ GMT +14:00
Date / Time	Set the date and time.	Press the  button to adjust the value, and then press the  button to set the next field, and complete setting
Language	Language setting.	According to the actual shipping regions.
Time Stamp	If the time stamp is enabled, recording files or photos will show the date and time.	On / Off
Resolution	Setting of video resolution.	1080P / 30 fps, 1080P/ 27.5 fps, 720P / 30 fps, 720P/ 55 fps
EV	Setting of exposure value.	Press the  button to set the exposure value. It can be set between -2 ~ +2

Menu option	Description	Available option
LCD Setting	Set LCD off time. Camcorder screen will be off after a set time if no operation is detected during the standby or record mode. Press any button will switch it on. (Recording is not affected when screen is off).	On/ Turn off after 7 sec / Turn off after 1min/ Turn off after 3min
Voice Record	Setting for activating audio in the video.	On / Off
Volume	Adjust the sound volume.	Press the  button to set the volume. It can be set between 0 ~ 10.
Key Tone	Enable / disable power-on sound and key tone.	On / Off
Record Interval	Save respective video files in a length of the selected duration.	30 sec. / 1 min. / 3 min.
Parking Mode	If one of parking mode is activated, the camcorder will enter parking mode 10 seconds after disconnect the external power.	Motion Detection/ Vibration Detection/ off
Collision Detec.	If Collision Detection is activated, this camcorder starts emergency recording once it detects any collision.	High Sensitivity / Normal Sensitivity / Low Sensitivity / Off

Menu option	Description	Available option
Driver Fatigue Alert	When Driver Fatigue Alert is enabled, audible alert and screen message will be activated 1 hour after the camcorder is powered on, with a repetition every 30 minutes.	On / Off
LDWS	Once your car's location is determined by GPS and the LDWS function is enabled, this camcorder produces audible alert and screen message when you drive off of or change lanes at speeds over 70 km/h (43 mph).	On / Off
FCWS	When FCWS is activated after satellite positioning, camcorder will issue audible alert and screen message when vehicle speed is above 60 km/h (37 mph) and the distance with the front vehicle is less than 20m.	On / Off
File Deletion	Delete the file(s).	Video (Front camera) Video (Rear camera) Event (Front camera) Event (Rear camera) Picture (Front camera) Picture (Rear camera)

Menu option	Description	Available option
Anti-flicker	Domestic power supply varies by area. It is recommended that you should check the “Table of voltage and frequency of different countries” for the correct setting.	60Hz / 50Hz
Format	Format the memory card inserted in the equipment. All the files in the card will be erased.	Yes / No
Default	The system reverts to the default setting.	Yes / No
Firmware Version	Indicates the current firmware version.	



# 7 Connecting to Other Devices

## 7.1 Connecting to the Computer

You can connect the camcorder to a desktop computer or notebook to transfer or view files.

1. Connect mini USB cable to the camcorder mini USB port.
2. Connect the other end of USB cable to an available USB port of your computer.



3. Power on the camcorder, the computer screen will show up the message when the computer detects your camcorder, select "Open folder to view files", or open the "Removable Disk", then users can save the files to your computer.

**Note:**

1. This only indicates the camcorder can connect to the computer; mini USB cable is not included in standard package.
2. Under dual-lens mode, the recording files will be saved separately in different folders, "F" folder is for front camera files, "R" folder is for rear camera files.

## 7.2 Connecting to TV

You can use HDMI cable transfer to TV to play the file.

1. Power on the camcorder.
2. Connect HDMI cable to camcorder HDMI port.
3. Connect HDMI cable to TV HDMI port.

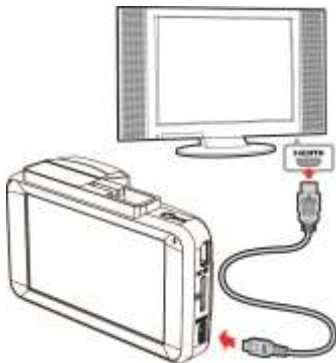

4. Power on TV, switch TV signal input to HDMI, please operates by camcorder  **2CH** buttons.

**Note:**

1. It only indicates this camcorder can connect to TV, HDMI cable is not included in standard package.
2. Please make sure the camcorder power is on before using HDMI cable connecting to TV.

## 8 Installing the Software

1. Place the attached CD ROM into the CD player.
2. If the CD does not execute automatically, please use Windows File Manager to execute the Install\_CD.exe file in the CD.

The following screen will be shown up.



3. Press the [Menu] item to start the installation process according to the instructions on-screen.

## 9 SuperCar



No.	Item
1	Front Camera Playback
2	Play / Pause
3	Previous
4	Next
5	Stop
6	Electronic Map
7	Compass
8	Speed Meter

No.	Item
9	File Path
10	Browser File
11	File List
12	Rear Camera Playback
13	Volume
14	Playback Duration / Total Duration
15	G-Sensor

**Note:**

1. To display the route on Electronic Map, please make sure the internet is connected before starting the video playback.

2. Video files of front-view camera (MOV) and GPS/G-Sensor files (NMEA) must be stored in the same folder before starting the playback.
3. The SuperCar software is only applicable to Windows operating system.

# 10 Specifications

Item	Description
Image sensor	1/2.9" SONY sensor
Effective pixels	1920 (H) x 1080 (V)
Storage media	Supports Micro SDHC, up to 32GB class 10 speed or greater
LCD display	3" LCD color TFT
Lens	Wide Angle Fixed Focus lens Aperture: Up to F1.8
Focus range	1.5m~Infinity
Satellite System	GPS (frequency:1575.42MHz)
Video	Resolution: 1080P/ 30 fps 、 1080P/ 27.5 fps 、 720P/ 30 fps 、 720P/ 55 fps
	Format: MOV
Still image (Photograph)	Resolution: depends on video resolution setting
	Format: DCF (JPG)
Shutter	Electronic shutter
G-Sensor	3-Axis G-Force sensor
ISO	Auto
White Balance	Auto

Item	Description
Microphone	Built-in
Speaker	Built-in
Interface	Mini USB, A/V port, HDMI
Battery	Built-in Li-polymer rechargeable (This battery is NOT replaceable)
Operating Temperature	0° ~ 60° C
Operating Humidity	20 ~ 70% RH
Storage Temperature	-20° ~ 70° C
Dimensions	87.6 x 28.5 x 53.1 mm
Weight	Approx. 94g
Built-in IEEE 802.11b/g/n(HT20) Wi-Fi chip: AP6181	
Frequency range	2412~2472MHz for EU; 2412~2462MHz for FCC
WiFi Channel	Ch1~Ch13 for EU; Ch1~Ch11 for FCC
WiFi Max. output	16.43dBm for EU; 23.70dBm for FCC





**HDMI**™  
HIGH DEFINITION MULTIMEDIA INTERFACE