

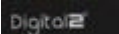

**SAR Evaluation Report**  
for  
**IEEE Std1528-2013, FCC KDB Publication 648474 D04**  
**Handset SAR v01r02 and 47CFR § 2.1093**

**Report No.:SESF1407074**

Client : Procom Products Inc.  
Product : Mobile Phone  
Model : D554P, DxxxP(xxx: stand for 0~9)  
Trade Mark :   
FCC ID : 2ACE6-DSPHXX  
Manufacturer/ supplier : Huizhou Hengdu Electronics Co., Ltd  
Date test campaign completed : July 27th,2014  
Date of issue : July 31th,2014  
Test Result :  Compliance  Not Compliance

**Statement of Compliance:**

The SAR values measured for the test sample are below the maximum recommended level of 1.6 W/kg averaged over any 1g tissue according to FCC KDBs and IEEE Std.1528-2013.

**The test result only corresponds to the tested sample. It is not permitted to copy this report, in part or in full, without the permission of the test laboratory.**

*Total number of pages of this test report: 188 pages*

The testing described in this report has been carried out to the best of our knowledge and ability, and our responsibility is limited to the exercise of reasonable care. This certification is not intended to believe the sellers from their legal and/or contractual obligations.

Test Engineer:

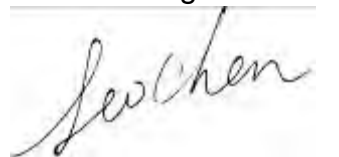

Leo Chen

Approved by:



Miro Chueh



## Applicant Information

<b>Client</b>	:	Procom Products Inc.
<b>Address</b>	:	525 Parriott Place, City of Industry, CA 91745
<b>Manufacturer</b>	:	Huizhou Hengdu Electronics Co., Ltd
<b>Address</b>	:	DIP South Area, Huiao Highway, Huizhou, Guangdong, China
<b>EUT</b>	:	Mobile Phone
<b>Model No.</b>	:	D554P, DxxxP(xxx: stand for 0~9)
<b>Standard Applied</b>	:	IEEE Std1528-2013 and 47CFR § 2.1093 FCC KDB Publication 648474 D04 Handset SAR v01r02 FCC KDB Publication 447498 D01v05r02 FCC KDB Publication 865664 D01v01r01
<b>Laboratory</b>	:	CERPASS TECHNOLOGY CORP. No.66, Tangzhuang Road, Suzhou Industrial Park, Jiangsu 215006, China.
<b>Max. Average Output Power</b>	:	GSM850: 32.29dBm GSM1900: 28.31dBm WCDMA Band II:22.42dBm WCDMA Band IV:21.26dBm WCDMA Band V: 24.66dBm WLAN: 15.54dBm BT: 1.04dBm
<b>Max. Reported SAR Value</b>	:	Head GSM850: 0.009W/kg(1g) PCS1900: 0.091 W/kg(1g) WCDMA Band II: 0.075 W/kg(1g) WCDMA Band IV: 0.113 W/kg(1g) WCDMA Band V: 0.044 W/kg(1g) 802.11b: 0.166 W/kg(1g) Body GSM850: 0.214W/kg(1g) PCS1900: 1.025 W/kg(1g) WCDMA Band II: 0.278 W/kg(1g) WCDMA Band IV: 0.570 W/kg(1g) WCDMA Band V: 0.057 W/kg(1g) 802.11b: 0.169 W/kg(1g)



<b>Max. Simultaneous SAR Value</b> :	Head
	WCDMA Band IV+802.11b: 0.279 W/kg(1g)
	Body
	GPRS 1900+802.11b: 1.194 W/kg(1g)



**Contents**

**Applicant Information .....2**

**1. General Information .....5**

1.1. Executive Summary .....5

1.2. Description of Equipment under Test .....5

1.3. Antenna Location .....7

1.4. Simultaneous Transmission Configurations .....7

1.5. SAR Test Exclusions Applied .....9

1.6. Power Reduction for SAR .....9

1.7. Environment Condition .....9

1.8. Test Standards ..... 10

1.9. RF Exposure Limits ..... 10

**2. The SAR Measurement Procedure ..... 11**

2.1. System Performance Check ..... 11

2.2. Test Requirements ..... 17

**3. DASYS Measurement System ..... 21**

3.1. Uncertainty of Inter-/Extrapolation and Averaging ..... 22

3.2. DASYS E-Field Probe ..... 22

3.3. Data Acquisition Electronics (DAE) ..... 23

3.4. Robot ..... 23

3.5. Light Beam Unit ..... 23

3.6. Measurement Server ..... 24

3.7. SAM Phantom ..... 24

3.8. Device Holder ..... 25

3.9. Test Equipment List ..... 26

**4. Results ..... 35**

4.1. Conducted power (Averaged) ..... 35

4.2. Estimated SAR for Bluetooth ..... 39

4.3. SAR Test Results Summary ..... 40

**5. The Description of Test Procedure ..... 52**

5.1. General Notes: ..... 52

5.2. Simultaneous Transmission Procedures ..... 52

5.3. Simultaneous Transmission Analysis ..... 53

5.4. Simultaneous Transmission Conclusion ..... 55

**6. Measurement Uncertainty ..... 56**

**7. APPENDIX A. SAR System Validation Data ..... 57**

**9. APPENDIX B. SAR measurement Data ..... 65**

**8. APPENDIX C Antenna Location, EUT and Test Setup Photographs ..... 133**

**9. APPENDIX D. Probe Calibration Data ..... 134**

**10. Appendix E. Dipole Calibration Data ..... 145**

**11. Appendix F. DAE Calibration Data ..... 184**



## 1. General Information

### 1.1. Executive Summary

The EUT is a MOBILE PHONE with operations in 850MHz, 1700MHz, 1900MHz and 2450MHz frequency ranges. It contains GSM/GPRS, WCDMA band II, WCDMA band IV, WCDMA band V, 802.11b/g/n and BT functions for SAR testing. The measurement was conducted by CERPASS, carried out with the dosimetric assessment system under DASYS. And it conducts according to the IEEE Std.1528-2013 and FCC KDBs for SAR evaluating compliance.

### 1.2. Description of Equipment under Test

<b>Product Name</b>	Mobile Phone
<b>Model No.</b>	D554P, DxxxP(xxx: stand for 0~9)
<b>IMEI1</b>	200364391378587
<b>IMEI2</b>	830565743232603
<b>Device Category</b>	Portable
<b>RF Exposure Environment</b>	Uncontrolled
<b>Antenna Type</b>	Internal
<b>2G</b>	
<b>Support Band</b>	GSM850/PCS1900
<b>GPRS Type</b>	Class B
<b>GPRS Class</b>	Class 12
<b>Uplink</b>	GSM 850: 824~849MHz PCS 1900: 1850~1910MHz
<b>Downlink</b>	GSM 850: 869~894MHz PCS 1900: 1930~1990MHz
<b>Release Version</b>	R99
<b>Type of modulation</b>	GMSK for GSM/GPRS; 8PSK for EDGE
<b>Antenna Gain</b>	GSM 850: -1.72dBi PCS1900: -1.16dBi
<b>3G</b>	
<b>Support Band</b>	WCDMA Band II/WCDMA Band IV/WCDMA Band V
<b>Uplink</b>	WCDMA Band II: 1850~1910MHz WCDMA Band IV: 1710~1755MHz WCDMA Band V: 824~849MHz
<b>Downlink</b>	WCDMA Band II: 1930~1990MHz WCDMA Band IV: 2110~2155MHz



	WCDMA Band V: 869~894MHz
<b>Release Version</b>	Rel-6
<b>Type of modulation</b>	QPSK
<b>Antenna Gain</b>	WCDMA Band II: -1.09dBi WCDMA Band IV: -1.09dBi WCDMA Band V: -1.45dBi
<b>Bluetooth</b>	
<b>Bluetooth Frequency</b>	2402~2480MHz
<b>Bluetooth Version</b>	V3.0
<b>Type of modulation</b>	FHSS
<b>Data Rate</b>	1Mbps(GFSK), 2Mbps(Pi/4 DQPSK), 3Mbps (8DPSK)
<b>Antenna Gain</b>	-1.96dBi
<b>Wi-Fi</b>	
<b>Hotspots Function</b>	YES
<b>Wi-Fi Frequency</b>	802.11b/g/n(20MHz): 2412 ~ 2462 MHz 802.11n(40MHz):2422~2452 MHz
<b>Type of modulation</b>	802.11b: DSSS; 802.11g/n: OFDM
<b>Data Rate</b>	802.11b: 1/2/5.5/11 Mbps
	802.11g: 6/9/12/18/24/36/48/54 Mbps
	802.11n: up to 150 Mbps
<b>Antenna Gain</b>	-1.96dBi



### 1.3. Antenna Location

## Rear of EUT

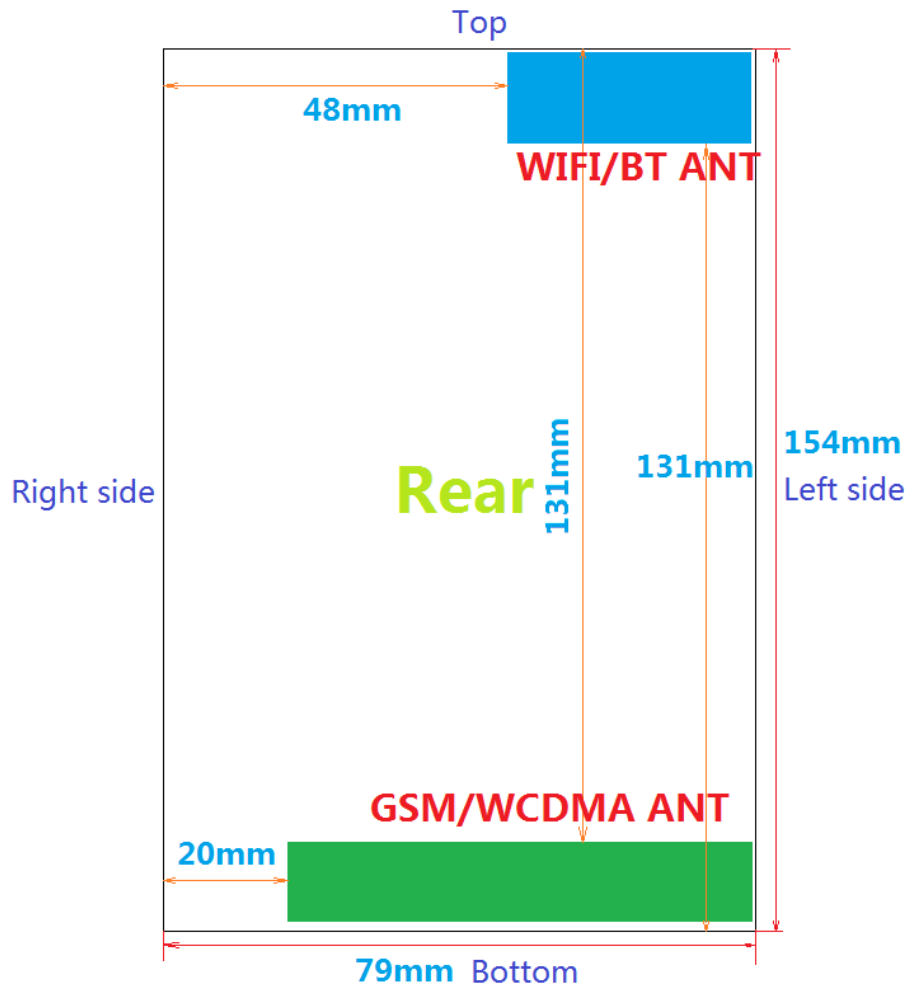

### 1.4. Simultaneous Transmission Configurations

Simultaneous Transmission Scenarios

Mode	Back	Front	Top	Bottom	Right	Left
GPRS850	Yes	Yes	No	Yes	Yes	Yes
GPRS1900	Yes	Yes	No	Yes	Yes	Yes
WCDMA Band II	Yes	Yes	No	Yes	Yes	Yes
WCDMA Band IV	Yes	Yes	No	Yes	Yes	Yes
WCDMA Band V	Yes	Yes	No	Yes	Yes	Yes
2.4GHz WLAN	Yes	Yes	Yes	No	No	Yes



**Simultaneous Transmission Condition**

RF Exposure Condition	Capable Transmit Configurations
Head	1. GSM 850/1900 Voice +BT
	2. WCDMA Band II/IV/V (Voice)+ BT
Body-worn Accessory	1. GSM 850/1900 Voice +BT
	2. WCDMA Band II/IV/V (RMC) + BT
	3. GSM 850/1900(GPRS/EDGE) + BT
	4. WCDMA Band II/IV/V (Voice)+ BT
Wireless Router (Hotspot)	1. GSM 850/1900 (GPRS/EDGE) + WiFi 2.4GHz
	1. WCDMA Band II/IV/V + WiFi 2.4GHz

**Notes:**

1. This device cannot function as a 'wireless hotspot' while performing a voice call;
2. GPRS/EDGE and WCDMA support Hotspot;
3. By reason of their independent modules and antennas, when GSM/GPRS or WCDMA is on, BT function also can be at work;
4. WiFi 2.4GHz Radio cannot transmit simultaneously with Bluetooth Radio;
5. According to FCC KDB Publication 447498 D01v05r02 section5.3, transmitter are considered to be transmitting simultaneously when there is overlapping transmission, with the exception of transmissions during network hand-offs with maximum hand-off duration less than 30 seconds. This device contains multiple transmitters that may operate simultaneously, and therefore requires a simultaneously transmission analysis.





## 1.5. SAR Test Exclusions Applied

### Wi-Fi/Bluetooth

Per FCC KDB 447498 D01v05r02, the SAR exclusion threshold for distances < 50mm is defined by the following equation:

$$\frac{\text{Max Power of Channel}(mW)}{\text{Test Separation Distance}(mm)} \times \sqrt{\text{Frequency}(GHz)} \leq 3.0$$

Based on the maximum conducted power of Bluetooth and the antenna to use separation distance, Bluetooth SAR is not required;

$$[(1.27mW/5) * \sqrt{2.441}] = 0.4 < 3.0, \text{ Bluetooth for Head};$$

$$[(1.27mW/10) * \sqrt{2.441}] = 0.2 < 3.0, \text{ Bluetooth for Body}.$$

IEEE 802.11g/n were not evaluated for SAR since the average output power was not more than 0.25 dB higher than the average output power of IEEE 802.11b.

### Licensed Transmitter(s)

GSM/GPRS/EDGE DTM is not supported for US bands. Therefore, the GSM Voice modes in this report do not transmit simultaneously with GPRS/EDGE Data.

This device is capable of QPSK HSUPA/HSDPA in the uplink. Therefore, no additional SAR tests are required beyond that described for devices with HSUPA/HSDPA in KDB 941225 D01v02.

When the user utilizes multiple services in UMTS 3G mode it uses multi-Radio Access Bearer or multi-RAB.

The power control is based on a physical control channel (Dedicated Physical Control

Channel [DPCCH]) and power control will be adjusted to meet the needs of both services. Therefore, the UMTS+WLAN scenario also represents the UMTS Voice/DATA + WLAN Hotspot scenario.

## 1.6. Power Reduction for SAR

There is no power reduction used for any band/mode implemented in this device for SAR purposes.

## 1.7. Environment Condition

Item	Target	Measured
Ambient Temperature(°C)	18~25	21.5±2
Temperature of Simulant(°C)	20~22	21±2
Relative Humidity(%RH)	30~70	52



### 1.8. Test Standards

1. IEEE Std.1528-2013
2. FCC KDB Publication 447498 D01 General RF Exposure Guidance v05r02
3. FCC KDB Publication 865664 D01 SAR Measurement 100 MHz to 6 GHz v01r03
4. FCC KDB Publication 941225 D01 SAR test for 3G devices v02
5. FCC KDB Publication 941225 D02 HSPA and 1x Advanced v02r02
6. FCC KDB Publication 941225 D03 SAR Test Reduction GSM GPRS EDGE v01
7. FCC KDB Publication 941225 D04 SAR for GSM E GPRS Dual Xfer Mode v01
8. FCC KDB Publication 941225 D06 Hotspot Mode SAR v01r01
9. FCC KDB Publication 648474 D04 Handset SAR v01r02
10. FCC KDB Publication 248227 D01 SAR measurement for 802 11 a b g v01r02

### 1.9. RF Exposure Limits

Human Exposure	Basic restrictions for electric, magnetic and electromagnetic fields. (Unit in mW/ or W/kg)
Spatial Peak SAR <sup>1</sup> (Head and Body)	1.60
Spatial Average SAR <sup>2</sup> (Whole Body)	0.08
Spatial Peak SAR <sup>3</sup> (Arms and Legs)	4.00

**Notes:**

1. The Spatial Peak value of the SAR averaged over any 1gram of tissue (defined as a tissue volume in the shape of a cube) and over the appropriate averaging time.
2. The Spatial Average value of the SAR averaged over the whole body.
3. The Spatial Peak value of the SAR averaged over any 1 grams of tissue (defined as a tissue volume in the shape of a cube) and over appropriate averaging time.



## 2. The SAR Measurement Procedure

### 2.1. System Performance Check

#### 2.1.1 Purpose

1. To verify the simulating liquids are valid for testing.
2. To verify the performance of testing system is valid for testing.

#### 2.1.2 Tissue Dielectric Parameters for Head and Body Phantoms

Target Frequency (MHz)	Head		Body	
	$\epsilon_r$	$\sigma$ (S/m)	$\epsilon_r$	$\sigma$ (S/m)
150	52.3	0.76	61.9	0.80
300	45.3	0.87	58.2	0.92
450	43.5	0.87	56.7	0.94
835	41.5	0.90	55.2	0.97
<b>850</b>	<b>41.5</b>	<b>0.92</b>	<b>55.2</b>	<b>0.99</b>
900	41.5	0.97	55.0	1.05
915	41.5	0.98	55.0	1.06
1450	40.5	1.20	54.0	1.30
1610	40.3	1.29	53.8	1.40
<b>1800 – 2000</b>	<b>40.0</b>	<b>1.40</b>	<b>53.3</b>	<b>1.52</b>
<b>2450</b>	<b>39.2</b>	<b>1.80</b>	<b>52.7</b>	<b>1.95</b>
3000	38.5	2.40	52.0	2.73
5800	35.3	5.27	48.2	6.00

( $\epsilon_r$  = relative permittivity,  $\sigma$  = conductivity and  $\rho = 1000 \text{ kg/m}^3$ )

**2.1.3 Tissue Calibration Result**

- The dielectric parameters of the liquids were verified prior to the SAR evaluation using DASY5 Dielectric Assessment Kit and Agilent Vector Network Analyzer E5071C.

<b>Head Tissue Simulant Measurement</b>				
Frequency [MHz]	Description	Dielectric Parameters		Tissue Temp. [°C]
		$\epsilon_r$	$\sigma$ [s/m]	
850 MHz	Reference result ± 5% window	41.50 39.43 to 43.58	0.92 0.87 to 0.97	N/A
	21-07-2014	41.29	0.90	21.0
1750 MHz	Reference result ± 5% window	40.08 38.076 to 42.084	1.37 1.3015 to 1.4385	N/A
	21-07-2014	39.97	1.37	21.0
1900 MHz	Reference result ± 5% window	40.0 38.00 to 42.00	1.40 1.33 to 1.47	N/A
	21-07-2014	39.57	1.46	21.0
2450MHz	Reference result ± 5% window	39.2 37.24 to 41.16	1.80 22.32 to 27.28	N/A
	21-07-2014	40.19	1.82	21.0

<b>Body Tissue Simulant Measurement</b>				
Frequency [MHz]	Description	Dielectric Parameters		Tissue Temp. [°C]
		$\epsilon_r$	$\sigma$ [s/m]	
850 MHz	Reference result ± 5% window	55.2 52.44 to 57.96	0.99 0.94 to 1.04	N/A
	21-07-2014	55.61	0.97	21.0
1750MHz	Reference result ± 5% window	53.4 50.73 to 56.07	1.49 1.42 to 1.57	N/A
	21-07-2014	53.03	1.48	21.0
1900 MHz	Reference result ± 5% window	53.3 50.64 to 55.97	1.52 1.44 to 1.60	N/A
	21-07-2014	51.08	1.54	21.0
2450MHz	Reference result ± 5% window	52.7 50.07 to 55.34	1.95 1.85 to 2.05	N/A
	21-07-2014	50.84	1.96	21.0



- Refer to KDB 865664 D01 v01r01, The depth of body tissue-equivalent liquid in a phantom must be  $\geq 15.0$  cm with  $\leq \pm 0.5$  cm variation for SAR measurements  $\leq 3$  GHz and  $\geq 10.0$  cm with  $\leq \pm 0.5$  cm variation for measurements  $> 3$  GHz.

#### 2.1.4 System Performance Check Procedure

The DASY5 installation includes predefined files with recommended procedures for measurements and the system performance check. They are read-only document files and destined as fully defined but unmeasured masks, so the finished system performance check must be saved under a different name. The system performance check document requires the SAM Twin Phantom or ELI4 Phantom, so the phantom must be properly installed in your system. (User defined measurement procedures can be created by opening a new document or editing an existing document file). Before you start the system performance check, you need only to tell the system with which components (probe, medium, and device) you are performing the system performance check; the system will take care of all parameters.

- **The Power Reference Measurement and Power Drift Measurement** jobs are located at the beginning and end of the batch process. They measure the field drift at one single point in the liquid over the complete procedure. The indicated drift is mainly the variation of the Dipole output power. If it is too high (above  $\pm 0.2$  dB), the system performance check should be repeated;
- **The Surface Check** job tests the optical surface detection system of the DASY5 system by repeatedly detecting the surface with the optical and mechanical surface detector and comparing the results. The output gives the detecting heights of both systems, the difference between the two systems and the standard deviation of the detection repeatability. Air bubbles or refraction in the liquid due to separation of the sugar-water mixture gives poor repeatability (above  $\pm 0.1$  mm). In that case it is better to abort the system performance check and stir the liquid;
- **The Area Scan** job measures the SAR above the dipole on a plane parallel to the surface. It is used to locate the approximate location of the peak SAR. The proposed scan uses large grid spacing for faster measurement; due to the symmetric field, the peak detection is reliable;
- **The Zoom Scan** job measures the field in a volume around the peak SAR value assessed in the previous Area Scan job (for more information see the application note on SAR evaluation). If the system performance check gives reasonable results. The dipole input power (forward power) was 250mW, 1 g and 10 g spatial average SAR values normalized to 1W dipole input power give reference data for comparisons and it's equal to  $10 \times$  (dipole forward power). The next sections analyze the expected uncertainties of these values, as well as additional checks for further information or troubleshooting.



### 2.1.5 System Performance Check Setup

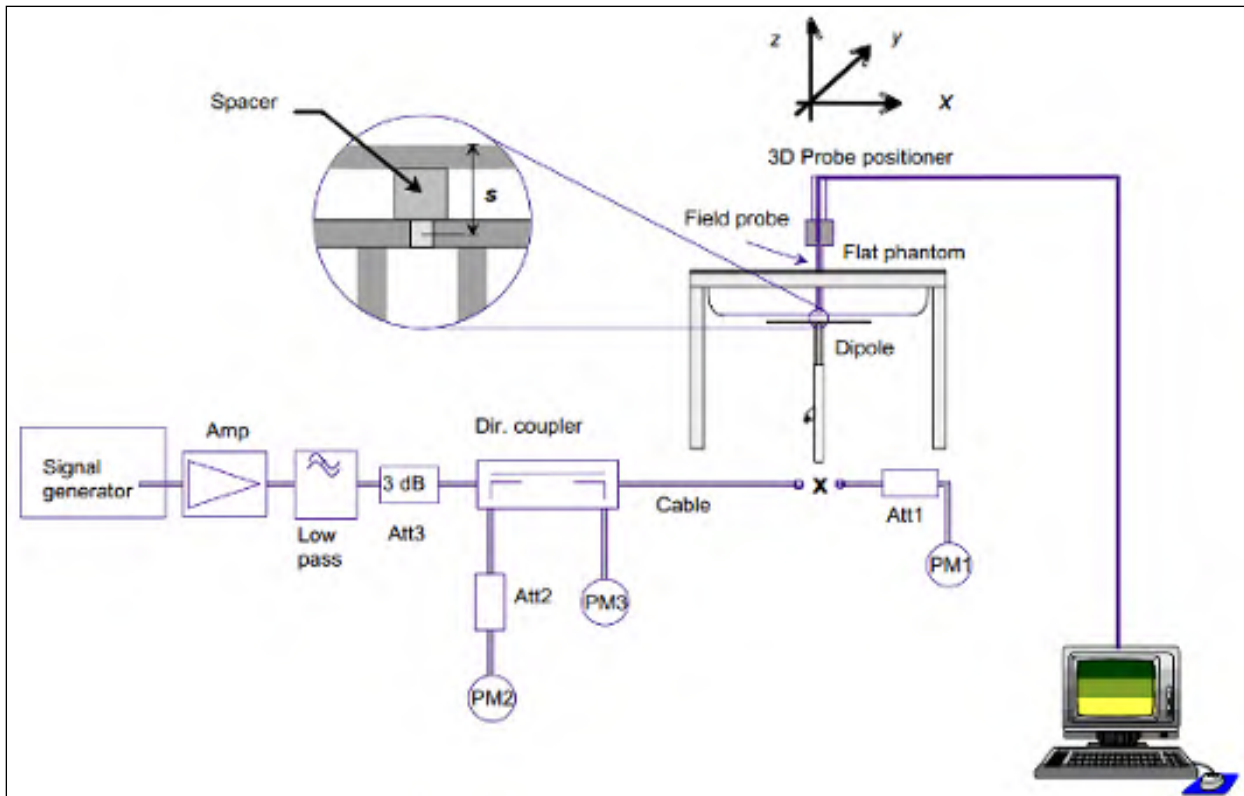

### 2.1.6 Validation Dipoles

The dipoles use is based on the IEEE Std.1528-2013 and FCC KDB 865664 D01 SAR Measurement 100 MHz to 6 GHz v01r03standard, and is complied with mechanical and electrical specifications in line with the requirements of both EN62209-1 and EN62209-2. The table below provides details for the mechanical and electrical specifications for the dipoles.

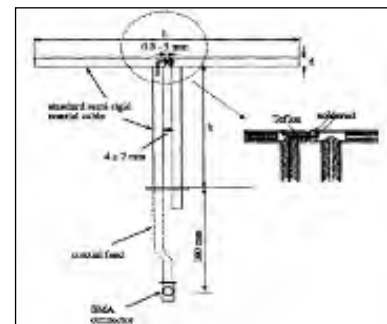

Frequency	L (mm)	h (mm)	d (mm)
850MHz	158	88	3.6
1750MHz	75.2	42.5	3.6
1900MHz	68.0	39.5	3.6
2450MHz	53.5	30.4	3.6



## 2.1.7 Result of System Performance Check: Valid Result

System Performance Check at 850MHz, 1700MHz, 1900MHz and 2450MHz for Head.				
Validation Kit: D850V2-SN: 1008				
Frequency [MHz]	Description	SAR [w/kg] 1g	SAR [w/kg] 10g	Tissue Temp. [°C]
850 MHz	Reference result ± 10% window	9.83 8.85 to 10.81	6.37 5.73 to 7.01	N/A
	21-07-2014	9.76	6.40	21.0
Validation Kit: D1750V2-SN: 1097				
Frequency [MHz]	Description	SAR [w/kg] 1g	SAR [w/kg] 10g	Tissue Temp. [°C]
1750 MHz	Reference result ± 10% window	36.9 33.21 to 40.59	19.6 17.64 to 21.56	N/A
	21-07-2014	35.88	19.56	21.0
Validation Kit: D1900V2-SN: 5d174				
Frequency [MHz]	Description	SAR [w/kg] 1g	SAR [w/kg] 10g	Tissue Temp. [°C]
1900 MHz	Reference result ± 10% window	39.9 35.91 to 43.89	20.9 18.81 to 22.99	N/A
	21-07-2014	40.40	20.52	21.0
Validation Kit: D2450V2-SN: 914				
Frequency [MHz]	Description	SAR [w/kg] 1g	SAR [w/kg] 10g	Tissue Temp. [°C]
2450 MHz	Reference result ± 10% window	53.4 48.06 to 58.74	24.8 22.32 to 27.28	N/A
	21-07-2014	52.40	23.88	21.0
Note: All SAR values are normalized to 1W forward power.				

**System Performance Check at 850MHz, 1700MHz, 1900MHz and 2450MHz for Body.****Validation Kit: D850V2-SN: 1008**

Frequency [MHz]	Description	SAR [w/kg] 1g	SAR [w/kg] 10g	Tissue Temp. [°C]
850 MHz	Reference result ± 10% window	9.62 8.66 to 10.58	6.27 5.64 to 6.90	N/A
	21-07-2014	10.08	6.44	21.0

**Validation Kit: D1750V2-SN: 1097**

Frequency [MHz]	Description	SAR [w/kg] 1g	SAR [w/kg] 10g	Tissue Temp. [°C]
1750 MHz	Reference result ± 10% window	37.2 33.48 to 40.92	20.1 18.09 to 22.11	N/A
	21-07-2014	37.4	19.56	21.0

**Validation Kit: D1900V2-SN: 5d174**

Frequency [MHz]	Description	SAR [w/kg] 1g	SAR [w/kg] 10g	Tissue Temp. [°C]
1900 MHz	Reference result ± 10% window	40.4 36.36 to 44.44	21.5 19.35 to 23.65	N/A
	21-07-2014	39.36	20.44	21.0

**Validation Kit: D2450V2-SN: 914**

Frequency [MHz]	Description	SAR [w/kg] 1g	SAR [w/kg] 10g	Tissue Temp. [°C]
2450 MHz	Reference result ± 10% window	51.5 46.35 to 56.65	23.9 21.51 to 26.29	N/A
	21-07-2014	50.80	23.16	21.0

Note: All SAR values are normalized to 1W forward power.





## 2.2. Test Requirements

### 2.2.1 Test Procedures

#### Step 1 Setup a Connection

First, engineer should record the conducted power before the test. Then establish a call in handset at the maximum power level with a base station simulator via air interface, or make the EUT estimate by itself in testing band. Place the EUT to the specific test location. After the testing, must export SAR test data by SEMCAD. Then writing down the conducted power of the EUT into the report, also the SAR values tested.

#### Step 2 Power Reference Measurements

To measure the local E-field value at a fixed location which value will be taken as a reference value for calculating a possible power drift.

#### Step 3 Area Scan

The Area Scan is used as a fast scan in two dimensions to find the area of high field values, before doing a fine measurement around the hot spot. The sophisticated interpolation routines implemented in DASY software can find the maximum locations even in relatively coarse grids. When an Area Scan has measured all reachable points, it computes the field maximal found in the scanned area, within a range of the global maximum. The range (in dB) is specified in the standards for compliance testing. For example, a 2 dB range is required in IEEE Standard 1528 and IEC 62209 standards, whereby 3 dB is a requirement when compliance is assessed in accordance with the ARIB standard (Japan). If only one Zoom Scan follows the Area Scan, then only the absolute maximum will be taken as reference. For cases where multiple maximums are detected, the number of Zoom Scans has to be increased accordingly.

**Area Scan Parameters extracted from KDB 865664 D01v01r01**

	≤ 3 GHz	> 3 GHz
Maximum distance from closest measurement point (geometric center of probe sensors) to phantom surface	5 ± 1 mm	$\frac{1}{2} \cdot \delta \cdot \ln(2) \pm 0.5$ mm
Maximum probe angle from probe axis to phantom surface normal at the measurement location	30° ± 1°	20° ± 1°
Maximum area scan spatial resolution: $\Delta x_{Area}$ , $\Delta y_{Area}$	≤ 2 GHz: ≤ 15 mm 2 – 3 GHz: ≤ 12 mm	3 – 4 GHz: ≤ 12 mm 4 – 6 GHz: ≤ 10 mm
	When the x or y dimension of the test device, in the measurement plane orientation, is smaller than the above, the measurement resolution must be ≤ the corresponding x or y dimension of the test device with at least one measurement point on the test device.	

**Step 4 Zoom Scan**

Zoom Scans are used to assess the peak spatial SAR values within a cubic averaging volume containing 1 g and 10 g of simulated tissue. The Zoom Scan measures points (refer to table below) within a cube whose base faces are centered on the maxima found in a preceding area scan job within the same procedure. When the measurement is done, the Zoom Scan evaluates the averaged SAR for 1 g and 10 g and displays these values next to the job's label.

**Zoom Scan Parameters extracted from KDB 865664 D01 v01r01**

		≤ 3 GHz	> 3 GHz
Maximum zoom scan spatial resolution: $\Delta x_{Zoom}$ , $\Delta y_{Zoom}$		$\leq 2$ GHz: $\leq 8$ mm 2 – 3 GHz: $\leq 5$ mm*	3 – 4 GHz: $\leq 5$ mm* 4 – 6 GHz: $\leq 4$ mm*
Maximum zoom scan spatial resolution, normal to phantom surface	uniform grid: $\Delta z_{Zoom}(n)$	$\leq 5$ mm	3 – 4 GHz: $\leq 4$ mm 4 – 5 GHz: $\leq 3$ mm 5 – 6 GHz: $\leq 2$ mm
	graded grid	$\Delta z_{Zoom}(1)$ : between 1 <sup>st</sup> two points closest to phantom surface	$\leq 4$ mm  3 – 4 GHz: $\leq 3$ mm 4 – 5 GHz: $\leq 2.5$ mm 5 – 6 GHz: $\leq 2$ mm
		$\Delta z_{Zoom}(n>1)$ : between subsequent points	$\leq 1.5 \cdot \Delta z_{Zoom}(n-1)$
Minimum zoom scan volume	x, y, z	$\geq 30$ mm	3 – 4 GHz: $\geq 28$ mm 4 – 5 GHz: $\geq 25$ mm 5 – 6 GHz: $\geq 22$ mm
Note: $\delta$ is the penetration depth of a plane-wave at normal incidence to the tissue medium; see draft standard IEEE P1528-2011 for details. * When zoom scan is required and the <i>reported</i> SAR from the <i>area scan based 1-g SAR estimation</i> procedures of KDB 447498 is $\leq 1.4$ W/kg, $\leq 8$ mm, $\leq 7$ mm and $\leq 5$ mm zoom scan resolution may be applied, respectively, for 2 GHz to 3 GHz, 3 GHz to 4 GHz and 4 GHz to 6 GHz.			

**Step 5 Power Drift Measurements**

Repetition of the E-field measurement at the fixed location mentioned in Step 1 to make sure the two results differ by less than  $\pm 0.2$  dB.

**2.2.2 Standards of Mobile Phone SAR testing**

According to IEEE std.1528-2013, head SAR testing of the mobile phone is a matter of course. Also, per FCC KDB 941225 D06 Hotspot Mode SAR v01r01, when the overall device length and width are  $\geq 9$  cm x 5 cm respectively, a test separation of 10 mm is required. SAR must be measured for all sides (edges) and surfaces with a transmitting antenna located at  $\leq 25$  mm from that surface or edge, for the data modes, wireless technologies and frequency bands supporting hotspot mode.



2.2.3 Test Channel Choosing

1. Per FCC KDB 941225 D03 SAR Test Reduction GSM GPRS EDGE v01, when the 1-g SAR is  $\leq 0.8$  W/kg, testing for low and high channel is optional.
2. Per FCC KDB 941225 D01 SAR test for 3G devices v02, body SAR is not required for handsets with HSUPA/HSDPA capabilities when the maximum average output of each RF channel with HSDPA active is less than ¼ dB higher than that measured without HSUPA/HSDPA using 12.2 kbps RMC and the maximum SAR for 12.2 kbps RMC is  $\leq 75\%$  of the SAR limit.

Here are HSDPA/HSUPA sub-test setups as show blow, per FCC KDB 941225 D01 v02.

Sub-Test 1 Setup for Release 5 HSDPA

Sub-test	$\beta_c$	$\beta_d$	$\beta_d$ (SF)	$\beta_c/\beta_d$	$\beta_{hs}^{(1)}$	CM (dB) <sup>(2)</sup>
1	2/15	15/15	64	2/15	4/15	0.0
2	12/15 <sup>(3)</sup>	15/15 <sup>(3)</sup>	64	12/15 <sup>(3)</sup>	24/15	1.0
3	15/15	8/15	64	15/8	30/15	1.5
4	15/15	4/15	64	15/4	30/15	1.5

Note 1:  $\Delta_{ACK}, \Delta_{NACK}$  and  $\Delta_{CQI} = 8 \Leftrightarrow A_{hs} = \beta_{hs}/\beta_c = 30/15 \Leftrightarrow \beta_{hs} = 30/15 * \beta_c$   
 Note 2: CM = 1 for  $\beta_c/\beta_d = 12/15, \beta_{hs}/\beta_c = 24/15$ .  
 Note 3: For subtest 2 the  $\beta_c/\beta_d$  ratio of 12/15 for the TFC during the measurement period (TF1, TF0) is achieved by setting the signaled gain factors for the reference TFC (TF1, TF1) to  $\beta_c = 11/15$  and  $\beta_d = 15/15$ .

Sub-test	$\beta_c$	$\beta_d$	$\beta_d$ (SF)	$\beta_c/\beta_d$	$\beta_{hs}^{(1)}$	$\beta_{ec}$	$\beta_{ed}$	$\beta_{ec}$ (SF)	$\beta_{ed}$ (codes)	CM <sup>(2)</sup> (dB)	MPR (dB)	AG <sup>(4)</sup> Index	E-TFCI
1	11/15 <sup>(3)</sup>	15/15 <sup>(3)</sup>	64	11/15 <sup>(3)</sup>	22/15	209/225	1039/225	4	1	1.0	0.0	30	75
2	6/15	15/15	64	6/15	12/15	12/15	94/75	4	1	3.0	2.0	12	67
3	15/15	9/15	64	15/9	30/15	30/15	$\beta_{ec} = 47/15$ $\beta_{ed} = 47/15$	4	2	2.0	1.0	15	92
4	2/15	15/15	64	2/15	4/15	2/15	56/75	4	1	3.0	2.0	17	71
5	15/15 <sup>(4)</sup>	15/15 <sup>(4)</sup>	64	15/15 <sup>(4)</sup>	30/15	24/15	134/15	4	1	1.0	0.0	21	81

Note 1:  $\Delta_{ACK}, \Delta_{NACK}$  and  $\Delta_{CQI} = 8 \Leftrightarrow A_{hs} = \beta_{hs}/\beta_c = 30/15 \Leftrightarrow \beta_{hs} = 30/15 * \beta_c$   
 Note 2: CM = 1 for  $\beta_c/\beta_d = 12/15, \beta_{hs}/\beta_c = 24/15$ . For all other combinations of DPDCH, DPCCCH, HS-DPCCCH, E-DPDCH and E-DPCCCH the MPR is based on the relative CM difference.  
 Note 3: For subtest 1 the  $\beta_c/\beta_d$  ratio of 11/15 for the TFC during the measurement period (TF1, TF0) is achieved by setting the signaled gain factors for the reference TFC (TF1, TF1) to  $\beta_c = 10/15$  and  $\beta_d = 15/15$ .  
 Note 4: For subtest 5 the  $\beta_c/\beta_d$  ratio of 15/15 for the TFC during the measurement period (TF1, TF0) is achieved by setting the signaled gain factors for the reference TFC (TF1, TF1) to  $\beta_c = 14/15$  and  $\beta_d = 15/15$ .  
 Note 5: Testing UE using E-DPDCH Physical Layer category 1 Sub-test 3 is not required according to TS 25.306 Table 5.1g.  
 Note 6:  $\beta_{ed}$  can not be set directly; it is set by Absolute Grant Value.



3. 1) Per KDB 248227 D01v01r02, SAR is not required for 802.11g/HT20 channels when the maximum average output power is less than 1/4 dB higher than that measured on the corresponding 802.11b channels.
- 2) SAR is not required for Channels 12 and 13, if the tune-up limit and the measured output power for these two channels are no greater than those for the default test channels.

Mode	GHz	Channel	Turbo Channel	"Default Test Channels"			
				§15.247		UNII	
				802.11b	802.11g		
802.11 b/g	2.412	1 <sup>*</sup>		√	∇		
	2.437	6	6	√	∇		
	2.462	11 <sup>*</sup>		√	∇		

- √ = "default test channels"
- \* = possible 802.11a channels with maximum average output > the "default test channels"
- ∇ = possible 802.11g channels with maximum average output ¼ dB ≥ the "default test channels"
- <sup>‡</sup> = when output power is reduced for channel 1 and/or 11 to meet restricted band requirements the highest output channels closest to each of these channels should be tested





### 3. DASY5 Measurement System

#### DASY5 Measurement System

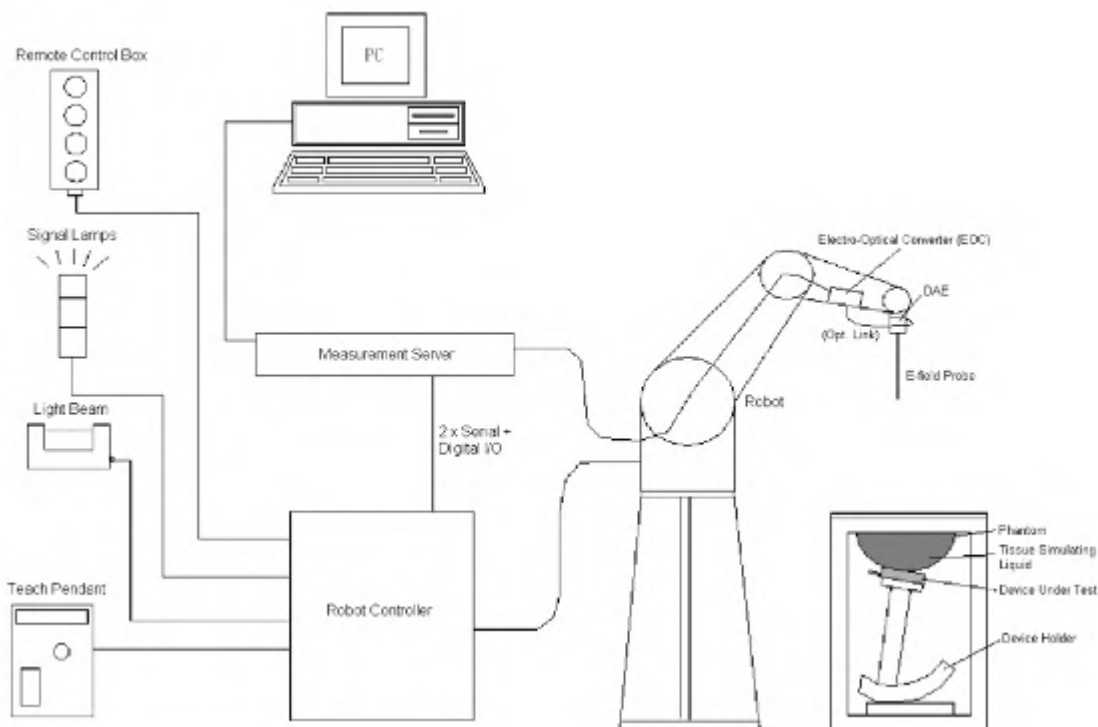

**Figure 2.1 SPEAG DASY5 System Configurations**

The DASY5 system for performance compliance tests is illustrated above graphically. This system consists of the following items:

- A standard high precision 6-axis robot with controller, a teach pendant and software
- A data acquisition electronic(DAE)attached to the robot arm extension
- A dosimetric probe equipped with an optical surface detector system
- The electro-optical converter(ECO)performs the conversion between optical and electrical signals
- A measurement server performs the time critical tasks such as signal filtering, control of the robot operation and fast movement interrupts.
- A probe alignment unit which improves the accuracy of the probe positioning
- A computer operating Windows 7
- DASY5 software
- Remove control with teach pendant additional circuitry for robot safety such as warning lamps, etc.
- The SAM twin phantom
- A device holder
- Tissue simulating liquid
- Dipole for evaluating the proper functioning of the system



### 3.1. Uncertainty of Inter-/Extrapolation and Averaging

In order to evaluate the uncertainty of the interpolation, extrapolation and averaged SAR calculation algorithms of the Postprocessor, DASY5 allows the generation of measurement grids which are artificially predefined by analytically based test functions. Therefore, the grids of area scans and zoom scans can be filled with uncertainty test data, according to the SAR benchmark functions of IEEE 1528. The three analytical functions shown in equations as below are used to describe the possible range of the expected SAR distributions for the tested handsets. The field gradients are covered by the spatially flat distribution f1, the spatially steep distribution f3 and f2 accounts for H-field cancellation on the phantom/tissue surface.

$$f_1(x, y, z) = Ae^{-\frac{z}{2a}} \cos^2 \left( \frac{\pi \sqrt{x'^2 + y'^2}}{2 \cdot 5a} \right)$$

$$f_2(x, y, z) = Ae^{-\frac{z}{a}} \frac{a^2}{a^2 + x'^2} \left( 3 - e^{-\frac{2z}{a}} \right) \cos^2 \left( \frac{\pi y'}{2 \cdot 3a} \right)$$

$$f_3(x, y, z) = A \frac{a^2}{\frac{a^2}{4} + x'^2 + y'^2} \left( e^{-\frac{2z}{a}} + \frac{a^2}{2(a + 2z)^2} \right)$$

### 3.2. DASY5 E-Field Probe

The SAR measurement is conducted with the dosimetric probe manufactured by SPEAG. The probe is specially designed and calibrated for use in liquid with high permittivity. The dosimetric probe has special calibration in liquid at different frequency.

SPEAG conducts the probe calibration in compliance with international and national standards (e.g. IEEE 1528, EN 62209-1, IEC 62209, etc.) under ISO 17025. The calibration data are in Appendix D.

Model	EX3DV4	
<b>Construction</b>	Symmetrical design with triangular core Built-in shielding against static charges PEEK enclosure material (resistant to organic solvents, e.g., DGBE)	
<b>Frequency</b>	10 MHz to 6 GHz Linearity: ± 0.2 dB (30 MHz to 6 GHz)	
<b>Directivity</b>	± 0.3 dB in HSL (rotation around probe axis) ± 0.5 dB in tissue material (rotation normal to probe axis)	
<b>Dynamic Range</b>	10 µW/g to 100 mW/g Linearity: ± 0.2 dB (noise: typically < 1 µW/g)	
<b>Dimensions</b>	Overall length: 330 mm (Tip: 20 mm) Tip diameter: 2.5 mm (Body: 12 mm) Typical distance from probe tip to dipole centers: 1 mm	
<b>Application</b>	High precision dosimetric measurements in any exposure scenario (e.g., very strong gradient fields). Only probe which enables compliance testing for frequencies up to 6 GHz with precision of better 30%.	



### 3.3. Data Acquisition Electronics (DAE)

The data acquisition electronics (DAE) consists of a highly sensitive electrometer-grade preamplifier with auto-zeroing, a channel and gain-switching multiplexer, a fast 16 bit AD-converter and a command decoder and control logic unit.

Transmission to the measurement server is accomplished through an optical downlink for data and status information as well as an optical uplink for commands and the clock.

The input impedance of the DAE4 is 200M Ohm; the inputs are symmetrical and floating. Common mode rejection is above 80dB.

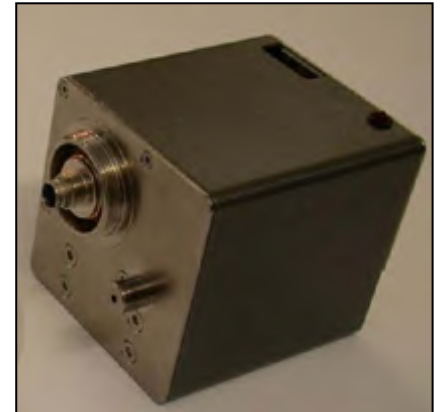

### 3.4. Robot

The DASY5 system uses the high precision robots TX90 XL type out of the newer series from Stäubli SA (France). For the 6-axis controller DASY5 system, the CS8C robot controller version from Stäubli is used.

The XL robot series have many features that are important for our application:

- High precision (repeatability 0.02 mm)
- High reliability (industrial design)
- Jerk-free straight movements
- Low ELF interference (the closed metallic construction shields against motor control fields)
- 6-axis controller



### 3.5. Light Beam Unit

The light beam switch allows automatic "tooling" of the probe. During the process, the actual position of the probe tip with respect to the robot arm is measured, as well as the probe length and the horizontal probe offset. The software then corrects all movements, such that the robot coordinates are valid for the probe tip.

The repeatability of this process is better than 0.1 mm. If a position has been taught with an aligned probe, the same position will be reached with another aligned probe within 0.1 mm, even if the other probe has different dimensions. During probe rotations, the probe tip will keep its actual position.





### 3.6. Measurement Server

The DASY5 measurement server is based on a PC/104 CPU board with a 400MHz intel ULV Celeron, 128MB chipdisk and 128MB RAM. The necessary circuits for communication with the DAE electronics box, as well as the 16 bit AD converter system for optical detection and digital I/O interface are contained on the DASY5 I/O board, which is directly connected to the PC/104 bus of the CPU board.



### 3.7. SAM Phantom

The SAM twin phantom is a fiberglass shell phantom with 2mm shell thickness (except the ear region where shell thickness increases to 6mm). It has three measurement areas:

- Left head
- Right head
- Flat phantom



The ELI4 Phantom also is a fiberglass shell phantom with 2mm shell thickness. It has 30 liters filling volume, and with a dimension of 600mm for major ellipse axis , 400mm for minor axis. It is intended for compliance testing of handheld and body-mounted wireless devices in frequency range of 30 MHz to 6GHz. ELI4 is fully compatible with standard and all known tissue simulating liquids.

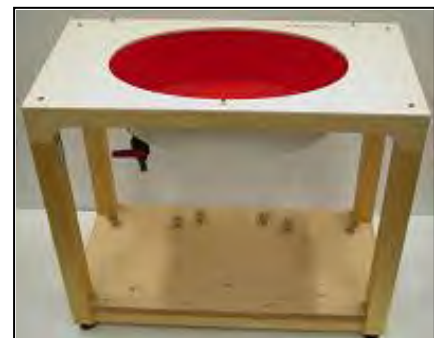

The bottom plate contains three pair of bolts for locking the device holder. The device holder positions are adjusted to the standard measurement positions in the three sections. A white cover is provided to tap the phantom during off-periods to prevent water evaporation and changes in the liquid parameters. On the phantom top, three reference markers are provided to identify the phantom position with respect to the robot.





### 3.8. Device Holder

The DASY5 device holder is designed to cope with different positions given in the standard. It has two scales for the device rotation (with respect to the body axis) and the device inclination (with respect to the line between the ear reference points). The rotation center for both scales is the ear reference point (EPR). Thus the device needs no repositioning when changing the angles. The DASY5 device holder has been made out of low-loss POM material having the following dielectric parameters: relative permittivity  $\epsilon_r = 3$  and loss tangent  $\delta = 0.02$ . The amount of dielectric material has been reduced in the closest vicinity of the device, since measurements have suggested that the influence of the clamp on the test results could thus be lowered.

The laptop extension is lightweight and made of POM, acrylic glass and foam. It fits easily on upper part of the mounting device in place of the phone positioned. The extension is fully compatible with the SAM Twin and ELI phantoms.

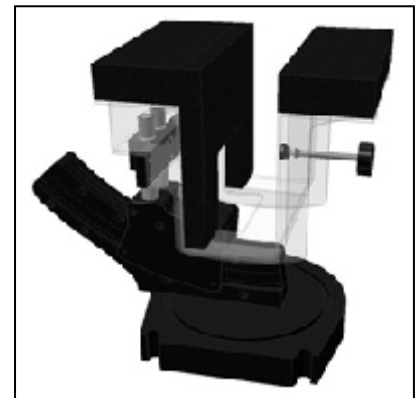



### 3.9. Test Equipment List

Instrument	Manufacturer	Model No.	Serial No.	Cali. Due Date
Stäubli Robot TX60L	Stäubli	TX60L	5P6VA1/A/01	only once
Robot Controller	Stäubli	CS8C	5P6VA1/C/01	only once
Dipole Validation Kits	Speag	D850V2	1008	2015.06.12
Dipole Validation Kits	Speag	D1750V2	1097	2015.06.10
Dipole Validation Kits	Speag	D1900V2	5d174	2015.06.09
Dipole Validation Kits	Speag	D2450V2	914	2015.06.06
SAM Twin Phantom	Speag	SAM	1767	N/A
SAM ELI Phantom	Speag	SAM	1211	N/A
Device Holder	Speag	SD 000 H01 KA	N/A	N/A
Laptop Holder	Speag	SM LH1 001CD	N/A	N/A
Data Acquisition Electronic	Speag	DAE4	1379	2015.05.23
E-Field Probe	Speag	EX3DV4	3927	2015.05.19
SAR Software	Speag	DASY5	V5.2 Build 162	N/A
Power Amplifier	Mini-Circuit	ZVA-183W-S+	MN136701248	N/A
Directional Coupler	Agilent	772D	MY52180104	N/A
Directional Coupler	Agilent	778D	MY52180185	N/A
Universal Radio Communication Tester	R&S	CMU 200	108823	2015.01.08
Vector Network	Agilent	E5071C	MY4631693	2015.01.15
Signal Generator	R&S	SML	103287	2015.03.09
Power Meter	BONN	BLWA0830-160/100/40D	76659	2015.11.10
AUG Power Sensor	R&S	NRP-Z91	100384	2015.03.09



### 3.10. Annul Internal Check of Impedance and Return Loss

Plot for D850V2, serial No. 1008

850MHz Head calibrated impedance 52.23Ω; measured impedance: 53.110Ω (within 5Ω)

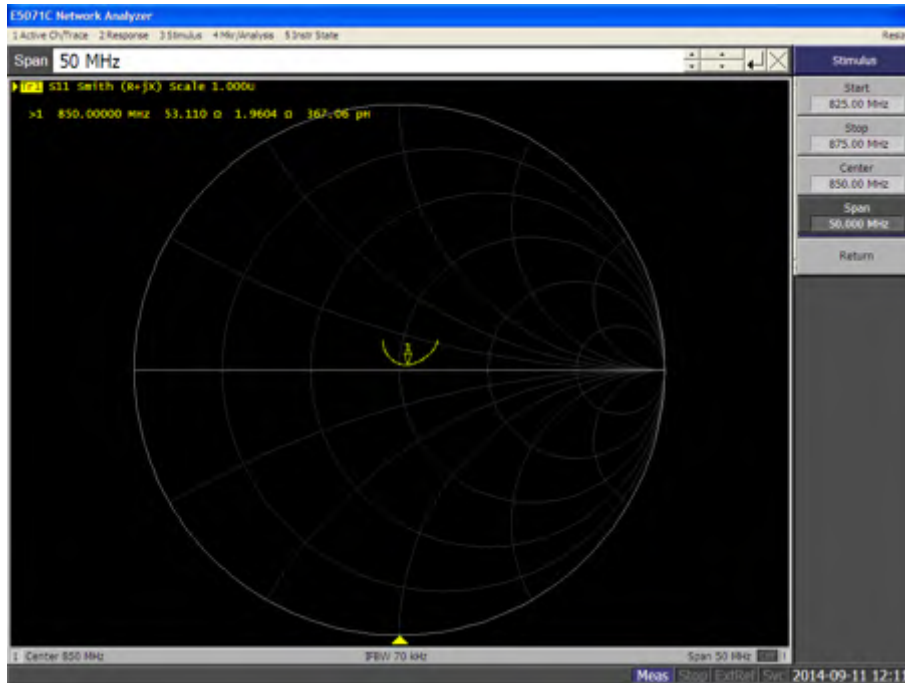

850MHz Head calibrated return loss: -28.56 dB; Measured impedance: 26.408dB (within 20%)

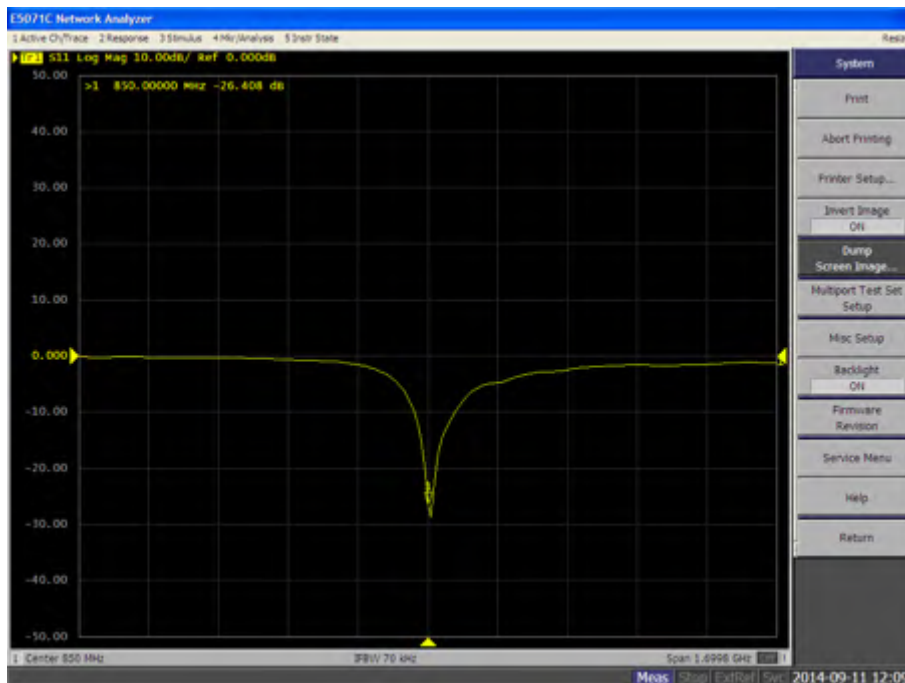



850MHz Body calibrated impedance 47.514Ω; measured impedance: 46.964Ω (within 5Ω)

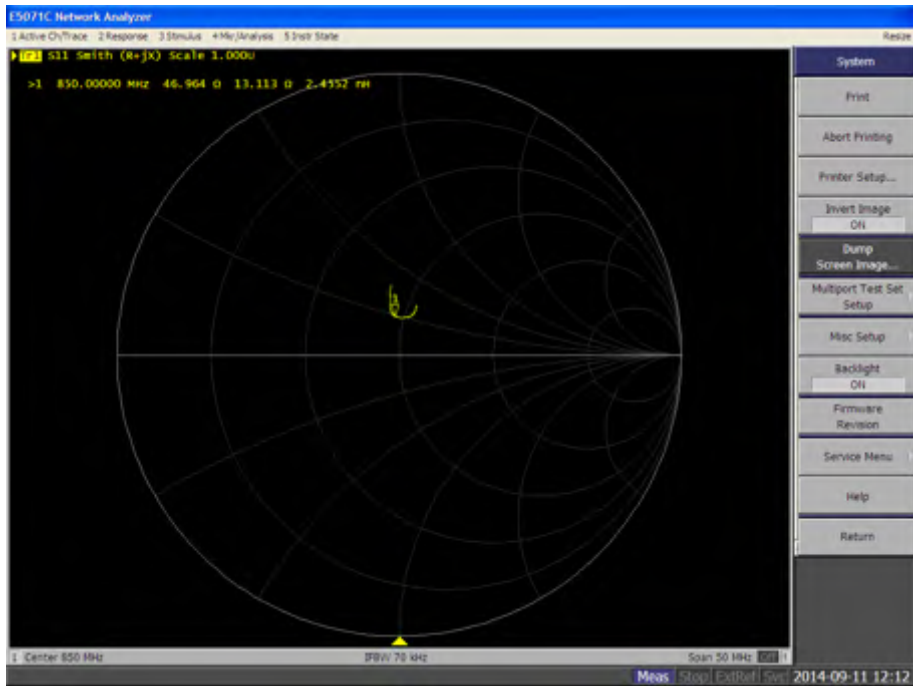

850MHz Body calibrated return loss: -24.393 dB; Measured impedance: 23.534dB (within 20%)

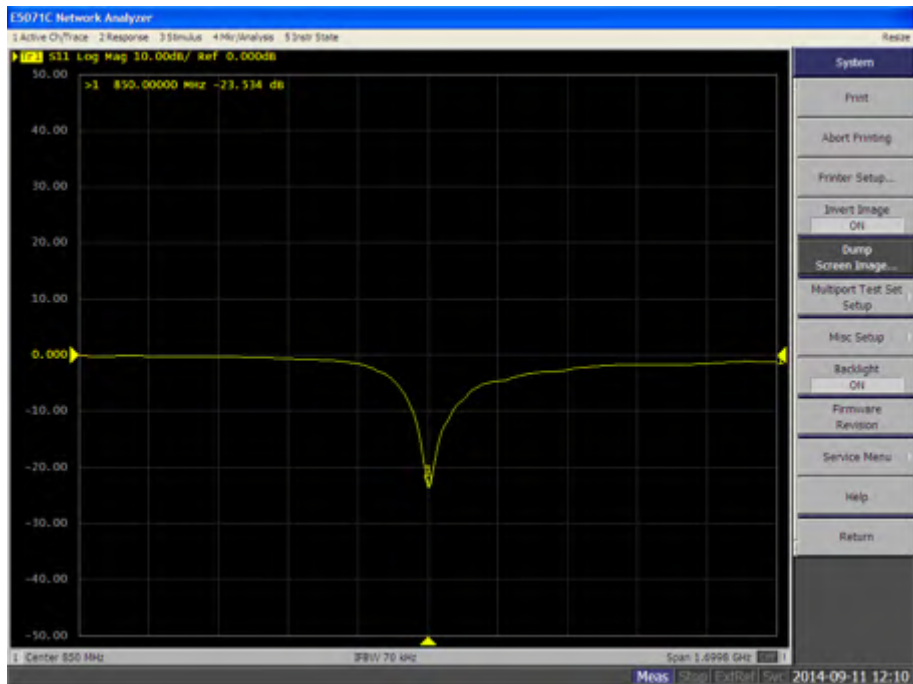



Plot for D1750V2, serial No.1097

1750MHz Head calibrated impedance 51.021Ω; measured impedance: 52.149Ω (within 5Ω)

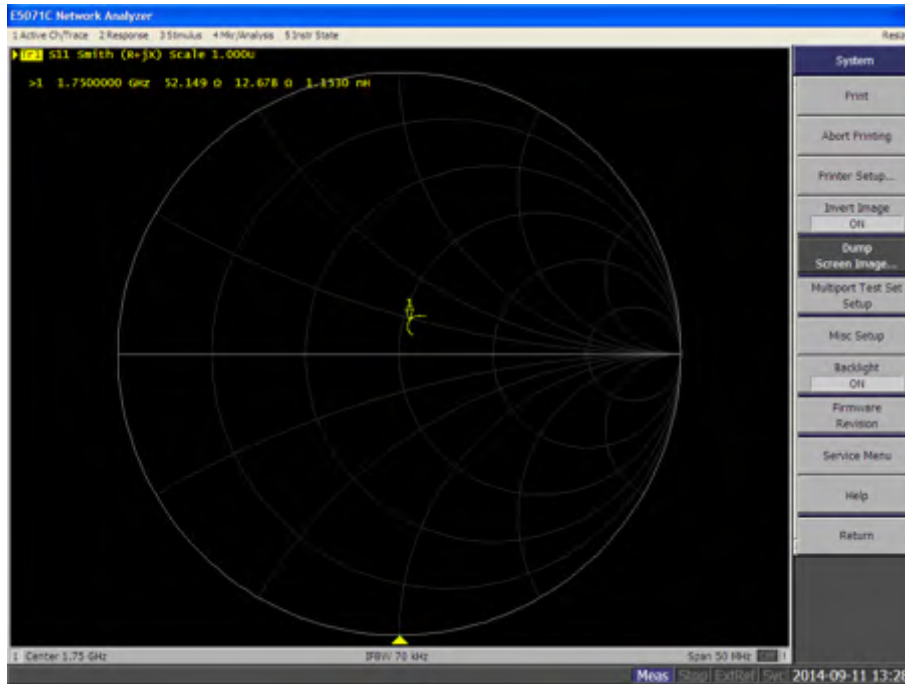

1750MHz Head calibrated return loss: -38.783 dB; Measured impedance: -38.677dB (within 20%)

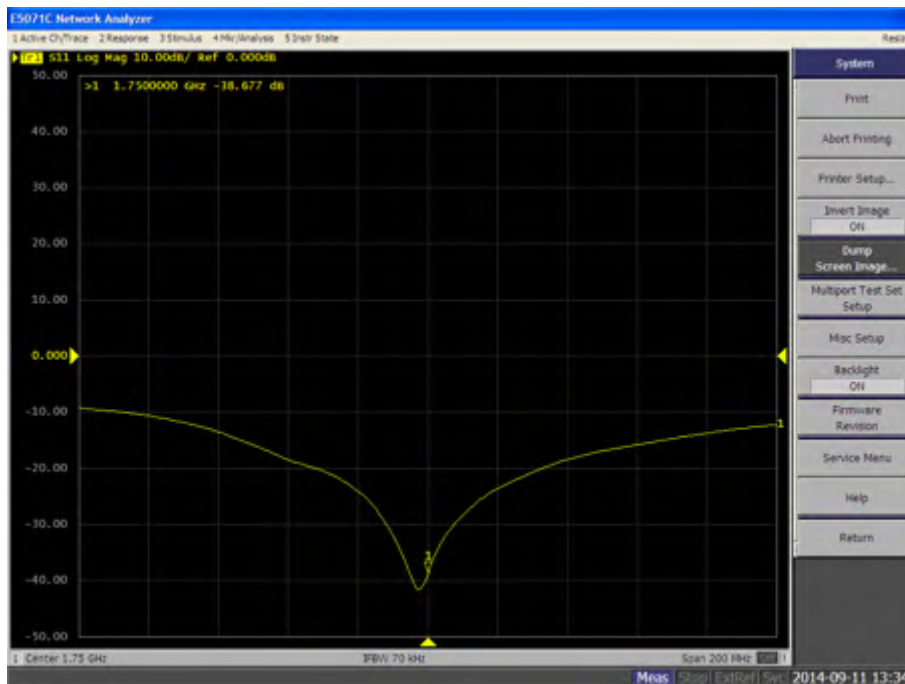



1750MHz Body calibrated impedance 46.645Ω; measured impedance: 45.798Ω (within 5Ω)

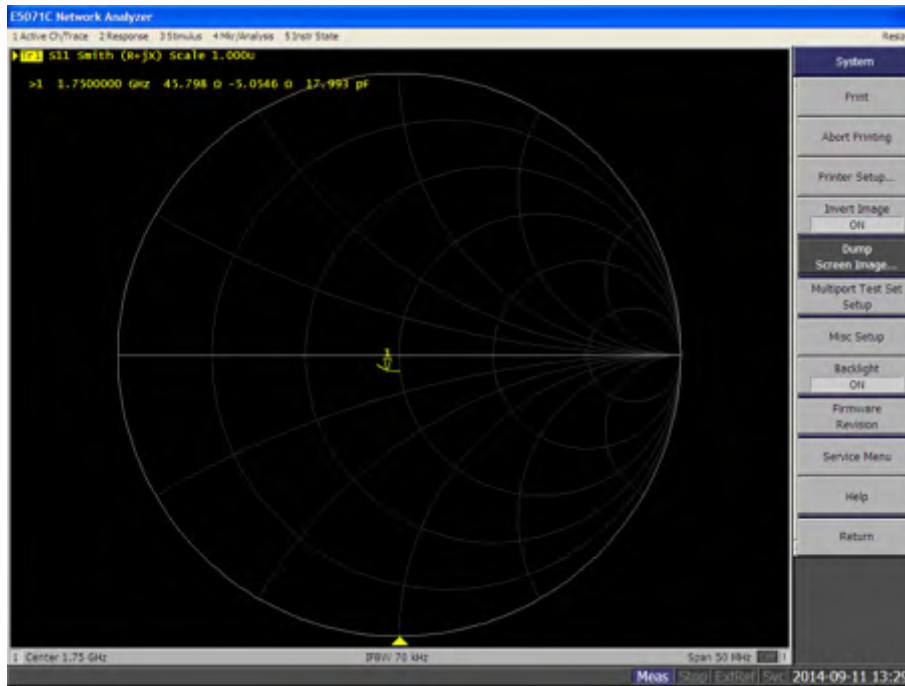

1750MHz Body calibrated return loss: -29.177 dB; Measured impedance: -28.425dB (within 20%)

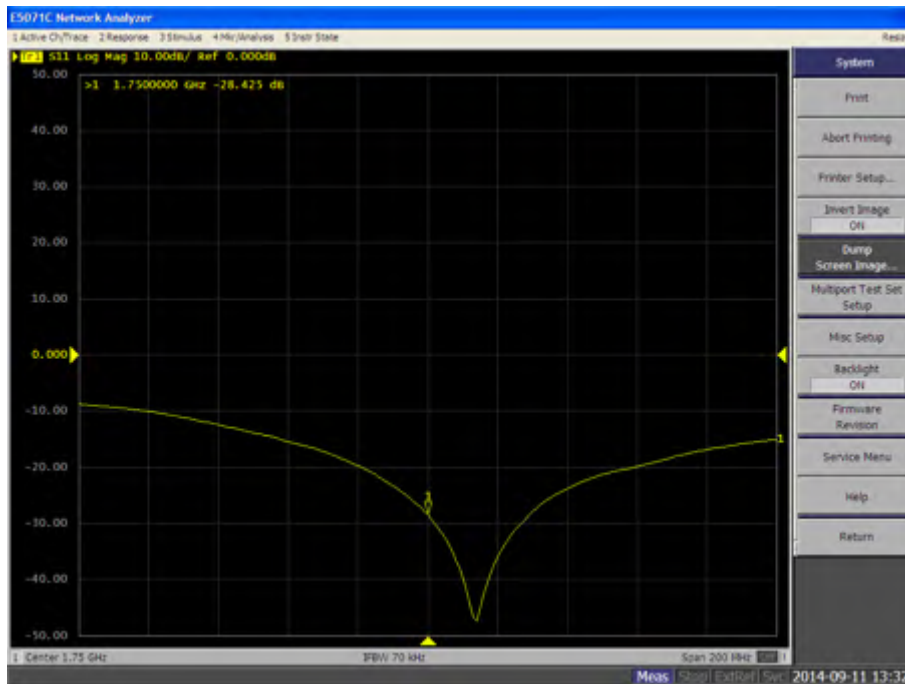



Plot for D1900V2, serial No. 5d174

1900MHz Head calibrated impedance 51.623Ω; measured impedance: 51.610Ω (within 5Ω)

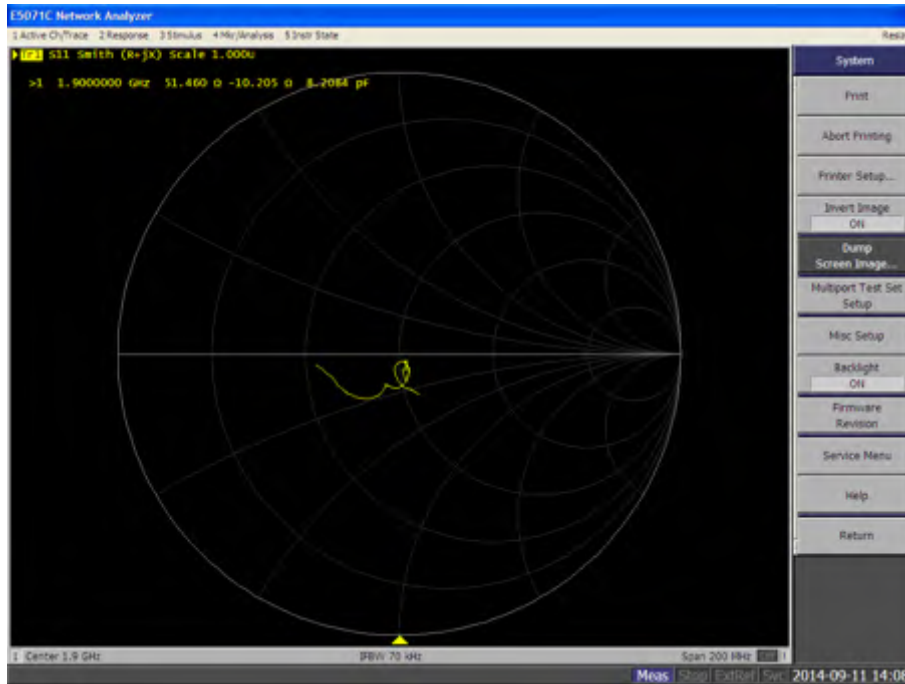

1900MHz Head calibrated return loss: -22.812dB; Measured impedance: -23.464dB (within 20%)

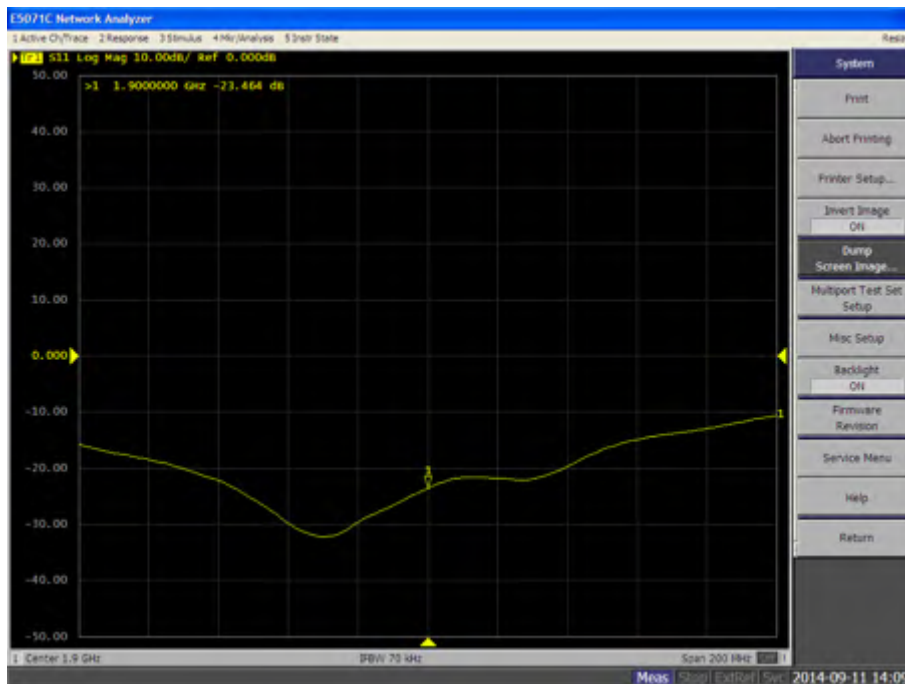





1900MHz Body calibrated impedance 48.270Ω; measured impedance: 48.993Ω (within 5Ω)

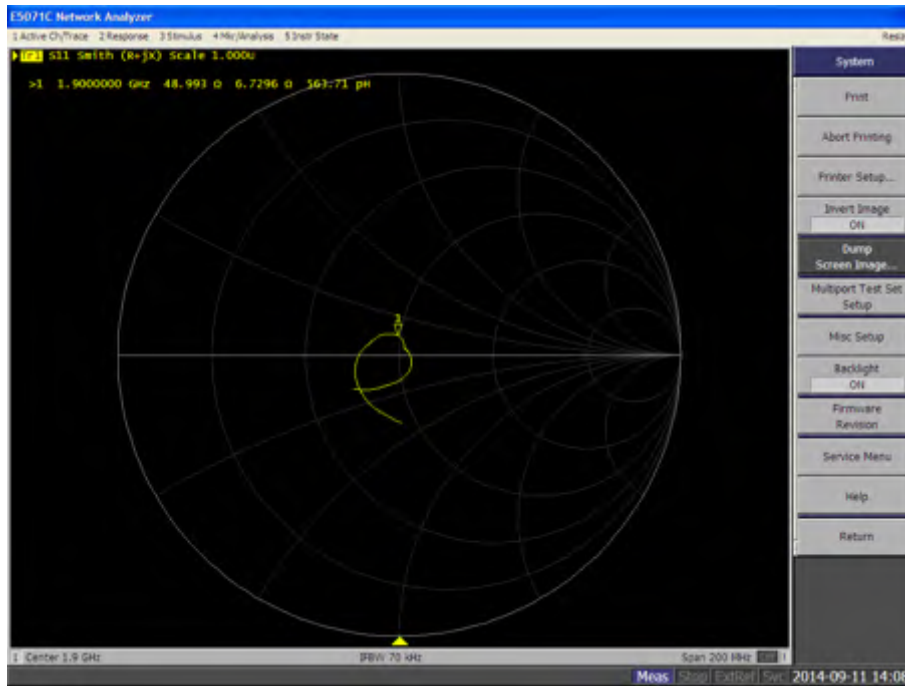

1900MHz Body calibrated return loss: -25.301dB; Measured impedance: -24.213dB (within 20%)

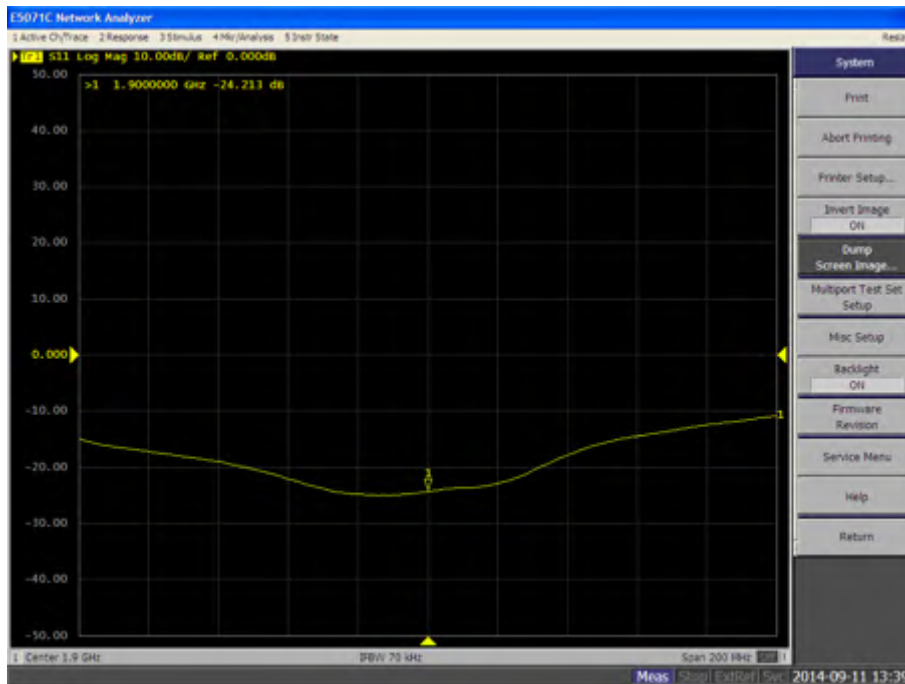





Plot for D2450V2, serial No. 914

2450MHz Head calibrated impedance 57.025Ω; measured impedance: 55.186Ω (within 5Ω)

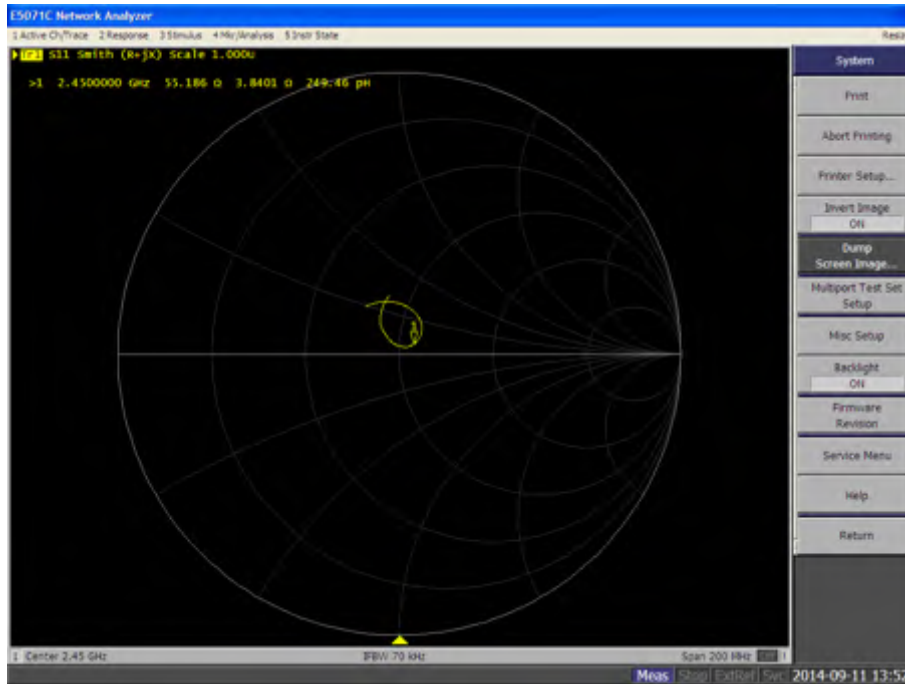

2450MHz Head calibrated return loss: -23.339dB; Measured impedance: -22.468dB (within 20%)

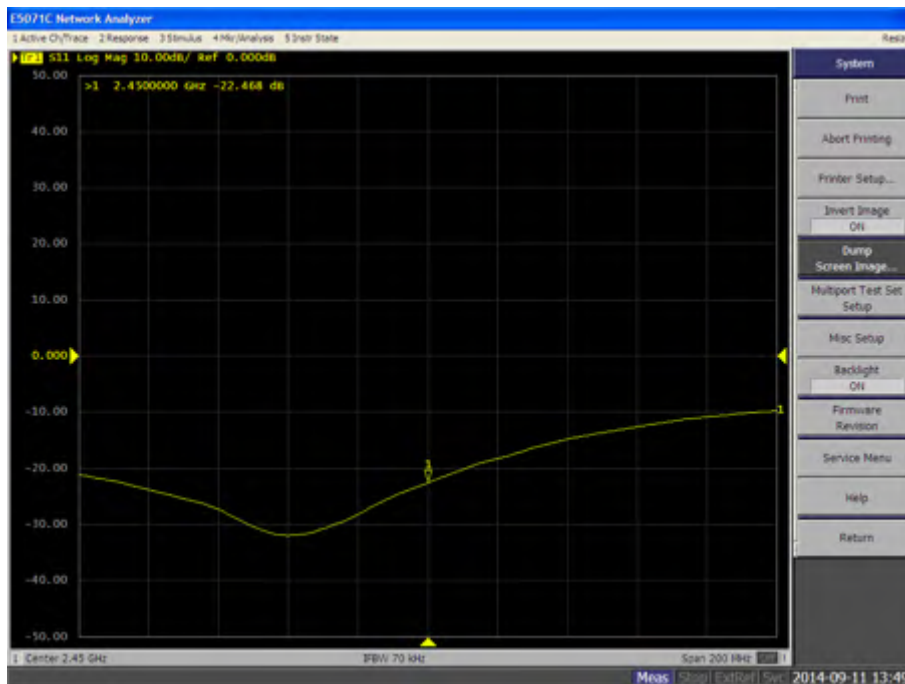



2450MHz Body calibrated impedance 52.051Ω; measured impedance: 50.948Ω (within 5Ω)

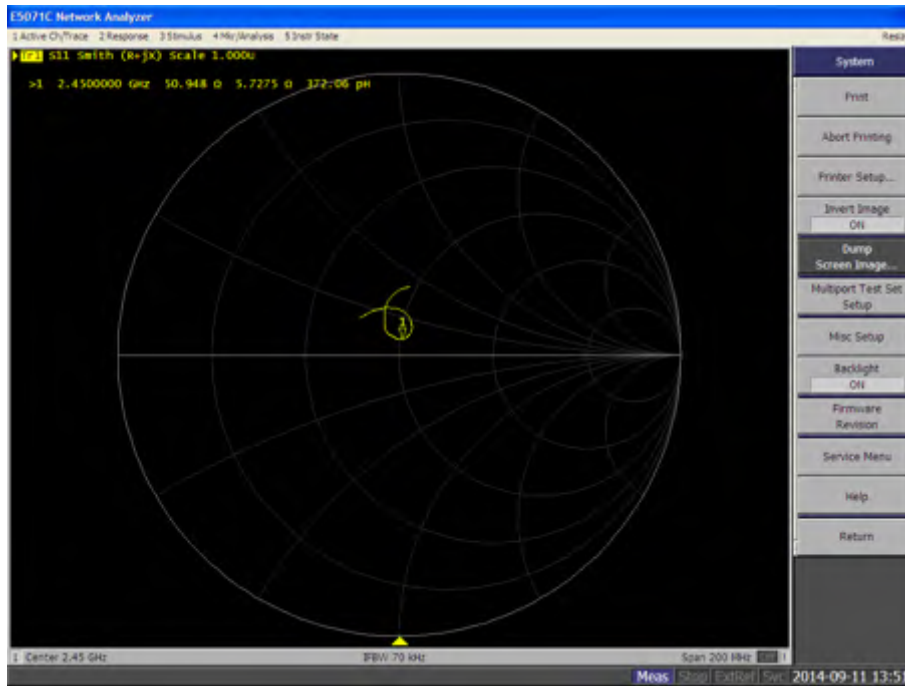

2450MHz Body calibrated return loss: -28.024 dB; Measured impedance: -26.968dB (within 20%)

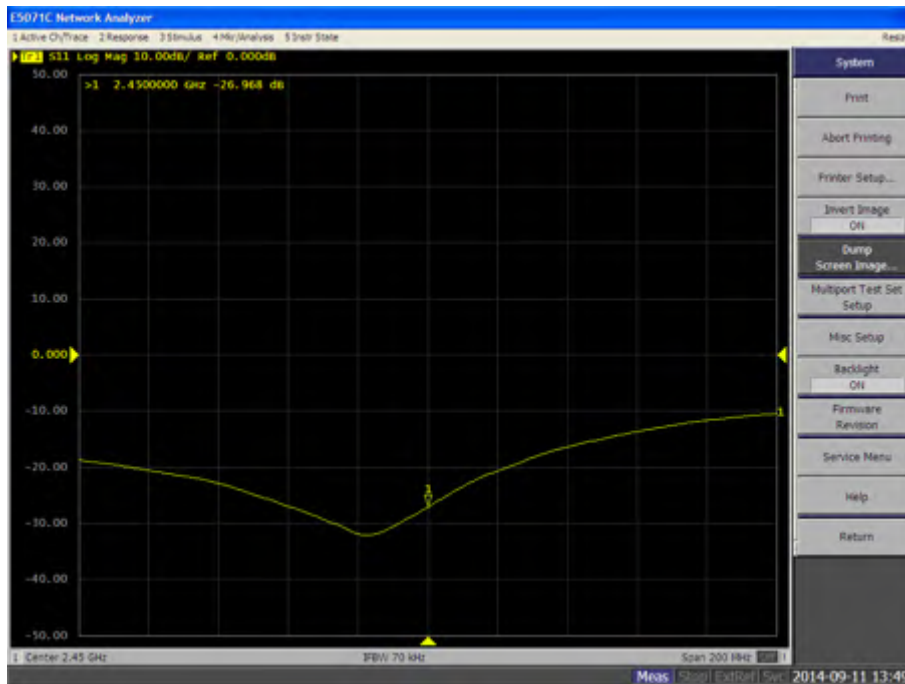



## 4. Results

### 4.1. Conducted power (Averaged)

#### ➤ GSM850&PCS1900

Mode	Frequency (MHz)	Avg. Burst Power(dBm)	Duty Cycle Factor (dB)	Frame Power (dBm)	Max. Power (dBm)	Scaling Factor
GSM850	824.2	32.13	-9	23.13	32.5	1.09
	836.6	32.15	-9	23.15	32.5	1.08
	848.8	32.29	-9	23.29	32.5	1.05
GPRS850(1Slot)	824.2	32.06	-9	23.06	32.5	1.11
	836.6	32.07	-9	23.07	32.5	1.10
	848.8	32.23	-9	23.23	32.5	1.06
GPRS850(2Slot)	824.2	31.43	-6	25.43	32.0	1.14
	836.6	31.35	-6	25.35	32.0	1.16
	848.8	31.65	-6	25.65	32.0	1.08
GPRS850(3Slot)	824.2	30.59	-4.25	26.34	31.0	1.10
	836.6	30.55	-4.25	26.30	31.0	1.11
	848.8	30.65	-4.25	26.40	31.0	1.08
<b>GPRS850(4Slot)</b>	<b>824.2</b>	<b>29.31</b>	<b>-3</b>	<b>26.31</b>	<b>29.5</b>	<b>1.04</b>
	<b>836.6</b>	<b>29.46</b>	<b>-3</b>	<b>26.46</b>	<b>29.5</b>	<b>1.01</b>
	<b>848.8</b>	<b>29.49</b>	<b>-3</b>	<b>26.49</b>	<b>29.5</b>	<b>1.00</b>
Edge850(1Slot)	824.2	32.06	-9	23.06	32.5	1.11
	836.6	32.04	-9	23.04	32.5	1.11
	848.8	32.21	-9	23.21	32.5	1.07
Edge850(2Slot)	824.2	31.35	-6	25.35	31.5	1.04
	836.6	31.33	-6	25.33	31.5	1.04
	848.8	31.45	-6	25.45	31.5	1.01
Edge850(3Slot)	824.2	30.40	-4.25	26.15	30.50	1.02
	836.6	30.29	-4.25	26.04	30.50	1.05
	848.8	30.33	-4.25	26.08	30.50	1.04
Edge850(4Slot)	824.2	29.46	-3	26.46	29.50	1.01
	836.6	29.29	-3	26.29	29.50	1.05
	848.8	29.36	-3	26.36	29.50	1.03
<b>SIM2</b>						
GSM850	824.2	32.12	-9	23.12	32.5	1.09
	836.6	32.13	-9	23.13	32.5	1.09
	848.8	32.29	-9	23.29	32.5	1.05



Mode	Frequency (MHz)	Avg. Burst Power(dBm)	Duty Cycle Factor (dB)	Frame Power (dBm)	Max. Power (dBm)	Scaling Factor
PCS1900	1850.2	28.31	-9	19.31	28.5	1.04
	1880	28.29	-9	19.29	28.5	1.05
	1909.8	27.76	-9	18.76	28.5	1.19
GPRS1900(1Slot)	1850.2	28.32	-9	19.32	28.5	1.04
	1880	28.27	-9	19.27	28.5	1.05
	1909.8	27.78	-9	18.78	28.5	1.18
GPRS1900(2Slot)	1850.2	26.88	-6	20.88	27.0	1.03
	1880	26.77	-6	20.77	27.0	1.05
	1909.8	26.32	-6	20.32	27.0	1.17
GPRS1900(3Slot)	1850.2	25.86	-4.25	21.61	26.0	1.03
	1880	25.95	-4.25	21.70	26.0	1.01
	1909.8	25.31	-4.25	21.06	26.0	1.17
<b>GPRS1900(4Slot)</b>	<b>1850.2</b>	<b>25.16</b>	<b>-3</b>	<b>22.16</b>	<b>25.2</b>	<b>1.01</b>
	<b>1880</b>	<b>25.06</b>	<b>-3</b>	<b>22.06</b>	<b>25.2</b>	<b>1.03</b>
	<b>1909.8</b>	<b>25.17</b>	<b>-3</b>	<b>22.17</b>	<b>25.2</b>	<b>1.01</b>
EDGE 1900(1Slot)	1850.2	28.22	-9	19.22	28.5	1.07
	1880	28.17	-9	19.17	28.5	1.08
	1909.8	27.67	-9	18.67	28.5	1.21
EDGE 1900(2Slot)	1850.2	27.23	-6	21.23	27.5	1.06
	1880	27.22	-6	21.22	27.5	1.07
	1909.8	26.69	-6	20.69	27.5	1.21
EDGE 1900(3Slot)	1850.2	26.64	-4.25	22.39	27.0	1.09
	1880	26.62	-4.25	22.37	27.0	1.09
	1909.8	26.06	-4.25	21.81	27.0	1.24
EDGE 1900(4Slot)	1850.2	25.31	-3	22.31	25.5	1.04
	1880	25.31	-3	22.31	25.5	1.04
	1909.8	24.74	-3	21.74	25.5	1.19
<b>SIM2</b>						
PCS1900	1850.2	28.30	-9	19.30	28.5	1.05
	1880	28.29	-9	19.29	28.5	1.05
	1909.8	27.75	-9	18.75	28.5	1.19

Note: 1. Scaling Factor = Max. Power (mW) / Avg. Burst Power (mW), Max. Power is the tune-up power.

2. This device operates using the following maximum and nominal output power specifications. SAR values were scaled to the maximum allowed power to determine compliance per KDB Publication 447498D01v05.

3. Both burst-averaged and calculated frame-averaged powers are included. Frame-averaged powers were calculated from the measured burst-averaged power by converting the slot powers into linear units and calculating the energy over 8 timeslots.

4. The bolded GPRS modes were selected for SAR testing according to the highest frame-averaged output power table per KDB 941225 D03v01.



➤ WCDMA/HSDPA/HSUPA

Mode	3GPP Subtest	Band II (1900MHz) Channel			Band IV (1700MHz) Channel			Band V (850MHz) Channel			MPR
		Conducted Power (dBm)									
		9262	9400	9538	1312	1413	1513	4132	4183	4233	
WCDMA R99	1	21.95	22.42	21.67	20.61	21.26	20.88	24.66	24.33	23.06	N/A
Rel5 HSDPA	1	21.77	22.36	21.66	20.60	21.26	20.87	24.56	24.32	23.02	0
	2	21.73	22.36	21.59	20.59	21.25	20.87	24.55	24.33	22.99	0
	3	21.78	22.40	21.56	20.58	21.25	20.84	24.56	24.25	22.98	0.5
	4	21.77	22.41	21.58	20.59	21.26	20.83	24.49	24.29	22.98	0.5
Rel6 HSUPA	1	21.82	22.41	21.61	20.62	21.25	20.86	24.63	24.30	23.05	0.0
	2	21.83	22.39	21.54	20.58	21.23	20.85	24.60	24.29	23.04	2.0
	3	21.79	22.38	21.55	20.61	21.25	20.84	24.59	24.30	22.98	1.0
	4	21.78	22.28	21.60	20.56	21.24	20.86	24.55	24.26	22.99	2.0
	5	21.81	22.39	21.66	20.58	21.25	20.87	24.56	24.17	22.98	0.0

Mode	Band II (1900MHz) Channel	Normal Power (dBm)	Max. Power (dBm)	Scaling Factor
WCDMA R99	9262	21.95	22.5	1.14
	9400	22.42	22.5	1.02
	9538	21.67	22.5	1.21
Rel5 HSDPA	9262	21.77	22.5	1.18
	9400	22.36	22.5	1.03
	9538	21.66	22.5	1.21
Rel6 HSUPA	9262	21.82	22.5	1.17
	9400	22.41	22.5	1.02
	9538	21.61	22.5	1.23
Mode	Band IV (1700MHz) Channel	Normal Power (dBm)	Max. Power (dBm)	
WCDMA R99	1312	20.61	21.5	1.23
	1412	21.26	21.5	1.06
	1513	20.88	21.5	1.15
Rel5 HSDPA	1312	20.60	21.5	1.23
	1412	21.26	21.5	1.06
	1513	20.87	21.5	1.16
Rel6 HSUPA	1312	20.62	21.5	1.22
	1412	21.25	21.5	1.06
	1513	20.86	21.5	1.16



Mode	Band V (850MHz) Channel	Normal Power (dBm)	Max. Power (dBm)	Scaling Factor
WCDMA R99	4132	24.66	25.0	1.08
	4183	24.33	25.0	1.17
	4233	23.06	25.0	1.56
Rel5 HSDPA	4132	24.56	25.0	1.11
	4183	24.32	25.0	1.17
	4233	23.02	25.0	1.58
Rel6 HSUPA	4132	24.63	25.0	1.09
	4183	24.30	25.0	1.17
	4233	23.05	25.0	1.57

Note: UMTS SAR was tested under RMC 12.2 kbps with HSPA Inactive per KDB Publication 941225 D01v02. HSPA SAR was not required since the average output power of the HSPA subtests was not more than 0.25 dB higher than the RMC level and SAR was less than 1.2 W/kg.

➤ **WLAN**

Test Mode	Channel No.	Frequency (MHz)	Average Power (dBm)	Max. Power (dBm)	Scaling Factor
802.11b	1	2412	15.30	16.0	1.17
	6	2437	15.42	16.0	1.14
	11	2462	15.54	16.0	1.11
802.11g	1	2412	11.78	13.5	1.49
	6	2437	13.26	13.5	1.06
	11	2462	12.72	13.5	1.20
802.11n (20MHz)	1	2412	12.12	13.5	1.37
	6	2437	13.32	13.5	1.04
	11	2462	12.85	13.5	1.16
802.11n (40MHz)	3	2422	9.94	10.0	1.01
	6	2437	11.85	12.0	1.04
	9	2452	10.40	12.0	1.45

Note 1: Justification for reduced test configurations for Wi-Fi channels Per KDB Publication 248227 D01v01r02 and KDB 447498 D01v05r02.

2: For 2.4 GHz, highest average RF output power channel for the lowest data rate for IEEE 802.11b were selected for SAR evaluation. Other IEEE 802.11 modes (including 802.11g/n) were not investigated since the average output powers over all channels and data rates were not more than 0.25 dB higher than the tested channel in the lowest data rate of IEEE 802.11b mode.

3: When the maximum extrapolated peak SAR of the zoom scan for the maximum output channel is <1.6 W/kg and the reported 1g averaged SAR is <0.8 W/kg, SAR testing on other channels is not required. Otherwise, the other default (or corresponding required) test channels were additionally tested using the lowest data rate.



### 4.2. Estimated SAR for Bluetooth

This device contains transmitters that may operate simultaneously. Therefore simultaneous transmission analysis is required. Per FCC KDB 447498 D01v05r02, simultaneous transmission SAR test exclusion may be applied when the sum of the 1-g SAR for all the simultaneous transmitting antennas in a specific a physical test configuration is ≤1.6W/kg. When standalone SAR is not required to be measured, per FCC KDB 447498 D01v05r02 4.3.2 2, the following equation must be used to estimate the standalone 1g SAR for simultaneous transmission assessment involving that transmitter.

$$\text{Estimated SAR} = \frac{\sqrt{f(\text{GHz})}}{7.5} * \frac{(\text{Max Power of channel, mW})}{\text{Min. Separation Distance, mm}}$$

Mode	Frequency	Maximum Allowed Power	Separation Distance (Head)	Estimated SAR (Held-to-Ear)	Separation Distance (Body)	Estimated SAR (Body)
	[MHz]	[dBm]	[mm]	[W/kg]	[mm]	[W/kg]
Bluetooth	2441	1.04	5	0.053	10	0.027



## 4.3. SAR Test Results Summary

SAR MEASUREMENT									
Ambient Temperature (°C) : 21.5 ± 2					Relative Humidity (%): 52				
Liquid Temperature (°C) : 21.0 ± 2					Depth of Liquid (cm):>15				
Product: Mobile Phone									
Test Mode: GSM850									
Tune-up power: 32.5dBm									
Test Position Head	Antenna Position	Frequency		Avg. Power (dBm)	Power Drift (<±0.2)	SAR 1g (W/kg)	Scaling Factor	Scaled SAR 1g (W/kg)	Limit (W/kg)
		Channel	MHz						
Left-Cheek	Fixed	128	824.2	32.13	--	--	1.09	--	1.6
Left-Cheek	Fixed	190	836.6	32.15	0.07	0.00821	1.08	0.009	1.6
Left-Cheek	Fixed	251	848.8	32.29	--	--	1.05	--	1.6
Left-Tilted	Fixed	190	836.6	32.15	0.19	0.00272	1.08	0.003	1.6
Right-Cheek	Fixed	128	824.2	32.13	--	--	1.09	--	1.6
Right-Cheek	Fixed	190	836.6	32.15	-0.13	0.00682	1.08	0.007	1.6
Right-Cheek	Fixed	251	848.8	32.29	--	--	1.05	--	1.6
Right-Tilted	Fixed	190	836.6	32.15	0.09	0.00277	1.08	0.0030	1.6
SIM2									
Left-Cheek	Fixed	190	836.6	32.13	0.11	0.00806	1.09	0.009	1.6
Note 1: when the 1-g SAR is ≤ 0.8 W/kg, testing for low and high channel is optional, refer to KDB 447498; 2: Two SIM cards cannot work simultaneously.									





SAR MEASUREMENT									
Ambient Temperature (°C) : 21.5 ± 2					Relative Humidity (%): 52				
Liquid Temperature (°C) : 21.0 ± 2					Depth of Liquid (cm):>15				
Product: Mobile Phone									
Test Mode: GSM850									
Tune-up power: 32.5dBm									
Test Position Body (10mm gap)	Antenna Position	Frequency		Avg. Power (dBm)	Power Drift (<±0.2)	SAR 1g (W/kg)	Scaling Factor	Scaled SAR 1g (W/kg)	Limit (W/kg)
		Channel	MHz						
Body-Back	Fixed	128	824.2	32.13	--	--		--	1.6
Body-Back	Fixed	190	836.6	32.15	0.01	0.127	1.08	0.137	1.6
Body-Back	Fixed	251	848.8	32.29	--	--		--	1.6
Test Mode: GPRS850-4slot									
Tune-up power: 29.5dBm									
Body-Back	Fixed	128	824.2	29.31	--	--	1.04	--	1.6
Body-Back	Fixed	190	836.6	29.46	0.11	0.212	1.01	0.214	1.6
Body-Back	Fixed	251	848.8	29.49	--	--	1.00	--	1.6
Body-Front	Fixed	190	836.6	29.46	0.06	0.146	1.01	0.147	1.6
Left side	Fixed	190	836.6	29.46	-0.16	0.060	1.01	0.061	1.6
Right side	Fixed	190	836.6	29.46	-0.13	0.033	1.01	0.033	1.6
Bottom	Fixed	190	836.6	29.46	-0.15	0.110	1.01	0.111	1.6
Note 1: when the 1-g SAR is ≤ 0.8 W/kg, testing for low and high channel is optional, refer to KDB 447498;									
2: Two SIM cards cannot work simultaneously.									



SAR MEASUREMENT									
Ambient Temperature (°C) : 21.5 ± 2					Relative Humidity (%): 52				
Liquid Temperature (°C) : 21.0 ± 2					Depth of Liquid (cm):>15				
Product: Mobile Phone									
Test Mode: PCS1900									
Tune-up power: 28.5dBm									
Test Position Head	Antenna Position	Frequency		Avg. Power (dBm)	Power Drift (<±0.2)	SAR 1g (W/kg)	Scaling Factor	Scaled SAR 1g (W/kg)	Limit (W/kg)
		Channel	MHz						
Left-Cheek	Fixed	512	1850.2	28.31	--	--	1.04	--	1.6
Left-Cheek	Fixed	661	1880	28.29	-0.19	0.087	1.05	0.091	1.6
Left-Cheek	Fixed	810	1909.8	27.76	--	--	1.19	--	1.6
Left-Tilted	Fixed	661	1880.0	28.29	0.15	0.042	1.05	0.044	1.6
Right-Cheek	Fixed	512	1850.2	28.31	--	--	1.04	--	1.6
Right-Cheek	Fixed	661	1880	28.29	0.16	0.058	1.05	0.061	1.6
Right-Cheek	Fixed	810	1909.8	27.76	--	--	1.19	--	1.6
Right-Tilted	Fixed	661	1880.0	28.29	0.12	0.038	1.05	0.040	1.6
SIM2									
Left-Cheek	Fixed	661	1880	28.29	0.15	0.076	1.05	0.080	1.6
Note 1: when the 1-g SAR is ≤ 0.8 W/kg, testing for low and high channel is optional, refer to KDB 447498; 2: Two SIM cards cannot work simultaneously.									



SAR MEASUREMENT									
Ambient Temperature (°C) : 21.5 ± 2					Relative Humidity (%): 52				
Liquid Temperature (°C) : 21.0 ± 2					Depth of Liquid (cm):>15				
Product: Mobile Phone									
Test Mode: PCS1900									
Tune-up power: 28.5dBm									
Test Position Body (10mm gap)	Antenna Position	Frequency		Avg. Power (dBm)	Power Drift (<±0.2)	SAR 1g (W/kg)	Scaling Factor	Scaled SAR 1g (W/kg)	Limit (W/kg)
		Channel	MHz						
Body-Back	Fixed	512	1850.2	28.31	--	--	1.04	--	1.6
Body-Back	Fixed	661	1880	28.29	0.11	0.264	1.05	0.277	1.6
Body-Back	Fixed	810	1909.8	27.76	--	--	1.19	--	1.6
Test Mode: GPRS1900-4slot									
Tune-up power: 25.2dBm									
Body-Back	Fixed	512	1850.2	25.16	0.10	0.867	1.01	0.876	1.6
Body-Back	Fixed	661	1880	25.06	0.19	0.994	1.03	1.024	1.6
Body-Back	Fixed	810	1909.8	25.17	0.14	0.997	1.01	1.007	1.6
Body-Back*	Fixed	810	1909.8	24.57	0.12	0.995	1.03	1.025	1.6
Body-Front	Fixed	661	1880	25.06	0.12	0.367	1.03	0.378	1.6
Left side	Fixed	661	1880	25.06	-0.02	0.225	1.03	0.232	1.6
Right side	Fixed	661	1880	25.06	0.06	0.123	1.03	0.127	1.6
Bottom	Fixed	661	1880	25.06	-0.03	0.461	1.03	0.475	1.6
<p>Note 1: when the 1-g SAR is ≤ 0.8 W/kg, testing for low and high channel is optional, refer to KDB 447498;</p> <p>2: * - repeated SAR is required according to the FCC KDB 865664;</p> <p>3: Two SIM cards cannot work simultaneously.</p>									



SAR MEASUREMENT									
Ambient Temperature (°C) : 21.5 ±2					Relative Humidity (%): 52				
Liquid Temperature (°C) : 21.0 ±2					Depth of Liquid (cm):>15				
Product: Mobile Phone									
Test Mode: WCDMA Band II									
Tune-up power: 22.5dBm									
Test Position Head	Antenna Position	Frequency		Conducted Power (dBm)	Power Drift (<±0.2)	SAR 1g (W/kg)	Scaling Factor	Scaled SAR 1g (W/kg)	Limit (W/kg)
		Channel	MHz						
Left-Cheek	Fixed	9400	1880.0	22.42	0.12	<b>0.074</b>	1.02	<b>0.075</b>	1.6
Left-Tilt	Fixed	9400	1880.0	22.42	0.18	<b>0.034</b>	1.02	<b>0.035</b>	1.6
Right-Cheek	Fixed	9400	1880.0	22.42	0.19	<b>0.047</b>	1.02	<b>0.048</b>	1.6
Right-Tilt	Fixed	9400	1880.0	22.42	0.10	<b>0.031</b>	1.02	<b>0.032</b>	1.6
Note 1: when the 1-g SAR is $\leq 0.8$ W/kg, testing for low and high channel is optional, refer to KDB 447498. 2: Two SIM cards cannot work simultaneously.									



SAR MEASUREMENT									
Ambient Temperature (°C): 21.5 ±2					Relative Humidity (%): 52				
Liquid Temperature (°C): 21.0 ±2					Depth of Liquid (cm):>15				
Product: Mobile Phone									
Test Mode: WCDMA Band II									
Tune-up power: 22.5dBm									
Test Position Body (10mm gap)	Antenna Position	Frequency		Conducted Power (dBm)	Power Drift (<±0.2)	SAR 1g (W/kg)	Scaling Factor	Scaled SAR 1g (W/kg)	Limit (W/kg)
		Channel	MHz						
Body-Back	Fixed	9262	1852.4	21.95	--	--	1.14	--	1.6
Body-Back	Fixed	9400	1880.0	22.42	-0.12	<b>0.273</b>	1.02	<b>0.278</b>	1.6
Body-Back	Fixed	9538	1907.6	21.67	--	--	1.21	--	1.6
Body-Front	Fixed	9400	1880.0	22.42	0.12	<b>0.192</b>	1.02	<b>0.196</b>	1.6
Left side	Fixed	9400	1880.0	22.42	0.04	<b>0.104</b>	1.02	<b>0.106</b>	1.6
Right side	Fixed	9400	1880.0	22.42	-0.08	<b>0.047</b>	1.02	<b>0.048</b>	1.6
Body-Bottom	Fixed	9400	1880.0	22.42	0.09	<b>0.182</b>	1.02	<b>0.186</b>	1.6
Note 1: when the 1-g SAR is ≤ 0.8 W/kg, testing for low and high channel is optional, refer to KDB 447498; 2: Two SIM cards cannot work simultaneously.									



SAR MEASUREMENT									
Ambient Temperature (°C) : 21.5 ±2					Relative Humidity (%): 52				
Liquid Temperature (°C) : 21.0 ±2					Depth of Liquid (cm):>15				
Product: Mobile Phone									
Test Mode: WCDMA Band IV									
Tune-up power: 21.5dBm									
Test Position Head	Antenna Position	Frequency		Conducted Power (dBm)	Power Drift (<±0.2)	SAR 1g (W/kg)	Scaling Factor	Scaled SAR 1g (W/kg)	Limit (W/kg)
		Channel	MHz						
Left-Cheek	Fixed	1413	1732.6	21.26	0.19	0.059	1.06	0.063	1.6
Left-Tilt	Fixed	1413	1732.6	21.26	0.14	0.00688	1.06	0.007	1.6
Right-Cheek	Fixed	1413	1732.6	21.26	0.14	0.107	1.06	0.113	1.6
Right-Tilt	Fixed	1413	1732.6	21.26	0.04	0.025	1.06	0.027	1.6
Note 1: when the 1-g SAR is ≤ 0.8 W/kg, testing for low and high channel is optional, refer to KDB 447498.									
2: Two SIM cards cannot work simultaneously.									



SAR MEASUREMENT									
Ambient Temperature (°C): 21.5 ±2					Relative Humidity (%): 52				
Liquid Temperature (°C): 21.0 ±2					Depth of Liquid (cm):>15				
Product: Tablet PC									
Test Mode: WCDMA Band IV									
Tune-up power: 21.5dBm									
Test Position Body (10mm gap)	Antenna Position	Frequency		Conducted Power (dBm)	Power Drift (<±0.2)	SAR 1g (W/kg)	Scaling Factor	Scaled SAR 1g (W/kg)	Limit (W/kg)
		Channel	MHz						
Back	Fixed	1312	1712.4	20.61	--	--	1.23	--	1.6
Back	Fixed	1413	1732.6	21.26	0.12	<b>0.538</b>	1.06	<b>0.570</b>	1.6
Back	Fixed	1513	1752.6	20.88	--	--	1.15	--	1.6
Front	Fixed	1413	1732.6	21.26	0.19	<b>0.358</b>	1.06	<b>0.379</b>	1.6
Left side	Fixed	1413	1732.6	21.26	-0.13	<b>0.021</b>	1.06	<b>0.022</b>	1.6
Right side	Fixed	1413	1732.6	21.26	-0.16	<b>0.011</b>	1.06	<b>0.012</b>	1.6
Bottom	Fixed	1413	1732.6	21.26	0.15	<b>0.513</b>	1.06	<b>0.544</b>	1.6
Note 1: when the 1-g SAR is ≤ 0.8 W/kg, testing for low and high channel is optional, refer to KDB 447498;									





SAR MEASUREMENT									
Ambient Temperature (°C) : 21.5 ±2					Relative Humidity (%): 52				
Liquid Temperature (°C) : 21.0 ±2					Depth of Liquid (cm):>15				
Product: Mobile Phone									
Test Mode: WCDMA Band V									
Tune-up power: 25.0dBm									
Test Position Head	Antenna Position	Frequency		Conducted Power (dBm)	Power Drift (<±0.2)	SAR 1g (W/kg)	Scaling Factor	Scaled SAR 1g (W/kg)	Limit (W/kg)
		Channel	MHz						
Left-Cheek	Fixed	4183	836.6	24.33	0.12	0.038	1.17	0.044	1.6
Left-Tilt	Fixed	4183	836.6	24.33	0.19	0.016	1.17	0.019	1.6
Right-Cheek	Fixed	4183	836.6	24.33	0.10	0.0242	1.17	0.028	1.6
Right-Tilt	Fixed	4183	836.6	24.33	0.18	0.015	1.17	0.018	1.6
Note 1: when the 1-g SAR is ≤ 0.8 W/kg, testing for low and high channel is optional, refer to KDB 447498; 2: Two SIM cards cannot work simultaneously.									



SAR MEASUREMENT									
Ambient Temperature (°C): 21.5 ±2					Relative Humidity (%): 52				
Liquid Temperature (°C): 21.0 ±2					Depth of Liquid (cm):>15				
Product: Mobile Phone									
Test Mode: WCDMA Band V									
Tune-up power: 25.0dBm									
Test Position Body (10mm gap)	Antenna Position	Frequency		Conducted Power (dBm)	Power Drift (<±0.2)	SAR 1g (W/kg)	Scaling Factor	Scaled SAR 1g (W/kg)	Limit (W/kg)
		Channel	MHz						
Body-Back	Fixed	4183	836.6	24.33	0.14	0.049	1.17	0.057	1.6
Body-Front	Fixed	4183	836.6	24.33	0.18	0.029	1.17	0.034	1.6
Left side	Fixed	4183	836.6	24.33	0.19	0.027	1.17	0.032	1.6
Right side	Fixed	4183	836.6	24.33	0.13	0.014	1.17	0.016	1.6
Body-Bottom	Fixed	4183	836.6	24.33	0.10	0.00556	1.17	0.007	1.6
Note 1: when the 1-g SAR is $\leq 0.8$ W/kg, testing for low and high channel is optional, refer to KDB 447498; 2: Two SIM cards cannot work simultaneously.									



SAR MEASUREMENT									
Ambient Temperature (°C) : 21.5 ± 2					Relative Humidity (%): 52				
Liquid Temperature (°C) : 21.0 ± 2					Depth of Liquid (cm):>15				
Product: Mobile Phone									
Test Mode: 802.11b									
Tune-up power: 16.0dBm									
Test Position Head	Antenna Position	Frequency		Average Power (dBm)	Power Drift (<±0.2)	SAR 1g (W/kg)	Scaling Factor	Scaled SAR 1g (W/kg)	Limit (W/kg)
		Channel	MHz						
Left-Cheek	Fixed	1	2412	15.30	--	--	1.17	--	1.6
Left-Cheek	Fixed	6	2437	15.42	0.11	0.143	1.14	0.163	1.6
Left-Cheek	Fixed	11	2462	15.54	--	--	1.11	--	1.6
Left-Tilted	Fixed	6	2437	15.42	0.15	0.074	1.14	0.084	1.6
Right-Cheek	Fixed	1	2412	15.30	--	--	1.17	--	1.6
Right-Cheek	Fixed	6	2437	15.42	-0.11	0.146	1.14	0.166	1.6
Right-Cheek	Fixed	11	2462	15.54	--	--	1.11	--	1.6
Right-Tilted	Fixed	6	2437	15.42	-0.11	0.081	1.14	0.092	1.6
Note 1: when the 1-g SAR is ≤ 0.8 W/kg, testing for low and high channel is optional, refer to KDB 447498; 2: Two SIM cards cannot work simultaneously.									



SAR Measurement									
Ambient Temperature (°C): 21.5 ± 2					Relative Humidity (%): 52				
Liquid Temperature (°C): 21.0 ± 2					Depth of Liquid (cm):>15				
Product: Mobile Phone									
Tablet Mode SAR Configurations									
Test Mode: 802.11b									
Tune-up power: 16.0dBm									
Test Position Body (10mm gap)	Antenna Position	Frequency		Average Power (dBm)	Power Drift (<±0.2)	SAR 1g (W/kg)	Scaling Factor	Scaled SAR 1g (W/kg)	Limit (W/kg)
		Channel	MHz						
Back	Fixed	1	2412	15.30	-0.06	0.068	1.17	0.080	1.6
Back	Fixed	6	2437	15.42	-0.10	0.122	1.14	0.139	1.6
Back	Fixed	11	2462	15.54	0.01	0.152	1.11	0.169	1.6
Front	Fixed	11	2462	15.54	-0.18	0.046	1.11	0.051	1.6
Right side	Fixed	11	2462	15.54	0.11	0.100	1.11	0.111	1.6
Top	Fixed	11	2462	15.54	0.10	0.035	1.11	0.039	1.6
Note1: when the 1-g SAR is ≤ 0.8 W/kg, testing for low and high channel is optional, refer to KDB 447498; 2: Two SIM cards cannot work simultaneously.									



## 5. The Description of Test Procedure

### 5.1. General Notes:

1. Batteries are fully charged at the beginning of the SAR measurements.
2. The manufacturer has confirmed that the device(s) tested have the same physical, mechanical and thermal characteristics and are within operational tolerances expected for production units.
3. SAR results were scaled to the maximum allowed power to demonstrate compliance per FCC KDB Publication 447498 D01v05r02.
4. Per FCC KDB 616217 D04 Section 4.3, SAR tests are required for the back surface and edges of the tablet with the tablet touching the phantom. The SAR Exclusion Threshold in FCC KDB 447498 D01v05 was applied to determine SAR test exclusion for adjacent edge configurations. SAR tests were required for bottom and primary landscape for the BT/WLAN Antenna.

### WLAN/BT Notes:

1. Justification for reduced test configurations for WIFI channels per KDB Publication 248227 D01v01r02 and April 2010 FCC/TCB Meeting Notes for 2.4 GHz WIFI: Highest average RF output power channel for the lowest data rate was selected for SAR evaluation in 802.11b. Other IEEE 802.11 modes (including 802.11g/n) were not investigated since the average output powers over all channels and data rates were not more than 0.25 dB higher than the tested channel in the lowest data rate of IEEE 802.11b mode.
2. WIFI transmission was verified using a spectrum analyzer.
3. When the maximum extrapolated peak SAR of the zoom scan for the maximum output channel is  $<1.6$  W/kg and the reported 1g averaged SAR is  $<0.8$  W/kg, SAR testing on other default channels is not required.

### 5.2. Simultaneous Transmission Procedures

This device contains transmitters that may operate simultaneously. Therefore simultaneous transmission analysis is required. Per FCC KDB 447498 D01v05r02, simultaneous transmission SAR test exclusion may be applied when the sum of the 1-g SAR for all the simultaneous transmitting antennas in a specific a physical test configuration is  $\leq 1.6$ W/kg.



### 5.3. Simultaneous Transmission Analysis

#### Simultaneous Transmission Scenario with Wi-Fi

Configuration	Mode	Max. Scaled SAR(W/kg)	Wi-Fi SAR(W/kg)	Σ SAR(W/kg)
Head	GSM850	0.009	0.166	0.175
Head	PCS1900	0.091	0.166	0.257
Head	WCDMA Band II	0.075	0.166	0.241
Head	WCDMA Band IV	0.113	0.166	<b>0.279</b>
Head	WCDMA Band V	0.057	0.166	0.223
Back	GSM850	0.214	0.169	0.383
Back	PCS1900	1.025	0.169	<b>1.194</b>
Back	WCDMA Band II	0.278	0.169	0.447
Back	WCDMA Band IV	0.570	0.169	0.739
Back	WCDMA Band V	0.057	0.169	0.226

#### Simultaneous Transmission Scenario with Bluetooth

Configuration	Mode	Max. Scaled SAR(W/kg)	Bluetooth SAR(W/kg)	Σ SAR(W/kg)
Head	GSM850	0.009	0.053	0.062
Head	PCS1900	0.091	0.053	0.144
Head	WCDMA Band II	0.075	0.053	0.128
Head	WCDMA Band IV	0.113	0.053	0.166
Head	WCDMA Band V	0.057	0.053	0.110
Back	GSM850	0.214	0.027	0.241
Back	PCS1900	1.025	0.027	1.052
Back	WCDMA Band II	0.278	0.027	0.305
Back	WCDMA Band IV	0.570	0.027	0.597
Back	WCDMA Band V	0.057	0.027	0.084

Note : Bluetooth SAR was not required to be measured per FCC KDB 447498. Estimated SAR results were used in the above table to determine simultaneous transmission SAR test exclusion.

#### Simultaneous Transmission Scenario with Wi-Fi & Bluetooth

Note: Bluetooth and WIFI cannot be transmit at same time, due to they share the same antenna.



## Simultaneous Transmission Scenario (Hotspot)

Simult Tx	Configuration	GPRS850 SAR(W/kg)	Wi-Fi SAR(W/kg)	$\Sigma$ SAR(W/kg)
Body	Back	0.214	0.169	0.383
	Front	0.147	0.051	0.198
	Left side	0.061	N/A	0.061
	Right side	0.033	0.111	0.144
	Top	N/A	0.039	0.039
	Bottom	0.111	N/A	0.111
Simult Tx	Configuration	GPRS1900 SAR(W/kg)	Wi-Fi SAR(W/kg)	$\Sigma$ AR(W/kg)
Body	Back	1.025	0.169	<b>1.194</b>
	Front	0.378	0.051	0.429
	Left side	0.232	N/A	0.232
	Right side	0.127	0.111	0.238
	Top	N/A	0.039	0.039
	Bottom	0.475	N/A	0.475
Simult Tx	Configuration	WCDMA Band II SAR(W/kg)	Wi-Fi SAR(W/kg)	$\Sigma$ SAR(W/kg)
Body	Back	0.278	0.169	0.447
	Front	0.196	0.051	0.247
	Left side	0.106	N/A	0.106
	Right side	0.048	0.111	0.159
	Top	N/A	0.039	0.039
	Bottom	0.186	N/A	0.186
Simult Tx	Configuration	WCDMA Band IV SAR(W/kg)	Wi-Fi SAR(W/kg)	$\Sigma$ SAR(W/kg)
Body	Back	0.570	0.169	0.739
	Front	0.379	0.051	0.430
	Left side	0.022	N/A	0.022
	Right side	0.012	0.111	0.123
	Top	N/A	0.039	0.039
	Bottom	0.544	N/A	0.544
Simult Tx	Configuration	WCDMA Band V SAR(W/kg)	Wi-Fi SAR (W/kg)	$\Sigma$ SAR(W/kg)
Body	Back	0.057	0.169	0.226
	Front	0.034	0.051	0.085
	Left side	0.032	N/A	0.032



---

	Right side	0.016	0.111	0.127
	Top	N/A	0.039	0.039
	Bottom	0.007	N/A	0.007

#### 5.4. Simultaneous Transmission Conclusion

The above numerical summed SAR results for all the worst-case simultaneous transmission conditions were below the SAR limit. Therefore, the above analysis is sufficient to determine that simultaneous transmission cases will not exceed the SAR limit and therefore no measured volumetric simultaneous SAR summation is required per FCC KDB Publication 447498 D01v05r02.





## 6. Measurement Uncertainty

DASY5 Uncertainty Budget								
according to IEEE 1528/2011 (0.3-3GHz range)								
Error Description	Uncert. value	Prob. Dist.	Div.	(ci) 1g	(ci) 10g	Std.Unc. (1g)	Std. nc. (10g)	(vi) v <sub>eff</sub>
<b>Measurement System</b>								
Probe Calibration	±6.0%	N	1	1	1	±6.0%	±6.0%	∞
Axial Isotropy	±4.7%	R	$\sqrt{3}$	0.7	0.7	±1.9%	±1.9%	∞
Hemispherical Isotropy	±9.6%	R	$\sqrt{3}$	0.7	0.7	±3.9%	±3.9%	∞
Boundary Effects	±1.0%	R	$\sqrt{3}$	1	1	±0.6%	±0.6%	∞
Linearity	±4.7%	R	$\sqrt{3}$	1	1	±2.7%	±2.7%	∞
System Detection Limits	±1.0%	R	$\sqrt{3}$	1	1	±0.6%	±0.6%	∞
Modulation Response	±2.4%	R	$\sqrt{3}$	1	1	±1.4%	±1.4%	∞
Readout Electronics	±0.3%	N	1	1	1	±0.3%	±0.3%	∞
Response Time	±0.8%	R	$\sqrt{3}$	1	1	±0.5%	±0.5%	∞
Integration Time	±2.6%	R	$\sqrt{3}$	1	1	±1.5%	±1.5%	∞
RF Ambient Noise	±3.0%	R	$\sqrt{3}$	1	1	±1.7%	±1.7%	∞
RF Ambient Reflections	±3.0%	R	$\sqrt{3}$	1	1	±1.7%	±1.7%	∞
Probe Positioner	±0.4%	R	$\sqrt{3}$	1	1	±0.2%	±0.2%	∞
Probe Positioning	±2.9%	R	$\sqrt{3}$	1	1	±1.7%	±1.7%	∞
Max.SAR Eval.	±2.0%	R	$\sqrt{3}$	1	1	±1.2%	±1.2%	∞
<b>Test Sample Related</b>								
Device Positioning	±2.9%	N	1	1	1	±2.9%	±2.9%	145
Device Holder	±3.6%	N	1	1	1	±3.6%	±3.6%	5
Power Drift	±5.0%	R	$\sqrt{3}$	1	1	±2.9%	±2.9%	∞
Power Scaling <sup>p</sup>	±0%	R	$\sqrt{3}$	0	0	±0%	±0%	∞
<b>Phantom and Setup</b>								
Phantom Uncertainty	±6.1%	R	$\sqrt{3}$	1	1	±3.5%	±3.5%	∞
SAR correction	±1.9%	R	$\sqrt{3}$	1	0.84	±1.1%	±0.9%	∞
Liquid Conductivity (mea.) <sup>DAK</sup>	±2.5%	R	$\sqrt{3}$	0.78	0.71	±1.1%	±1.0%	∞
Liquid Permittivity (mea.) <sup>DAK</sup>	±2.5%	R	$\sqrt{3}$	0.26	0.26	±0.3%	±0.4%	∞
Temp. unc. –Conductivity <sup>BB</sup>	±3.4%	R	$\sqrt{3}$	0.78	0.71	±1.5%	±1.4%	∞
Temp. unc. – Permittivity <sup>BB</sup>	±0.4%	R	$\sqrt{3}$	0.23	0.26	±0.1%	±0.1%	∞
<b>Combined Std. Uncertainty</b>						±11.2%	±11.1%	361
<b>Expanded STD Uncertainty(Coverage factor=2)</b>						<b>±22.3%</b>	<b>±22.2%</b>	



## 7. APPENDIX A. SAR System Validation Data

Date/Time: 21/07/2014

Test Laboratory: CerpPASS Lab

SystemPerformanceCheck-D850 Head

**DUT: Dipole 850 MHz D850V2; Type: D850V2; Serial: D850V2**

Communication System: CW; Frequency: 850 MHz

Medium parameters used:  $f = 850$  MHz;  $\sigma = 0.9$  S/m;  $\epsilon_r = 41.29$ ;  $\rho = 1000$  kg/m<sup>3</sup>

Phantom section: Flat Section; Meas. Ambient Temp (celsius) -22°C; Input power-250mW

Measurement Standard: DASYS (IEEE/IEC/ANSI C63.19-2011)

DASY Configuration:

- Probe: EX3DV4 - SN3927; ConvF(10.23, 10.23, 10.23); Calibrated: 2014/5/23;
- Sensor-Surface: 4mm (Mechanical Surface Detection),  $z = 1.0, 31.0$
- Electronics: DAE4 Sn1379; Calibrated: 2014/5/19
- Phantom: SAM (30deg probe tilt) with CRP v5.0; Type: QD000P40CD
- DASY52 52.8.8(1222); SEMCAD X 14.6.10(7331)

**Configuration/SystemPerformanceCheck-D850 Head/Area Scan (4x12x1):** Measurement grid:

dx=15mm, dy=15mm, Maximum value of SAR (measured) = 2.41 W/kg

**Configuration/SystemPerformanceCheck-D850 Head/Zoom Scan (7x7x7)/Cube 0:** Measurement

grid: dx=5mm, dy=5mm, dz=5mm, Reference Value = 54.04 V/m; Power Drift = 0.01 dB

Peak SAR (extrapolated) = 3.62 W/kg

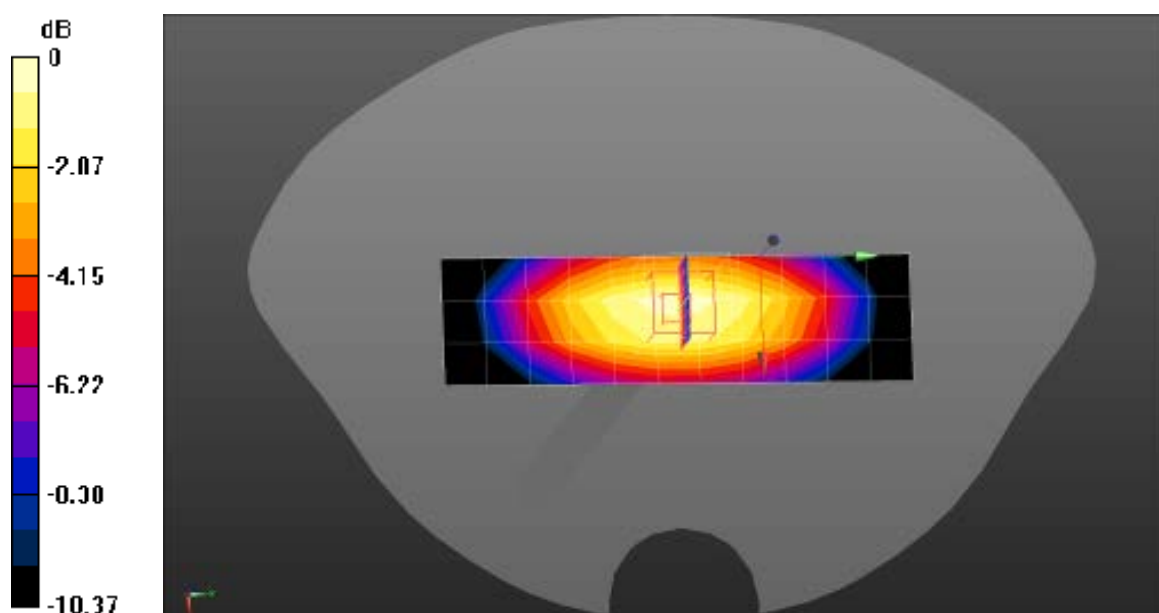
**SAR(1 g) = 2.44 W/kg; SAR(10 g) = 1.6 W/kg** Maximum value of SAR (measured) = 2.63 W/kg



Date/Time: 21/07/2014

Test Laboratory: CerpPASS Lab

SystemPerformanceCheck-D1750 Head

**DUT: Dipole 1750 MHz D1750V2; Type: D1750V2; Serial: D1750V2**

Communication System: CW; Frequency: 1750 MHz

Medium parameters used:  $f = 1750$  MHz;  $\sigma = 1.37$  S/m;  $\epsilon_r = 39.97$ ;  $\rho = 1000$  kg/m<sup>3</sup>

Phantom section: Flat Section ; Meas. Ambient Temp (celsius) -22°C; Input power-250mW

Measurement Standard: DASYS (IEEE/IEC/ANSI C63.19-2011)

DASY Configuration:

- Probe: EX3DV4 - SN3927; ConvF(8.55, 8.55, 8.55); Calibrated: 2014/5/23;
- Sensor-Surface: 4mm (Mechanical Surface Detection),  $z = 1.0, 31.0$
- Electronics: DAE4 Sn1379; Calibrated: 2014/5/19
- Phantom: SAM (30deg probe tilt) with CRP v5.0; Type: QD000P40CD
- DASYS 52.8.8(1222); SEMCAD X 14.6.10(7331)

**Configuration/SystemPerformanceCheck-D1750 Head/Area Scan (4x9x1):** Measurement grid:  $dx=15$ mm,  $dy=15$ mm, Maximum value of SAR (measured) = 8.53 W/kg

**Configuration/SystemPerformanceCheck-D1750 Head/Zoom Scan (7x7x7)/Cube 0:**

Measurement grid:  $dx=5$ mm,  $dy=5$ mm,  $dz=5$ mm, Reference Value = 86.88 V/m; Power Drift = 0.11 dB Peak SAR (extrapolated) = 16.5 W/kg

**SAR(1 g) = 8.97 W/kg; SAR(10 g) = 4.72 W/kg** Maximum value of SAR (measured) = 10.1 W/kg

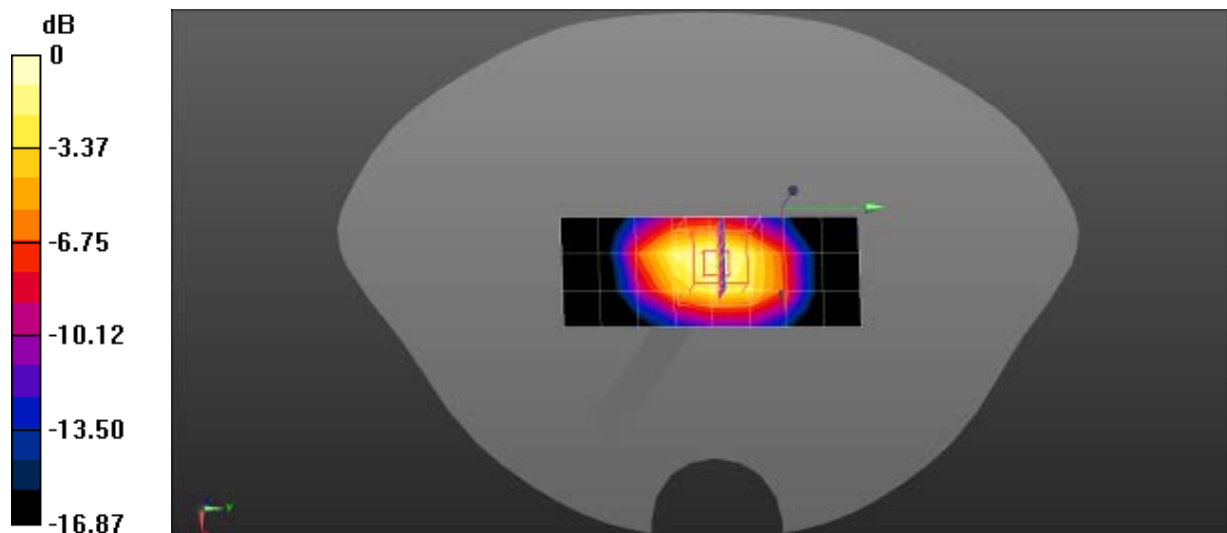

0 dB = 10.1 W/kg = 10.04 dBW/kg



Date/Time: 21/07/2014

Test Laboratory: CerpPASS Lab

SystemPerformanceCheck-D1900 Head

**DUT: Dipole 1900 MHz D1900V2; Type: D1900V2; Serial: D1900V2**

Communication System: CW; Frequency: 1900 MHz

Medium parameters used:  $f = 1900$  MHz;  $\sigma = 1.46$  S/m;  $\epsilon_r = 39.57$ ;  $\rho = 1000$  kg/m<sup>3</sup>

Phantom section: Flat Section; Meas. Ambient Temp (celsius) -22°C; Input power-250mW

Measurement Standard: DASYS (IEEE/IEC/ANSI C63.19-2007)

DASY Configuration:

- Probe: EX3DV4 - SN3927; ConvF(8.31, 8.31, 8.31); Calibrated: 2014/5/23;
- Sensor-Surface: 4mm (Mechanical Surface Detection),  $z = 1.0, 31.0$
- Electronics: DAE4 Sn1379; Calibrated: 2014/5/19
- Phantom: SAM (30deg probe tilt) with CRP v5.0; Type: QD000P40CD
- DASYS 52.8.8(1222); SEMCAD X 14.6.10(7331)

**Configuration/Systemcheck-D1900 Head/Area Scan (5x7x1):** Measurement grid:  $dx=15$ mm,  $dy=15$ mm, Maximum value of SAR (measured) = 11.2 W/kg

**Configuration/Systemcheck-D1900 Head/Zoom Scan (7x8x7)/Cube 0:** Measurement grid:  $dx=5$ mm,  $dy=5$ mm,  $dz=5$ mm, Reference Value = 128.7 V/m; Power Drift = 0.01 dB

Peak SAR (extrapolated) = 19.8 W/kg

**SAR(1 g) = 10.1 W/kg; SAR(10 g) = 5.13 W/kg** Maximum value of SAR (measured) = 11.3 W/kg

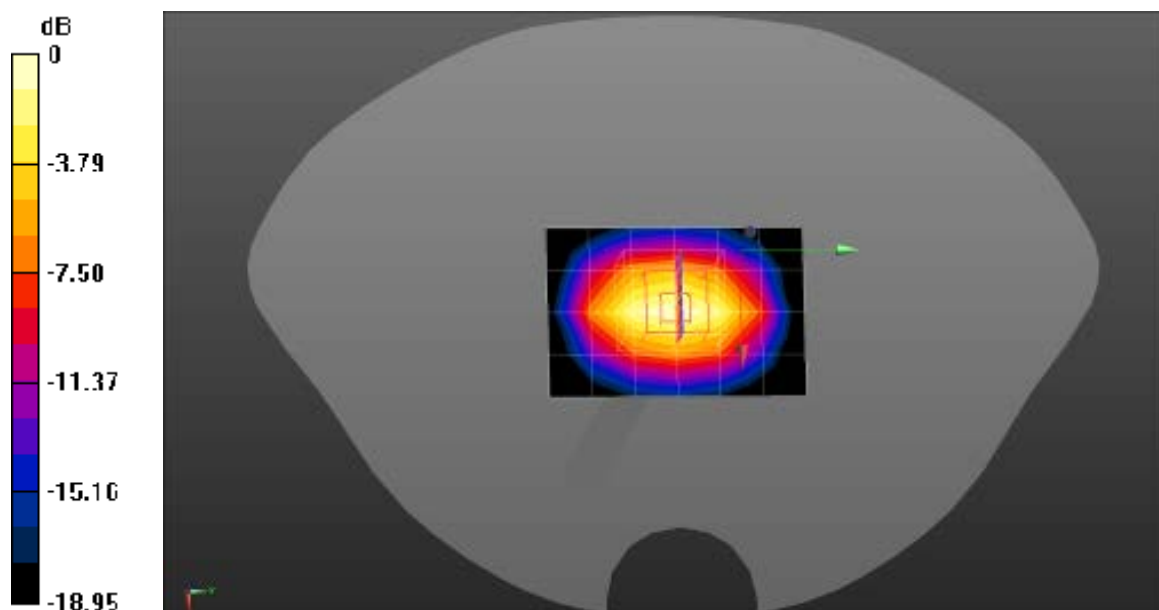

0 dB = 11.3 W/kg = 10.53 dBW/kg



Date/Time: 21/07/2014

Test Laboratory: CerpPASS Lab

SystemPerformanceCheck-D2450 Head

**DUT: Dipole 2450 MHz D2450V2; Type: D2450V2; Serial: D2450V2**

Communication System: CW; Frequency: 2450 MHz

Medium parameters used:  $f = 2450$  MHz;  $\sigma = 1.82$  S/m;  $\epsilon_r = 40.19$ ;  $\rho = 1000$  kg/m<sup>3</sup>

Phantom section: Flat Section; Meas. Ambient Temp (celsius) -22°C; Input power-250mW

Measurement Standard: DASYS (IEEE/IEC/ANSI C63.19-2011)

DASY Configuration:

- Probe: EX3DV4 - SN3927; ConvF(7.48, 7.48, 7.48); Calibrated: 2014/5/23;
- Sensor-Surface: 4mm (Mechanical Surface Detection),  $z = 1.0, 31.0$
- Electronics: DAE4 Sn1379; Calibrated: 2014/5/19
- Phantom: SAM (30deg probe tilt) with CRP v5.0; Type: QD000P40CD
- DASYS 52.8.8(1222); SEMCAD X 14.6.10(7331)

**Configuration/SystemPerformanceCheck-D2450 Head/Area Scan (4x6x1):** Measurement grid:  $dx=15$ mm,  $dy=15$ mm, Maximum value of SAR (measured) = 10.7 W/kg

**Configuration/SystemPerformanceCheck-D2450 Head/Zoom Scan (7x7x7)/Cube**

**0:** Measurement grid:  $dx=5$ mm,  $dy=5$ mm,  $dz=5$ mm, Reference Value = 90.18 V/m; Power Drift = 0.04 dB Peak SAR (extrapolated) = 28.0 W/kg

**SAR(1 g) = 13.1 W/kg; SAR(10 g) = 5.97 W/kg** Maximum value of SAR (measured) = 15.0 W/kg

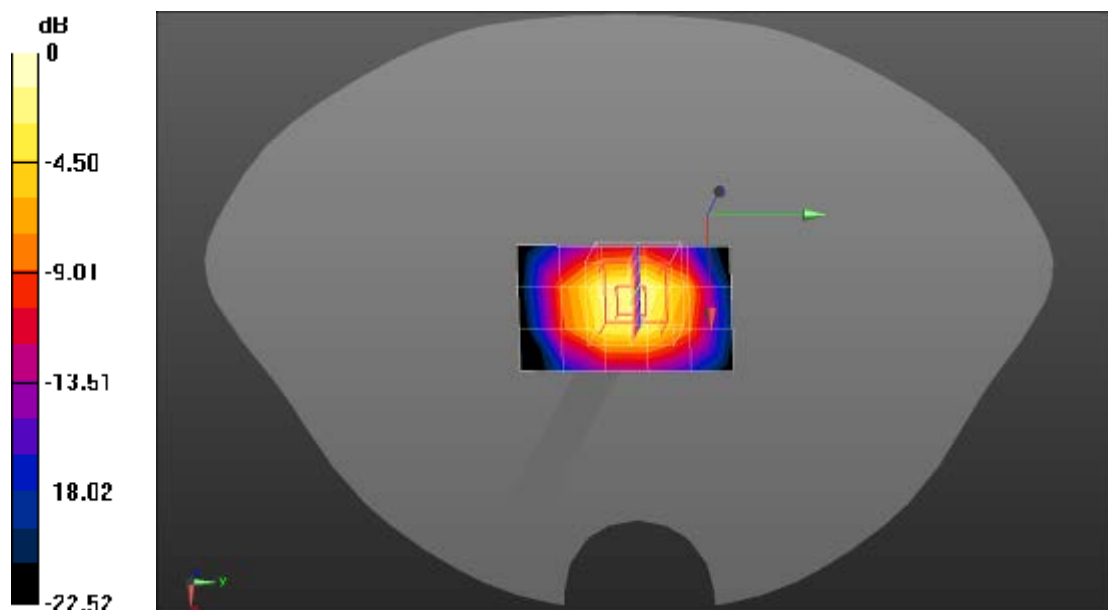

0 dB = 15.0 W/kg = 11.76 dBW/kg



Date/Time: 21/07/2014

Test Laboratory: CerpPASS Lab

SystemPerformanceCheck-D850 Body

**DUT: Dipole 850 MHz D850V2; Type: D850V2; Serial: D850V2**

Communication System: CW; Frequency: 850 MHz

Medium parameters used:  $f = 850 \text{ MHz}$ ;  $\sigma = 0.97 \text{ S/m}$ ;  $\epsilon_r = 55.61$ ;  $\rho = 1000 \text{ kg/m}^3$

Phantom section: Flat Section; Meas. Ambient Temp (celsius)  $-22^\circ\text{C}$ ; Input power-250mW

Measurement Standard: DASYS (IEEE/IEC/ANSI C63.19-2007)

DASY Configuration:

- Probe: EX3DV4 - SN3927; ConvF(9.91, 9.91, 9.91); Calibrated: 2014/5/23;
- Sensor-Surface: 4mm (Mechanical Surface Detection),  $z = 1.0, 31.0$
- Electronics: DAE4 Sn1379; Calibrated: 2014/5/19
- Phantom: SAM (30deg probe tilt) with CRP v5.0; Type: QD000P40CD
- DASYS 52.8.8(1222); SEMCAD X 14.6.10(7331)

**System Performance Check at Frequencies above 1 GHz/Systemcheck-D850 Body/Area Scan (5x13x1):** Measurement grid:  $dx=15\text{mm}$ ,  $dy=15\text{mm}$ , Maximum value of SAR (measured) = 3.21 W/kg

**System Performance Check at Frequencies above 1 GHz/Systemcheck-D850 Body/Zoom Scan (5x5x7)/Cube 0:** Measurement grid:  $dx=8\text{mm}$ ,  $dy=8\text{mm}$ ,  $dz=5\text{mm}$ , Reference Value = 40.83 V/m; Power Drift = 0.06 dB Peak SAR (extrapolated) = 3.77 W/kg

**SAR(1 g) = 2.52 W/kg; SAR(10 g) = 1.61 W/kg** Maximum value of SAR (measured) = 3.22 W/kg

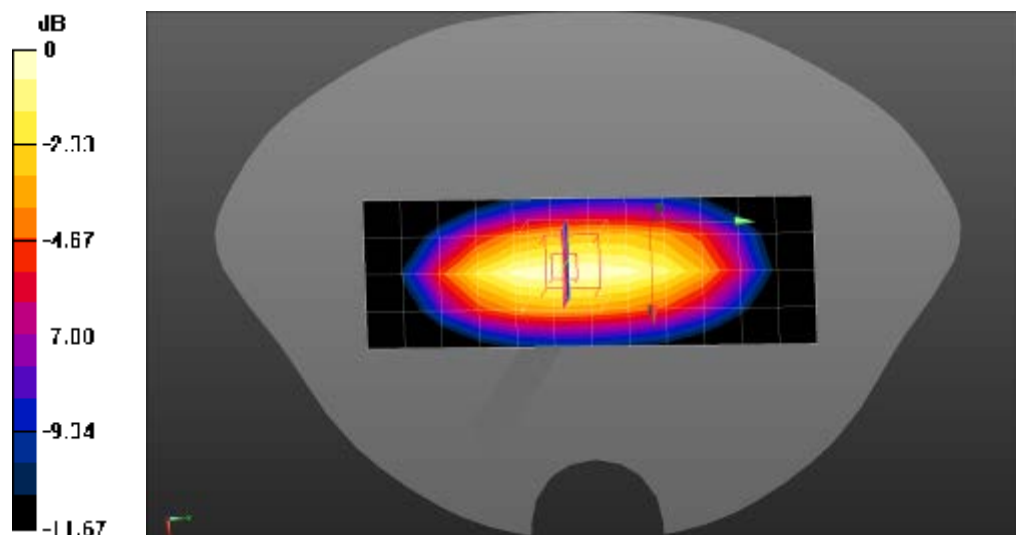

0 dB = 3.22 W/kg = 5.08 dBW/kg



Date/Time: 21/07/2014

Test Laboratory: CerpPASS Lab

SystemPerformanceCheck-D1750 Body

**DUT: Dipole 1750 MHz D1750V2; Type: D1750V2; Serial: D1750V2**

Communication System: CW; Frequency: 1750 MHz

Medium parameters used:  $f = 1750$  MHz;  $\sigma = 1.48$  S/m;  $\epsilon_r = 53.03$ ;  $\rho = 1000$  kg/m<sup>3</sup>

Phantom section: Flat Section ; Meas. Ambient Temp (celsius) -22°C; Input power-250mW

Measurement Standard: DASYS (IEEE/IEC/ANSI C63.19-2011)

DASY Configuration:

- Probe: EX3DV4 - SN3927; ConvF(8.45, 8.45, 8.45); Calibrated: 2014/5/23;
- Sensor-Surface: 4mm (Mechanical Surface Detection),  $z = 1.0, 31.0$
- Electronics: DAE4 Sn1379; Calibrated: 2014/5/19
- Phantom: SAM (30deg probe tilt) with CRP v5.0; Type: QD000P40CD
- DASYS52 52.8.8(1222); SEMCAD X 14.6.10(7331)

**Configuration/SystemPerformanceCheck-D1750 Body/Area Scan (4x9x1):** Measurement grid:  $dx=15$ mm,  $dy=15$ mm, Maximum value of SAR (measured) = 8.19 W/kg

**Configuration/SystemPerformanceCheck-D1750 Body/Zoom Scan (7x7x7)/Cube 0:** Measurement grid:  $dx=5$ mm,  $dy=5$ mm,  $dz=5$ mm, Reference Value = 87.92 V/m; Power Drift = 0.05 dB Peak SAR (extrapolated) = 17.4 W/kg

**SAR(1 g) = 9.35 W/kg; SAR(10 g) = 4.89 W/kg** Maximum value of SAR (measured) = 10.5 W/kg

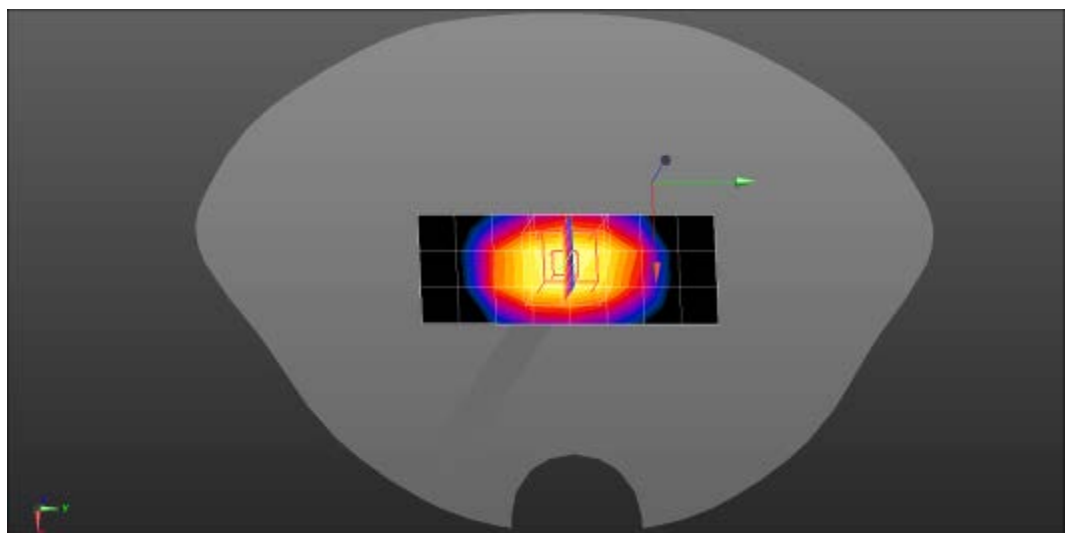
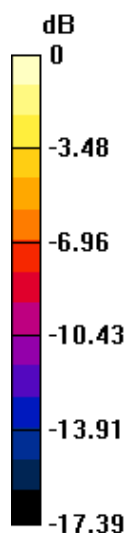

0 dB = 10.5 W/kg = 10.21 dBW/kg





Date/Time: 21/07/2014

Test Laboratory: CerpPASS Lab

SystemPerformanceCheck-D1900 Body

**DUT: Dipole 1900 MHz D1900V2; Type: D1900V2; Serial: D1900V2**

Communication System: CW; Frequency: 1900 MHz

Medium parameters used:  $f = 1900$  MHz;  $\sigma = 1.54$  S/m;  $\epsilon_r = 51.08$ ;  $\rho = 1000$  kg/m<sup>3</sup>

Phantom section: Flat Section; Meas. Ambient Temp (celsius) -22°C; Input power-250mW

Measurement Standard: DASYS (IEEE/IEC/ANSI C63.19-2007)

DASY Configuration:

- Probe: EX3DV4 - SN3927; ConvF(8.1, 8.1, 8.1); Calibrated: 2014/5/23;
- Sensor-Surface: 4mm (Mechanical Surface Detection),  $z = 1.0, 31.0$
- Electronics: DAE4 Sn1379; Calibrated: 2014/5/19
- Phantom: SAM (30deg probe tilt) with CRP v5.0; Type: QD000P40CD
- DASYS 52.8.8(1222); SEMCAD X 14.6.10(7331)

**System Performance Check at Frequencies above 1 GHz/Systemcheck-D1900 Body/Area Scan**

**(5x7x1):** Measurement grid:  $dx=15$ mm,  $dy=15$ mm, Maximum value of SAR (measured) = 14.1 W/kg

**System Performance Check at Frequencies above 1 GHz/Systemcheck-D1900 Body/Zoom**

**Scan (7x7x7)/Cube 0:** Measurement grid:  $dx=5$ mm,  $dy=5$ mm,  $dz=5$ mm, Reference Value = 95.64

V/m; Power Drift = 0.13 dB Peak SAR (extrapolated) = 17.8 W/kg

**SAR(1 g) = 9.84 W/kg; SAR(10 g) = 5.11 W/kg**

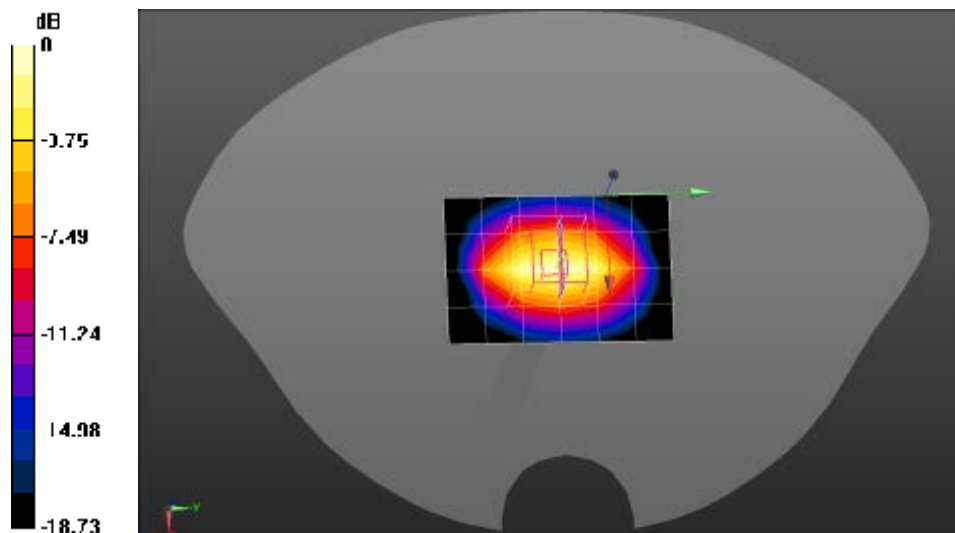

0 dB = 14.1 W/kg = 11.49 dBW/kg





Date/Time: 21/07/2014

Test Laboratory: CerpPASS Lab

SystemPerformanceCheck-D2450 Body2014721

**DUT: Dipole 2450 MHz D2450V2; Type: D2450V2; Serial: D2450V2**

Communication System: CW; Frequency: 2450 MHz

Medium parameters used:  $f = 2450$  MHz;  $\sigma = 1.96$  S/m;  $\epsilon_r = 50.84$ ;  $\rho = 1000$  kg/m<sup>3</sup>

Phantom section: Flat Section; Meas. Ambient Temp (celsius) -22°C; Input power-250mW

Measurement Standard: DASYS (IEEE/IEC/ANSI C63.19-2011)

DASY Configuration:

- Probe: EX3DV4 - SN3927; ConvF(7.63, 7.63, 7.63); Calibrated: 2014/5/23;
- Sensor-Surface: 4mm (Mechanical Surface Detection),  $z = 1.0, 31.0$
- Electronics: DAE4 Sn1379; Calibrated: 2014/5/19
- Phantom: SAM (30deg probe tilt) with CRP v5.0; Type: QD000P40CD
- DASYS 52.8.8(1222); SEMCAD X 14.6.10(7331)

**Configuration/SystemPerformanceCheck-D2450 Body/Area Scan (4x6x1):** Measurement grid:  $dx=15$ mm,  $dy=15$ mm, Maximum value of SAR (measured) = 10.3 W/kg

**Configuration/SystemPerformanceCheck-D2450 Body/Zoom Scan (7x7x7)/Cube**

**0:** Measurement grid:  $dx=5$ mm,  $dy=5$ mm,  $dz=5$ mm, Reference Value = 89.29 V/m; Power Drift = 0.04 dB Peak SAR (extrapolated) = 27.2 W/kg

**SAR(1 g) = 12.7 W/kg; SAR(10 g) = 5.79 W/kg** Maximum value of SAR (measured) = 14.6 W/kg

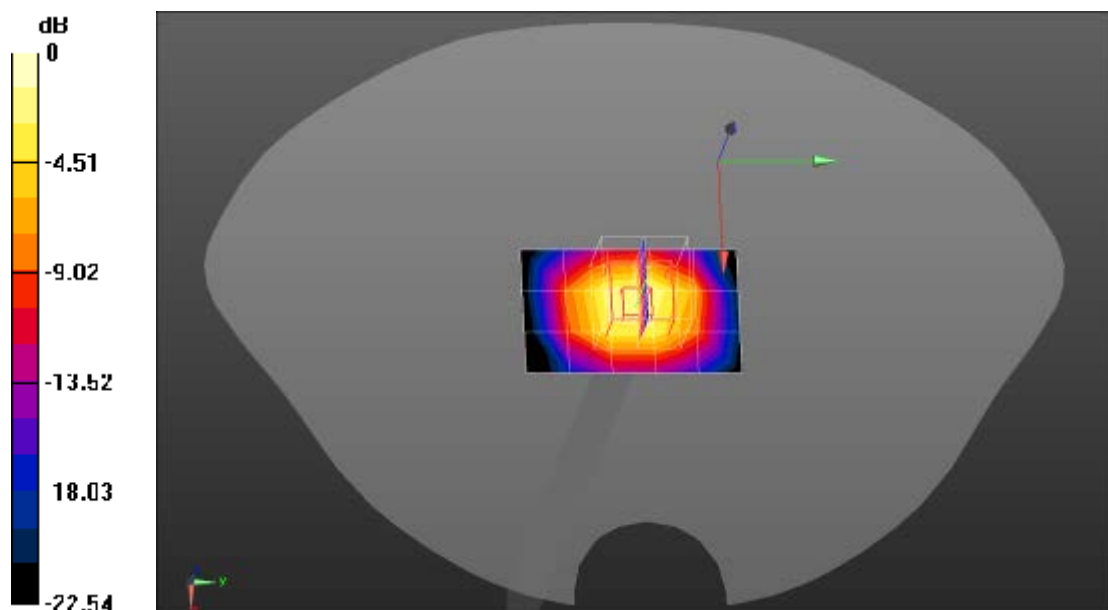

0 dB = 14.6 W/kg = 11.64 dBW/kg



## 9. APPENDIX B. SAR measurement Data

Date/Time: 21/07/2014

Test Laboratory: CerpPASS Lab

DUT: Mobile Phone; Type: D554P, DxxxP(xxx: stand for 0~9)

**Procedure Name: GSM850MHz Mid Touch-Left**

Communication System Band: GSM850MHz ; Frequency: 836.6 MHz; Duty Cycle: 1:8.3

Medium parameters used:  $f = 836.6$  MHz;  $\sigma = 0.89$  S/m;  $\epsilon_r = 41.48$ ;  $\rho = 1000$  kg/m<sup>3</sup>

Phantom section: Left Section; Tissue Temp (celsius) - 21°C

Measurement Standard: DASYS (IEEE/IEC/ANSI C63.19-2011)

DASY5 Configuration:

- Probe: EX3DV4 - SN3927; ConvF(10.23, 10.23, 10.23); Calibrated: 2014/5/23;
- Sensor-Surface: 4mm (Mechanical Surface Detection)
- Electronics: DAE4 Sn1379; Calibrated: 2014/5/19
- Phantom: SAM (30deg probe tilt) with CRP v5.0; Type: QD000P40CD
- Measurement SW: DASY52, Version 52.8 (8);

**Configuration/GSM850MHz Mid Touch-Left/Area Scan (8x13x1):** Measurement grid: dx=15mm, dy=15mm, Maximum value of SAR (measured) = 0.00797 W/kg**Configuration/GSM850MHz Mid Touch-Left/Zoom Scan (5x5x7)/Cube 0:** Measurement grid: dx=8mm, dy=8mm, dz=5mm, Reference Value = 0 V/m; Power Drift = 0.07 dB

Peak SAR (extrapolated) = 0.00884 W/kg

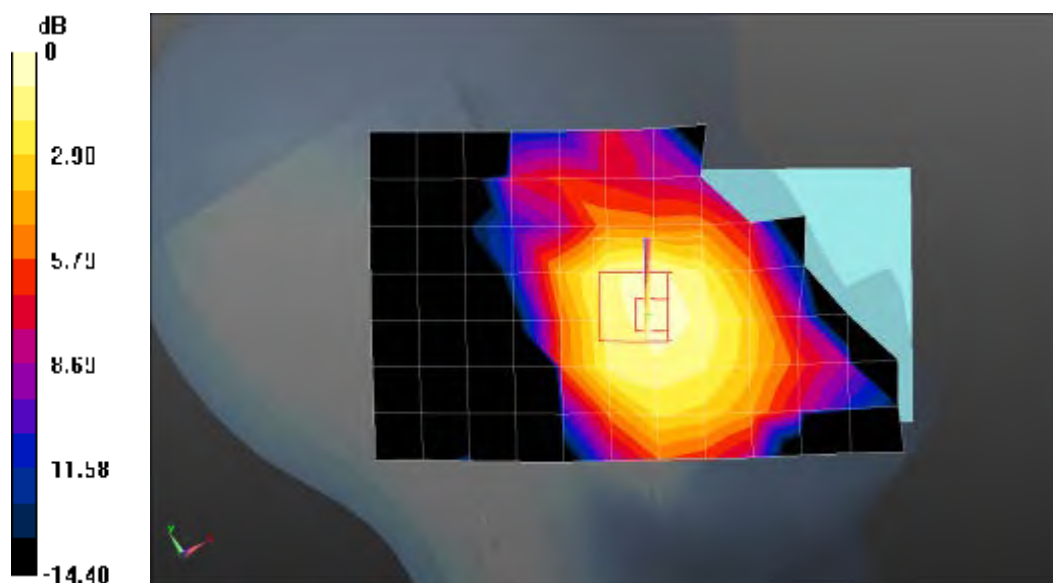
**SAR(1 g) = 0.00821 W/kg; SAR(10 g) = 0.00661 W/kg** Maximum value of SAR (measured) = 0.00859 W/kg

0 dB = 0.00859 W/kg = -20.66 dBW/kg



Test Laboratory: CerpPASS Lab

DUT: Mobile Phone; Type: D554P, DxxxP(xxx: stand for 0~9)

**Procedure Name: GSM850MHz Mid Tilt-Left**

Communication System Band: GSM850MHz ; Frequency: 836.6 MHz; Duty Cycle: 1:8.3

Medium parameters used:  $f = 836.6$  MHz;  $\sigma = 0.89$  S/m;  $\epsilon_r = 41.48$ ;  $\rho = 1000$  kg/m<sup>3</sup>

Phantom section: Left Section; Tissue Temp (celsius) - 21°C

Measurement Standard: DASYS (IEEE/IEC/ANSI C63.19-2011)

DASY5 Configuration:

- Probe: EX3DV4 - SN3927; ConvF(10.23, 10.23, 10.23); Calibrated: 2014/5/23;
- Sensor-Surface: 4mm (Mechanical Surface Detection)
- Electronics: DAE4 Sn1379; Calibrated: 2014/5/19
- Phantom: SAM (30deg probe tilt) with CRP v5.0; Type: QD000P40CD
- Measurement SW: DASYS2, Version 52.8 (8);

**Configuration/GSM850MHz Mid Tilt-Left/Area Scan (8x13x1):** Measurement grid: dx=15mm, dy=15mm, Maximum value of SAR (measured) = 0.00341 W/kg

**Configuration/GSM850MHz Mid Tilt-Left/Zoom Scan (5x5x7)/Cube 0:** Measurement grid: dx=8mm, dy=8mm, dz=5mm, Reference Value = 0.7930 V/m; Power Drift = 0.19 dB

Peak SAR (extrapolated) = 0.00340 W/kg

**SAR(1 g) = 0.00272 W/kg; SAR(10 g) = 0.00212 W/kg** Maximum value of SAR (measured) = 0.00296 W/kg

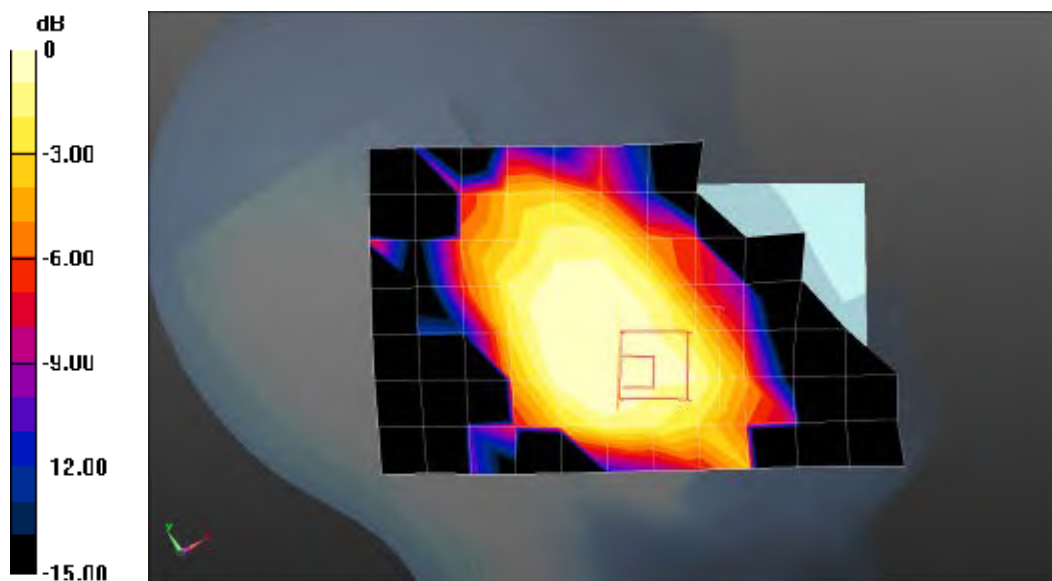

0 dB = 0.00296 W/kg = -25.29 dBW/kg



Test Laboratory: CerpPASS Lab

DUT: Mobile Phone; Type: D554P, DxxxP(xxx: stand for 0~9)

**Procedure Name: GSM850MHz Mid Touch-Right**

Communication System Band: GSM850MHz ; Frequency: 836.6 MHz; Duty Cycle: 1:8.3

Medium parameters used:  $f = 836.6$  MHz;  $\sigma = 0.89$  S/m;  $\epsilon_r = 41.48$ ;  $\rho = 1000$  kg/m<sup>3</sup>

Phantom section: Right Section; Tissue Temp (celsius) - 21°C

Measurement Standard: DASYS (IEEE/IEC/ANSI C63.19-2011)

DASY5 Configuration:

- Probe: EX3DV4 - SN3927; ConvF(10.23, 10.23, 10.23); Calibrated: 2014/5/23;
- Sensor-Surface: 4mm (Mechanical Surface Detection)
- Electronics: DAE4 Sn1379; Calibrated: 2014/5/19
- Phantom: SAM (30deg probe tilt) with CRP v5.0; Type: QD000P40CD
- Measurement SW: DASY52, Version 52.8 (8);

**Configuration/GSM850MHz Mid Touch-Right/Area Scan (8x13x1):** Measurement grid: dx=15mm, dy=15mm, Maximum value of SAR (measured) = 0.00887 W/kg

**Configuration/GSM850MHz Mid Touch-Right/Zoom Scan (5x5x7)/Cube 0:** Measurement grid: dx=8mm, dy=8mm, dz=5mm, Reference Value = 0.4360 V/m; Power Drift = -0.13 dB

Peak SAR (extrapolated) = 0.00811 W/kg

**SAR(1 g) = 0.00682 W/kg; SAR(10 g) = 0.00533 W/kg** Maximum value of SAR (measured) = 0.00711 W/kg

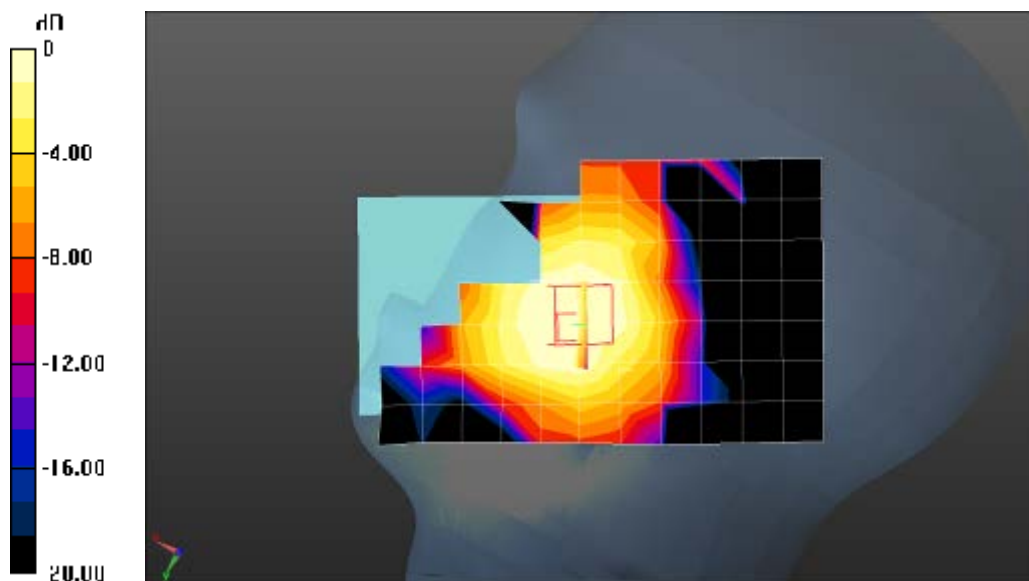

0 dB = 0.00711 W/kg = -21.48 dBW/kg



Test Laboratory: CerpPASS Lab

DUT: Mobile Phone; Type: D554P, DxxxP(xxx: stand for 0~9)

**Procedure Name: GSM850MHz Mid Tilt-Right**

Communication System Band: GSM850MHz ; Frequency: 836.6 MHz; Duty Cycle: 1:8.3

Medium parameters used:  $f = 836.6$  MHz;  $\sigma = 0.89$  S/m;  $\epsilon_r = 41.48$ ;  $\rho = 1000$  kg/m<sup>3</sup>

Phantom section: Right Section; Tissue Temp (celsius) - 21°C

Measurement Standard: DASYS (IEEE/IEC/ANSI C63.19-2011)

DASY5 Configuration:

- Probe: EX3DV4 - SN3927; ConvF(10.23, 10.23, 10.23); Calibrated: 2014/5/23;
- Sensor-Surface: 4mm (Mechanical Surface Detection)
- Electronics: DAE4 Sn1379; Calibrated: 2014/5/19
- Phantom: SAM (30deg probe tilt) with CRP v5.0; Type: QD000P40CD
- Measurement SW: DASY52, Version 52.8 (8);

**Configuration/GSM850MHz Mid Tilt-Right/Area Scan (8x13x1):** Measurement grid: dx=15mm, dy=15mm, Maximum value of SAR (measured) = 0.00297 W/kg

**Configuration/GSM850MHz Mid Tilt-Right/Zoom Scan (5x5x7)/Cube 0:** Measurement grid: dx=8mm, dy=8mm, dz=5mm, Reference Value = 0 V/m; Power Drift = 0.09 dB

Peak SAR (extrapolated) = 0.00349 W/kg

**SAR(1 g) = 0.00277 W/kg; SAR(10 g) = 0.00216 W/kg** Maximum value of SAR (measured) = 0.00311 W/kg

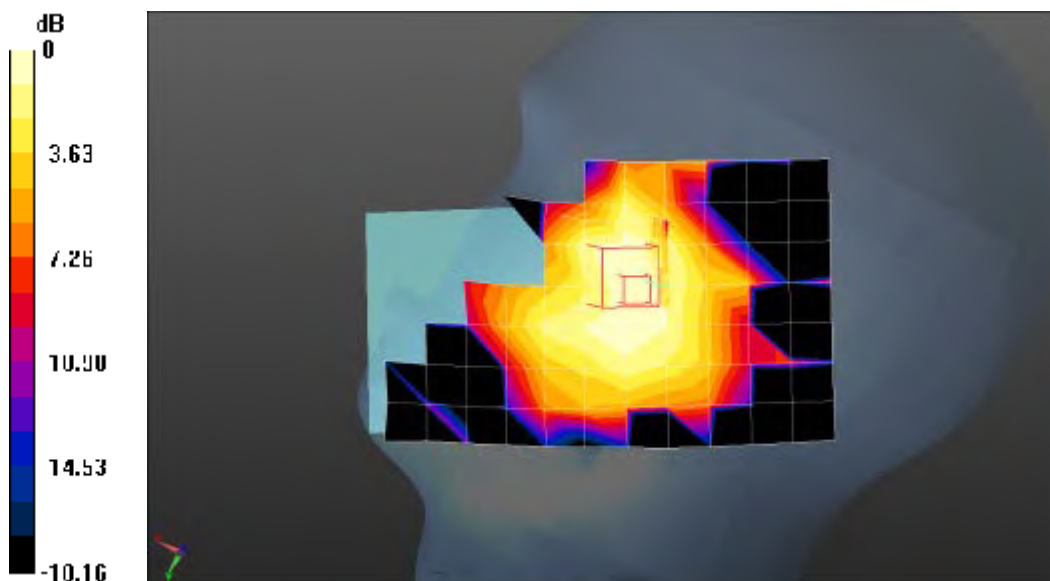

0 dB = 0.00311 W/kg = -25.07 dBW/kg



Date/Time: 21/07/2014

Test Laboratory: CerpPASS Lab

DUT: Mobile Phone; Type: D554P, DxxxP(xxx: stand for 0~9)

**Procedure Name: GSM850MHz Mid Touch-Left<SIM2>**

Communication System Band: GSM850MHz ; Frequency: 836.6 MHz; Duty Cycle: 1:8.3

Medium parameters used:  $f = 836.6$  MHz;  $\sigma = 0.89$  S/m;  $\epsilon_r = 41.48$ ;  $\rho = 1000$  kg/m<sup>3</sup>

Phantom section: Left Section; Tissue Temp (celsius) - 21°C

Measurement Standard: DASYS (IEEE/IEC/ANSI C63.19-2011)

DASY5 Configuration:

- Probe: EX3DV4 - SN3927; ConvF(10.23, 10.23, 10.23); Calibrated: 2014/5/23;
- Sensor-Surface: 4mm (Mechanical Surface Detection)
- Electronics: DAE4 Sn1379; Calibrated: 2014/5/19
- Phantom: SAM (30deg probe tilt) with CRP v5.0; Type: QD000P40CD
- Measurement SW: DASYS2, Version 52.8 (8);

**Configuration/GSM850MHz Mid Touch-Left/Area Scan (8x13x1):** Measurement grid: dx=15mm, dy=15mm, Maximum value of SAR (measured) = 0.00787 W/kg

**Configuration/GSM850MHz Mid Touch-Left/Zoom Scan (5x5x7)/Cube 0:** Measurement grid: dx=8mm, dy=8mm, dz=5mm, Reference Value = 0 V/m; Power Drift = 0.11 dB

Peak SAR (extrapolated) = 0.00935 W/kg

**SAR(1 g) = 0.00806 W/kg; SAR(10 g) = 0.00664 W/kg** Maximum value of SAR (measured) = 0.00833 W/kg

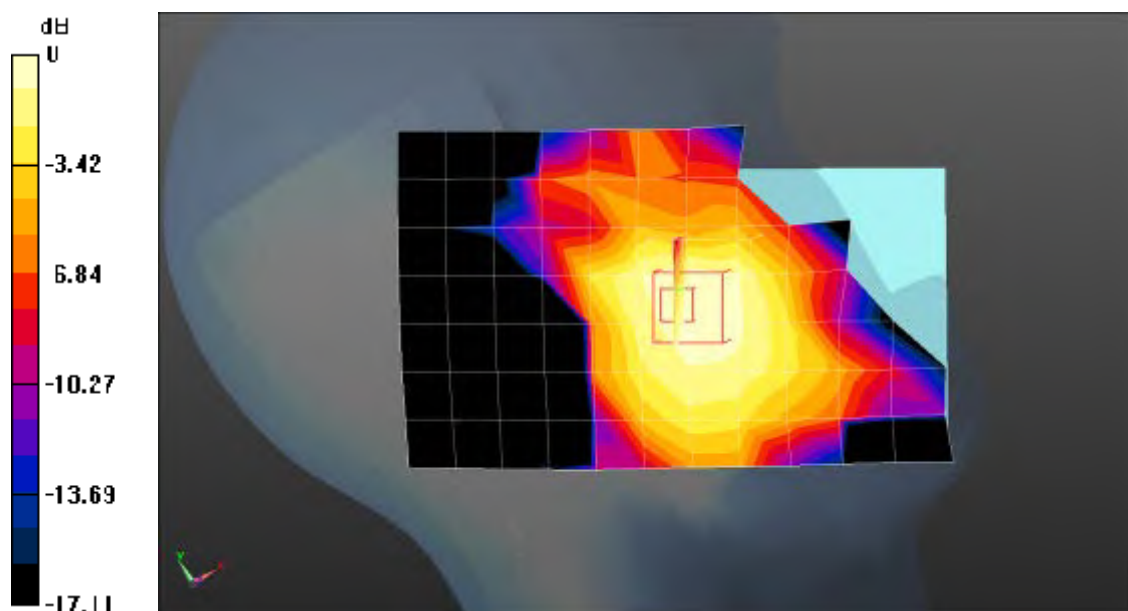

0 dB = 0.00833 W/kg = -20.79 dBW/kg





Test Laboratory: CerpPASS Lab

DUT: Mobile Phone; Type: D554P, DxxxP(xxx: stand for 0~9)

**Procedure Name: GSM850MHz Mid Body-Back**

Communication System Band: GSM850MHz ; Frequency: 836.6 MHz; Duty Cycle: 1:8.3

Medium parameters used:  $f = 836.6$  MHz;  $\sigma = 0.96$  S/m;  $\epsilon_r = 55.86$ ;  $\rho = 1000$  kg/m<sup>3</sup>

Phantom section: Flat Section; Tissue Temp (celsius) - 21°C

Measurement Standard: DASYS (IEEE/IEC/ANSI C63.19-2011)

DASY5 Configuration:

- Probe: EX3DV4 - SN3927; ConvF(9.91, 9.91, 9.91); Calibrated: 2014/5/23;
- Sensor-Surface: 4mm (Mechanical Surface Detection)
- Electronics: DAE4 Sn1379; Calibrated: 2014/5/19
- Phantom: SAM (30deg probe tilt) with CRP v5.0; Type: QD000P40CD
- Measurement SW: DASY52, Version 52.8 (8);

**Configuration/GSM850MHz Mid Body-Back/Area Scan (8x12x1):** Measurement grid: dx=15mm, dy=15mm, Maximum value of SAR (measured) = 0.143 W/kg

**Configuration/GSM850MHz Mid Body-Back/Zoom Scan (5x5x7)/Cube 0:** Measurement grid: dx=8mm, dy=8mm, dz=5mm, Reference Value = 3.209 V/m; Power Drift = 0.01 dB

Peak SAR (extrapolated) = 0.223 W/kg

**SAR(1 g) = 0.127 W/kg; SAR(10 g) = 0.068 W/kg** Maximum value of SAR (measured) = 0.142 W/kg

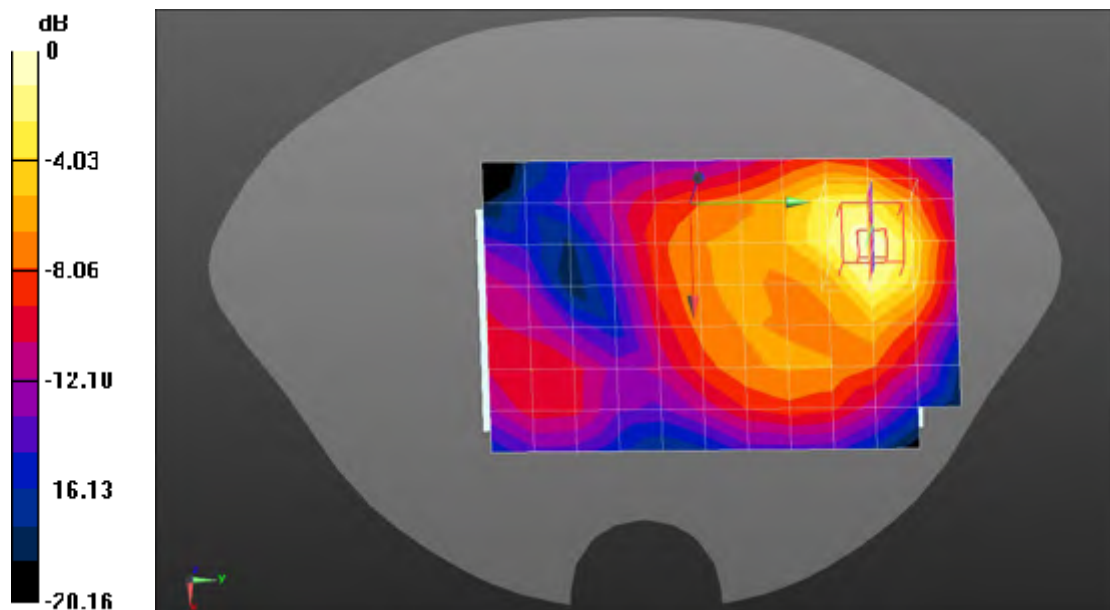

0 dB = 0.142 W/kg = -8.48 dBW/kg



Test Laboratory: CerpPASS Lab

DUT: Mobile Phone; Type: D554P, DxxxP(xxx: stand for 0~9)

**Procedure Name: GPRS850MHz Mid Body-Back(4up)**

Communication System Band: GPRS850MHz(4up); Frequency: 836.6 MHz; Duty Cycle: 1:2.1

Medium parameters used:  $f = 836.6 \text{ MHz}$ ;  $\sigma = 0.96 \text{ S/m}$ ;  $\epsilon_r = 55.86$ ;  $\rho = 1000 \text{ kg/m}^3$

Phantom section: Flat Section; Tissue Temp (celsius) -  $21^\circ\text{C}$

Measurement Standard: DASYS (IEEE/IEC/ANSI C63.19-2011)

DASY5 Configuration:

- Probe: EX3DV4 - SN3927; ConvF(9.91, 9.91, 9.91); Calibrated: 2014/5/23;
- Sensor-Surface: 4mm (Mechanical Surface Detection)
- Electronics: DAE4 Sn1379; Calibrated: 2014/5/19
- Phantom: SAM (30deg probe tilt) with CRP v5.0; Type: QD000P40CD
- Measurement SW: DASY52, Version 52.8 (8);

**Configuration/GPRS850MHz Mid Body-Back(4up)/Area Scan (8x12x1):** Measurement grid:

$dx=15\text{mm}$ ,  $dy=15\text{mm}$ , Maximum value of SAR (measured) =  $0.237 \text{ W/kg}$

**Configuration/GPRS850MHz Mid Body-Back(4up)/Zoom Scan (5x5x7)/Cube 0:** Measurement

grid:  $dx=8\text{mm}$ ,  $dy=8\text{mm}$ ,  $dz=5\text{mm}$ , Reference Value =  $3.648 \text{ V/m}$ ; Power Drift =  $0.11 \text{ dB}$

Peak SAR (extrapolated) =  $0.385 \text{ W/kg}$

**SAR(1 g) =  $0.212 \text{ W/kg}$ ; SAR(10 g) =  $0.109 \text{ W/kg}$**  Maximum value of SAR (measured) =  $0.240 \text{ W/kg}$

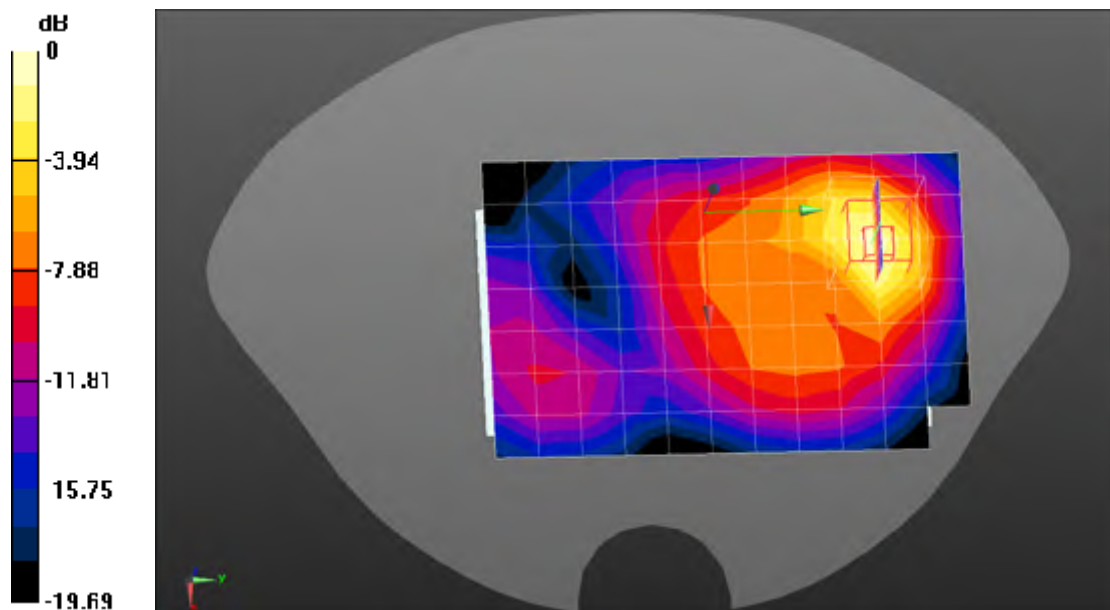

0 dB =  $0.240 \text{ W/kg}$  =  $-6.20 \text{ dBW/kg}$





Z-Axis Plot

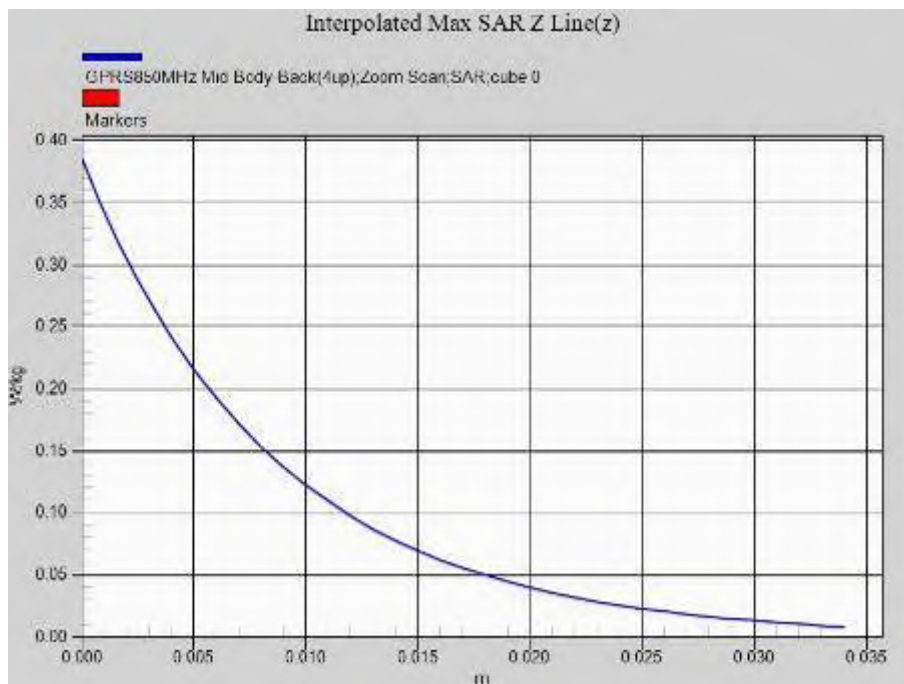



Test Laboratory: CerpPASS Lab

DUT: Mobile Phone; Type: D554P, DxxxP(xxx: stand for 0~9)

**Procedure Name: GPRS850MHz Mid Body-Front(4up)**

Communication System Band: GPRS850MHz(4up); Frequency: 836.6 MHz; Duty Cycle: 1:2.1

Medium parameters used:  $f = 836.6 \text{ MHz}$ ;  $\sigma = 0.96 \text{ S/m}$ ;  $\epsilon_r = 55.86$ ;  $\rho = 1000 \text{ kg/m}^3$

Phantom section: Flat Section; Tissue Temp (celsius) -  $21^\circ\text{C}$

Measurement Standard: DASYS (IEEE/IEC/ANSI C63.19-2011)

DASY5 Configuration:

- Probe: EX3DV4 - SN3927; ConvF(9.91, 9.91, 9.91); Calibrated: 2014/5/23;
- Sensor-Surface: 4mm (Mechanical Surface Detection)
- Electronics: DAE4 Sn1379; Calibrated: 2014/5/19
- Phantom: SAM (30deg probe tilt) with CRP v5.0; Type: QD000P40CD
- Measurement SW: DASYS2, Version 52.8 (8);

**Configuration/GPRS850MHz Mid Body-Front(4up)/Area Scan (8x12x1):** Measurement grid:

$dx=15\text{mm}$ ,  $dy=15\text{mm}$ , Maximum value of SAR (measured) =  $0.165 \text{ W/kg}$

**Configuration/GPRS850MHz Mid Body-Front(4up)/Zoom Scan (5x5x7)/Cube 0:** Measurement

grid:  $dx=8\text{mm}$ ,  $dy=8\text{mm}$ ,  $dz=5\text{mm}$ , Reference Value =  $3.190 \text{ V/m}$ ; Power Drift =  $0.06 \text{ dB}$

Peak SAR (extrapolated) =  $0.273 \text{ W/kg}$

**SAR(1 g) =  $0.146 \text{ W/kg}$ ; SAR(10 g) =  $0.075 \text{ W/kg}$**  Maximum value of SAR (measured) =  $0.160 \text{ W/kg}$

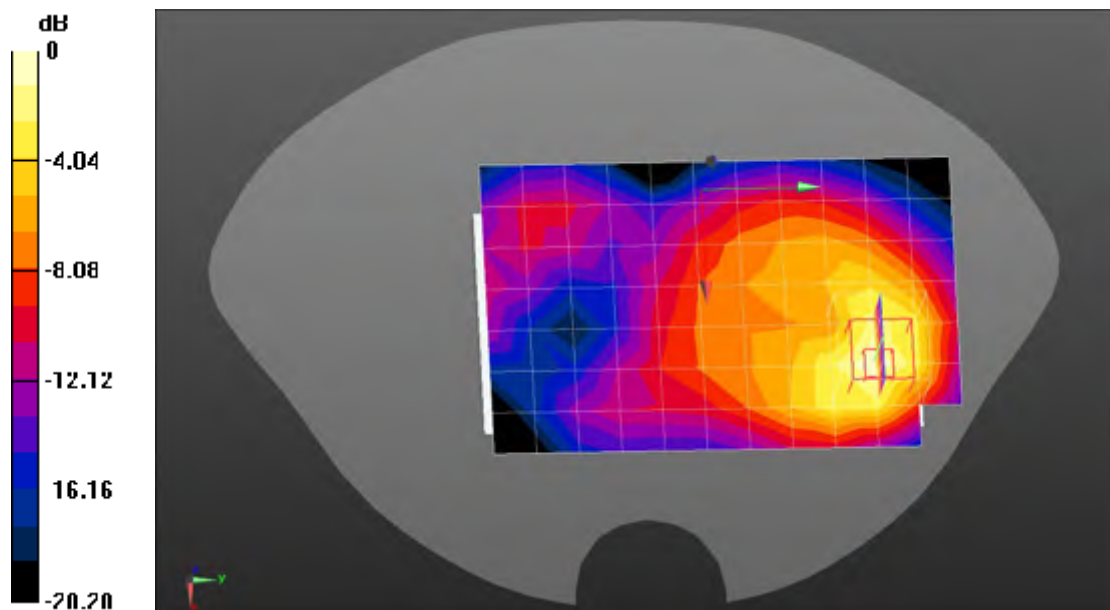

0 dB =  $0.160 \text{ W/kg}$  =  $-7.96 \text{ dBW/kg}$



Test Laboratory: CerpPASS Lab

DUT: Mobile Phone; Type: D554P, DxxxP(xxx: stand for 0~9)

**Procedure Name: GPRS850MHz Mid Body-Leftside(4up)**

Communication System Band: GPRS850MHz(4up); Frequency: 836.6 MHz; Duty Cycle: 1:2.1

Medium parameters used:  $f = 836.6 \text{ MHz}$ ;  $\sigma = 0.96 \text{ S/m}$ ;  $\epsilon_r = 55.86$ ;  $\rho = 1000 \text{ kg/m}^3$

Phantom section: Flat Section; Tissue Temp (celsius) -  $21^\circ\text{C}$

Measurement Standard: DASYS (IEEE/IEC/ANSI C63.19-2011)

DASY5 Configuration:

- Probe: EX3DV4 - SN3927; ConvF(9.91, 9.91, 9.91); Calibrated: 2014/5/23;
- Sensor-Surface: 4mm (Mechanical Surface Detection)
- Electronics: DAE4 Sn1379; Calibrated: 2014/5/19
- Phantom: SAM (30deg probe tilt) with CRP v5.0; Type: QD000P40CD
- Measurement SW: DASYS2, Version 52.8 (8);

**Configuration/GPRS850MHz Mid Body-Leftside(4up)/Area Scan (5x12x1):** Measurement grid:

$dx=15\text{mm}$ ,  $dy=15\text{mm}$ , Maximum value of SAR (measured) =  $0.0660 \text{ W/kg}$

**Configuration/GPRS850MHz Mid Body-Leftside(4up)/Zoom Scan (5x5x7)/Cube 0:** Measurement

grid:  $dx=8\text{mm}$ ,  $dy=8\text{mm}$ ,  $dz=5\text{mm}$ , Reference Value =  $5.932 \text{ V/m}$ ; Power Drift =  $-0.16 \text{ dB}$

Peak SAR (extrapolated) =  $0.103 \text{ W/kg}$

**SAR(1 g) =  $0.060 \text{ W/kg}$ ; SAR(10 g) =  $0.035 \text{ W/kg}$**  Maximum value of SAR (measured) =  $0.0661 \text{ W/kg}$

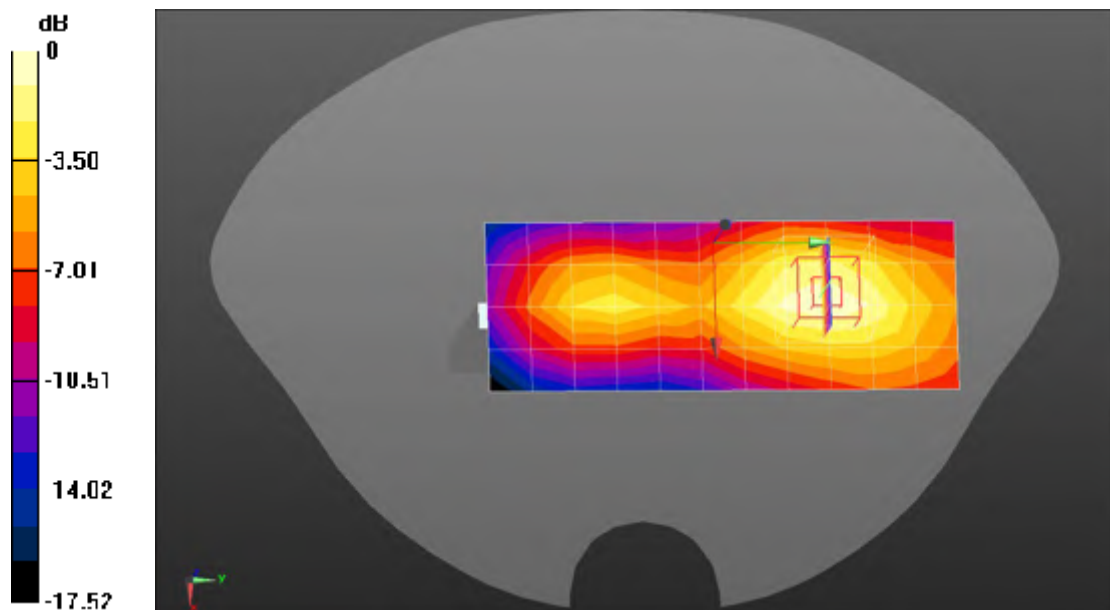

0 dB =  $0.0661 \text{ W/kg} = -11.80 \text{ dBW/kg}$



Test Laboratory: CerpPASS Lab

DUT: Mobile Phone; Type: D554P, DxxxP(xxx: stand for 0~9)

**Procedure Name: GPRS850MHz Mid Body-Rightside(4up)**

Communication System Band: GPRS850MHz(4up); Frequency: 836.6 MHz; Duty Cycle: 1:2.1

Medium parameters used:  $f = 836.6$  MHz;  $\sigma = 0.96$  S/m;  $\epsilon_r = 55.86$ ;  $\rho = 1000$  kg/m<sup>3</sup>

Phantom section: Flat Section; Tissue Temp (celsius) - 21°C

Measurement Standard: DASYS (IEEE/IEC/ANSI C63.19-2011)

DASY5 Configuration:

- Probe: EX3DV4 - SN3927; ConvF(9.91, 9.91, 9.91); Calibrated: 2014/5/23;
- Sensor-Surface: 4mm (Mechanical Surface Detection)
- Electronics: DAE4 Sn1379; Calibrated: 2014/5/19
- Phantom: SAM (30deg probe tilt) with CRP v5.0; Type: QD000P40CD
- Measurement SW: DASY52, Version 52.8 (8);

**Configuration/GPRS850MHz Mid Body-Rightside(4up)/Area Scan (5x12x1):** Measurement grid:

$dx=15$ mm,  $dy=15$ mm, Maximum value of SAR (measured) = 0.0340 W/kg

**Configuration/GPRS850MHz Mid Body-Rightside(4up)/Zoom Scan (5x5x7)/Cube**

**0:** Measurement grid:  $dx=8$ mm,  $dy=8$ mm,  $dz=5$ mm, Reference Value = 3.548 V/m; Power Drift =

-0.13 dB Peak SAR (extrapolated) = 0.0570 W/kg

**SAR(1 g) = 0.033 W/kg; SAR(10 g) = 0.019 W/kg** Maximum value of SAR (measured) = 0.0365 W/kg

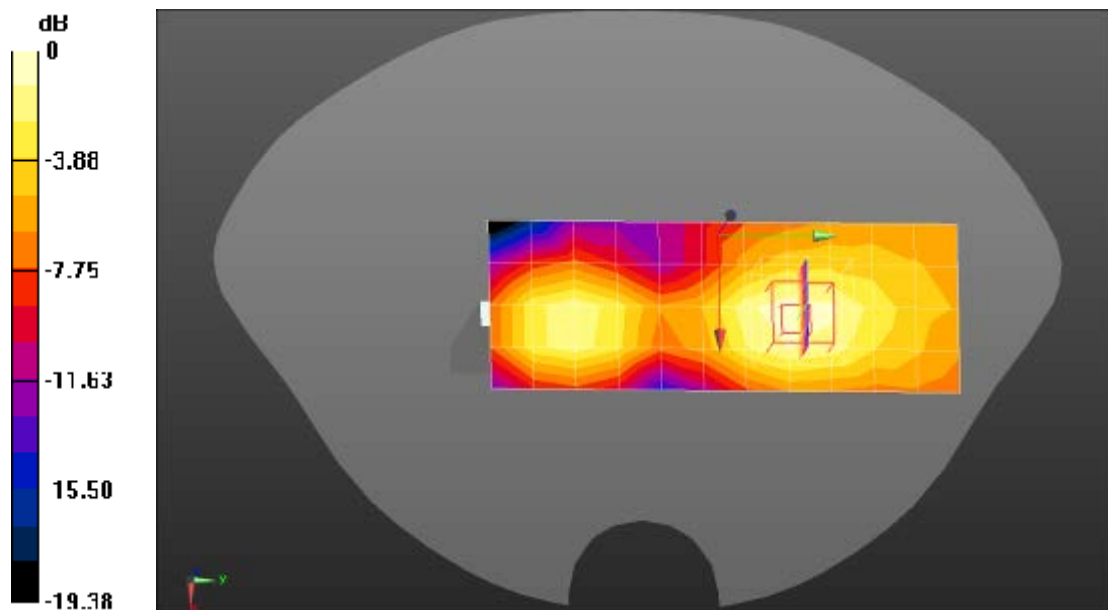

0 dB = 0.0365 W/kg = -14.38 dBW/kg



Date/Time: 21/07/2014

Test Laboratory: CerpPASS Lab

DUT: Mobile Phone; Type: D554P, DxxxP(xxx: stand for 0~9)

**Procedure Name: GPRS850MHz Mid Body-Bottom(4up)**

Communication System Band: GPRS850MHz(4up); Frequency: 836.6 MHz; Duty Cycle: 1:2.1

Medium parameters used:  $f = 836.6$  MHz;  $\sigma = 0.96$  S/m;  $\epsilon_r = 55.86$ ;  $\rho = 1000$  kg/m<sup>3</sup>

Phantom section: Flat Section; Tissue Temp (celsius) - 21°C

Measurement Standard: DASYS (IEEE/IEC/ANSI C63.19-2011)

DASY5 Configuration:

- Probe: EX3DV4 - SN3927; ConvF(9.91, 9.91, 9.91); Calibrated: 2014/5/23;
- Sensor-Surface: 4mm (Mechanical Surface Detection)
- Electronics: DAE4 Sn1379; Calibrated: 2014/5/19
- Phantom: SAM (30deg probe tilt) with CRP v5.0; Type: QD000P40CD
- Measurement SW: DASYS2, Version 52.8 (8);

**Configuration/GPRS850MHz Mid Body-Bottom(4up)/Area Scan (5x8x1):** Measurement grid:

$dx=15$ mm,  $dy=15$ mm, Maximum value of SAR (measured) = 0.119 W/kg

**Configuration/GPRS850MHz Mid Body-Bottom(4up)/Zoom Scan (5x5x7)/Cube 0:** Measurement

grid:  $dx=8$ mm,  $dy=8$ mm,  $dz=5$ mm, Reference Value = 8.701 V/m; Power Drift = -0.15 dB

Peak SAR (extrapolated) = 0.189 W/kg

**SAR(1 g) = 0.110 W/kg; SAR(10 g) = 0.060 W/kg** Maximum value of SAR (measured) = 0.123 W/kg

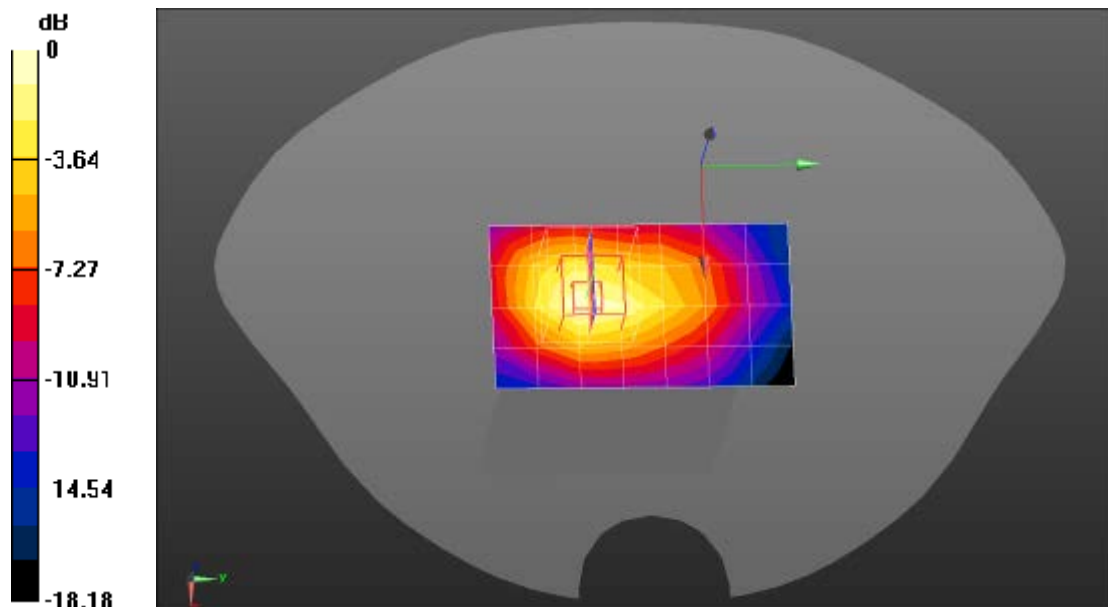

0 dB = 0.123 W/kg = -9.10 dBW/kg



Test Laboratory: CerpPASS Lab

DUT: Mobile Phone; Type: D554P, DxxxP(xxx: stand for 0~9)

**Procedure Name: PCS1900MHz Mid Touch-Left**

Communication System Band: PCS1900MHz ; Frequency: 1880 MHz; Duty Cycle: 1:8.3

Medium parameters used:  $f = 1880$  MHz;  $\sigma = 1.45$  S/m;  $\epsilon_r = 39.74$ ;  $\rho = 1000$  kg/m<sup>3</sup>

Phantom section: Left Section; Tissue Temp (celsius) - 21°C

Measurement Standard: DASYS (IEEE/IEC/ANSI C63.19-2011)

DASY5 Configuration:

- Probe: EX3DV4 - SN3927; ConvF(8.31, 8.31, 8.31); Calibrated: 2014/5/23;
- Sensor-Surface: 4mm (Mechanical Surface Detection)
- Electronics: DAE4 Sn1379; Calibrated: 2014/5/19
- Phantom: SAM (30deg probe tilt) with CRP v5.0; Type: QD000P40CD
- Measurement SW: DASY52, Version 52.8 (8);

**Configuration/PCS1900MHz Mid Touch-Left/Area Scan (8x13x1):** Measurement grid: dx=15mm, dy=15mm, Maximum value of SAR (measured) = 0.0959 W/kg

**Configuration/PCS1900MHz Mid Touch-Left/Zoom Scan (5x5x7)/Cube 0:** Measurement grid: dx=8mm, dy=8mm, dz=5mm, Reference Value = 3.147 V/m; Power Drift = -0.19 dB

Peak SAR (extrapolated) = 0.137 W/kg

**SAR(1 g) = 0.087 W/kg; SAR(10 g) = 0.053 W/kg** Maximum value of SAR (measured) = 0.0980 W/kg

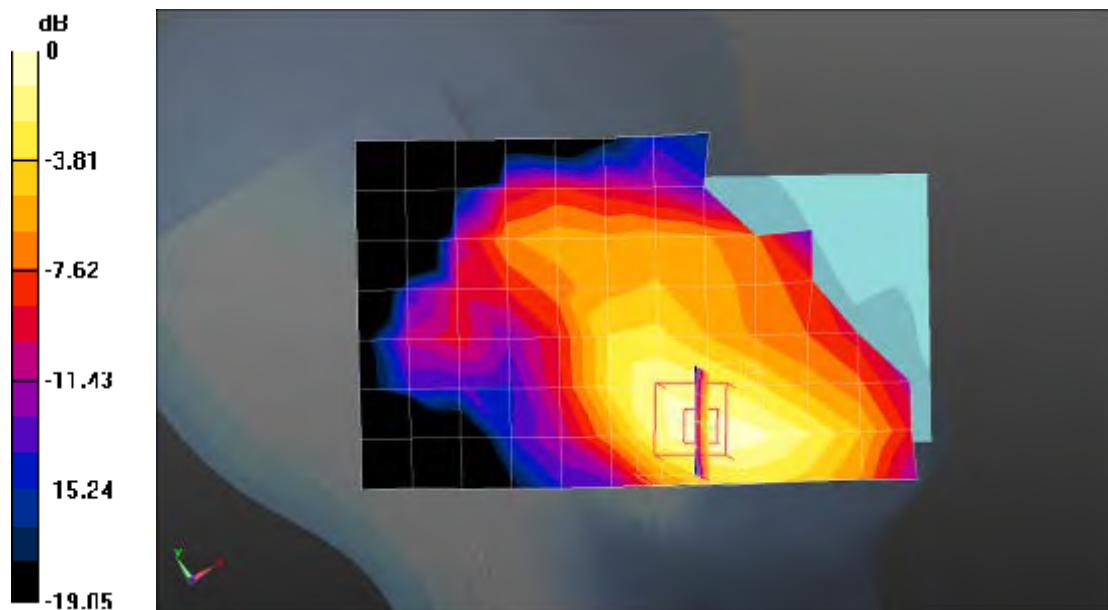

0 dB = 0.0980 W/kg = -10.09 dBW/kg





Date/Time: 21/07/2014

Test Laboratory: CerpPASS Lab

DUT: Mobile Phone; Type: D554P, DxxxP(xxx: stand for 0~9)

**Procedure Name: PCS1900MHz Mid Tilt-Left**

Communication System Band: PCS1900MHz ; Frequency: 1880 MHz; Duty Cycle: 1:8.3

Medium parameters used:  $f = 1880$  MHz;  $\sigma = 1.45$  S/m;  $\epsilon_r = 39.74$ ;  $\rho = 1000$  kg/m<sup>3</sup>

Phantom section: Left Section; Tissue Temp (celsius) - 21 °C

Measurement Standard: DASYS (IEEE/IEC/ANSI C63.19-2011)

DASY5 Configuration:

- Probe: EX3DV4 - SN3927; ConvF(8.31, 8.31, 8.31); Calibrated: 2014/5/23;
- Sensor-Surface: 4mm (Mechanical Surface Detection)
- Electronics: DAE4 Sn1379; Calibrated: 2014/5/19
- Phantom: SAM (30deg probe tilt) with CRP v5.0; Type: QD000P40CD
- Measurement SW: DASYS2, Version 52.8 (8);

**Configuration/PCS1900MHz Mid Tilt-Left/Area Scan (8x13x1):** Measurement grid: dx=15mm, dy=15mm, Maximum value of SAR (measured) = 0.0448 W/kg

**Configuration/PCS1900MHz Mid Tilt-Left/Zoom Scan (5x5x7)/Cube 0:** Measurement grid: dx=8mm, dy=8mm, dz=5mm, Reference Value = 5.281 V/m; Power Drift = 0.15 dB

Peak SAR (extrapolated) = 0.0620 W/kg

**SAR(1 g) = 0.042 W/kg; SAR(10 g) = 0.025 W/kg** Maximum value of SAR (measured) = 0.0436 W/kg

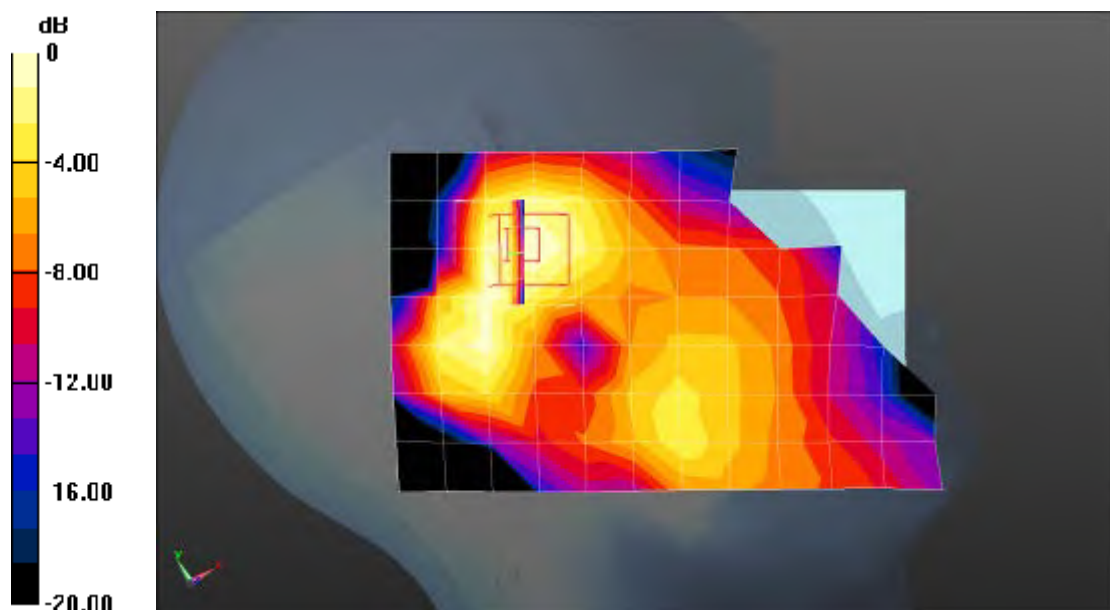

0 dB = 0.0436 W/kg = -13.61 dBW/kg



Date/Time: 21/07/2014

Test Laboratory: CerpPASS Lab

DUT: Mobile Phone; Type: D554P, DxxxP(xxx: stand for 0~9)

**Procedure Name: PCS1900MHz Mid Touch-Right**

Communication System Band: PCS1900MHz ; Frequency: 1880 MHz; Duty Cycle: 1:8.3

Medium parameters used:  $f = 1880$  MHz;  $\sigma = 1.45$  S/m;  $\epsilon_r = 39.74$ ;  $\rho = 1000$  kg/m<sup>3</sup>

Phantom section: Right Section; Tissue Temp (celsius) - 21°C

Measurement Standard: DASYS (IEEE/IEC/ANSI C63.19-2011)

DASY5 Configuration:

- Probe: EX3DV4 - SN3927; ConvF(8.31, 8.31, 8.31); Calibrated: 2014/5/23;
- Sensor-Surface: 4mm (Mechanical Surface Detection)
- Electronics: DAE4 Sn1379; Calibrated: 2014/5/19
- Phantom: SAM (30deg probe tilt) with CRP v5.0; Type: QD000P40CD
- Measurement SW: DASY52, Version 52.8 (8);

**Configuration/PCS1900MHz Mid Touch-Right/Area Scan (8x13x1):** Measurement grid: dx=15mm, dy=15mm, Maximum value of SAR (measured) = 0.0578 W/kg

**Configuration/PCS1900MHz Mid Touch-Right/Zoom Scan (5x5x7)/Cube 0:** Measurement grid: dx=8mm, dy=8mm, dz=5mm, Reference Value = 3.505 V/m; Power Drift = 0.16 dB

Peak SAR (extrapolated) = 0.0900 W/kg

**SAR(1 g) = 0.058 W/kg; SAR(10 g) = 0.036 W/kg** Maximum value of SAR (measured) = 0.0642 W/kg

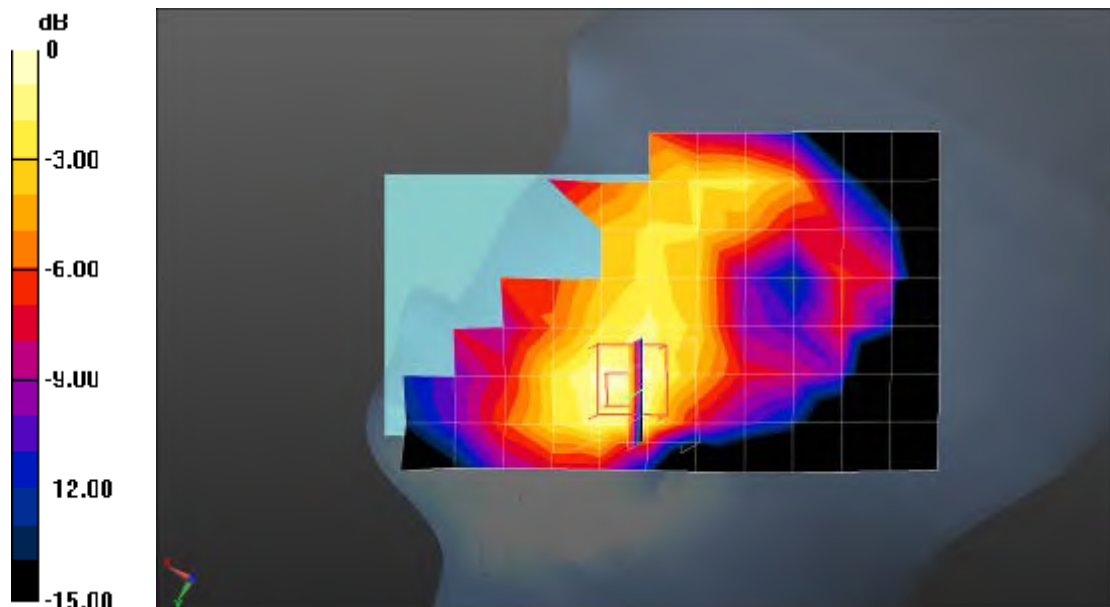

0 dB = 0.0642 W/kg = -11.92 dBW/kg





Date/Time: 21/07/2014

Test Laboratory: CerpPASS Lab

DUT: Mobile Phone; Type: D554P, DxxxP(xxx: stand for 0~9)

**Procedure Name: PCS1900MHz Mid Tilt-Right**

Communication System Band: PCS1900MHz ; Frequency: 1880 MHz; Duty Cycle: 1:8.3

Medium parameters used:  $f = 1880$  MHz;  $\sigma = 1.45$  S/m;  $\epsilon_r = 39.74$ ;  $\rho = 1000$  kg/m<sup>3</sup>

Phantom section: Right Section; Tissue Temp (celsius) - 21°C

Measurement Standard: DASYS (IEEE/IEC/ANSI C63.19-2011)

DASY5 Configuration:

- Probe: EX3DV4 - SN3927; ConvF(8.31, 8.31, 8.31); Calibrated: 2014/5/23;
- Sensor-Surface: 4mm (Mechanical Surface Detection)
- Electronics: DAE4 Sn1379; Calibrated: 2014/5/19
- Phantom: SAM (30deg probe tilt) with CRP v5.0; Type: QD000P40CD
- Measurement SW: DASYS2, Version 52.8 (8);

**Configuration/PCS1900MHz Mid Tilt-Right/Area Scan (8x13x1):** Measurement grid: dx=15mm, dy=15mm, Maximum value of SAR (measured) = 0.0363 W/kg

**Configuration/PCS1900MHz Mid Tilt-Right/Zoom Scan (5x5x7)/Cube 0:** Measurement grid: dx=8mm, dy=8mm, dz=5mm, Reference Value = 5.469 V/m; Power Drift = 0.12 dB

Peak SAR (extrapolated) = 0.0620 W/kg

**SAR(1 g) = 0.038 W/kg; SAR(10 g) = 0.020 W/kg** Maximum value of SAR (measured) = 0.0422 W/kg

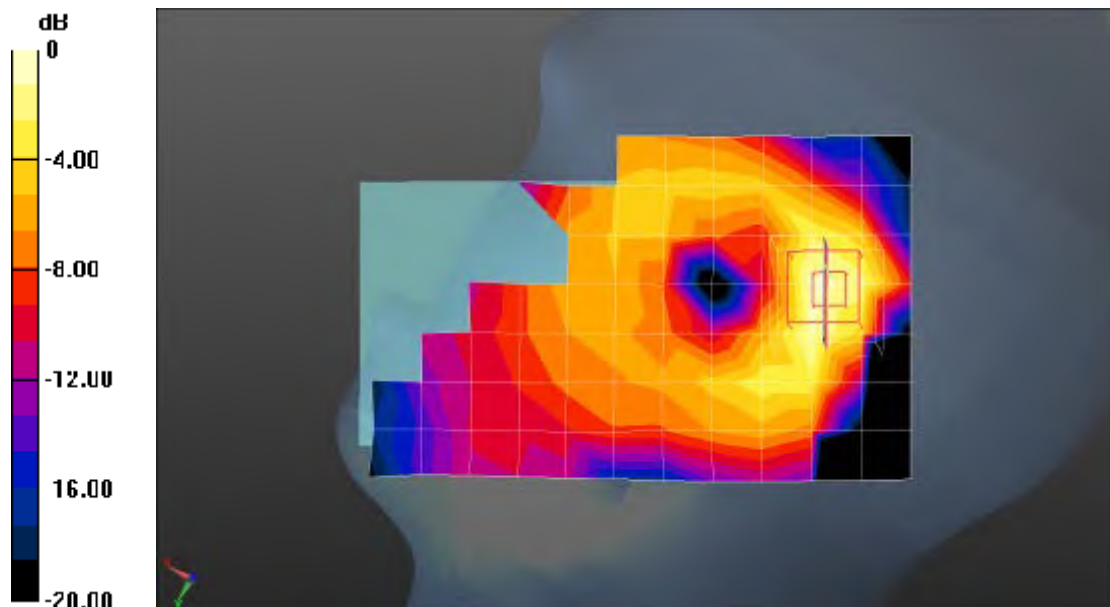

0 dB = 0.0422 W/kg = -13.75 dBW/kg



Date/Time: 21/07/2014

Test Laboratory: CerpPASS Lab

DUT: Mobile Phone; Type: D554P, DxxxP(xxx: stand for 0~9)

**Procedure Name: PCS1900MHz Mid Touch-Left<SIM2>**

Communication System Band: PCS1900MHz ; Frequency: 1880 MHz; Duty Cycle: 1:8.3

Medium parameters used:  $f = 1880$  MHz;  $\sigma = 1.45$  S/m;  $\epsilon_r = 39.74$ ;  $\rho = 1000$  kg/m<sup>3</sup>

Phantom section: Left Section; Tissue Temp (celsius) - 21 °C

Measurement Standard: DASY5 (IEEE/IEC/ANSI C63.19-2011)

DASY5 Configuration:

- Probe: EX3DV4 - SN3927; ConvF(8.31, 8.31, 8.31); Calibrated: 2014/5/23;
- Sensor-Surface: 4mm (Mechanical Surface Detection)
- Electronics: DAE4 Sn1379; Calibrated: 2014/5/19
- Phantom: SAM (30deg probe tilt) with CRP v5.0; Type: QD000P40CD
- Measurement SW: DASY52, Version 52.8 (8);

**Configuration/PCS1900MHz Mid Touch-Left/Area Scan (8x13x1):** Measurement grid: dx=15mm, dy=15mm, Maximum value of SAR (measured) = 0.0775 W/kg

**Configuration/PCS1900MHz Mid Touch-Left/Zoom Scan (5x5x7)/Cube 0:** Measurement grid: dx=8mm, dy=8mm, dz=5mm, Reference Value = 3.128 V/m; Power Drift = 0.15 dB

Peak SAR (extrapolated) = 0.118 W/kg

**SAR(1 g) = 0.076 W/kg; SAR(10 g) = 0.048 W/kg** Maximum value of SAR (measured) = 0.0827 W/kg

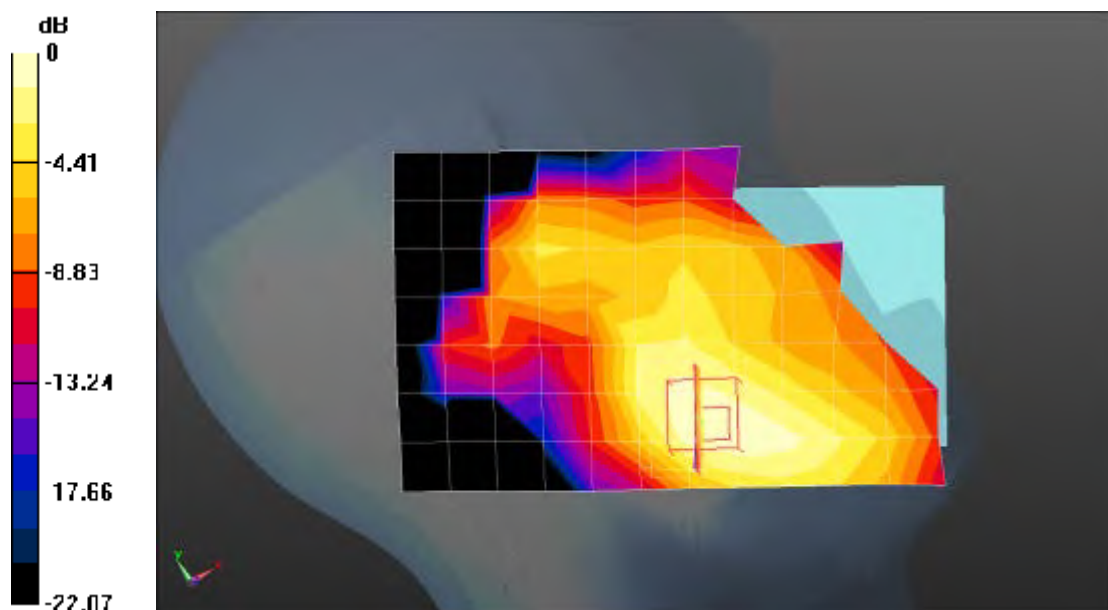

0 dB = 0.0827 W/kg = -10.82 dBW/kg



Date/Time: 21/07/2014

Test Laboratory: CerpPASS Lab

DUT: Mobile Phone; Type: D554P, DxxxP(xxx: stand for 0~9)

**Procedure Name: PCS1900MHz Mid Body-Back**

Communication System Band: PCS1900MHz ; Frequency: 1880 MHz; Duty Cycle: 1:8.3

Medium parameters used:  $f = 1880$  MHz;  $\sigma = 1.52$  S/m;  $\epsilon_r = 51.14$ ;  $\rho = 1000$  kg/m<sup>3</sup>

Phantom section: Flat Section; Tissue Temp (celsius) - 21°C

Measurement Standard: DASYS (IEEE/IEC/ANSI C63.19-2011)

DASY5 Configuration:

- Probe: EX3DV4 - SN3927; ConvF(8.1, 8.1, 8.1); Calibrated: 2014/5/23;
- Sensor-Surface: 4mm (Mechanical Surface Detection)
- Electronics: DAE4 Sn1379; Calibrated: 2014/5/19
- Phantom: SAM (30deg probe tilt) with CRP v5.0; Type: QD000P40CD
- Measurement SW: DASYS2, Version 52.8 (8);

**Configuration/PCS1900MHz Mid Body-Back/Area Scan (8x12x1):** Measurement grid: dx=15mm, dy=15mm, Maximum value of SAR (measured) = 0.257 W/kg

**Configuration/PCS1900MHz Mid Body-Back/Zoom Scan (5x5x7)/Cube 0:** Measurement grid: dx=8mm, dy=8mm, dz=5mm, Reference Value = 1.246 V/m; Power Drift = 0.11 dB

Peak SAR (extrapolated) = 0.498 W/kg

**SAR(1 g) = 0.264 W/kg; SAR(10 g) = 0.132 W/kg** Maximum value of SAR (measured) = 0.307 W/kg

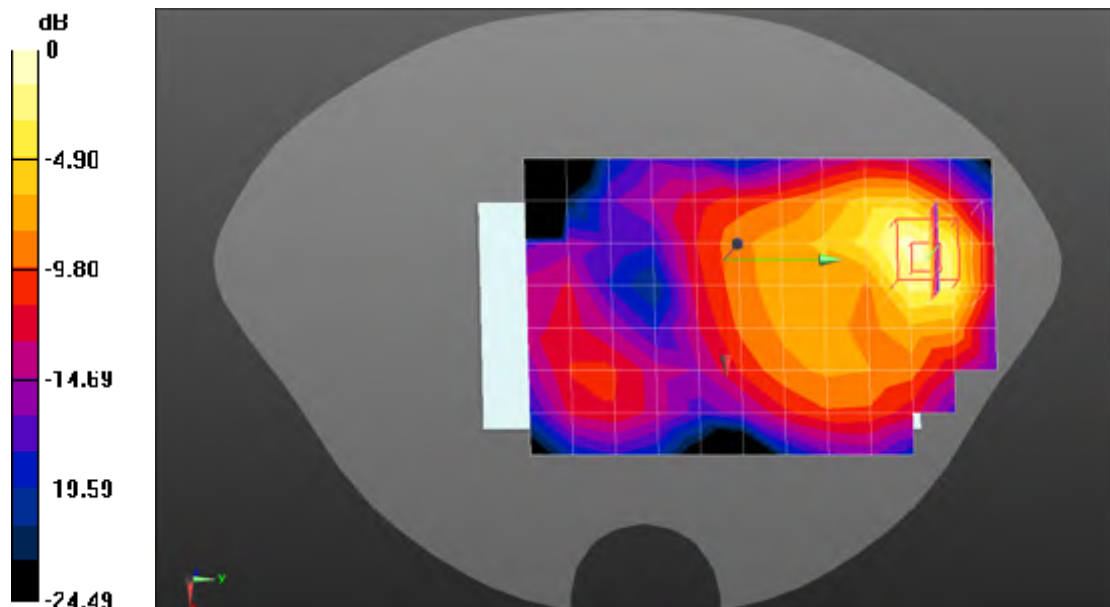

0 dB = 0.307 W/kg = -5.13 dBW/kg



Date/Time: 21/07/2014

Test Laboratory: CerpPASS Lab

DUT: Mobile Phone; Type: D554P, DxxxP(xxx: stand for 0~9)

**Procedure Name: GPRS1900MHz Low Body-Back(4up)**

Communication System Band: GPRS1900MHz(4up); Frequency: 1850.2 MHz; Duty Cycle: 1:2.1

Medium parameters used:  $f = 1850.2$  MHz;  $\sigma = 1.48$  S/m;  $\epsilon_r = 51.24$ ;  $\rho = 1000$  kg/m<sup>3</sup>

Phantom section: Flat Section; Tissue Temp (celsius) - 21°C

Measurement Standard: DASYS (IEEE/IEC/ANSI C63.19-2011)

DASY5 Configuration:

- Probe: EX3DV4 - SN3927; ConvF(8.1, 8.1, 8.1); Calibrated: 2014/5/23;
- Sensor-Surface: 4mm (Mechanical Surface Detection)
- Electronics: DAE4 Sn1379; Calibrated: 2014/5/19
- Phantom: SAM (30deg probe tilt) with CRP v5.0; Type: QD000P40CD
- Measurement SW: DASYS2, Version 52.8 (8);

**Configuration/GPRS1900MHz Low Body-Back(4up)/Area Scan (8x12x1):** Measurement grid:

$dx=15$ mm,  $dy=15$ mm, Maximum value of SAR (measured) = 0.807 W/kg

**Configuration/GPRS1900MHz Low Body-Back(4up)/Zoom Scan (5x5x7)/Cube 0:** Measurement

grid:  $dx=8$ mm,  $dy=8$ mm,  $dz=5$ mm, Reference Value = 3.697 V/m; Power Drift = 0.10 dB

Peak SAR (extrapolated) = 1.60 W/kg

**SAR(1 g) = 0.867 W/kg; SAR(10 g) = 0.439 W/kg** Maximum value of SAR (measured) = 0.993 W/kg

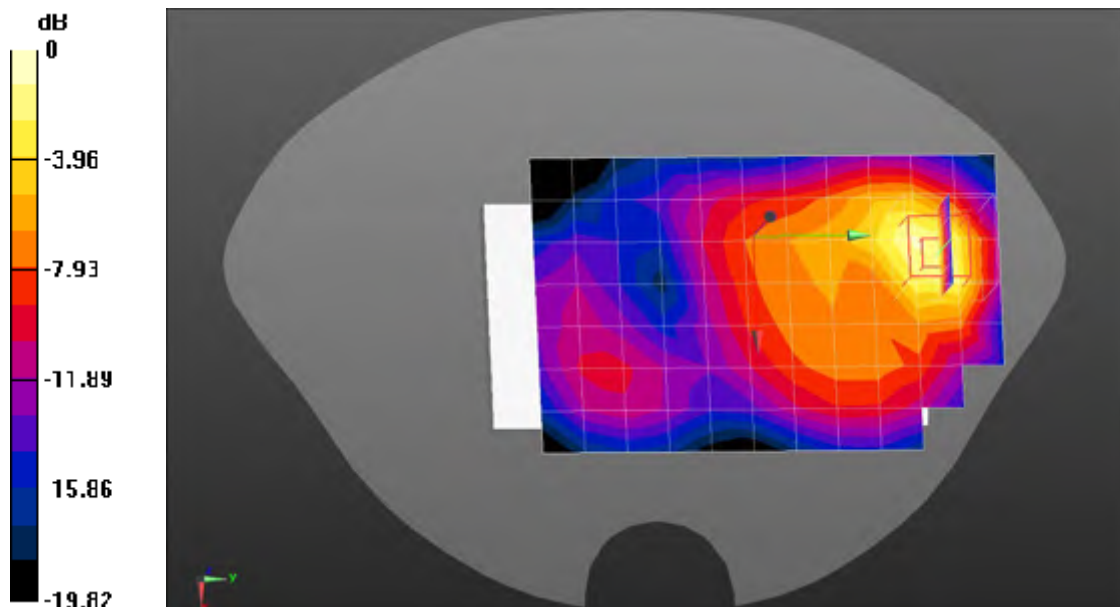

0 dB = 0.993 W/kg = -0.03 dBW/kg



Date/Time: 21/07/2014

Test Laboratory: CerpPASS Lab

DUT: Mobile Phone; Type: D554P, DxxxP(xxx: stand for 0~9)

**Procedure Name: GPRS1900MHz Mid Body-Back(4up)**

Communication System Band: GPRS1900MHz(4up); Frequency: 1880 MHz; Duty Cycle: 1:2.1

Medium parameters used:  $f = 1880$  MHz;  $\sigma = 1.52$  S/m;  $\epsilon_r = 51.14$ ;  $\rho = 1000$  kg/m<sup>3</sup>

Phantom section: Flat Section; Tissue Temp (celsius) - 21°C

Measurement Standard: DASYS (IEEE/IEC/ANSI C63.19-2011)

DASY5 Configuration:

- Probe: EX3DV4 - SN3927; ConvF(8.1, 8.1, 8.1); Calibrated: 2014/5/23;
- Sensor-Surface: 4mm (Mechanical Surface Detection)
- Electronics: DAE4 Sn1379; Calibrated: 2014/5/19
- Phantom: SAM (30deg probe tilt) with CRP v5.0; Type: QD000P40CD
- Measurement SW: DASYS2, Version 52.8 (8);

**Configuration/GPRS1900MHz Mid Body-Back(4up)/Area Scan (8x12x1):** Measurement grid:

$dx=15$ mm,  $dy=15$ mm, Maximum value of SAR (measured) = 0.964 W/kg

**Configuration/GPRS1900MHz Mid Body-Back(4up)/Zoom Scan (5x5x7)/Cube 0:** Measurement

grid:  $dx=8$ mm,  $dy=8$ mm,  $dz=5$ mm, Reference Value = 3.456 V/m; Power Drift = 0.19 dB

Peak SAR (extrapolated) = 1.88 W/kg

**SAR(1 g) = 0.994 W/kg; SAR(10 g) = 0.500 W/kg** Maximum value of SAR (measured) = 1.14 W/kg

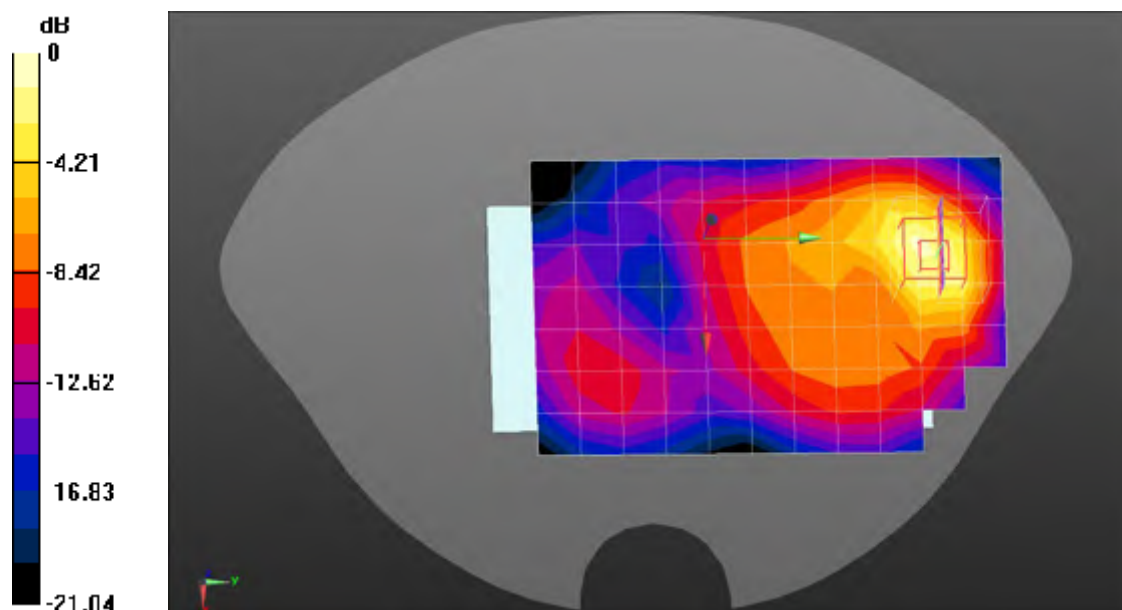

0 dB = 1.14 W/kg = 0.57 dBW/kg





Date/Time: 21/07/2014

Test Laboratory: CerpPASS Lab

DUT: Mobile Phone; Type: D554P, DxxxP(xxx: stand for 0~9)

**Procedure Name: GPRS1900MHz High Body-Back(4up)**

Communication System Band: GPRS1900MHz(4up); Frequency: 1909.8 MHz; Duty Cycle: 1:2.1

Medium parameters used:  $f = 1909.8$  MHz;  $\sigma = 1.55$  S/m;  $\epsilon_r = 51.04$ ;  $\rho = 1000$  kg/m<sup>3</sup>

Phantom section: Flat Section; Tissue Temp (celsius) - 21 °C

Measurement Standard: DASYS (IEEE/IEC/ANSI C63.19-2011)

DASY5 Configuration:

- Probe: EX3DV4 - SN3927; ConvF(8.1, 8.1, 8.1); Calibrated: 2014/5/23;
- Sensor-Surface: 4mm (Mechanical Surface Detection)
- Electronics: DAE4 Sn1379; Calibrated: 2014/5/19
- Phantom: SAM (30deg probe tilt) with CRP v5.0; Type: QD000P40CD
- Measurement SW: DASYS2, Version 52.8 (8);

**Configuration/GPRS1900MHz High Body-Back(4up)/Area Scan (8x12x1):** Measurement grid:

$dx=15$ mm,  $dy=15$ mm, Maximum value of SAR (measured) = 1.05 W/kg

**Configuration/GPRS1900MHz High Body-Back(4up)/Zoom Scan (5x5x7)/Cube 0:** Measurement

grid:  $dx=8$ mm,  $dy=8$ mm,  $dz=5$ mm, Reference Value = 3.240 V/m; Power Drift = 0.14 dB

Peak SAR (extrapolated) = 1.99 W/kg

**SAR(1 g) = 0.997 W/kg; SAR(10 g) = 0.531 W/kg** Maximum value of SAR (measured) = 1.22 W/kg

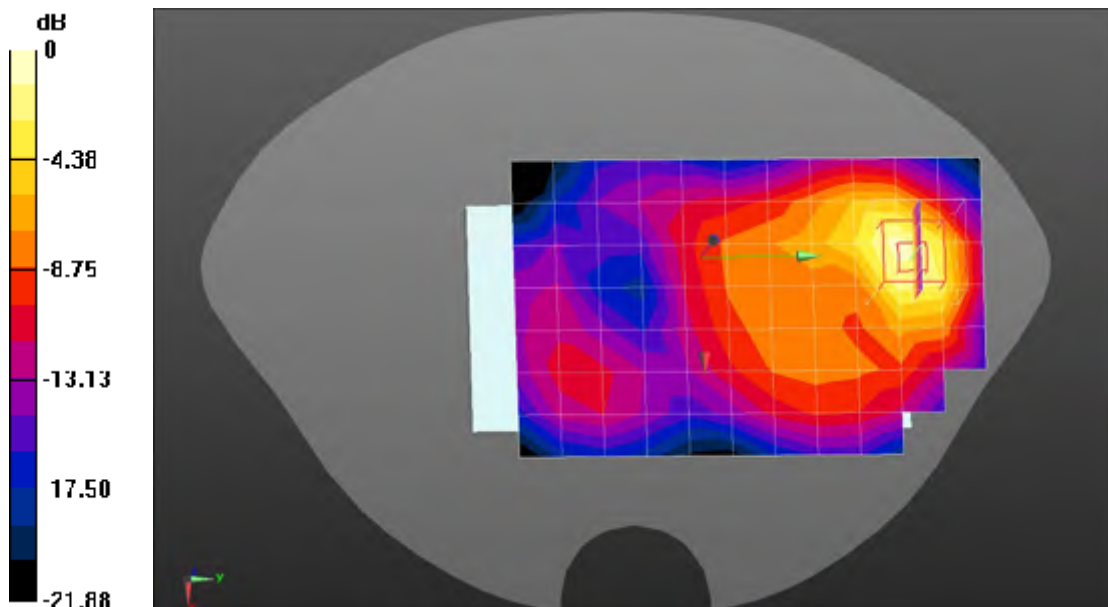

0 dB = 1.22 W/kg = 0.86 dBW/kg



Z-Axis Plot

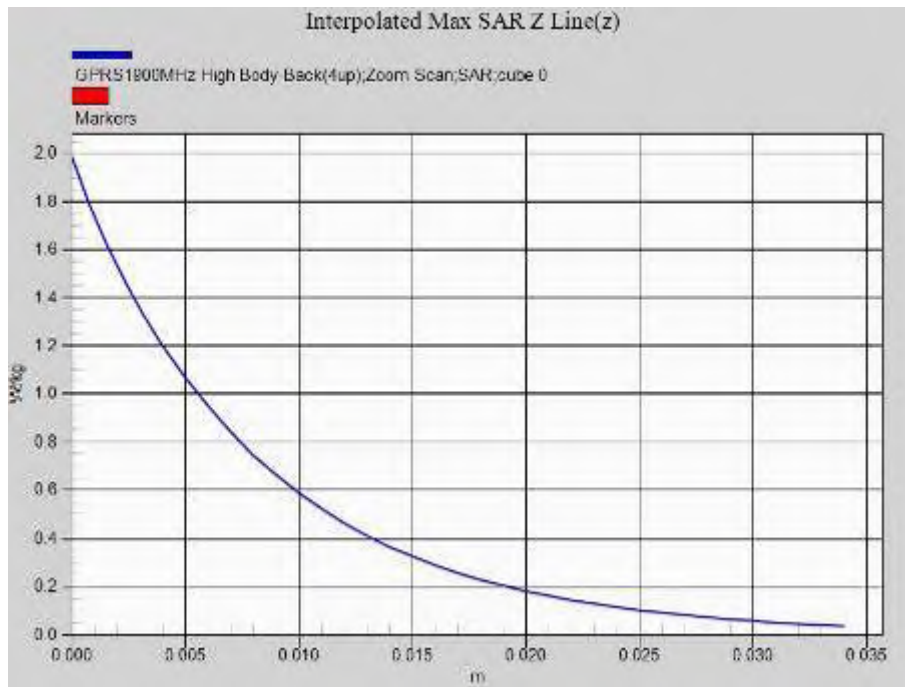



Test Laboratory: CerpPASS Lab

DUT: Mobile Phone; Type: D554P, DxxxP(xxx: stand for 0~9)

**Procedure Name: GPRS1900MHz High Body-Back (4up)\***

Communication System Band: GPRS1900MHz(4up); Frequency: 1909.8 MHz; Duty Cycle: 1:2.1

Medium parameters used:  $f = 1909.8$  MHz;  $\sigma = 1.55$  S/m;  $\epsilon_r = 51.04$ ;  $\rho = 1000$  kg/m<sup>3</sup>

Phantom section: Flat Section; Tissue Temp(celsius)- 21°C

Measurement Standard: DASYS (IEEE/IEC/ANSI C63.19-2011)

DASY5 Configuration:

- Probe: EX3DV4 - SN3927; ConvF(8.1, 8.1, 8.1); Calibrated: 2014/5/23;
- Sensor-Surface: 4mm (Mechanical Surface Detection)
- Electronics: DAE4 Sn1379; Calibrated: 2014/5/19
- Phantom: SAM (30deg probe tilt) with CRP v5.0; Type: QD000P40CD
- Measurement SW: DASYS2, Version 52.8 (8);

**Configuration/GPRS1900MHz High Body-Back(4up)/Area Scan (8x12x1):** Measurement grid:

$dx=15$ mm,  $dy=15$ mm, Maximum value of SAR (measured) = 1.04 W/kg

**Configuration/GPRS1900MHz High Body-Back(4up)/Zoom Scan (5x5x7)/Cube 0:** Measurement

grid:  $dx=8$ mm,  $dy=8$ mm,  $dz=5$ mm, Reference Value = 3.240 V/m; Power Drift = 0.12 dB

Peak SAR (extrapolated) = 1.96 W/kg

**SAR(1 g) = 0.995 W/kg; SAR(10 g) = 0.525 W/kg** Maximum value of SAR (measured) = 1.21 W/kg

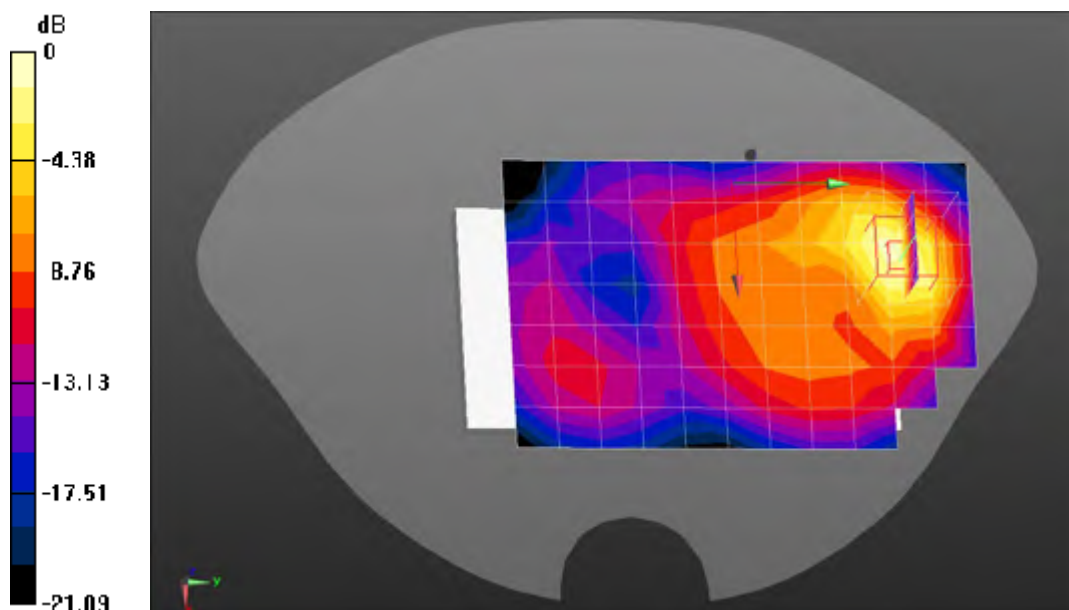

0 dB = 1.21 W/kg = 0.83 dBW/kg





Date/Time: 21/07/2014

Test Laboratory: CerpPASS Lab

DUT: Mobile Phone; Type: D554P, DxxxP(xxx: stand for 0~9)

**Procedure Name: GPRS1900MHz Mid Body-Front(4up)**

Communication System Band: GPRS1900MHz(4up); Frequency: 1880 MHz; Duty Cycle: 1:2.1

Medium parameters used:  $f = 1880$  MHz;  $\sigma = 1.52$  S/m;  $\epsilon_r = 51.14$ ;  $\rho = 1000$  kg/m<sup>3</sup>

Phantom section: Flat Section; Tissue Temp (celsius) - 21°C

Measurement Standard: DASYS (IEEE/IEC/ANSI C63.19-2011)

DASY5 Configuration:

- Probe: EX3DV4 - SN3927; ConvF(8.1, 8.1, 8.1); Calibrated: 2014/5/23;
- Sensor-Surface: 4mm (Mechanical Surface Detection)
- Electronics: DAE4 Sn1379; Calibrated: 2014/5/19
- Phantom: SAM (30deg probe tilt) with CRP v5.0; Type: QD000P40CD
- Measurement SW: DASYS2, Version 52.8 (8);

**Configuration/GPRS1900MHz Mid Body-Front(4up)/Area Scan (8x12x1):** Measurement grid:

$dx=15$ mm,  $dy=15$ mm, Maximum value of SAR (measured) = 0.389 W/kg

**Configuration/GPRS1900MHz Mid Body-Front(4up)/Zoom Scan (5x5x7)/Cube 0:** Measurement

grid:  $dx=8$ mm,  $dy=8$ mm,  $dz=5$ mm, Reference Value = 2.593 V/m; Power Drift = 0.12 dB

Peak SAR (extrapolated) = 0.664 W/kg

**SAR(1 g) = 0.367 W/kg; SAR(10 g) = 0.199 W/kg** Maximum value of SAR (measured) = 0.403 W/kg

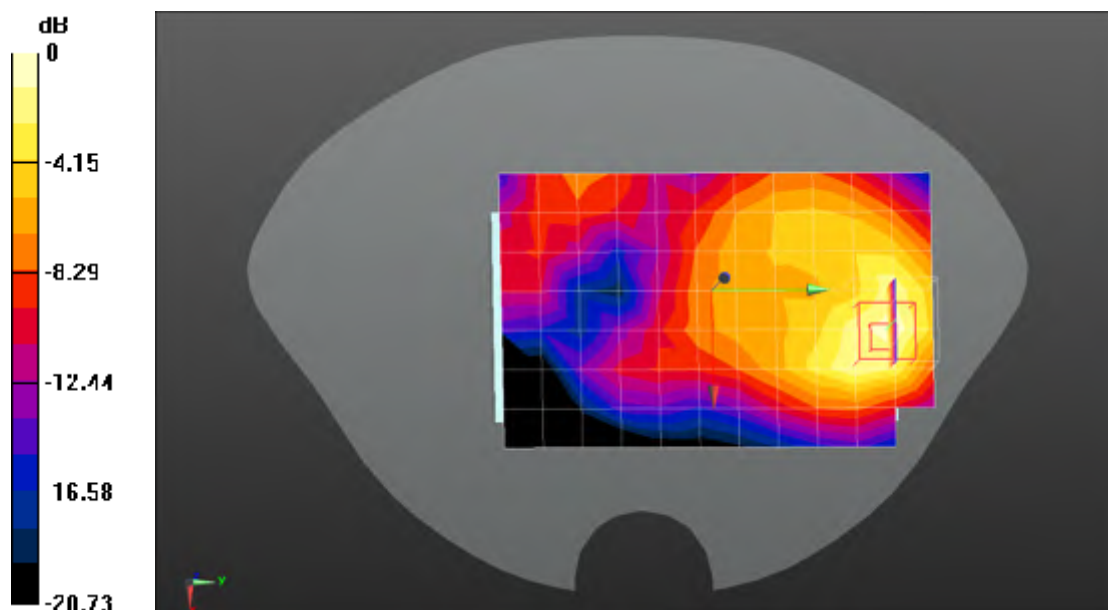

0 dB = 0.403 W/kg = -3.95 dBW/kg



Date/Time: 21/07/2014

Test Laboratory: CerpPASS Lab

DUT: Mobile Phone; Type: D554P, DxxxP(xxx: stand for 0~9)

**Procedure Name: GPRS1900MHz Mid Body-Leftside(4up)**

Communication System Band: GPRS1900MHz(4up); Frequency: 1880 MHz; Duty Cycle: 1:2.1

Medium parameters used:  $f = 1880$  MHz;  $\sigma = 1.52$  S/m;  $\epsilon_r = 51.14$ ;  $\rho = 1000$  kg/m<sup>3</sup>

Phantom section: Flat Section; Tissue Temp (celsius) - 21°C

Measurement Standard: DASYS (IEEE/IEC/ANSI C63.19-2011)

DASY5 Configuration:

- Probe: EX3DV4 - SN3927; ConvF(8.1, 8.1, 8.1); Calibrated: 2014/5/23;
- Sensor-Surface: 4mm (Mechanical Surface Detection)
- Electronics: DAE4 Sn1379; Calibrated: 2014/5/19
- Phantom: SAM (30deg probe tilt) with CRP v5.0; Type: QD000P40CD
- Measurement SW: DASYS2, Version 52.8 (8);

**Configuration/GPRS1900MHz Mid Body-Leftside(4up)/Area Scan (5x12x1):** Measurement grid: dx=15mm, dy=15mm, Maximum value of SAR (measured) = 0.229 W/kg

**Configuration/GPRS1900MHz Mid Body-Leftside(4up)/Zoom Scan (5x5x7)/Cube**

**0:** Measurement grid: dx=8mm, dy=8mm, dz=5mm, Reference Value = 9.066 V/m; Power Drift = -0.02 dB Peak SAR (extrapolated) = 0.388 W/kg

**SAR(1 g) = 0.225 W/kg; SAR(10 g) = 0.127 W/kg** Maximum value of SAR (measured) = 0.248 W/kg

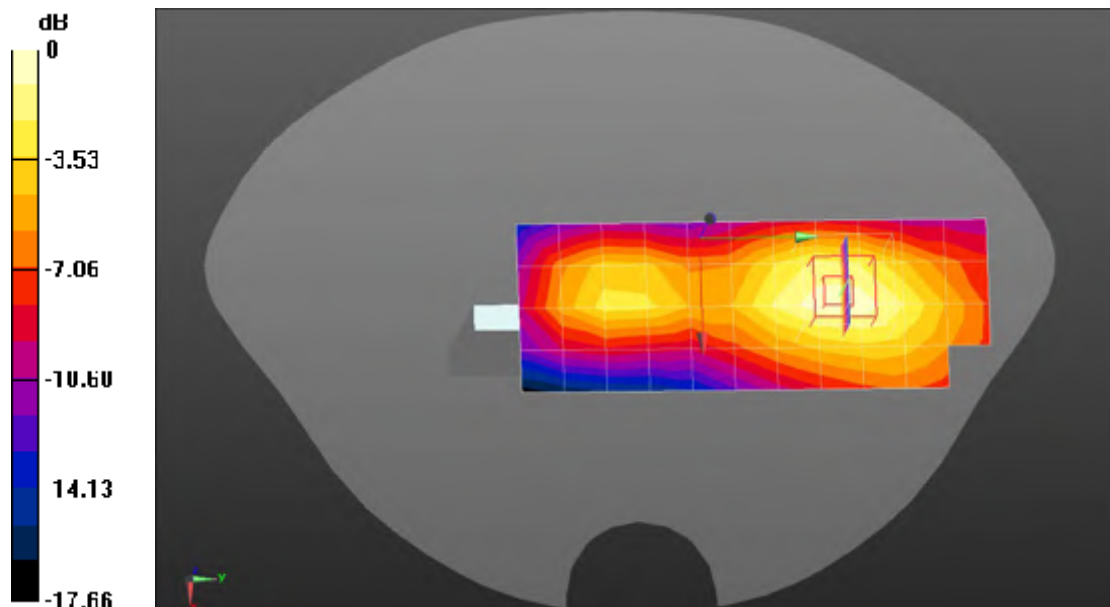

0 dB = 0.248 W/kg = -6.06 dBW/kg



Date/Time: 21/07/2014

Test Laboratory: CerpPASS Lab

DUT: Mobile Phone; Type: D554P, DxxxP(xxx: stand for 0~9)

**Procedure Name: GPRS1900MHz Mid Body-Rightside(4up)**

Communication System Band: GPRS1900MHz(4up); Frequency: 1880 MHz; Duty Cycle: 1:2.1

Medium parameters used:  $f = 1880$  MHz;  $\sigma = 1.52$  S/m;  $\epsilon_r = 51.14$ ;  $\rho = 1000$  kg/m<sup>3</sup>

Phantom section: Flat Section; Tissue Temp (celsius) - 21°C

Measurement Standard: DASYS (IEEE/IEC/ANSI C63.19-2011)

DASY5 Configuration:

- Probe: EX3DV4 - SN3927; ConvF(8.1, 8.1, 8.1); Calibrated: 2014/5/23;
- Sensor-Surface: 4mm (Mechanical Surface Detection)
- Electronics: DAE4 Sn1379; Calibrated: 2014/5/19
- Phantom: SAM (30deg probe tilt) with CRP v5.0; Type: QD000P40CD
- Measurement SW: DASY52, Version 52.8 (8);

**Configuration/GPRS1900MHz Mid Body-Rightside(4up)/Area Scan (5x12x1):** Measurement grid: dx=15mm, dy=15mm, Maximum value of SAR (measured) = 0.129 W/kg

**Configuration/GPRS1900MHz Mid Body-Rightside(4up)/Zoom Scan (5x5x7)/Cube**

**0:** Measurement grid: dx=8mm, dy=8mm, dz=5mm, Reference Value = 7.835 V/m; Power Drift = 0.06 dB Peak SAR (extrapolated) = 0.208 W/kg

**SAR(1 g) = 0.123 W/kg; SAR(10 g) = 0.070 W/kg** Maximum value of SAR (measured) = 0.134 W/kg

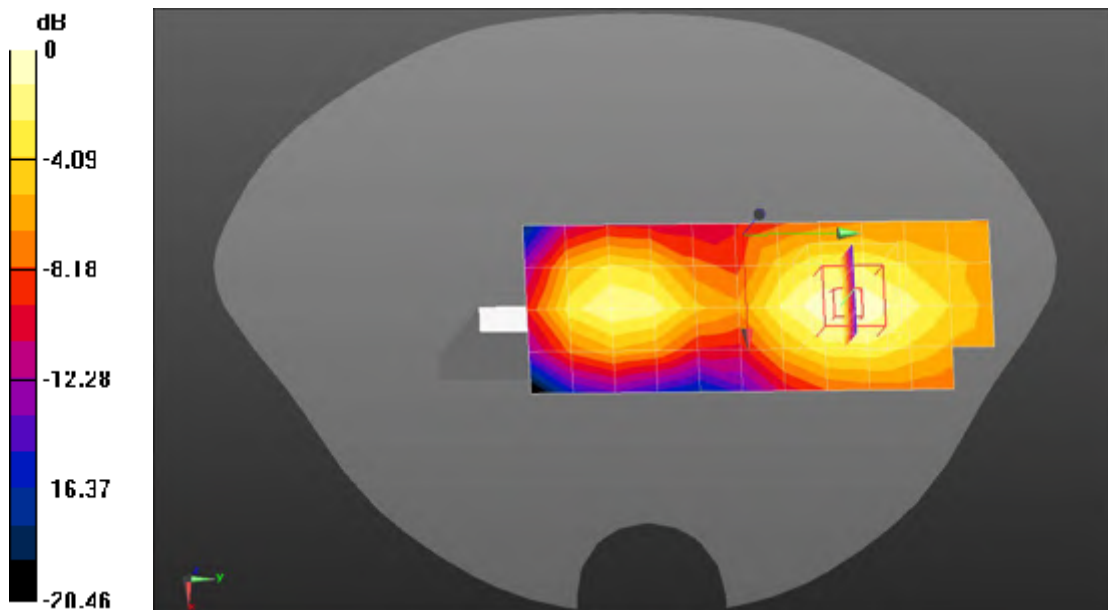

0 dB = 0.134 W/kg = -8.73 dBW/kg



Date/Time: 21/07/2014

Test Laboratory: CerpPASS Lab

DUT: Mobile Phone; Type: D554P, DxxxP(xxx: stand for 0~9)

**Procedure Name: GPRS1900MHz Mid Body-Bottom(4up)**

Communication System Band: GPRS1900MHz(4up); Frequency: 1880 MHz; Duty Cycle: 1:2.1

Medium parameters used:  $f = 1880$  MHz;  $\sigma = 1.52$  S/m;  $\epsilon_r = 51.14$ ;  $\rho = 1000$  kg/m<sup>3</sup>

Phantom section: Flat Section; Tissue Temp (celsius) - 21°C

Measurement Standard: DASY5 (IEEE/IEC/ANSI C63.19-2011)

DASY5 Configuration:

- Probe: EX3DV4 - SN3927; ConvF(8.1, 8.1, 8.1); Calibrated: 2014/5/23;
- Sensor-Surface: 4mm (Mechanical Surface Detection)
- Electronics: DAE4 Sn1379; Calibrated: 2014/5/19
- Phantom: SAM (30deg probe tilt) with CRP v5.0; Type: QD000P40CD
- Measurement SW: DASY52, Version 52.8 (8);

**Configuration/GPRS1900MHz Mid Body-Bottom(4up)/Area Scan (5x8x1):** Measurement grid:

$dx=15$ mm,  $dy=15$ mm, Maximum value of SAR (measured) = 0.496 W/kg

**Configuration/GPRS1900MHz Mid Body-Bottom(4up)/Zoom Scan (5x5x7)/Cube 0:** Measurement

grid:  $dx=8$ mm,  $dy=8$ mm,  $dz=5$ mm, Reference Value = 13.70 V/m; Power Drift = -0.03 dB

Peak SAR (extrapolated) = 0.804 W/kg

**SAR(1 g) = 0.461 W/kg; SAR(10 g) = 0.245 W/kg** Maximum value of SAR (measured) = 0.517 W/kg

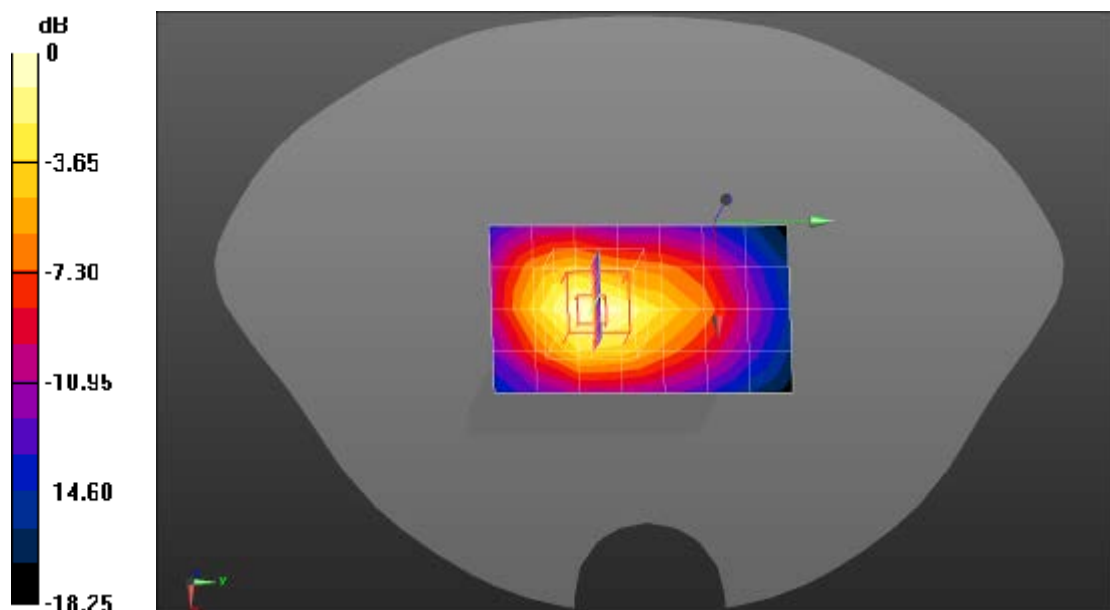

0 dB = 0.517 W/kg = -2.87 dBW/kg



Date/Time: 21/07/2014

Test Laboratory: CerpPASS Lab

DUT: Mobile Phone; Type: D554P, DxxxP(xxx: stand for 0~9)

**Procedure Name: WCDMA Band II Mid Touch-Left**

Communication System Band: WCDMA Band II; Frequency: 1880 MHz; Duty Cycle: 1:1

Medium parameters used:  $f = 1880$  MHz;  $\sigma = 1.45$  S/m;  $\epsilon_r = 39.74$ ;  $\rho = 1000$  kg/m<sup>3</sup>

Phantom section: Left Section; Tissue Temp (celsius) - 21 °C

Measurement Standard: DASYS (IEEE/IEC/ANSI C63.19-2011)

DASY5 Configuration:

- Probe: EX3DV4 - SN3927; ConvF(8.31, 8.31, 8.31); Calibrated: 2014/5/23;
- Sensor-Surface: 4mm (Mechanical Surface Detection)
- Electronics: DAE4 Sn1379; Calibrated: 2014/5/19
- Phantom: SAM (30deg probe tilt) with CRP v5.0; Type: QD000P40CD
- Measurement SW: DASYS2, Version 52.8 (8);

**Configuration/WCDMA Band II Mid Touch-Left/Area Scan (8x13x1):** Measurement grid: dx=15mm, dy=15mm, Maximum value of SAR (measured) = 0.0779 W/kg

**Configuration/WCDMA Band II Mid Touch-Left/Zoom Scan (5x5x7)/Cube 0:** Measurement grid: dx=8mm, dy=8mm, dz=5mm, Reference Value = 2.928 V/m; Power Drift = 0.12 dB

Peak SAR (extrapolated) = 0.115 W/kg

**SAR(1 g) = 0.074 W/kg; SAR(10 g) = 0.046 W/kg** Maximum value of SAR (measured) = 0.0814 W/kg

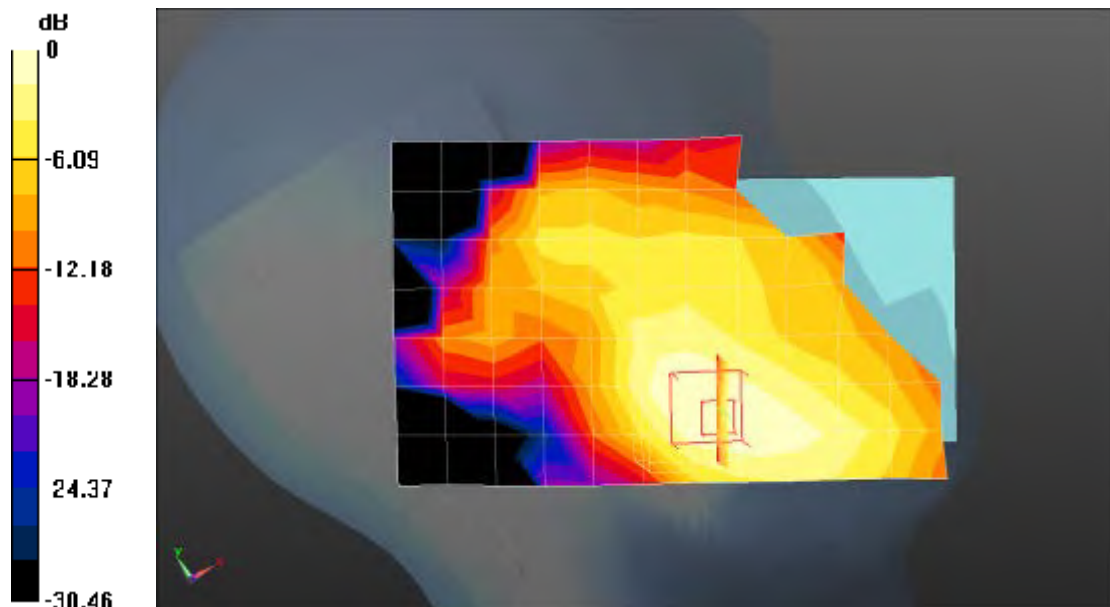

0 dB = 0.0814 W/kg = -10.89 dBW/kg



Date/Time: 21/07/2014

Test Laboratory: CerpPASS Lab

DUT: Mobile Phone; Type: D554P, DxxxP(xxx: stand for 0~9)

**Procedure Name: WCDMA Band II Mid Tilt-Left**

Communication System Band: WCDMA Band II; Frequency: 1880 MHz; Duty Cycle: 1:1

Medium parameters used:  $f = 1880$  MHz;  $\sigma = 1.45$  S/m;  $\epsilon_r = 39.74$ ;  $\rho = 1000$  kg/m<sup>3</sup>

Phantom section: Left Section; Tissue Temp (celsius) - 21 °C

Measurement Standard: DASYS (IEEE/IEC/ANSI C63.19-2011)

DASY5 Configuration:

- Probe: EX3DV4 - SN3927; ConvF(8.31, 8.31, 8.31); Calibrated: 2014/5/23;
- Sensor-Surface: 4mm (Mechanical Surface Detection)
- Electronics: DAE4 Sn1379; Calibrated: 2014/5/19
- Phantom: SAM (30deg probe tilt) with CRP v5.0; Type: QD000P40CD
- Measurement SW: DASYS2, Version 52.8 (8);

**Configuration/WCDMA Band II Mid Tilt-Left/Area Scan (8x13x1):** Measurement grid: dx=15mm, dy=15mm, Maximum value of SAR (measured) = 0.0374 W/kg

**Configuration/WCDMA Band II Mid Tilt-Left/Zoom Scan (5x5x7)/Cube 0:** Measurement grid: dx=8mm, dy=8mm, dz=5mm, Reference Value = 4.740 V/m; Power Drift = 0.18 dB

Peak SAR (extrapolated) = 0.0500 W/kg

**SAR(1 g) = 0.034 W/kg; SAR(10 g) = 0.020 W/kg** Maximum value of SAR (measured) = 0.0368 W/kg

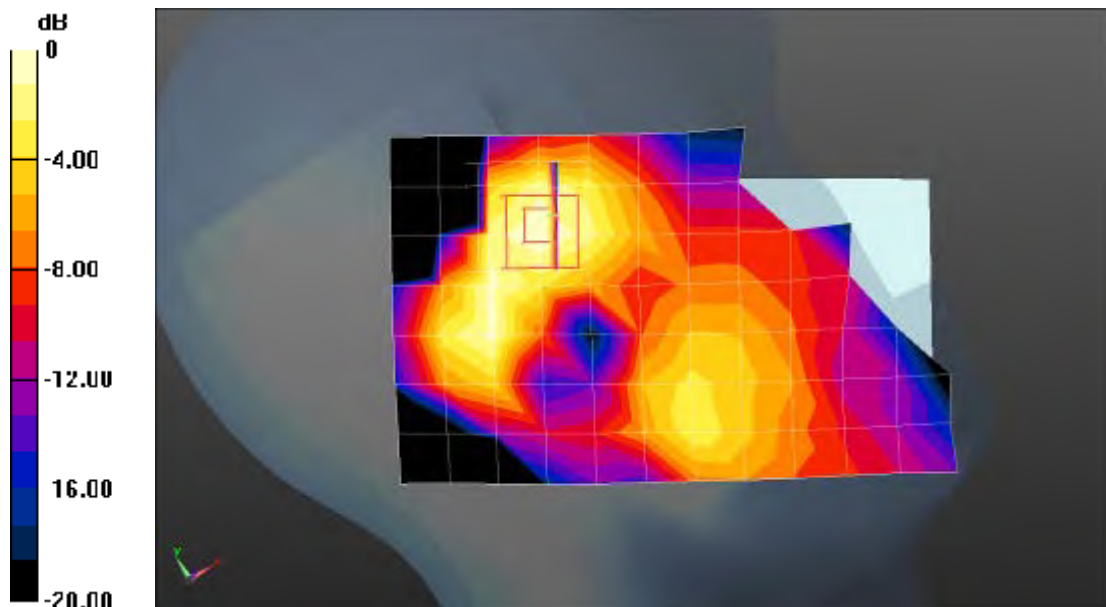

0 dB = 0.0368 W/kg = -14.34 dBW/kg





Date/Time: 21/07/2014

Test Laboratory: CerpPASS Lab

DUT: Mobile Phone; Type: D554P, DxxxP(xxx: stand for 0~9)

**Procedure Name: WCDMA Band II Mid Touch-Right**

Communication System Band: WCDMA Band II; Frequency: 1880 MHz; Duty Cycle: 1:1

Medium parameters used:  $f = 1880$  MHz;  $\sigma = 1.45$  S/m;  $\epsilon_r = 39.74$ ;  $\rho = 1000$  kg/m<sup>3</sup>

Phantom section: Right Section; Tissue Temp (celsius) - 21°C

Measurement Standard: DASYS (IEEE/IEC/ANSI C63.19-2011)

DASY5 Configuration:

- Probe: EX3DV4 - SN3927; ConvF(8.31, 8.31, 8.31); Calibrated: 2014/5/23;
- Sensor-Surface: 4mm (Mechanical Surface Detection)
- Electronics: DAE4 Sn1379; Calibrated: 2014/5/19
- Phantom: SAM (30deg probe tilt) with CRP v5.0; Type: QD000P40CD
- Measurement SW: DASY52, Version 52.8 (8);

**Configuration/WCDMA Band II Mid Touch-Right/Area Scan (8x13x1):** Measurement grid:

$dx=15$ mm,  $dy=15$ mm, Maximum value of SAR (measured) = 0.0454 W/kg

**Configuration/WCDMA Band II Mid Touch-Right/Zoom Scan (5x5x7)/Cube 0:** Measurement grid:

$dx=8$ mm,  $dy=8$ mm,  $dz=5$ mm, Reference Value = 3.062 V/m; Power Drift = 0.19 dB

Peak SAR (extrapolated) = 0.0740 W/kg

**SAR(1 g) = 0.047 W/kg; SAR(10 g) = 0.029 W/kg** Maximum value of SAR (measured) = 0.0506 W/kg

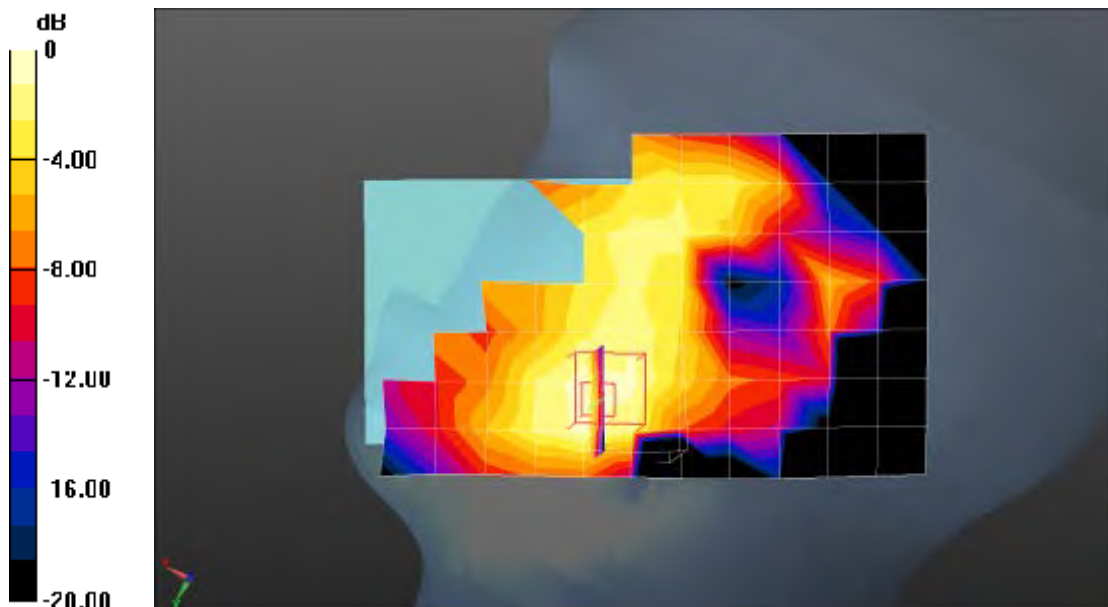

0 dB = 0.0506 W/kg = -12.96 dBW/kg



Date/Time: 21/07/2014

Test Laboratory: CerpPASS Lab

DUT: Mobile Phone; Type: D554P, DxxxP(xxx: stand for 0~9)

**Procedure Name: WCDMA Band II Mid Tilt-Right**

Communication System Band: WCDMA Band II; Frequency: 1880 MHz; Duty Cycle: 1:1

Medium parameters used:  $f = 1880$  MHz;  $\sigma = 1.45$  S/m;  $\epsilon_r = 39.74$ ;  $\rho = 1000$  kg/m<sup>3</sup>

Phantom section: Right Section; Tissue Temp (celsius) - 21°C

Measurement Standard: DASYS (IEEE/IEC/ANSI C63.19-2011)

DASY5 Configuration:

- Probe: EX3DV4 - SN3927; ConvF(8.31, 8.31, 8.31); Calibrated: 2014/5/23;
- Sensor-Surface: 4mm (Mechanical Surface Detection)
- Electronics: DAE4 Sn1379; Calibrated: 2014/5/19
- Phantom: SAM (30deg probe tilt) with CRP v5.0; Type: QD000P40CD
- Measurement SW: DASY52, Version 52.8 (8);

**Configuration/WCDMA Band II Mid Tilt-Right/Area Scan (8x13x1):** Measurement grid: dx=15mm, dy=15mm, Maximum value of SAR (measured) = 0.0312 W/kg

**Configuration/WCDMA Band II Mid Tilt-Right/Zoom Scan (5x5x7)/Cube 0:** Measurement grid: dx=8mm, dy=8mm, dz=5mm, Reference Value = 5.058 V/m; Power Drift = 0.10 dB

Peak SAR (extrapolated) = 0.0550 W/kg

**SAR(1 g) = 0.031 W/kg; SAR(10 g) = 0.017 W/kg** Maximum value of SAR (measured) = 0.0351 W/kg

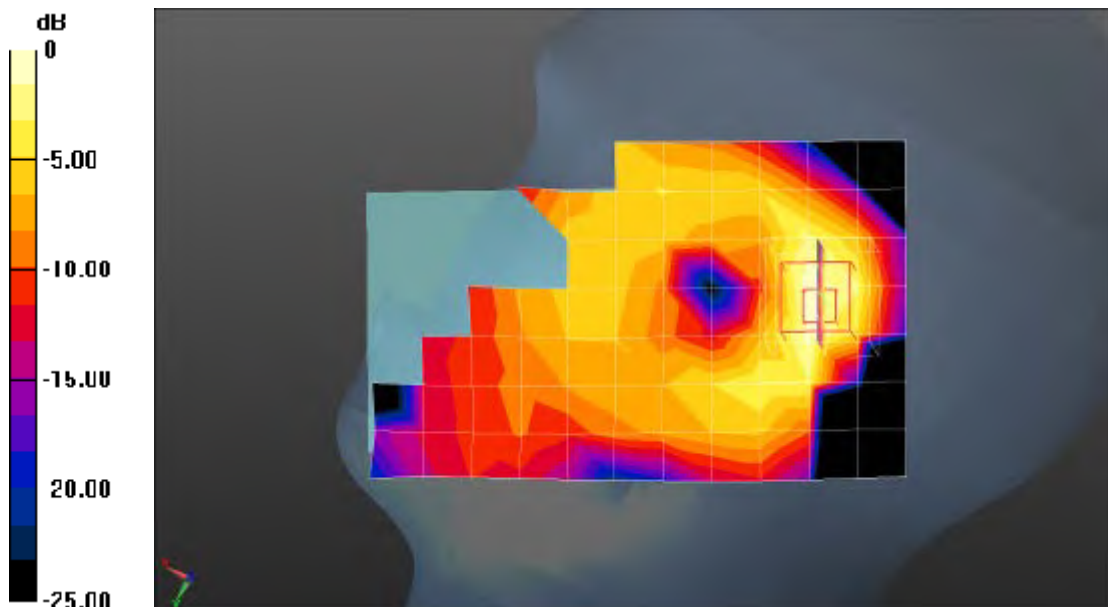

0 dB = 0.0351 W/kg = -14.55 dBW/kg





Date/Time: 21/07/2014

Test Laboratory: CerpPASS Lab

DUT: Mobile Phone; Type: D554P, DxxxP(xxx: stand for 0~9)

**Procedure Name: WCDMA Band II Mid Body-Back**

Communication System Band: WCDMA Band II; Frequency: 1880 MHz; Duty Cycle: 1:1

Medium parameters used:  $f = 1880$  MHz;  $\sigma = 1.52$  S/m;  $\epsilon_r = 51.14$ ;  $\rho = 1000$  kg/m<sup>3</sup>

Phantom section: Flat Section; Tissue Temp (celsius) - 21°C

Measurement Standard: DASYS (IEEE/IEC/ANSI C63.19-2011)

DASY5 Configuration:

- Probe: EX3DV4 - SN3927; ConvF(8.1, 8.1, 8.1); Calibrated: 2014/5/23;
- Sensor-Surface: 4mm (Mechanical Surface Detection)
- Electronics: DAE4 Sn1379; Calibrated: 2014/5/19
- Phantom: SAM (30deg probe tilt) with CRP v5.0; Type: QD000P40CD
- Measurement SW: DASYS2, Version 52.8 (8);

**Configuration/WCDMA Band II Mid Body-Back/Area Scan (8x12x1):** Measurement grid:

$dx=15$ mm,  $dy=15$ mm, Maximum value of SAR (measured) = 0.296 W/kg

**Configuration/WCDMA Band II Mid Body-Back/Zoom Scan (5x5x7)/Cube 0:** Measurement grid:

$dx=8$ mm,  $dy=8$ mm,  $dz=5$ mm, Reference Value = 1.581 V/m; Power Drift = -0.12 dB

Peak SAR (extrapolated) = 0.482 W/kg

**SAR(1 g) = 0.273 W/kg; SAR(10 g) = 0.146 W/kg** Maximum value of SAR (measured) = 0.298 W/kg

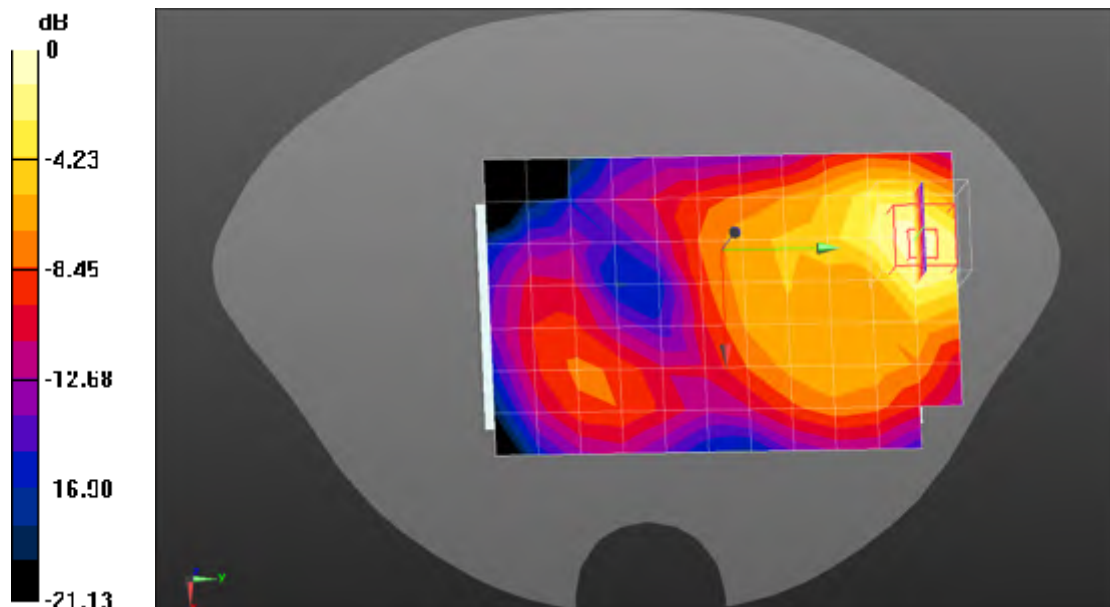

0 dB = 0.298 W/kg = -5.26 dBW/kg



Z-Axis Plot





Date/Time: 21/07/2014

Test Laboratory: CerpPASS Lab

DUT: Mobile Phone; Type: D554P, DxxxP(xxx: stand for 0~9)

**Procedure Name: WCDMA Band II Mid Body-Front**

Communication System Band: WCDMA Band II; Frequency: 1880 MHz; Duty Cycle: 1:1

Medium parameters used:  $f = 1880$  MHz;  $\sigma = 1.52$  S/m;  $\epsilon_r = 51.14$ ;  $\rho = 1000$  kg/m<sup>3</sup>

Phantom section: Flat Section; Tissue Temp (celsius) - 21°C

Measurement Standard: DASYS (IEEE/IEC/ANSI C63.19-2011)

DASY5 Configuration:

- Probe: EX3DV4 - SN3927; ConvF(8.1, 8.1, 8.1); Calibrated: 2014/5/23;
- Sensor-Surface: 4mm (Mechanical Surface Detection)
- Electronics: DAE4 Sn1379; Calibrated: 2014/5/19
- Phantom: SAM (30deg probe tilt) with CRP v5.0; Type: QD000P40CD
- Measurement SW: DASY52, Version 52.8 (8);

**Configuration/WCDMA Band II Mid Body-Front/Area Scan (8x12x1):** Measurement grid:

$dx=15$ mm,  $dy=15$ mm, Maximum value of SAR (measured) = 0.203 W/kg

**Configuration/WCDMA Band II Mid Body-Front/Zoom Scan (5x5x7)/Cube 0:** Measurement grid:

$dx=8$ mm,  $dy=8$ mm,  $dz=5$ mm, Reference Value = 2.592 V/m; Power Drift = 0.12 dB

Peak SAR (extrapolated) = 0.346 W/kg

**SAR(1 g) = 0.192 W/kg; SAR(10 g) = 0.104 W/kg** Maximum value of SAR (measured) = 0.210 W/kg

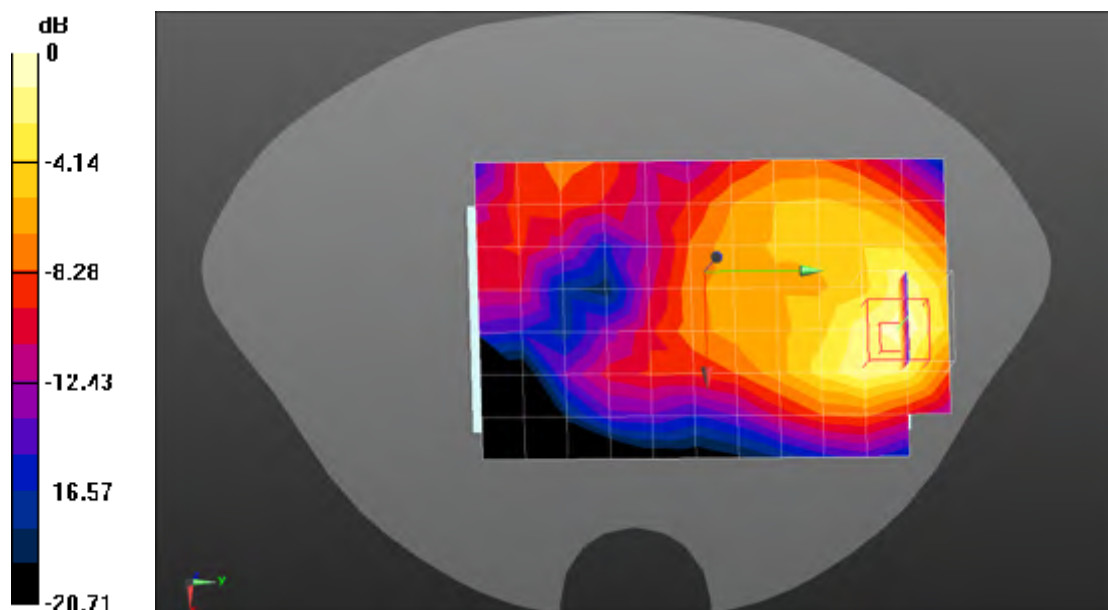

0 dB = 0.210 W/kg = -6.78 dBW/kg



Date/Time: 21/07/2014

Test Laboratory: CerpPASS Lab

DUT: Mobile Phone; Type: D554P, DxxxP(xxx: stand for 0~9)

**Procedure Name: WCDMA Band II Mid Body-Leftside**

Communication System Band: WCDMA Band II; Frequency: 1880 MHz; Duty Cycle: 1:1

Medium parameters used:  $f = 1880$  MHz;  $\sigma = 1.52$  S/m;  $\epsilon_r = 51.14$ ;  $\rho = 1000$  kg/m<sup>3</sup>

Phantom section: Flat Section; Tissue Temp (celsius) - 21°C

Measurement Standard: DASYS (IEEE/IEC/ANSI C63.19-2011)

DASY5 Configuration:

- Probe: EX3DV4 - SN3927; ConvF(8.1, 8.1, 8.1); Calibrated: 2014/5/23;
- Sensor-Surface: 4mm (Mechanical Surface Detection)
- Electronics: DAE4 Sn1379; Calibrated: 2014/5/19
- Phantom: SAM (30deg probe tilt) with CRP v5.0; Type: QD000P40CD
- Measurement SW: DASYS2, Version 52.8 (8);

**Configuration/WCDMA Band II Mid Body-Leftside/Area Scan (5x12x1):** Measurement grid:

$dx=15$ mm,  $dy=15$ mm, Maximum value of SAR (measured) = 0.105 W/kg

**Configuration/WCDMA Band II Mid Body-Leftside/Zoom Scan (5x5x7)/Cube 0:** Measurement

grid:  $dx=8$ mm,  $dy=8$ mm,  $dz=5$ mm, Reference Value = 5.045 V/m; Power Drift = 0.04 dB

Peak SAR (extrapolated) = 0.178 W/kg

**SAR(1 g) = 0.104 W/kg; SAR(10 g) = 0.060 W/kg** Maximum value of SAR (measured) = 0.114 W/kg

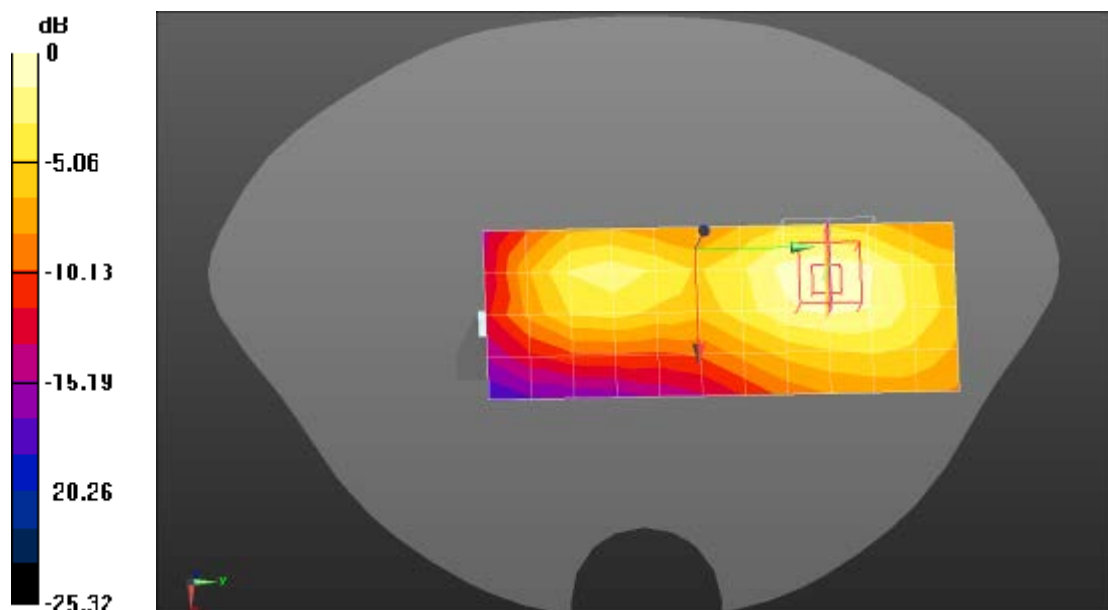

0 dB = 0.114 W/kg = -9.43 dBW/kg



Date/Time: 21/07/2014

Test Laboratory: CerpPASS Lab

DUT: Mobile Phone; Type: D554P, DxxxP(xxx: stand for 0~9)

**Procedure Name: WCDMA Band II Mid Body-Rightside**

Communication System Band: WCDMA Band II; Frequency: 1880 MHz; Duty Cycle: 1:1

Medium parameters used:  $f = 1880$  MHz;  $\sigma = 1.52$  S/m;  $\epsilon_r = 51.14$ ;  $\rho = 1000$  kg/m<sup>3</sup>

Phantom section: Flat Section; Tissue Temp (celsius) - 21°C

Measurement Standard: DASYS (IEEE/IEC/ANSI C63.19-2011)

DASY5 Configuration:

- Probe: EX3DV4 - SN3927; ConvF(8.1, 8.1, 8.1); Calibrated: 2014/5/23;
- Sensor-Surface: 4mm (Mechanical Surface Detection)
- Electronics: DAE4 Sn1379; Calibrated: 2014/5/19
- Phantom: SAM (30deg probe tilt) with CRP v5.0; Type: QD000P40CD
- Measurement SW: DASYS2, Version 52.8 (8);

**Configuration/WCDMA Band II Mid Body-Rightside/Area Scan (5x12x1):** Measurement grid:

$dx=15$ mm,  $dy=15$ mm, Maximum value of SAR (measured) = 0.0476 W/kg

**Configuration/WCDMA Band II Mid Body-Rightside/Zoom Scan (5x5x7)/Cube 0:** Measurement

grid:  $dx=8$ mm,  $dy=8$ mm,  $dz=5$ mm, Reference Value = 4.039 V/m; Power Drift = -0.08 dB

Peak SAR (extrapolated) = 0.0790 W/kg

**SAR(1 g) = 0.047 W/kg; SAR(10 g) = 0.027 W/kg** Maximum value of SAR (measured) = 0.0515 W/kg

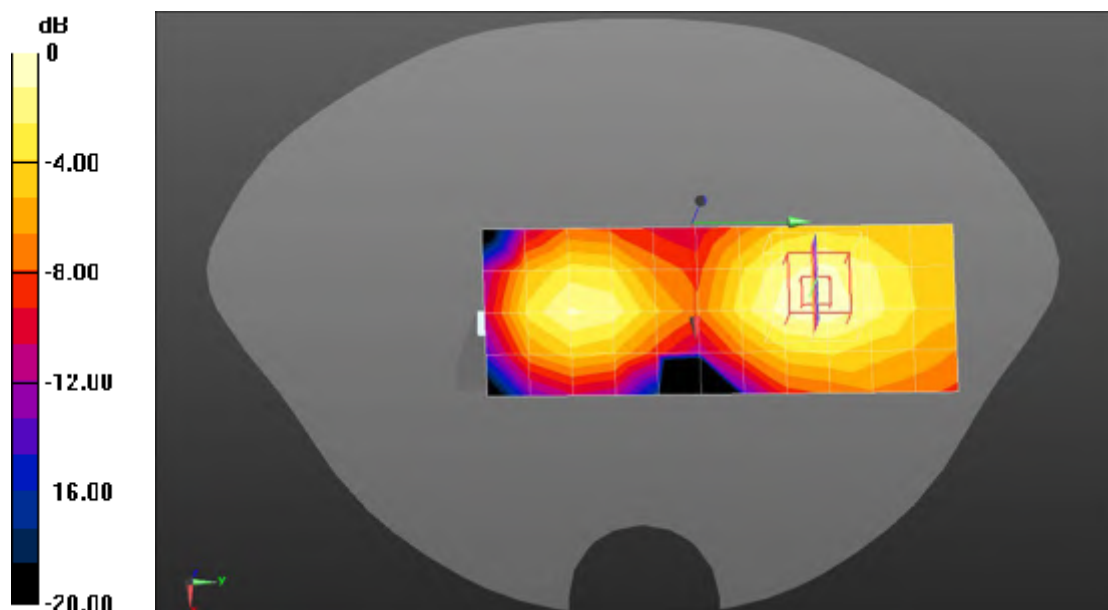

0 dB = 0.0515 W/kg = -12.88 dBW/kg



Date/Time: 21/07/2014

Test Laboratory: CerpPASS Lab

DUT: Mobile Phone; Type: D554P, DxxxP(xxx: stand for 0~9)

**Procedure Name: WCDMA Band II Mid Body-Bottom**

Communication System Band: WCDMA Band II; Frequency: 1880 MHz; Duty Cycle: 1:1

Medium parameters used:  $f = 1880$  MHz;  $\sigma = 1.52$  S/m;  $\epsilon_r = 51.14$ ;  $\rho = 1000$  kg/m<sup>3</sup>

Phantom section: Flat Section; Tissue Temp (celsius) - 21°C

Measurement Standard: DASYS (IEEE/IEC/ANSI C63.19-2011)

DASY5 Configuration:

- Probe: EX3DV4 - SN3927; ConvF(8.1, 8.1, 8.1); Calibrated: 2014/5/23;
- Sensor-Surface: 4mm (Mechanical Surface Detection)
- Electronics: DAE4 Sn1379; Calibrated: 2014/5/19
- Phantom: SAM (30deg probe tilt) with CRP v5.0; Type: QD000P40CD
- Measurement SW: DASYS2, Version 52.8 (8);

**Configuration/WCDMA Band II Mid Body-Bottom/Area Scan (5x8x1):** Measurement grid:

$dx=15$ mm,  $dy=15$ mm, Maximum value of SAR (measured) = 0.167 W/kg

**Configuration/WCDMA Band II Mid Body-Bottom/Zoom Scan (5x5x7)/Cube 0:** Measurement grid:

$dx=8$ mm,  $dy=8$ mm,  $dz=5$ mm, Reference Value = 7.465 V/m; Power Drift = 0.09 dB

Peak SAR (extrapolated) = 0.316 W/kg

**SAR(1 g) = 0.182 W/kg; SAR(10 g) = 0.100 W/kg** Maximum value of SAR (measured) = 0.203 W/kg

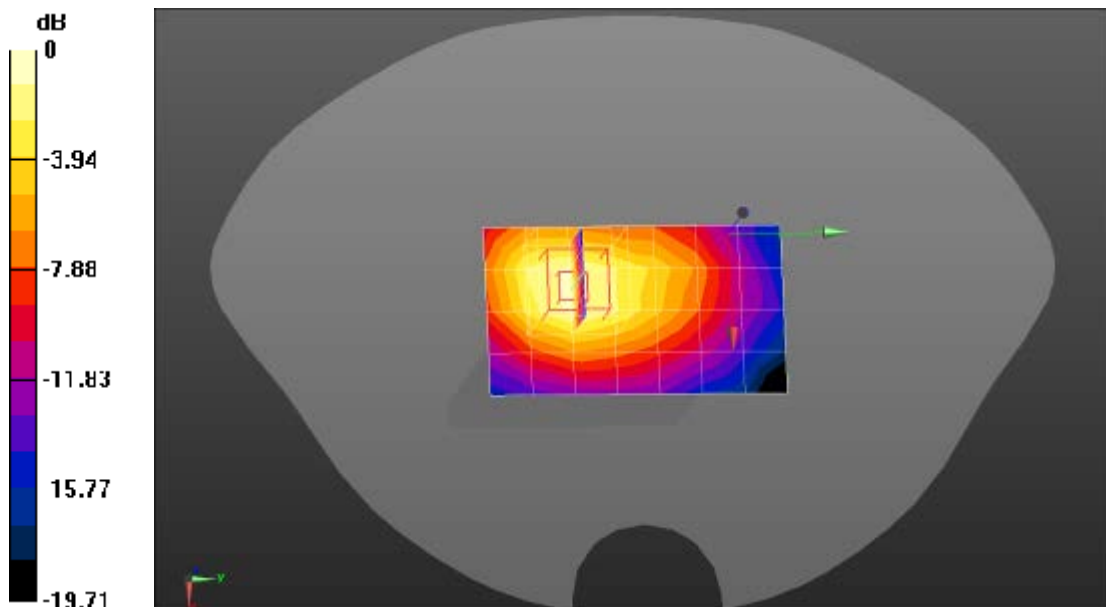

0 dB = 0.203 W/kg = -6.93 dBW/kg





Date/Time: 21/07/2014

Test Laboratory: CerpPASS Lab

DUT: Mobile Phone; Type: D554P, DxxxP(xxx: stand for 0~9)

**Procedure Name: WCDMA Band IV Mid Touch-Left**

Communication System Band: WCDMA Band IV; Frequency: 1732.6 MHz; Duty Cycle: 1:1

Medium parameters used:  $f = 1732.6$  MHz;  $\sigma = 1.36$  S/m;  $\epsilon_r = 40.13$ ;  $\rho = 1000$  kg/m<sup>3</sup>

Phantom section: Left Section; Tissue Temp(celsius)- 21 °C

Measurement Standard: DASYS (IEEE/IEC/ANSI C63.19-2011)

DASY5 Configuration:

- Probe: EX3DV4 - SN3927; ConvF(8.55, 8.55, 8.55); Calibrated: 2014/5/23;
- Sensor-Surface: 2mm (Mechanical Surface Detection)
- Electronics: DAE4 Sn1379; Calibrated: 2014/5/19
- Phantom: SAM (30deg probe tilt) with CRP v5.0; Type: QD000P40CD
- Measurement SW: DASYS2, Version 52.8 (8);

**Configuration/WCDMA Band IV Mid Touch-Left/Area Scan (9x13x1):** Measurement grid:

$dx=15$ mm,  $dy=15$ mm, Maximum value of SAR (measured) = 0.0904 W/kg

**Configuration/WCDMA Band IV Mid Touch-Left/Zoom Scan (5x5x7)/Cube 0:** Measurement grid:

$dx=8$ mm,  $dy=8$ mm,  $dz=5$ mm, Reference Value = 1.426 V/m; Power Drift = 0.19 dB

Peak SAR (extrapolated) = 0.121 W/kg

**SAR(1 g) = 0.059 W/kg; SAR(10 g) = 0.027 W/kg** Maximum value of SAR (measured) = 0.0819 W/kg

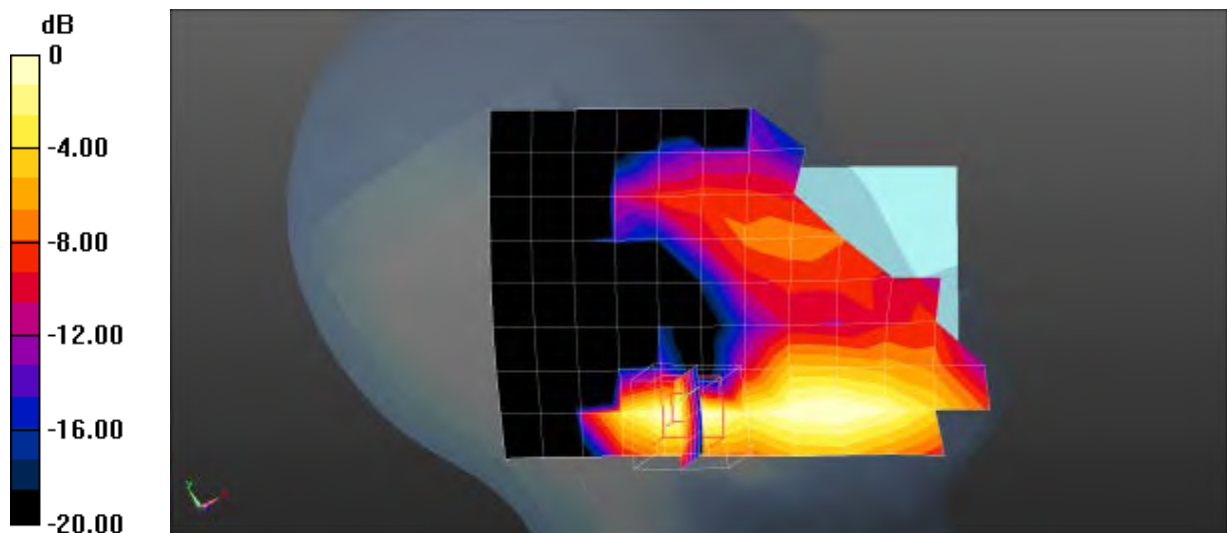

0 dB = 0.0819 W/kg = -10.87 dBW/kg



Date/Time: 21/07/2014

Test Laboratory: CerpPASS Lab

DUT: Mobile Phone; Type: D554P, DxxxP(xxx: stand for 0~9)

**Procedure Name: WCDMA Band IV Mid Tilt-Left**

Communication System Band: WCDMA Band IV; Frequency: 1732.6 MHz; Duty Cycle: 1:1

Medium parameters used:  $f = 1732.6$  MHz;  $\sigma = 1.36$  S/m;  $\epsilon_r = 40.13$ ;  $\rho = 1000$  kg/m<sup>3</sup>

Phantom section: Left Section; Tissue Temp(celsius)- 21 °C

Measurement Standard: DASYS (IEEE/IEC/ANSI C63.19-2011)

DASY5 Configuration:

- Probe: EX3DV4 - SN3927; ConvF(8.55, 8.55, 8.55); Calibrated: 2014/5/23;
- Sensor-Surface: 2mm (Mechanical Surface Detection)
- Electronics: DAE4 Sn1379; Calibrated: 2014/5/19
- Phantom: SAM (30deg probe tilt) with CRP v5.0; Type: QD000P40CD
- Measurement SW: DASYS2, Version 52.8 (8);

**Configuration/WCDMA Band IV Mid Tilt-Left/Area Scan (9x13x1):** Measurement grid: dx=15mm, dy=15mm, Maximum value of SAR (measured) = 0.0139 W/kg

**Configuration/WCDMA Band IV Mid Tilt-Left/Zoom Scan (6x7x7)/Cube 0:** Measurement grid: dx=8mm, dy=8mm, dz=5mm, Reference Value = 2.414 V/m; Power Drift = 0.14 dB

Peak SAR (extrapolated) = 0.0120 W/kg

**SAR(1 g) = 0.00688 W/kg; SAR(10 g) = 0.00333 W/kg** Maximum value of SAR (measured) = 0.00969 W/kg

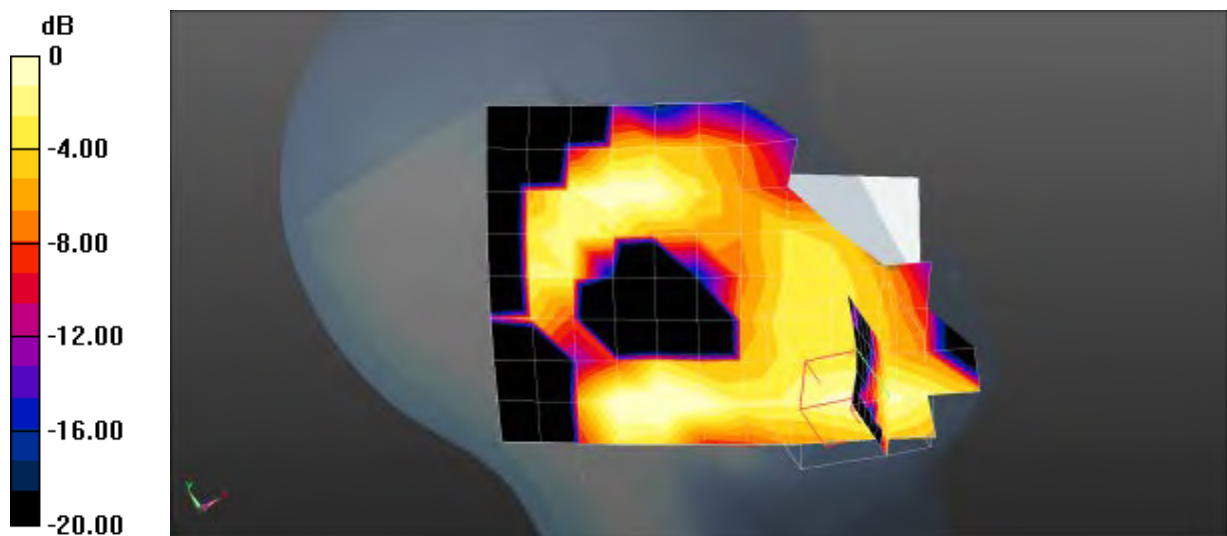

0 dB = 0.00969 W/kg = -20.14 dBW/kg





Date/Time: 21/07/2014

Test Laboratory: CerpPASS Lab

DUT: Mobile Phone; Type: D554P, DxxxP(xxx: stand for 0~9)

**Procedure Name: WCDMA Band IV Mid Touch-Right**

Communication System Band: WCDMA Band IV; Frequency: 1732.6 MHz; Duty Cycle: 1:1

Medium parameters used:  $f = 1732.6$  MHz;  $\sigma = 1.36$  S/m;  $\epsilon_r = 40.13$ ;  $\rho = 1000$  kg/m<sup>3</sup>

Phantom section: Right Section; Tissue Temp(celsius)- 21 °C

Measurement Standard: DASYS (IEEE/IEC/ANSI C63.19-2011)

DASY5 Configuration:

- Probe: EX3DV4 - SN3927; ConvF(8.55, 8.55, 8.55); Calibrated: 2014/5/23;
- Sensor-Surface: 2mm (Mechanical Surface Detection)
- Electronics: DAE4 Sn1379; Calibrated: 2014/5/19
- Phantom: SAM (30deg probe tilt) with CRP v5.0; Type: QD000P40CD
- Measurement SW: DASY52, Version 52.8 (8);

**Configuration/WCDMA Band IV Mid Touch-Right/Area Scan (9x13x1):** Measurement grid:

$dx=15$ mm,  $dy=15$ mm, Maximum value of SAR (measured) = 0.145 W/kg

**Configuration/WCDMA Band IV Mid Touch-Right/Zoom Scan (5x5x7)/Cube 0:** Measurement grid:

$dx=8$ mm,  $dy=8$ mm,  $dz=5$ mm, Reference Value = 1.102 V/m; Power Drift = 0.14 dB

Peak SAR (extrapolated) = 0.224 W/kg

**SAR(1 g) = 0.107 W/kg; SAR(10 g) = 0.048 W/kg** Maximum value of SAR (measured) = 0.149 W/kg

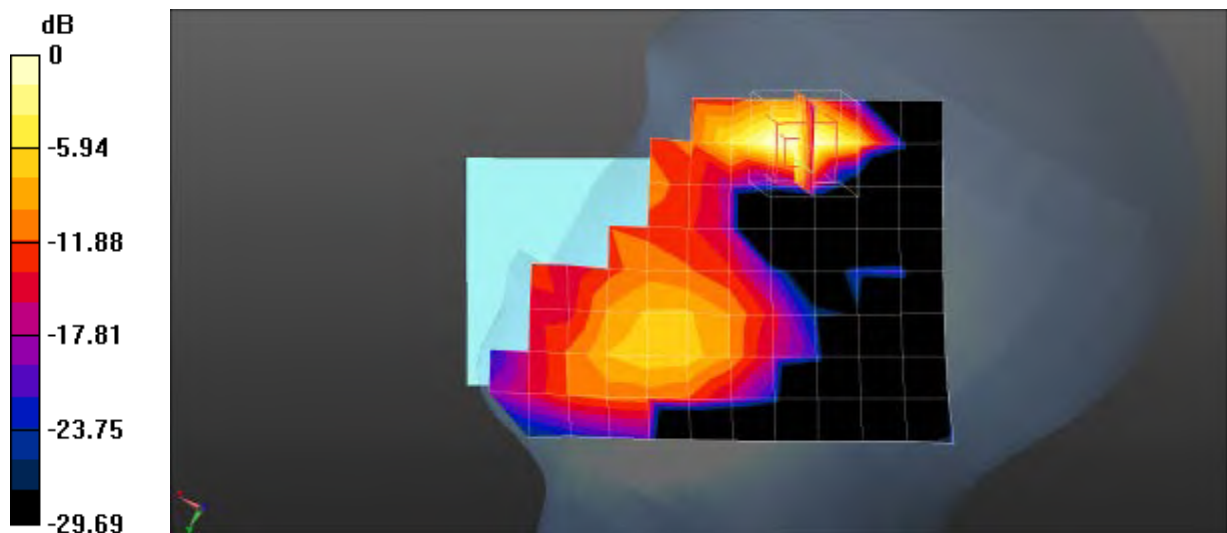

0 dB = 0.149 W/kg = -8.27 dBW/kg



Date/Time: 21/07/2014

Test Laboratory: CerpPASS Lab

DUT: Mobile Phone; Type: D554P, DxxxP(xxx: stand for 0~9)

**Procedure Name: WCDMA Band IV Mid Tilt-Right**

Communication System Band: WCDMA Band IV; Frequency: 1732.6 MHz; Duty Cycle: 1:1

Medium parameters used:  $f = 1732.6$  MHz;  $\sigma = 1.36$  S/m;  $\epsilon_r = 40.13$ ;  $\rho = 1000$  kg/m<sup>3</sup>

Phantom section: Right Section; Tissue Temp(celsius)- 21 °C

Measurement Standard: DASYS (IEEE/IEC/ANSI C63.19-2011)

DASY5 Configuration:

- Probe: EX3DV4 - SN3927; ConvF(8.55, 8.55, 8.55); Calibrated: 2014/5/23;
- Sensor-Surface: 2mm (Mechanical Surface Detection)
- Electronics: DAE4 Sn1379; Calibrated: 2014/5/19
- Phantom: SAM (30deg probe tilt) with CRP v5.0; Type: QD000P40CD
- Measurement SW: DASY52, Version 52.8 (8);

**Configuration/WCDMA Band IV Mid Tilt-Right/Area Scan (9x13x1):** Measurement grid: dx=15mm, dy=15mm, Maximum value of SAR (measured) = 0.0356 W/kg

**Configuration/WCDMA Band IV Mid Tilt-Right/Zoom Scan (5x5x7)/Cube 0:** Measurement grid: dx=8mm, dy=8mm, dz=5mm, Reference Value = 2.611 V/m; Power Drift = 0.04 dB

Peak SAR (extrapolated) = 0.0420 W/kg

**SAR(1 g) = 0.025 W/kg; SAR(10 g) = 0.013 W/kg** Maximum value of SAR (measured) = 0.0303 W/kg

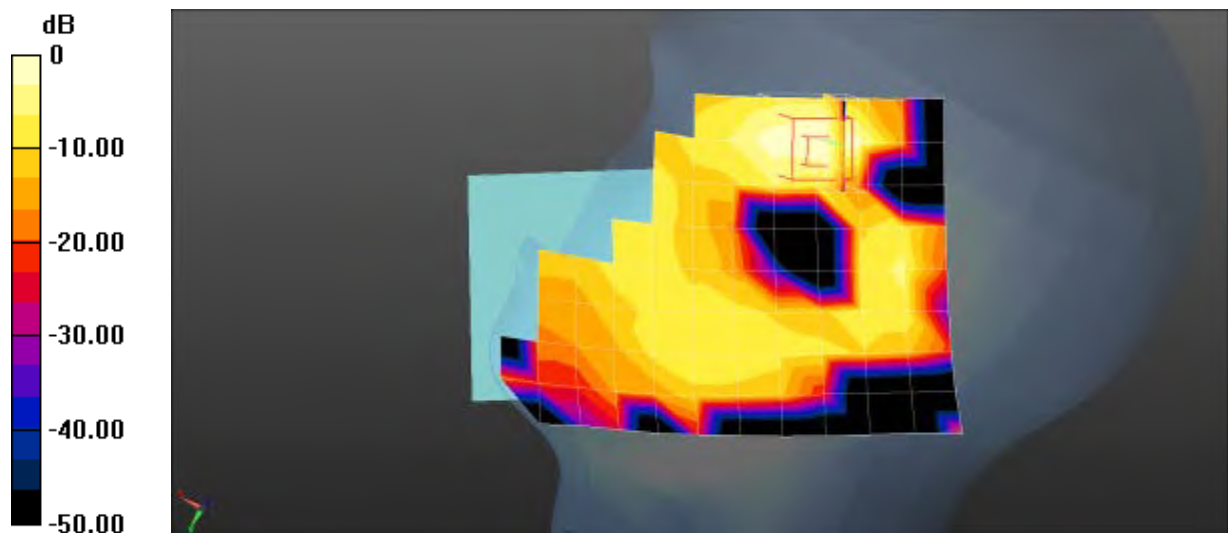

0 dB = 0.0303 W/kg = -15.19 dBW/kg



Date/Time: 21/07/2014

Test Laboratory: CerpPASS Lab

DUT: Mobile Phone; Type: D554P, DxxxP(xxx: stand for 0~9)

**Procedure Name: WCDMA Band IV Mid Body-Back**

Communication System Band: WCDMA Band IV; Frequency: 1732.6 MHz; Duty Cycle: 1:1

Medium parameters used:  $f = 1732.6$  MHz;  $\sigma = 1.47$  S/m;  $\epsilon_r = 53.19$ ;  $\rho = 1000$  kg/m<sup>3</sup>

Phantom section: Flat Section; Tissue Temp(celsius)- 21 °C

Measurement Standard: DASYS (IEEE/IEC/ANSI C63.19-2011)

DASY5 Configuration:

- Probe: EX3DV4 - SN3927; ConvF(8.45, 8.45, 8.45); Calibrated: 2014/5/23;
- Sensor-Surface: 4mm (Mechanical Surface Detection)
- Electronics: DAE4 Sn1379; Calibrated: 2014/5/19
- Phantom: SAM (30deg probe tilt) with CRP v5.0; Type: QD000P40CD
- Measurement SW: DASYS2, Version 52.8 (8);

**Configuration/WCDMA Band IV Mid Body-Back/Area Scan (8x12x1):** Measurement grid:

$dx=15$ mm,  $dy=15$ mm, Maximum value of SAR (measured) = 0.459 W/kg

**Configuration/WCDMA Band IV Mid Body-Back/Zoom Scan (5x5x7)/Cube 0:** Measurement grid:

$dx=8$ mm,  $dy=8$ mm,  $dz=5$ mm, Reference Value = 3.178 V/m; Power Drift = 0.12 dB

Peak SAR (extrapolated) = 1.00 W/kg

**SAR(1 g) = 0.538 W/kg; SAR(10 g) = 0.268 W/kg** Maximum value of SAR (measured) = 0.616 W/kg

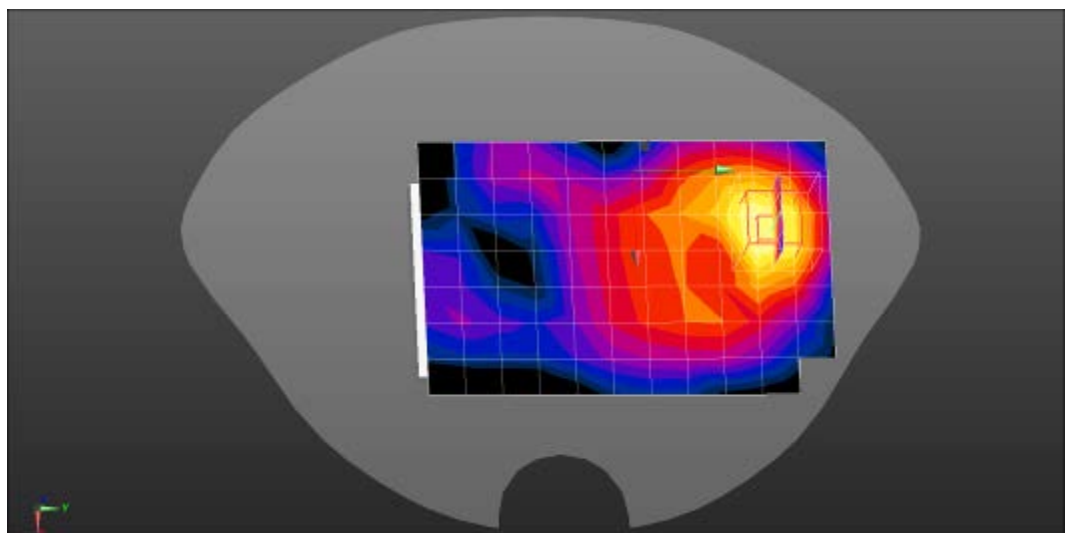
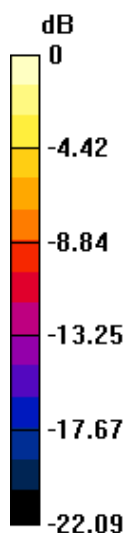

0 dB = 0.616 W/kg = -2.10 dBW/kg



Z-Axis Plot

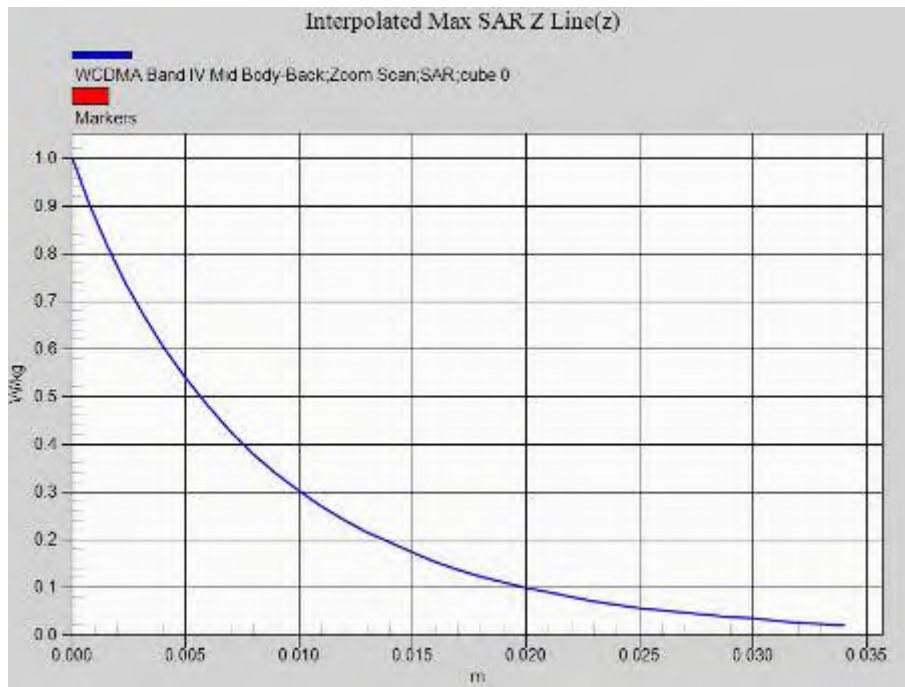



Date/Time: 21/07/2014

Test Laboratory: CerpPASS Lab

DUT: Mobile Phone; Type: D554P, DxxxP(xxx: stand for 0~9)

**Procedure Name: WCDMA Band IV Mid Body-Front**

Communication System Band: WCDMA Band IV; Frequency: 1732.6 MHz; Duty Cycle: 1:1

Medium parameters used:  $f = 1732.6$  MHz;  $\sigma = 1.47$  S/m;  $\epsilon_r = 53.19$ ;  $\rho = 1000$  kg/m<sup>3</sup>

Phantom section: Flat Section; Tissue Temp(celsius)- 21 °C

Measurement Standard: DASYS (IEEE/IEC/ANSI C63.19-2011)

DASY5 Configuration:

- Probe: EX3DV4 - SN3927; ConvF(8.45, 8.45, 8.45); Calibrated: 2014/5/23;
- Sensor-Surface: 4mm (Mechanical Surface Detection)
- Electronics: DAE4 Sn1379; Calibrated: 2014/5/19
- Phantom: SAM (30deg probe tilt) with CRP v5.0; Type: QD000P40CD
- Measurement SW: DASYS2, Version 52.8 (8);

**Configuration/WCDMA Band IV Mid Body-Front/Area Scan (8x12x1):** Measurement grid:

$dx=15$ mm,  $dy=15$ mm, Maximum value of SAR (measured) = 0.355 W/kg

**Configuration/WCDMA Band IV Mid Body-Front/Zoom Scan (5x5x7)/Cube 0:** Measurement grid:

$dx=8$ mm,  $dy=8$ mm,  $dz=5$ mm, Reference Value = 1.148 V/m; Power Drift = 0.19 dB

Peak SAR (extrapolated) = 0.661 W/kg

**SAR(1 g) = 0.358 W/kg; SAR(10 g) = 0.178 W/kg** Maximum value of SAR (measured) = 0.394 W/kg

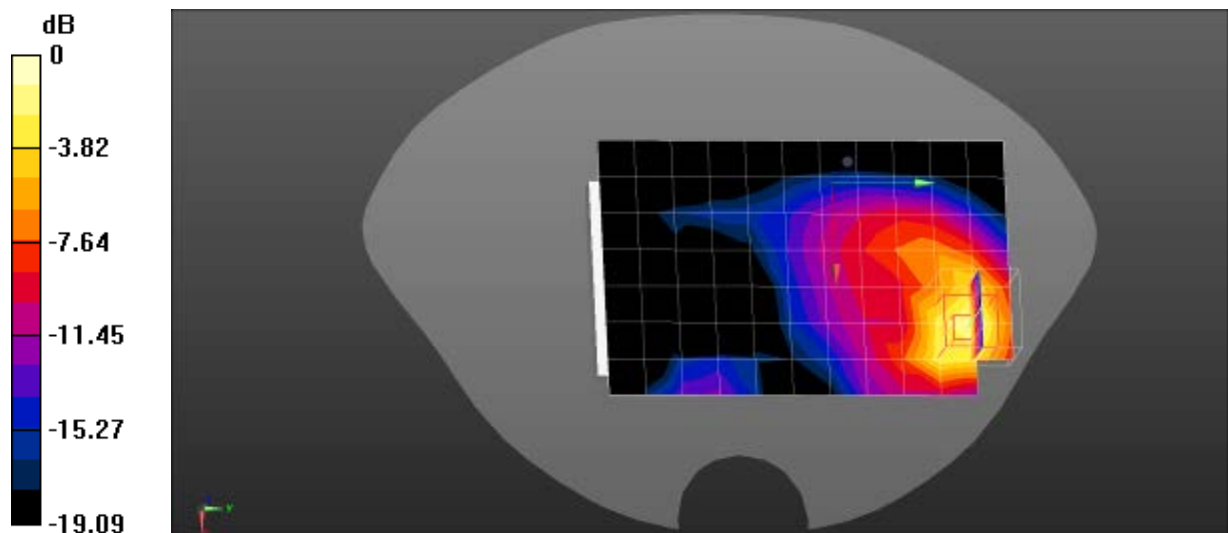

0 dB = 0.394 W/kg = -4.05 dBW/kg



Date/Time: 21/07/2014

Test Laboratory: CerpPASS Lab

DUT: Mobile Phone; Type: D554P, DxxxP(xxx: stand for 0~9)

**Procedure Name: WCDMA Band IV Mid Body-Leftside**

Communication System Band: WCDMA Band IV; Frequency: 1732.6 MHz; Duty Cycle: 1:1

Medium parameters used:  $f = 1732.6$  MHz;  $\sigma = 1.47$  S/m;  $\epsilon_r = 53.19$ ;  $\rho = 1000$  kg/m<sup>3</sup>

Phantom section: Flat Section; Tissue Temp(celsius)- 21 °C

Measurement Standard: DASYS (IEEE/IEC/ANSI C63.19-2011)

DASY5 Configuration:

- Probe: EX3DV4 - SN3927; ConvF(8.45, 8.45, 8.45); Calibrated: 2014/5/23;
- Sensor-Surface: 4mm (Mechanical Surface Detection)
- Electronics: DAE4 Sn1379; Calibrated: 2014/5/19
- Phantom: SAM (30deg probe tilt) with CRP v5.0; Type: QD000P40CD
- Measurement SW: DASYS2, Version 52.8 (8);

**Configuration/WCDMA Band IV Mid Body-Leftside/Area Scan (6x12x1):** Measurement grid:

$dx=15$ mm,  $dy=15$ mm, Maximum value of SAR (measured) = 0.0430 W/kg

**Configuration/WCDMA Band IV Mid Body-Leftside/Zoom Scan (5x5x7)/Cube 0:** Measurement

grid:  $dx=8$ mm,  $dy=8$ mm,  $dz=5$ mm, Reference Value = 4.253 V/m; Power Drift = -0.13 dB

Peak SAR (extrapolated) = 0.0360 W/kg

**SAR(1 g) = 0.021 W/kg; SAR(10 g) = 0.010 W/kg** Maximum value of SAR (measured) = 0.0258 W/kg

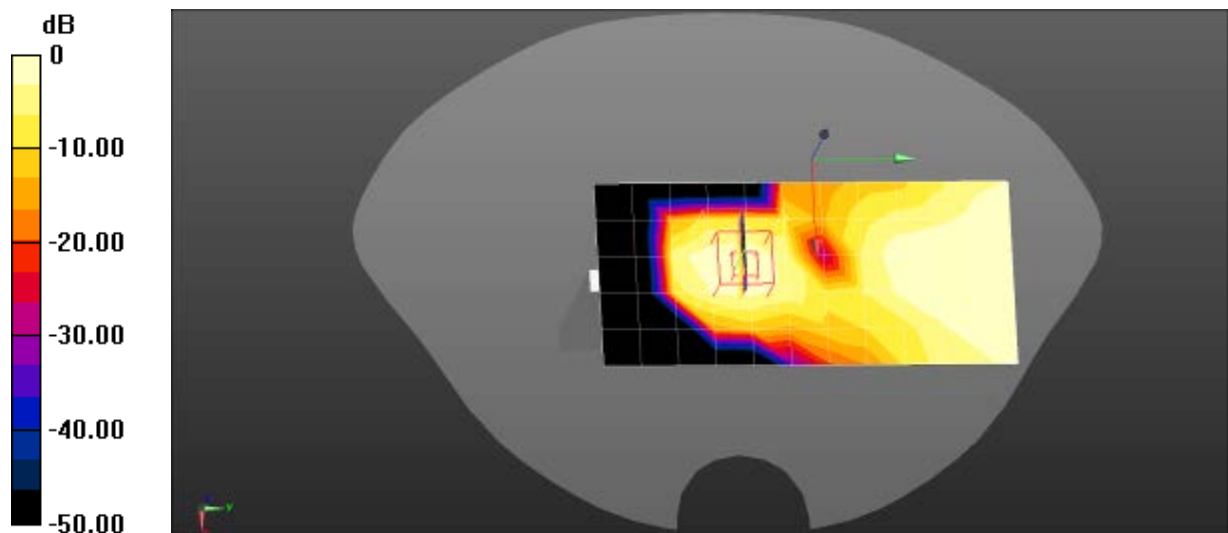

0 dB = 0.0258 W/kg = -15.88 dBW/kg



Date/Time: 21/07/2014

Test Laboratory: CerpPASS Lab

DUT: Mobile Phone; Type: D554P, DxxxP(xxx: stand for 0~9)

**Procedure Name: WCDMA Band IV Mid Body-Rightside**

Communication System Band: WCDMA Band IV; Frequency: 1732.6 MHz; Duty Cycle: 1:1

Medium parameters used:  $f = 1732.6$  MHz;  $\sigma = 1.47$  S/m;  $\epsilon_r = 53.19$ ;  $\rho = 1000$  kg/m<sup>3</sup>

Phantom section: Flat Section; Tissue Temp(celsius)- 21 °C

Measurement Standard: DASYS (IEEE/IEC/ANSI C63.19-2011)

DASY5 Configuration:

- Probe: EX3DV4 - SN3927; ConvF(8.45, 8.45, 8.45); Calibrated: 2014/5/23;
- Sensor-Surface: 4mm (Mechanical Surface Detection)
- Electronics: DAE4 Sn1379; Calibrated: 2014/5/19
- Phantom: SAM (30deg probe tilt) with CRP v5.0; Type: QD000P40CD
- Measurement SW: DASYS2, Version 52.8 (8);

**Configuration/WCDMA Band IV Mid Body-Rightside/Area Scan (6x12x1):** Measurement grid:

$dx=15$ mm,  $dy=15$ mm, Maximum value of SAR (measured) = 0.0127 W/kg

**Configuration/WCDMA Band IV Mid Body-Rightside/Zoom Scan (5x5x7)/Cube 0:** Measurement

grid:  $dx=8$ mm,  $dy=8$ mm,  $dz=5$ mm, Reference Value = 1.178 V/m; Power Drift = -0.16 dB

Peak SAR (extrapolated) = 0.0180 W/kg

**SAR(1 g) = 0.011 W/kg; SAR(10 g) = 0.00525 W/kg**

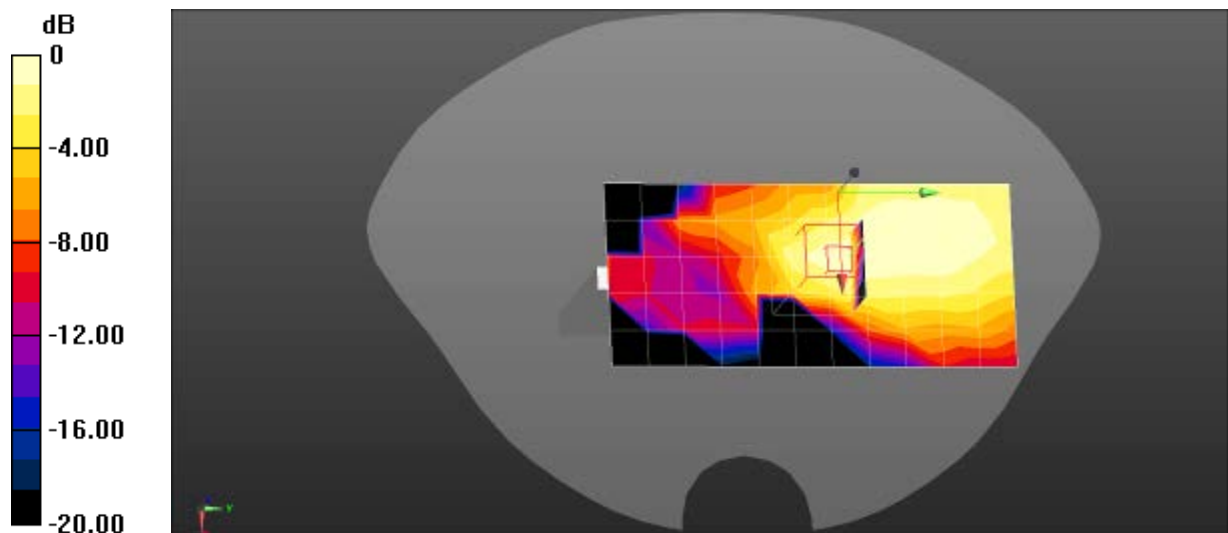

0 dB = 0.0127 W/kg = -18.96 dBW/kg





Date/Time: 21/07/2014

Test Laboratory: CerpPASS Lab

DUT: Mobile Phone; Type: D554P, DxxxP(xxx: stand for 0~9)

**Procedure Name: WCDMA Band IV Mid Body-Bottom**

Communication System Band: WCDMA Band IV; Frequency: 1732.6 MHz; Duty Cycle: 1:1

Medium parameters used:  $f = 1732.6$  MHz;  $\sigma = 1.47$  S/m;  $\epsilon_r = 53.19$ ;  $\rho = 1000$  kg/m<sup>3</sup>

Phantom section: Flat Section; Tissue Temp(celsius)- 21 °C

Measurement Standard: DASYS (IEEE/IEC/ANSI C63.19-2011)

DASY5 Configuration:

- Probe: EX3DV4 - SN3927; ConvF(8.45, 8.45, 8.45); Calibrated: 2014/5/23;
- Sensor-Surface: 4mm (Mechanical Surface Detection)
- Electronics: DAE4 Sn1379; Calibrated: 2014/5/19
- Phantom: SAM (30deg probe tilt) with CRP v5.0; Type: QD000P40CD
- Measurement SW: DASYS2, Version 52.8 (8);

**Configuration/WCDMA Band IV Mid Body-Bottom/Area Scan (5x8x1):** Measurement grid:

$dx=15$ mm,  $dy=15$ mm, Maximum value of SAR (measured) = 0.567 W/kg

**Configuration/WCDMA Band IV Mid Body-Bottom/Zoom Scan (5x5x7)/Cube 0:** Measurement

grid:  $dx=8$ mm,  $dy=8$ mm,  $dz=5$ mm, Reference Value = 10.63 V/m; Power Drift = 0.15 dB

Peak SAR (extrapolated) = 0.926 W/kg

**SAR(1 g) = 0.513 W/kg; SAR(10 g) = 0.256 W/kg** Maximum value of SAR (measured) = 0.582 W/kg

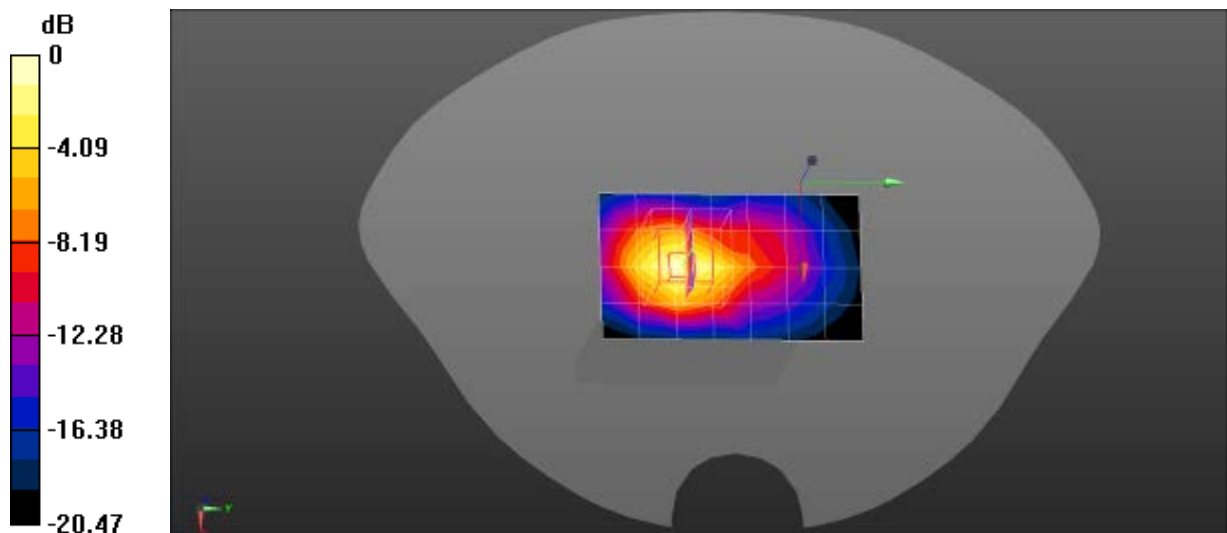

0 dB = 0.582 W/kg = -2.35 dBW/kg





Date/Time: 21/07/2014

Test Laboratory: CerpPASS Lab

DUT: Mobile Phone; Type: D554P, DxxxP(xxx: stand for 0~9)

**Procedure Name: WCDMA Band V Mid Touch-Left**

Communication System Band: WCDMA Band V; Frequency: 836.6 MHz; Duty Cycle: 1:1

Medium parameters used:  $f = 836.6$  MHz;  $\sigma = 0.89$  S/m;  $\epsilon_r = 41.48$ ;  $\rho = 1000$  kg/m<sup>3</sup>

Phantom section: Left Section; Tissue Temp (celsius) - 21°C

Measurement Standard: DASYS (IEEE/IEC/ANSI C63.19-2011)

DASY5 Configuration:

- Probe: EX3DV4 - SN3927; ConvF(10.23, 10.23, 10.23); Calibrated: 2014/5/23;
- Sensor-Surface: 4mm (Mechanical Surface Detection)
- Electronics: DAE4 Sn1379; Calibrated: 2014/5/19
- Phantom: SAM (30deg probe tilt) with CRP v5.0; Type: QD000P40CD
- Measurement SW: DASYS2, Version 52.8 (8);

**Configuration/WCDMA Band V Mid Touch-Left/Area Scan (8x13x1):** Measurement grid:

$dx=15$ mm,  $dy=15$ mm, Maximum value of SAR (measured) = 0.0402 W/kg

**Configuration/WCDMA Band V Mid Touch-Left/Zoom Scan (5x5x7)/Cube 0:** Measurement grid:

$dx=8$ mm,  $dy=8$ mm,  $dz=5$ mm, Reference Value = 3.147 V/m; Power Drift = 0.12 dB

Peak SAR (extrapolated) = 0.0570 W/kg

**SAR(1 g) = 0.038 W/kg; SAR(10 g) = 0.024 W/kg** Maximum value of SAR (measured) = 0.0408 W/kg

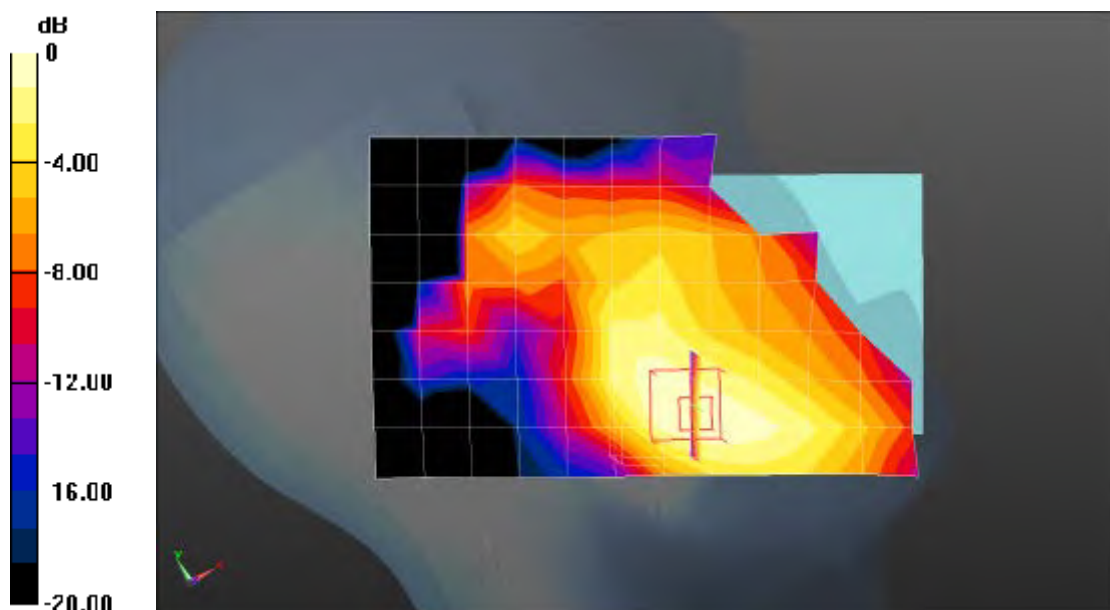

0 dB = 0.0408 W/kg = -13.89 dBW/kg



Date/Time: 21/07/2014

Test Laboratory: CerpPASS Lab

DUT: Mobile Phone; Type: D554P, DxxxP(xxx: stand for 0~9)

**Procedure Name: WCDMA Band V Mid Tilt-Left**

Communication System Band: WCDMA Band V; Frequency: 836.6 MHz; Duty Cycle: 1:1

Medium parameters used:  $f = 836.6$  MHz;  $\sigma = 0.89$  S/m;  $\epsilon_r = 41.48$ ;  $\rho = 1000$  kg/m<sup>3</sup>

Phantom section: Left Section; Tissue Temp (celsius) - 21 °C

Measurement Standard: DASYS (IEEE/IEC/ANSI C63.19-2011)

DASY5 Configuration:

- Probe: EX3DV4 - SN3927; ConvF(10.23, 10.23, 10.23); Calibrated: 2014/5/23;
- Sensor-Surface: 4mm (Mechanical Surface Detection)
- Electronics: DAE4 Sn1379; Calibrated: 2014/5/19
- Phantom: SAM (30deg probe tilt) with CRP v5.0; Type: QD000P40CD
- Measurement SW: DASYS2, Version 52.8 (8);

**Configuration/WCDMA Band V Mid Tilt-Left/Area Scan (8x13x1):** Measurement grid: dx=15mm, dy=15mm, Maximum value of SAR (measured) = 0.0205 W/kg

**Configuration/WCDMA Band V Mid Tilt-Left/Zoom Scan (5x5x7)/Cube 0:** Measurement grid: dx=8mm, dy=8mm, dz=5mm, Reference Value = 4.479 V/m; Power Drift = 0.19 dB

Peak SAR (extrapolated) = 0.0290 W/kg

**SAR(1 g) = 0.016 W/kg; SAR(10 g) = 0.00864 W/kg** Maximum value of SAR (measured) = 0.0186 W/kg

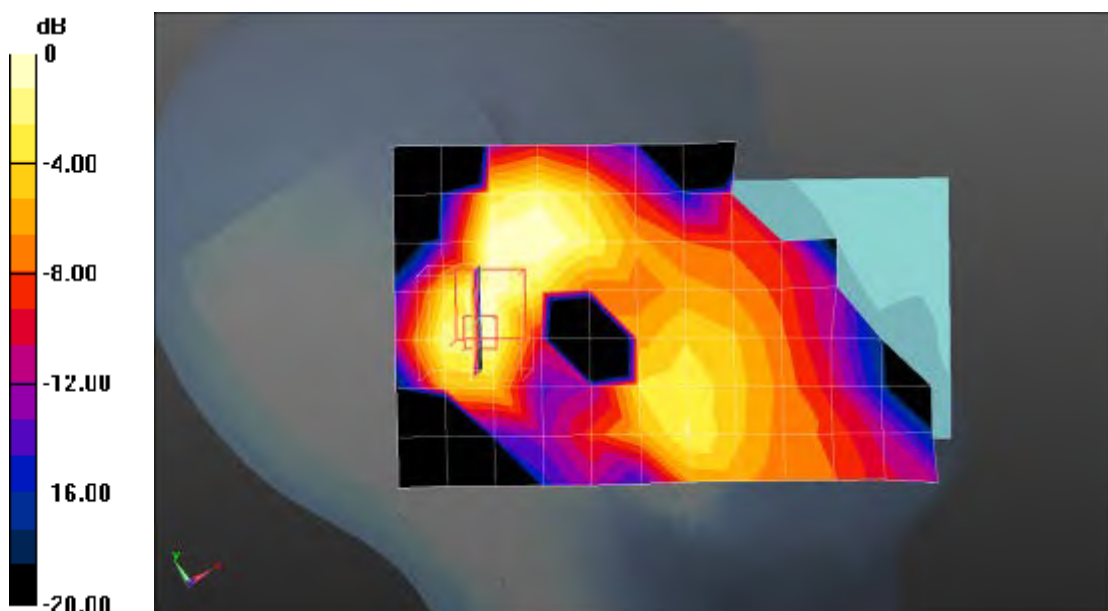

0 dB = 0.0186 W/kg = -17.30 dBW/kg



Date/Time: 21/07/2014

Test Laboratory: CerpPASS Lab

DUT: Mobile Phone; Type: D554P, DxxxP(xxx: stand for 0~9)

**Procedure Name: WCDMA Band V Mid Touch-Right**

Communication System Band: WCDMA Band V; Frequency: 836.6 MHz; Duty Cycle: 1:1

Medium parameters used:  $f = 836.6$  MHz;  $\sigma = 0.89$  S/m;  $\epsilon_r = 41.48$ ;  $\rho = 1000$  kg/m<sup>3</sup>

Phantom section: Right Section; Tissue Temp (celsius) - 21°C

Measurement Standard: DASYS (IEEE/IEC/ANSI C63.19-2011)

DASY5 Configuration:

- Probe: EX3DV4 - SN3927; ConvF(10.23, 10.23, 10.23); Calibrated: 2014/5/23;
- Sensor-Surface: 4mm (Mechanical Surface Detection)
- Electronics: DAE4 Sn1379; Calibrated: 2014/5/19
- Phantom: SAM (30deg probe tilt) with CRP v5.0; Type: QD000P40CD
- Measurement SW: DASY52, Version 52.8 (8);

**Configuration/WCDMA Band V Mid Touch-Right/Area Scan (8x13x1):** Measurement grid:

$dx=15$ mm,  $dy=15$ mm, Maximum value of SAR (measured) = 0.0239 W/kg

**Configuration/WCDMA Band V Mid Touch-Right/Zoom Scan (5x5x7)/Cube 0:** Measurement grid:

$dx=8$ mm,  $dy=8$ mm,  $dz=5$ mm, Reference Value = 2.862 V/m; Power Drift = 0.10 dB

Peak SAR (extrapolated) = 0.0360 W/kg

**SAR(1 g) = 0.024 W/kg; SAR(10 g) = 0.015 W/kg** Maximum value of SAR (measured) = 0.0258 W/kg

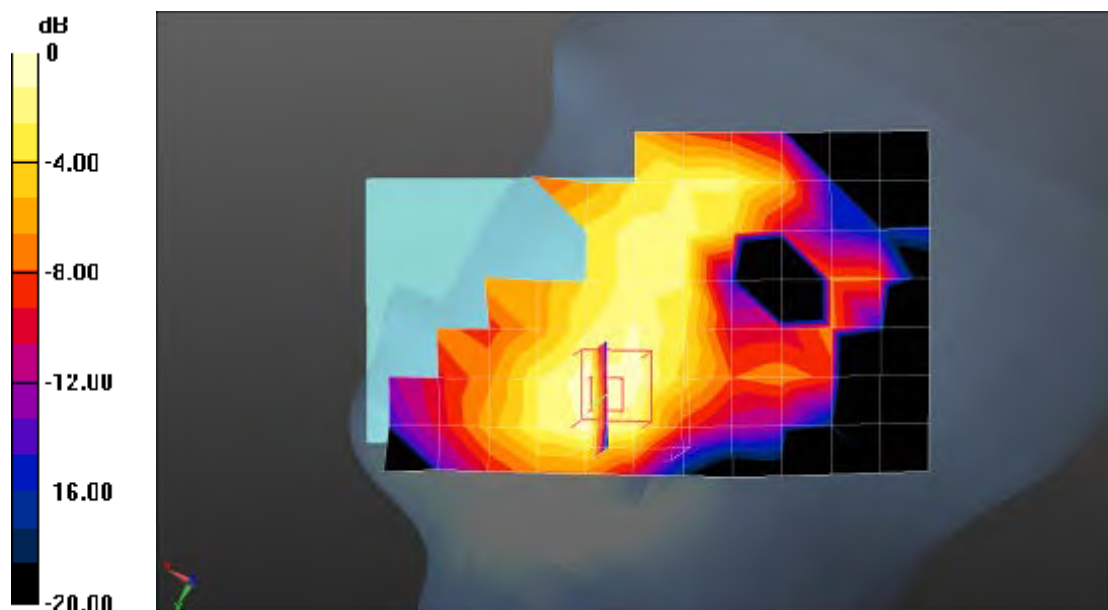

0 dB = 0.0258 W/kg = -15.88 dBW/kg



Date/Time: 21/07/2014

Test Laboratory: CerpPASS Lab

DUT: Mobile Phone; Type: D554P, DxxxP(xxx: stand for 0~9)

**Procedure Name: WCDMA Band V Mid Tilt-Right**

Communication System Band: WCDMA Band V; Frequency: 836.6 MHz; Duty Cycle: 1:1

Medium parameters used:  $f = 836.6$  MHz;  $\sigma = 0.89$  S/m;  $\epsilon_r = 41.48$ ;  $\rho = 1000$  kg/m<sup>3</sup>

Phantom section: Right Section; Tissue Temp (celsius) - 21°C

Measurement Standard: DASYS (IEEE/IEC/ANSI C63.19-2011)

DASY5 Configuration:

- Probe: EX3DV4 - SN3927; ConvF(10.23, 10.23, 10.23); Calibrated: 2014/5/23;
- Sensor-Surface: 4mm (Mechanical Surface Detection)
- Electronics: DAE4 Sn1379; Calibrated: 2014/5/19
- Phantom: SAM (30deg probe tilt) with CRP v5.0; Type: QD000P40CD
- Measurement SW: DASYS2, Version 52.8 (8);

**Configuration/WCDMA Band V Mid Tilt-Right/Area Scan (8x13x1):** Measurement grid: dx=15mm, dy=15mm, Maximum value of SAR (measured) = 0.0148 W/kg

**Configuration/WCDMA Band V Mid Tilt-Right/Zoom Scan (5x5x7)/Cube 0:** Measurement grid: dx=8mm, dy=8mm, dz=5mm, Reference Value = 4.563 V/m; Power Drift = 0.18 dB

Peak SAR (extrapolated) = 0.0380 W/kg

**SAR(1 g) = 0.015 W/kg; SAR(10 g) = 0.00825 W/kg** Maximum value of SAR (measured) = 0.0180 W/kg

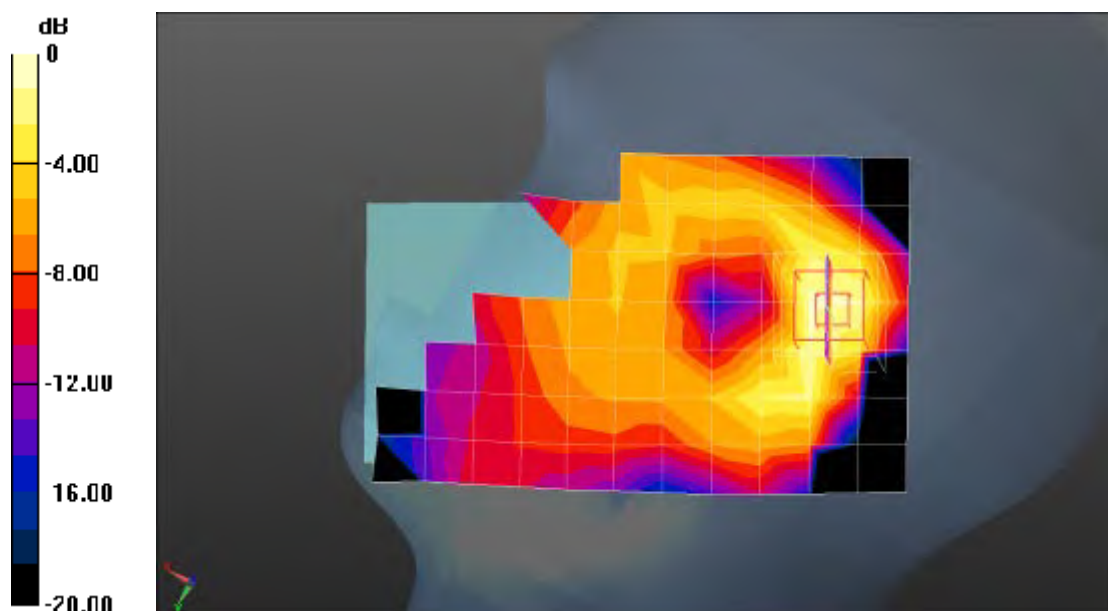

0 dB = 0.0180 W/kg = -17.45 dBW/kg



Date/Time: 21/07/2014

Test Laboratory: CerpPASS Lab

DUT: Mobile Phone; Type: D554P, DxxxP(xxx: stand for 0~9)

**Procedure Name: WCDMA Band V Mid Body-Back**

Communication System Band: WCDMA Band V; Frequency: 836.6 MHz; Duty Cycle: 1:1

Medium parameters used:  $f = 836.6$  MHz;  $\sigma = 0.96$  S/m;  $\epsilon_r = 55.86$ ;  $\rho = 1000$  kg/m<sup>3</sup>

Phantom section: Flat Section; Tissue Temp (celsius) - 21°C

Measurement Standard: DASYS (IEEE/IEC/ANSI C63.19-2011)

DASY5 Configuration:

- Probe: EX3DV4 - SN3927; ConvF(9.91, 9.91, 9.91); Calibrated: 2014/5/23;
- Sensor-Surface: 4mm (Mechanical Surface Detection)
- Electronics: DAE4 Sn1379; Calibrated: 2014/5/19
- Phantom: SAM (30deg probe tilt) with CRP v5.0; Type: QD000P40CD
- Measurement SW: DASYS2, Version 52.8 (8);

**Configuration/WCDMA Band V Mid Body-Back/Area Scan (8x12x1):** Measurement grid:

$dx=15$ mm,  $dy=15$ mm, Maximum value of SAR (measured) = 0.0509 W/kg

**Configuration/WCDMA Band V Mid Body-Back/Zoom Scan (5x5x7)/Cube 0:** Measurement grid:

$dx=8$ mm,  $dy=8$ mm,  $dz=5$ mm, Reference Value = 6.325 V/m; Power Drift = 0.14 dB

Peak SAR (extrapolated) = 0.0570 W/kg

**SAR(1 g) = 0.049 W/kg; SAR(10 g) = 0.040 W/kg** Maximum value of SAR (measured) = 0.0506 W/kg

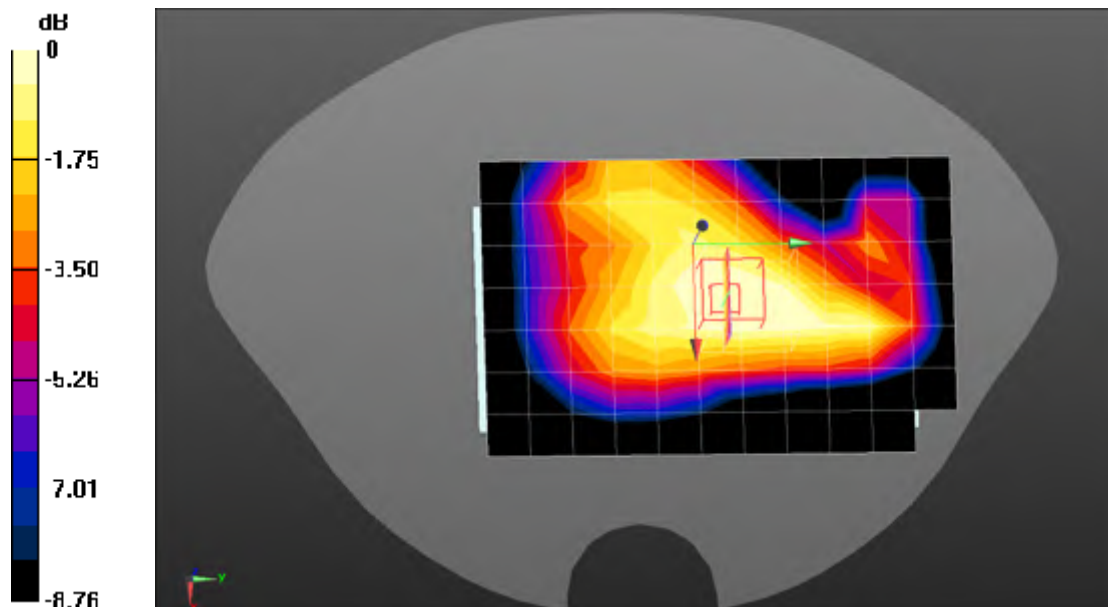

0 dB = 0.0506 W/kg = -12.96 dBW/kg



Z-Axis Plot

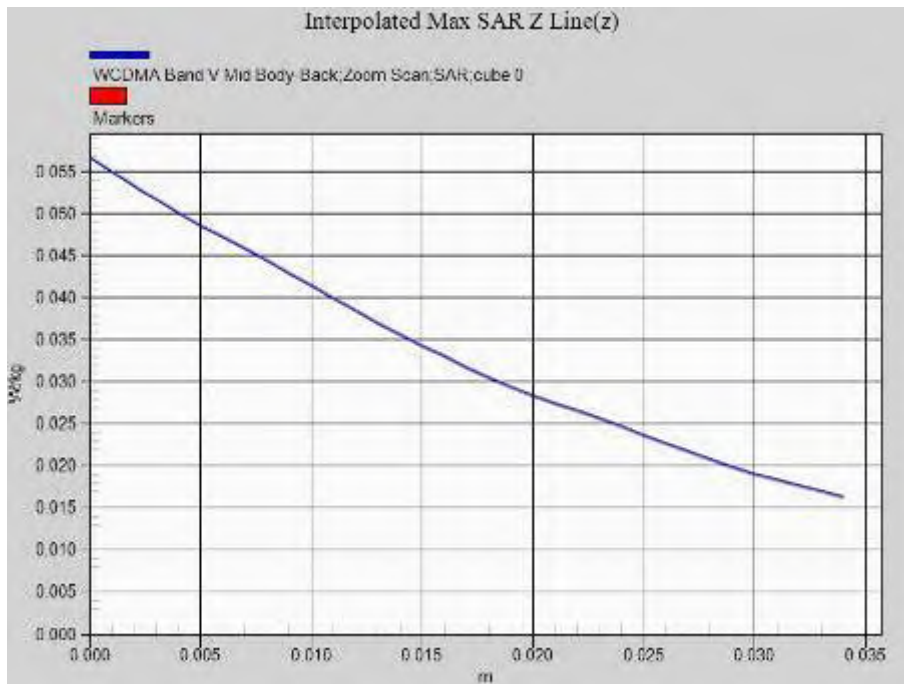





Date/Time: 21/07/2014

Test Laboratory: CerpPASS Lab

DUT: Mobile Phone; Type: D554P, DxxxP(xxx: stand for 0~9)

**Procedure Name: WCDMA Band V Mid Body-Front**

Communication System Band: WCDMA Band V; Frequency: 836.6 MHz; Duty Cycle: 1:1

Medium parameters used:  $f = 836.6$  MHz;  $\sigma = 0.96$  S/m;  $\epsilon_r = 55.86$ ;  $\rho = 1000$  kg/m<sup>3</sup>

Phantom section: Flat Section; Tissue Temp (celsius) - 21°C

Measurement Standard: DASYS (IEEE/IEC/ANSI C63.19-2011)

DASY5 Configuration:

- Probe: EX3DV4 - SN3927; ConvF(9.91, 9.91, 9.91); Calibrated: 2014/5/23;
- Sensor-Surface: 4mm (Mechanical Surface Detection)
- Electronics: DAE4 Sn1379; Calibrated: 2014/5/19
- Phantom: SAM (30deg probe tilt) with CRP v5.0; Type: QD000P40CD
- Measurement SW: DASYS2, Version 52.8 (8);

**Configuration/WCDMA Band V Mid Body-Front/Area Scan (8x12x1):** Measurement grid:

$dx=15$ mm,  $dy=15$ mm, Maximum value of SAR (measured) = 0.0322 W/kg

**Configuration/WCDMA Band V Mid Body-Front/Zoom Scan (5x5x7)/Cube 0:** Measurement grid:

$dx=8$ mm,  $dy=8$ mm,  $dz=5$ mm, Reference Value = 3.566 V/m; Power Drift = 0.18 dB

Peak SAR (extrapolated) = 0.0500 W/kg

**SAR(1 g) = 0.029 W/kg; SAR(10 g) = 0.016 W/kg** Maximum value of SAR (measured) = 0.0302 W/kg

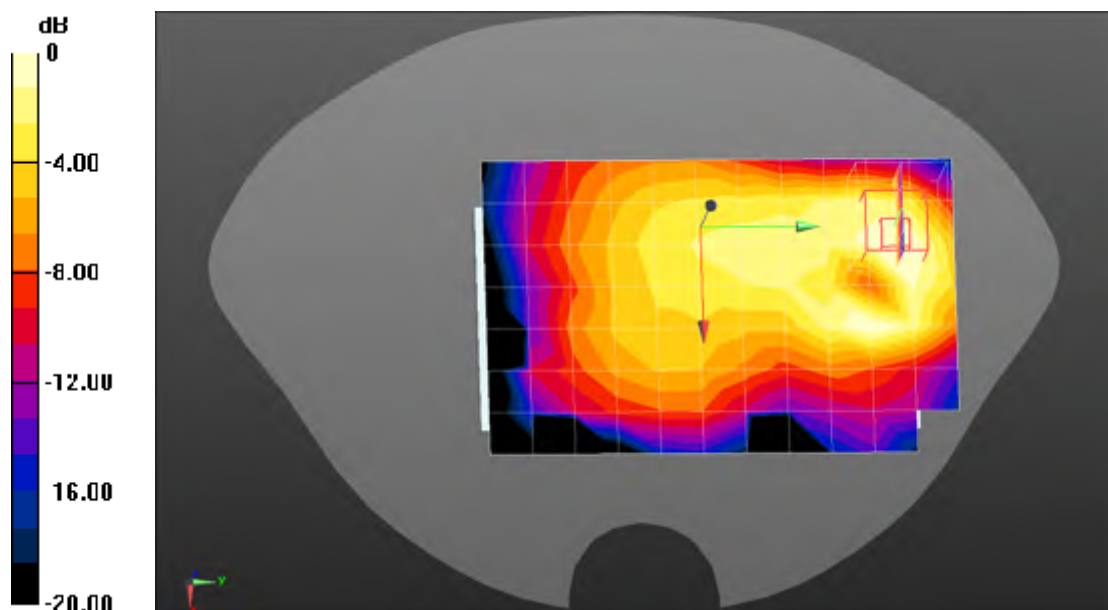

0 dB = 0.0302 W/kg = -15.20 dBW/kg





Date/Time: 21/07/2014

Test Laboratory: CerpPASS Lab

DUT: Mobile Phone; Type: D554P, DxxxP(xxx: stand for 0~9)

**Procedure Name: WCDMA Band V Mid Body-Leftside**

Communication System Band: WCDMA Band V; Frequency: 836.6 MHz; Duty Cycle: 1:1

Medium parameters used:  $f = 836.6$  MHz;  $\sigma = 0.96$  S/m;  $\epsilon_r = 55.86$ ;  $\rho = 1000$  kg/m<sup>3</sup>

Phantom section: Flat Section; Tissue Temp (celsius) - 21°C

Measurement Standard: DASYS (IEEE/IEC/ANSI C63.19-2011)

DASY5 Configuration:

- Probe: EX3DV4 - SN3927; ConvF(9.91, 9.91, 9.91); Calibrated: 2014/5/23;
- Sensor-Surface: 4mm (Mechanical Surface Detection)
- Electronics: DAE4 Sn1379; Calibrated: 2014/5/19
- Phantom: SAM (30deg probe tilt) with CRP v5.0; Type: QD000P40CD
- Measurement SW: DASYS2, Version 52.8 (8);

**Configuration/WCDMA Band V Mid Body-Leftside/Area Scan (5x12x1):** Measurement grid:

$dx=15$ mm,  $dy=15$ mm, Maximum value of SAR (measured) = 0.0282 W/kg

**Configuration/WCDMA Band V Mid Body-Leftside/Zoom Scan (5x5x7)/Cube 0:** Measurement

grid:  $dx=8$ mm,  $dy=8$ mm,  $dz=5$ mm, Reference Value = 4.578 V/m; Power Drift = 0.19 dB

Peak SAR (extrapolated) = 0.0360 W/kg

**SAR(1 g) = 0.027 W/kg; SAR(10 g) = 0.019 W/kg** Maximum value of SAR (measured) = 0.0290 W/kg

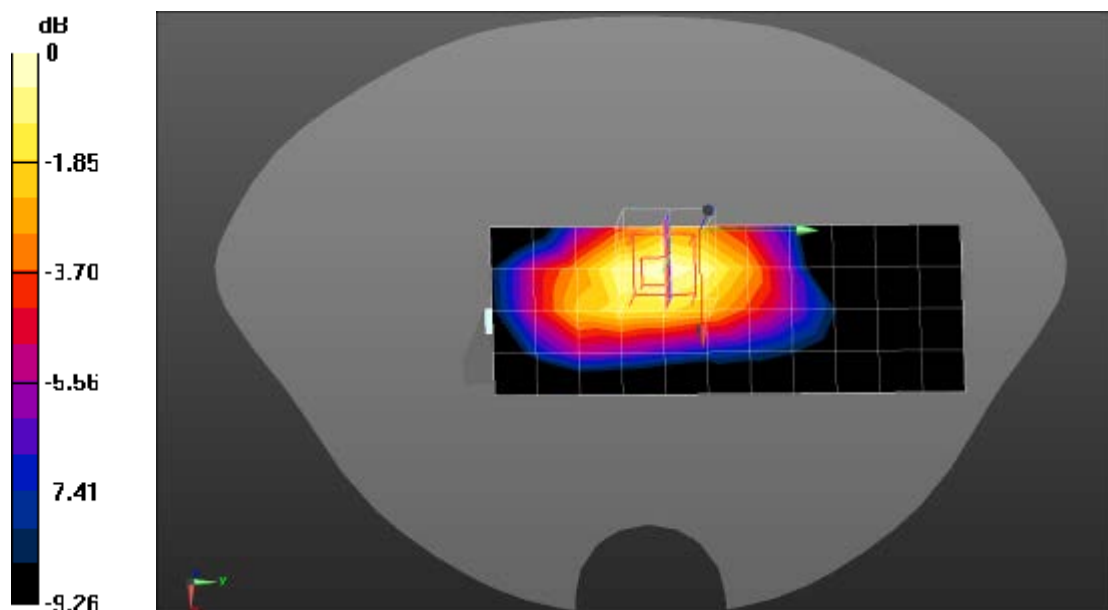

0 dB = 0.0290 W/kg = -15.38 dBW/kg



Date/Time: 21/07/2014

Test Laboratory: CerpPASS Lab

DUT: Mobile Phone; Type: D554P, DxxxP(xxx: stand for 0~9)

**Procedure Name: WCDMA Band V Mid Body-Rightside**

Communication System Band: WCDMA Band V; Frequency: 836.6 MHz; Duty Cycle: 1:1

Medium parameters used:  $f = 836.6$  MHz;  $\sigma = 0.96$  S/m;  $\epsilon_r = 55.86$ ;  $\rho = 1000$  kg/m<sup>3</sup>

Phantom section: Flat Section; Tissue Temp (celsius) - 21°C

Measurement Standard: DASYS (IEEE/IEC/ANSI C63.19-2011)

DASY5 Configuration:

- Probe: EX3DV4 - SN3927; ConvF(9.91, 9.91, 9.91); Calibrated: 2014/5/23;
- Sensor-Surface: 4mm (Mechanical Surface Detection)
- Electronics: DAE4 Sn1379; Calibrated: 2014/5/19
- Phantom: SAM (30deg probe tilt) with CRP v5.0; Type: QD000P40CD
- Measurement SW: DASYS2, Version 52.8 (8);

**Configuration/WCDMA Band V Mid Body-Rightside/Area Scan (5x12x1):** Measurement grid:

$dx=15$ mm,  $dy=15$ mm, Maximum value of SAR (measured) = 0.0151 W/kg

**Configuration/WCDMA Band V Mid Body-Rightside/Zoom Scan (5x5x7)/Cube 0:** Measurement

grid:  $dx=8$ mm,  $dy=8$ mm,  $dz=5$ mm, Reference Value = 2.995 V/m; Power Drift = 0.13 dB

Peak SAR (extrapolated) = 0.0200 W/kg

**SAR(1 g) = 0.014 W/kg; SAR(10 g) = 0.010 W/kg**

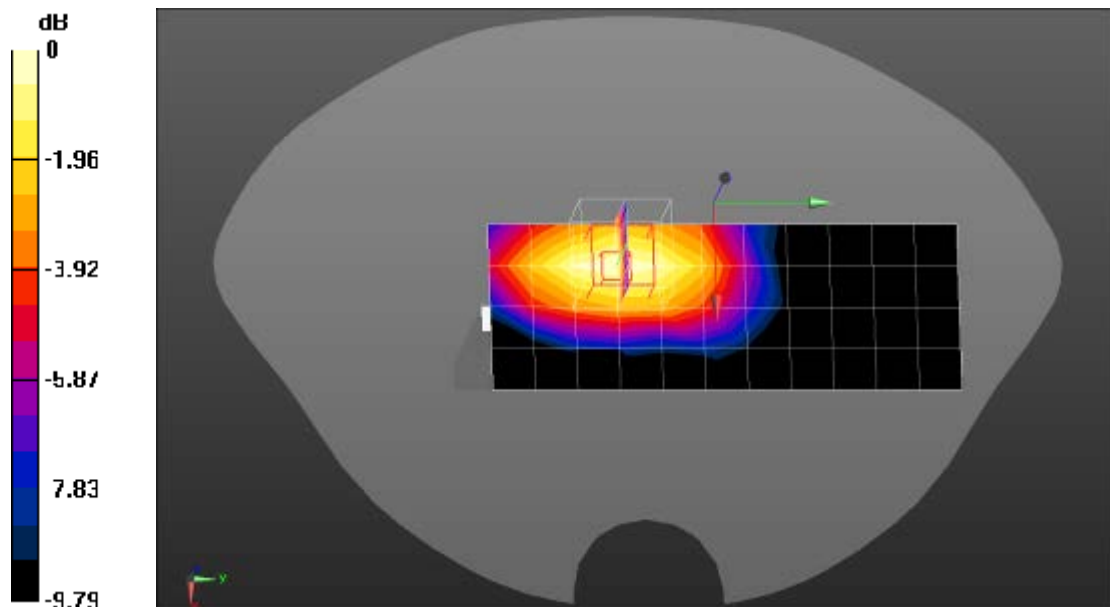

0 dB = 0.0151 W/kg = -18.21 dBW/kg



Date/Time: 21/07/2014

Test Laboratory: CerpPASS Lab

DUT: Mobile Phone; Type: D554P, DxxxP(xxx: stand for 0~9)

**Procedure Name: WCDMA Band V Mid Body-Bottom**

Communication System Band: WCDMA Band V; Frequency: 836.6 MHz; Duty Cycle: 1:1

Medium parameters used:  $f = 836.6$  MHz;  $\sigma = 0.96$  S/m;  $\epsilon_r = 55.86$ ;  $\rho = 1000$  kg/m<sup>3</sup>

Phantom section: Flat Section; Tissue Temp (celsius) - 21°C

Measurement Standard: DASYS (IEEE/IEC/ANSI C63.19-2011)

DASY5 Configuration:

- Probe: EX3DV4 - SN3927; ConvF(9.91, 9.91, 9.91); Calibrated: 2014/5/23;
- Sensor-Surface: 4mm (Mechanical Surface Detection)
- Electronics: DAE4 Sn1379; Calibrated: 2014/5/19
- Phantom: SAM (30deg probe tilt) with CRP v5.0; Type: QD000P40CD
- Measurement SW: DASYS2, Version 52.8 (8);

**Configuration/WCDMA Band V Mid Body-Bottom/Area Scan (5x8x1):** Measurement grid:

$dx=15$ mm,  $dy=15$ mm, Maximum value of SAR (measured) = 0.00597 W/kg

**Configuration/WCDMA Band V Mid Body-Bottom/Zoom Scan (5x5x7)/Cube 0:** Measurement grid:

$dx=8$ mm,  $dy=8$ mm,  $dz=5$ mm, Reference Value = 2.568 V/m; Power Drift = 0.10 dB

Peak SAR (extrapolated) = 0.00891 W/kg

**SAR(1 g) = 0.00556 W/kg; SAR(10 g) = 0.00304 W/kg** Maximum value of SAR (measured) = 0.00631 W/kg

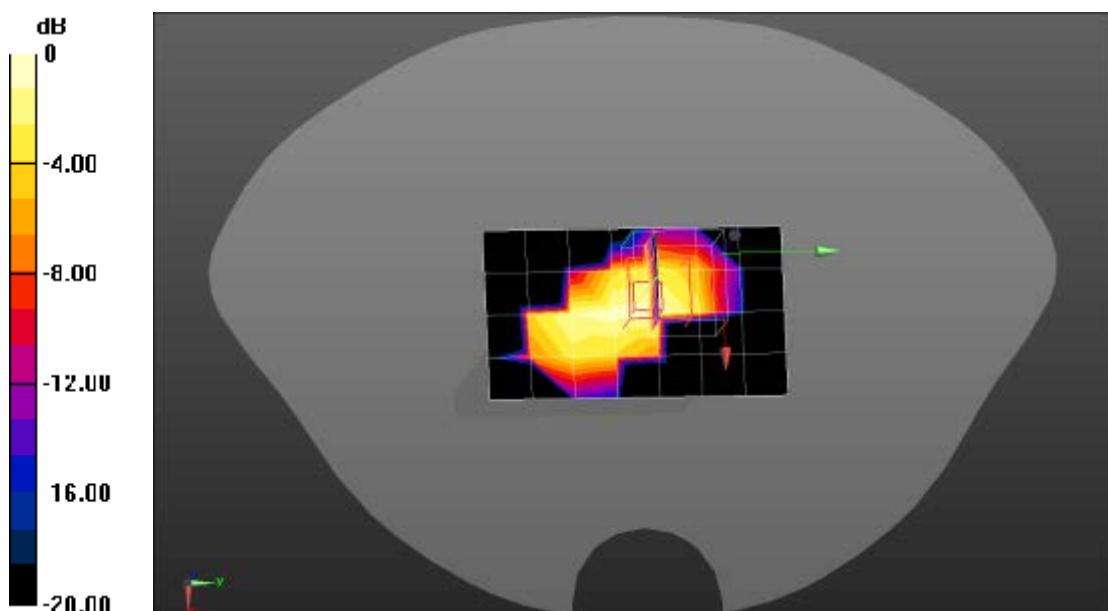

0 dB = 0.00631 W/kg = -22.00 dBW/kg



Date/Time: 21/07/2014

Test Laboratory: CerpPASS Lab

DUT: Mobile Phone; Type: D554P, DxxxP(xxx: stand for 0~9)

**Procedure Name: 802.11b 2462MHz High Touch-Left**

Communication System Band: 802.11b; Frequency: 2462 MHz; Duty Cycle: 1:1

Medium parameters used:  $f = 2462$  MHz;  $\sigma = 1.83$  S/m;  $\epsilon_r = 40.05$ ;  $\rho = 1000$  kg/m<sup>3</sup>

Phantom section: Left Section; Tissue Temp (celsius) - 21°C

Measurement Standard: DASYS (IEEE/IEC/ANSI C63.19-2011)

DASY5 Configuration:

- Probe: EX3DV4 - SN3927; ConvF(7.63, 7.63, 7.63); Calibrated: 2014/5/23;
- Sensor-Surface: 4mm (Mechanical Surface Detection)
- Electronics: DAE4 Sn1379; Calibrated: 2014/5/19
- Phantom: SAM (30deg probe tilt) with CRP v5.0; Type: QD000P40CD
- Measurement SW: DASYS2, Version 52.8 (8);

**Configuration/802.11b 2462MHz High Touch-Left/Area Scan (8x12x1):** Measurement grid:

$dx=15$ mm,  $dy=15$ mm, Maximum value of SAR (measured) = 0.149 W/kg

**Configuration/802.11b 2462MHz High Touch-Left/Zoom Scan (5x5x7)/Cube 0:** Measurement grid:

$dx=8$ mm,  $dy=8$ mm,  $dz=5$ mm, Reference Value = 7.789 V/m; Power Drift = -0.11 dB

Peak SAR (extrapolated) = 0.353 W/kg

**SAR(1 g) = 0.143 W/kg; SAR(10 g) = 0.069 W/kg** Maximum value of SAR (measured) = 0.154 W/kg

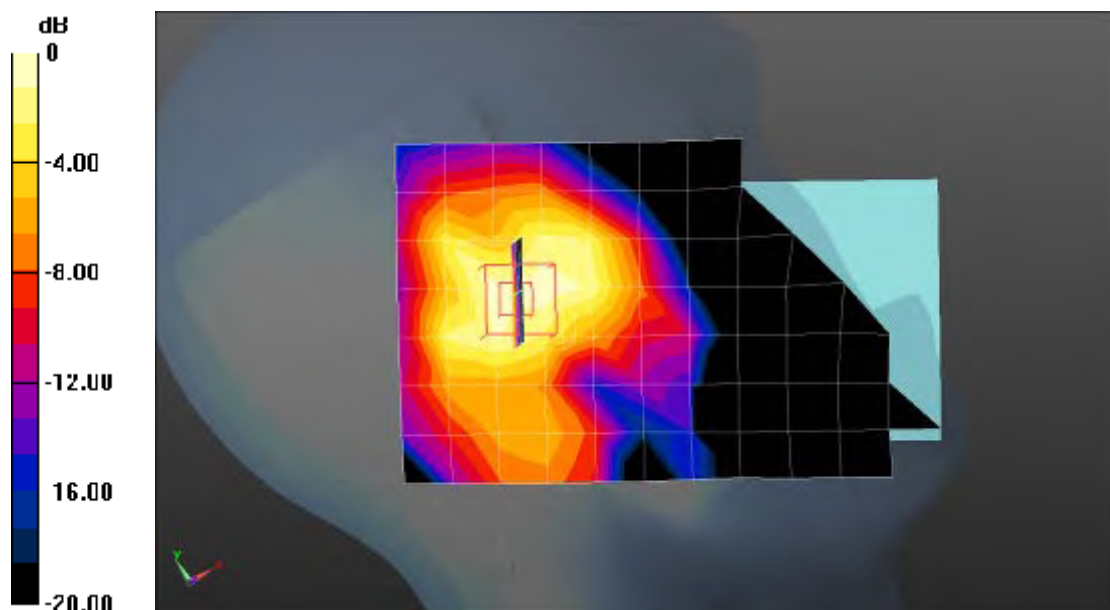

0 dB = 0.154 W/kg = -8.12 dBW/kg



Date/Time: 21/07/2014

Test Laboratory: CerpPASS Lab

DUT: Mobile Phone; Type: D554P, DxxxP(xxx: stand for 0~9)

**Procedure Name: 802.11b 2462MHz High Tilt-Left**

Communication System Band: 802.11b; Frequency: 2462 MHz; Duty Cycle: 1:1

Medium parameters used:  $f = 2462$  MHz;  $\sigma = 1.83$  S/m;  $\epsilon_r = 40.05$ ;  $\rho = 1000$  kg/m<sup>3</sup>

Phantom section: Left Section; Tissue Temp (celsius) - 21 °C

Measurement Standard: DASYS (IEEE/IEC/ANSI C63.19-2011)

DASY5 Configuration:

- Probe: EX3DV4 - SN3927; ConvF(7.63, 7.63, 7.63); Calibrated: 2014/5/23;
- Sensor-Surface: 4mm (Mechanical Surface Detection)
- Electronics: DAE4 Sn1379; Calibrated: 2014/5/19
- Phantom: SAM (30deg probe tilt) with CRP v5.0; Type: QD000P40CD
- Measurement SW: DASYS2, Version 52.8 (8);

**Configuration/802.11b 2462MHz High Tilt-Left/Area Scan (8x12x1):** Measurement grid: dx=15mm, dy=15mm, Maximum value of SAR (measured) = 0.0789 W/kg

**Configuration/802.11b 2462MHz High Tilt-Left/Zoom Scan (5x5x7)/Cube 0:** Measurement grid: dx=8mm, dy=8mm, dz=5mm, Reference Value = 5.640 V/m; Power Drift = 0.15 dB

Peak SAR (extrapolated) = 0.159 W/kg

**SAR(1 g) = 0.074 W/kg; SAR(10 g) = 0.034 W/kg** Maximum value of SAR (measured) = 0.0824 W/kg

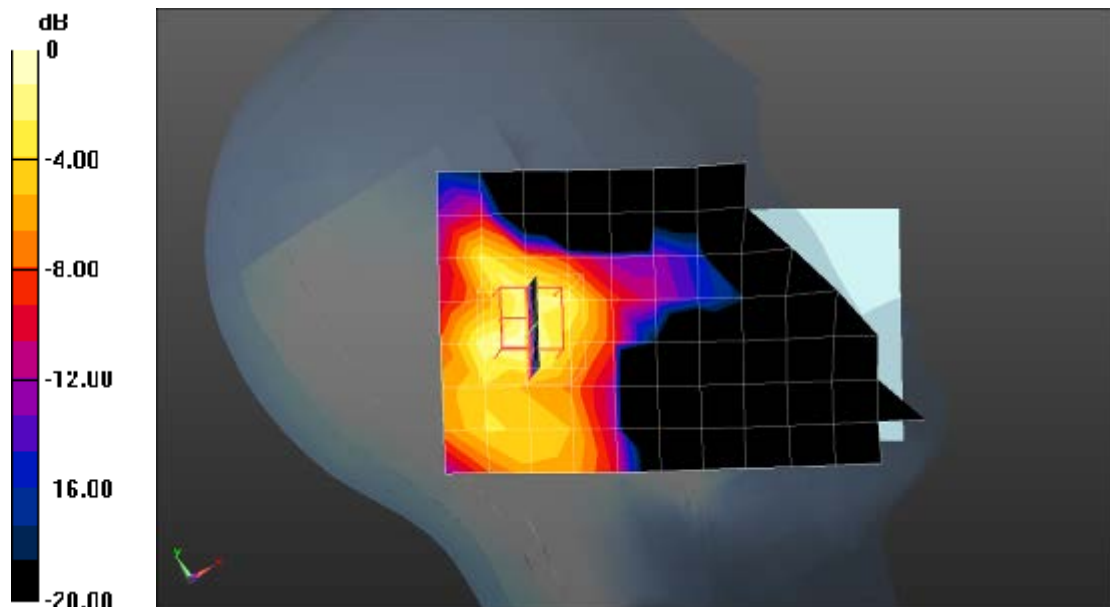

0 dB = 0.0824 W/kg = -10.84 dBW/kg



Date/Time: 21/07/2014

Test Laboratory: CerpPASS Lab

DUT: Mobile Phone; Type: D554P, DxxxP(xxx: stand for 0~9)

**Procedure Name: 802.11b 2462MHz High Touch-Right**

Communication System Band: 802.11b; Frequency: 2462 MHz; Duty Cycle: 1:1

Medium parameters used:  $f = 2462$  MHz;  $\sigma = 1.83$  S/m;  $\epsilon_r = 40.05$ ;  $\rho = 1000$  kg/m<sup>3</sup>

Phantom section: Right Section; Tissue Temp (celsius) - 21°C

Measurement Standard: DASYS (IEEE/IEC/ANSI C63.19-2011)

DASY5 Configuration:

- Probe: EX3DV4 - SN3927; ConvF(7.63, 7.63, 7.63); Calibrated: 2014/5/23;
- Sensor-Surface: 4mm (Mechanical Surface Detection)
- Electronics: DAE4 Sn1379; Calibrated: 2014/5/19
- Phantom: SAM (30deg probe tilt) with CRP v5.0; Type: QD000P40CD
- Measurement SW: DASYS2, Version 52.8 (8);

**Configuration/802.11b 2462MHz High Touch-Right/Area Scan (8x12x1):** Measurement grid:

$dx=15$ mm,  $dy=15$ mm, Maximum value of SAR (measured) = 0.163 W/kg

**Configuration/802.11b 2462MHz High Touch-Right/Zoom Scan (5x5x7)/Cube 0:** Measurement

grid:  $dx=8$ mm,  $dy=8$ mm,  $dz=5$ mm, Reference Value = 7.625 V/m; Power Drift = -0.11 dB

Peak SAR (extrapolated) = 0.341 W/kg

**SAR(1 g) = 0.146 W/kg; SAR(10 g) = 0.067 W/kg** Maximum value of SAR (measured) = 0.167 W/kg

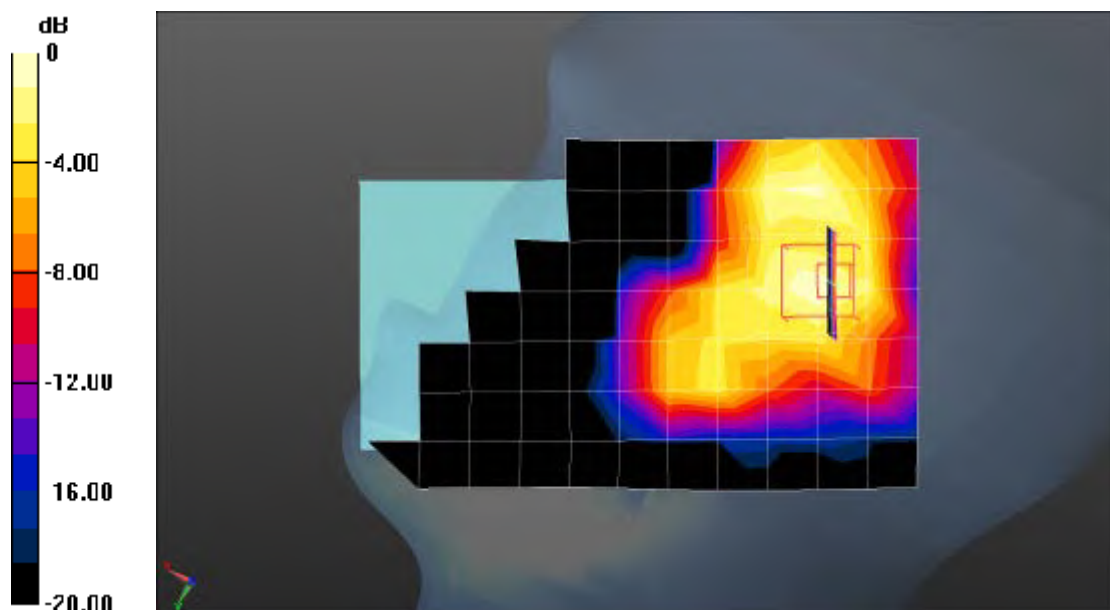

0 dB = 0.167 W/kg = -7.77 dBW/kg





Date/Time: 21/07/2014

Test Laboratory: CerpPASS Lab

DUT: Mobile Phone; Type: D554P, DxxxP(xxx: stand for 0~9)

**Procedure Name: 802.11b 2462MHz High Tilt-Right**

Communication System Band: 802.11b; Frequency: 2462 MHz; Duty Cycle: 1:1

Medium parameters used:  $f = 2462$  MHz;  $\sigma = 1.83$  S/m;  $\epsilon_r = 40.05$ ;  $\rho = 1000$  kg/m<sup>3</sup>

Phantom section: Right Section; Tissue Temp (celsius) - 21°C

Measurement Standard: DASYS (IEEE/IEC/ANSI C63.19-2011)

DASY5 Configuration:

- Probe: EX3DV4 - SN3927; ConvF(7.63, 7.63, 7.63); Calibrated: 2014/5/23;
- Sensor-Surface: 4mm (Mechanical Surface Detection)
- Electronics: DAE4 Sn1379; Calibrated: 2014/5/19
- Phantom: SAM (30deg probe tilt) with CRP v5.0; Type: QD000P40CD
- Measurement SW: DASY52, Version 52.8 (8);

**Configuration/802.11b 2462MHz High Tilt-Right/Area Scan (8x12x1):** Measurement grid:

$dx=15$ mm,  $dy=15$ mm, Maximum value of SAR (measured) = 0.0902 W/kg

**Configuration/802.11b 2462MHz High Tilt-Right/Zoom Scan (5x5x7)/Cube 0:** Measurement grid:

$dx=8$ mm,  $dy=8$ mm,  $dz=5$ mm, Reference Value = 5.469 V/m; Power Drift = -0.11 dB

Peak SAR (extrapolated) = 0.168 W/kg

**SAR(1 g) = 0.081 W/kg; SAR(10 g) = 0.039 W/kg** Maximum value of SAR (measured) = 0.0886 W/kg

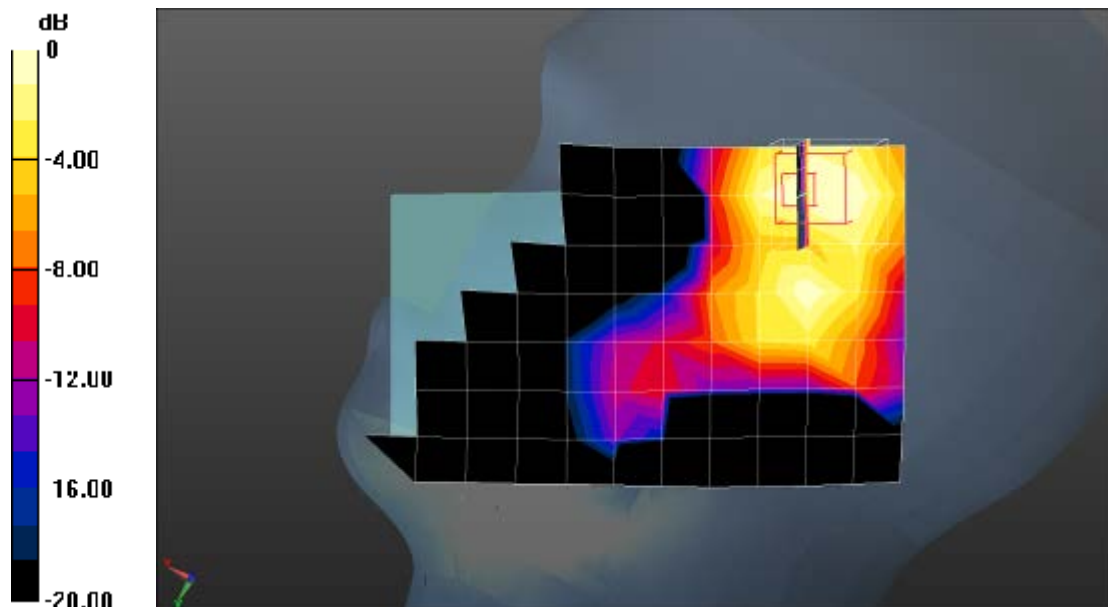

0 dB = 0.0886 W/kg = -10.53 dBW/kg





Date/Time: 21/07/2014

Test Laboratory: CerpPASS Lab

DUT: Mobile Phone; Type: D554P, DxxxP(xxx: stand for 0~9)

**Procedure Name: 802.11b 2412MHz Low Body-Back**

Communication System Band: 802.11b; Frequency: 2412 MHz; Duty Cycle: 1:1

Medium parameters used:  $f = 2412$  MHz;  $\sigma = 1.93$  S/m;  $\epsilon_r = 51.03$ ;  $\rho = 1000$  kg/m<sup>3</sup>

Phantom section: Flat Section; Tissue Temp (celsius) - 21°C

Measurement Standard: DASYS (IEEE/IEC/ANSI C63.19-2011)

DASY5 Configuration:

- Probe: EX3DV4 - SN3927; ConvF(7.63, 7.63, 7.63); Calibrated: 2014/5/23;
- Sensor-Surface: 4mm (Mechanical Surface Detection)
- Electronics: DAE4 Sn1379; Calibrated: 2014/5/19
- Phantom: SAM (30deg probe tilt) with CRP v5.0; Type: QD000P40CD
- Measurement SW: DASYS2, Version 52.8 (8);

**Configuration/802.11b 2412MHz Low Body-Back/Area Scan (8x12x1):** Measurement grid:

$dx=15$ mm,  $dy=15$ mm, Maximum value of SAR (measured) = 0.0846 W/kg

**Configuration/802.11b 2412MHz Low Body-Back/Zoom Scan (5x5x7)/Cube 0:** Measurement grid:

$dx=8$ mm,  $dy=8$ mm,  $dz=5$ mm, Reference Value = 1.056 V/m; Power Drift = -0.06 dB

Peak SAR (extrapolated) = 0.129 W/kg

**SAR(1 g) = 0.068 W/kg; SAR(10 g) = 0.029 W/kg** Maximum value of SAR (measured) = 0.0842 W/kg

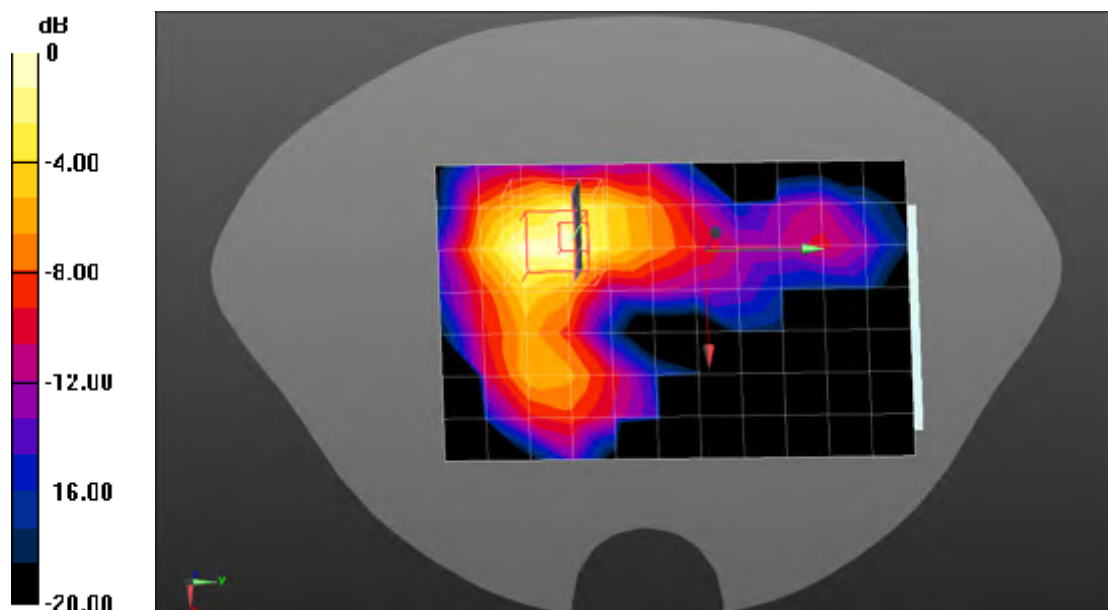

0 dB = 0.0842 W/kg = -10.75 dBW/kg



Date/Time: 21/07/2014

Test Laboratory: CerpPASS Lab

DUT: Mobile Phone; Type: D554P, DxxxP(xxx: stand for 0~9)

**Procedure Name: 802.11b 2437MHz Mid Body-Back**

Communication System Band: 802.11b; Frequency: 2437 MHz; Duty Cycle: 1:1

Medium parameters used:  $f = 2437$  MHz;  $\sigma = 1.95$  S/m;  $\epsilon_r = 50.91$ ;  $\rho = 1000$  kg/m<sup>3</sup>

Phantom section: Flat Section; Tissue Temp (celsius) - 21°C

Measurement Standard: DASYS (IEEE/IEC/ANSI C63.19-2011)

DASY5 Configuration:

- Probe: EX3DV4 - SN3927; ConvF(7.63, 7.63, 7.63); Calibrated: 2014/5/23;
- Sensor-Surface: 4mm (Mechanical Surface Detection)
- Electronics: DAE4 Sn1379; Calibrated: 2014/5/19
- Phantom: SAM (30deg probe tilt) with CRP v5.0; Type: QD000P40CD
- Measurement SW: DASY52, Version 52.8 (8);

**Configuration/802.11b 2437MHz Mid Body-Back/Area Scan (8x12x1):** Measurement grid:

$dx=15$ mm,  $dy=15$ mm, Maximum value of SAR (measured) = 0.138 W/kg

**Configuration/802.11b 2437MHz Mid Body-Back/Zoom Scan (5x5x7)/Cube 0:** Measurement grid:

$dx=8$ mm,  $dy=8$ mm,  $dz=5$ mm, Reference Value = 1.716 V/m; Power Drift = -0.10 dB

Peak SAR (extrapolated) = 0.287 W/kg

**SAR(1 g) = 0.122 W/kg; SAR(10 g) = 0.054 W/kg** Maximum value of SAR (measured) = 0.139 W/kg

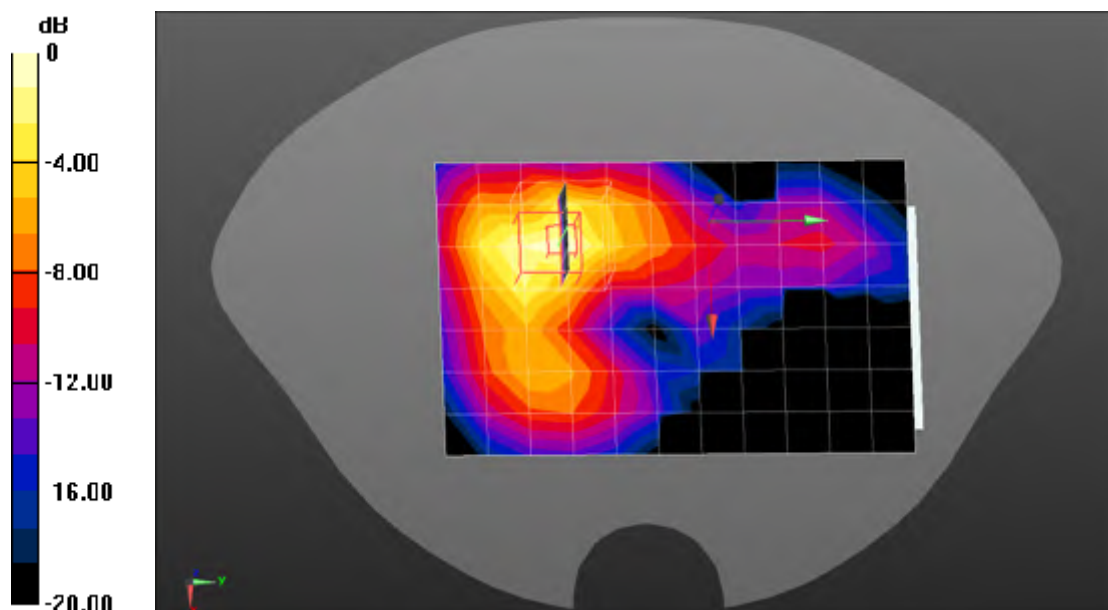

0 dB = 0.139 W/kg = -8.57 dBW/kg



Date/Time: 21/07/2014

Test Laboratory: CerpPASS Lab

DUT: Mobile Phone; Type: D554P, DxxxP(xxx: stand for 0~9)

**Procedure Name: 802.11b 2462MHz High Body-Back**

Communication System Band: 802.11b; Frequency: 2462 MHz; Duty Cycle: 1:1

Medium parameters used:  $f = 2462$  MHz;  $\sigma = 1.97$  S/m;  $\epsilon_r = 50.72$ ;  $\rho = 1000$  kg/m<sup>3</sup>

Phantom section: Flat Section; Tissue Temp (celsius) - 21°C

Measurement Standard: DASYS (IEEE/IEC/ANSI C63.19-2011)

DASY5 Configuration:

- Probe: EX3DV4 - SN3927; ConvF(7.63, 7.63, 7.63); Calibrated: 2014/5/23;
- Sensor-Surface: 4mm (Mechanical Surface Detection)
- Electronics: DAE4 Sn1379; Calibrated: 2014/5/19
- Phantom: SAM (30deg probe tilt) with CRP v5.0; Type: QD000P40CD
- Measurement SW: DASYS2, Version 52.8 (8);

**Configuration/802.11b 2462MHz High Body-Back/Area Scan (8x12x1):** Measurement grid:

$dx=15$ mm,  $dy=15$ mm, Maximum value of SAR (measured) = 0.197 W/kg

**Configuration/802.11b 2462MHz High Body-Back/Zoom Scan (5x5x7)/Cube 0:** Measurement grid:

$dx=8$ mm,  $dy=8$ mm,  $dz=5$ mm, Reference Value = 2.265 V/m; Power Drift = 0.01 dB

Peak SAR (extrapolated) = 0.450 W/kg

**SAR(1 g) = 0.152 W/kg; SAR(10 g) = 0.088 W/kg** Maximum value of SAR (measured) = 0.210 W/kg

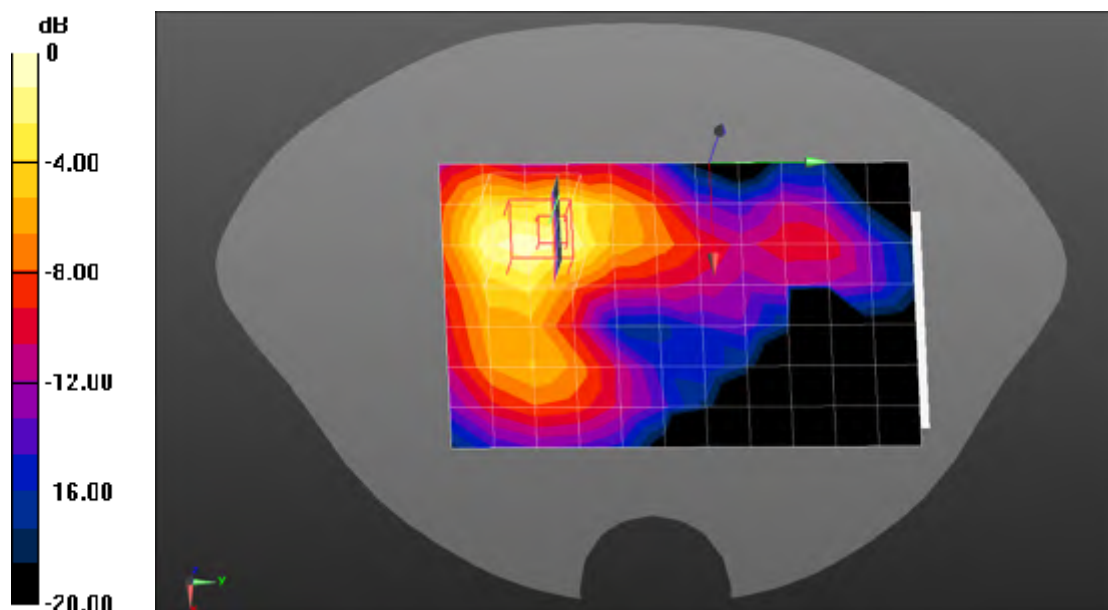

0 dB = 0.210 W/kg = -6.78 dBW/kg



Z-Axis Plot

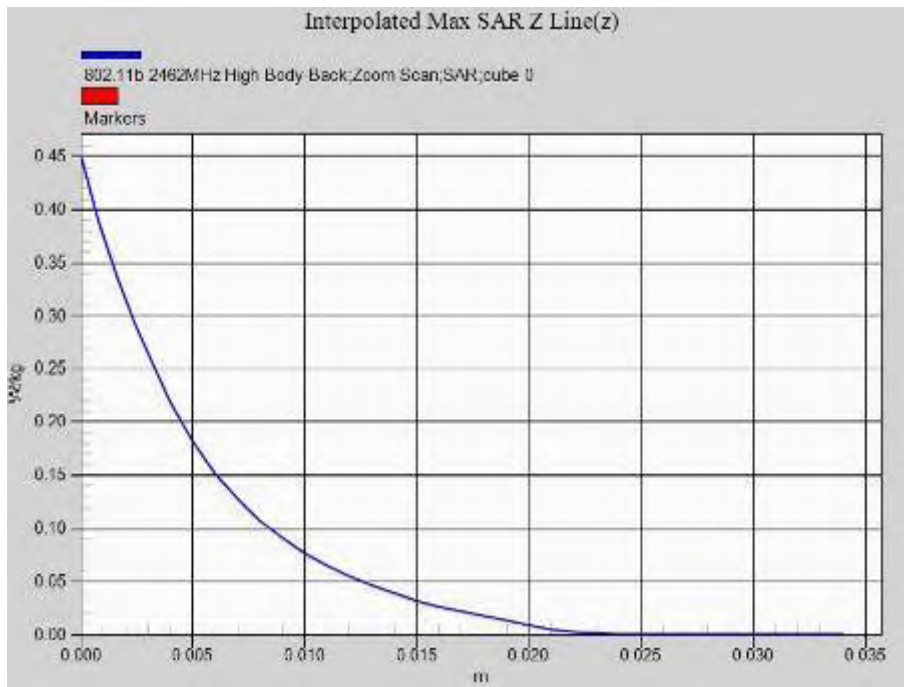



Date/Time: 21/07/2014

Test Laboratory: CerpPASS Lab

DUT: Mobile Phone; Type: D554P, DxxxP(xxx: stand for 0~9)

**Procedure Name: 802.11b 2462MHz High Body-Front**

Communication System Band: 802.11b; Frequency: 2462 MHz; Duty Cycle: 1:1

Medium parameters used:  $f = 2462$  MHz;  $\sigma = 1.97$  S/m;  $\epsilon_r = 50.72$ ;  $\rho = 1000$  kg/m<sup>3</sup>

Phantom section: Flat Section; Tissue Temp (celsius) - 21°C

Measurement Standard: DASYS (IEEE/IEC/ANSI C63.19-2011)

DASY5 Configuration:

- Probe: EX3DV4 - SN3927; ConvF(7.63, 7.63, 7.63); Calibrated: 2014/5/23;
- Sensor-Surface: 4mm (Mechanical Surface Detection)
- Electronics: DAE4 Sn1379; Calibrated: 2014/5/19
- Phantom: SAM (30deg probe tilt) with CRP v5.0; Type: QD000P40CD
- Measurement SW: DASYS2, Version 52.8 (8);

**Configuration/802.11b 2462MHz High Body-Front/Area Scan (8x12x1):** Measurement grid:

$dx=15$ mm,  $dy=15$ mm, Maximum value of SAR (measured) = 0.0525 W/kg

**Configuration/802.11b 2462MHz High Body-Front/Zoom Scan (5x5x7)/Cube 0:** Measurement grid:

$dx=8$ mm,  $dy=8$ mm,  $dz=5$ mm, Reference Value = 2.369 V/m; Power Drift = -0.18 dB

Peak SAR (extrapolated) = 0.0850 W/kg

**SAR(1 g) = 0.046 W/kg; SAR(10 g) = 0.024 W/kg** Maximum value of SAR (measured) = 0.0511 W/kg

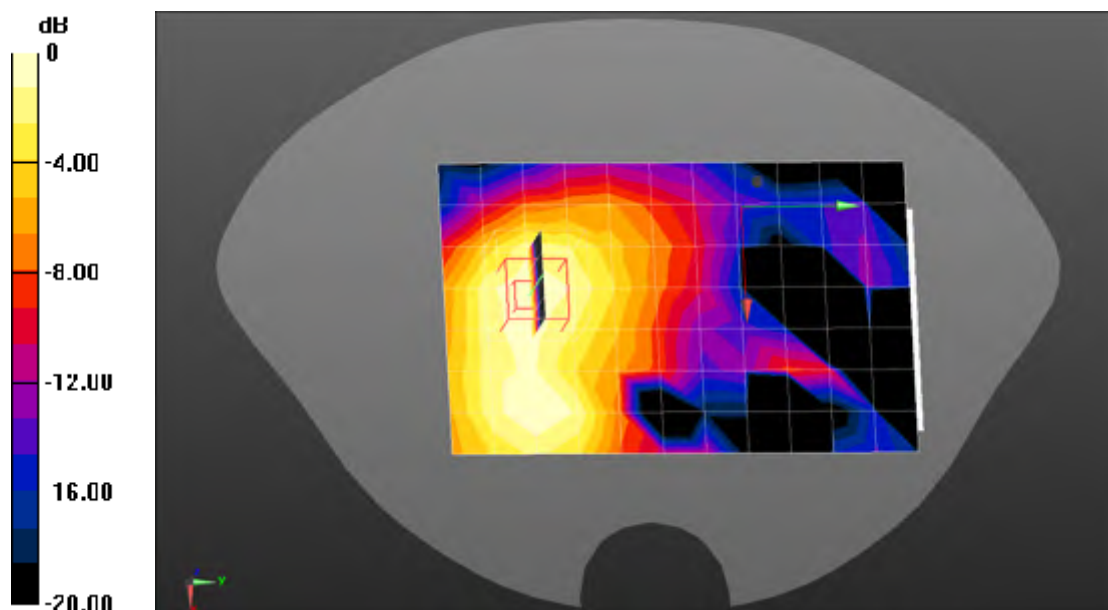

0 dB = 0.0511 W/kg = -12.92 dBW/kg



Date/Time: 21/07/2014

Test Laboratory: CerpPASS Lab

DUT: Mobile Phone; Type: D554P, DxxxP(xxx: stand for 0~9)

**Procedure Name: 802.11b 2462MHz High Body-Leftside**

Communication System Band: 802.11b; Frequency: 2462 MHz; Duty Cycle: 1:1

Medium parameters used:  $f = 2462$  MHz;  $\sigma = 1.97$  S/m;  $\epsilon_r = 50.72$ ;  $\rho = 1000$  kg/m<sup>3</sup>

Phantom section: Flat Section; Tissue Temp (celsius) - 21°C

Measurement Standard: DASYS (IEEE/IEC/ANSI C63.19-2011)

DASY5 Configuration:

- Probe: EX3DV4 - SN3927; ConvF(7.63, 7.63, 7.63); Calibrated: 2014/5/23;
- Sensor-Surface: 4mm (Mechanical Surface Detection)
- Electronics: DAE4 Sn1379; Calibrated: 2014/5/19
- Phantom: SAM (30deg probe tilt) with CRP v5.0; Type: QD000P40CD
- Measurement SW: DASYS2, Version 52.8 (8);

**Configuration/802.11b 2462MHz High Body-Leftside/Area Scan (5x12x1):** Measurement grid:

$dx=15$ mm,  $dy=15$ mm, Maximum value of SAR (measured) = 0.0923 W/kg

**Configuration/802.11b 2462MHz High Body-Leftside/Zoom Scan (5x5x7)/Cube 0:** Measurement

grid:  $dx=8$ mm,  $dy=8$ mm,  $dz=5$ mm, Reference Value = 5.043 V/m; Power Drift = 0.11 dB

Peak SAR (extrapolated) = 0.216 W/kg

**SAR(1 g) = 0.100 W/kg; SAR(10 g) = 0.045 W/kg** Maximum value of SAR (measured) = 0.107 W/kg

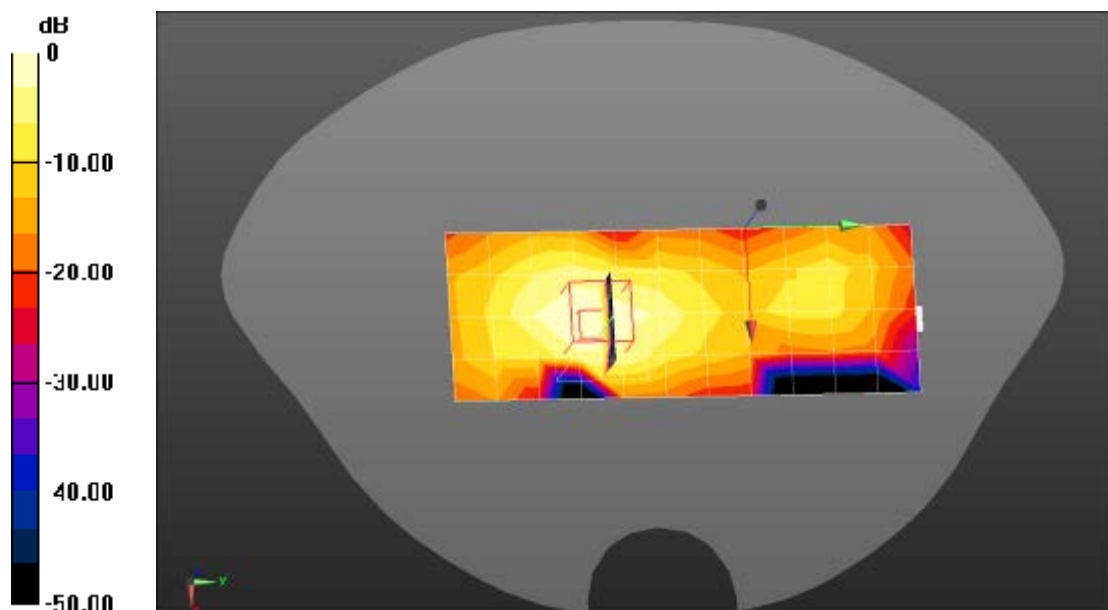

0 dB = 0.107 W/kg = -9.71 dBW/kg





Date/Time: 21/07/2014

Test Laboratory: CerpPASS Lab

DUT: Mobile Phone; Type: D554P, DxxxP(xxx: stand for 0~9)

**Procedure Name: 802.11b 2462MHz High Body-Top**

Communication System Band: 802.11b; Frequency: 2462 MHz; Duty Cycle: 1:1

Medium parameters used:  $f = 2462$  MHz;  $\sigma = 1.97$  S/m;  $\epsilon_r = 50.72$ ;  $\rho = 1000$  kg/m<sup>3</sup>

Phantom section: Flat Section; Tissue Temp (celsius) - 21°C

Measurement Standard: DASYS (IEEE/IEC/ANSI C63.19-2011)

DASY5 Configuration:

- Probe: EX3DV4 - SN3927; ConvF(7.63, 7.63, 7.63); Calibrated: 2014/5/23;
- Sensor-Surface: 4mm (Mechanical Surface Detection)
- Electronics: DAE4 Sn1379; Calibrated: 2014/5/19
- Phantom: SAM (30deg probe tilt) with CRP v5.0; Type: QD000P40CD
- Measurement SW: DASYS2, Version 52.8 (8);

**Configuration/802.11b 2462MHz High Body-Top/Area Scan (5x8x1):** Measurement grid:

$dx=15$ mm,  $dy=15$ mm, Maximum value of SAR (measured) = 0.0404 W/kg

**Configuration/802.11b 2462MHz High Body-Top/Zoom Scan (5x5x7)/Cube 0:** Measurement grid:

$dx=8$ mm,  $dy=8$ mm,  $dz=5$ mm, Reference Value = 3.761 V/m; Power Drift = 0.10 dB

Peak SAR (extrapolated) = 0.0740 W/kg

**SAR(1 g) = 0.035 W/kg; SAR(10 g) = 0.015 W/kg** Maximum value of SAR (measured) = 0.0411 W/kg

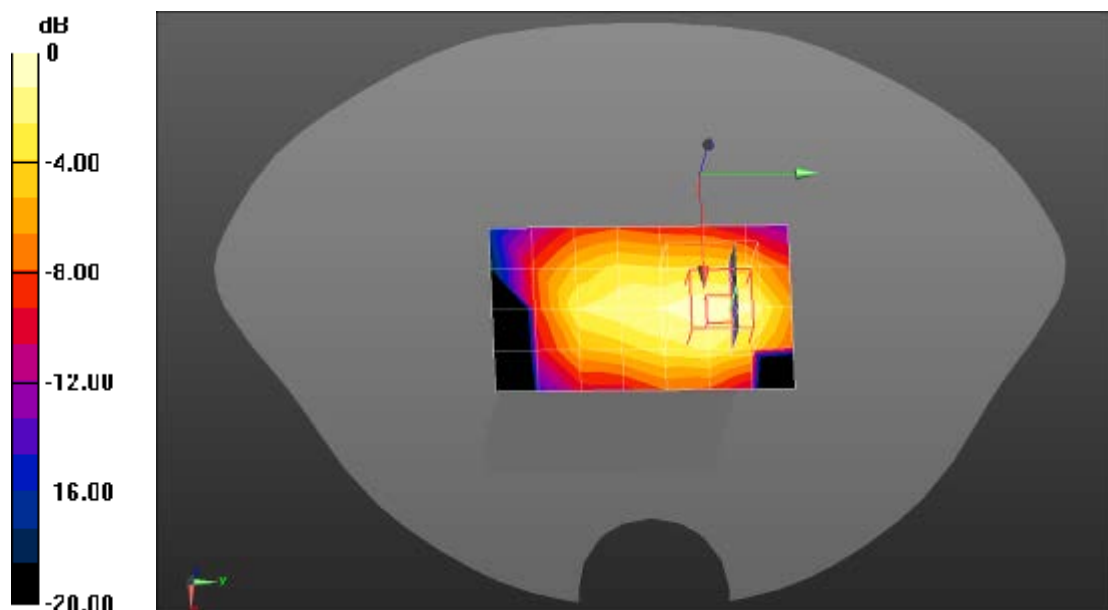

0 dB = 0.0411 W/kg = -13.86 dBW/kg





## 8. APPENDIX C Antenna Location, EUT and Test Setup Photographs

Note: Antenna Location, EUT and test setup photographs, see separate documents in PDF, named FCC SAR-Appendix C-Antenna internal view, outside view and Test Setup Photographs.



### 9. APPENDIX D. Probe Calibration Data

**Calibration Laboratory of Schmid & Partner Engineering AG**  
Zeughausstrasse 43, 8004 Zurich, Switzerland



**S** Schweizerischer Kalibrierdienst  
**S** Service suisse d'étalonnage  
**S** Servizio svizzero di taratura  
**S** Swiss Calibration Service

Accredited by the Swiss Accreditation Service (SAS)  
The Swiss Accreditation Service is one of the signatories to the EA  
Multilateral Agreement for the recognition of calibration certificates.

Accreditation No.: **SCS 108**

Client **CerpPASS (Auden)**

Certificate No: **EX3-3927\_May14**

## CALIBRATION CERTIFICATE

Object: EX3DV4 - SN:3927

Calibration procedure(s): QA CAL-01.v9, QA CAL-12.v9, QA CAL-14.v4, QA CAL-23.v5, QA CAL-25.v6  
Calibration procedure for dosimetric E-field probes

Calibration date: May 23, 2014

This calibration certificate documents the traceability to national standards, which realize the physical units of measurements (SI). The measurements and the uncertainties with confidence probability are given on the following pages and are part of the certificate.

All calibrations have been conducted in the closed laboratory facility: environment temperature (22 ± 3)°C and humidity < 70%.

Calibration Equipment used (M&TE critical for calibration)

Primary Standards	ID	Cal Date (Certificate No.)	Scheduled Calibration
Power meter E4419B	GB41293B74	03-Apr-14 (No. 217-01911)	Apr-15
Power sensor E4412A	MY41498087	03-Apr-14 (No. 217-01911)	Apr-15
Reference 3 dB Attenuator	SN: S5054 (3c)	03-Apr-14 (No. 217-01915)	Apr-15
Reference 20 dB Attenuator	SN: S5277 (20x)	03-Apr-14 (No. 217-01919)	Apr-15
Reference 30 dB Attenuator	SN: S5129 (30b)	03-Apr-14 (No. 217-01920)	Apr-15
Reference Probe ES3DV2	SN: 3013	30-Dec-13 (No. ES3-3013_Dec13)	Dec-14
DAE4	SN: 660	13-Dec-13 (No. DAE4-680 Dec13)	Dec-14
Secondary Standards	ID	Check Date (in house)	Scheduled Check
RF generator HP 8648C	US3642U01700	4-Aug-99 (in house check Apr-13)	In house check: Apr-16
Network Analyzer HP B753E	US37390585	19-Oct-01 (in house check Oct-13)	In house check: Oct-14

Calibrated by:	Name Claudio Leubler	Function Laboratory Technician	    Issued: May 23, 2014
Approved by:	Name Katja Pokovic	Function Technical Manager	

This calibration certificate shall not be reproduced except in full without written approval of the laboratory.



**Calibration Laboratory of**  
Schmid & Partner  
Engineering AG  
Zeughausstrasse 43, 8004 Zurich, Switzerland



**S** Schweizerischer Kalibrierdienst  
**C** Service suisse d'étalonnage  
**S** Servizio svizzero di taratura  
**S** Swiss Calibration Service

Accredited by the Swiss Accreditation Service (SAS)  
The Swiss Accreditation Service is one of the signatories to the EA  
Multilateral Agreement for the recognition of calibration certificates

Accreditation No.: **SCS 108**

#### Glossary:

TSL	tissue simulating liquid
NORM <sub>x,y,z</sub>	sensitivity in free space
ConvF	sensitivity in TSL / NORM <sub>x,y,z</sub>
DCP	diode compression point
CF	crest factor (1/duty_cycle) of the RF signal
A, B, C, D	modulation dependent linearization parameters
Polarization $\varphi$	$\varphi$ rotation around probe axis
Polarization $\theta$	$\theta$ rotation around an axis that is in the plane normal to probe axis (at measurement center), i.e., $\theta = 0$ is normal to probe axis
Connector Angle	information used in DASY system to align probe sensor X to the robot coordinate system

#### Calibration is Performed According to the Following Standards:

- IEEE Std 1528-2013, "IEEE Recommended Practice for Determining the Peak Spatial-Averaged Specific Absorption Rate (SAR) in the Human Head from Wireless Communications Devices: Measurement Techniques", June 2013
- IEC 62209-1, "Procedure to measure the Specific Absorption Rate (SAR) for hand-held devices used in close proximity to the ear (frequency range of 300 MHz to 3 GHz)", February 2005

#### Methods Applied and Interpretation of Parameters:

- NORM<sub>x,y,z</sub>**: Assessed for E-field polarization  $\theta = 0$  ( $f \leq 900$  MHz in TEM-cell;  $f > 1800$  MHz: R22 waveguide). NORM<sub>x,y,z</sub> are only intermediate values, i.e., the uncertainties of NORM<sub>x,y,z</sub> does not affect the E<sup>2</sup>-field uncertainty inside TSL (see below ConvF).
- NORM(f)<sub>x,y,z</sub> = NORM<sub>x,y,z</sub> \* frequency\_response** (see Frequency Response Chart). This linearization is implemented in DASY4 software versions later than 4.2. The uncertainty of the frequency response is included in the stated uncertainty of ConvF.
- DCP<sub>x,y,z</sub>**: DCP are numerical linearization parameters assessed based on the data of power sweep with CW signal (no uncertainty required). DCP does not depend on frequency nor media.
- PAR**: PAR is the Peak to Average Ratio that is not calibrated but determined based on the signal characteristics
- A<sub>x,y,z</sub>; B<sub>x,y,z</sub>; C<sub>x,y,z</sub>; D<sub>x,y,z</sub>; VR<sub>x,y,z</sub>**: A, B, C, D are numerical linearization parameters assessed based on the data of power sweep for specific modulation signal. The parameters do not depend on frequency nor media. VR is the maximum calibration range expressed in RMS voltage across the diode.
- ConvF and Boundary Effect Parameters**: Assessed in flat phantom using E-field (or Temperature Transfer Standard for  $f \leq 800$  MHz) and inside waveguide using analytical field distributions based on power measurements for  $f > 800$  MHz. The same setups are used for assessment of the parameters applied for boundary compensation (alpha, depth) of which typical uncertainty values are given. These parameters are used in DASY4 software to improve probe accuracy close to the boundary. The sensitivity in TSL corresponds to NORM<sub>x,y,z</sub> \* ConvF whereby the uncertainty corresponds to that given for ConvF. A frequency dependent ConvF is used in DASY version 4.4 and higher which allows extending the validity from  $\pm 50$  MHz to  $\pm 100$  MHz.
- Spherical Isotropy (3D deviation from isotropy)**: in a field of low gradients realized using a flat phantom exposed by a patch antenna.
- Sensor Offset**: The sensor offset corresponds to the offset of virtual measurement center from the probe tip (on probe axis). No tolerance required.
- Connector Angle**: The angle is assessed using the information gained by determining the NORM<sub>x</sub> (no uncertainty required).



EX3DV4 – SN:3927

May 23, 2014

# Probe EX3DV4

## SN:3927

Manufactured: March 8, 2013  
Calibrated: May 23, 2014

Calibrated for DASY/EASY Systems  
(Note: non-compatible with DASY2 system!)



EX3DV4-- SN:3927

May 23, 2014

**DASY/EASY - Parameters of Probe: EX3DV4 - SN:3927****Basic Calibration Parameters**

	Sensor X	Sensor Y	Sensor Z	Unc (k=2)
Norm ( $\mu\text{V}/(\text{V}/\text{m})^2$ ) <sup>A</sup>	0.57	0.33	0.61	± 10.1 %
DCP (mV) <sup>B</sup>	96.7	96.5	92.4	

**Modulation Calibration Parameters**

UID	Communication System Name		A dB	B dB $\sqrt{\mu\text{V}}$	C	D dB	VR mV	Unc <sup>E</sup> (k=2)
0	CW	X	0.0	0.0	1.0	0.00	133.2	±3.3 %
		Y	0.0	0.0	1.0		148.7	
		Z	0.0	0.0	1.0		135.9	

The reported uncertainty of measurement is stated as the standard uncertainty of measurement multiplied by the coverage factor k=2, which for a normal distribution corresponds to a coverage probability of approximately 95%.

<sup>A</sup> The uncertainties of NormX,Y,Z do not affect the E<sup>2</sup>-field uncertainty inside TSL (see Pages 5 and 6).

<sup>B</sup> Numerical linearization parameter: uncertainty not required.

<sup>E</sup> Uncertainty is determined using the max. deviation from linear response applying rectangular distribution and is expressed for the square of the field value.





EX3DV4- SN:3927

May 23, 2014

**DASY/EASY - Parameters of Probe: EX3DV4 - SN:3927****Calibration Parameter Determined in Head Tissue Simulating Media**

f (MHz) <sup>C</sup>	Relative Permittivity <sup>F</sup>	Conductivity (S/m) <sup>F</sup>	ConvF X	ConvF Y	ConvF Z	Alpha <sup>G</sup>	Depth <sup>G</sup> (mm)	Unct. (k=2)
450	43.5	0.87	11.02	11.02	11.02	0.15	1.30	± 13.3 %
850	41.5	0.92	10.23	10.23	10.23	0.43	0.81	± 12.0 %
1750	40.1	1.37	8.55	8.55	8.55	0.40	0.90	± 12.0 %
1900	40.0	1.40	8.31	8.31	8.31	0.60	0.66	± 12.0 %
2100	39.8	1.49	8.47	8.47	8.47	0.56	0.65	± 12.0 %
2450	39.2	1.80	7.48	7.48	7.48	0.68	0.59	± 12.0 %
5200	36.0	4.66	5.35	5.35	5.35	0.30	1.80	± 13.1 %
5500	35.6	4.96	4.97	4.97	4.97	0.35	1.80	± 13.1 %
5600	35.5	5.07	4.78	4.78	4.78	0.40	1.80	± 13.1 %
5800	35.3	5.27	4.65	4.65	4.65	0.40	1.80	± 13.1 %

<sup>C</sup> Frequency validity above 300 MHz of ± 100 MHz only applies for DASY v4.4 and higher (see Page 2), else it is restricted to ± 50 MHz. The uncertainty is the RSS of the ConvF uncertainty at calibration frequency and the uncertainty for the indicated frequency band. Above 5 GHz frequency validity can be extended to ± 110 MHz. Frequency validity below 300 MHz is ± 10, 25, 40, 50 and 70 MHz for ConvF assessments at 30, 64, 128, 150 and 220 MHz respectively.

<sup>F</sup> At frequencies below 3 GHz, the validity of tissue parameters ( $\epsilon$  and  $\sigma$ ) can be relaxed to ± 10% if liquid compensation formula is applied to measured SAR values. At frequencies above 3 GHz, the validity of tissue parameters ( $\epsilon$  and  $\sigma$ ) is restricted to ± 5%. The uncertainty is the RSS of the ConvF uncertainty for indicated target tissue parameters.

<sup>G</sup> Alpha/Depth are determined during calibration. SPEAG warrants that the remaining deviation due to the boundary effect after compensation is always less than ± 1% for frequencies below 3 GHz and below ± 2% for frequencies between 3-6 GHz at any distance larger than half the probe tip diameter from the boundary.



EX3DV4- SN:3927

May 23, 2014

**DASY/EASY - Parameters of Probe: EX3DV4 - SN:3927****Calibration Parameter Determined in Body Tissue Simulating Media**

f (MHz) <sup>C</sup>	Relative Permittivity <sup>F</sup>	Conductivity (S/m) <sup>F</sup>	ConvF X	ConvF Y	ConvF Z	Alpha <sup>G</sup>	Depth (mm) <sup>G</sup>	Unct. (k=2)
450	56.7	0.94	11.67	11.67	11.67	0.10	1.20	± 13.3 %
850	55.2	0.99	9.91	9.91	9.91	0.28	1.18	± 12.0 %
1750	53.4	1.49	8.45	8.45	8.45	0.71	0.64	± 12.0 %
1900	53.3	1.52	8.10	8.10	8.10	0.38	0.91	± 12.0 %
2100	53.2	1.62	8.40	8.40	8.40	0.40	0.87	± 12.0 %
2450	52.7	1.95	7.63	7.63	7.63	0.80	0.50	± 12.0 %
5200	49.0	5.30	4.61	4.61	4.61	0.40	1.90	± 13.1 %
5500	48.6	5.65	4.30	4.30	4.30	0.40	1.90	± 13.1 %
5600	48.5	5.77	4.23	4.23	4.23	0.40	1.90	± 13.1 %
5800	48.2	6.00	4.25	4.25	4.25	0.45	1.90	± 13.1 %

<sup>C</sup> Frequency validity above 300 MHz of ± 100 MHz only applies for DASY v4.4 and higher (see Page 2), else it is restricted to ± 50 MHz. The uncertainty is the RSS of the ConvF uncertainty at calibration frequency and the uncertainty for the indicated frequency band. Above 5 GHz frequency validity can be extended to ± 110 MHz. Frequency validity below 300 MHz is ± 10, 25, 40, 50 and 70 MHz for ConvF assessments at 30, 64, 128, 150 and 220 MHz respectively.

<sup>F</sup> At frequencies below 3 GHz, the validity of tissue parameters ( $\epsilon$  and  $\sigma$ ) can be relaxed to ± 10% if liquid compensation formula is applied to measured SAR values. At frequencies above 3 GHz, the validity of tissue parameters ( $\epsilon$  and  $\sigma$ ) is restricted to ± 5%. The uncertainty is the RSS of the ConvF uncertainty for indicated target tissue parameters.

<sup>G</sup> Alpha/Depth are determined during calibration. SPEAG warrants that the remaining deviation due to the boundary effect after compensation is always less than ± 1% for frequencies below 3 GHz and below ± 2% for frequencies between 3-6 GHz at any distance larger than half the probe tip diameter from the boundary.





EX3DV4- SN:3927

May 23, 2014

### Frequency Response of E-Field (TEM-Cell: ifi110 EXX, Waveguide: R22)

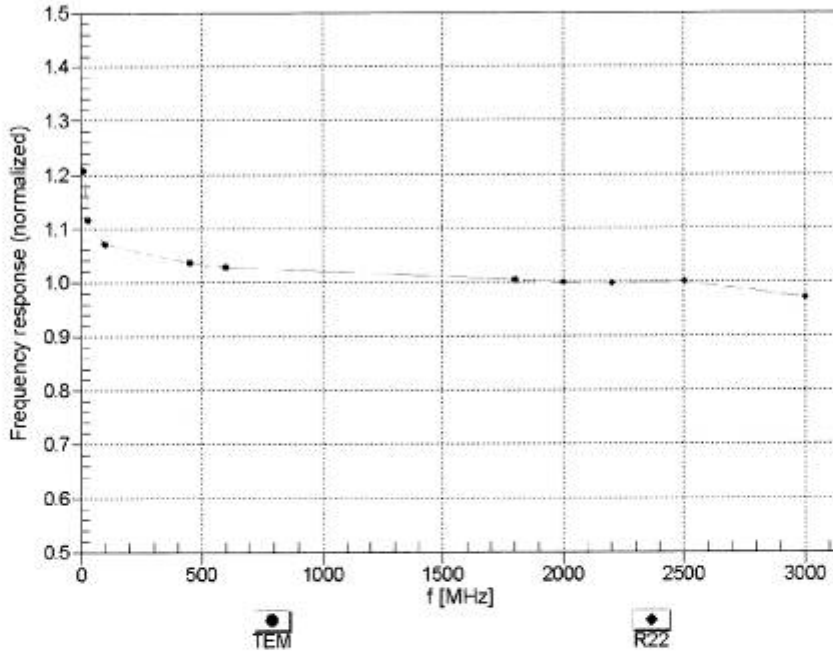

Uncertainty of Frequency Response of E-field:  $\pm 6.3\%$  (k=2)



EX3DV4- SN:3927

May 23, 2014

### Receiving Pattern ( $\phi$ ), $\theta = 0^\circ$

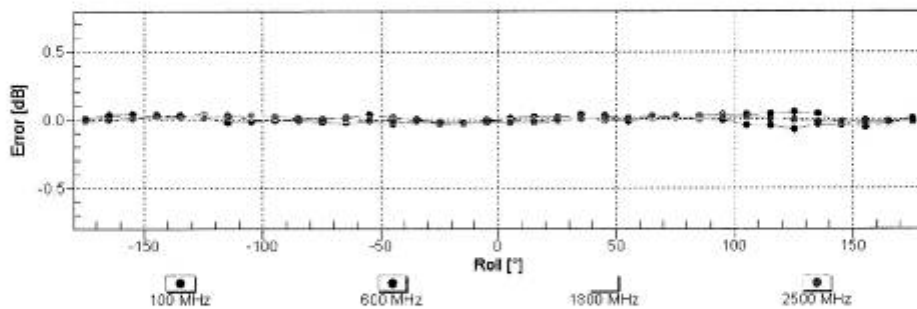
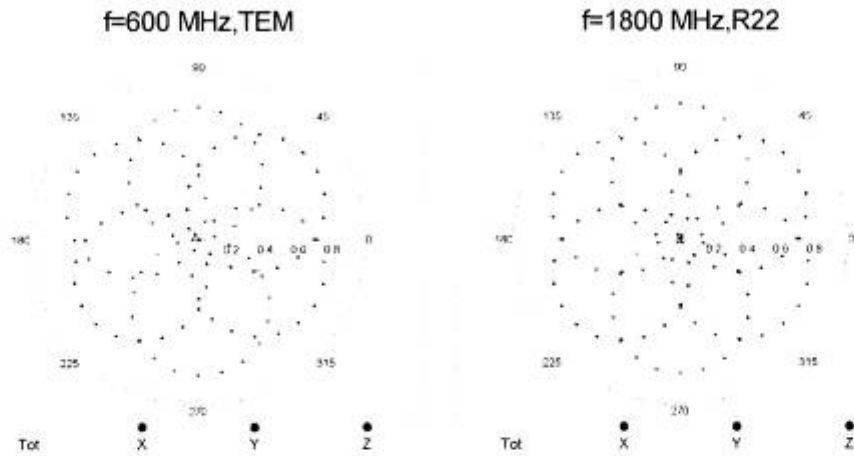

Uncertainty of Axial Isotropy Assessment:  $\pm 0.5\%$  ( $k=2$ )



EX3DV4- SN:3927

May 23, 2014

### Dynamic Range $f(SAR_{head})$ (TEM cell , $f_{eval}= 1900$ MHz)

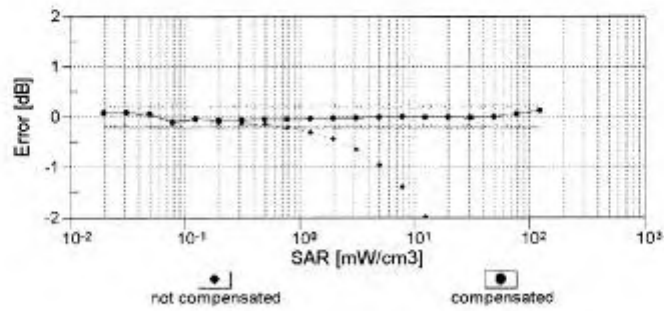
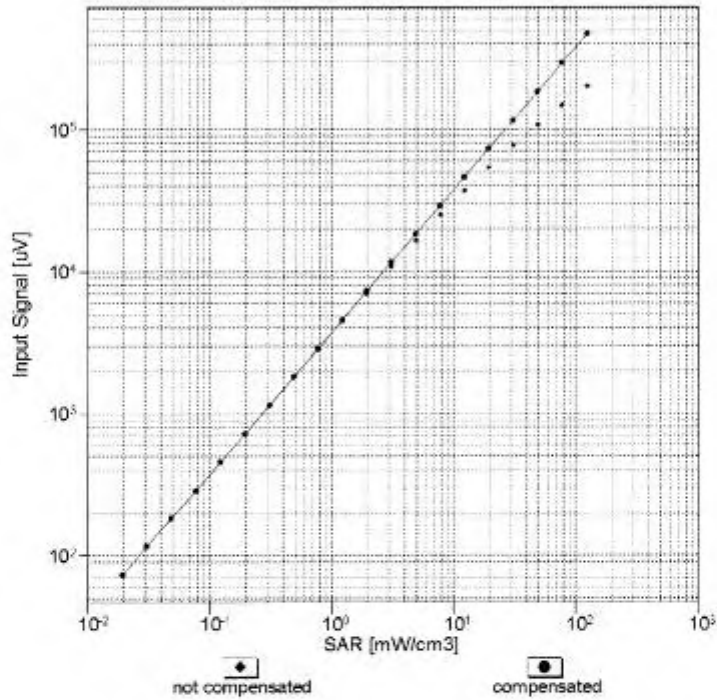

Uncertainty of Linearity Assessment:  $\pm 0.6\%$  (k=2)



EX3DV4- SN:3927

May 23, 2014

### Conversion Factor Assessment

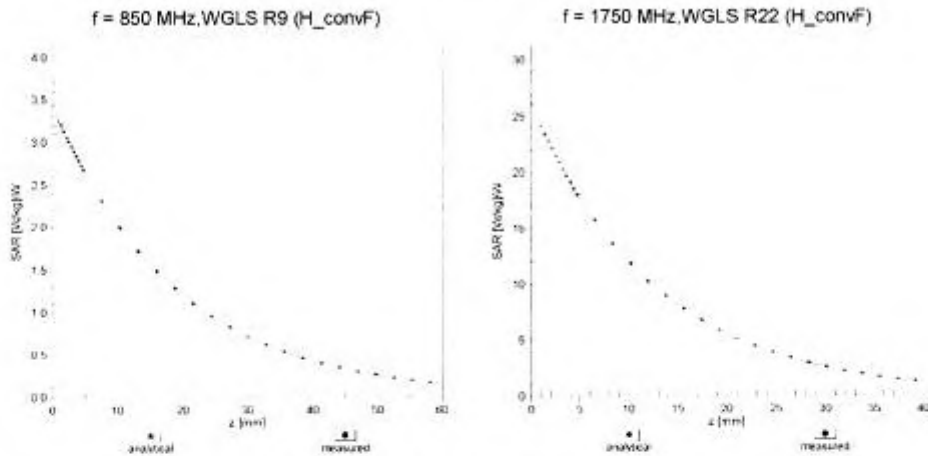

### Deviation from Isotropy in Liquid Error ( $\phi, \theta$ ), f = 900 MHz

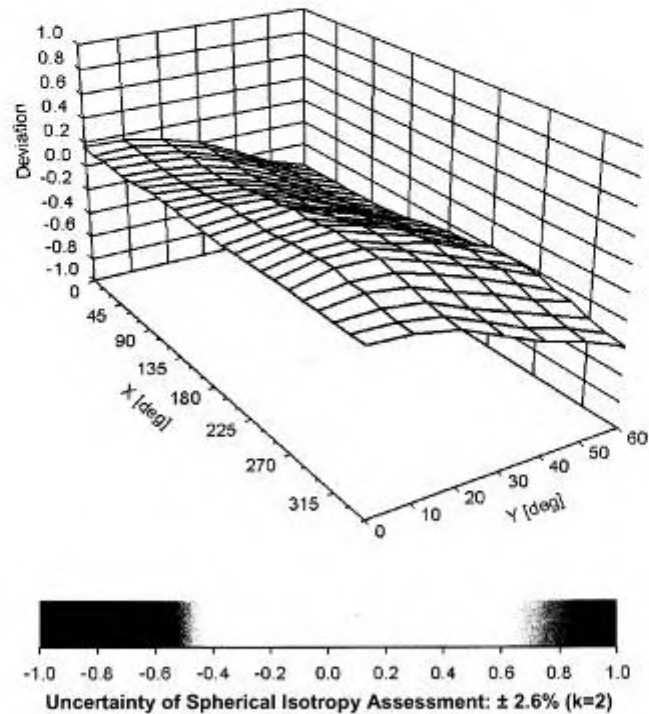



EX3DV4- SN:3927

May 23, 2014

### DASY/EASY - Parameters of Probe: EX3DV4 - SN:3927

#### Other Probe Parameters

Sensor Arrangement	Triangular
Connector Angle (°)	25.1
Mechanical Surface Detection Mode	enabled
Optical Surface Detection Mode	disabled
Probe Overall Length	337 mm
Probe Body Diameter	10 mm
Tip Length	9 mm
Tip Diameter	2.5 mm
Probe Tip to Sensor X Calibration Point	1 mm
Probe Tip to Sensor Y Calibration Point	1 mm
Probe Tip to Sensor Z Calibration Point	1 mm
Recommended Measurement Distance from Surface	2 mm



### 10. Appendix E. Dipole Calibration Data

**Calibration Laboratory of Schmid & Partner Engineering AG**  
Zeughausstrasse 43, 8004 Zurich, Switzerland



**S** Schweizerischer Kalibrierdienst  
**C** Service suisse d'étalonnage  
**S** Servizio svizzero di taratura  
**S** Swiss Calibration Service

Accredited by the Swiss Accreditation Service (SAS)  
The Swiss Accreditation Service is one of the signatories to the EA  
Multilateral Agreement for the recognition of calibration certificates

Accreditation No.: **SCS 108**

Client **CerpPASS (Auden)**

Certificate No: **D450V3-1086\_Jun13**

## CALIBRATION CERTIFICATE

Object: **D450V3 - SN: 1086**

Calibration procedure(s): **QA CAL-15.v7**  
**Calibration procedure for dipole validation kits below 700 MHz**

Calibration date: **June 14, 2013**

This calibration certificate documents the traceability to national standards, which realize the physical units of measurements (SI). The measurements and the uncertainties with confidence probability are given on the following pages and are part of the certificate.

All calibrations have been conducted in the closed laboratory facility: environment temperature (22 ± 3)°C and humidity < 70%.

Calibration Equipment used (M&TE critical for calibration)

Primary Standards	ID #	Cal Date (Certificate No.)	Scheduled Calibration
Power meter E4419B	GB41293874	04-Apr-13 (No. 217-01733)	Apr-14
Power sensor E4412A	MY41498087	04-Apr-13 (No. 217-01733)	Apr-14
Reference 3 dB Attenuator	SN: S5054 (3c)	04-Apr-13 (No. 217-01737)	Apr-14
Reference 20 dB Attenuator	SN: 5058 (20k)	04-Apr-13 (No. 217-01736)	Apr-14
Type-N mismatch combination	SN: 5047.3 / 06327	04-Apr-13 (No. 217-01739)	Apr-14
Reference Probe ET3DV6	SN: 1507	28-Dec-12 (No. ET3-1507_Dec12)	Dec-13
DAE4	SN: 654	10-Apr-13 (No. DAE4-654_Apr13)	Apr-14

Secondary Standards	ID #	Check Date (in house)	Scheduled Check
Power sensor HP 8481A	MY41082317	18-Oct-02 (in house check Oct-11)	In house check: Oct-13
RF generator R&S SMT-06	100005	04-Aug-99 (in house check Oct-11)	In house check: Oct-13
Network Analyzer HP 8753E	US37390585 S4206	18-Oct-01 (in house check Oct-12)	In house check: Oct-13

Calibrated by:	Name: <b>Jeton Kastrati</b>	Function: <b>Laboratory Technician</b>	Signature:
Approved by:	Name: <b>Katja Pokovic</b>	Function: <b>Technical Manager</b>	Signature:

Issued: June 14, 2013

This calibration certificate shall not be reproduced except in full without written approval of the laboratory.





**Calibration Laboratory of**  
Schmid & Partner  
Engineering AG  
Zeughausstrasse 43, 8004 Zurich, Switzerland



**S** Schweizerischer Kalibrierdienst  
**S** Service suisse d'étalonnage  
**C** Servizio svizzero di taratura  
**S** Swiss Calibration Service

Accredited by the Swiss Accreditation Service (SAS)  
The Swiss Accreditation Service is one of the signatories to the EA  
Multilateral Agreement for the recognition of calibration certificates

Accreditation No.: **SCS 108**

#### Glossary:

TSL	tissue simulating liquid
ConvF	sensitivity in TSL / NORM x,y,z
N/A	not applicable or not measured

#### Calibration is Performed According to the Following Standards:

- IEEE Std 1528-2003, "IEEE Recommended Practice for Determining the Peak Spatial-Averaged Specific Absorption Rate (SAR) in the Human Head from Wireless Communications Devices: Measurement Techniques", December 2003
- IEC 62209-1, "Procedure to measure the Specific Absorption Rate (SAR) for hand-held devices used in close proximity to the ear (frequency range of 300 MHz to 3 GHz)", February 2005
- Federal Communications Commission Office of Engineering & Technology (FCC OET), "Evaluating Compliance with FCC Guidelines for Human Exposure to Radiofrequency Electromagnetic Fields; Additional Information for Evaluating Compliance of Mobile and Portable Devices with FCC Limits for Human Exposure to Radiofrequency Emissions", Supplement C (Edition 01-01) to Bulletin 65

#### Additional Documentation:

- DASY4/5 System Handbook

#### Methods Applied and Interpretation of Parameters:

- Measurement Conditions:** Further details are available from the Validation Report at the end of the certificate. All figures stated in the certificate are valid at the frequency indicated.
- Antenna Parameters with TSL:** The dipole is mounted with the spacer to position its feed point exactly below the center marking of the flat phantom section, with the arms oriented parallel to the body axis.
- Feed Point Impedance and Return Loss:** These parameters are measured with the dipole positioned under the liquid filled phantom. The impedance stated is transformed from the measurement at the SMA connector to the feed point. The Return Loss ensures low reflected power. No uncertainty required.
- Electrical Delay:** One-way delay between the SMA connector and the antenna feed point. No uncertainty required.
- SAR measured:** SAR measured at the stated antenna input power.
- SAR normalized:** SAR as measured, normalized to an input power of 1 W at the antenna connector.
- SAR for nominal TSL parameters:** The measured TSL parameters are used to calculate the nominal SAR result.

The reported uncertainty of measurement is stated as the standard uncertainty of measurement multiplied by the coverage factor  $k=2$ , which for a normal distribution corresponds to a coverage probability of approximately 95%.



**Measurement Conditions**

DASY system configuration, as far as not given on page 1.

<b>DASY Version</b>	DASY5	V52.8.7
<b>Extrapolation</b>	Advanced Extrapolation	
<b>Phantom</b>	ELI4 Flat Phantom	Shell thickness: $2 \pm 0.2$ mm
<b>Distance Dipole Center - TSL</b>	15 mm	with Spacer
<b>Zoom Scan Resolution</b>	dx, dy, dz = 5 mm	
<b>Frequency</b>	450 MHz $\pm$ 1 MHz	

**Head TSL parameters**

The following parameters and calculations were applied.

	Temperature	Permittivity	Conductivity
<b>Nominal Head TSL parameters</b>	22.0 °C	43.5	0.87 mho/m
<b>Measured Head TSL parameters</b>	(22.0 $\pm$ 0.2) °C	44.2 $\pm$ 6 %	0.90 mho/m $\pm$ 6 %
<b>Head TSL temperature change during test</b>	< 0.5 °C	---	---

**SAR result with Head TSL**

<b>SAR averaged over 1 cm<sup>3</sup> (1 g) of Head TSL</b>	Condition	
SAR measured	250 mW input power	1.21 W/kg
SAR for nominal Head TSL parameters	normalized to 1W	<b>4.73 W/kg <math>\pm</math> 18.1 % (k=2)</b>

<b>SAR averaged over 10 cm<sup>3</sup> (10 g) of Head TSL</b>	condition	
SAR measured	250 mW input power	0.802 W/kg
SAR for nominal Head TSL parameters	normalized to 1W	<b>3.14 W/kg <math>\pm</math> 17.6 % (k=2)</b>

**Body TSL parameters**

The following parameters and calculations were applied.

	Temperature	Permittivity	Conductivity
<b>Nominal Body TSL parameters</b>	22.0 °C	56.7	0.94 mho/m
<b>Measured Body TSL parameters</b>	(22.0 $\pm$ 0.2) °C	57.1 $\pm$ 6 %	0.96 mho/m $\pm$ 6 %
<b>Body TSL temperature change during test</b>	< 0.5 °C	---	---

**SAR result with Body TSL**

<b>SAR averaged over 1 cm<sup>3</sup> (1 g) of Body TSL</b>	Condition	
SAR measured	250 mW input power	1.17 W/kg
SAR for nominal Body TSL parameters	normalized to 1W	<b>4.61 W/kg <math>\pm</math> 18.1 % (k=2)</b>

<b>SAR averaged over 10 cm<sup>3</sup> (10 g) of Body TSL</b>	condition	
SAR measured	250 mW input power	0.776 W/kg
SAR for nominal Body TSL parameters	normalized to 1W	<b>3.06 W/kg <math>\pm</math> 17.6 % (k=2)</b>

**Appendix****Antenna Parameters with Head TSL**

Impedance, transformed to feed point	51.1 $\Omega$ - 8.2 j $\Omega$
Return Loss	- 21.8 dB

**Antenna Parameters with Body TSL**

Impedance, transformed to feed point	56.2 $\Omega$ - 6.2 j $\Omega$
Return Loss	- 21.7 dB

**General Antenna Parameters and Design**

Electrical Delay (one direction)	1.349 ns
----------------------------------	----------

After long term use with 100W radiated power, only a slight warming of the dipole near the feedpoint can be measured.

The dipole is made of standard semirigid coaxial cable. The center conductor of the feeding line is directly connected to the second arm of the dipole. The antenna is therefore short-circuited for DC-signals. On some of the dipoles, small end caps are added to the dipole arms in order to improve matching when loaded according to the position as explained in the "Measurement Conditions" paragraph. The SAR data are not affected by this change. The overall dipole length is still according to the Standard.

No excessive force must be applied to the dipole arms, because they might bend or the soldered connections near the feedpoint may be damaged.

**Additional EUT Data**

Manufactured by	SPEAG
Manufactured on	October 10, 2012

**DASY5 Validation Report for Head TSL**

Date: 14.06.2013

Test Laboratory: The name of your organization

**DUT: Dipole 450 MHz; Type: D450V3; Serial: D450V3 - SN: 1086**

Communication System: UID 0 - CW ; Frequency: 450 MHz

Medium parameters used:  $f = 450$  MHz;  $\sigma = 0.9$  S/m;  $\epsilon_r = 44.2$ ;  $\rho = 1000$  kg/m<sup>3</sup>

Phantom section: Flat Section

Measurement Standard: DASY5 (IEEE/IEC/ANSI C63.19-2007)

DASY52 Configuration:

- Probe: ET3DV6 - SN1507; ConvF(6.59, 6.59, 6.59); Calibrated: 28.12.2012;
- Sensor-Surface: 4mm (Mechanical Surface Detection)
- Electronics: DAE4 Sn654; Calibrated: 10.04.2013
- Phantom: ELI 4.0; Type: QDOVA001BA; Serial: 1003
- DASY52 52.8.7(1137); SEMCAD X 14.6.10(7164)

**Dipole Calibration for Head Tissue/d=15mm, Pin=250mW/Zoom Scan (7x7x7)/Cube 0:**Measurement grid:  $dx=5$ mm,  $dy=5$ mm,  $dz=5$ mm

Reference Value = 39.197 V/m; Power Drift = -0.04 dB

Peak SAR (extrapolated) = 1.85 W/kg

**SAR(1 g) = 1.21 W/kg; SAR(10 g) = 0.802 W/kg**

Maximum value of SAR (measured) = 1.30 W/kg

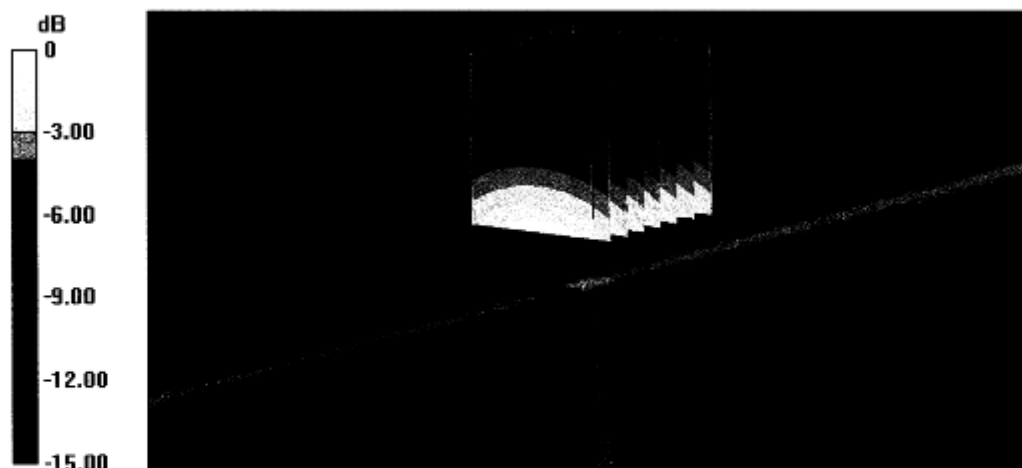

0 dB = 1.30 W/kg = 1.14 dBW/kg



Impedance Measurement Plot for Head TSL

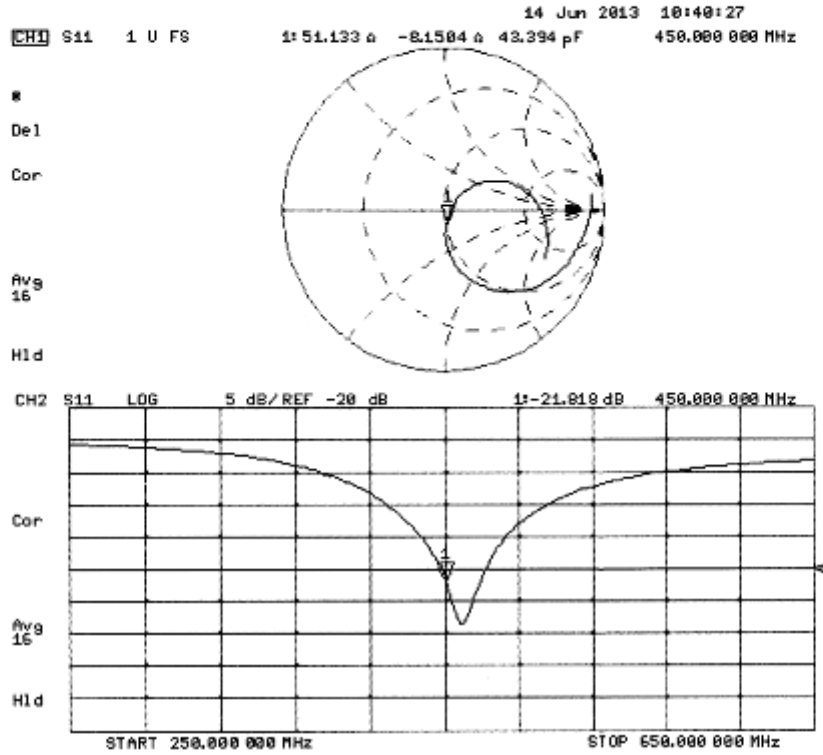

**DASY5 Validation Report for Body TSL**

Date: 14.06.2013

Test Laboratory: The name of your organization

**DUT: Dipole 450 MHz; Type: D450V3; Serial: D450V3 - SN: 1086**

Communication System: UID 0 - CW ; Frequency: 450 MHz

Medium parameters used:  $f = 450$  MHz;  $\sigma = 0.96$  S/m;  $\epsilon_r = 57.1$ ;  $\rho = 1000$  kg/m<sup>3</sup>

Phantom section: Flat Section

Measurement Standard: DASY5 (IEEE/IEC/ANSI C63.19-2007)

DASY52 Configuration:

- Probe: ET3DV6 - SN1507; ConvF(7.03, 7.03, 7.03); Calibrated: 28.12.2012;
- Sensor-Surface: 4mm (Mechanical Surface Detection)
- Electronics: DAF4 Sn654; Calibrated: 10.04.2013
- Phantom: ELI 4.0; Type: QDOVA001BA; Serial: 1003
- DASY52 52.8.7(1137); SEMCAD X 14.6.10(7164)

**Dipole Calibration for Body Tissue/d=15mm, Pin=250mW/Zoom Scan (7x7x7)/Cube 0:**

Measurement grid: dx=5mm, dy=5mm, dz=5mm

Reference Value = 39.197 V/m; Power Drift = -0.04 dB

Peak SAR (extrapolated) = 1.81 W/kg

**SAR(1 g) = 1.17 W/kg; SAR(10 g) = 0.776 W/kg**

Maximum value of SAR (measured) = 1.25 W/kg

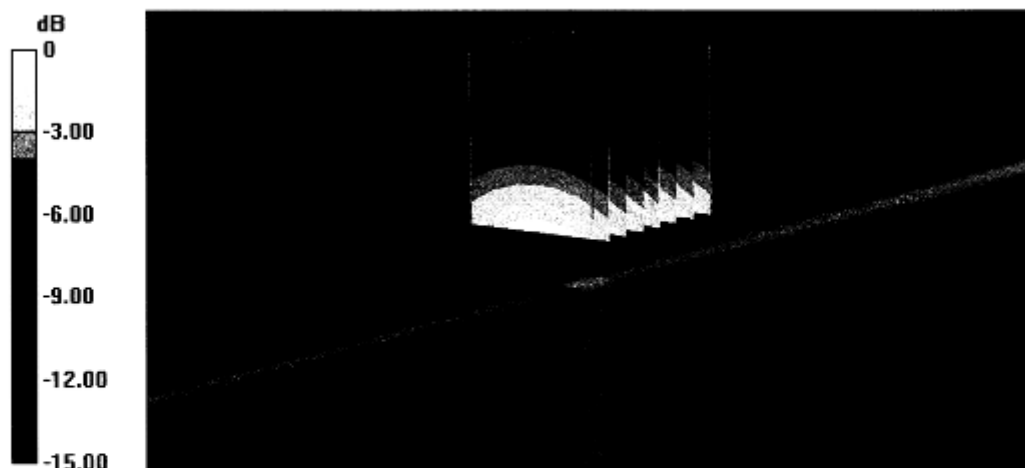



Impedance Measurement Plot for Body TSL

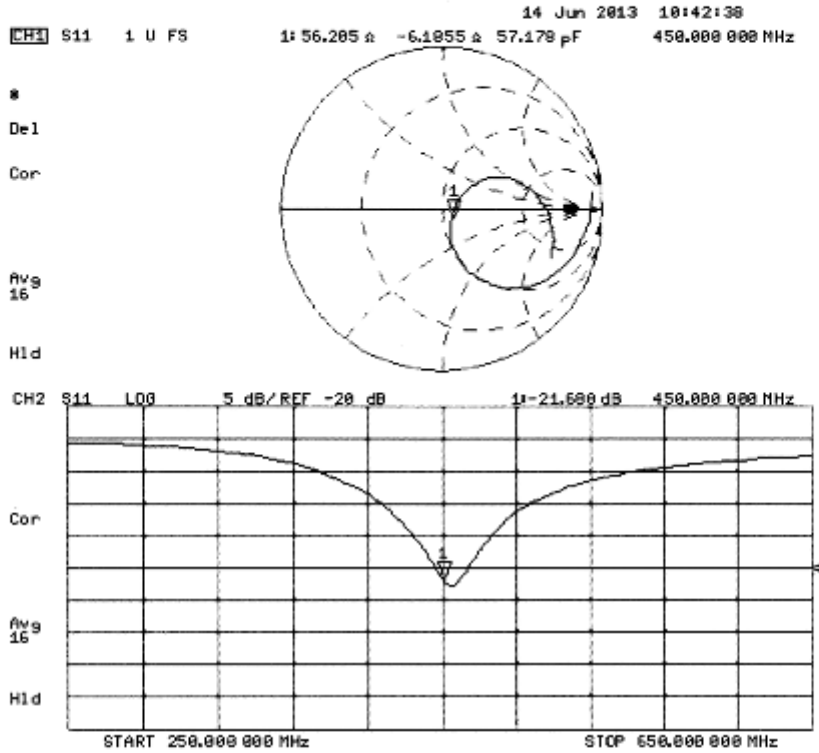



Calibration Laboratory of Schmid & Partner Engineering AG, Zeughausstrasse 43, 8004 Zurich, Switzerland



S Schweizerischer Kalibrierdienst, C Service suisse d'etalonnage, S Servizio svizzero di taratura, S Swiss Calibration Service

Accredited by the Swiss Accreditation Service (SAS), The Swiss Accreditation Service is one of the signatories to the EA Multilateral Agreement for the recognition of calibration certificates

Accreditation No.: SCS 108

Client: CerpPASS (Auden)

Certificate No: D850V2-1008\_Jun13

CALIBRATION CERTIFICATE

Object: D850V2 - SN: 1008
Calibration procedure(s): QA CAL-05.v9 Calibration procedure for dipole validation kits above 700 MHz
Calibration date: June 13, 2013

This calibration certificate documents the traceability to national standards, which realize the physical units of measurements (SI). The measurements and the uncertainties with confidence probability are given on the following pages and are part of the certificate.

All calibrations have been conducted in the closed laboratory facility: environment temperature (22 ± 3)°C and humidity < 70%.

Calibration Equipment used (M&TE critical for calibration)

Table with 4 columns: Primary Standards, ID #, Cal Date (Certificate No.), Scheduled Calibration. Includes items like Power meter EPM-442A, Power sensor HP 8481A, Reference 20 dB Attenuator, etc.

Calibrated by: Leif Klysner, Laboratory Technician
Approved by: Katja Pokovic, Technical Manager

Issued: June 13, 2013

This calibration certificate shall not be reproduced except in full without written approval of the laboratory.





**Calibration Laboratory of**  
Schmid & Partner  
Engineering AG  
Zeughausstrasse 43, 8004 Zurich, Switzerland



**S** Schweizerischer Kalibrierdienst  
**S** Service suisse d'étalonnage  
**C** Servizio svizzero di taratura  
**S** Swiss Calibration Service

Accredited by the Swiss Accreditation Service (SAS)  
The Swiss Accreditation Service is one of the signatories to the EA  
Multilateral Agreement for the recognition of calibration certificates

Accreditation No.: **SCS 108**

#### Glossary:

TSL	tissue simulating liquid
ConvF	sensitivity in TSL / NORM x,y,z
N/A	not applicable or not measured

#### Calibration is Performed According to the Following Standards:

- IEEE Std 1528-2003, "IEEE Recommended Practice for Determining the Peak Spatial-Averaged Specific Absorption Rate (SAR) in the Human Head from Wireless Communications Devices: Measurement Techniques", December 2003
- IEC 62209-1, "Procedure to measure the Specific Absorption Rate (SAR) for hand-held devices used in close proximity to the ear (frequency range of 300 MHz to 3 GHz)", February 2005
- Federal Communications Commission Office of Engineering & Technology (FCC OET), "Evaluating Compliance with FCC Guidelines for Human Exposure to Radiofrequency Electromagnetic Fields; Additional Information for Evaluating Compliance of Mobile and Portable Devices with FCC Limits for Human Exposure to Radiofrequency Emissions", Supplement C (Edition 01-01) to Bulletin 65

#### Additional Documentation:

- DASY4/5 System Handbook

#### Methods Applied and Interpretation of Parameters:

- Measurement Conditions:** Further details are available from the Validation Report at the end of the certificate. All figures stated in the certificate are valid at the frequency indicated.
- Antenna Parameters with TSL:** The dipole is mounted with the spacer to position its feed point exactly below the center marking of the flat phantom section, with the arms oriented parallel to the body axis.
- Feed Point Impedance and Return Loss:** These parameters are measured with the dipole positioned under the liquid filled phantom. The impedance stated is transformed from the measurement at the SMA connector to the feed point. The Return Loss ensures low reflected power. No uncertainty required.
- Electrical Delay:** One-way delay between the SMA connector and the antenna feed point. No uncertainty required.
- SAR measured:** SAR measured at the stated antenna input power.
- SAR normalized:** SAR as measured, normalized to an input power of 1 W at the antenna connector.
- SAR for nominal TSL parameters:** The measured TSL parameters are used to calculate the nominal SAR result.

The reported uncertainty of measurement is stated as the standard uncertainty of measurement multiplied by the coverage factor  $k=2$ , which for a normal distribution corresponds to a coverage probability of approximately 95%.

**Measurement Conditions**

DASY system configuration, as far as not given on page 1.

<b>DASY Version</b>	DASY5	V52.8.7
<b>Extrapolation</b>	Advanced Extrapolation	
<b>Phantom</b>	Modular Flat Phantom	
<b>Distance Dipole Center - TSL</b>	15 mm	with Spacer
<b>Zoom Scan Resolution</b>	dx, dy, dz = 5 mm	
<b>Frequency</b>	850 MHz $\pm$ 1 MHz	

**Head TSL parameters**

The following parameters and calculations were applied.

	Temperature	Permittivity	Conductivity
<b>Nominal Head TSL parameters</b>	22.0 °C	41.5	0.92 mho/m
<b>Measured Head TSL parameters</b>	(22.0 $\pm$ 0.2) °C	40.5 $\pm$ 6 %	0.95 mho/m $\pm$ 6 %
<b>Head TSL temperature change during test</b>	< 0.5 °C	----	----

**SAR result with Head TSL**

<b>SAR averaged over 1 cm<sup>3</sup> (1 g) of Head TSL</b>	Condition	
SAR measured	250 mW input power	2.53 W/kg
SAR for nominal Head TSL parameters	normalized to 1W	<b>9.83 W/kg <math>\pm</math> 17.0 % (k=2)</b>

<b>SAR averaged over 10 cm<sup>3</sup> (10 g) of Head TSL</b>	condition	
SAR measured	250 mW input power	1.63 W/kg
SAR for nominal Head TSL parameters	normalized to 1W	<b>6.37 W/kg <math>\pm</math> 16.5 % (k=2)</b>

**Body TSL parameters**

The following parameters and calculations were applied.

	Temperature	Permittivity	Conductivity
<b>Nominal Body TSL parameters</b>	22.0 °C	55.2	0.99 mho/m
<b>Measured Body TSL parameters</b>	(22.0 $\pm$ 0.2) °C	53.9 $\pm$ 6 %	1.03 mho/m $\pm$ 6 %
<b>Body TSL temperature change during test</b>	< 0.5 °C	----	----

**SAR result with Body TSL**

<b>SAR averaged over 1 cm<sup>3</sup> (1 g) of Body TSL</b>	Condition	
SAR measured	250 mW input power	2.49 W/kg
SAR for nominal Body TSL parameters	normalized to 1W	<b>9.62 W/kg <math>\pm</math> 17.0 % (k=2)</b>

<b>SAR averaged over 10 cm<sup>3</sup> (10 g) of Body TSL</b>	condition	
SAR measured	250 mW input power	1.61 W/kg
SAR for nominal Body TSL parameters	normalized to 1W	<b>6.27 W/kg <math>\pm</math> 16.5 % (k=2)</b>

**Appendix****Antenna Parameters with Head TSL**

Impedance, transformed to feed point	52.2 $\Omega$ - 3.1 $j\Omega$
Return Loss	- 28.6 dB

**Antenna Parameters with Body TSL**

Impedance, transformed to feed point	47.5 $\Omega$ - 5.3 $j\Omega$
Return Loss	- 24.4 dB

**General Antenna Parameters and Design**

Electrical Delay (one direction)	1.382 ns
----------------------------------	----------

After long term use with 100W radiated power, only a slight warming of the dipole near the feedpoint can be measured.

The dipole is made of standard semirigid coaxial cable. The center conductor of the feeding line is directly connected to the second arm of the dipole. The antenna is therefore short-circuited for DC-signals. On some of the dipoles, small end caps are added to the dipole arms in order to improve matching when loaded according to the position as explained in the "Measurement Conditions" paragraph. The SAR data are not affected by this change. The overall dipole length is still according to the Standard.

No excessive force must be applied to the dipole arms, because they might bend or the soldered connections near the feedpoint may be damaged.

**Additional EUT Data**

Manufactured by	SPEAG
Manufactured on	January 30, 2009

**DASY5 Validation Report for Head TSL**

Date: 13.06.2013

Test Laboratory: SPEAG, Zurich, Switzerland

**DUT: Dipole 850 MHz; Type: D850V2; Serial: D850V2 - SN: 1008**

Communication System: UID 0 - CW ; Frequency: 850 MHz

Medium parameters used:  $f = 850$  MHz;  $\sigma = 0.95$  S/m;  $\epsilon_r = 40.5$ ;  $\rho = 1000$  kg/m<sup>3</sup>

Phantom section: Flat Section

Measurement Standard: DASY5 (IEEE/IEC/ANSI C63.19-2007)

DASY52 Configuration:

- Probe: ES3DV3 - SN3205; ConvF(6.05, 6.05, 6.05); Calibrated: 28.12.2012;
- Sensor-Surface: 3mm (Mechanical Surface Detection)
- Electronics: DAE4 Sn601; Calibrated: 25.04.2013
- Phantom: Flat Phantom 4.9L; Type: QD000P49AA; Serial: 1001
- DASY52 52.8.7(1137); SEMCAD X 14.6.10(7164)

**Dipole Calibration for Head Tissue/Pin=250 mW, d=15mm/Zoom Scan (7x7x7)****(7x7x7)/Cube 0:** Measurement grid: dx=5mm, dy=5mm, dz=5mm

Reference Value = 57.472 V/m; Power Drift = -0.00 dB

Peak SAR (extrapolated) = 3.82 W/kg

**SAR(1 g) = 2.53 W/kg; SAR(10 g) = 1.63 W/kg**

Maximum value of SAR (measured) = 2.96 W/kg

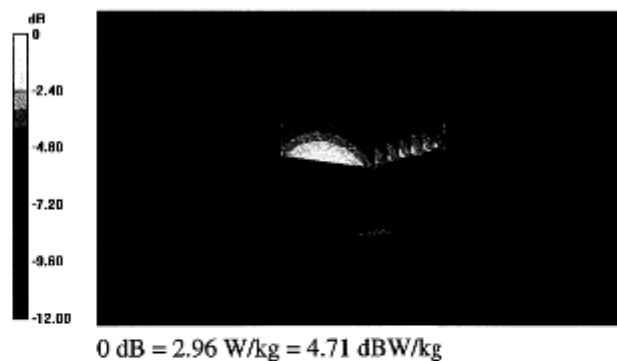



Impedance Measurement Plot for Head TSL

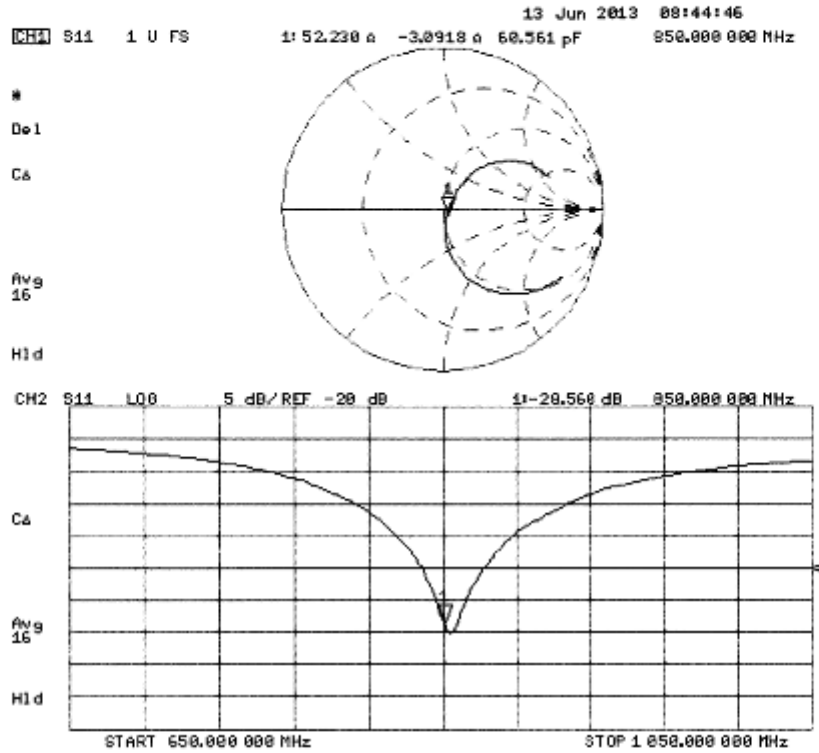

**DASY5 Validation Report for Body TSL**

Date: 12.06.2013

Test Laboratory: SPEAG, Zurich, Switzerland

**DUT: Dipole 850 MHz; Type: D850V2; Serial: D850V2 - SN: 1008**

Communication System: UID 0 - CW ; Frequency: 850 MHz

Medium parameters used:  $f = 850$  MHz;  $\sigma = 1.03$  S/m;  $\epsilon_r = 53.9$ ;  $\rho = 1000$  kg/m<sup>3</sup>

Phantom section: Flat Section

Measurement Standard: DASY5 (IEEE/IEC/ANSI C63.19-2007)

DASY52 Configuration:

- Probe: ES3DV3 - SN3205; ConvF(6.01, 6.01, 6.01); Calibrated: 28.12.2012;
- Sensor-Surface: 3mm (Mechanical Surface Detection)
- Electronics: DAE4 Sn601; Calibrated: 25.04.2013
- Phantom: Flat Phantom 4.9L; Type: QD000P49AA; Serial: 1001
- DASY52 52.8.7(1137); SEMCAD X 14.6.10(7164)

**Dipole Calibration for Body Tissue/Pin=250 mW, d=15mm/Zoom Scan (7x7x7)****(7x8x7)/Cube 0:** Measurement grid: dx=5mm, dy=5mm, dz=5mm

Reference Value = 54.836 V/m; Power Drift = 0.03 dB

Peak SAR (extrapolated) = 3.67 W/kg

**SAR(1 g) = 2.49 W/kg; SAR(10 g) = 1.61 W/kg**

Maximum value of SAR (measured) = 2.91 W/kg

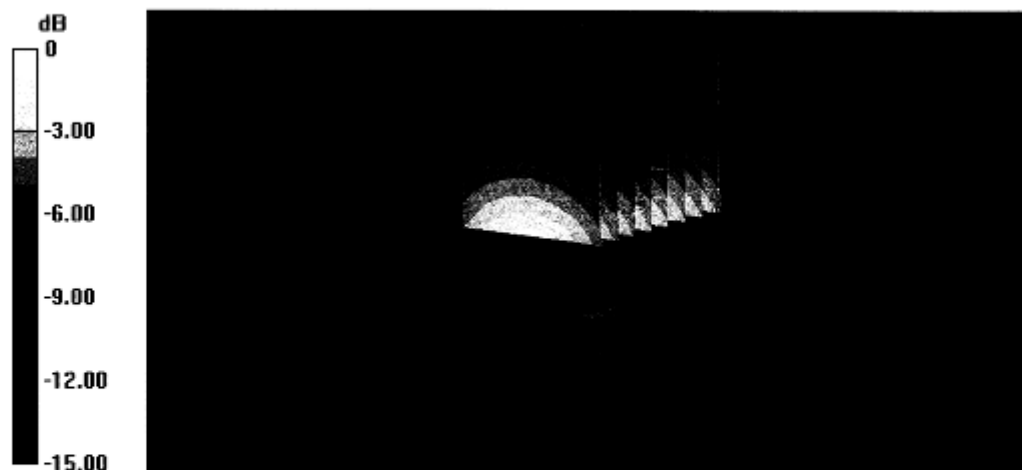



Impedance Measurement Plot for Body TSL

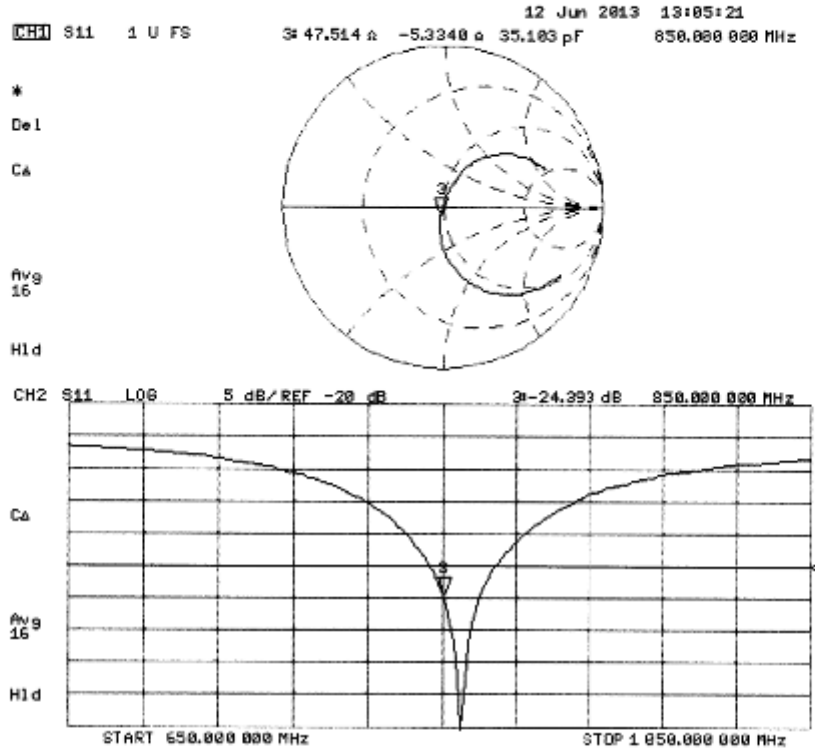





Calibration Laboratory of Schmid & Partner Engineering AG Zeughausstrasse 43, 8004 Zurich, Switzerland



S Schweizerischer Kalibrierdienst
C Service suisse d'etalonnage
S Servizio svizzero di taratura
S Swiss Calibration Service

Accredited by the Swiss Accreditation Service (SAS)
The Swiss Accreditation Service is one of the signatories to the EA Multilateral Agreement for the recognition of calibration certificates

Accreditation No.: SCS 108

Client CerpPASS (Auden)

Certificate No: D1750V2-1097\_Jun13

CALIBRATION CERTIFICATE

Object: D1750V2 - SN: 1097
Calibration procedure(s): QA CAL-05.v9
Calibration procedure for dipole validation kits above 700 MHz
Calibration date: June 11, 2013

This calibration certificate documents the traceability to national standards, which realize the physical units of measurements (SI). The measurements and the uncertainties with confidence probability are given on the following pages and are part of the certificate.

All calibrations have been conducted in the closed laboratory facility: environment temperature (22 ± 3)°C and humidity < 70%.

Calibration Equipment used (M&TE critical for calibration)

Table with 4 columns: Primary Standards, ID #, Cal Date (Certificate No.), Scheduled Calibration. Includes items like Power meter EPM-442A, Power sensor HP 8481A, Reference 20 dB Attenuator, etc.

Calibrated by: Jeton Kastrati, Laboratory Technician
Approved by: Katja Pokovic, Technical Manager

Issued: June 13, 2013

This calibration certificate shall not be reproduced except in full without written approval of the laboratory.



**Calibration Laboratory of  
Schmid & Partner  
Engineering AG**  
Zeughausstrasse 43, 8004 Zurich, Switzerland



**S** Schweizerischer Kallbrierdienst  
**S** Service suisse d'étalonnage  
**C** Servizio svizzero di taratura  
**S** Swiss Calibration Service

Accredited by the Swiss Accreditation Service (SAS)  
The Swiss Accreditation Service is one of the signatories to the EA  
Multilateral Agreement for the recognition of calibration certificates

Accreditation No.: **SCS 108**

#### Glossary:

TSL	tissue simulating liquid
ConvF	sensitivity in TSL / NORM x,y,z
N/A	not applicable or not measured

#### Calibration is Performed According to the Following Standards:

- IEEE Std 1528-2003, "IEEE Recommended Practice for Determining the Peak Spatial-Averaged Specific Absorption Rate (SAR) in the Human Head from Wireless Communications Devices: Measurement Techniques", December 2003
- IEC 62209-1, "Procedure to measure the Specific Absorption Rate (SAR) for hand-held devices used in close proximity to the ear (frequency range of 300 MHz to 3 GHz)", February 2005
- Federal Communications Commission Office of Engineering & Technology (FCC OET), "Evaluating Compliance with FCC Guidelines for Human Exposure to Radiofrequency Electromagnetic Fields; Additional Information for Evaluating Compliance of Mobile and Portable Devices with FCC Limits for Human Exposure to Radiofrequency Emissions", Supplement C (Edition 01-01) to Bulletin 65

#### Additional Documentation:

- DASY4/5 System Handbook

#### Methods Applied and Interpretation of Parameters:

- Measurement Conditions:** Further details are available from the Validation Report at the end of the certificate. All figures stated in the certificate are valid at the frequency indicated.
- Antenna Parameters with TSL:** The dipole is mounted with the spacer to position its feed point exactly below the center marking of the flat phantom section, with the arms oriented parallel to the body axis.
- Feed Point Impedance and Return Loss:** These parameters are measured with the dipole positioned under the liquid filled phantom. The impedance stated is transformed from the measurement at the SMA connector to the feed point. The Return Loss ensures low reflected power. No uncertainty required.
- Electrical Delay:** One-way delay between the SMA connector and the antenna feed point. No uncertainty required.
- SAR measured:** SAR measured at the stated antenna input power.
- SAR normalized:** SAR as measured, normalized to an input power of 1 W at the antenna connector.
- SAR for nominal TSL parameters:** The measured TSL parameters are used to calculate the nominal SAR result.

The reported uncertainty of measurement is stated as the standard uncertainty of measurement multiplied by the coverage factor  $k=2$ , which for a normal distribution corresponds to a coverage probability of approximately 95%.

**Measurement Conditions**

DASY system configuration, as far as not given on page 1.

<b>DASY Version</b>	DASY5	V52.8.7
<b>Extrapolation</b>	Advanced Extrapolation	
<b>Phantom</b>	Modular Flat Phantom	
<b>Distance Dipole Center - TSL</b>	10 mm	with Spacer
<b>Zoom Scan Resolution</b>	dx, dy, dz = 5 mm	
<b>Frequency</b>	1750 MHz $\pm$ 1 MHz	

**Head TSL parameters**

The following parameters and calculations were applied.

	Temperature	Permittivity	Conductivity
<b>Nominal Head TSL parameters</b>	22.0 °C	40.1	1.37 mho/m
<b>Measured Head TSL parameters</b>	(22.0 $\pm$ 0.2) °C	39.1 $\pm$ 6 %	1.32 mho/m $\pm$ 6 %
<b>Head TSL temperature change during test</b>	< 0.5 °C	----	----

**SAR result with Head TSL**

<b>SAR averaged over 1 cm<sup>3</sup> (1 g) of Head TSL</b>	Condition	
SAR measured	250 mW input power	9.07 W/kg
SAR for nominal Head TSL parameters	normalized to 1W	<b>36.9 W/kg <math>\pm</math> 17.0 % (k=2)</b>

<b>SAR averaged over 10 cm<sup>3</sup> (10 g) of Head TSL</b>	condition	
SAR measured	250 mW input power	4.85 W/kg
SAR for nominal Head TSL parameters	normalized to 1W	<b>19.6 W/kg <math>\pm</math> 16.5 % (k=2)</b>

**Body TSL parameters**

The following parameters and calculations were applied.

	Temperature	Permittivity	Conductivity
<b>Nominal Body TSL parameters</b>	22.0 °C	53.4	1.49 mho/m
<b>Measured Body TSL parameters</b>	(22.0 $\pm$ 0.2) °C	51.7 $\pm$ 6 %	1.51 mho/m $\pm$ 6 %
<b>Body TSL temperature change during test</b>	< 0.5 °C	----	----

**SAR result with Body TSL**

<b>SAR averaged over 1 cm<sup>3</sup> (1 g) of Body TSL</b>	Condition	
SAR measured	250 mW input power	9.46 W/kg
SAR for nominal Body TSL parameters	normalized to 1W	<b>37.2 W/kg <math>\pm</math> 17.0 % (k=2)</b>

<b>SAR averaged over 10 cm<sup>3</sup> (10 g) of Body TSL</b>	condition	
SAR measured	250 mW input power	5.08 W/kg
SAR for nominal Body TSL parameters	normalized to 1W	<b>20.1 W/kg <math>\pm</math> 16.5 % (k=2)</b>

**Appendix****Antenna Parameters with Head TSL**

Impedance, transformed to feed point	51.0 $\Omega$ + 0.5 j $\Omega$
Return Loss	- 38.8 dB

**Antenna Parameters with Body TSL**

Impedance, transformed to feed point	46.6 $\Omega$ + 0.2 j $\Omega$
Return Loss	- 29.2 dB

**General Antenna Parameters and Design**

Electrical Delay (one direction)	1.218 ns
----------------------------------	----------

After long term use with 100W radiated power, only a slight warming of the dipole near the feedpoint can be measured.

The dipole is made of standard semirigid coaxial cable. The center conductor of the feeding line is directly connected to the second arm of the dipole. The antenna is therefore short-circuited for DC-signals. On some of the dipoles, small end caps are added to the dipole arms in order to improve matching when loaded according to the position as explained in the "Measurement Conditions" paragraph. The SAR data are not affected by this change. The overall dipole length is still according to the Standard.

No excessive force must be applied to the dipole arms, because they might bend or the soldered connections near the feedpoint may be damaged.

**Additional EUT Data**

Manufactured by	SPEAG
Manufactured on	May 16, 2013

**DASY5 Validation Report for Head TSL**

Date: 10.06.2013

Test Laboratory: SPEAG, Zurich, Switzerland

**DUT: Dipole 1750 MHz; Type: D1750V2; Serial: D1750V2 - SN: 1097**

Communication System: UID 0 - CW ; Frequency: 1750 MHz

Medium parameters used:  $f = 1750$  MHz;  $\sigma = 1.32$  S/m;  $\epsilon_r = 39.1$ ;  $\rho = 1000$  kg/m<sup>3</sup>

Phantom section: Flat Section

Measurement Standard: DASY5 (IEEE/IEC/ANSI C63.19-2007)

DASY52 Configuration:

- Probe: ES3DV3 - SN3205; ConvF(5.18, 5.18, 5.18); Calibrated: 28.12.2012;
- Sensor-Surface: 3mm (Mechanical Surface Detection)
- Electronics: DAE4 Sn601; Calibrated: 25.04.2013
- Phantom: Flat Phantom 5.0 (back); Type: QD000P50AA; Serial: 1002
- DASY52 52.8.7(1137); SEMCAD X 14.6.10(7164)

**Dipole Calibration for Head Tissue/Pin=250 mW, d=10mm/Zoom Scan (7x7x7)/Cube 0:**

Measurement grid: dx=5mm, dy=5mm, dz=5mm

Reference Value = 95.679 V/m; Power Drift = 0.02 dB

Peak SAR (extrapolated) = 16.2 W/kg

**SAR(1 g) = 9.07 W/kg; SAR(10 g) = 4.85 W/kg**

Maximum value of SAR (measured) = 11.4 W/kg



0 dB = 11.4 W/kg = 10.57 dBW/kg





Impedance Measurement Plot for Head TSL

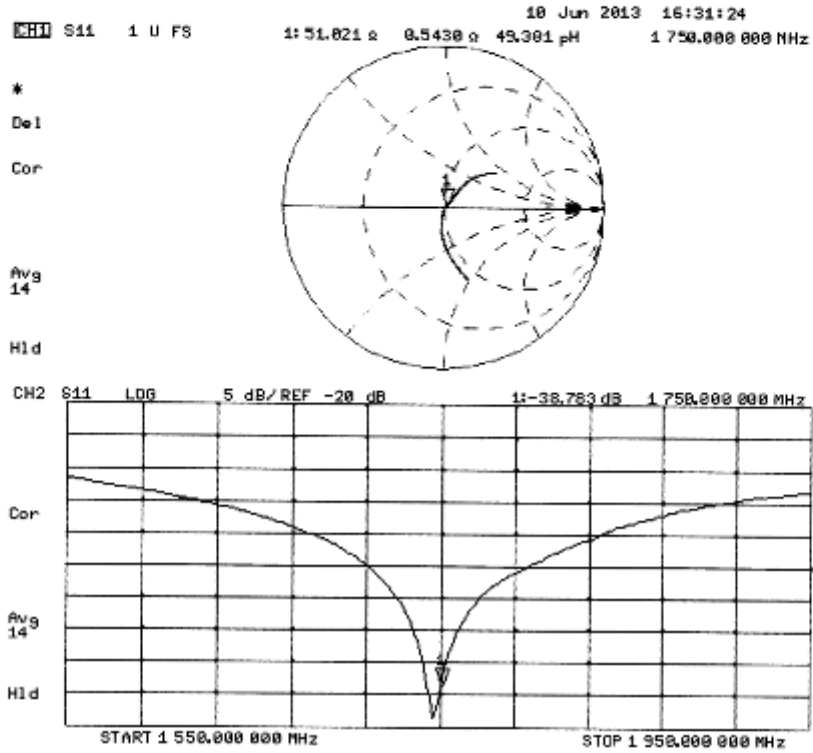

**DASY5 Validation Report for Body TSL**

Date: 11.06.2013

Test Laboratory: SPEAG, Zurich, Switzerland

**DUT: Dipole 1750 MHz; Type: D1750V2; Serial: D1750V2 - SN: 1097**

Communication System: UID 0 - CW ; Frequency: 1750 MHz

Medium parameters used:  $f = 1750$  MHz;  $\sigma = 1.51$  S/m;  $\epsilon_r = 51.7$ ;  $\rho = 1000$  kg/m<sup>3</sup>

Phantom section: Flat Section

Measurement Standard: DASY5 (IEEE/TEC/ANSI C63.19-2007)

**DASY52 Configuration:**

- Probe: ES3DV3 - SN3205; ConvF(4.83, 4.83, 4.83); Calibrated: 28.12.2012;
- Sensor-Surface: 3mm (Mechanical Surface Detection)
- Electronics: DAE4 Sn601; Calibrated: 25.04.2013
- Phantom: Flat Phantom 5.0 (back); Type: QD000P50AA; Serial: 1002
- DASY52 52.8.7(1137); SEMCAD X 14.6.10(7164)

**Dipole Calibration for Body Tissue/Pin=250 mW, d=10mm/Zoom Scan (7x7x7)/Cube 0:**

Measurement grid: dx=5mm, dy=5mm, dz=5mm

Reference Value = 91.830 V/m; Power Drift = 0.08 dB

Peak SAR (extrapolated) = 16.3 W/kg

**SAR(1 g) = 9.46 W/kg; SAR(10 g) = 5.08 W/kg**

Maximum value of SAR (measured) = 11.8 W/kg

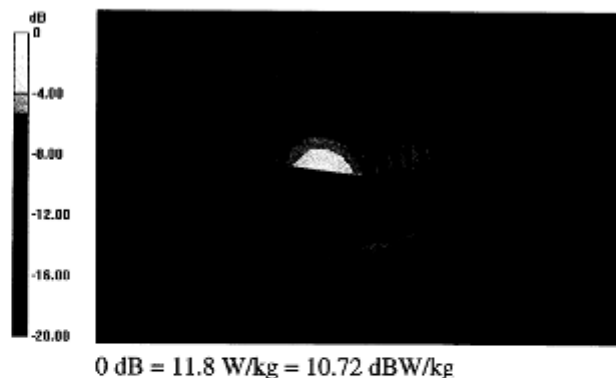





Impedance Measurement Plot for Body TSL

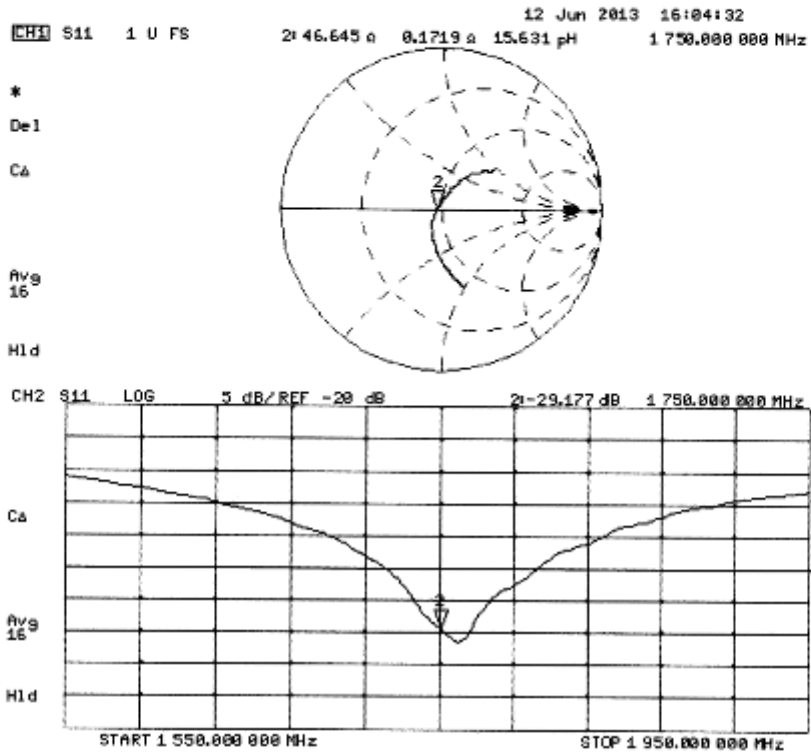



Calibration Laboratory of Schmid & Partner Engineering AG, Zeughausstrasse 43, 8004 Zurich, Switzerland



S Schweizerischer Kalibrierdienst, S Service suisse d'etalonnage, C Servizio svizzero di taratura, S Swiss Calibration Service

Accredited by the Swiss Accreditation Service (SAS), The Swiss Accreditation Service is one of the signatories to the EA Multilateral Agreement for the recognition of calibration certificates

Accreditation No.: SCS 108

Client: CerpPASS (Auden)

Certificate No: D1900V2-5d174\_Jun13

CALIBRATION CERTIFICATE

Object: D1900V2 - SN: 5d174; Calibration procedure(s): QA CAL-05.v9; Calibration date: June 10, 2013. Includes tables for Primary and Secondary Standards, and calibration details.



**Calibration Laboratory of**  
Schmid & Partner  
Engineering AG  
Zeughausstrasse 43, 8004 Zurich, Switzerland



**S** Schweizerischer Kalibrierdienst  
**S** Service suisse d'étalonnage  
**C** Servizio svizzero di taratura  
**S** Swiss Calibration Service

Accredited by the Swiss Accreditation Service (SAS)

Accreditation No.: **SCS 108**

The Swiss Accreditation Service is one of the signatories to the EA  
Multilateral Agreement for the recognition of calibration certificates

#### Glossary:

TSL tissue simulating liquid  
ConvF sensitivity in TSL / NORM x,y,z  
N/A not applicable or not measured

#### Calibration is Performed According to the Following Standards:

- IEEE Std 1528-2003, "IEEE Recommended Practice for Determining the Peak Spatial-Averaged Specific Absorption Rate (SAR) in the Human Head from Wireless Communications Devices: Measurement Techniques", December 2003
- IEC 62209-1, "Procedure to measure the Specific Absorption Rate (SAR) for hand-held devices used in close proximity to the ear (frequency range of 300 MHz to 3 GHz)", February 2005
- Federal Communications Commission Office of Engineering & Technology (FCC OET), "Evaluating Compliance with FCC Guidelines for Human Exposure to Radiofrequency Electromagnetic Fields; Additional Information for Evaluating Compliance of Mobile and Portable Devices with FCC Limits for Human Exposure to Radiofrequency Emissions", Supplement C (Edition 01-01) to Bulletin 65

#### Additional Documentation:

- DASY4/5 System Handbook

#### Methods Applied and Interpretation of Parameters:

- Measurement Conditions:** Further details are available from the Validation Report at the end of the certificate. All figures stated in the certificate are valid at the frequency indicated.
- Antenna Parameters with TSL:** The dipole is mounted with the spacer to position its feed point exactly below the center marking of the flat phantom section, with the arms oriented parallel to the body axis.
- Feed Point Impedance and Return Loss:** These parameters are measured with the dipole positioned under the liquid filled phantom. The impedance stated is transformed from the measurement at the SMA connector to the feed point. The Return Loss ensures low reflected power. No uncertainty required.
- Electrical Delay:** One-way delay between the SMA connector and the antenna feed point. No uncertainty required.
- SAR measured:** SAR measured at the stated antenna input power.
- SAR normalized:** SAR as measured, normalized to an input power of 1 W at the antenna connector.
- SAR for nominal TSL parameters:** The measured TSL parameters are used to calculate the nominal SAR result.

The reported uncertainty of measurement is stated as the standard uncertainty of measurement multiplied by the coverage factor  $k=2$ , which for a normal distribution corresponds to a coverage probability of approximately 95%.

**Measurement Conditions**

DASY system configuration, as far as not given on page 1.

<b>DASY Version</b>	DASY5	V52.8.7
<b>Extrapolation</b>	Advanced Extrapolation	
<b>Phantom</b>	Modular Flat Phantom	
<b>Distance Dipole Center - TSL</b>	10 mm	with Spacer
<b>Zoom Scan Resolution</b>	dx, dy, dz = 5 mm	
<b>Frequency</b>	1900 MHz $\pm$ 1 MHz	

**Head TSL parameters**

The following parameters and calculations were applied.

	Temperature	Permittivity	Conductivity
<b>Nominal Head TSL parameters</b>	22.0 °C	40.0	1.40 mho/m
<b>Measured Head TSL parameters</b>	(22.0 $\pm$ 0.2) °C	39.3 $\pm$ 6 %	1.34 mho/m $\pm$ 6 %
<b>Head TSL temperature change during test</b>	< 0.5 °C	----	----

**SAR result with Head TSL**

SAR averaged over 1 cm <sup>3</sup> (1 g) of Head TSL	Condition	
SAR measured	250 mW input power	9.76 W/kg
SAR for nominal Head TSL parameters	normalized to 1W	<b>39.9 W/kg <math>\pm</math> 17.0 % (k=2)</b>

SAR averaged over 10 cm <sup>3</sup> (10 g) of Head TSL	condition	
SAR measured	250 mW input power	5.15 W/kg
SAR for nominal Head TSL parameters	normalized to 1W	<b>20.9 W/kg <math>\pm</math> 16.5 % (k=2)</b>

**Body TSL parameters**

The following parameters and calculations were applied.

	Temperature	Permittivity	Conductivity
<b>Nominal Body TSL parameters</b>	22.0 °C	53.3	1.52 mho/m
<b>Measured Body TSL parameters</b>	(22.0 $\pm$ 0.2) °C	53.7 $\pm$ 6 %	1.50 mho/m $\pm$ 6 %
<b>Body TSL temperature change during test</b>	< 0.5 °C	----	----

**SAR result with Body TSL**

SAR averaged over 1 cm <sup>3</sup> (1 g) of Body TSL	Condition	
SAR measured	250 mW input power	10.00 W/kg
SAR for nominal Body TSL parameters	normalized to 1W	<b>40.4 W/kg <math>\pm</math> 17.0 % (k=2)</b>

SAR averaged over 10 cm <sup>3</sup> (10 g) of Body TSL	condition	
SAR measured	250 mW input power	5.34 W/kg
SAR for nominal Body TSL parameters	normalized to 1W	<b>21.5 W/kg <math>\pm</math> 16.5 % (k=2)</b>

**Appendix****Antenna Parameters with Head TSL**

Impedance, transformed to feed point	53.2 $\Omega$ + 3.9 $j\Omega$
Return Loss	- 26.2 dB

**Antenna Parameters with Body TSL**

Impedance, transformed to feed point	48.3 $\Omega$ + 5.0 $j\Omega$
Return Loss	- 25.4 dB

**General Antenna Parameters and Design**

Electrical Delay (one direction)	1.202 ns
----------------------------------	----------

After long term use with 100W radiated power, only a slight warming of the dipole near the feedpoint can be measured.

The dipole is made of standard semirigid coaxial cable. The center conductor of the feeding line is directly connected to the second arm of the dipole. The antenna is therefore short-circuited for DC-signals. On some of the dipoles, small end caps are added to the dipole arms in order to improve matching when loaded according to the position as explained in the "Measurement Conditions" paragraph. The SAR data are not affected by this change. The overall dipole length is still according to the Standard.

No excessive force must be applied to the dipole arms, because they might bend or the soldered connections near the feedpoint may be damaged.

**Additional EUT Data**

Manufactured by	SPEAG
Manufactured on	June 08, 2012



**DASY5 Validation Report for Head TSL**

Date: 10.06.2013

Test Laboratory: SPEAG, Zurich, Switzerland

**DUT: Dipole 1900 MHz; Type: D1900V2; Serial: D1900V2 - SN: 5d174**

Communication System: UID 0 - CW ; Frequency: 1900 MHz

Medium parameters used:  $f = 1900$  MHz;  $\sigma = 1.34$  S/m;  $\epsilon_r = 39.3$ ;  $\rho = 1000$  kg/m<sup>3</sup>

Phantom section: Flat Section

Measurement Standard: DASY5 (IEEE/IEC/ANSI C63.19-2007)

DASY52 Configuration:

- Probe: ES3DV3 - SN3205; ConvF(4.98, 4.98, 4.98); Calibrated: 28.12.2012;
- Sensor-Surface: 3mm (Mechanical Surface Detection)
- Electronics: DAE4 Sn601; Calibrated: 25.04.2013
- Phantom: Flat Phantom 5.0 (front); Type: QD000P50AA; Serial: 1001
- DASY52 52.8.7(1137); SEMCAD X 14.6.10(7164)

**Dipole Calibration for Head Tissue/Pin=250 mW, d=10mm/Zoom Scan (7x7x7)/Cube 0:**

Measurement grid: dx=5mm, dy=5mm, dz=5mm

Reference Value = 95.712 V/m; Power Drift = 0.06 dB

Peak SAR (extrapolated) = 17.6 W/kg

**SAR(1 g) = 9.76 W/kg; SAR(10 g) = 5.15 W/kg**

Maximum value of SAR (measured) = 12.0 W/kg



0 dB = 12.0 W/kg = 10.79 dBW/kg

**DASY5 Validation Report for Body TSL**

Date: 10.06.2013

Test Laboratory: SPEAG, Zurich, Switzerland

**DUT: Dipole 1900 MHz; Type: D1900V2; Serial: D1900V2 - SN: 5d174**

Communication System: UID 0 - CW ; Frequency: 1900 MHz

Medium parameters used:  $f = 1900$  MHz;  $\sigma = 1.5$  S/m;  $\epsilon_r = 53.7$ ;  $\rho = 1000$  kg/m<sup>3</sup>

Phantom section: Flat Section

Measurement Standard: DASY5 (IEEE/IEC/ANSI C63.19-2007)

DASY52 Configuration:

- Probe: ES3DV3 - SN3205; ConvF(4.6, 4.6, 4.6); Calibrated: 28.12.2012;
- Sensor-Surface: 3mm (Mechanical Surface Detection)
- Electronics: DAE4 Sn601; Calibrated: 25.04.2013
- Phantom: Flat Phantom 5.0 (back); Type: QD000P50AA; Serial: 1002
- DASY52 52.8.7(1137); SEMCAD X 14.6.10(7164)

**Dipole Calibration for Body Tissue/Pin=250 mW, d=10mm/Zoom Scan (7x7x7)/Cube 0:**Measurement grid:  $dx=5$ mm,  $dy=5$ mm,  $dz=5$ mm

Reference Value = 95.712 V/m; Power Drift = 0.01 dB

Peak SAR (extrapolated) = 17.1 W/kg

**SAR(1 g) = 10 W/kg; SAR(10 g) = 5.34 W/kg**

Maximum value of SAR (measured) = 12.7 W/kg



0 dB = 12.7 W/kg = 11.04 dBW/kg





### Impedance Measurement Plot for Body TSL

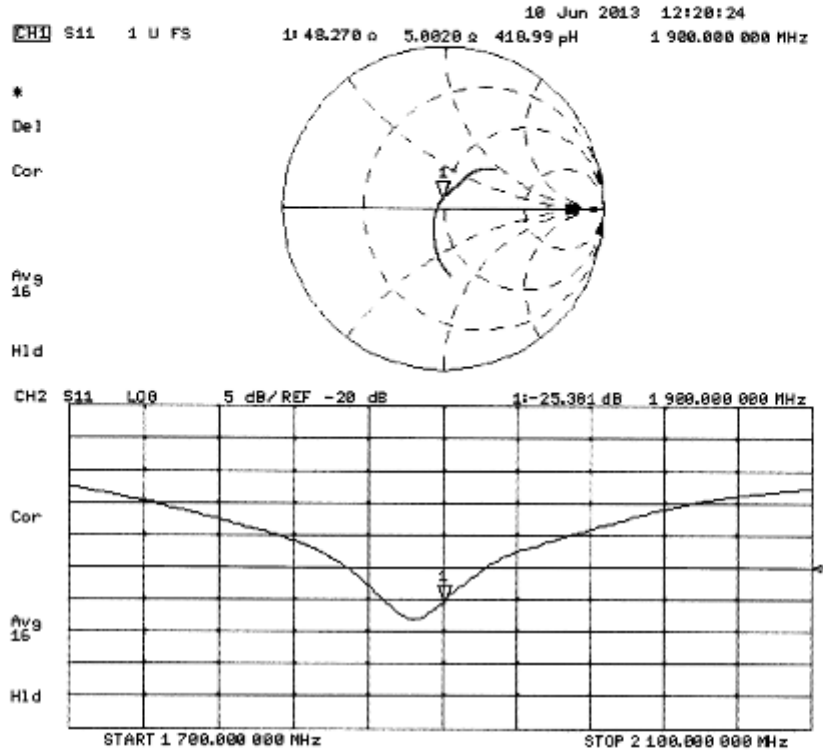



Calibration Laboratory of Schmid & Partner Engineering AG



S Schweizerischer Kalibrierdienst
S Service suisse d'etalonnage
C Servizio svizzero di taratura
S Swiss Calibration Service

Accredited by the Swiss Accreditation Service (SAS)
The Swiss Accreditation Service is one of the signatories to the EA Multilateral Agreement for the recognition of calibration certificates

Accreditation No.: SCS 108

Client CerpPASS (Auden)

Certificate No: D2450V2-914\_Jun13

CALIBRATION CERTIFICATE

Object: D2450V2 - SN: 914
Calibration procedure(s): QA CAL-05.v9
Calibration procedure for dipole validation kits above 700 MHz
Calibration date: June 07, 2013

This calibration certificate documents the traceability to national standards, which realize the physical units of measurements (SI). The measurements and the uncertainties with confidence probability are given on the following pages and are part of the certificate.

All calibrations have been conducted in the closed laboratory facility: environment temperature (22 ± 3)°C and humidity < 70%.

Calibration Equipment used (M&TE critical for calibration)

Table with 4 columns: Primary Standards, ID #, Cal Date (Certificate No.), Scheduled Calibration. Includes items like Power meter EPM-442A, Power sensor HP 8481A, Reference 20 dB Attenuator, etc.

Calibrated by: Leif Klysner, Laboratory Technician
Approved by: Katja Pokovic, Technical Manager

Issued: June 7, 2013

This calibration certificate shall not be reproduced except in full without written approval of the laboratory.



**Calibration Laboratory of  
Schmid & Partner  
Engineering AG**  
Zeughausstrasse 43, 8004 Zurich, Switzerland



**S** Schweizerischer Kalibrierdienst  
**S** Service suisse d'étalonnage  
**C** Servizio svizzero di taratura  
**S** Swiss Calibration Service

Accredited by the Swiss Accreditation Service (SAS)

Accreditation No.: **SCS 108**

The Swiss Accreditation Service is one of the signatories to the EA Multilateral Agreement for the recognition of calibration certificates

#### Glossary:

TSL tissue simulating liquid  
ConvF sensitivity in TSL / NORM x,y,z  
N/A not applicable or not measured

#### Calibration is Performed According to the Following Standards:

- IEEE Std 1528-2003, "IEEE Recommended Practice for Determining the Peak Spatial-Averaged Specific Absorption Rate (SAR) in the Human Head from Wireless Communications Devices: Measurement Techniques", December 2003
- IEC 62209-1, "Procedure to measure the Specific Absorption Rate (SAR) for hand-held devices used in close proximity to the ear (frequency range of 300 MHz to 3 GHz)", February 2005
- Federal Communications Commission Office of Engineering & Technology (FCC OET), "Evaluating Compliance with FCC Guidelines for Human Exposure to Radiofrequency Electromagnetic Fields; Additional Information for Evaluating Compliance of Mobile and Portable Devices with FCC Limits for Human Exposure to Radiofrequency Emissions", Supplement C (Edition 01-01) to Bulletin 65

#### Additional Documentation:

- DASY4/5 System Handbook

#### Methods Applied and Interpretation of Parameters:

- Measurement Conditions:** Further details are available from the Validation Report at the end of the certificate. All figures stated in the certificate are valid at the frequency indicated.
- Antenna Parameters with TSL:** The dipole is mounted with the spacer to position its feed point exactly below the center marking of the flat phantom section, with the arms oriented parallel to the body axis.
- Feed Point Impedance and Return Loss:** These parameters are measured with the dipole positioned under the liquid filled phantom. The impedance stated is transformed from the measurement at the SMA connector to the feed point. The Return Loss ensures low reflected power. No uncertainty required.
- Electrical Delay:** One-way delay between the SMA connector and the antenna feed point. No uncertainty required.
- SAR measured:** SAR measured at the stated antenna input power.
- SAR normalized:** SAR as measured, normalized to an input power of 1 W at the antenna connector.
- SAR for nominal TSL parameters:** The measured TSL parameters are used to calculate the nominal SAR result.

The reported uncertainty of measurement is stated as the standard uncertainty of measurement multiplied by the coverage factor  $k=2$ , which for a normal distribution corresponds to a coverage probability of approximately 95%.

**Measurement Conditions**

DASY system configuration, as far as not given on page 1.

<b>DASY Version</b>	DASY5	V52.8.7
<b>Extrapolation</b>	Advanced Extrapolation	
<b>Phantom</b>	Modular Flat Phantom	
<b>Distance Dipole Center - TSL</b>	10 mm	with Spacer
<b>Zoom Scan Resolution</b>	dx, dy, dz = 5 mm	
<b>Frequency</b>	2450 MHz $\pm$ 1 MHz	

**Head TSL parameters**

The following parameters and calculations were applied.

	Temperature	Permittivity	Conductivity
<b>Nominal Head TSL parameters</b>	22.0 °C	39.2	1.80 mho/m
<b>Measured Head TSL parameters</b>	(22.0 $\pm$ 0.2) °C	37.8 $\pm$ 6 %	1.81 mho/m $\pm$ 6 %
<b>Head TSL temperature change during test</b>	< 0.5 °C	----	----

**SAR result with Head TSL**

<b>SAR averaged over 1 cm<sup>3</sup> (1 g) of Head TSL</b>	Condition	
SAR measured	250 mW input power	13.5 W/kg
SAR for nominal Head TSL parameters	normalized to 1W	<b>53.4 W/kg <math>\pm</math> 17.0 % (k=2)</b>

<b>SAR averaged over 10 cm<sup>3</sup> (10 g) of Head TSL</b>	condition	
SAR measured	250 mW input power	6.24 W/kg
SAR for nominal Head TSL parameters	normalized to 1W	<b>24.8 W/kg <math>\pm</math> 16.5 % (k=2)</b>

**Body TSL parameters**

The following parameters and calculations were applied.

	Temperature	Permittivity	Conductivity
<b>Nominal Body TSL parameters</b>	22.0 °C	52.7	1.95 mho/m
<b>Measured Body TSL parameters</b>	(22.0 $\pm$ 0.2) °C	50.9 $\pm$ 6 %	2.02 mho/m $\pm$ 6 %
<b>Body TSL temperature change during test</b>	< 0.5 °C	----	----

**SAR result with Body TSL**

<b>SAR averaged over 1 cm<sup>3</sup> (1 g) of Body TSL</b>	Condition	
SAR measured	250 mW input power	13.2 W/kg
SAR for nominal Body TSL parameters	normalized to 1W	<b>51.5 W/kg <math>\pm</math> 17.0 % (k=2)</b>

<b>SAR averaged over 10 cm<sup>3</sup> (10 g) of Body TSL</b>	condition	
SAR measured	250 mW input power	6.07 W/kg
SAR for nominal Body TSL parameters	normalized to 1W	<b>23.9 W/kg <math>\pm</math> 16.5 % (k=2)</b>

**Appendix****Antenna Parameters with Head TSL**

Impedance, transformed to feed point	57.0 $\Omega$ + 1.9 j $\Omega$
Return Loss	- 23.3 dB

**Antenna Parameters with Body TSL**

Impedance, transformed to feed point	52.1 $\Omega$ + 3.5 j $\Omega$
Return Loss	- 28.0 dB

**General Antenna Parameters and Design**

Electrical Delay (one direction)	1.160 ns
----------------------------------	----------

After long term use with 100W radiated power, only a slight warming of the dipole near the feedpoint can be measured.

The dipole is made of standard semirigid coaxial cable. The center conductor of the feeding line is directly connected to the second arm of the dipole. The antenna is therefore short-circuited for DC-signals. On some of the dipoles, small end caps are added to the dipole arms in order to improve matching when loaded according to the position as explained in the "Measurement Conditions" paragraph. The SAR data are not affected by this change. The overall dipole length is still according to the Standard.

No excessive force must be applied to the dipole arms, because they might bend or the soldered connections near the feedpoint may be damaged.

**Additional EUT Data**

Manufactured by	SPEAG
Manufactured on	December 19, 2012



**DASY5 Validation Report for Head TSL**

Date: 07.06.2013

Test Laboratory: SPEAG, Zurich, Switzerland

**DUT: Dipole 2450 MHz; Type: D2450V2; Serial: D2450V2 - SN: 914**

Communication System: UID 0 - CW ; Frequency: 2450 MHz

Medium parameters used:  $f = 2450$  MHz;  $\sigma = 1.81$  S/m;  $\epsilon_r = 37.8$ ;  $\rho = 1000$  kg/m<sup>3</sup>

Phantom section: Flat Section

Measurement Standard: DASY5 (IEEE/IEC/ANSI C63.19-2007)

DASY52 Configuration:

- Probe: ES3DV3 - SN3205; ConvF(4.52, 4.52, 4.52); Calibrated: 28.12.2012;
- Sensor-Surface: 3mm (Mechanical Surface Detection)
- Electronics: DAE4 Sn601; Calibrated: 25.04.2013
- Phantom: Flat Phantom 5.0 (front); Type: QD000P50AA; Serial: 1001
- DASY52 52.8.7(1137); SEMCAD X 14.6.10(7164)

**Dipole Calibration for Head Tissue/Pin=250 mW, d=10mm/Zoom Scan (7x7x7)/Cube 0:**

Measurement grid: dx=5mm, dy=5mm, dz=5mm

Reference Value = 95.695 V/m; Power Drift = 0.05 dB

Peak SAR (extrapolated) = 28.3 W/kg

**SAR(1 g) = 13.5 W/kg; SAR(10 g) = 6.24 W/kg**

Maximum value of SAR (measured) = 17.6 W/kg

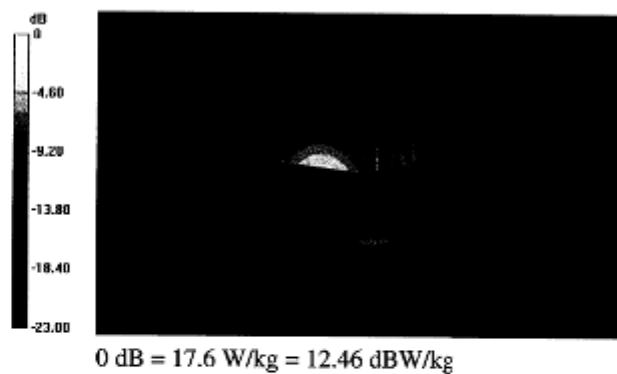



### Impedance Measurement Plot for Head TSL

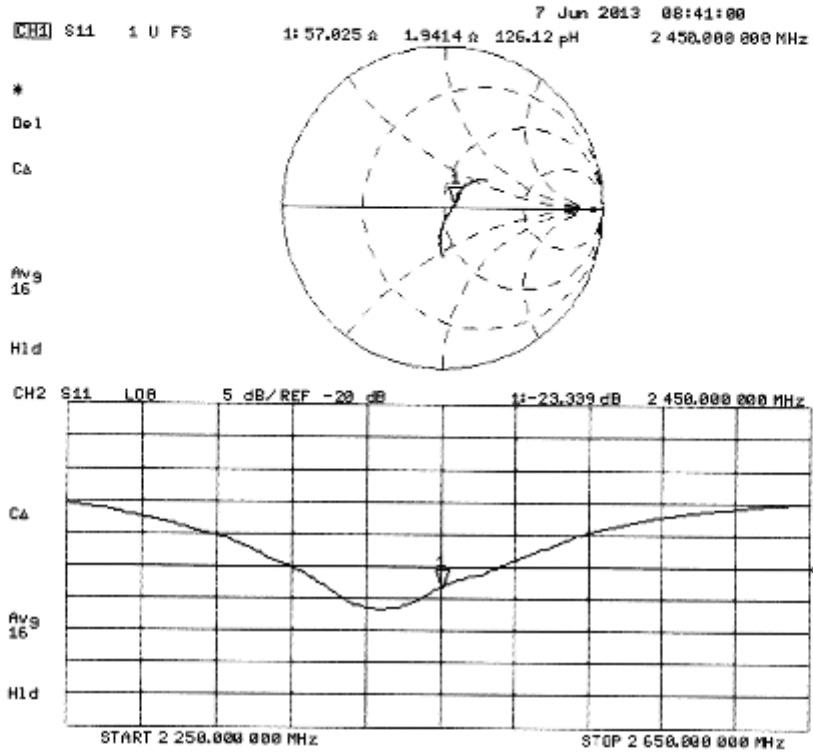



**DASY5 Validation Report for Body TSL**

Date: 07.06.2013

Test Laboratory: SPEAG, Zurich, Switzerland

**DUT: Dipole 2450 MHz; Type: D2450V2; Serial: D2450V2 - SN: 914**

Communication System: UID 0 - CW ; Frequency: 2450 MHz

Medium parameters used:  $f = 2450$  MHz;  $\sigma = 2.02$  S/m;  $\epsilon_r = 50.9$ ;  $\rho = 1000$  kg/m<sup>3</sup>

Phantom section: Flat Section

Measurement Standard: DASY5 (IEEE/IEC/ANSI C63.19-2007)

DASY52 Configuration:

- Probe: ES3DV3 - SN3205; ConvF(4.42, 4.42, 4.42); Calibrated: 28.12.2012;
- Sensor-Surface: 3mm (Mechanical Surface Detection)
- Electronics: DAE4 Sn601; Calibrated: 25.04.2013
- Phantom: Flat Phantom 5.0 (back); Type: QD000P50AA; Serial: 1002
- DASY52 52.8.7(1137); SEMCAD X 14.6.10(7164)

**Dipole Calibration for Body Tissue/Pin=250 mW, d=10mm/Zoom Scan (7x7x7)/Cube 0:**

Measurement grid: dx=5mm, dy=5mm, dz=5mm

Reference Value = 95.695 V/m; Power Drift = 0.01 dB

Peak SAR (extrapolated) = 27.6 W/kg

**SAR(1 g) = 13.2 W/kg; SAR(10 g) = 6.07 W/kg**

Maximum value of SAR (measured) = 17.5 W/kg

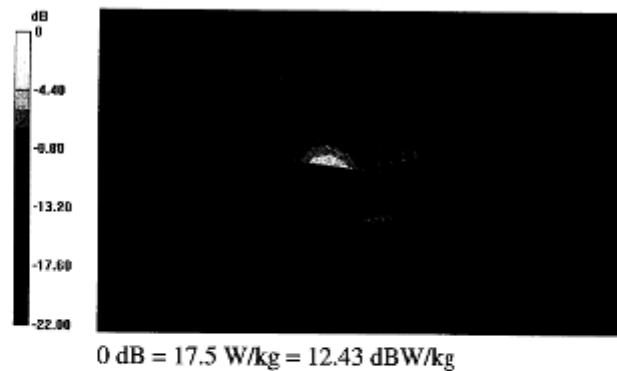



### Impedance Measurement Plot for Body TSL

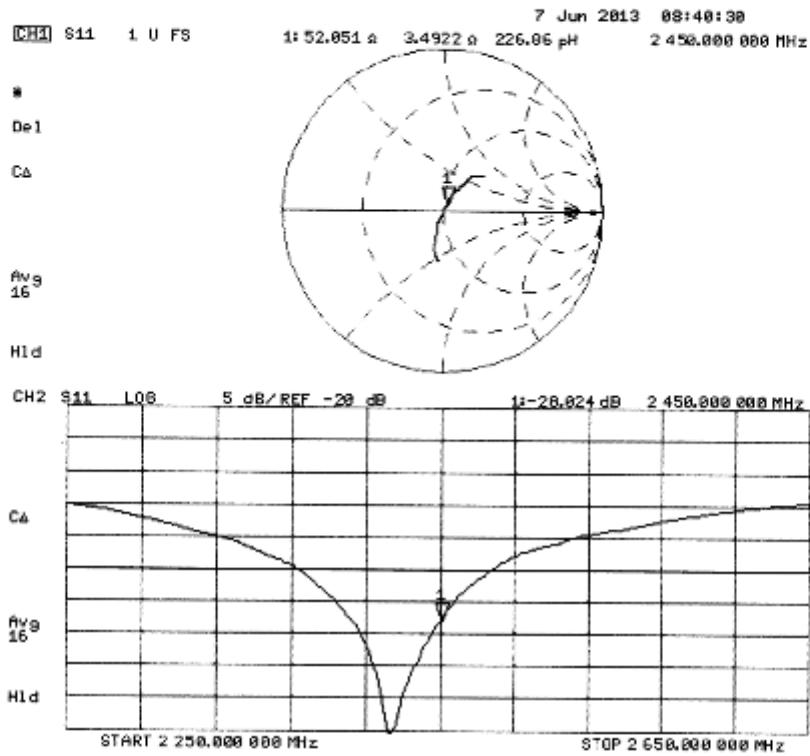



# 11. Appendix F. DAE Calibration Data

**Calibration Laboratory of  
Schmid & Partner  
Engineering AG**  
Zeughausstrasse 43, 8004 Zurich, Switzerland



**S** Schweizerischer Kalibrierdienst  
**C** Service suisse d'étalonnage  
**S** Servizio svizzero di taratura  
**S** Swiss Calibration Service

Accredited by the Swiss Accreditation Service (SAS)  
The Swiss Accreditation Service is one of the signatories to the EA  
Multilateral Agreement for the recognition of calibration certificates

Accreditation No.: **SCS 108**

Client **CerpPASS (Auden)**

Certificate No: **DAE4-1379\_May14**

CALIBRATION CERTIFICATE																							
Object	DAE4 - SD 000 D04 BJ - SN: 1379																						
Calibration procedure(s)	QA CAL-06.v26 Calibration procedure for the data acquisition electronics (DAE)																						
Calibration date:	May 19, 2014																						
<p>This calibration certificate documents the traceability to national standards, which realize the physical units of measurements (SI). The measurements and the uncertainties with confidence probability are given on the following pages and are part of the certificate.</p> <p>All calibrations have been conducted in the closed laboratory facility: environment temperature (22 ± 3)°C and humidity &lt; 70%.</p> <p>Calibration Equipment used (M&amp;TE critical for calibration)</p> <table border="1"> <thead> <tr> <th>Primary Standards</th> <th>ID #</th> <th>Cal Date (Certificate No.)</th> <th>Scheduled Calibration</th> </tr> </thead> <tbody> <tr> <td>Keithley Multimeter Type 2001</td> <td>SN: 0610278</td> <td>01-Oct-13 (No:13975)</td> <td>Oct-14</td> </tr> <tr> <th>Secondary Standards</th> <th>ID #</th> <th>Check Date (in house)</th> <th>Scheduled Check</th> </tr> <tr> <td>Auto DAE Calibration Unit</td> <td>SE UWS 053 AA 1001</td> <td>07-Jan-14 (in house check)</td> <td>In house check: Jan-15</td> </tr> <tr> <td>Calibrator Box V2.1</td> <td>SE UMS 006 AA 1002</td> <td>07-Jan-14 (in house check)</td> <td>In house check: Jan-15</td> </tr> </tbody> </table>				Primary Standards	ID #	Cal Date (Certificate No.)	Scheduled Calibration	Keithley Multimeter Type 2001	SN: 0610278	01-Oct-13 (No:13975)	Oct-14	Secondary Standards	ID #	Check Date (in house)	Scheduled Check	Auto DAE Calibration Unit	SE UWS 053 AA 1001	07-Jan-14 (in house check)	In house check: Jan-15	Calibrator Box V2.1	SE UMS 006 AA 1002	07-Jan-14 (in house check)	In house check: Jan-15
Primary Standards	ID #	Cal Date (Certificate No.)	Scheduled Calibration																				
Keithley Multimeter Type 2001	SN: 0610278	01-Oct-13 (No:13975)	Oct-14																				
Secondary Standards	ID #	Check Date (in house)	Scheduled Check																				
Auto DAE Calibration Unit	SE UWS 053 AA 1001	07-Jan-14 (in house check)	In house check: Jan-15																				
Calibrator Box V2.1	SE UMS 006 AA 1002	07-Jan-14 (in house check)	In house check: Jan-15																				
Calibrated by:	Name Dominique Steffen	Function Technician	Signature 																				
Approved by:	Fin Bomholt	Deputy Technical Manager																					
This calibration certificate shall not be reproduced except in full without written approval of the laboratory.			Issued: May 19, 2014																				



**Calibration Laboratory of  
Schmid & Partner  
Engineering AG**  
Zeughausstrasse 43, 8004 Zurich, Switzerland



**S** Schweizerischer Kalibrierdienst  
**C** Service suisse d'étalonnage  
**S** Servizio svizzero di taratura  
**S** Swiss Calibration Service

Accredited by the Swiss Accreditation Service (SAS)  
The Swiss Accreditation Service is one of the signatories to the EA  
Multilateral Agreement for the recognition of calibration certificates

Accreditation No.: **SCS 108**

### Glossary

DAE data acquisition electronics  
Connector angle information used in DASY system to align probe sensor X to the robot coordinate system.

### Methods Applied and Interpretation of Parameters

- *DC Voltage Measurement:* Calibration Factor assessed for use in DASY system by comparison with a calibrated instrument traceable to national standards. The figure given corresponds to the full scale range of the voltmeter in the respective range.
- *Connector angle:* The angle of the connector is assessed measuring the angle mechanically by a tool inserted. Uncertainty is not required.
- The following parameters as documented in the Appendix contain technical information as a result from the performance test and require no uncertainty.
  - *DC Voltage Measurement Linearity:* Verification of the Linearity at +10% and -10% of the nominal calibration voltage. Influence of offset voltage is included in this measurement.
  - *Common mode sensitivity:* Influence of a positive or negative common mode voltage on the differential measurement.
  - *Channel separation:* Influence of a voltage on the neighbor channels not subject to an input voltage.
  - *AD Converter Values with inputs shorted:* Values on the internal AD converter corresponding to zero input voltage
  - *Input Offset Measurement:* Output voltage and statistical results over a large number of zero voltage measurements.
  - *Input Offset Current:* Typical value for information; Maximum channel input offset current, not considering the input resistance.
  - *Input resistance:* Typical value for information: DAE input resistance at the connector, during internal auto-zeroing and during measurement.
  - *Low Battery Alarm Voltage:* Typical value for information. Below this voltage, a battery alarm signal is generated.
  - *Power consumption:* Typical value for information. Supply currents in various operating modes.



**DC Voltage Measurement**

A/D - Converter Resolution nominal

High Range: 1LSB = 6.1 $\mu$ V , full range = -100...+300 mV

Low Range: 1LSB = 61nV , full range = -1.....+3mV

DASY measurement parameters: Auto Zero Time: 3 sec; Measuring time: 3 sec

Calibration Factors	X	Y	Z
High Range	403.805 $\pm$ 0.02% (k=2)	404.075 $\pm$ 0.02% (k=2)	404.011 $\pm$ 0.02% (k=2)
Low Range	3.99838 $\pm$ 1.50% (k=2)	3.99504 $\pm$ 1.50% (k=2)	4.00152 $\pm$ 1.50% (k=2)

**Connector Angle**

Connector Angle to be used in DASY system	149.5 $^{\circ}$ $\pm$ 1 $^{\circ}$
---	-------------------------------------





## Appendix

## 1. DC Voltage Linearity

High Range	Reading ( $\mu\text{V}$ )	Difference ( $\mu\text{V}$ )	Error (%)
Channel X + Input	199994.29	-1.98	-0.00
Channel X + Input	19999.30	-1.30	-0.01
Channel X - Input	-19998.41	2.90	-0.01
Channel Y + Input	199996.73	0.29	0.00
Channel Y + Input	19996.72	-3.84	-0.02
Channel Y - Input	-20001.24	-0.12	0.00
Channel Z + Input	199995.04	-1.34	-0.00
Channel Z + Input	19998.92	-1.47	-0.01
Channel Z - Input	-20002.08	-0.85	0.00

Low Range	Reading ( $\mu\text{V}$ )	Difference ( $\mu\text{V}$ )	Error (%)
Channel X + Input	2001.97	1.11	0.06
Channel X + Input	201.61	0.19	0.10
Channel X - Input	-198.88	-0.22	0.11
Channel Y + Input	2001.25	0.31	0.02
Channel Y + Input	201.42	0.07	0.03
Channel Y - Input	-199.14	-0.59	0.30
Channel Z + Input	2001.40	0.60	0.03
Channel Z + Input	199.50	-1.64	-0.82
Channel Z - Input	-199.24	-0.49	0.25

## 2. Common mode sensitivity

DASY measurement parameters: Auto Zero Time: 3 sec; Measuring time: 3 sec

	Common mode Input Voltage (mV)	High Range Average Reading ( $\mu\text{V}$ )	Low Range Average Reading ( $\mu\text{V}$ )
Channel X	200	-17.61	-19.05
	-200	20.93	18.82
Channel Y	200	-4.43	-4.39
	-200	4.21	4.00
Channel Z	200	-10.49	-10.31
	-200	8.62	8.36

## 3. Channel separation

DASY measurement parameters: Auto Zero Time: 3 sec; Measuring time: 3 sec

	Input Voltage (mV)	Channel X ( $\mu\text{V}$ )	Channel Y ( $\mu\text{V}$ )	Channel Z ( $\mu\text{V}$ )
Channel X	200	-	-0.60	-5.10
Channel Y	200	8.15	-	0.34
Channel Z	200	10.42	5.32	-

**4. AD-Converter Values with inputs shorted**

DASY measurement parameters: Auto Zero Time: 3 sec; Measuring time: 3 sec

	High Range (LSB)	Low Range (LSB)
Channel X	16034	13894
Channel Y	16256	12489
Channel Z	15825	15529

**5. Input Offset Measurement**

DASY measurement parameters: Auto Zero Time: 3 sec; Measuring time: 3 sec

Input 10M $\Omega$ 

	Average ( $\mu$ V)	min. Offset ( $\mu$ V)	max. Offset ( $\mu$ V)	Std. Deviation ( $\mu$ V)
Channel X	-1.79	-3.29	-0.79	0.47
Channel Y	-0.21	-2.44	1.81	0.71
Channel Z	-0.03	-1.33	2.40	0.79

**6. Input Offset Current**

Nominal Input circuitry offset current on all channels: &lt;25fA

**7. Input Resistance** (Typical values for information)

	Zeroing (kOhm)	Measuring (MOhm)
Channel X	200	200
Channel Y	200	200
Channel Z	200	200

**8. Low Battery Alarm Voltage** (Typical values for information)

Typical values	Alarm Level (VDC)
Supply (+ Vcc)	+7.9
Supply (- Vcc)	-7.6

**9. Power Consumption** (Typical values for information)

Typical values	Switched off (mA)	Stand by (mA)	Transmitting (mA)
Supply (+ Vcc)	+0.01	+6	+14
Supply (- Vcc)	-0.01	-8	-9