

TEST REPORT

Applicant Name: TELEPHONE EST (HK) CO., LTD
Address: Room709,7F, FuLi tianhe commercial building, Linhe East Road and tianhe district, Guangzhou, China
Report Number: 2401S48621-RF-00
FCC ID: 2ACE5-MSPLAYER

Test Standard (s)

FCC PART 15.247

Sample Description

Product Type: MP3 Player
Model No.: UPT-1534
Multiple Model(s) No.: UPT-1532
Trade Mark: UP-TECH
Date Received: 2024/04/17
Issue Date: 2024/05/11

Test Result:

Pass[▲]

▲ In the configuration tested, the EUT complied with the standards above.

Prepared and Checked By:

Jojo Guo

Jojo Guo
RF Engineer

Approved By:

Nancy Wang

Nancy Wang
RF Supervisor

Note: The information marked # is provided by the applicant, the laboratory is not responsible for its authenticity and this information can affect the validity of the result in the test report. Customer model name, addresses, names, trademarks etc. are included.

This report cannot be reproduced except in full, without prior written approval of the Company. Unless otherwise stated the results shown in this test report refer only to the sample(s) tested. This report is valid only with a valid digital signature. The digital signature may be available only under the Adobe software above version 7.0.

This report must not be used by the customer to claim product certification, approval, or endorsement by NVLAP or any agency of the U.S. Government.

This report may contain data that are not covered by the NVLAP accreditation and are marked with an asterisk "▼".

Bay Area Compliance Laboratories Corp. (Shenzhen)

5F(B-West) , 6F, 7F, the 3rd Phase of Wan Li Industrial Building D, Shihua Rd, FuTian Free Trade Zone, Shenzhen, China

Tel: +86-755-33320018 Fax: +86-755-33320008 www.baclcorp.com.cn

TABLE OF CONTENTS

DOCUMENT REVISION HISTORY	4
GENERAL INFORMATION.....	5
PRODUCT DESCRIPTION FOR EQUIPMENT UNDER TEST (EUT).....	5
OBJECTIVE	5
TEST METHODOLOGY	5
MEASUREMENT UNCERTAINTY	6
TEST FACILITY	6
SYSTEM TEST CONFIGURATION.....	7
DESCRIPTION OF TEST CONFIGURATION	7
EUT EXERCISE SOFTWARE	7
SPECIAL ACCESSORIES.....	7
EQUIPMENT MODIFICATIONS	7
SUPPORT EQUIPMENT LIST AND DETAILS	7
EXTERNAL I/O CABLE.....	8
BLOCK DIAGRAM OF TEST SETUP	8
SUMMARY OF TEST RESULTS	10
TEST EQUIPMENT LIST	11
FCC§15.247 (I), §1.1307 (B) (1) & §2.1093 - RF EXPOSURE.....	12
APPLICABLE STANDARD	12
MEASUREMENT RESULT	12
FCC §15.203 - ANTENNA REQUIREMENT.....	13
APPLICABLE STANDARD	13
ANTENNA CONNECTOR CONSTRUCTION	13
FCC §15.207 (A) - AC LINE CONDUCTED EMISSIONS	14
APPLICABLE STANDARD	14
EUT SETUP	14
EMI TEST RECEIVER SETUP.....	14
TEST PROCEDURE	14
FACTOR & OVER LIMIT CALCULATION.....	15
TEST DATA	15
FCC §15.205, §15.209 & §15.247(D) - RADIATED EMISSIONS.....	18
APPLICABLE STANDARD	18
EUT SETUP	18
EMI TEST RECEIVER & SPECTRUM ANALYZER SETUP	19
TEST PROCEDURE	20
FACTOR & OVER LIMIT/MARGIN CALCULATION	20
TEST DATA	20
FCC §15.247(A) (1) - CHANNEL SEPARATION TEST	34
APPLICABLE STANDARD	34
TEST PROCEDURE	34
TEST DATA	34

FCC §15.247(A) (1) - 20 DB EMISSION BANDWIDTH.....35
 APPLICABLE STANDARD35
 TEST PROCEDURE35
 TEST DATA36

FCC §15.247(A) (1) (III) - QUANTITY OF HOPPING CHANNEL TEST.....37
 APPLICABLE STANDARD37
 TEST PROCEDURE37
 TEST DATA37

FCC §15.247(A) (1) (III) - TIME OF OCCUPANCY (DWELL TIME).....38
 APPLICABLE STANDARD38
 TEST PROCEDURE38
 TEST DATA39

FCC §15.247(B) (1) - PEAK OUTPUT POWER MEASUREMENT40
 APPLICABLE STANDARD40
 TEST PROCEDURE40
 TEST DATA40

FCC §15.247(D) § 5.5 - BAND EDGES TESTING.....41
 APPLICABLE STANDARD41
 TEST PROCEDURE41
 TEST DATA42

EUT PHOTOGRAPHS.....43

TEST SETUP PHOTOGRAPHS44

APPENDIX45
 APPENDIX A: 20dB EMISSION BANDWIDTH.....45
 APPENDIX B: OCCUPIED CHANNEL BANDWIDTH51
 APPENDIX C: MAXIMUM CONDUCTED OUTPUT POWER.....57
 APPENDIX D: CARRIER FREQUENCY SEPARATION62
 APPENDIX E: TIME OF OCCUPANCY65
 APPENDIX F: NUMBER OF HOPPING CHANNELS75
 APPENDIX G: BAND EDGE MEASUREMENTS78

DOCUMENT REVISION HISTORY

Revision Number	Report Number	Description of Revision	Date of Revision
0	2401S48621-RF-00	Original Report	2024/05/11

GENERAL INFORMATION

Product Description for Equipment under Test (EUT)

Product	MP3 Player
Tested Model	UPT-1534
Multiple Model(s)	UPT-1532
Frequency Range	Bluetooth: 2402~2480MHz
Transmit Peak Power	8.54dBm
Modulation Technique	Bluetooth: GFSK, $\pi/4$ -DQPSK, 8DPSK
Antenna Specification [#]	-0.58dBi (provided by the applicant)
Voltage Range	DC 3.7V from battery or DC 5V from USB port
Sample serial number	OSEB118935-1 for Conducted and Radiated Emissions Test OSEB118935-2 for RF Conducted Test (Assigned by BAACL, Shenzhen)
Sample/EUT Status	Good condition
Adapter Information	N/A
Note: The models are electrically identical with the test model except for color. Please refer to the declaration letter [#] for more detail, which was provided by manufacturer.	

Objective

This test report is in accordance with Part 2-Subpart J, Part 15-Subparts A and C of the Federal Communication Commission rules.

The tests were performed in order to determine compliance with FCC Part 15, Subpart C, section 15.203, 15.207, 15.205, 15.209 and 15.247 rules.

Test Methodology

All measurements contained in this report were conducted with ANSI C63.10-2013, American National Standard of Procedures for Compliance Testing of Unlicensed Wireless Devices.

All emissions measurement was performed at Bay Area Compliance Laboratories Corp. (Shenzhen). The radiated testing was performed at an antenna-to-EUT distance of 3 meters.

Each test item follows test standards and with no deviation.

Measurement Uncertainty

Parameter		Uncertainty
Occupied Channel Bandwidth		±5%
RF output power, conducted		0.72 dB(k=2, 95% level of confidence)
AC Power Lines Conducted Emissions	9kHz-150kHz	3.94dB(k=2, 95% level of confidence)
	150kHz-30MHz	3.84dB(k=2, 95% level of confidence)
Radiated Emissions	9kHz - 30MHz	3.30dB(k=2, 95% level of confidence)
	30MHz~200MHz (Horizontal)	4.48dB(k=2, 95% level of confidence)
	30MHz~200MHz (Vertical)	4.55dB(k=2, 95% level of confidence)
	200MHz~1000MHz (Horizontal)	4.85dB(k=2, 95% level of confidence)
	200MHz~1000MHz (Vertical)	5.05dB(k=2, 95% level of confidence)
	1GHz - 6GHz	5.35dB(k=2, 95% level of confidence)
	6GHz - 18GHz	5.44dB(k=2, 95% level of confidence)
18GHz - 40GHz	5.16dB(k=2, 95% level of confidence)	
Temperature		±1°C
Humidity		±1%
Supply voltages		±0.4%

Note: The extended uncertainty given in this report is obtained by combining the standard uncertainty times the coverage factor K with the 95% confidence interval. Otherwise required by the applicant or Product Regulations, Decision Rule in this report did not consider the uncertainty.

Test Facility

The Test site used by Bay Area Compliance Laboratories Corp. (Shenzhen) to collect test data is located on the 5F(B-West) , 6F, 7F, the 3rd Phase of Wan Li Industrial Building D, Shihua Rd, FuTian Free Trade Zone, Shenzhen, China.

The lab has been recognized as the FCC accredited lab under the KDB 974614 D01 and is listed in the FCC Public Access Link (PAL) database, FCC Registration No. : 715558, the FCC Designation No. : CN5045.

SYSTEM TEST CONFIGURATION

Description of Test Configuration

The system was configured for testing in an engineering mode.

Channel	Frequency (MHz)	Channel	Frequency (MHz)
0	2402	40	2442
1	2403	41	2443
2	2404	42	2444
...
...
36	2438	75	2477
37	2439	76	2478
38	2440	77	2479
39	2441	78	2480

EUT was tested with Channel 0, 39 and 78.

EUT Exercise Software

“bt-tool-v1.1.0”[#] exercise software was used and the power level is 23[#]. The software and power level was provided by the applicant.

Special Accessories

No special accessory.

Equipment Modifications

No modification was made to the EUT tested.

Support Equipment List and Details

Manufacturer	Description	Model	Serial Number
XED	Adapter	XED-UL050100CU	Unknown
Bull	Receptacle	Unknown	Unknown
HUAWEI	Earphone	Unknown	Unknown

External I/O Cable

Cable Description	Length (m)	From Port	To
Un-shielded Detachable DC Cable	1.0	EUT	Adapter
Un-shielded Detachable AC Cable	1.5	Receptacle	LISN/AC Mains
Un-shielded Detachable DC Cable	1.0	EUT	Earphone

Block Diagram of Test Setup

For Conducted Emissions:

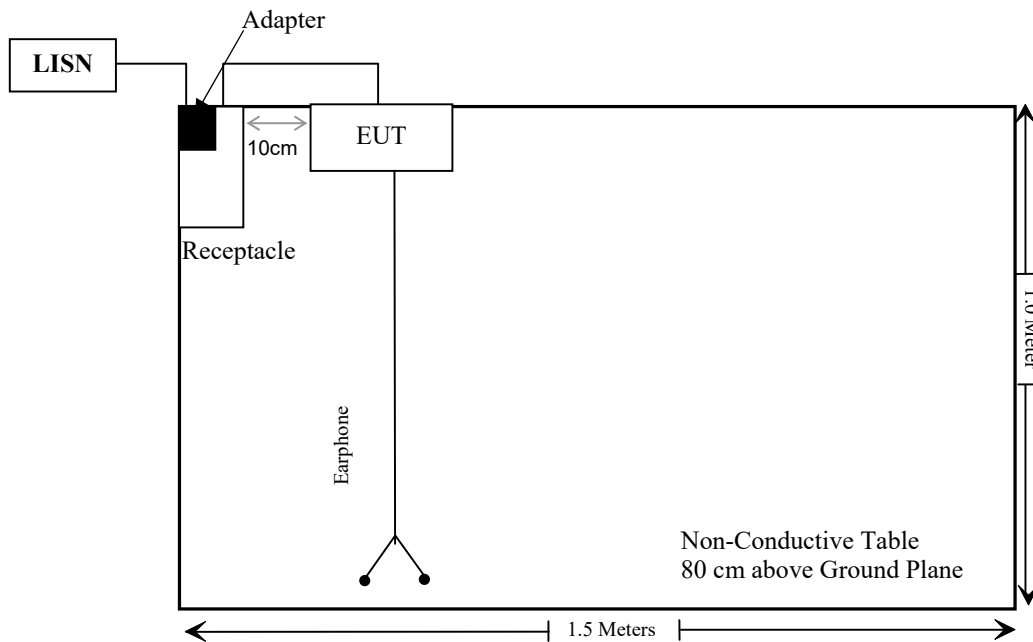

For Radiated Emissions below 1GHz:

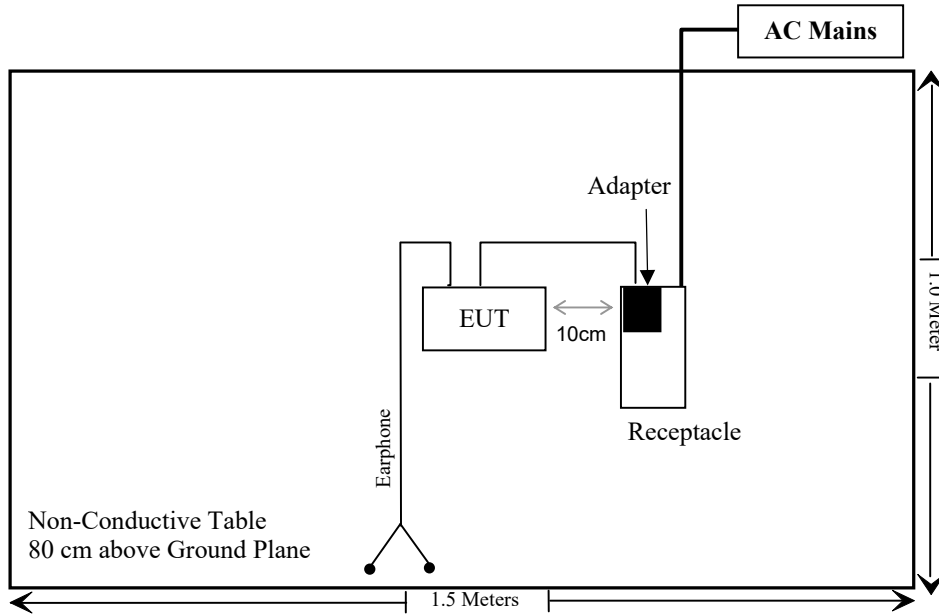

For Radiated Emissions above 1GHz:

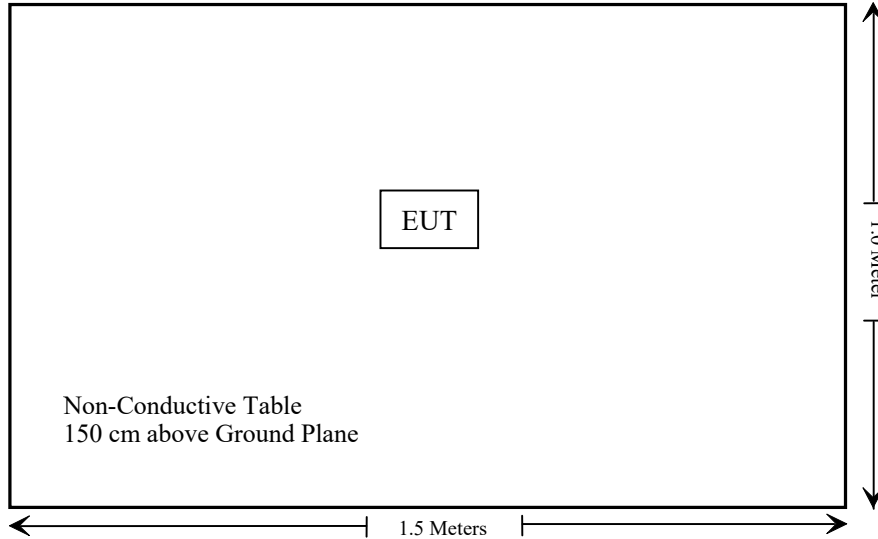

SUMMARY OF TEST RESULTS

Rules	Description of Test	Result
FCC 15.247 (i), §1.1307 (b) (1) & §2.1093	RF Exposure	Compliant
FCC §15.203	Antenna Requirement	Compliant
FCC §15.207(a)	AC Line Conducted Emissions	Compliant
FCC §15.205, §15.209, §15.247(d)	Radiated Emissions	Compliant
FCC §15.247(a)(1)	20 dB Emission Bandwidth & 99% Occupied Bandwidth	Compliant
FCC §15.247(a)(1)	Channel Separation Test	Compliant
FCC §15.247(a)(1)(iii)	Time of Occupancy (Dwell Time)	Compliant
FCC §15.247(a)(1)(iii)	Quantity of hopping channel Test	Compliant
FCC §15.247(b)(1)	Peak Output Power Measurement	Compliant
FCC §15.247(d)	Band edges	Compliant

TEST EQUIPMENT LIST

Manufacturer	Description	Model	Serial Number	Calibration Date	Calibration Due Date
Conducted Emission Test					
Rohde & Schwarz	EMI Test Receiver	ESCI	101120	2024/01/16	2025/01/15
Rohde & Schwarz	LISN	ENV216	101613	2024/01/16	2025/01/15
Rohde & Schwarz	Transient Limiter	ESH3Z2	DE25985	2023/08/03	2024/08/02
Unknown	CE Cable	CE Cable	UF A210B-1-0720-504504	2023/08/03	2024/08/02
Audix	EMI Test software	E3	191218	NCR	NCR
Radiated Emission Test below 1 GHz					
R&S	EMI Test Receiver	ESR3	102455	2024/01/16	2025/01/15
Sonoma instrument	Pre-amplifier	310 N	186238	2023/06/08	2024/06/07
Sunol Sciences	Broadband Antenna	JB1	A040904-1	2023/07/20	2024/07/19
BACL	Active Loop Antenna	1313-1A	4031911	2024/03/21	2025/03/20
Unknown	Cable	Chamber Cable 1	F-03-EM236	2023/08/03	2024/08/02
Unknown	Cable	Chamber Cable 4	EC-007	2023/08/03	2024/08/02
Audix	EMI Test software	E3	19821b(V9)	NCR	NCR
Radiated Emission Test above 1 GHz					
Rohde & Schwarz	Spectrum Analyzer	FSV40	101605	2024/03/27	2025/03/26
COM-POWER	Pre-amplifier	PA-122	181919	2023/06/29	2024/06/28
Schwarzbeck	Horn Antenna	BBHA9120D(1201)	1143	2023/07/26	2024/07/25
Unknown	RF Cable	KMSE	0735	2023/10/08	2024/10/07
Unknown	RF Cable	UFA147	219661	2023/10/08	2024/10/07
Unknown	RF Cable	XH750A-N	J-10M	2023/10/08	2024/10/07
SNSD	2.4G Band Reject filter	BSF2402-2480MN-0898-001	2.4G filter	2023/08/03	2024/08/02
A.H.System	Pre-amplifier	PAM-1840VH	190	2023/08/03	2024/08/02
Electro-Mechanics Co	Horn Antenna	3116	9510-2270	2023/09/18	2026/09/17
Audix	EMI Test software	E3	191218(V9)	NCR	NCR
RF Conducted Test					
R&S	Spectrum Analyzer	FSU26	200120	2024/01/08	2025/01/07
Tonscend	RF control Unit	JS0806-2	19D8060154	2023/09/06	2024/09/05
Rohde & Schwarz	Signal and Spectrum Analyzer	FSV40	101473	2024/01/16	2025/01/15
MARCONI	10dB Attenuator	6534/3	2942	2023/07/04	2024/07/03
Unknown	RF Cable	65475	01670515	2023/07/04	2024/07/03

*** Statement of Traceability:** Bay Area Compliance Laboratories Corp. (Shenzhen) attests that all calibrations have been performed in accordance to requirements that traceable to National Primary Standards and International System of Units (SI).

FCC§15.247 (i), §1.1307 (b) (1) & §2.1093 - RF EXPOSURE

Applicable Standard

According to FCC §2.1093 and §1.1307(b) (1), systems operating under the provisions of this section shall be operated in a manner that ensure that the public is not exposed to radio frequency energy level in excess of the Commission’s guideline.

According to KDB 447498 D01 General RF Exposure Guidance

The 1-g and 10-g SAR test exclusion thresholds for 100 MHz to 6 GHz at test separation distances ≤ 50 mm are determined by:

$$[(\text{max. power of channel, including tune-up tolerance, mW})/(\text{min. test separation distance, mm})] \cdot [\sqrt{f(\text{GHz})}] \leq 3.0 \text{ for 1-g SAR and } \leq 7.5 \text{ for 10-g extremity SAR, where}$$

1. f(GHz) is the RF channel transmit frequency in GHz.
2. Power and distance are rounded to the nearest mW and mm before calculation.
3. The result is rounded to one decimal place for comparison.
4. When the minimum test separation distance is < 5 mm, a distance of 5 mm is applied to determine SAR test Exclusion.

Measurement Result

For worst case:

Mode	Frequency (MHz)	Max tune-up conducted power [#] (dBm)	Max tune-up conducted power [#] (mW)	Distance (mm)	Calculated value	Threshold (1-g SAR)	SAR Test Exclusion
BT	2402-2480	9.00	7.94	5	2.5	3	Yes

Result: Compliant

FCC §15.203 - ANTENNA REQUIREMENT

Applicable Standard

According to FCC § 15.203, an intentional radiator shall be designed to ensure that no antenna other than that furnished by the responsible party shall be used with the device. The use of a permanently attached antenna or of an antenna that uses a unique coupling to the intentional radiator shall be considered sufficient to comply with the provisions of this Section. The manufacturer may design the unit so that a broken antenna can be replaced by the user, but the use of a standard antenna jack or electrical connector is prohibited.

Antenna Connector Construction

The EUT has an internal antenna arrangement, which was permanently attached, the antenna gain[#] is -0.58dBi, fulfill the requirement of this section. Please refer to the EUT photos.

Result: Compliant

FCC §15.207 (a) - AC LINE CONDUCTED EMISSIONS

Applicable Standard

FCC §15.207(a)

EUT Setup

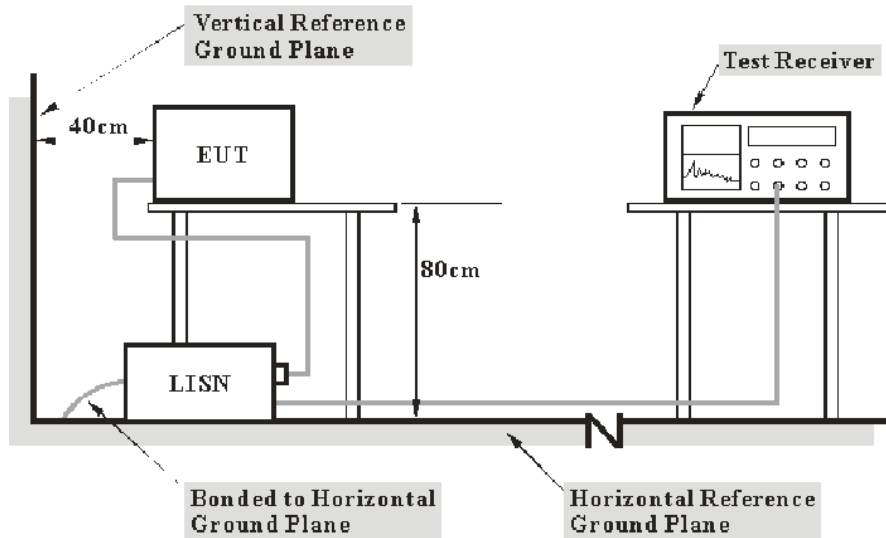

- Note: 1. Support units were connected to second LISN.
 2. Both of LISNs (AMN) 80 cm from EUT and at the least 80 cm from other units and other metal planes support units.

The measurement procedure of EUT setup is according with ANSI C63.10-2013. The related limit was specified in FCC Part 15.207.

The spacing between the peripherals was 10 cm.

EMI Test Receiver Setup

The EMI test receiver was set to investigate the spectrum from 150 kHz to 30 MHz.

During the conducted emission test, the EMI test receiver was set with the following configurations:

Frequency Range	IF B/W
150 kHz – 30 MHz	9 kHz

Test Procedure

Maximizing procedure was performed on the six (6) highest emissions of the EUT.

All final data was recorded in the Quasi-peak and average detection mode.

Factor & Over Limit Calculation

The factor is calculated by adding LISN VDF (Voltage Division Factor) and Cable Loss. The basic equation is as follows:

$$\text{Factor} = \text{LISN VDF} + \text{Cable Loss}$$

The “**Over limit**” column of the following data tables indicates the degree of compliance with the applicable limit. For example, an Over limit of -7 dB means the emission is 7 dB below the limit. The equation for calculation is as follows:

$$\begin{aligned}\text{Over Limit} &= \text{Level} - \text{Limit} \\ \text{Level} &= \text{Read Level} + \text{Factor}\end{aligned}$$

Note: The term "cable loss" refers to the combination of a cable and a 10dB transient limiter (attenuator).

Test Data

Environmental Conditions

Temperature:	26 °C
Relative Humidity:	70 %
ATM Pressure:	101 kPa

The testing was performed by Macy Shi on 2024-04-22.

EUT operation mode: Transmitting (Maximum output power mode, EDR (8DPSK) Low Channel)

AC 120V/60 Hz, Line

Date: 2024-04-22

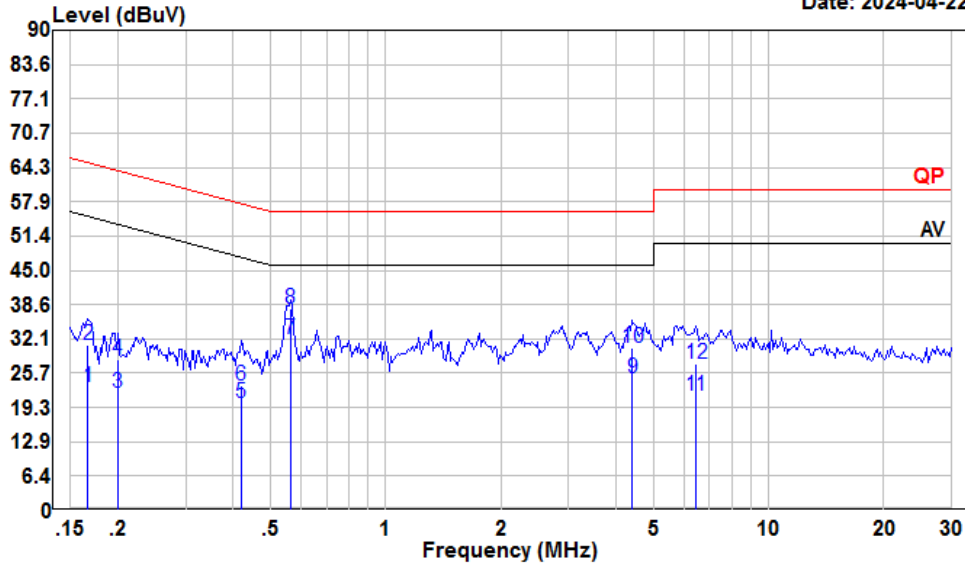

Condition: Line
 Project : 2401S48621-RF
 Tester : Macy shi
 Note : BT

	Read Freq	Read Level	LISN Level	LISN Factor	Cable Loss	Limit Line	Over Limit	Remark
	MHz	dBuV	dBuV	dB	dB	dBuV	dB	
1	0.17	2.08	23.09	10.86	10.15	55.12	-32.03	Average
2	0.17	10.08	31.09	10.86	10.15	65.12	-34.03	QP
3	0.20	1.26	22.15	10.80	10.09	53.62	-31.47	Average
4	0.20	7.29	28.18	10.80	10.09	63.62	-35.44	QP
5	0.42	-0.66	20.11	10.56	10.21	47.46	-27.35	Average
6	0.42	2.65	23.42	10.56	10.21	57.46	-34.04	QP
7	0.56	11.33	32.02	10.50	10.19	46.00	-13.98	Average
8	0.56	17.00	37.69	10.50	10.19	56.00	-18.31	QP
9	4.41	4.24	24.81	10.33	10.24	46.00	-21.19	Average
10	4.41	9.96	30.53	10.33	10.24	56.00	-25.47	QP
11	6.45	0.90	21.59	10.47	10.22	50.00	-28.41	Average
12	6.45	6.66	27.35	10.47	10.22	60.00	-32.65	QP

AC 120V/60 Hz, Neutral

Date: 2024-04-22

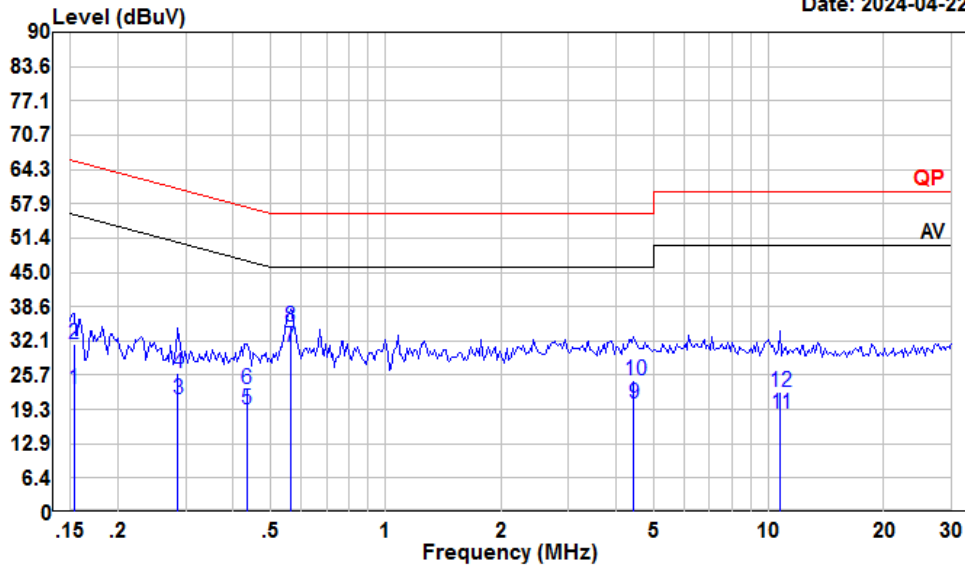

Condition: Neutral
 Project : 2401S48621-RF
 Tester : Macy shi
 Note : BT

	Read Freq	Read Level	LISN Level	LISN Factor	Cable Loss	Limit Line	Over Limit	Remark
	MHz	dBuV	dBuV	dB	dB	dBuV	dB	
1	0.15	2.46	23.20	10.59	10.15	55.82	-32.62	Average
2	0.15	10.86	31.60	10.59	10.15	65.82	-34.22	QP
3	0.29	0.64	21.30	10.52	10.14	50.63	-29.33	Average
4	0.29	5.34	26.00	10.52	10.14	60.63	-34.63	QP
5	0.43	-1.47	19.38	10.65	10.20	47.20	-27.82	Average
6	0.43	2.26	23.11	10.65	10.20	57.20	-34.09	QP
7	0.56	10.06	30.95	10.70	10.19	46.00	-15.05	Average
8	0.56	13.87	34.76	10.70	10.19	56.00	-21.24	QP
9	4.45	-0.20	20.50	10.46	10.24	46.00	-25.50	Average
10	4.45	4.10	24.80	10.46	10.24	56.00	-31.20	QP
11	10.73	-2.57	18.47	10.80	10.24	50.00	-31.53	Average
12	10.73	1.48	22.52	10.80	10.24	60.00	-37.48	QP

FCC §15.205, §15.209 & §15.247(d) - RADIATED EMISSIONS

Applicable Standard

FCC §15.205; §15.209; §15.247(d)

EUT Setup

9 kHz-30MHz:

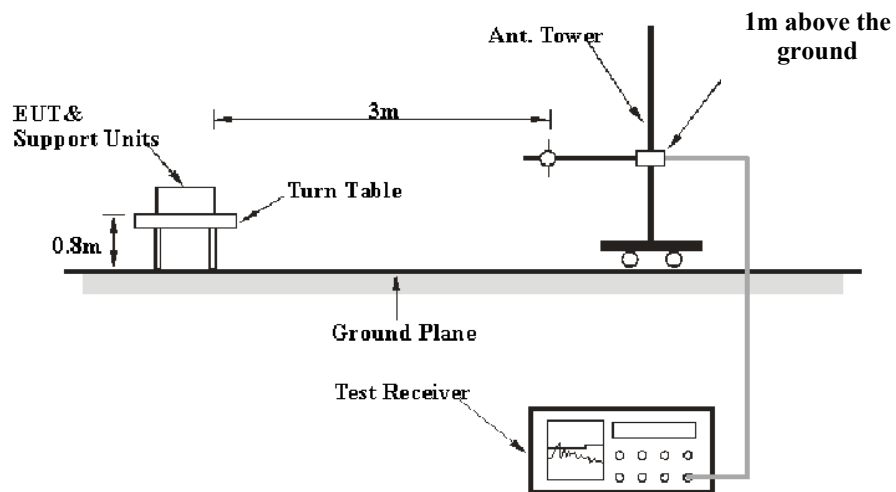

30MHz-1GHz:

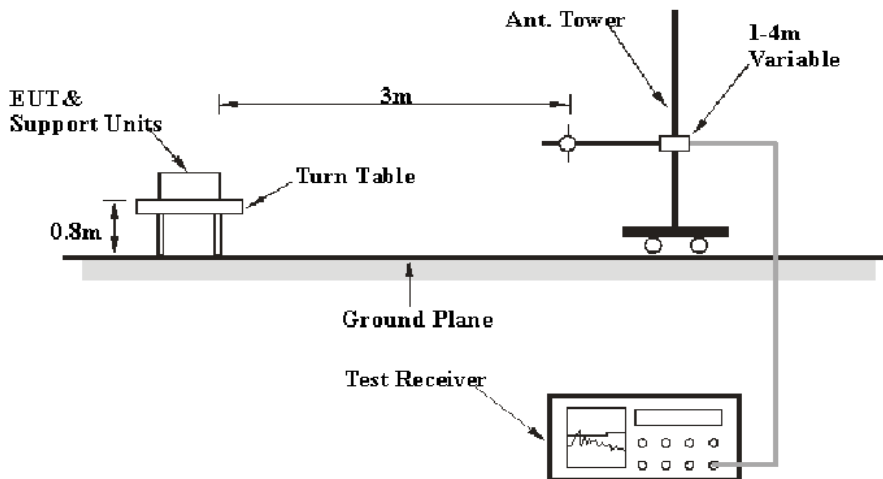

Above 1GHz:

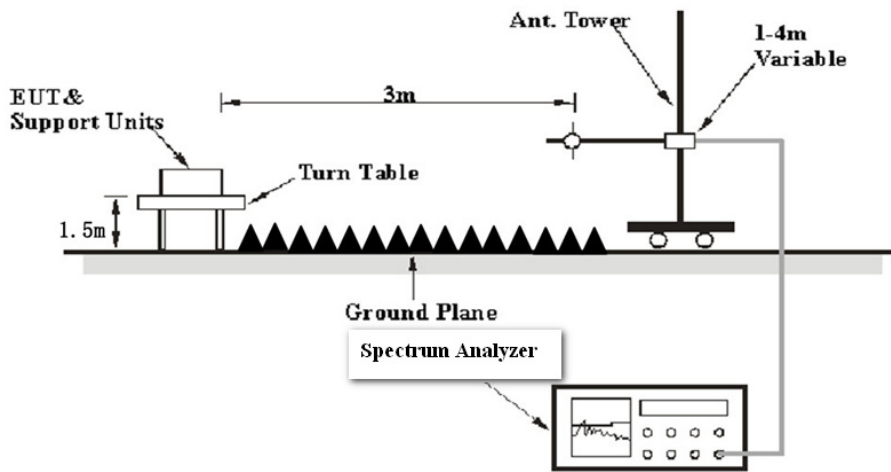

The radiated emission tests were performed in the 3 meters, using the setup accordance with the ANSI C63.10-2013. The specification used was the FCC 15.209 and FCC 15.247 limits.

EMI Test Receiver & Spectrum Analyzer Setup

The EMI test receiver & Spectrum Analyzer Setup were set with the following configurations:

Frequency Range	RBW	Video B/W	IF B/W	Measurement
9 kHz – 150 kHz	/	/	200 Hz	QP
	300 Hz	1 kHz	/	PK
150 kHz – 30 MHz	/	/	9 kHz	QP
	10 kHz	30 kHz	/	PK
30 MHz – 1000 MHz	/	/	120 kHz	QP
	100 kHz	300 kHz	/	PK
Above 1 GHz	Harmonics & Band Edge			
	1MHz	3 MHz	/	PK
	Average Emission Level=Peak Emission Level+20*log(Duty cycle)			
	Other Emissions			
	1MHz	3 MHz	/	PK
	1MHz	10 Hz	/	Average

For Duty cycle measurement:

Use the duty cycle factor correction factor method per 15.35(c).

Duty cycle=On time/100milliseconds, On time= $N_1 * L_1 + N_2 * L_2 + \dots + N_{n-1} * L_{n-1} + N_n * L_n$,

Where N_1 is number of type 1 pulses, L_1 is length of type 1 pulse, etc.

Test Procedure

Maximizing procedure was performed on the highest emissions to ensure that the EUT complied with all installation combinations.

All final data was recorded in Quasi-peak detection mode except for the frequency bands 9–90 kHz, 110–490 kHz and above 1000 MHz, average detection modes for frequency bands 9–90 kHz and 110–490 kHz, peak and average detection modes for frequencies above 1 GHz.

For 9 kHz-30MHz, the report shall list the six emissions with the smallest margin relative to the limit, for each of the three antenna orientations (parallel, perpendicular, and ground-parallel) unless the margin is greater than 20 dB.

If the maximized peak measured value complies with under the QP/Average limit more than 6dB, then it is unnecessary to perform an QP/Average measurement.

All emissions under the average limit and under the noise floor have not recorded in the report.

Factor & Over Limit/Margin Calculation

The Factor is calculated by adding the Antenna Factor and Cable Loss, and subtracting the Amplifier Gain. The basic equation is as follows:

$$\text{Factor} = \text{Antenna Factor} + \text{Cable Loss} - \text{Amplifier Gain}$$

The “**Over Limit/Margin**” column of the following data tables indicates the degree of compliance with the applicable limit. For example, an Over Limit/margin of -7dB means the emission is 7dB below the limit. The equation for calculation is as follows:

$$\begin{aligned} \text{Over Limit/Margin} &= \text{Level/Corrected Amplitude} - \text{Limit} \\ \text{Level / Corrected Amplitude} &= \text{Read Level} + \text{Factor} \end{aligned}$$

Test Data

Environmental Conditions

Temperature:	25~25.6°C
Relative Humidity:	50~54 %
ATM Pressure:	101 kPa

The testing was performed by Warren Huang on 2024-04-23 for below 1GHz and Dylan Yang from 2024-04-24 to 2024-04-28 for above 1GHz.

Test mode: Transmitting

Note: After pre-scan in the X, Y and Z axes of orientation, the worst case Z-axis of orientation was recorded.

9 kHz-30MHz: *(Maximum output power mode, EDR Mode (8DPSK) Low channel)*

For the radiated spurious emission below 30MHz, the emissions are 20dB below the limit or the noise floor which are not recorded.

30MHz-1GHz: (Maximum output power mode, EDR Mode (8DPSK) Low channel)

Horizontal

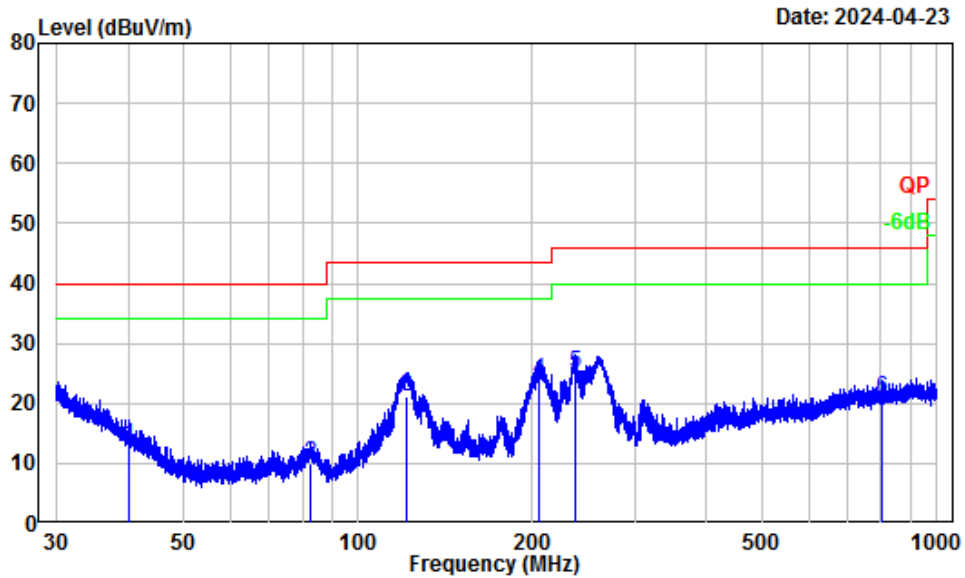

Site : Chamber A
 Condition : 3m Horizontal
 Project Number: 2401S48621-RF
 Note : BT
 Tester : Warren Huang

	Freq	Factor	Read Level	Level	Limit	Over Limit	Remark
	MHz	dB/m	dBuV	dBuV/m	dBuV/m	dB	
1	40.08	-11.57	24.61	13.04	40.00	-26.96	QP
2	82.61	-18.21	28.03	9.82	40.00	-30.18	QP
3	120.75	-12.35	33.50	21.15	43.50	-22.35	QP
4	204.69	-13.57	37.57	24.00	43.50	-19.50	QP
5	236.75	-14.24	39.21	24.97	46.00	-21.03	QP
6	803.55	-5.27	25.98	20.71	46.00	-25.29	QP

Vertical

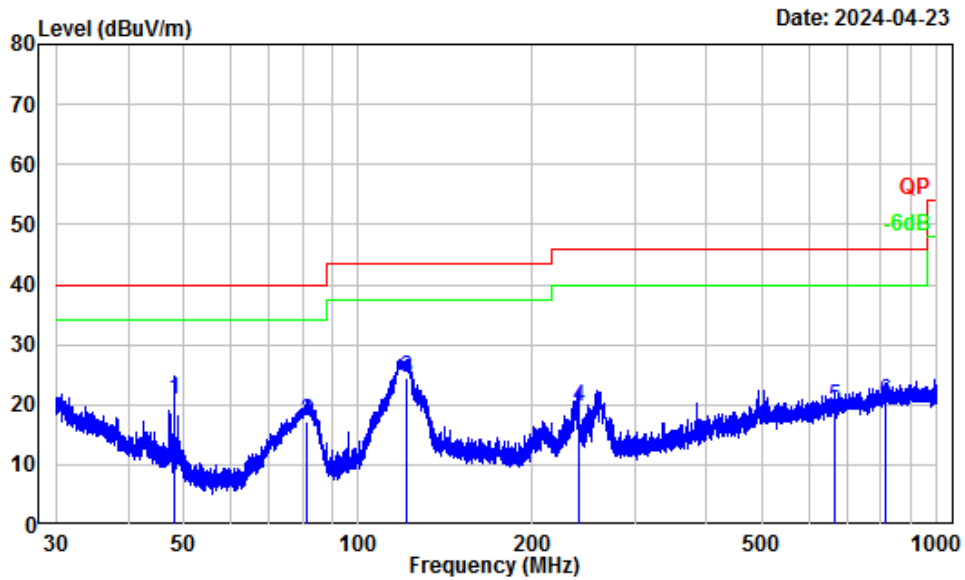

Site : Chamber A
 Condition : 3m Vertical
 Project Number: 2401S48621-RF
 Note : BT
 Tester : Warren Huang

	Freq	Factor	Read Level	Level	Limit Line	Over Limit	Remark
	MHz	dB/m	dBuV	dBuV/m	dBuV/m	dB	
1	48.02	-17.55	38.26	20.71	40.00	-19.29	QP
2	81.71	-18.77	35.87	17.10	40.00	-22.90	QP
3	121.39	-12.74	37.18	24.44	43.50	-19.06	QP
4	239.99	-14.88	34.46	19.58	46.00	-26.42	QP
5	666.68	-6.90	26.46	19.56	46.00	-26.44	QP
6	814.54	-5.31	25.82	20.51	46.00	-25.49	QP

Above 1GHz:

Frequency (MHz)	Receiver		Polar (H/V)	Factor (dB/m)	Corrected Amplitude (dBµV/m)	Limit (dBµV/m)	Margin (dB)
	Reading (dBµV)	PK/Ave					
8DPSK							
Low Channel 2402MHz							
2380.25	53.42	PK	H	-3.17	50.25	74	-23.75
2381.65	53.73	PK	V	-3.17	50.56	74	-23.44
4804.00	51.35	PK	H	1.69	53.04	74	-20.96
4804.00	50.52	PK	V	1.69	52.21	74	-21.79
Middle Channel 2441MHz							
4882.00	52.62	PK	H	1.79	54.41	74	-19.59
4882.00	51.77	PK	V	1.79	53.56	74	-20.44
High Channel 2480MHz							
2483.66	60.10	PK	H	-3.17	56.93	74	-17.07
2483.67	54.30	PK	V	-3.17	51.13	74	-22.87
4960.00	54.27	PK	H	2.68	56.95	74	-17.05
4960.00	51.82	PK	V	2.68	54.50	74	-19.50

Field Strength of Average							
Frequency (MHz)	Peak Measurement @3m (dBµV/m)	Polar (H/V)	Duty Cycle Correction Factor (dB)	Corrected Amplitude (dBµV/m)	FCC Part 15.247		
					Limit (dBµV/m)	Margin (dB)	Comment
Low Channel 2402MHz							
2380.25	50.25	H	-24.73	25.52	54	-28.48	Bandedge
2381.65	50.56	V	-24.73	25.83	54	-28.17	Bandedge
4804.00	53.04	H	-24.73	28.31	54	-25.69	Harmonic
4804.00	52.21	V	-24.73	27.48	54	-26.52	Harmonic
Middle Channel 2441MHz							
4882.00	54.41	H	-24.73	29.68	54	-24.32	Harmonic
4882.00	53.56	V	-24.73	28.83	54	-25.17	Harmonic
High Channel 2480MHz							
2483.66	56.93	H	-24.73	32.20	54	-21.80	Bandedge
2483.67	51.13	V	-24.73	26.40	54	-27.60	Bandedge
4960.00	56.95	H	-24.73	32.22	54	-21.78	Harmonic
4960.00	54.50	V	-24.73	29.77	54	-24.23	Harmonic

Note:

Corrected Amplitude/Level = Corrected Factor + Reading

Margin = Corrected Amplitude/Level - Limit

Average Corrected Amplitude /Level= Peak level+ Duty Cycle Corrected Factor

Duty cycle = Ton/100ms = 2.90*2/100=0.058

Duty Cycle Corrected Factor = 20lg (Duty cycle) = 20lg0.058 = -24.73

Duty cycle

Duty Cycle (100ms)

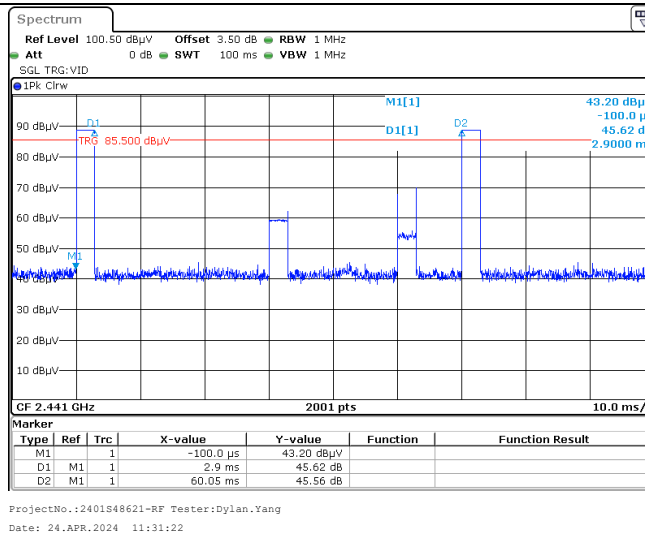

Duty Cycle (1s)

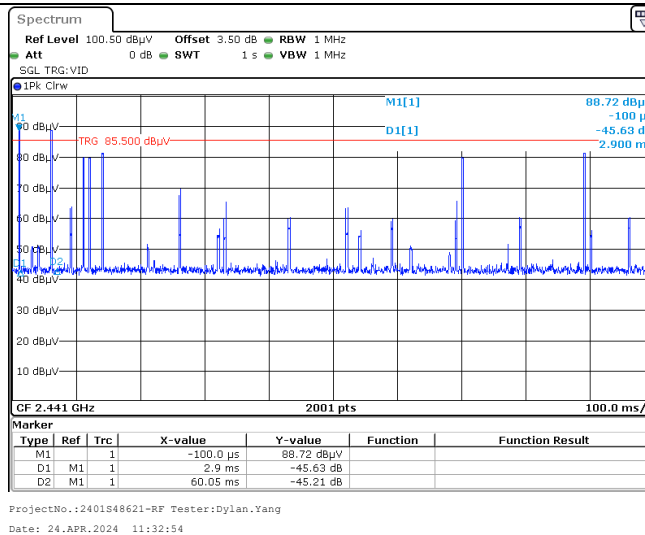

Test plots for Band Edge Measurements (Radiated):

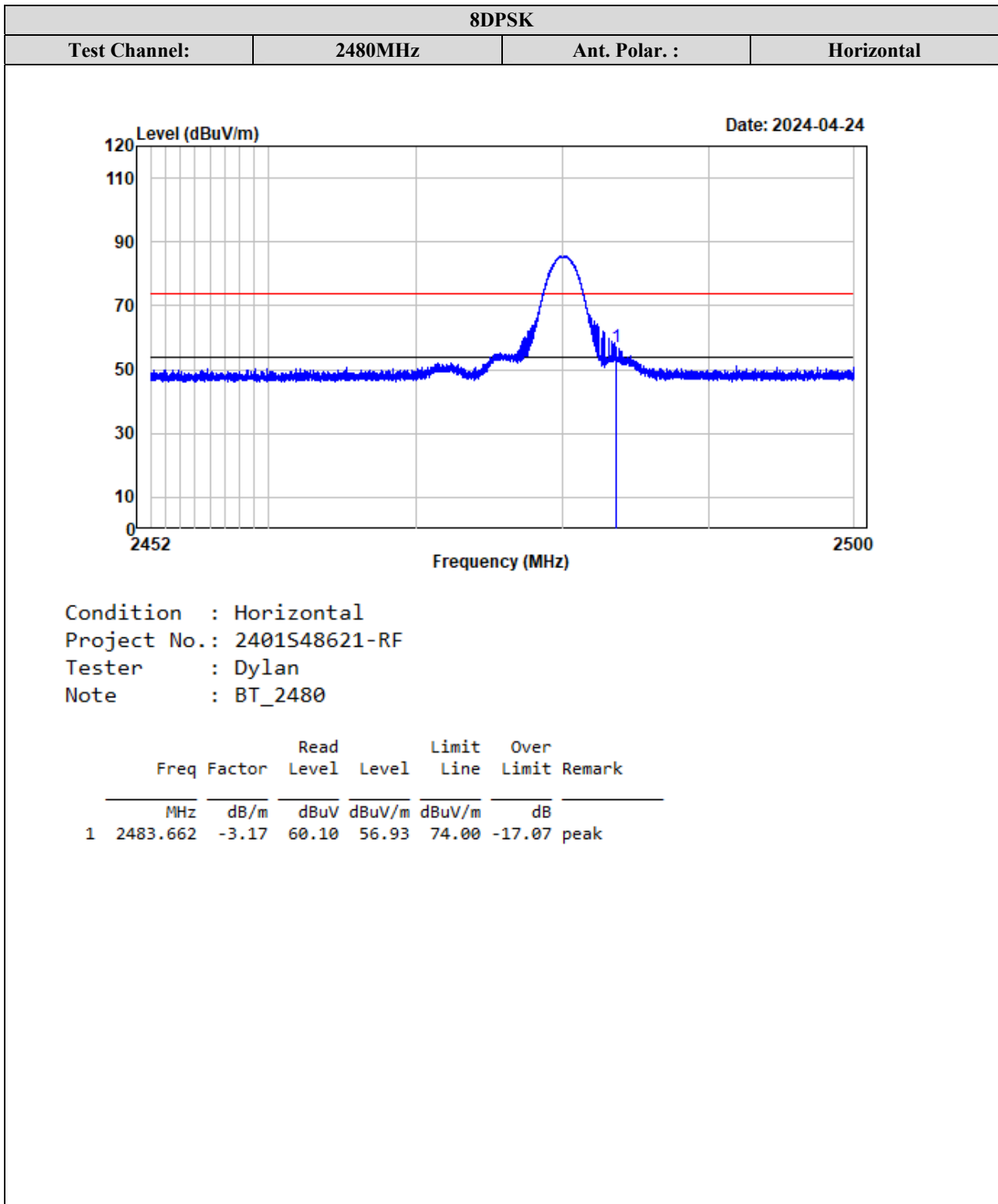

8DPSK			
Test Channel:	2480MHz	Ant. Polar. :	Vertical

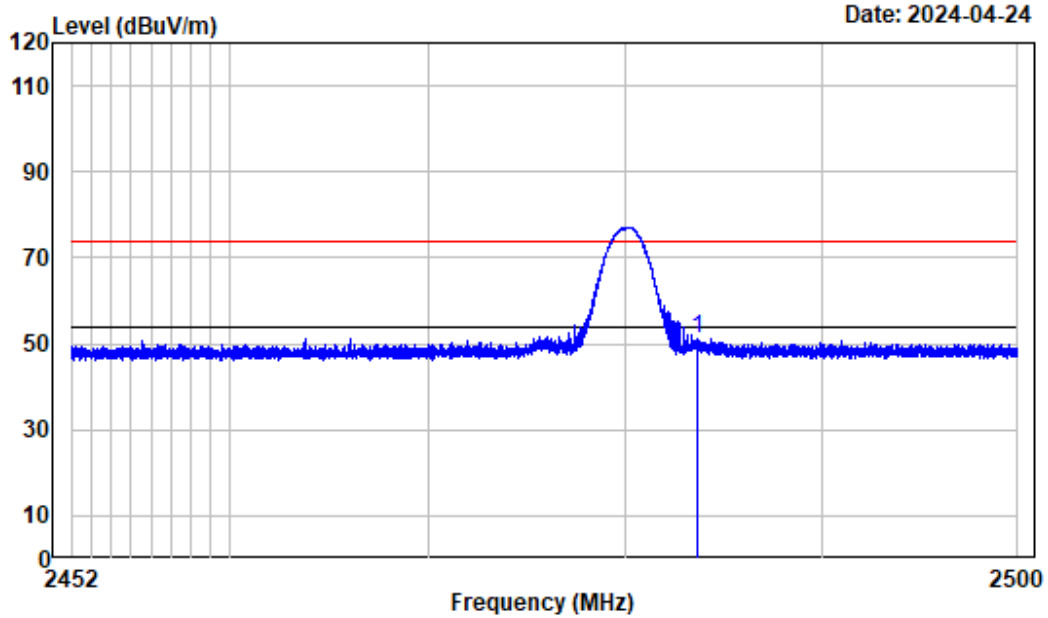

Condition : Vertical
 Project No.: 2401S48621-RF
 Tester : Dylan
 Note : BT_2480

		Read	Limit	Over		
		Level	Line	Limit	Remark	
Freq	Factor	dBuV	dBuV/m	dBuV/m	dB	
MHz	dB/m	dBuV	dBuV/m	dBuV/m	dB	
1	2483.668	-3.17	54.30	74.00	-22.87	peak

Listed with the harmonic margin test plot (EDR mode 8DPSK, High channel):

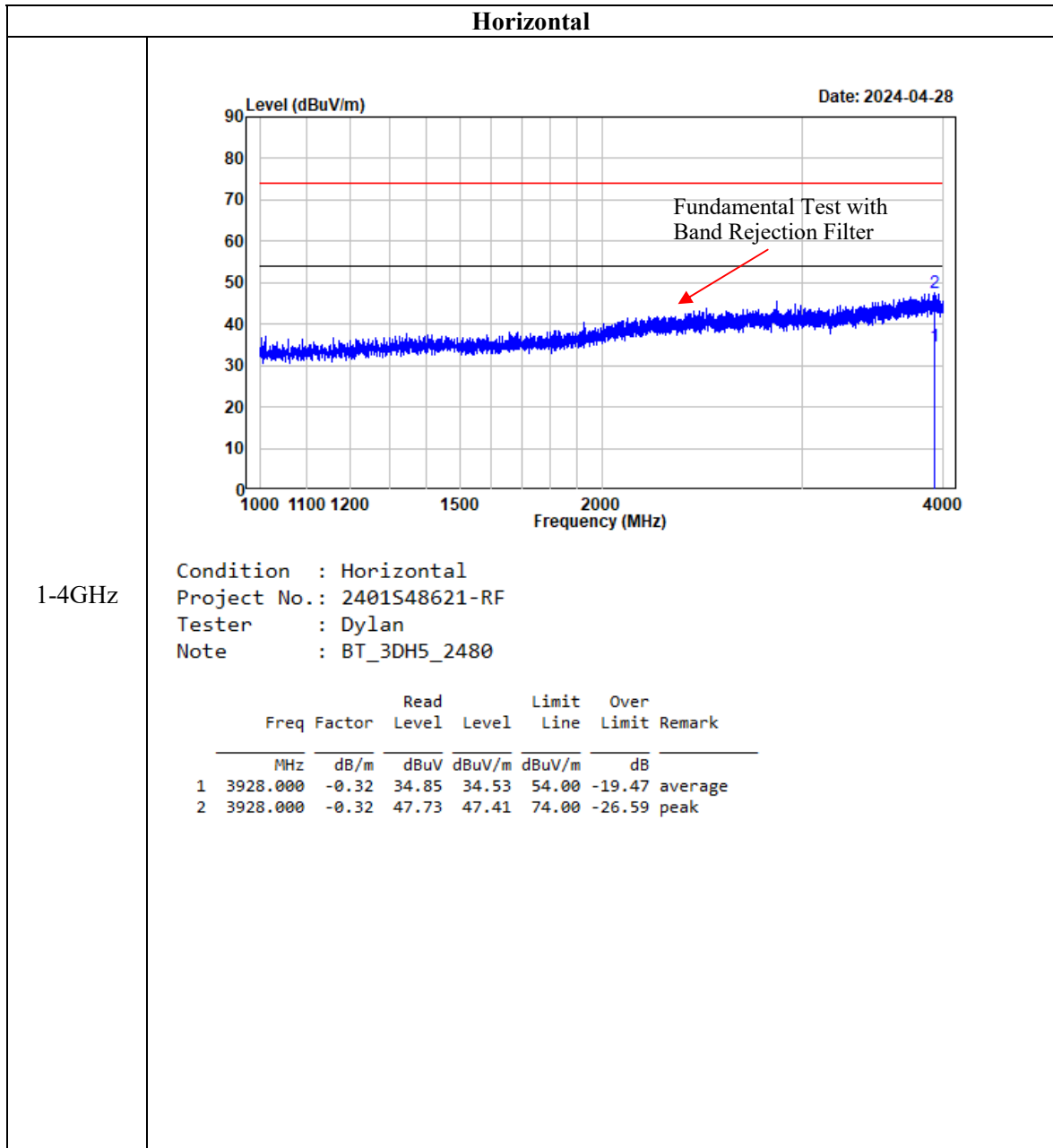

Vertical

1-4GHz

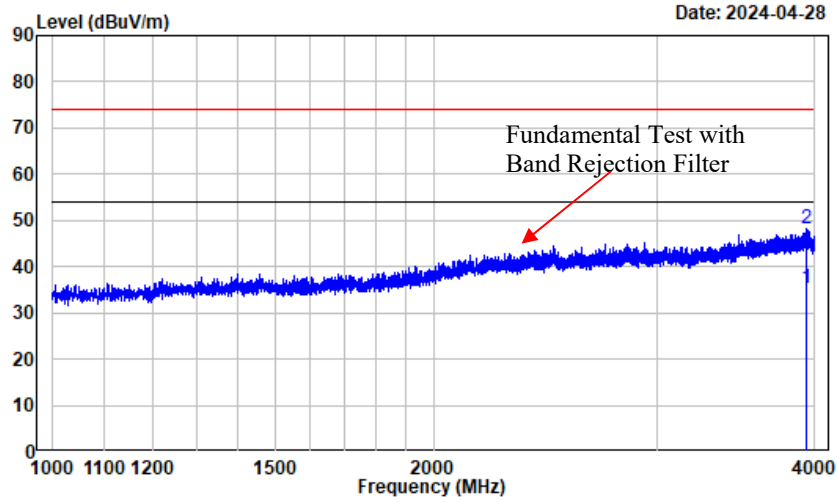

Condition : Vertical
 Project No.: 2401S48621-RF
 Tester : Dylan
 Note : BT_3DH5_2480

	Freq	Factor	Read Level	Level	Limit Line	Over Limit	Remark
	MHz	dB/m	dBuV	dBuV/m	dBuV/m	dB	
1	3935.875	-0.27	35.62	35.35	54.00	-18.65	average
2	3935.875	-0.27	48.37	48.10	74.00	-25.90	peak

Horizontal

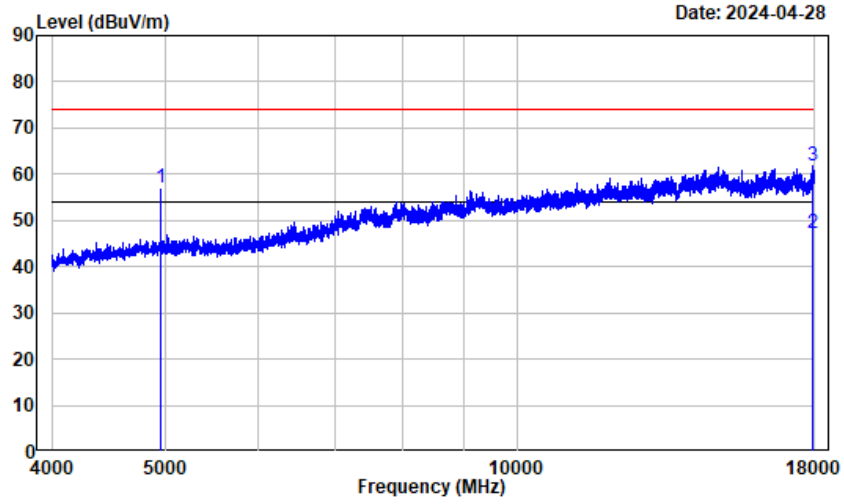

4-18GHz

Condition : Horizontal
 Project No.: 2401S48621-RF
 Tester : Dylan
 Note : BT_3DH5_2480

	Freq	Factor	Read Level	Level	Limit Line	Over Limit	Remark
	MHz	dB/m	dBuV	dBuV/m	dBuV/m	dB	
1	4960.000	2.68	54.27	56.95	74.00	-17.05	Peak
2	17940.500	24.19	23.03	47.22	54.00	-6.78	average
3	17940.500	24.19	37.61	61.80	74.00	-12.20	peak

Vertical

4-18GHz

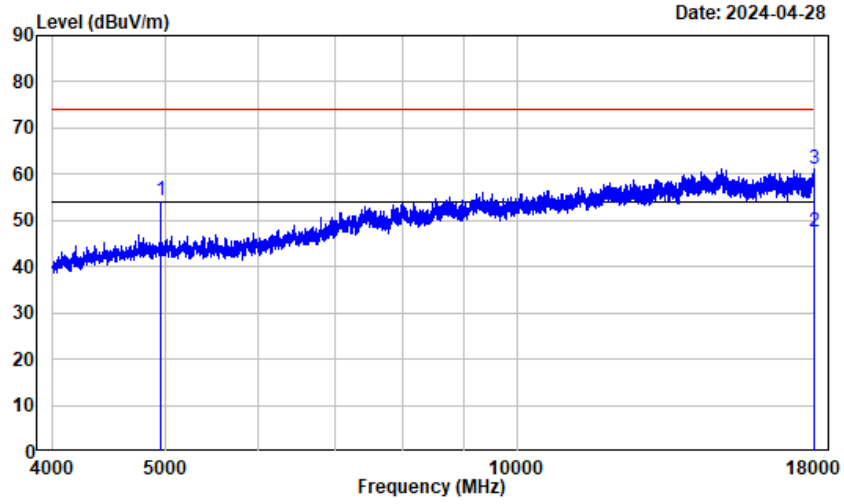

Condition : Vertical
 Project No.: 2401S48621-RF
 Tester : Dylan
 Note : BT_3DH5_2480

	Freq	Factor	Read Level	Level	Limit Line	Over Limit	Remark
	MHz	dB/m	dBuV	dBuV/m	dBuV/m	dB	
1	4960.000	2.68	51.82	54.50	74.00	-19.50	Peak
2	17973.750	24.44	23.17	47.61	54.00	-6.39	average
3	17973.750	24.44	36.77	61.21	74.00	-12.79	peak

Horizontal

18-25GHz

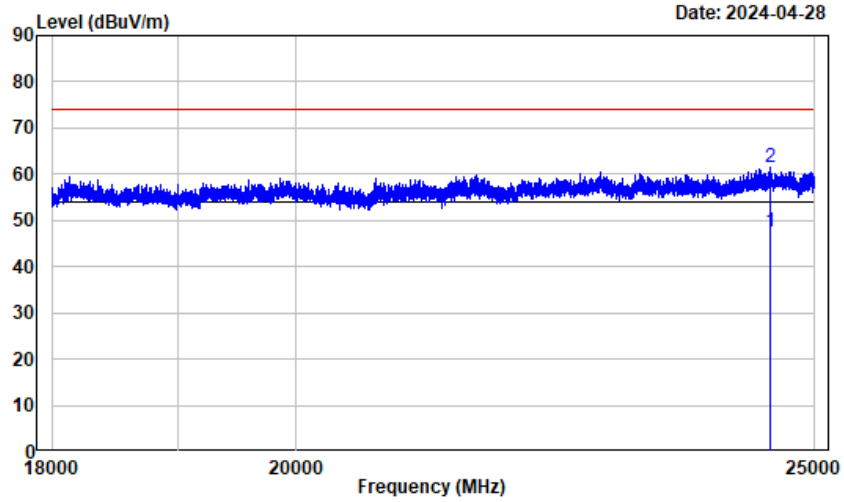

Condition : Horizontal
 Project No.: 2401S48621-RF
 Tester : Dylan
 Note : BT_3DH5_2480

	Freq	Factor	Read Level	Level	Limit Line	Over Limit	Remark
	MHz	dB/m	dBuV	dBuV/m	dBuV/m	dB	
1	24524.880	18.97	28.62	47.59	54.00	-6.41	Average
2	24524.880	18.97	42.64	61.61	74.00	-12.39	peak

Vertical

18-25GHz

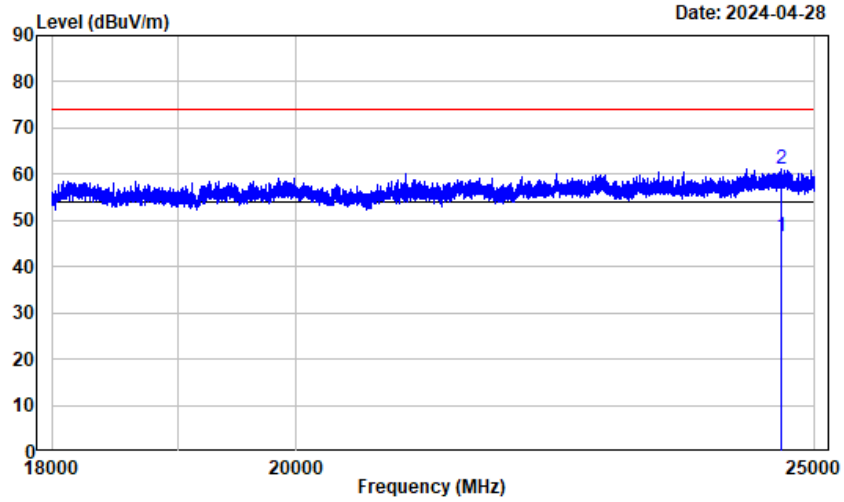

Condition : Vertical
 Project No.: 2401S48621-RF
 Tester : Dylan
 Note : BT_3DH5_2480

	Freq	Factor	Read Level	Level	Limit Line	Over Limit	Remark
	MHz	dB/m	dBuV	dBuV/m	dBuV/m	dB	
1	24639.500	18.82	27.63	46.45	54.00	-7.55	Average
2	24639.500	18.82	42.33	61.15	74.00	-12.85	peak

FCC §15.247(a) (1) - CHANNEL SEPARATION TEST

Applicable Standard

Frequency hopping systems shall have hopping channel carrier frequencies separated by a minimum of 25 kHz or the 20 dB bandwidth of the hopping channel, whichever is greater. Alternatively, frequency hopping systems operating in the 2400-2483.5 MHz band may have hopping channel carrier frequencies that are separated by 25 kHz or two-thirds of the 20 dB bandwidth of the hopping channel, whichever is greater provided the systems operate with an output power no greater than 125 mW. The system shall hop to channel frequencies that are selected at the system hopping rate from a pseudo randomly ordered list of hopping frequencies. Each frequency must be used equally on the average by each transmitter. The system receivers shall have input bandwidths that match the hopping channel bandwidths of their corresponding transmitters and shall shift frequencies in synchronization with the transmitted signals.

Test Procedure

Test Method: ANSI C63.10-2013 Clause 7.8.2

1. Set the EUT in transmitting mode, maxhold the channel.
2. Set the adjacent channel of the EUT and maxhold another trace.
3. Measure the channel separation.

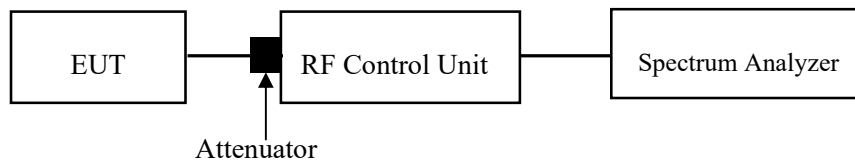

Test Data

Environmental Conditions

Temperature:	25 °C
Relative Humidity:	45 %
ATM Pressure:	101kPa

The testing was performed by Navilite Cai on 2024-04-26.

EUT operation mode: Transmitting

Test Result: Compliant. Please refer to the Appendix.

FCC §15.247(a) (1) - 20 dB EMISSION BANDWIDTH

Applicable Standard

Alternatively, frequency hopping systems operating in the 2400–2483.5 MHz band may have hopping channel carrier frequencies that are separated by 25 kHz or two-thirds of the 20 dB bandwidth of the hopping channel, whichever is greater, provided the systems operate with an output power no greater than 125 mW.

Test Procedure

Test Method: ANSI C63.10-2013 Clause 7.8.7 & Clause 6.9.2

The following conditions shall be observed for measuring the occupied bandwidth and 20 dB bandwidth:

- The transmitter shall be operated at its maximum carrier power measured under normal test conditions.
- The span of the spectrum analyzer shall be set large enough to capture all products of the modulation process, including the emission skirts, around the carrier frequency, but small enough to avoid having other emissions (e.g. on adjacent channels) within the span.
- The detector of the spectrum analyzer shall be set to “Sample”. However, a peak, or peak hold, may be used in place of the sampling detector since this usually produces a wider bandwidth than the actual bandwidth (worst-case measurement). Use of a peak hold (or “Max Hold”) may be necessary to determine the occupied / 20 dB bandwidth if the device is not transmitting continuously.
- The nominal IF filter bandwidth (3 dB RBW) shall be in the range of 1% to 5% of the OBW/ 20dB bandwidth and video bandwidth (VBW) shall be approximately three times RBW, unless otherwise specified by the applicable requirement.

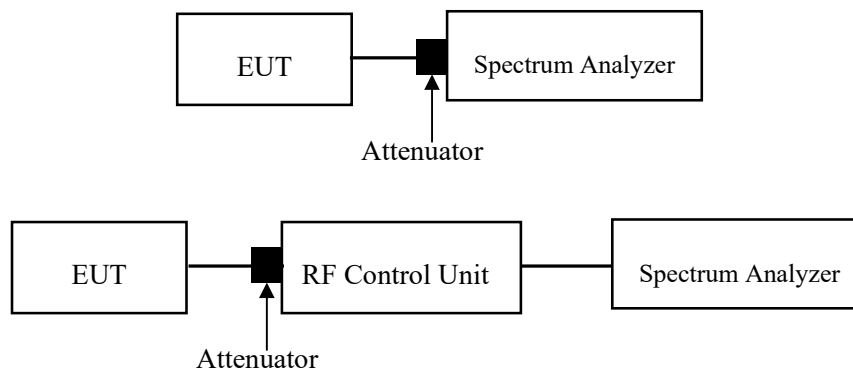

Test Data**Environmental Conditions**

Temperature:	25-26 °C
Relative Humidity:	45-48 %
ATM Pressure:	101kPa

The testing was performed by Navilite Cai and Cheeb Huang from 2024-04-26 to 2024-04-28.

EUT operation mode: Transmitting

Test Result: Compliant. Please refer to the Appendix.

FCC §15.247(a) (1) (iii) - QUANTITY OF HOPPING CHANNEL TEST

Applicable Standard

Frequency hopping systems in the 2400–2483.5 MHz band shall use at least 15 channels. The average time of occupancy on any channel shall not be greater than 0.4 seconds within a period of 0.4 seconds multiplied by the number of hopping channels employed. Frequency hopping systems may avoid or suppress transmissions on a particular hopping frequency provided that a minimum of 15 channels are used.

Test Procedure

Test Method: ANSI C63.10-2013 Clause 7.8.3

1. Check the calibration of the measuring instrument (SA) using either an internal calibrator or a known signal from an external generator.
2. Set the EUT in hopping mode from first channel to last.
3. By using the max-hold function record the quantity of the channel.

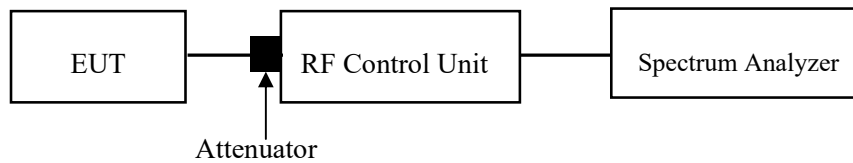

Test Data

Environmental Conditions

Temperature:	25 °C
Relative Humidity:	45 %
ATM Pressure:	101kPa

The testing was performed by Navilite Cai on 2024-04-26.

EUT operation mode: Transmitting

Test Result: Compliant. Please refer to the Appendix.

FCC §15.247(a) (1) (iii) - TIME OF OCCUPANCY (DWELL TIME)

Applicable Standard

Frequency hopping systems in the 2400-2483.5 MHz shall use at least 15 channels. The average time of occupancy on any channel shall not be greater than 0.4 seconds within a period of 0.4 seconds multiplied by the number of hopping channels employed. Frequency hopping systems may avoid or suppress transmissions on a particular hopping frequency provided that a minimum of 15 channels are used.

Test Procedure

Test Method: ANSI C63.10-2013 Clause 7.8.4

1. The EUT was worked in channel hopping.
2. Set the RBW to: 1MHz.
3. Set the VBW $\geq 3 \times$ RBW.
4. Set the span to 0Hz.
5. Detector = peak.
6. Sweep time = auto couple.
7. Trace mode = max hold.
8. Allow trace to fully stabilize.
9. Recorded the time of single pulses

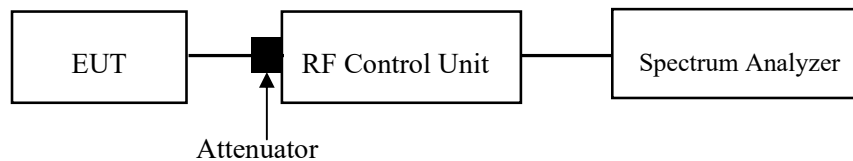

Note 1: A period time= $0.4 \times 79 = 31.6(S)$, Result=Burst Width*Total hops

Note 2: Total hops=Hopping Number in $3.16s \times 10$

Note 3: Hopping Number in $3.16s =$ Total of highest signals in $3.16s$ (Second high signals were other channel)

Test Data

Environmental Conditions

Temperature:	26 °C
Relative Humidity:	48 %
ATM Pressure:	101kPa

The testing was performed by Tom Tan on 2024-04-30.

EUT operation mode: Transmitting

Test Result: Compliant. Please refer to the Appendix.

FCC §15.247(b) (1) - PEAK OUTPUT POWER MEASUREMENT

Applicable Standard

According to §15.247(b) (1), for frequency hopping systems operating in the 2400–2483.5 MHz band employing at least 75 non-overlapping hopping channels, and all frequency hopping systems in the 5725–5850 MHz band: 1 watt. And for all other frequency hopping systems in the 2400–2483.5 MHz band: 0.125 watts.

Test Procedure

Test Method: ANSI C63.10-2013 Clause 7.8.5

1. Place the EUT on a bench and set in transmitting mode.
2. Remove the antenna from the EUT and then connect a low loss RF cable from the antenna port to one test equipment.
3. Add a correction factor to the display.

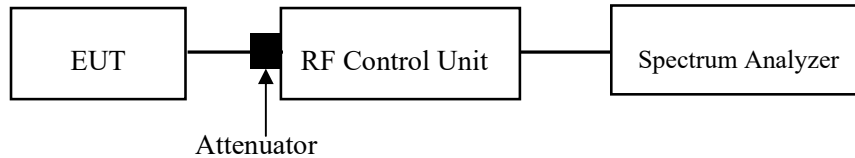

Test Data

Environmental Conditions

Temperature:	25°C
Relative Humidity:	45 %
ATM Pressure:	101kPa

The testing was performed by Navilite Cai on 2024-04-26.

EUT operation mode: Transmitting

Test Result: Compliant. Please refer to the Appendix.

FCC §15.247(d) § 5.5 - BAND EDGES TESTING

Applicable Standard

In any 100 kHz bandwidth outside the frequency band in which the spread spectrum or digitally modulated intentional radiator is operating, the radio frequency power that is produced by the intentional radiator shall be at least 20 dB below that in the 100 kHz bandwidth within the band that contains the highest level of the desired power, based on either an RF conducted or a radiated measurement, provided the transmitter demonstrates compliance with the peak conducted power limits. If the transmitter complies with the conducted power limits based on the use of RMS averaging over a time interval, as permitted under paragraph (b)(3) of this section, the attenuation required under this paragraph shall be 30 dB instead of 20 dB. Attenuation below the general limits specified in §15.209(a) is not required. In addition, radiated emissions which fall in the restricted bands, as defined in §15.205(a), must also comply with the radiated emission limits specified in §15.209(a) (see §15.205(c)).

Test Procedure

Test Method: ANSI C63.10-2013 Clause 7.8.6 & Clause 6.10

1. Check the calibration of the measuring instrument using either an internal calibrator or a known signal from an external generator.
2. Remove the antenna from the EUT and then connect to a low loss RF cable from the antenna port to a EMI test receiver, then turn on the EUT and make it operate in transmitting mode. Then set it to Low Channel and High Channel within its operating range, and make sure the instrument is operated in its linear range.
3. Set RBW of spectrum analyzer to 100 kHz with a convenient frequency span including 100 kHz bandwidth from band edge.
4. Measure the highest amplitude appearing on spectral display and set it as a reference level. Plot the graph with marking the highest point and edge frequency.
5. Repeat above procedures until all measured frequencies were complete.

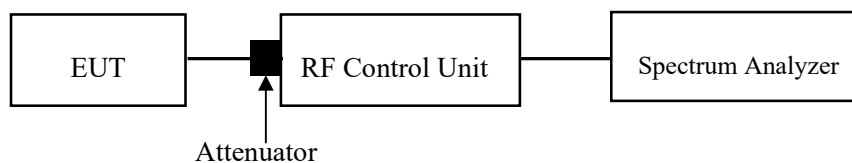

Test Data**Environmental Conditions**

Temperature:	25 °C
Relative Humidity:	45%
ATM Pressure:	101kPa

The testing was performed by Navilite Cai on 2024-04-26.

EUT operation mode: Transmitting

Test Result: Compliant. Please refer to the Appendix.

EUT PHOTOGRAPHS

Please refer to the attachment 2401S48621-RF External photo and 2401S48621-RF Internal photo.

TEST SETUP PHOTOGRAPHS

Please refer to the attachment 2401S48621-RF Test Setup photo.

APPENDIX

Appendix A: 20dB Emission Bandwidth

Test Result

Test Mode	Antenna	Frequency[MHz]	20db EBW[MHz]	FL[MHz]	FH[MHz]	Limit[MHz]	Verdict
DH1	Ant1	2402	0.978	2401.52	2402.50	---	---
		2441	0.981	2440.52	2441.50	---	---
		2480	0.975	2479.53	2480.50	---	---
2DH1	Ant1	2402	1.342	2401.35	2401.85	---	---
		2441	1.335	2440.35	2441.68	---	---
		2480	1.341	2479.35	2480.69	---	---
3DH1	Ant1	2402	1.269	2401.41	2402.68	---	---
		2441	1.269	2440.41	2441.68	---	---
		2480	1.272	2479.41	2480.68	---	---

Test Graphs

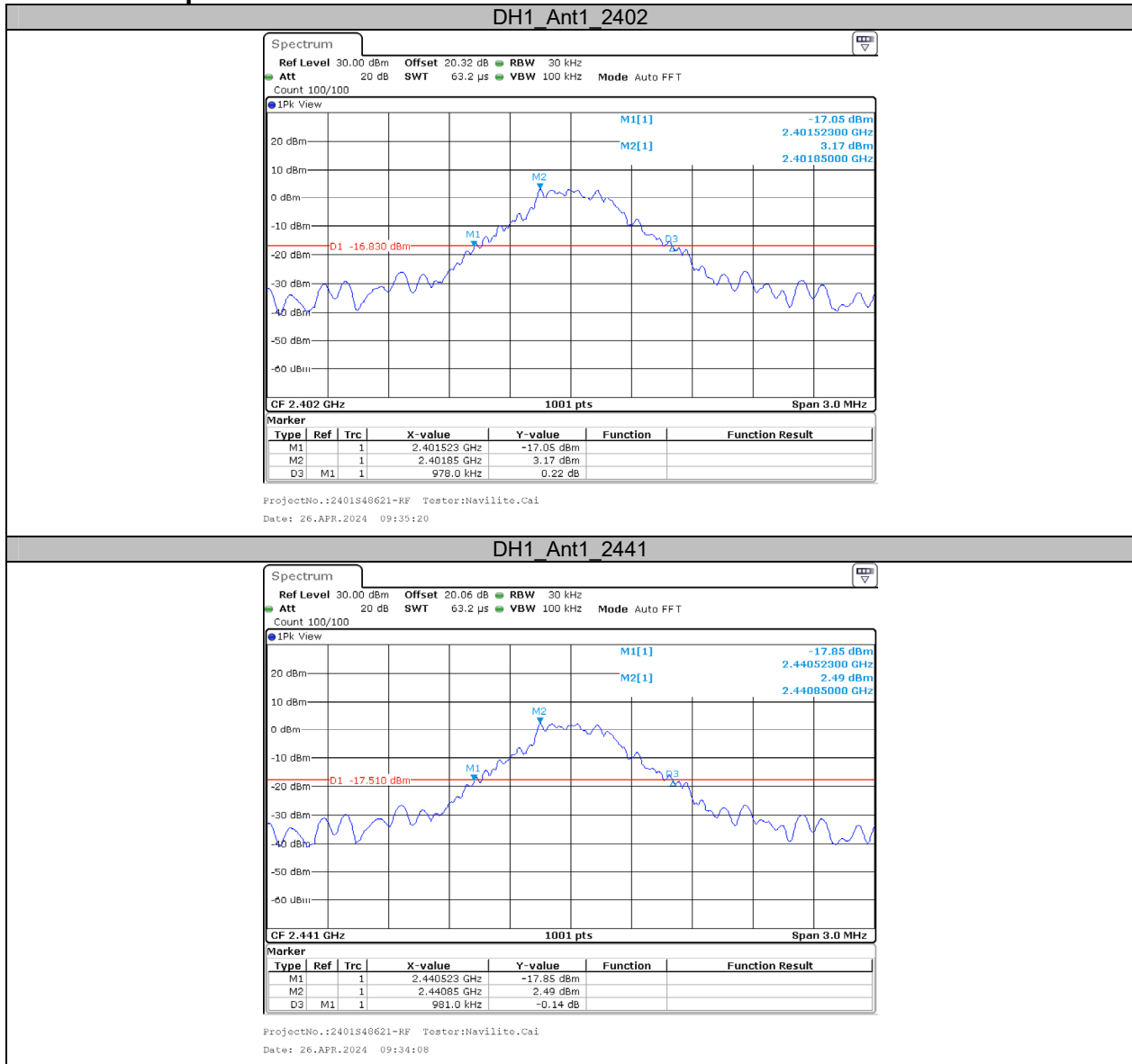

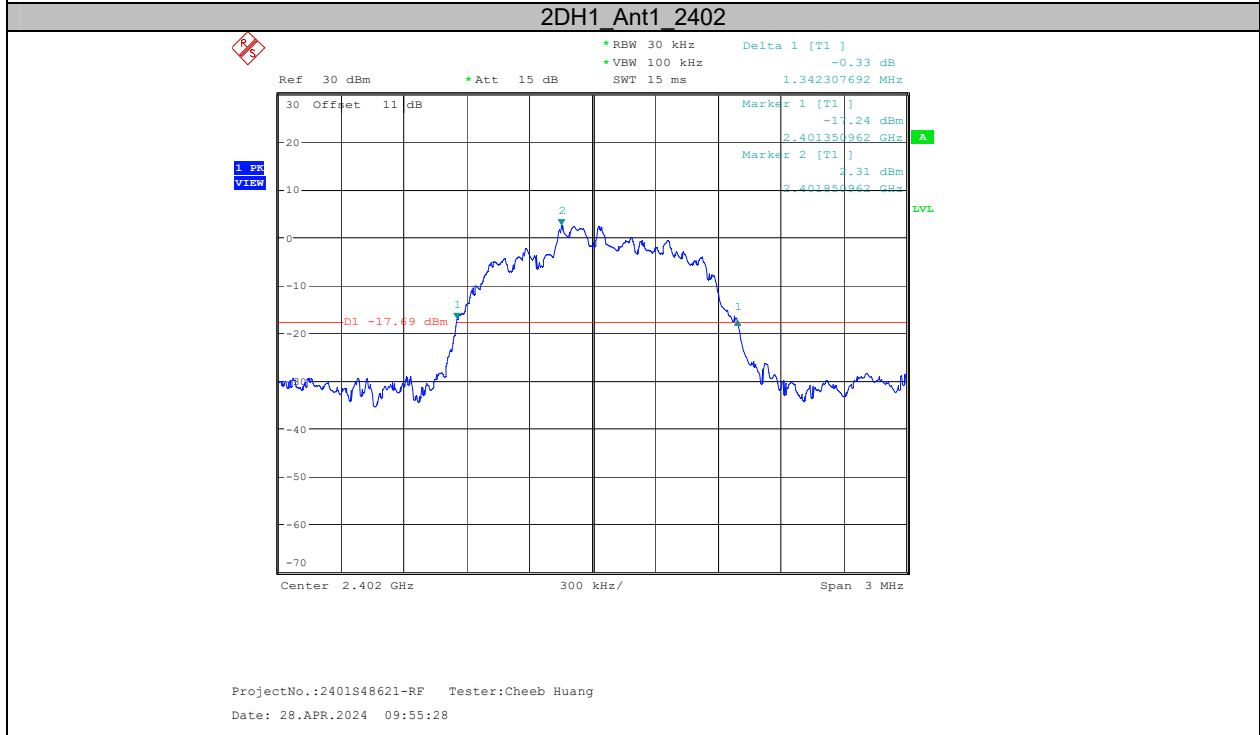
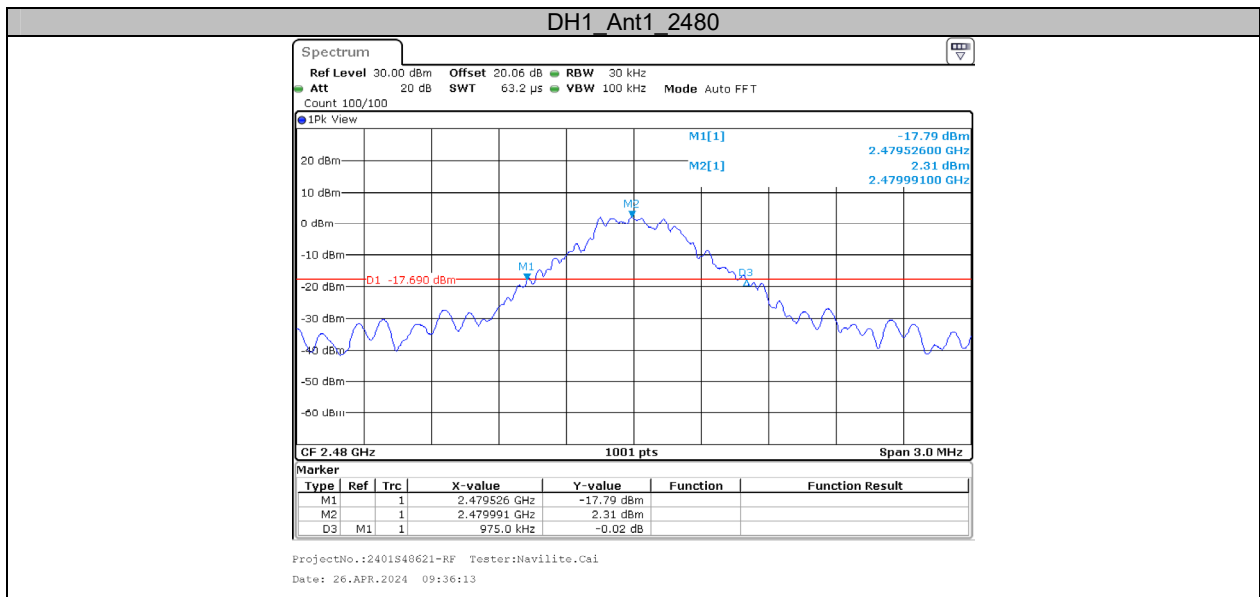

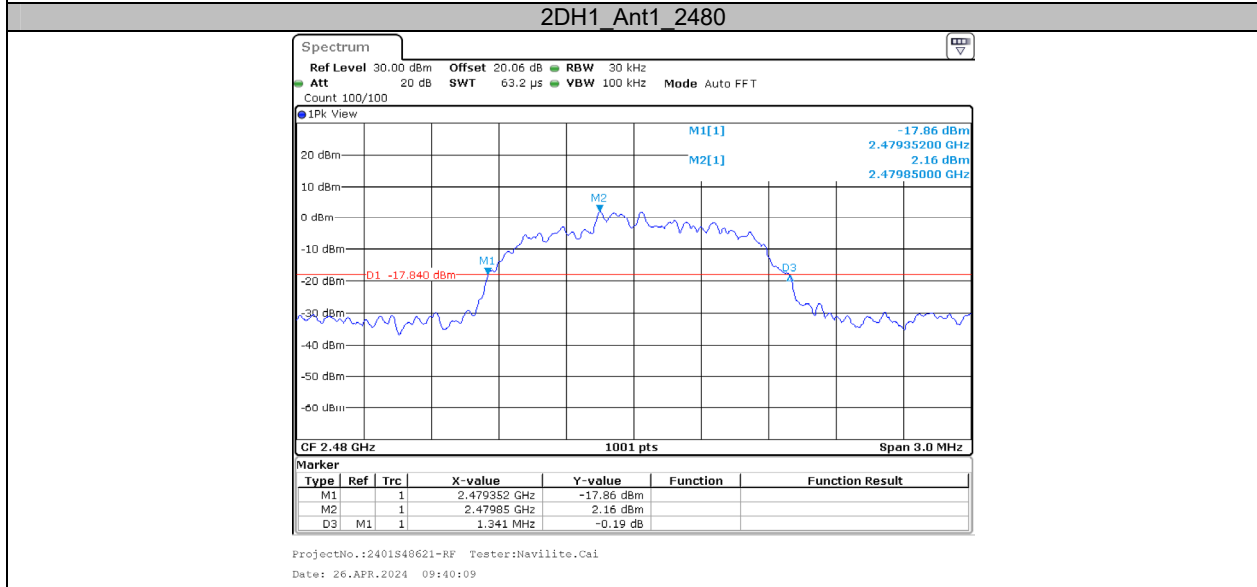
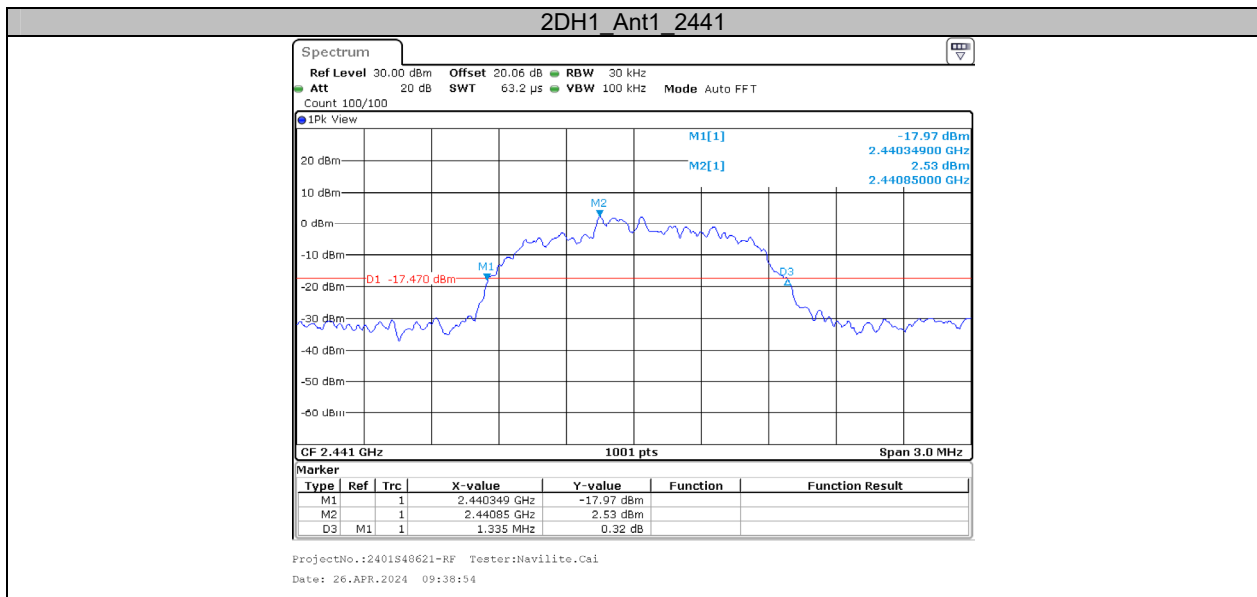

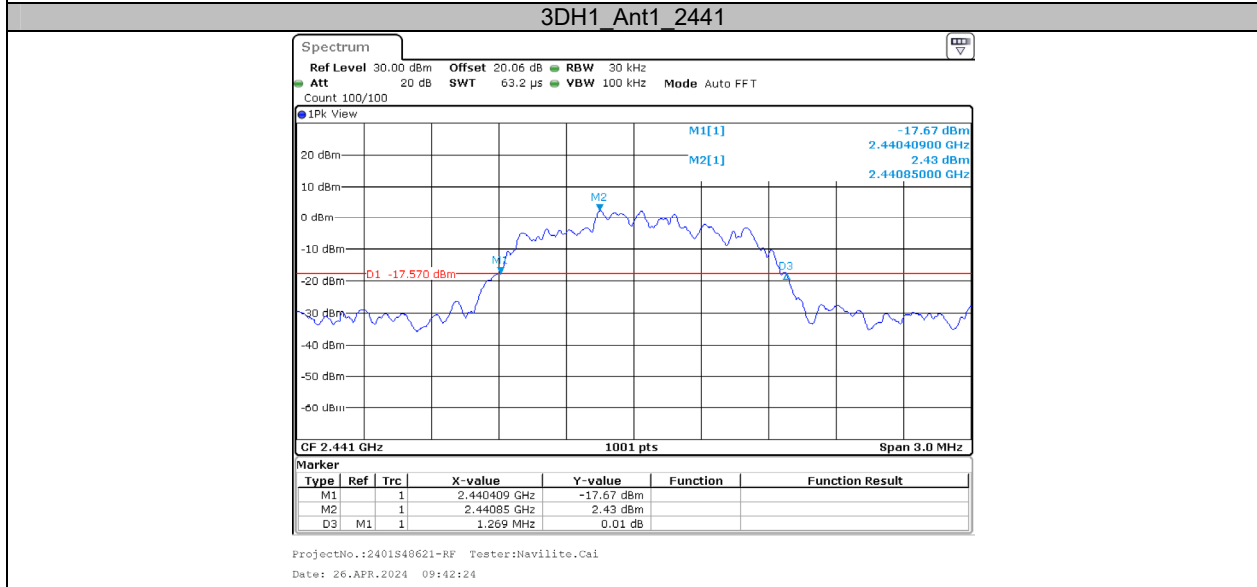
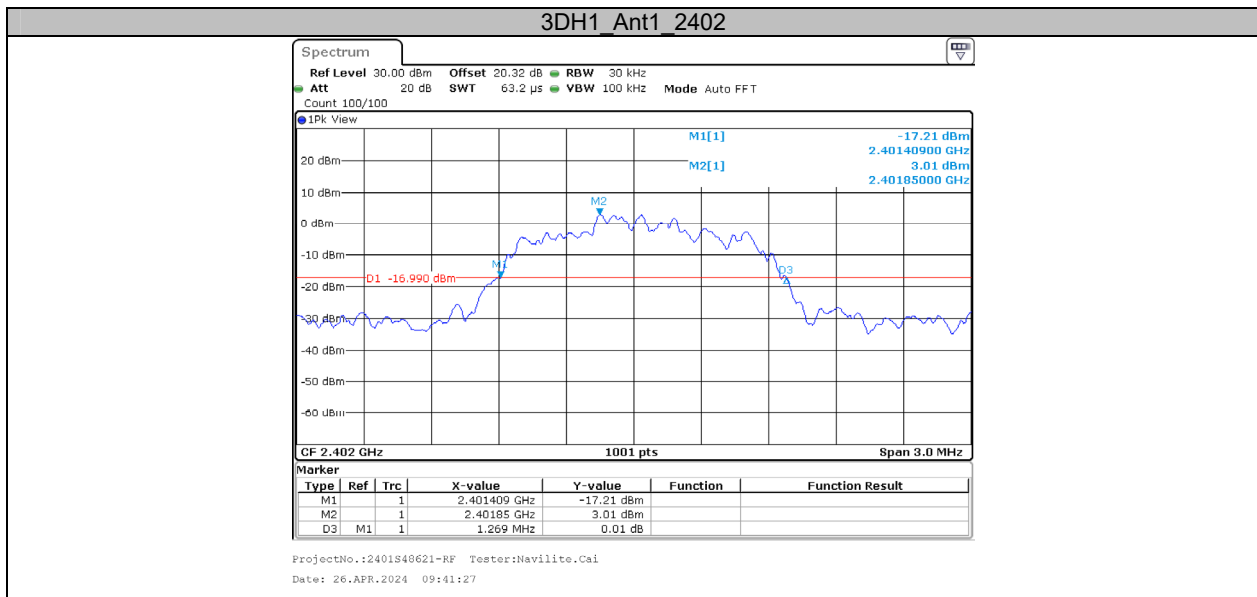

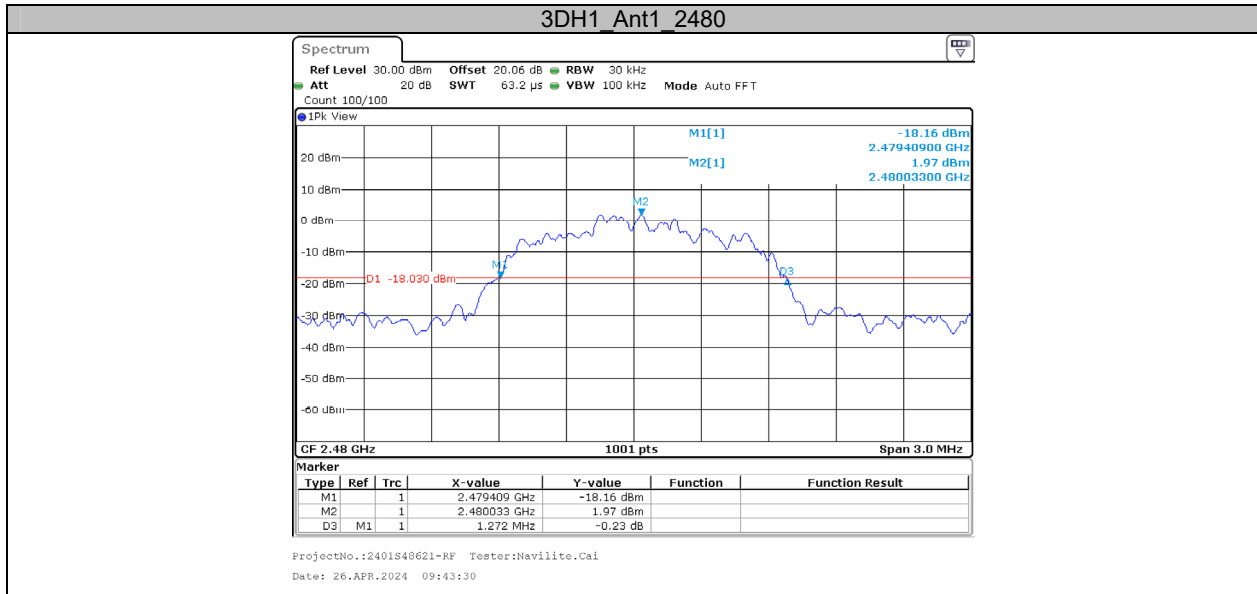

Appendix B: Occupied Channel Bandwidth

Test Result

Test Mode	Antenna	Frequency[MHz]	OCB [MHz]	FL[MHz]	FH[MHz]	Limit[MHz]	Verdict
DH1	Ant1	2402	0.887	2401.5804	2402.4675	---	---
		2441	0.884	2440.5804	2441.4645	---	---
		2480	0.875	2479.5834	2480.4585	---	---
2DH1	Ant1	2402	1.181	2401.4216	2402.6024	---	---
		2441	1.175	2440.4246	2441.5994	---	---
		2480	1.181	2479.4216	2480.6024	---	---
3DH1	Ant1	2402	1.178	2401.4396	2402.6174	---	---
		2441	1.175	2440.4396	2441.6144	---	---
		2480	1.178	2479.4396	2480.6174	---	---

Test Graphs

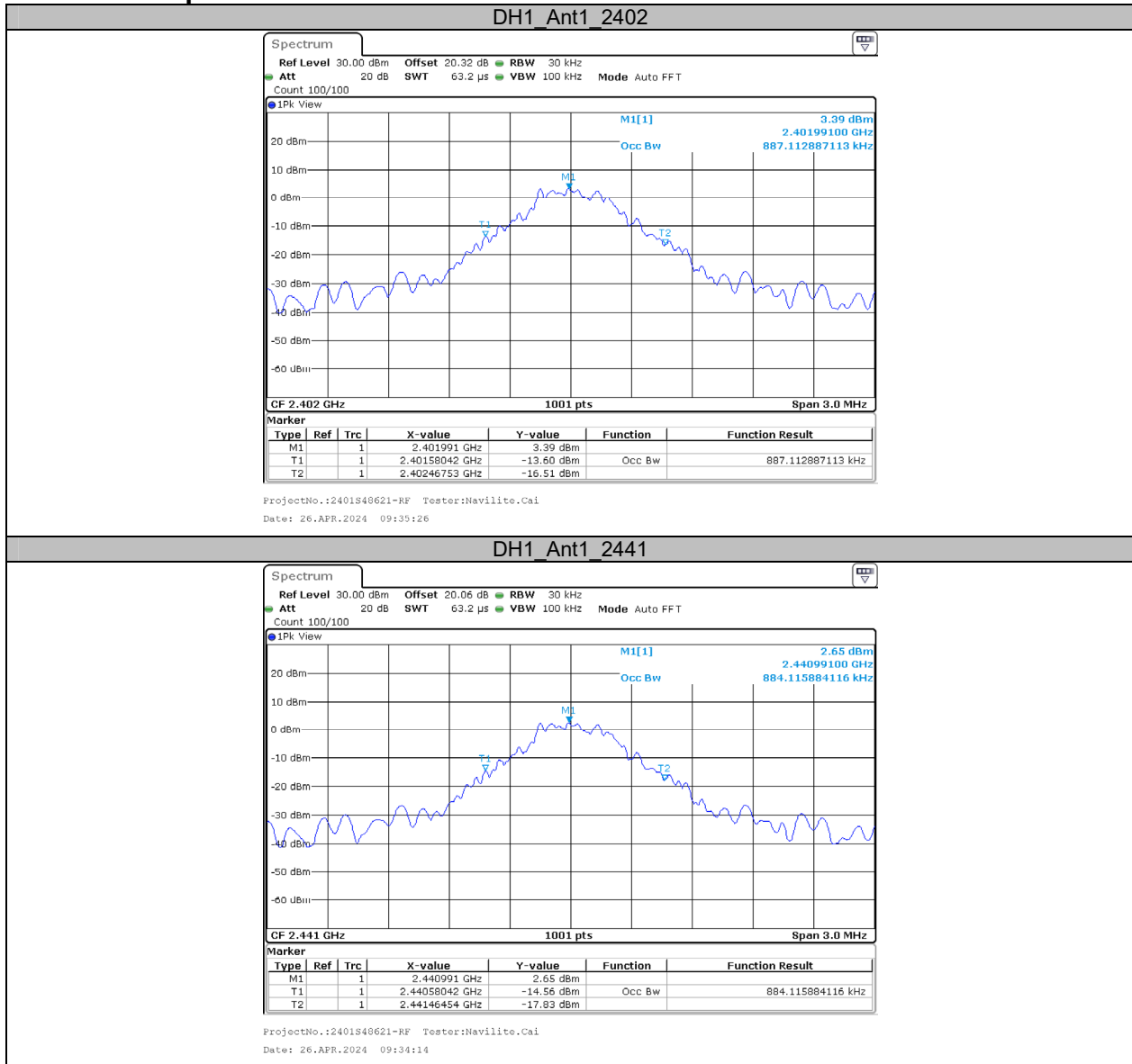

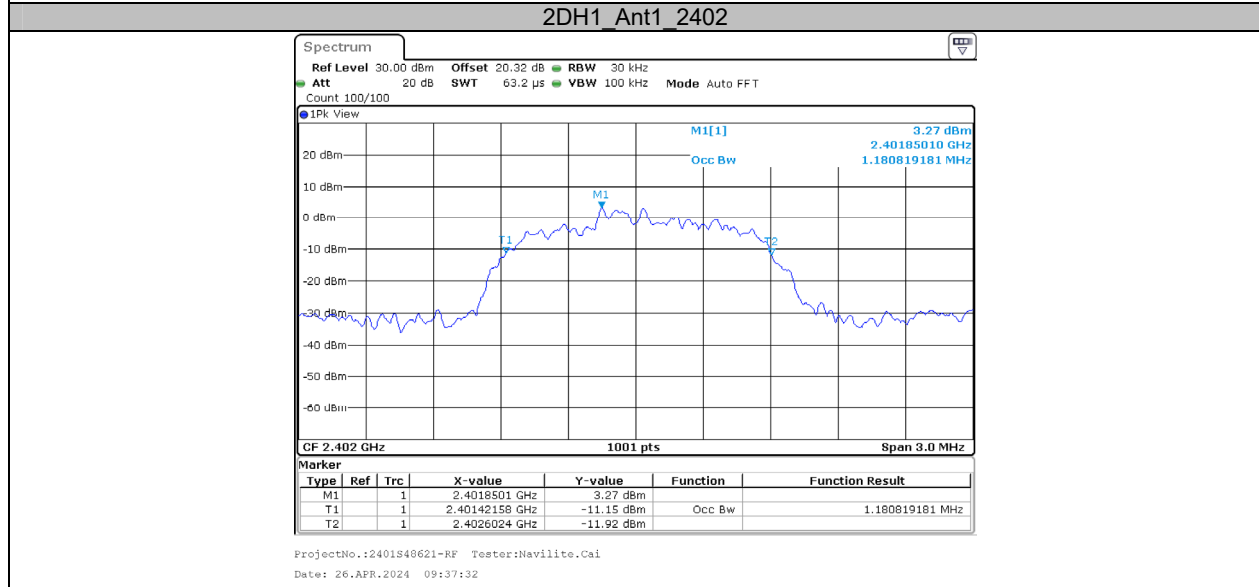
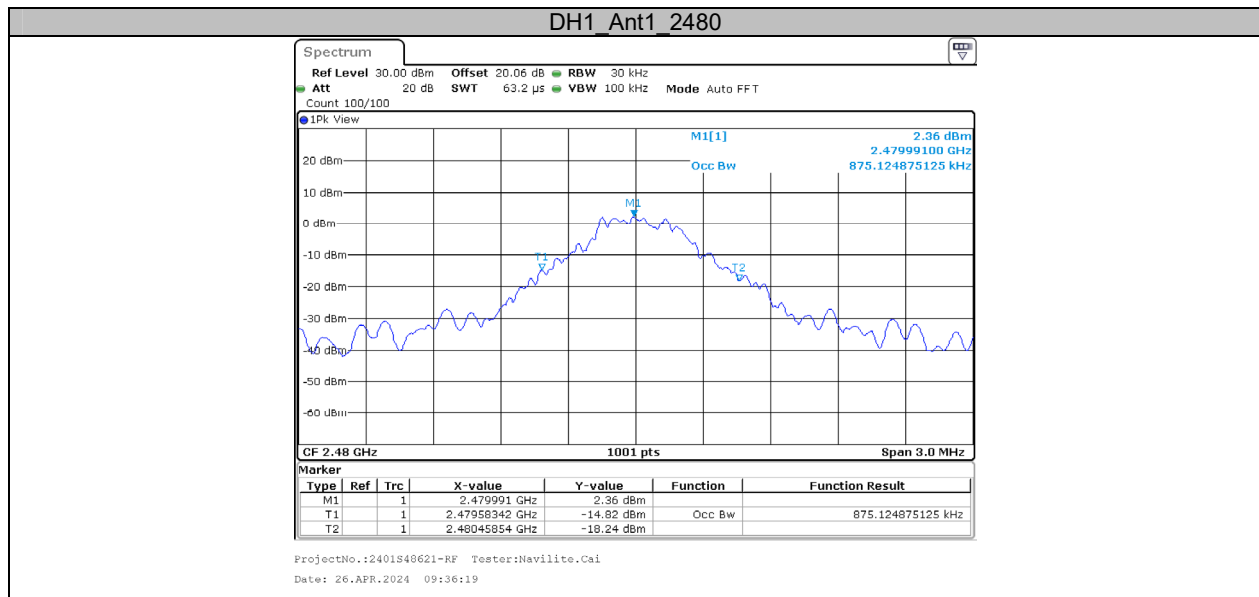

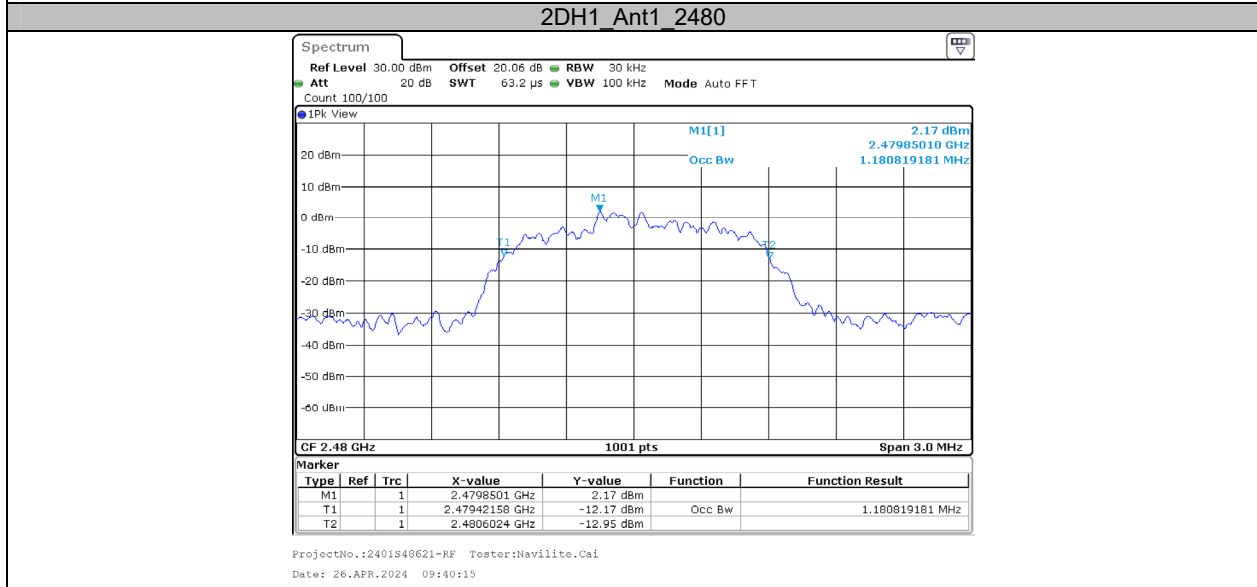
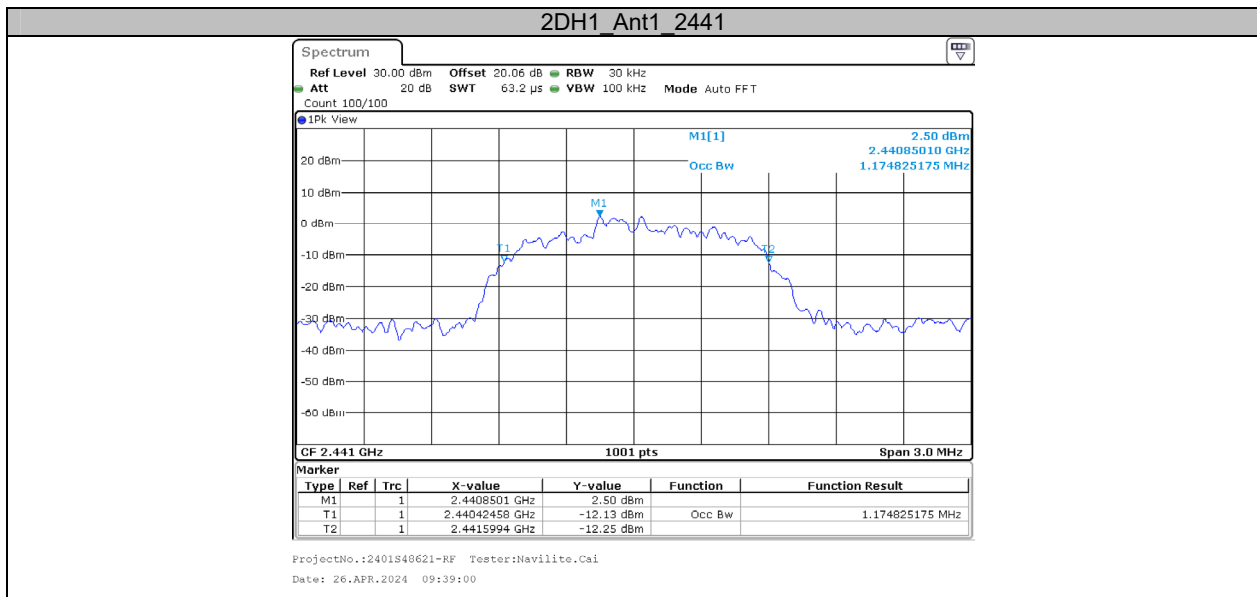

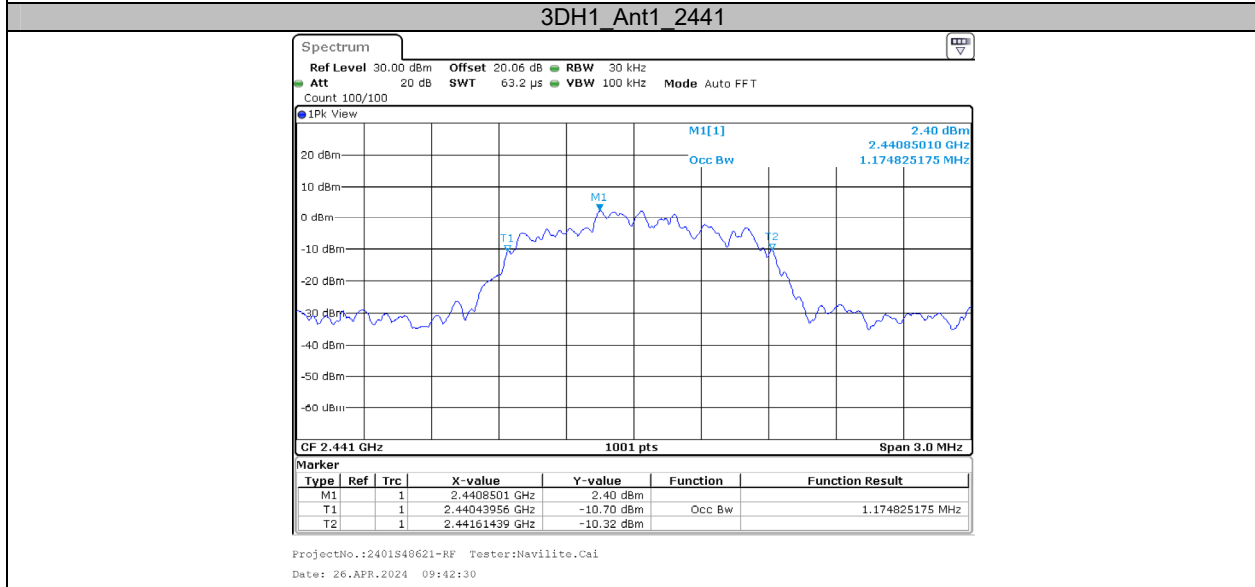
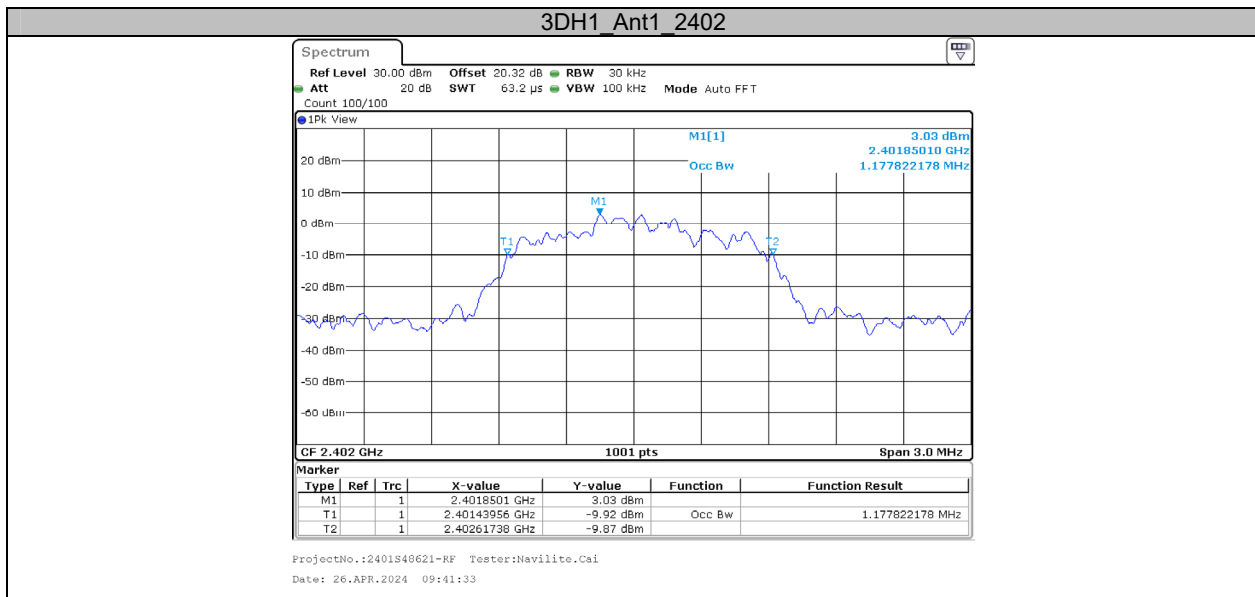

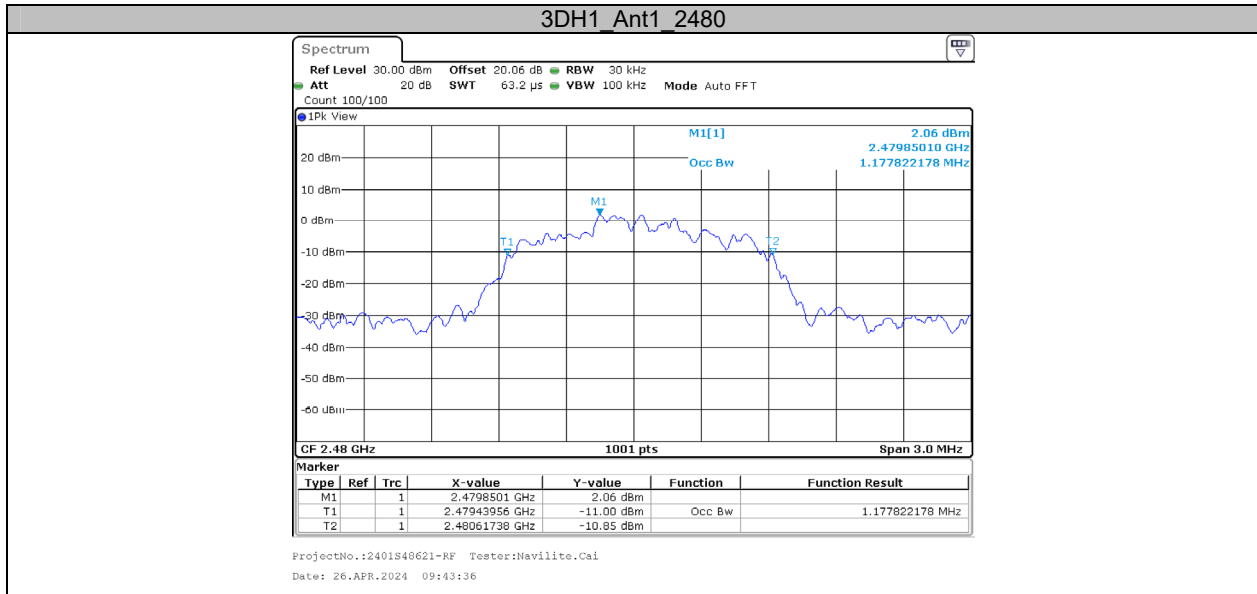

Appendix C: Maximum Conducted Output Power

Test Result Peak

Test Mode	Antenna	Frequency[MHz]	Conducted Peak Power[dBm]	Conducted Limit[dBm]	Verdict
DH1	Ant1	2402	7.89	≤20.97	PASS
		2441	7.18	≤20.97	PASS
		2480	6.86	≤20.97	PASS
2DH1	Ant1	2402	8.32	≤20.97	PASS
		2441	7.63	≤20.97	PASS
		2480	7.28	≤20.97	PASS
3DH1	Ant1	2402	8.54	≤20.97	PASS
		2441	7.82	≤20.97	PASS
		2480	7.50	≤20.97	PASS

Test Graphs

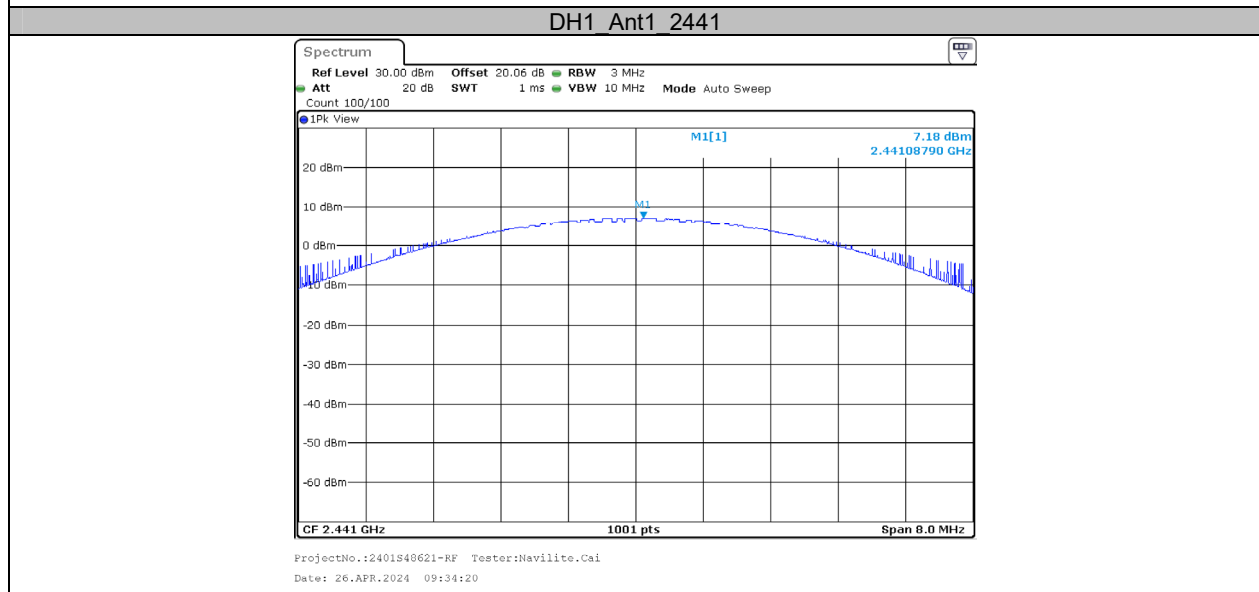
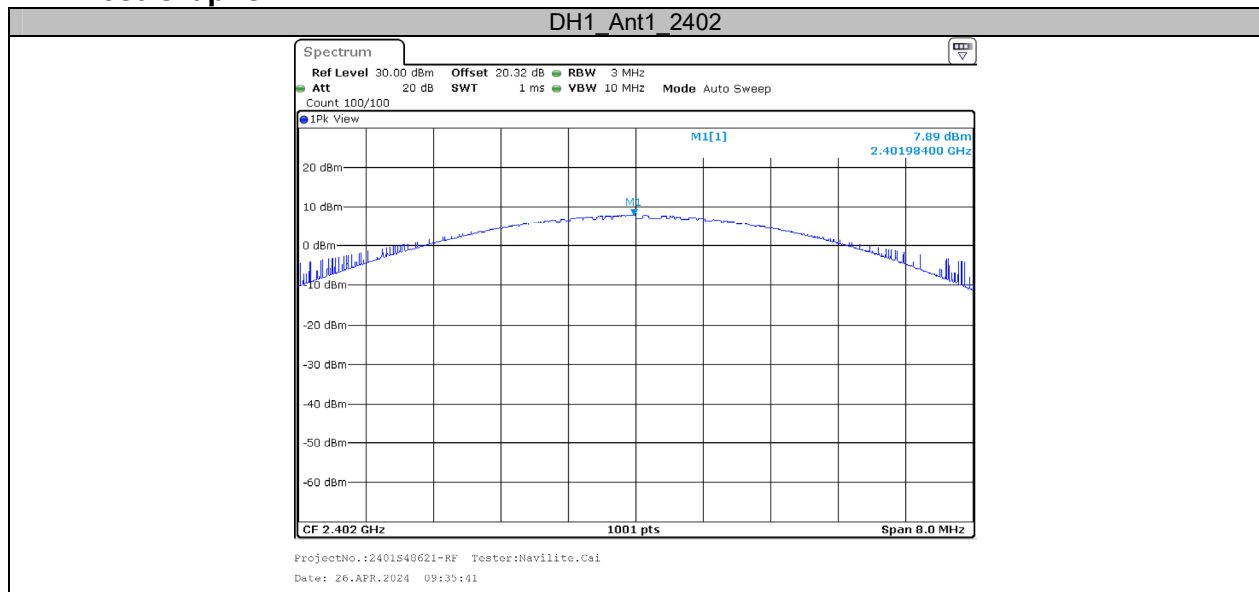

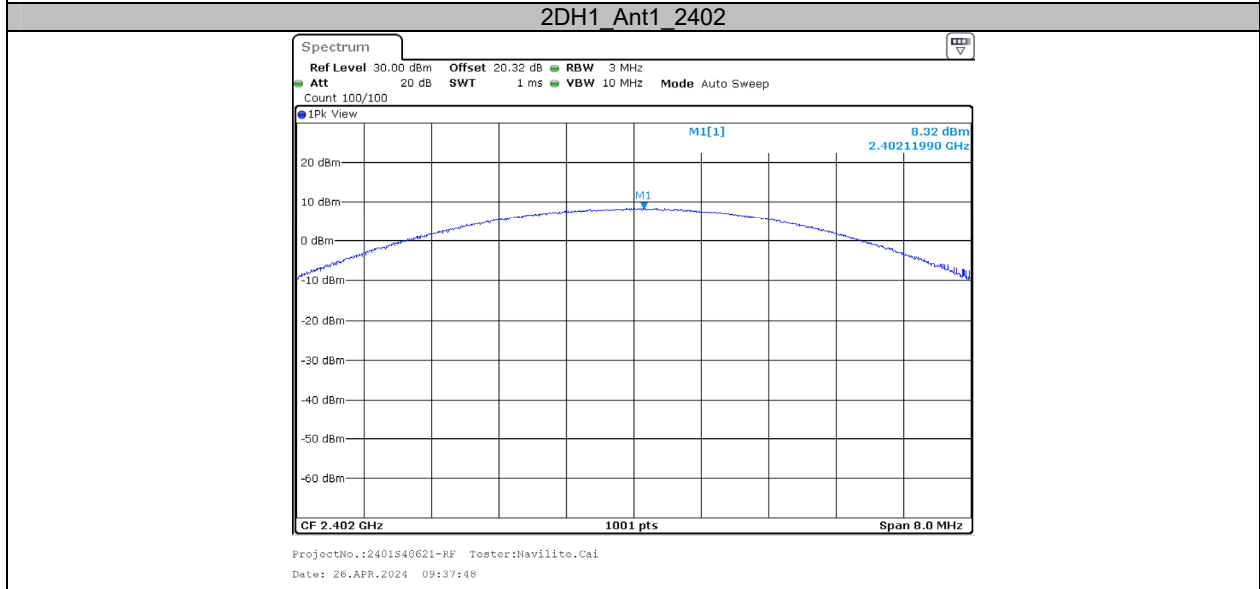
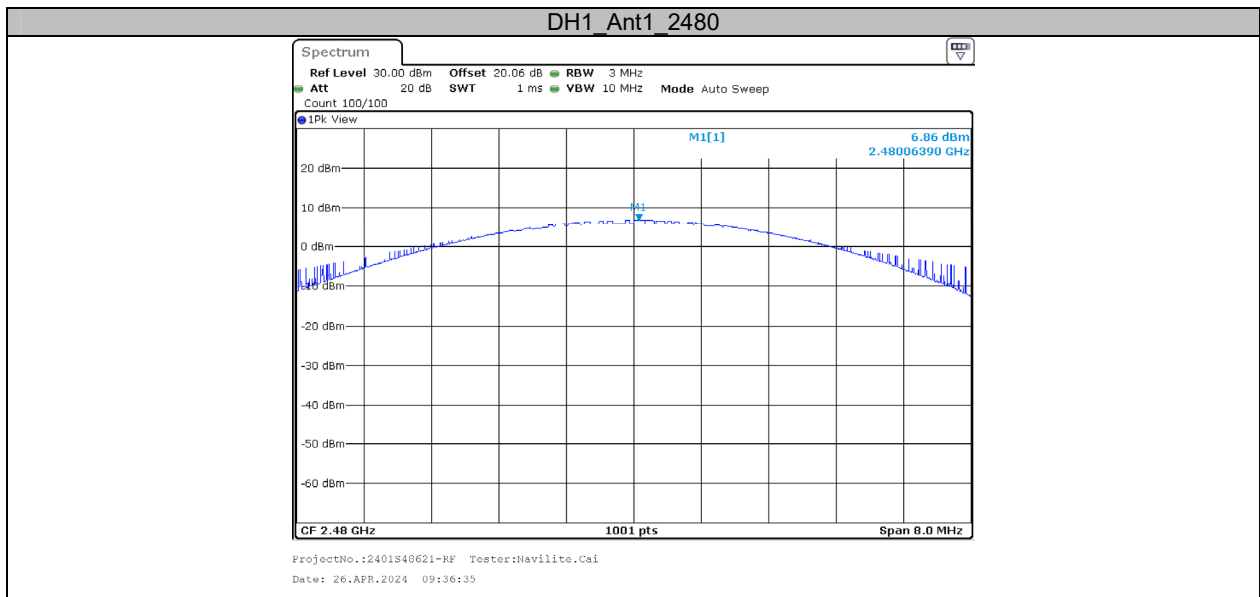

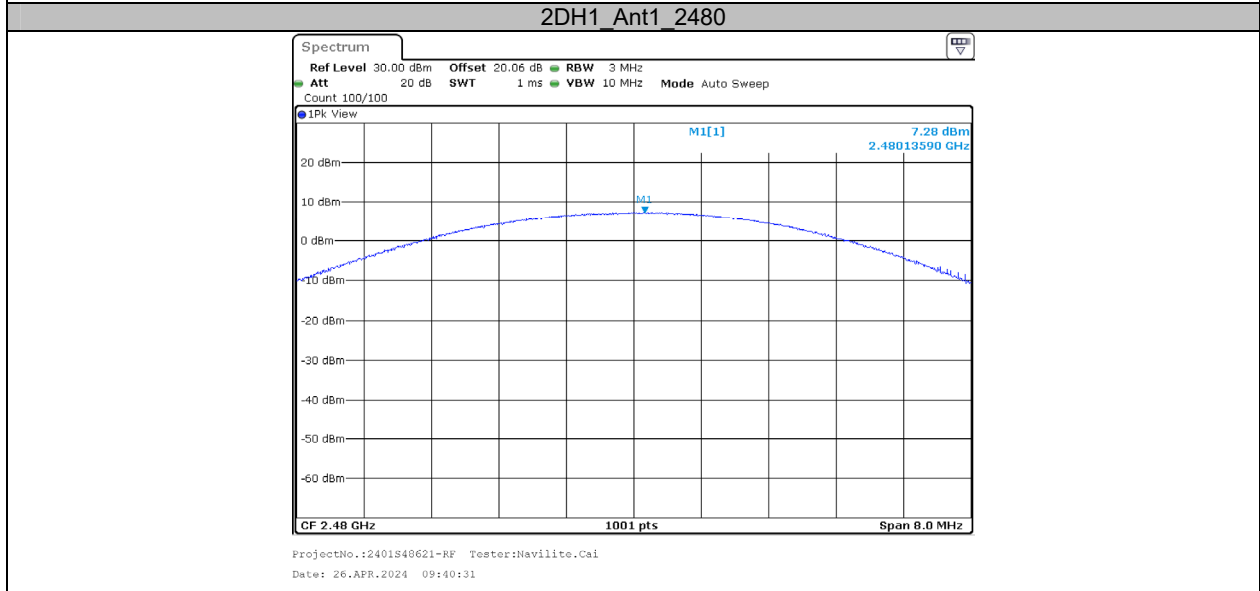
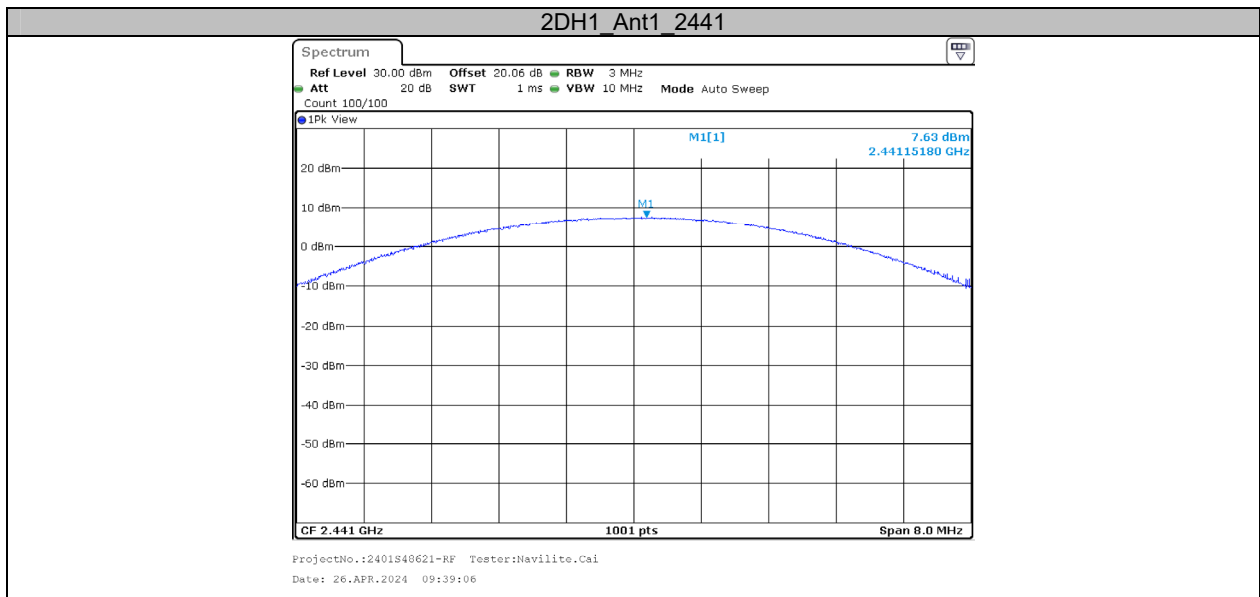

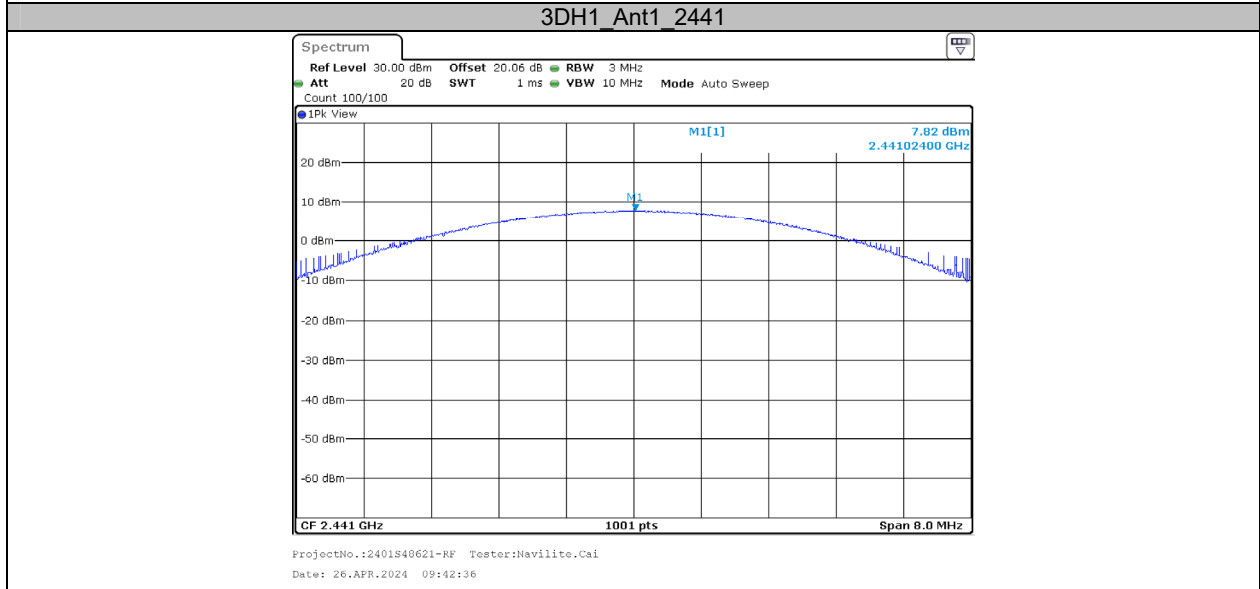
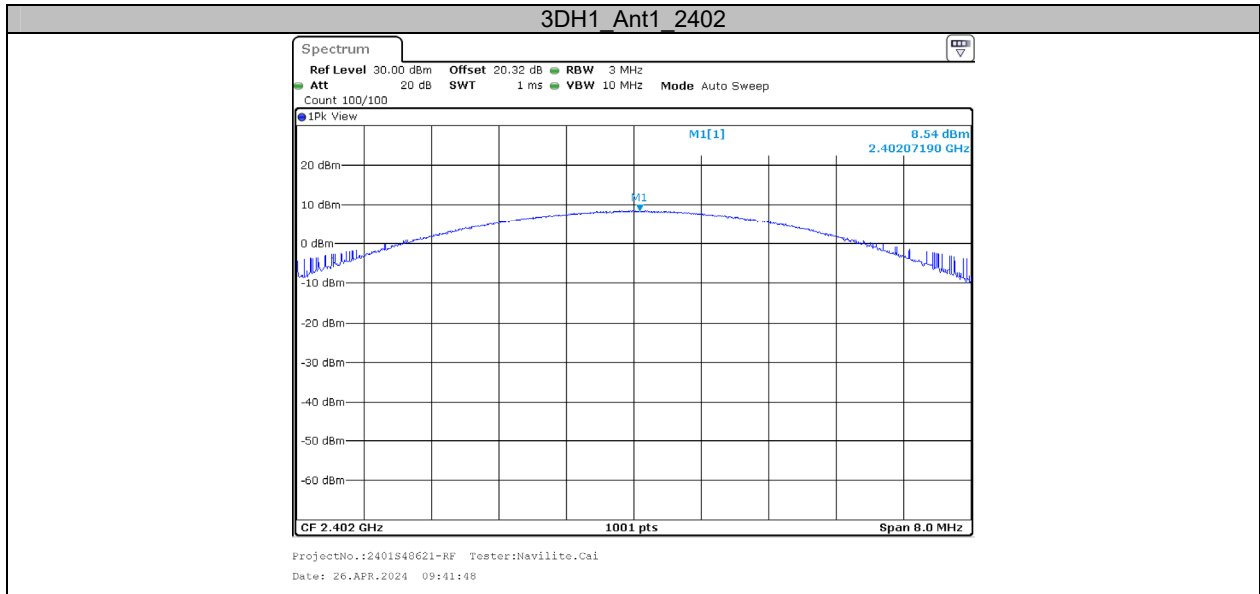

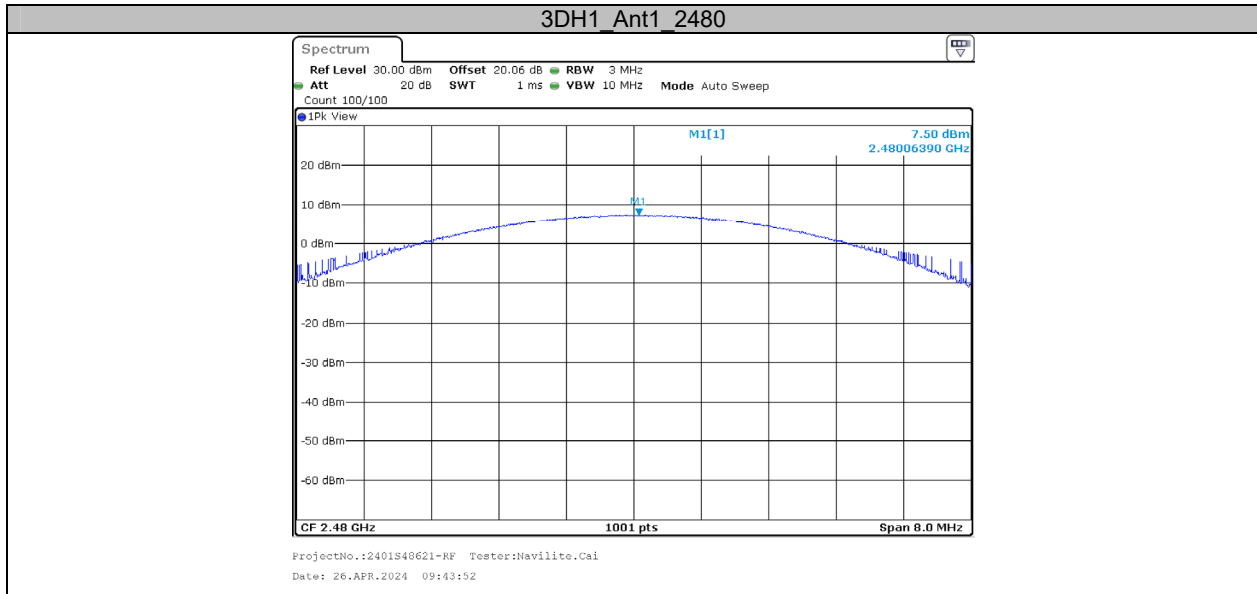

Appendix D: Carrier Frequency Separation**Test Result**

Test Mode	Antenna	Frequency[MHz]	Result[MHz]	Limit[MHz]	Verdict
DH1	Ant1	Hop	0.988	≥ 0.654	PASS
2DH1	Ant1	Hop	1.000	≥ 0.890	PASS
3DH1	Ant1	Hop	1.000	≥ 0.846	PASS

Test Graphs

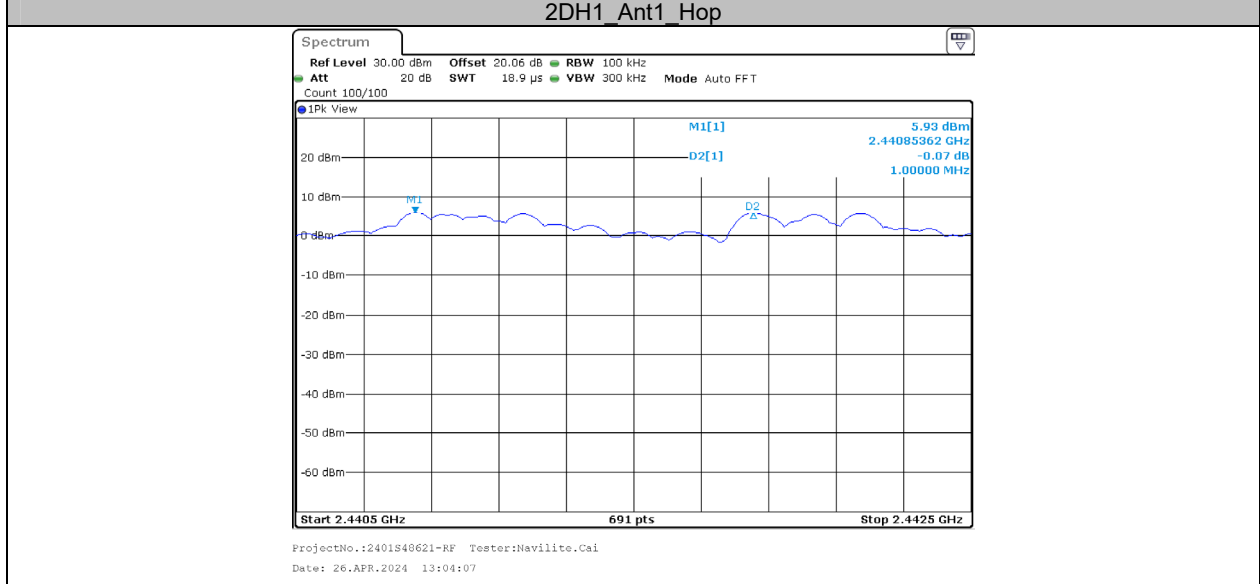
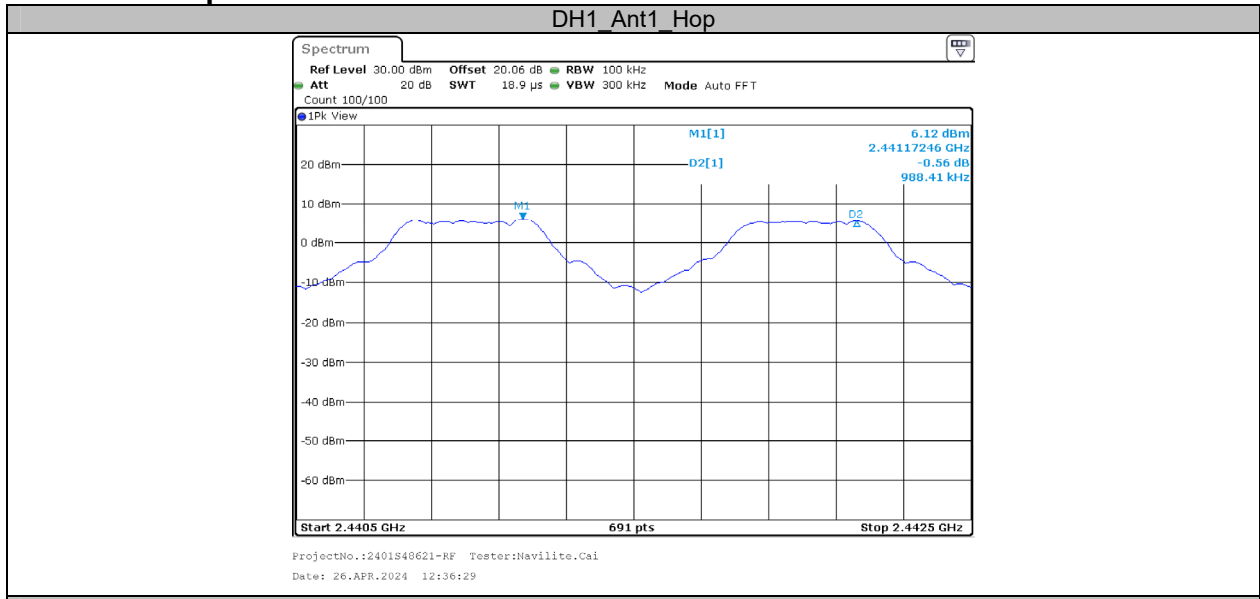

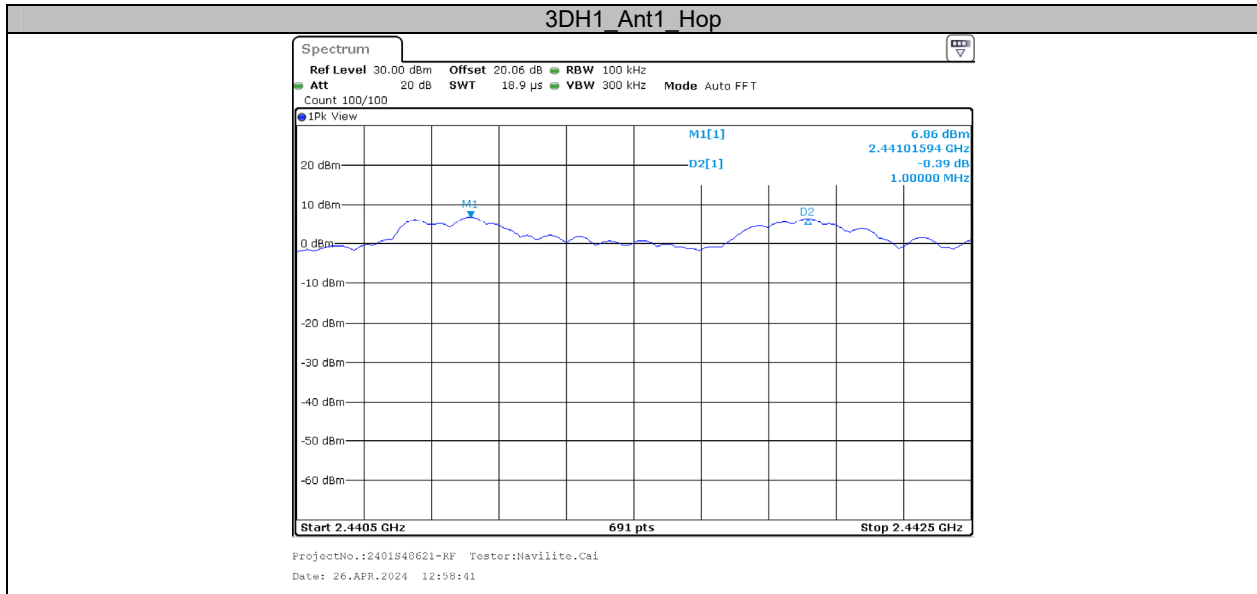

Appendix E: Time of Occupancy**Test Result**

Test Mode	Antenna	Frequency[MHz]	Burst Width [ms]	Total Hops [Num]	Result[s]	Limit[s]	Verdict
DH1	Ant1	Hop	0.375	300	0.113	≤0.4	PASS
DH3	Ant1	Hop	1.624	160	0.260	≤0.4	PASS
DH5	Ant1	Hop	2.864	130	0.372	≤0.4	PASS
2DH1	Ant1	Hop	0.385	290	0.112	≤0.4	PASS
2DH3	Ant1	Hop	1.629	180	0.293	≤0.4	PASS
2DH5	Ant1	Hop	2.869	130	0.373	≤0.4	PASS
3DH1	Ant1	Hop	0.388	260	0.101	≤0.4	PASS
3DH3	Ant1	Hop	1.630	170	0.277	≤0.4	PASS
3DH5	Ant1	Hop	2.874	130	0.374	≤0.4	PASS

Note 1: A period time=0.4*79=31.6(S), Result=Burst Width*Total hops

Note 2: Total hops=Hopping Number in 3.16s*10

Note 3: Hopping Number in 3.16s=Total of highest signals in 3.16s(Second high signals were other channel)

Test Graphs

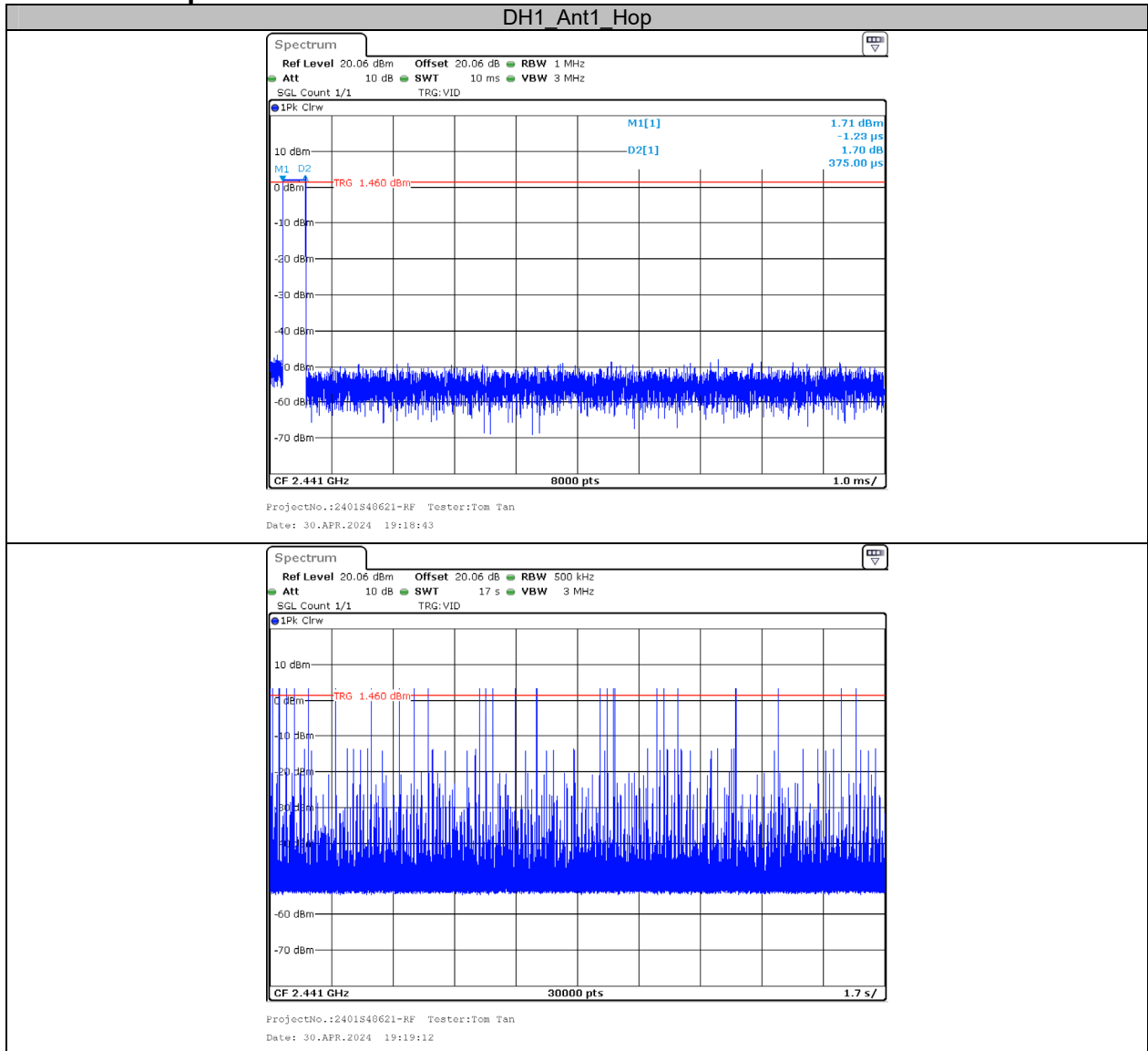

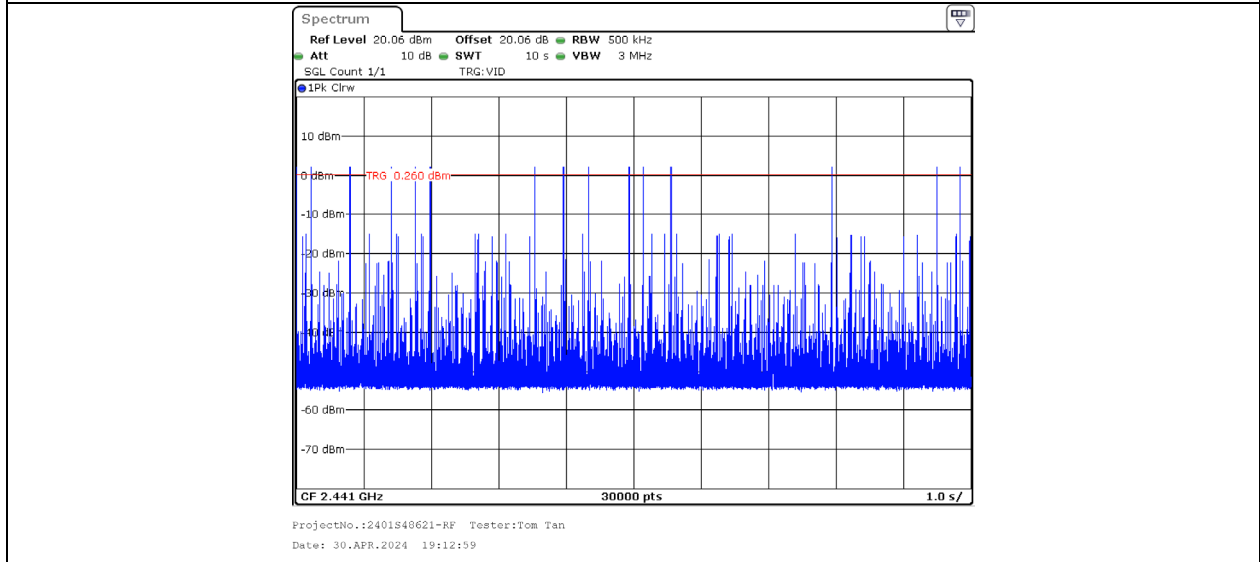
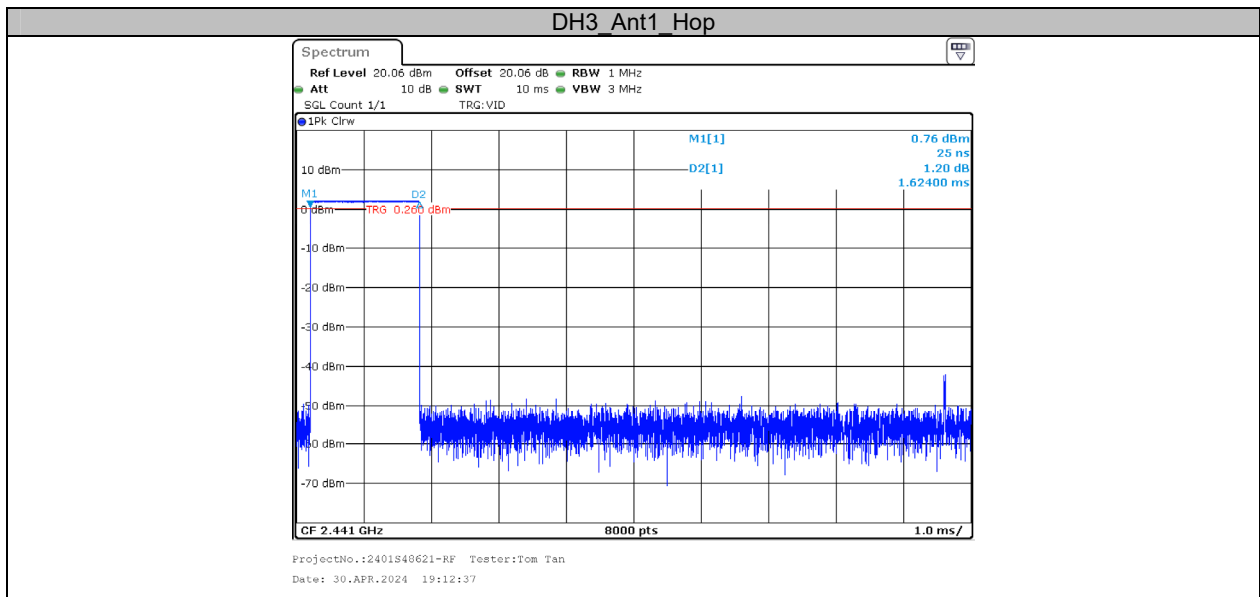

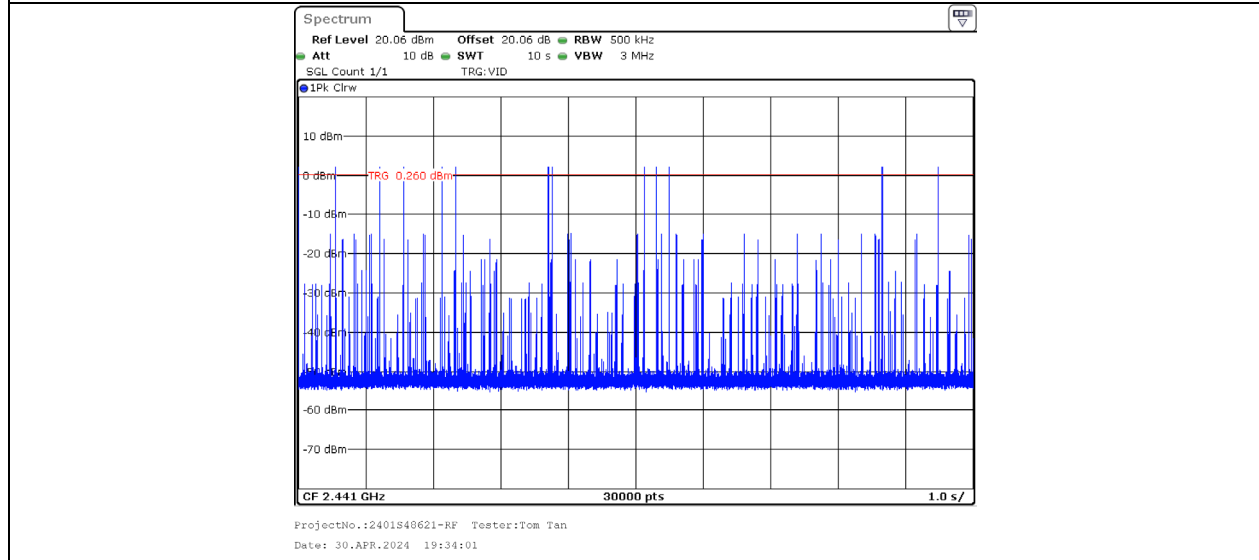
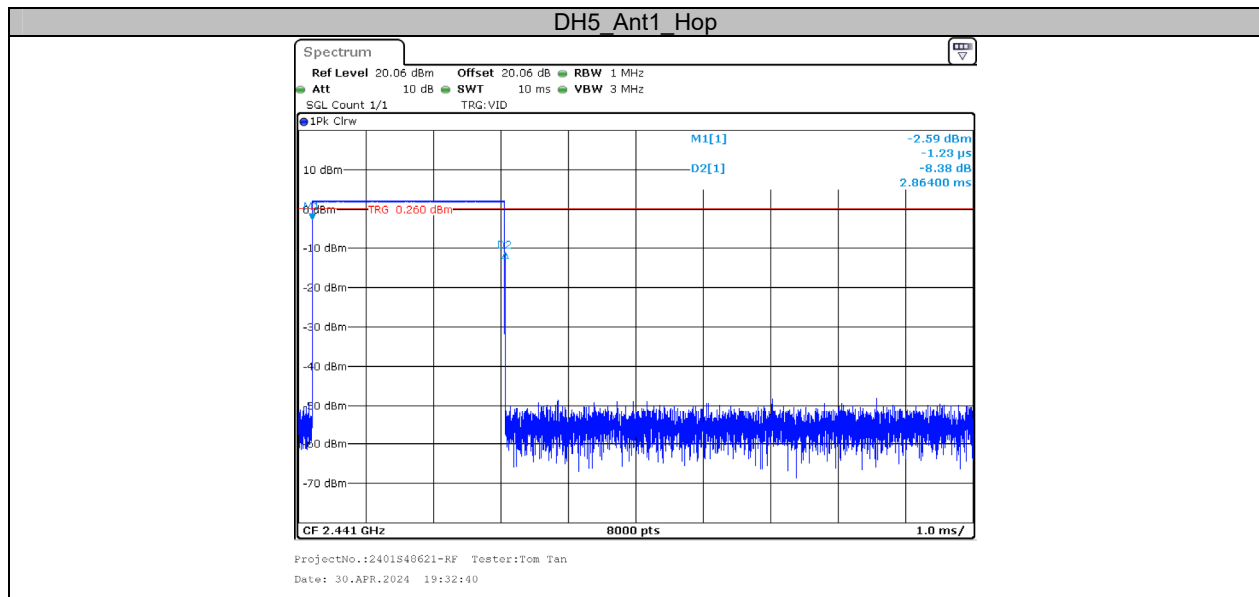

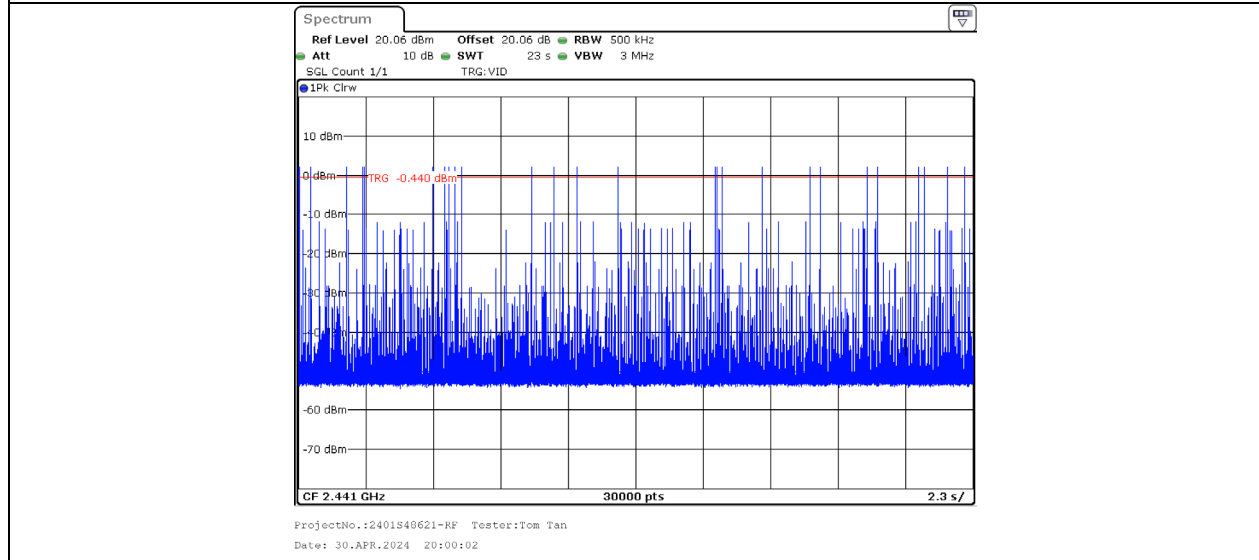
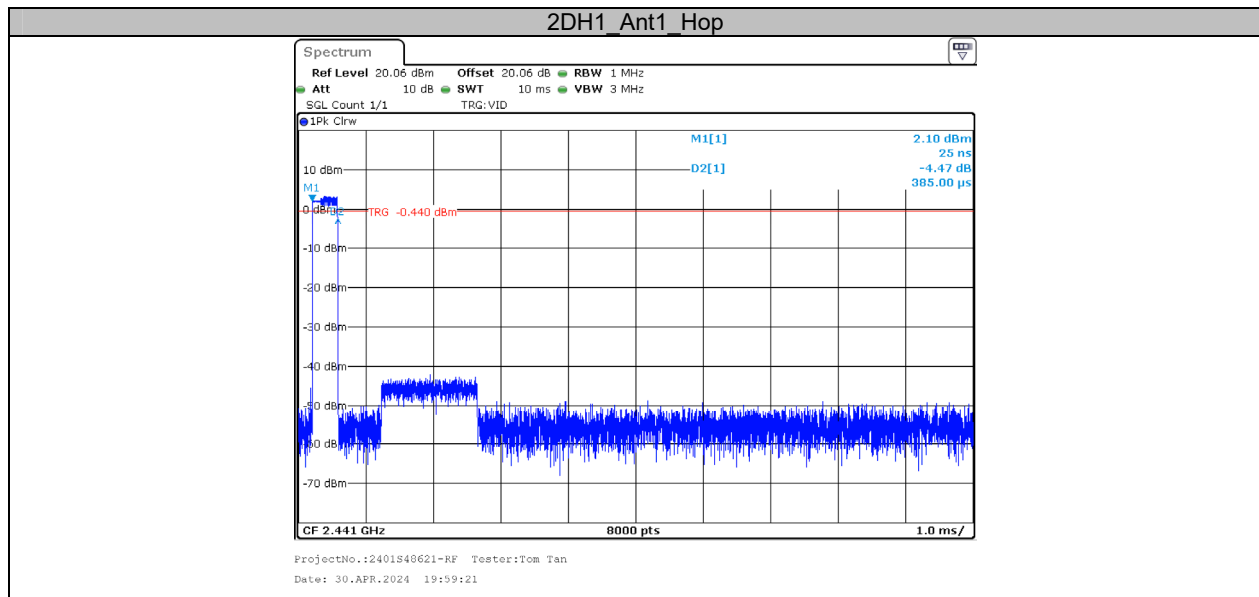

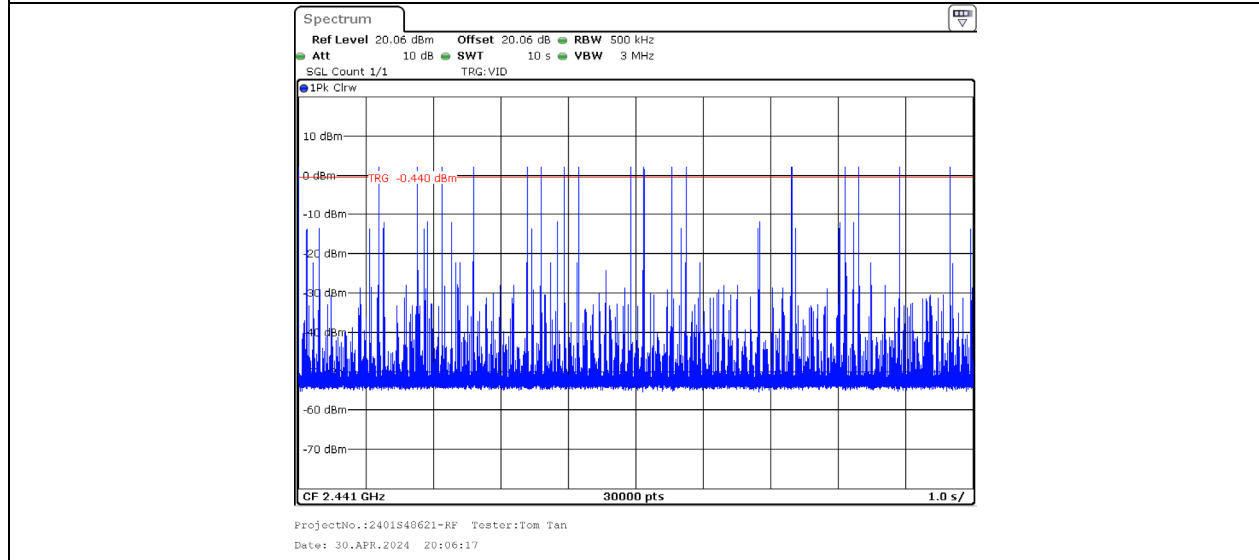
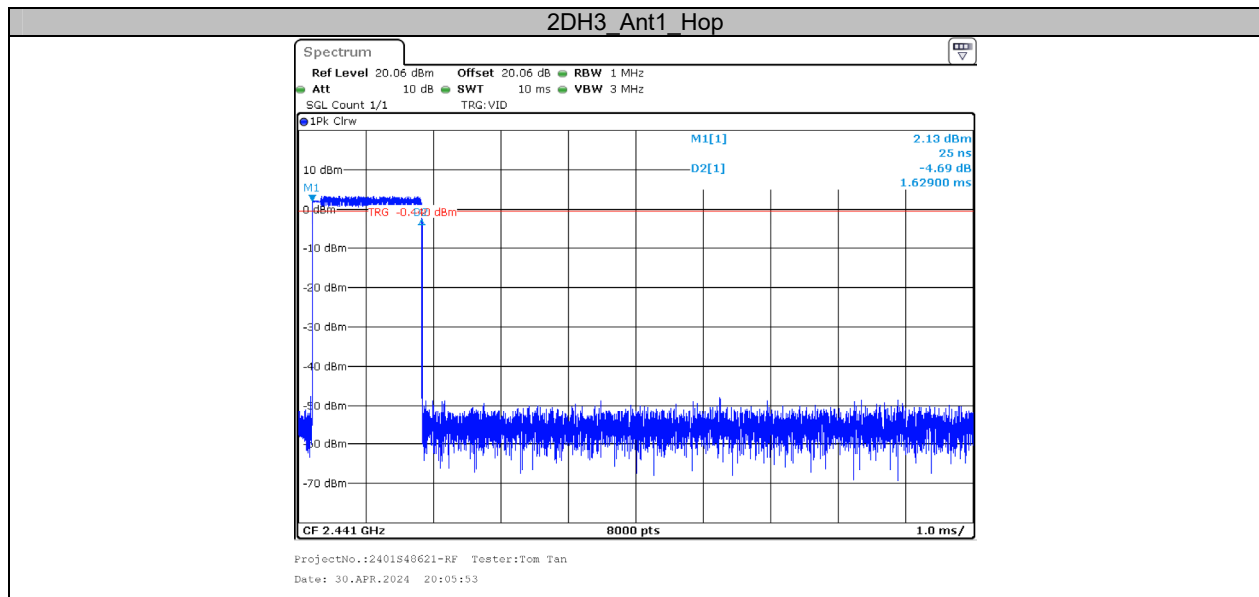

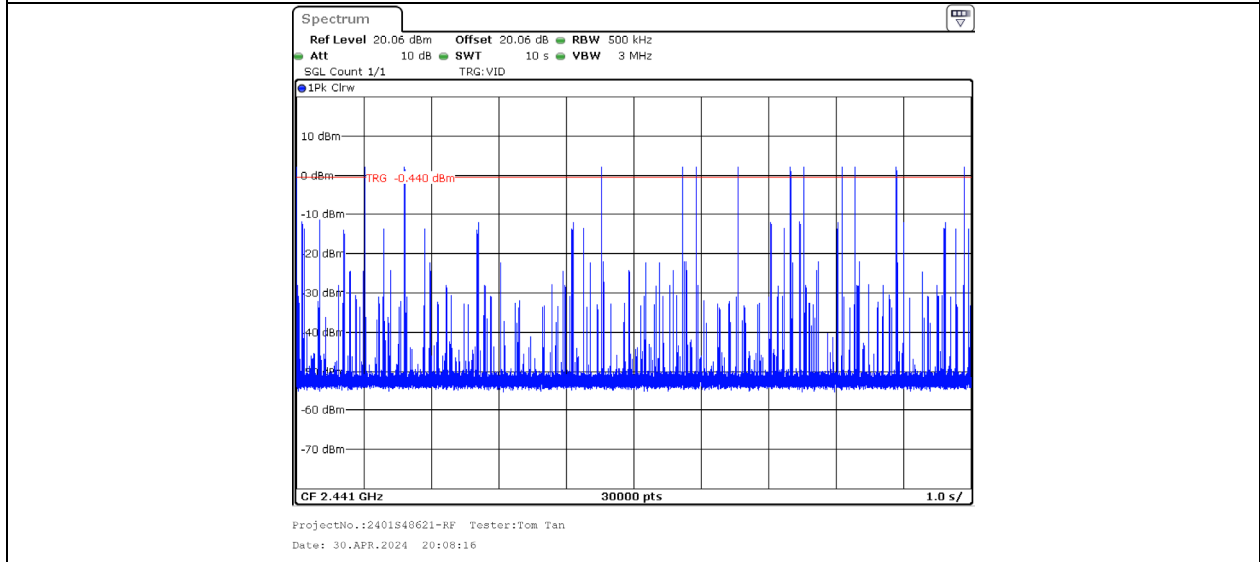
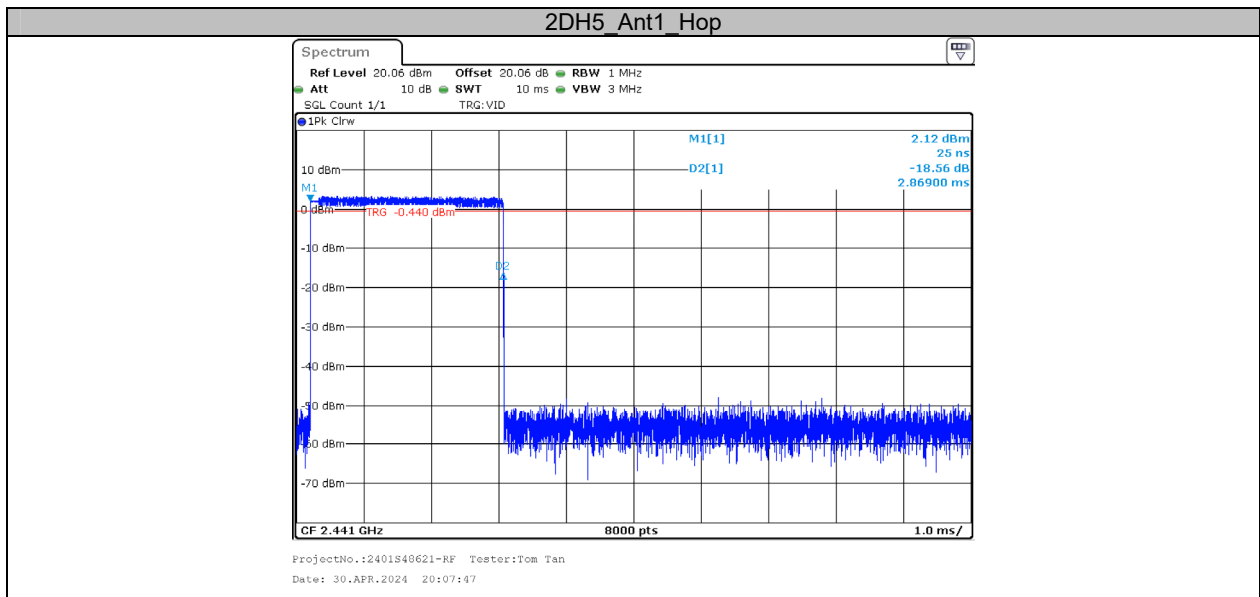

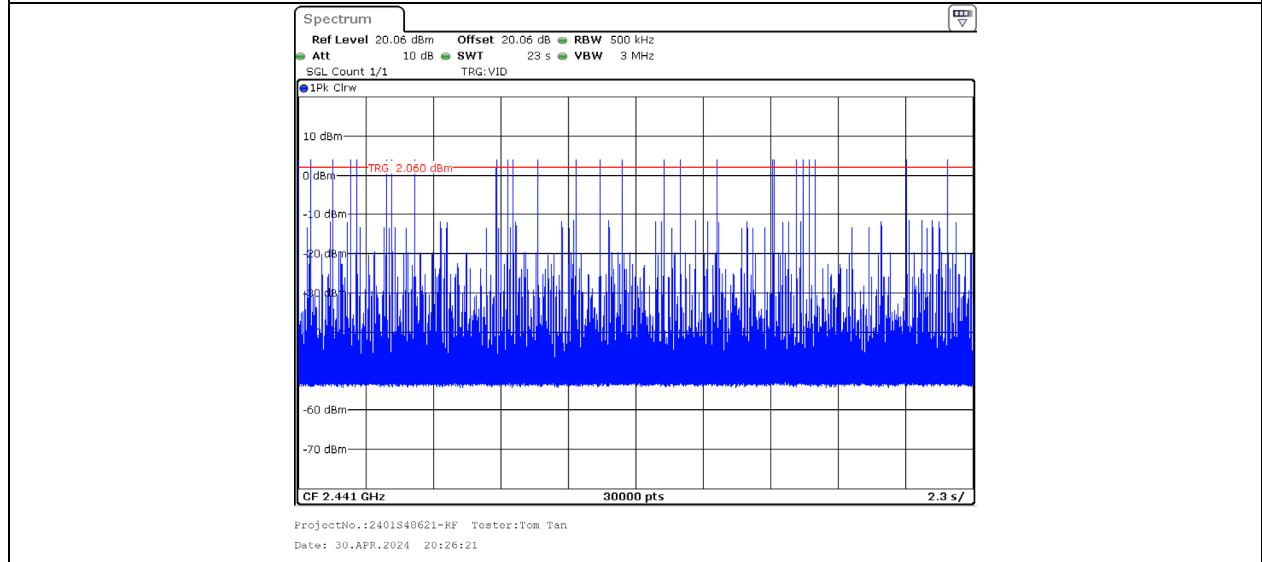
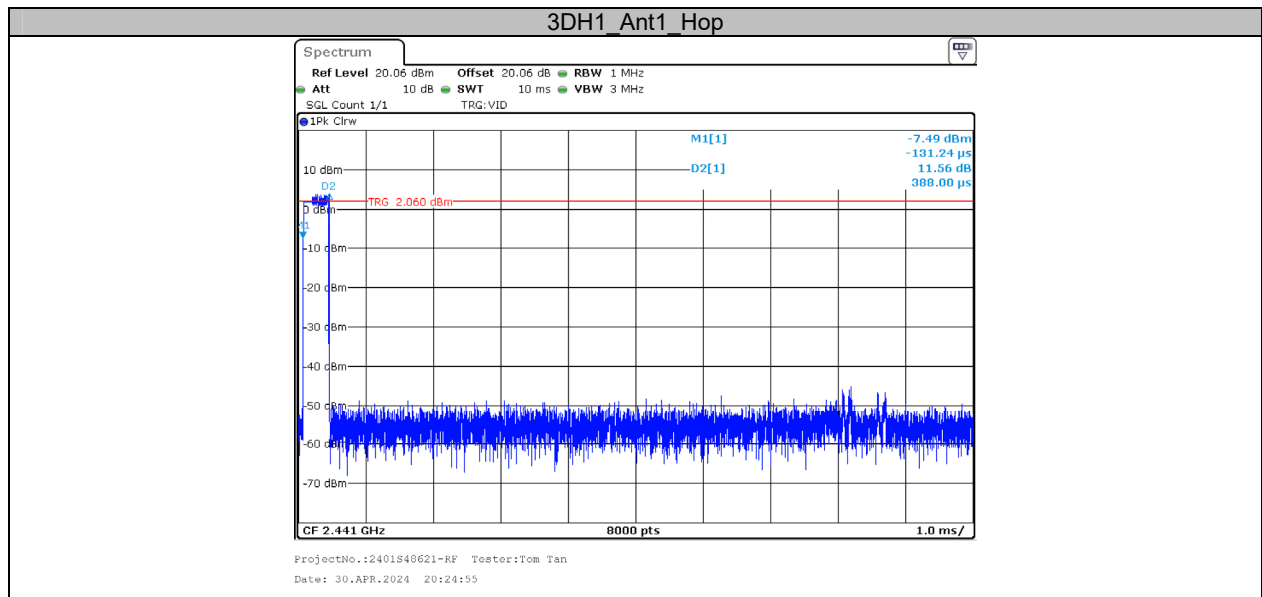

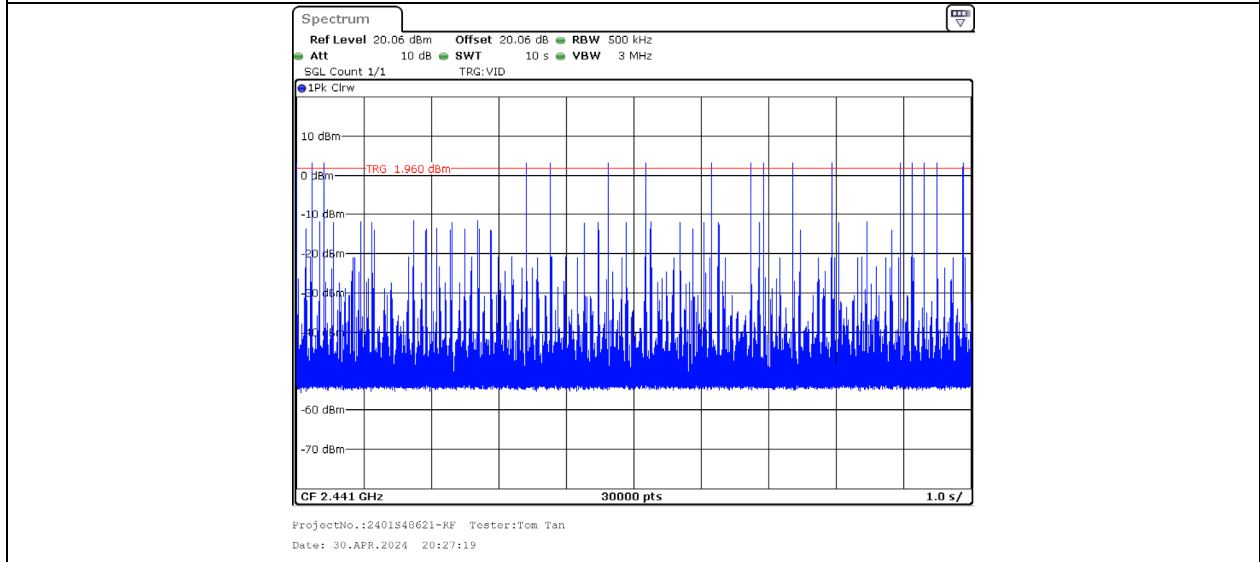
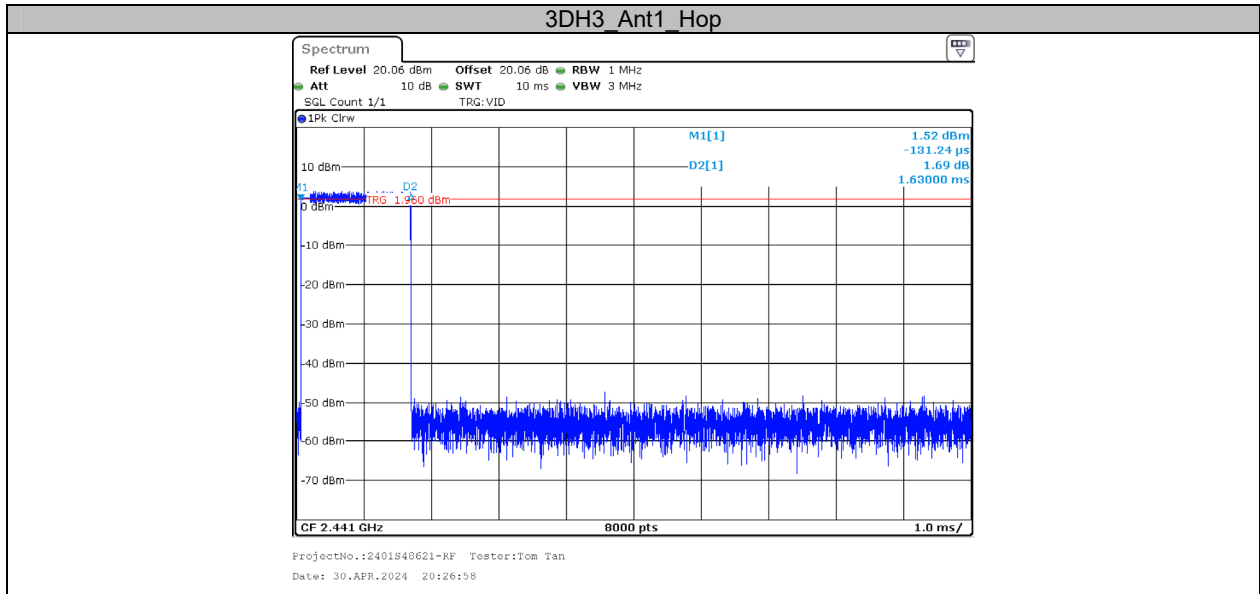

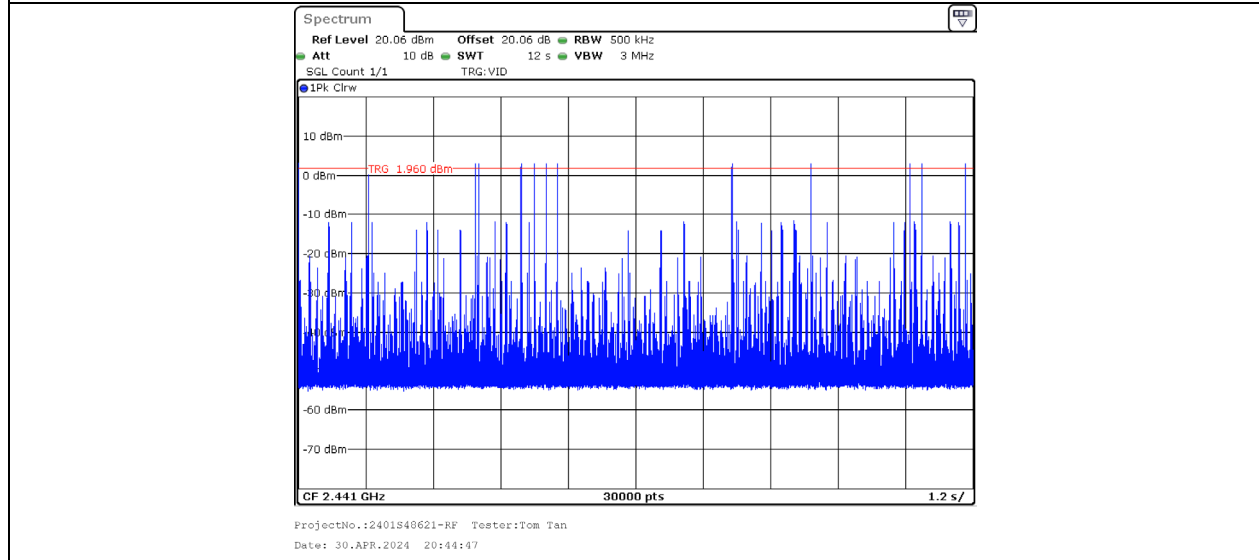
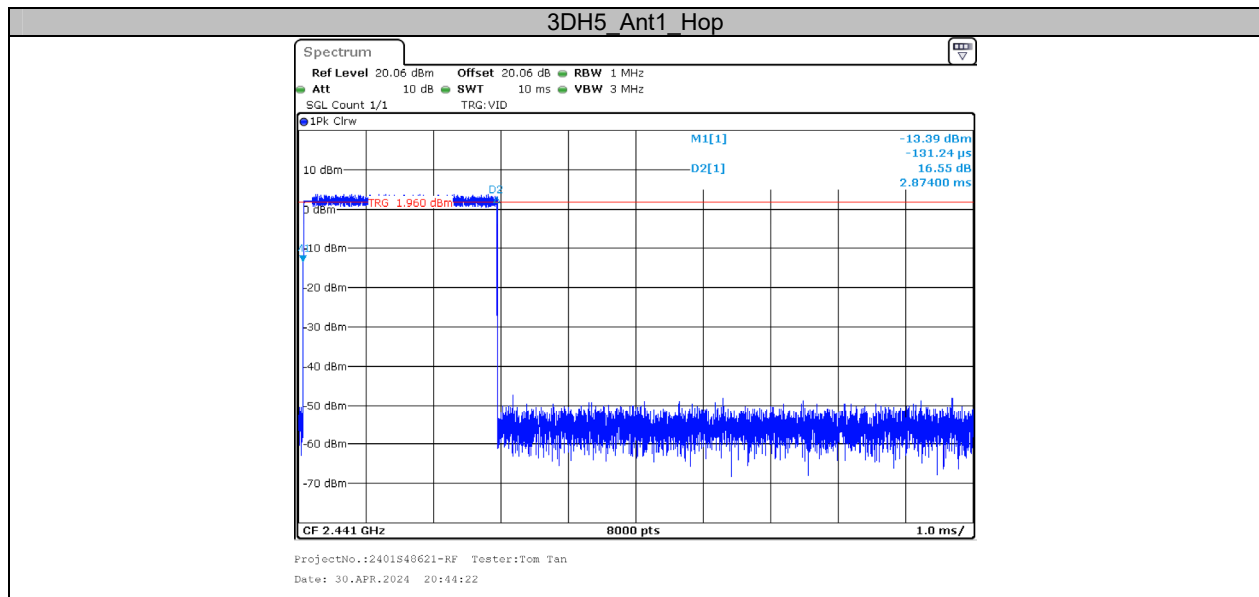

Appendix F: Number of Hopping Channels**Test Result**

Test Mode	Antenna	Frequency[MHz]	Result[Num]	Limit[Num]	Verdict
DH1	Ant1	Hop	79	≥ 15	PASS
2DH1	Ant1	Hop	79	≥ 15	PASS
3DH1	Ant1	Hop	79	≥ 15	PASS

Test Graphs

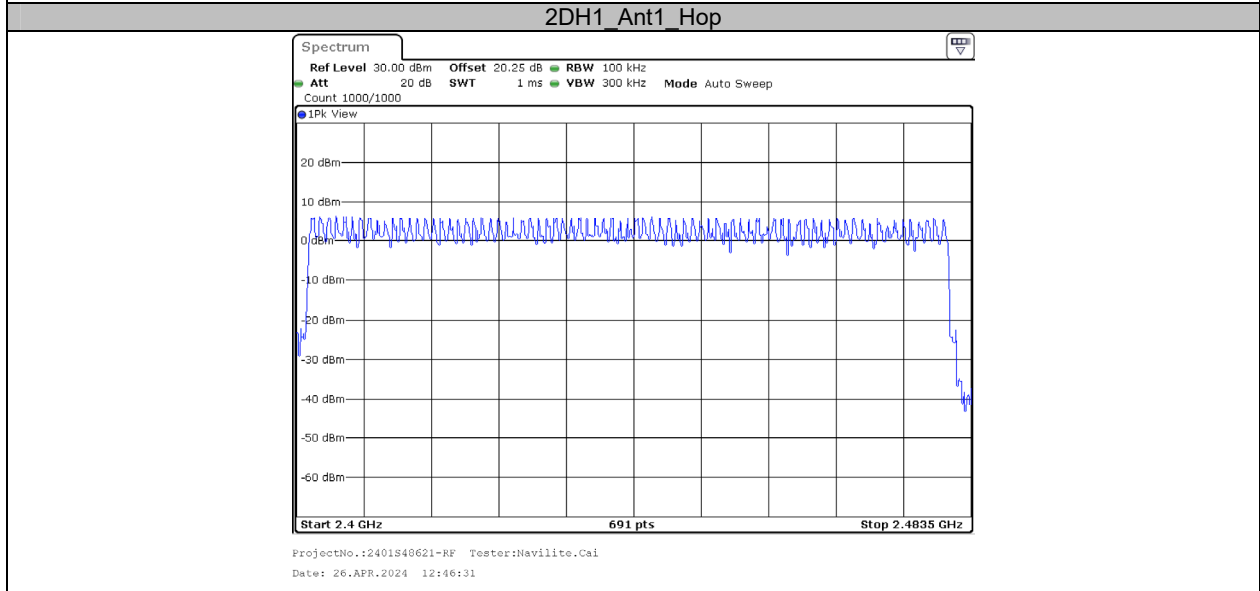
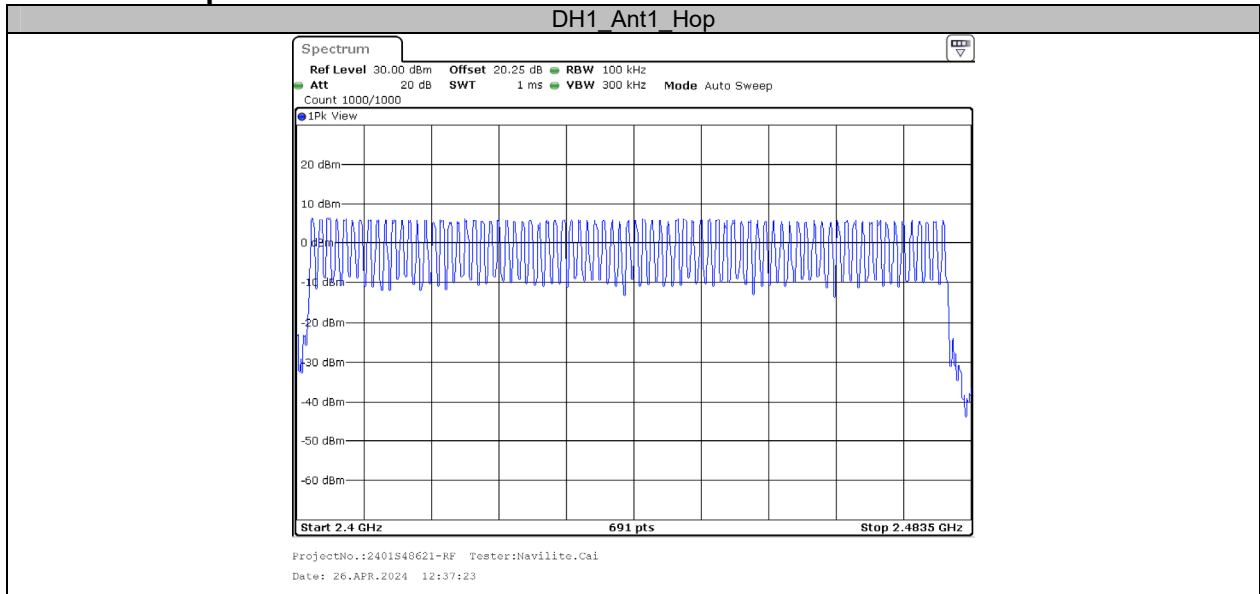

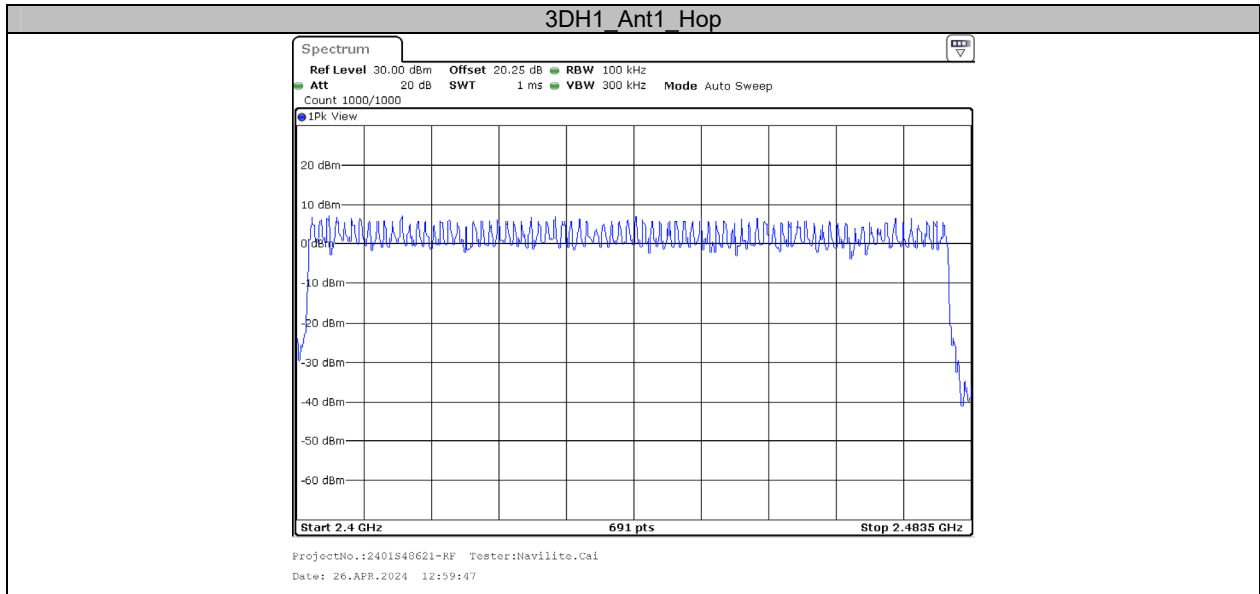

Appendix G: Band Edge Measurements

Test Graphs

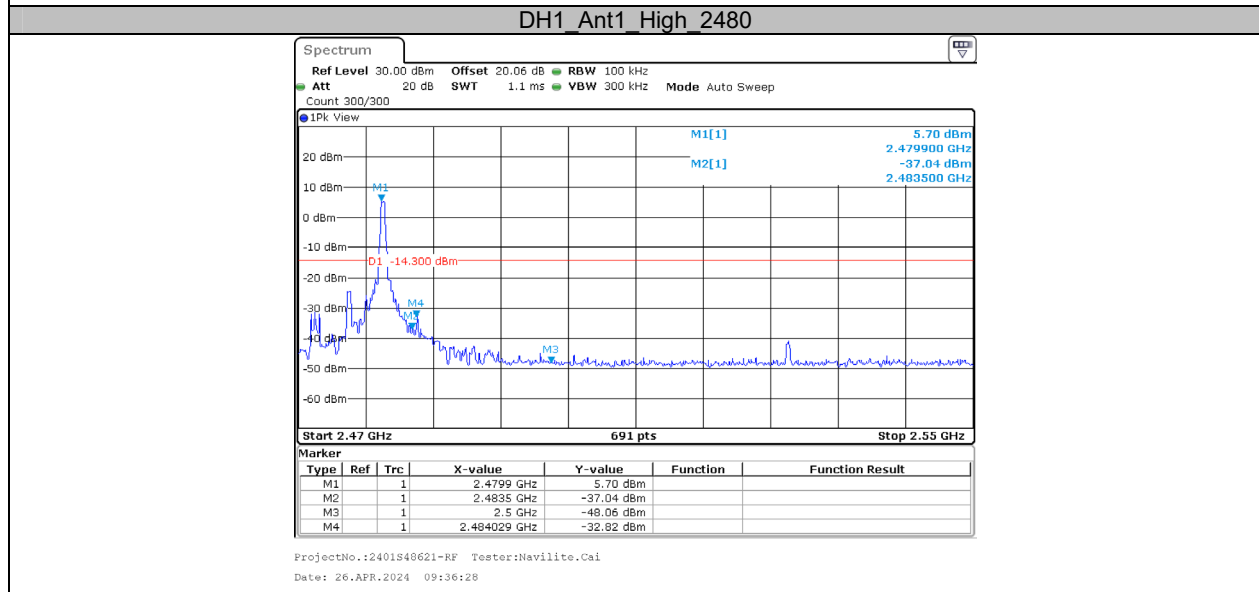
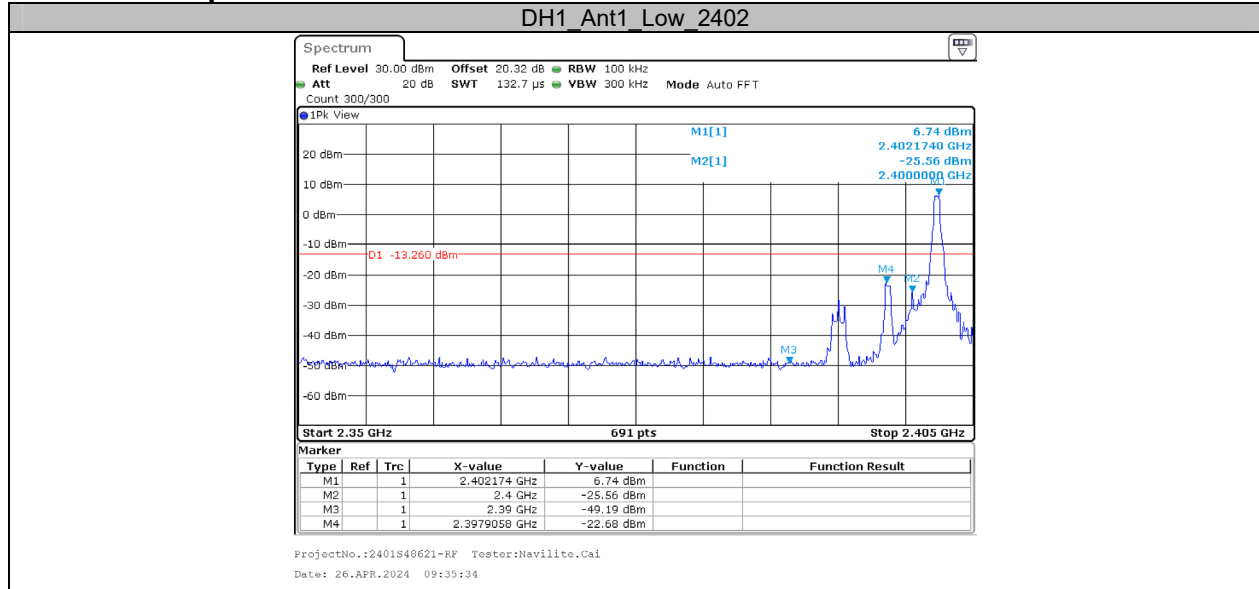

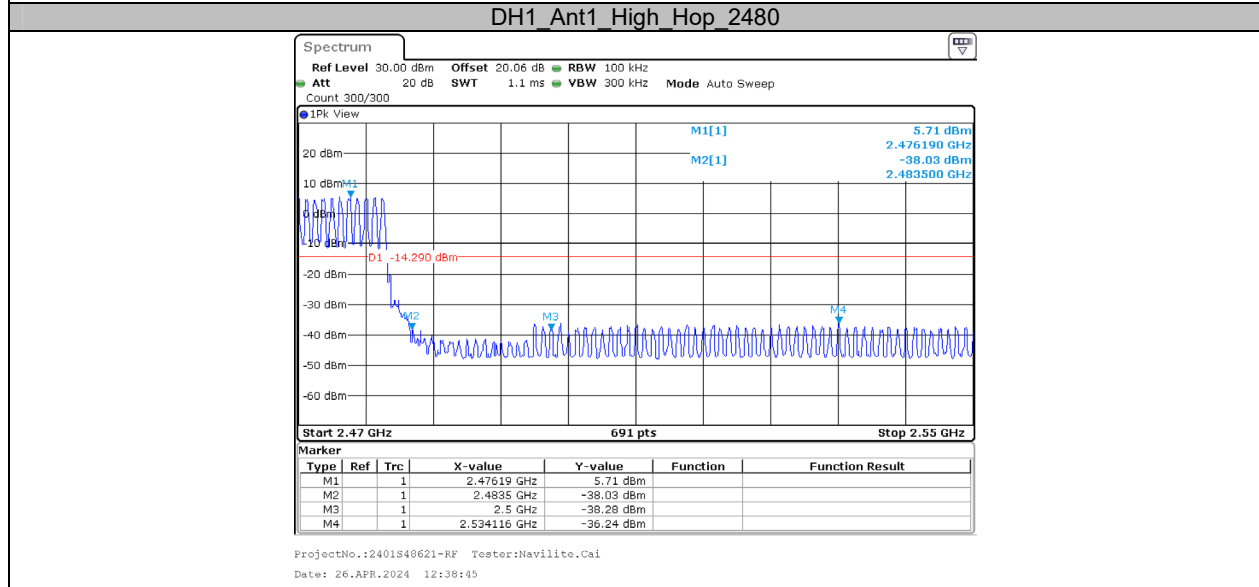
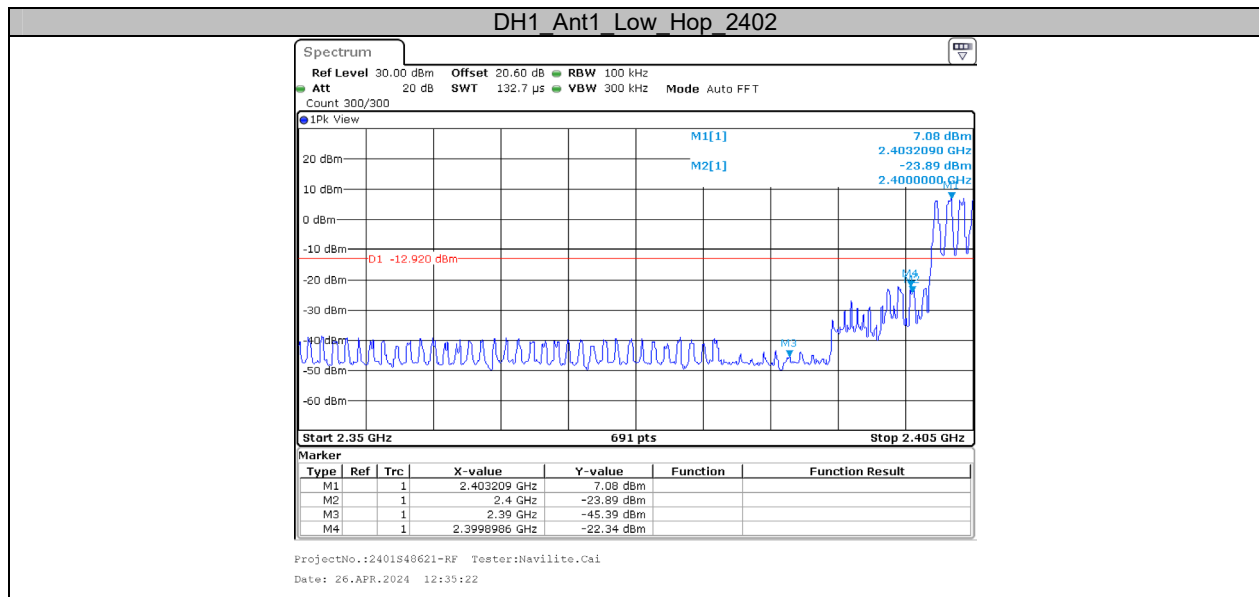

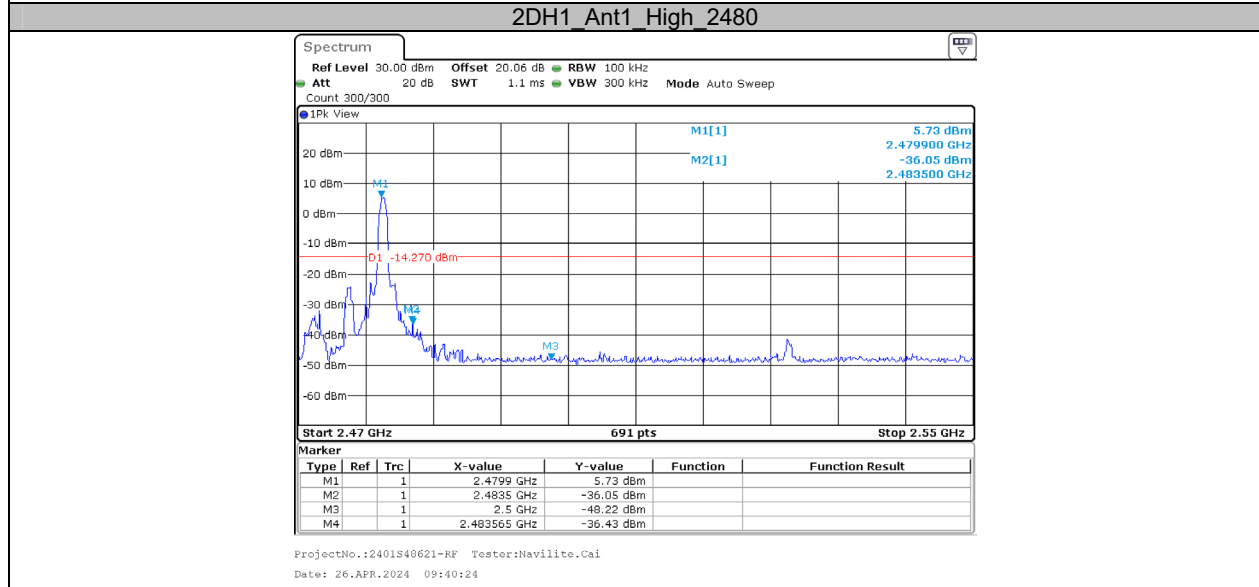
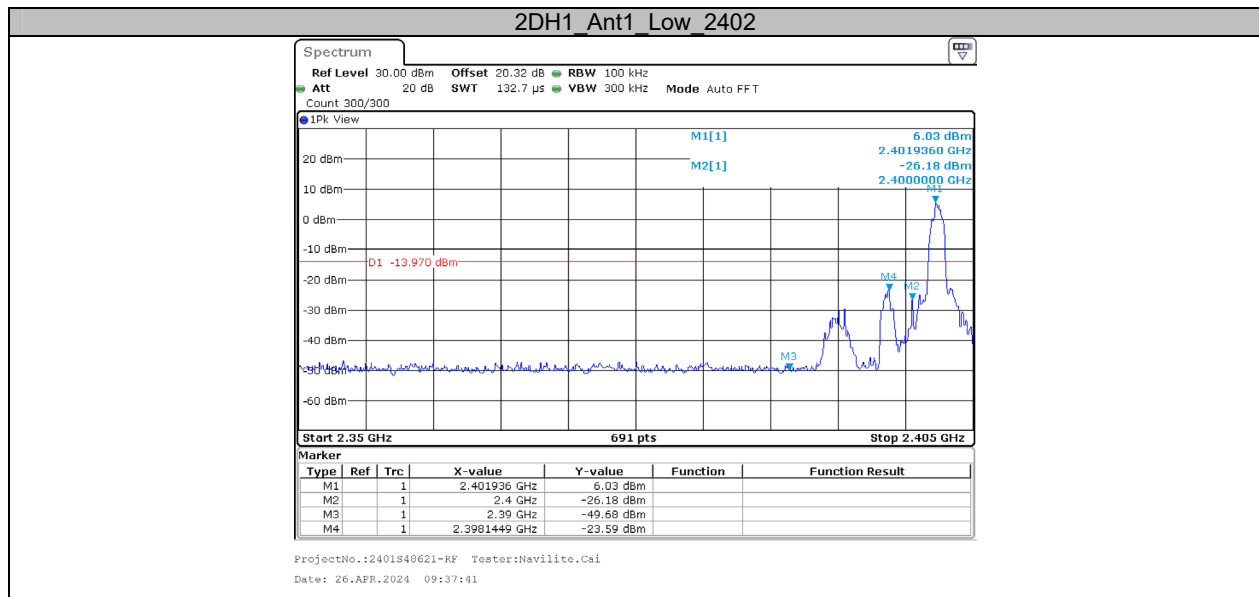

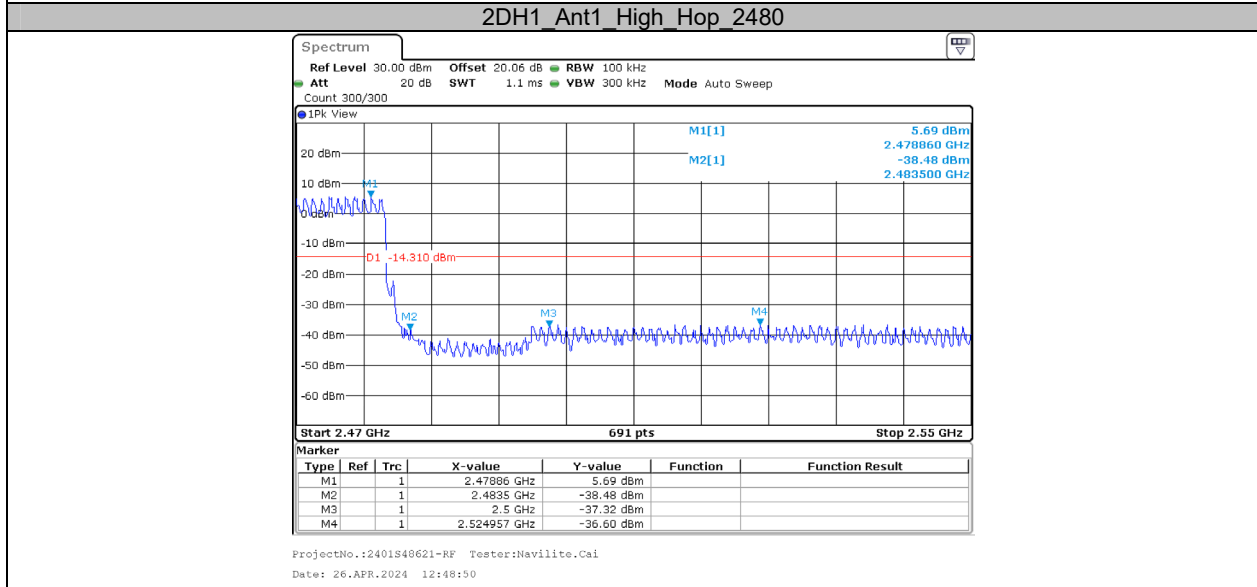
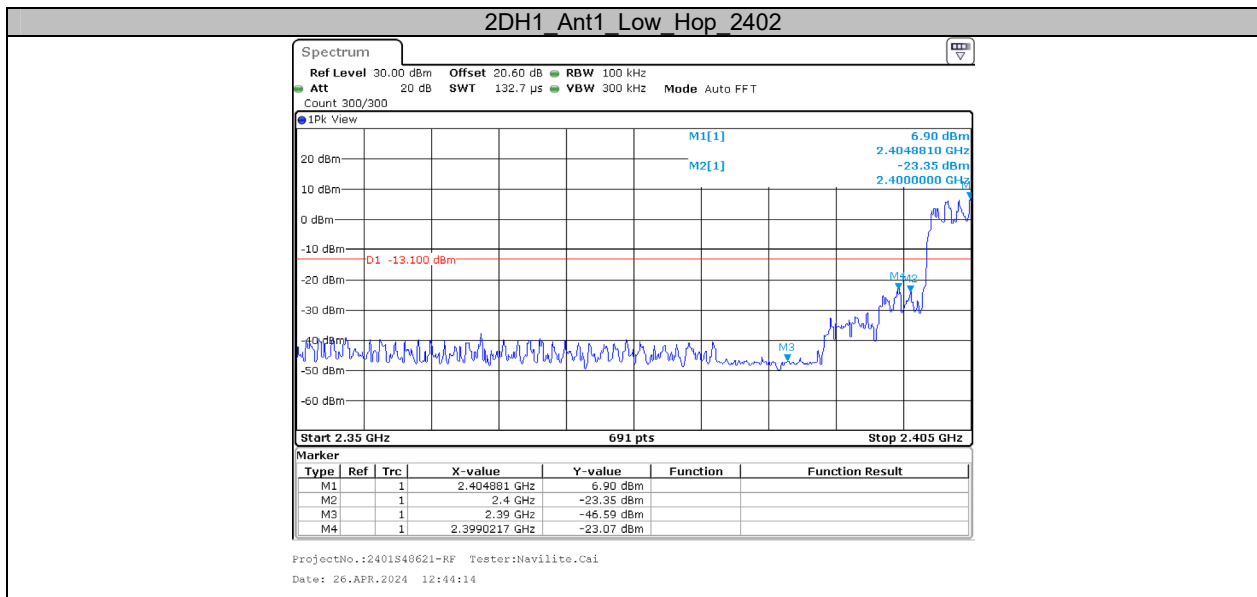

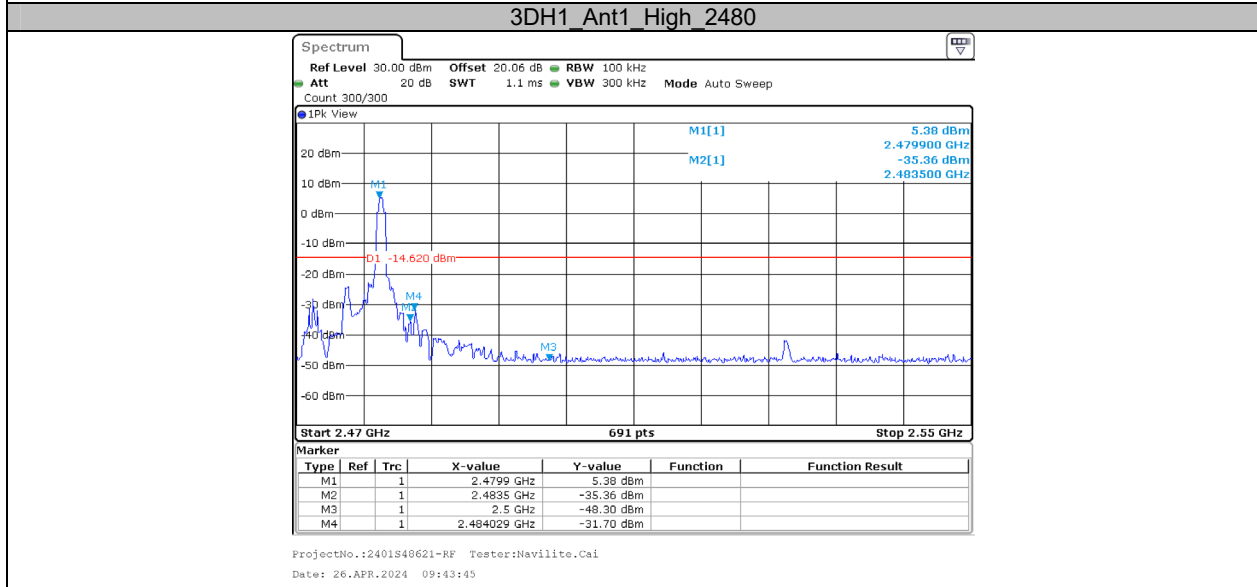
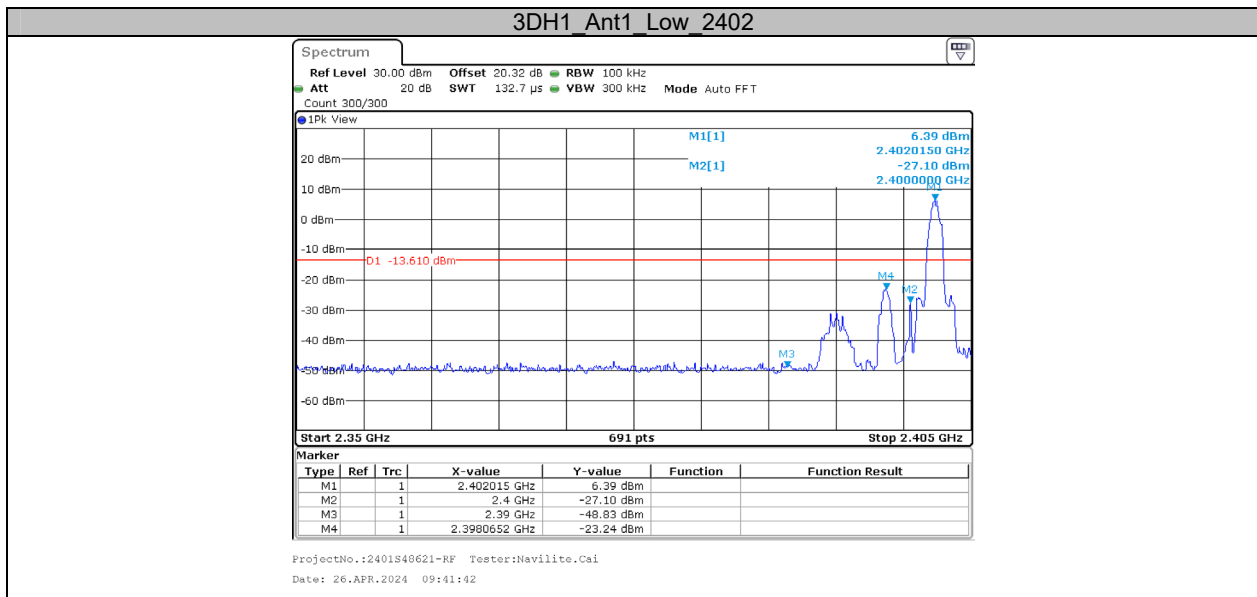

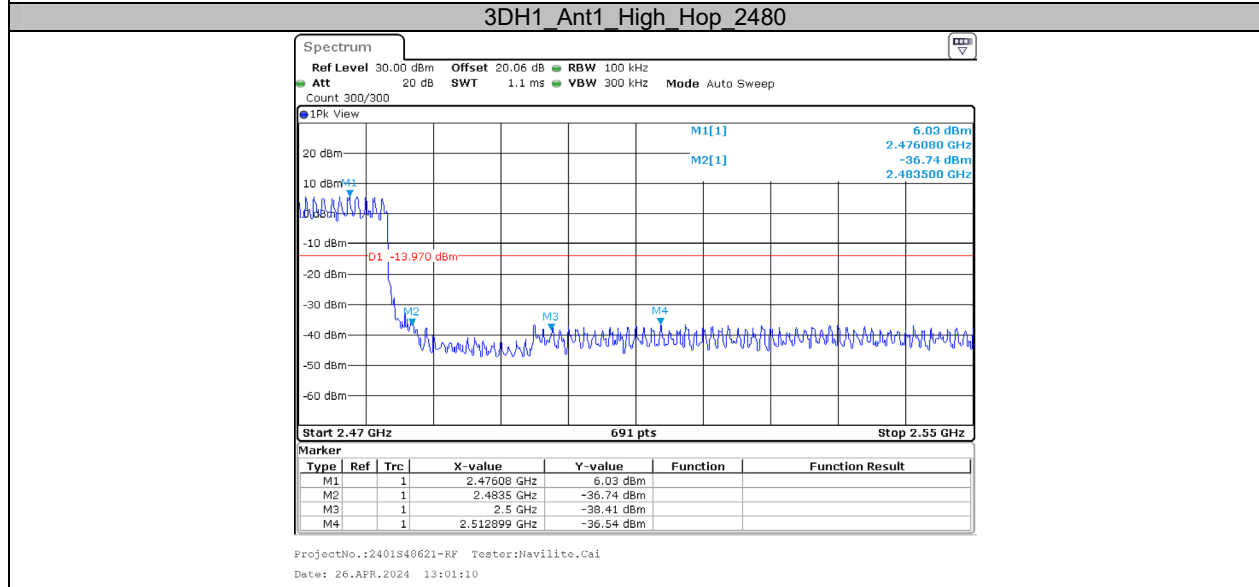
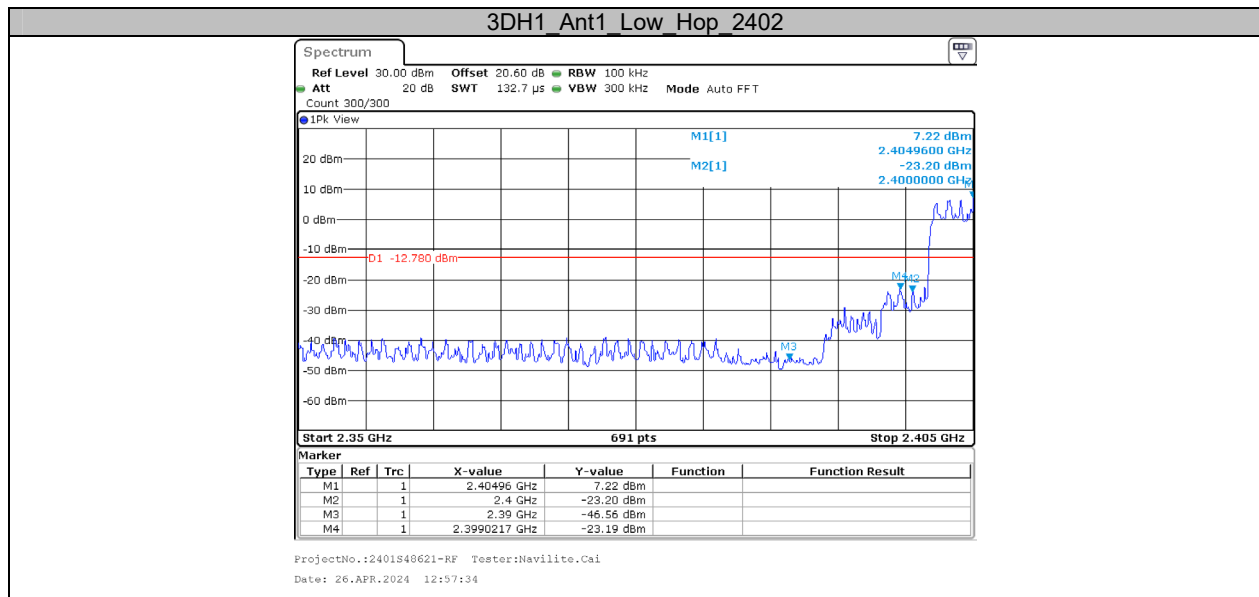

***** END OF REPORT *****