

BL3335-P

Embedded

Product

Version: 1.0

Release date: Jan 12, 2018

Features

- Support IEEE802.11 b/g/n standards
- Support WEP, WPA and WPA2 encryption
- Support UART/PWM/ADC/GPIO/I2C

interfaces

- Support STA/AP/AP+STA modes
- Support SmartConfig
- Support TLS/SSL protocols

- Support PCB antenna

- 3.3V power supply

- Wi-Fi related features

- Support 802.11 b/g/n with 20M and 40M bandwidth
- Support station and soft AP
- Support SmartConfig and AP

configuration

- Integrated balun/PA/LNA
- TCP/IP stack optimized for IoT

application

- PCB antenna

- Peripheral

- 2x UART
- 1x I2C
- 1x SPI

- 4x PWM
- Up to 14GPIOs

- Working temperature: -10°C to +85°C
- Stamp style SMD for surface mounting production

Applications

- Smart transportation
- Smart home / appliances
- Instruments
- Health care
- Industrial automation
- Intelligent security
- Smart energy

Models

Model	Antenna type	Note
BL3335-P	PCB antenna	Default

Content

1. Overview.....	- 3 -
2. Basic Specifications.....	- 3 -
2.1. Power Consumption.....	- 3 -
2.2. Working Environment.....	- 4 -
3. Radio Specifications.....	- 4 -
3.1. Basic Radio Specification.....	- 4 -
3.2. Radio Performance.....	- 5 -
3.2.1. IEEE 802.11b.....	- 5 -
3.2.2. IEEE 802.11g.....	- 5 -
3.2.3 IEEE802.11n.....	- 6 -
4. BL3335-P Hardware Information.....	- 8 -
4.1. Footprint Sequence.....	- 8 -
4.2. Footprint Definitions.....	- 9 -
4.3. PCB Antenna.....	- 10 -
4.4. Mechanical Dimensions.....	- 12 -
4.5. Recommended Pad Size.....	- 13 -
5. Reference Design.....	- 14 -
5.1. UART Interface Design.....	- 14 -
5.2. Power Supply Requirement.....	- 15 -
Revision History.....	- 16 -
Copyrights.....	- 16 -
Contact Us.....	- 16 -

1. Overview

BL3335-P is a cost-effective embedded Wi-Fi module designed by BroadLink, which supports 802.11 b/g/n standards and UART communication with other devices. The module integrates radio transceiver, MAC, baseband, all Wi-Fi protocols, configurations and network stack. It can be widely used in applications like smart home devices, remote monitoring devices and medical care instruments.

The module integrates an ARM Cortex-M4 processor speed up to 160MHz with 352KB SRAM and 1MB flash.

2. Basic Specifications

2.1. Power Consumption

Please refer to Table 1 for power consumption data.

Table 1 BL3335-P Power Consumption Data

Specifications	Min.	Typ.	Max.	Units
VDD ¹	3.3		4	V
VIL(input low voltage)	0		0.3VDD	V
VIH(input high voltage)	0.7VDD		VDD	V
VOL(output low voltage)		0		V
VOH(output high voltage)		VDD		V
Io			10	mA
Standby (SP mini)		80	85	mA
pulse current @TX 11b @17dBm 11Mbps			305	mA
pulse current @TX 11g @15dBm 54Mbps			250	mA
pulse current @TX 11n @14dBm 65Mbps			225	mA
Networking			305	mA

Note: Make sure VDD is not lower than 3.3V

2.2. Working Environment

Please refer to Table 2 for working environment data.

Table 2 BL3335-P Working Environment Data

Symbol	Description	Min.	Max.	Units
Ts	Storage temperature	-40	125	°C
TA	Ambient operating temperature	-10	85	°C
Vdd	Supply voltage	3.3	4	V
Vio	Voltage on IO pin	0	VDD	V
ESD	HBM	1000	2000	V

3. Radio Specifications

3.1. Basic Radio Specification

Please refer to Table 3 for radio specification.

Table 3 BL3335-P Radio Specification

Radio range	2.412 GHz - 2.462 GHz
Wireless standards	IEEE 802.11 b/g/n
Radio output	802.11b :18dBm ± 1dBm 802.11g :15dBm ± 1dBm 802.11n :13dBm ± 2dBm
Antenna type	Internal: PCB antenna External: Not supported
Receiving sensitivity	802.11b<-83dBm@11Mbps 802.11g<-72dBm@54Mbps 802.11n<-71dBm@MCS7
Stack	IPv4, TCP/UDP/FTP/HTTP/HTTPS/TLS/mDNS
Data rate (max)	11M@802.11b, 54M@802.11g, MCS7@802.11n
Security	Encryption standard: Open/WEP-Open/WPA/WPA2 Encryption algorithm: WEP64/WEP128/TKIP/AES
Network types	STA/AP/STA+AP/WIFI Direct

3.2. Radio Performance

3.2.1. IEEE 802.11b

Table 4 Basic specifications under IEEE802.11b

ITEM	Specification
Modulation Type	DSSS / CCK
Frequency range	2412MHz~2462MHz
Channel	CH1 to CH11
Data rate	1, 2, 5.5, 11Mbps

Table 5 Transmitting performance under IEEE802.11b

TX Characteristics	Min.	Typical	Max.	Unit
Power@11Mbps		17		dBm
Frequency Error	-10		+10	ppm
EVM@11Mbps			-20	dB
Transmit spectrum mask				
Pass				

Table 6 Receiving performance under IEEE802.11b

RX Characteristics	Min	Typical	Max.	Unit
Minimum Input Level Sensitivity				
11Mbps (FER \leq 8%)			-83	dBm
Maximum Input Level (FER \leq 8%)			-3	dBm

3.2.2. IEEE 802.11g

Table 7 Basic specifications under IEEE802.11g

ITEM	Specification
Modulation Type	OFDM
Frequency range	2412MHz~2462MHz

Channel	CH1 to CH11
Data rate	6, 9, 12, 18, 24, 36, 48, 54Mbps

Table 8 Transmitting performance under IEEE802.11g

TX Characteristics	Min.	Typical	Max.	Unit
Power@54Mbps		14		dBm
Frequency Error	-10		+10	ppm
EVM@54Mbps		-30	-29	dB
Transmit spectrum mask				
Pass				

Table 9 Receiving performance under IEEE802.11g

RX Characteristics	Min.	Typical	Max.	Unit
Minimum Input Level Sensitivity				
54Mbps			-71	dBm
Maximum Input Level (FER ≤ 10%)			-8	dBm

3.2.3 IEEE802.11n

IEEE802.11n 20MHz bandwidth mode

Table 10 Basic specifications under IEEE802.11n with 20MHz

ITEM	Specification
Modulation Type	OFDM
Frequency range	2412MHz~2462MHz
Channel	CH1 to CH11
Data rate	MCS0/1/2/3/4/5/6/7

Table 11 Transmitting performance under IEEE802.11n with 20MHz

TX Characteristics	Min.	Typical	Max.	Unit
Power@HT20, MCS7		14		dBm
Frequency Error	-10		+10	ppm
EVM@HT20, MCS7			-29	dB
Transmit spectrum mask				
Pass				

Table 12 Receiving performance under IEEE802.11n with 20MHz

RX Characteristics	Min.	Typical	Max.	Unit
Minimum Input Level Sensitivity				
MCS7			-69	dBm
Maximum Input Level (FER ≤ 10%)			-8	dBm

IEEE802.11n 40MHz bandwidth mode

Table 13 Basic specifications under IEEE802.11n with 40MHz

ITEM	Specification
Modulation Type	OFDM
Frequency range	2422MHz~2452MHz
Channel	CH3 to CH9
Data rate	MCS0/1/2/3/4/5/6/7

Table 14 Transmitting performance under IEEE802.11n with 40MHz

TX Characteristics	Min.	Typical	Max.	Unit
Power@HT40, MCS7		14		dBm
Frequency Error	-10		+10	ppm
EVM@HT40, MCS7			-33	dB
Transmit spectrum mask				
Pass				

Table 15 Receiving performance under IEEE802.11n with 40MHz

RX Characteristics	Min.	Typical	Max.	Unit
Minimum Input Level Sensitivity				
MCS7			-68	dBm
Maximum Input Level (FER \leq 10%)			-8	dBm

4. BL3335-P Hardware Information

4.1. Footprint Sequence

Please refer to Fig 1 for the footprint sequence of BL3335-P.

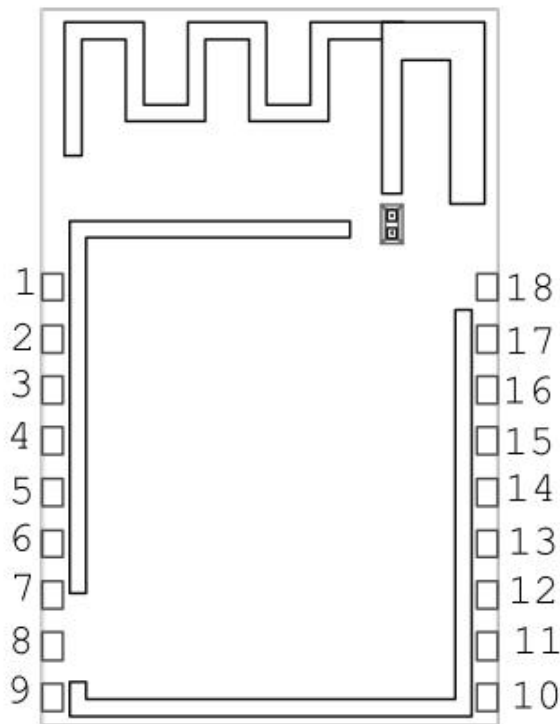

Fig 1 BL3335-P Footprint sequence

4.2. Footprint Definitions

Please refer to Table 16 for the footprint definitions of BL3335-P.

Table 16 BL3335-P footprint definitions

pin	Function 1	Function 2	Function 3	Function 4	Function 5	Default state
1	GPIO2	TX2				UP
2	GPIO1	RX2	I2C_SDA			UP
3	GPIO3		I2C_SCK			UP
4	GPIO12			SPI_MOSI		DOWN
5	GPIO13			SPI_MISO	PWM1	DOWN
6	GPIO25				PWM3	DOWN
7	GPIO0				PWM2	DOWN
8	VDD					
9	GND					
10	PDN					
11	GPADC	GPIO6				DOWN
12	GPIO7					DOWN
13	GPIO8				PWM0	DOWN
14	GPIO5			SPI_CS		DOWN
15	GPIO4			SPI_CLK		DOWN
16	RX0	GPIO_26				DOWN

17	TX0	GPIO_27				DOWN
18	GND					

Note:

1. In default, UART2 (pin1 and pin2) are used for bypass communication and UART0 (pin16 and pin17) are used for output of debugging information and burning firmware. Please refer to the description in DC Characteristics for UART output current level.
2. PDN is hardware reset for the module and will be effective with VIL. Configuration information will be remained after module reset. **The module has pull-up process for PDN designed internally.**
3. In default, PIN13 (GPIO8) is the PIN for external LED indicator to show the module configuration status and output VIH after configuration is successful.
4. In default, PIN14 (GPIO5) is the module software reset PIN and will be effective with VIH. The previous configuration information will be cleared after the module is reset (reset to factory settings).
5. The module supports max 4 channels of external interruption simultaneously except GPIO25 and UART0.
6. The ADC is 10bit with input voltage 0-2V
7. The power supply VDD should not be lower than 3.3V.

4.3. PCB Antenna

Please refer to Fig 2 for PCB antenna. Please avoid to place any electrical components, wiring or grounding under PCB antenna area on main board and it's better to leave this area blank on PCB.

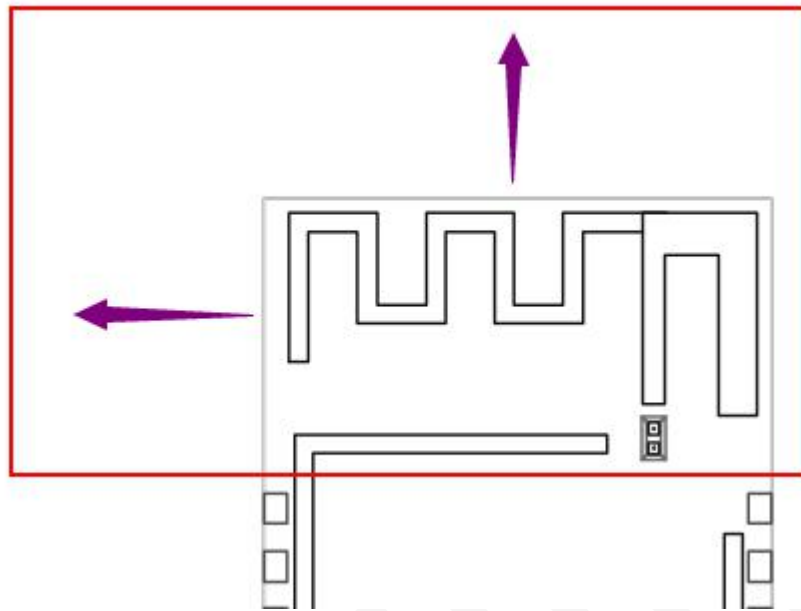

Fig 2 BL3335-P Antenna

The gain of PCB antenna on this module is about 0dB, as shown in Fig Fig 3.

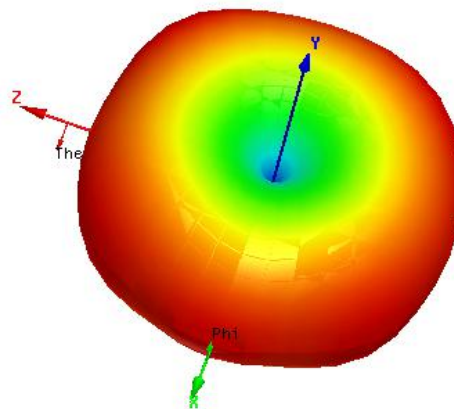
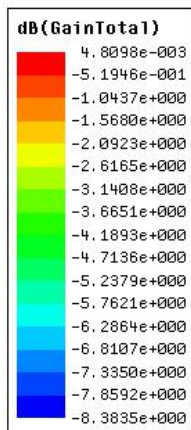

Fig 3 Simulated radiation pattern of antenna gain

The following precautions should be considered during designing with PCB antenna:

1. Do not place any electrical components or grounding in antenna area on main board and it's better to leave this area blank on PCB.
2. It is recommended to not place any electrical components within 30mm range of module

antenna and not design any circuit or bond copper on main board under this area.

3. Do not use the module inside any metal case or containers with metal painting.

4. Keep the antenna of wifi module next to the edge of main board during design of PCB to ensure better performance of antenna, as illustrated below.

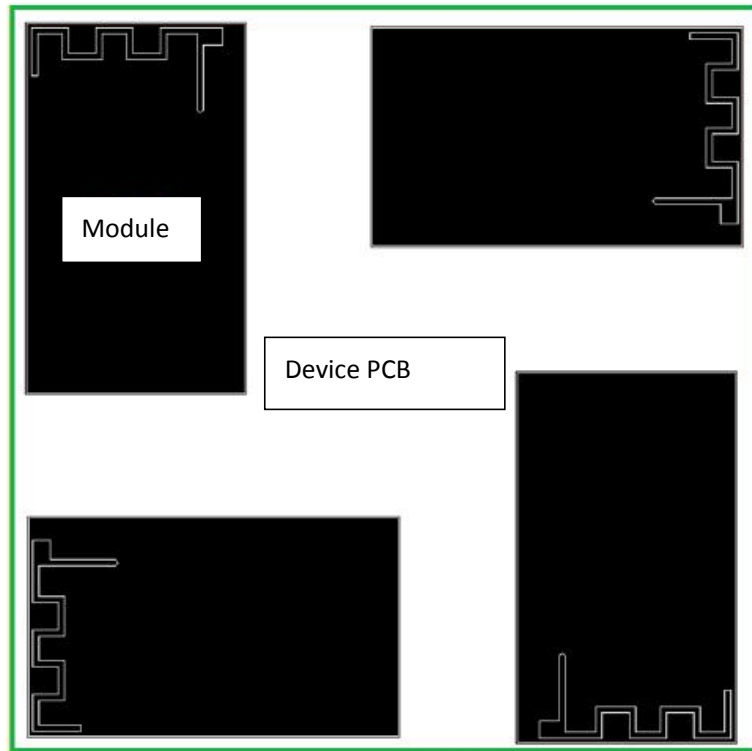

Fig 4 BL3335-P Recommended PCB layout

4.4. Mechanical Dimensions

Please refer to Fig Fig 5 for the dimensions of BL3335-P module.

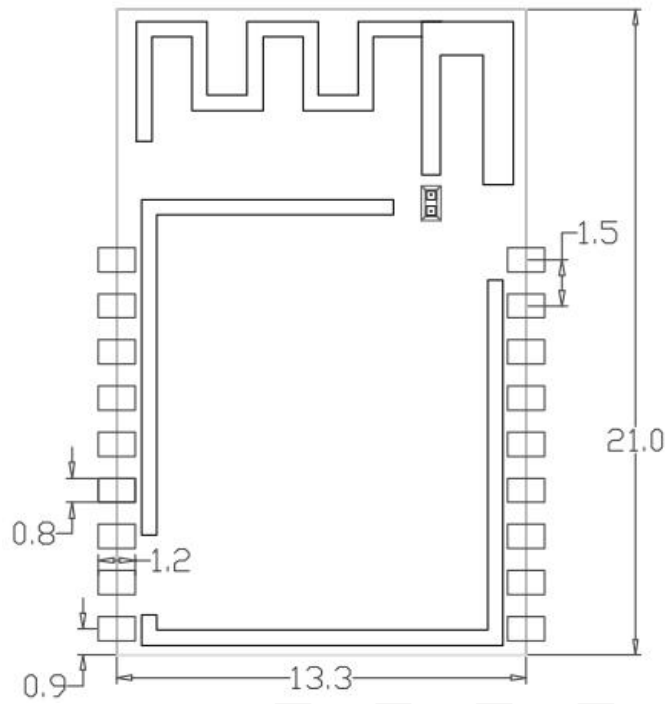

Fig 5 BL3335-P Dimensions

- a. Note: Dimensions (13.3 ± 0.2) mm * (21 ± 0.2) mm * (2.6 ± 0.2) mm (with shielding case)

4.5. Recommended Pad Size

Please refer to Fig Fig 6 for the recommended pad size of BL3335-P module.

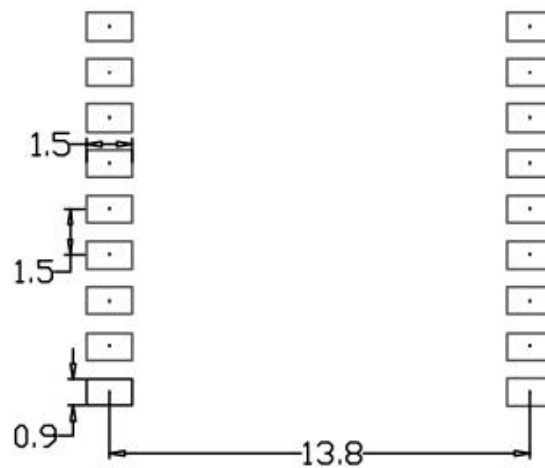

Fig 6 BL3335-P Recommended pad size

Unit: mm

5. Reference Design

5.1. UART Interface Design

For devices with 3.3V power supply, you can directly connect the device UART port with module UART port according to the illustration in Fig Fig 7.

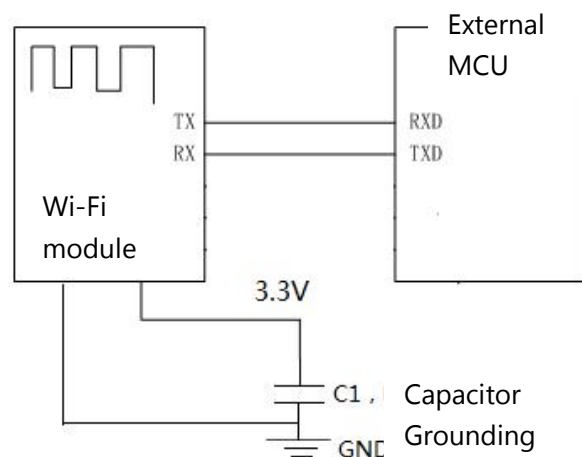

Fig 7 Circuit diagram (3.3V)

If your device is powered by 5V, you can refer to the circuit shown in Fig Fig 8 or design your own circuit for power conversion. The value of resistor can be adjusted according to actual circuit design.

Revision History

Date	Version	Updated Content
Jan 12, 2018	1.0	Preliminary version

Copyrights

It is prohibited to use or copy all or any part of contents in this manual without prior permission, especially applicable for trademarks, models, part numbers and figures.

Contact Us



Ms Zhou

Hangzhou Gubei Electronics Technology Co., Ltd.

Add: Room 106, Building 1, No. 611 Jianghong Road, Binjiang District, Hangzhou,

P.R.China Postcode: 310052

Tel: 0571-85071744-8010

Email: bingqi.zhou@broadlink.com.cn

For more information of BroadLink Wi-Fi modules, please visit our website:

www.broadlink.com.cn

This device complies with Part 15 of the FCC Rules. Operation is subject to the following two conditions:

- (1) This device may not cause harmful interference, and
- (2) This device must accept any interference received, including interference that may cause undesired operation.

Note: This product has been tested and found to comply with the limits for a Class B digital device, pursuant to Part 15 of the FCC Rules. These limits are designed to provide reasonable protection against harmful interference in a residential installation. This product generates, uses, and can radiate radio frequency energy and, if not installed and used in accordance with the instructions, may cause harmful interference to radio communications. However, there is no guarantee that interference will not occur in a particular installation. If this product does cause harmful interference to radio or television reception, which can be determined by turning the equipment off and on, the user is encouraged to try to correct the interference by one or more of the following measures:

- Reorient or relocate the receiving antenna.
- Increase the separation between the equipment and receiver.
- Connect the equipment into an outlet on a circuit different from that to which the receiver is connected.
- Consult the dealer or an experienced radio/TV technician for help.

Please take attention that changes or modification not expressly approved by the party responsible for compliance could void the user's authority to operate the equipment.

This equipment should be installed and operated with a minimum distance 20cm between the radiator and your body

This device complies with Industry Canada licence-exempt RSS standard(s).

Operation is subject to the following two conditions:

- (1) this device may not cause interference, and
- (2) this device must accept any interference, including interference that may cause undesired operation of the device.

Le présent appareil est conforme aux CNR d'Industrie Canada applicables aux appareils radioexempts de licence. L'exploitation est autorisée aux deux conditions suivantes :

- (1) l'appareil ne doit pas produire de brouillage, et
- (2) l'utilisateur de l'appareil doit accepter tout brouillage radioélectrique subi, même si le brouillage est susceptible d'en compromettre le fonctionnement.

Under Industry Canada regulations, this radio transmitter may only operate using an antenna of a type and maximum (or lesser) gain approved for the transmitter by Industry Canada. To reduce potential radio interference to other users, the antenna type and its gain should be so chosen that the equivalent isotropically radiated power (e.i.r.p.) is not more than that necessary for successful communication.

Conformément à la réglementation d'Industrie Canada, le présent émetteur radio peut fonctionner avec une antenne d'un type et d'un gain maximal (ou inférieur) approuvé pour l'émetteur par Industrie Canada. Dans le but de réduire les risques de brouillage radioélectrique à l'intention des autres utilisateurs, il faut choisir le type d'antenne et son gain de sorte que la puissance isotrope rayonnée équivalente (p.i.r.e.) ne dépasse pas l'intensité nécessaire à l'établissement d'une communication satisfaisante.

The module is limited to OEM installation ONLY

The OEM integrator is responsible for ensuring that the end-user has no manual instruction to remove or install module.

When the FCC identification number or ISED certification number is not visible when the module is installed inside another device, then the outside of the device into which the module is installed must also display a label referring to the enclosed module. This exterior label can use wording such as the following: "Contains FCC ID: 2ACDZ-BL3335-P or "Contains IC: 23239-BL3335P and the information should be also contained in the devices' user manual.