



SAR TEST REPORT

No. I21Z60291-SEM01

For

TCL Communication Ltd

GSM/UMTS/LTE mobile phone

Model name: T774B, T775B

With

Hardware Version: 03

Software Version: v3.0.9DF2

FCC ID: 2ACCJN054

Issued Date: 2021-3-18

Note:

The test results in this test report relate only to the devices specified in this report. This report shall not be reproduced except in full without the written approval of CTTL.

The report must not be used by the client to claim product certification, approval, or endorsement by NVLAP, NIST, or any agency of the U.S.Government.

Test Laboratory:

CTTL, Telecommunication Technology Labs, CAICT

No. 51, Xueyuan Road, Haidian District, Beijing, P. R. China 100191.

Tel:+86(0)10-62304633-2512, Fax:+86(0)10-62304633-2504

Email: ctl_terminals@caict.ac.cn, website: www.caict.ac.cn

**REPORT HISTORY**

Report Number	Revision	Issue Date	Description
I21Z60291-SEM01	Rev.0	2021-3-15	Initial creation of test report
I21Z60291-SEM01	Rev.1	2021-3-18	Update the frequency range information about B41. Update the sum of reported SAR evaluation for Extremity SAR 10g.

TABLE OF CONTENT

1 TEST LABORATORY	5
1.1 TESTING LOCATION	5
1.2 TESTING ENVIRONMENT.....	5
1.3 PROJECT DATA	5
1.4 SIGNATURE.....	5
2 STATEMENT OF COMPLIANCE	6
3 CLIENT INFORMATION	9
3.1 APPLICANT INFORMATION	9
3.2 MANUFACTURER INFORMATION	9
4 EQUIPMENT UNDER TEST (EUT) AND ANCILLARY EQUIPMENT (AE)	10
4.1 ABOUT EUT	10
4.2 INTERNAL IDENTIFICATION OF EUT USED DURING THE TEST.....	11
4.3 INTERNAL IDENTIFICATION OF AE USED DURING THE TEST	11
5 TEST METHODOLOGY	12
5.1 APPLICABLE LIMIT REGULATIONS.....	12
5.2 APPLICABLE MEASUREMENT STANDARDS	12
6 SPECIFIC ABSORPTION RATE (SAR).....	13
6.1 INTRODUCTION.....	13
6.2 SAR DEFINITION.....	13
7 TISSUE SIMULATING LIQUIDS	14
7.1 TARGETS FOR TISSUE SIMULATING LIQUID.....	14
7.2 DIELECTRIC PERFORMANCE	14
8 SYSTEM VERIFICATION	19
8.1 SYSTEM SETUP.....	19
8.2 SYSTEM VERIFICATION.....	20
9 MEASUREMENT PROCEDURES	21
9.1 TESTS TO BE PERFORMED	21
9.2 GENERAL MEASUREMENT PROCEDURE.....	22
9.3 WCDMA MEASUREMENT PROCEDURES FOR SAR	24
9.4 SAR MEASUREMENT FOR LTE.....	25
9.5 BLUETOOTH & WI-FI MEASUREMENT PROCEDURES FOR SAR	27
9.6 POWER DRIFT.....	27
10 AREA SCAN BASED 1-G SAR.....	28
10.1 REQUIREMENT OF KDB.....	28
10.2 FAST SAR ALGORITHMS	28

11 CONDUCTED OUTPUT POWER.....	29
11.1 GSM MEASUREMENT RESULT	29
11.2 WCDMA MEASUREMENT RESULT	32
11.4 LTE MEASUREMENT RESULT	34
11.4 WI-FI AND BT MEASUREMENT RESULT	68
12 SIMULTANEOUS TX SAR CONSIDERATIONS.....	72
12.1 INTRODUCTION.....	72
12.2 TRANSMIT ANTENNA SEPARATION DISTANCES.....	73
12.3 SAR MEASUREMENT POSITIONS	73
12.4 STANDALONE SAR TEST EXCLUSION CONSIDERATIONS	73
13 EVALUATION OF SIMULTANEOUS.....	75
14 SAR TEST RESULT	76
14.1 SAR RESULTS FOR FAST SAR	77
14.2 SAR RESULTS FOR STANDARD PROCEDURE.....	91
14.3 WLAN EVALUATION FOR 2.4G	98
14.4 WLAN EVALUATION FOR 5G.....	102
14.5 SAR RESULTS FOR PHABLET.....	113
14.6 SAR RESULTS FOR FAST BT	114
15 SAR MEASUREMENT VARIABILITY.....	114
16 MEASUREMENT UNCERTAINTY	117
16.1 MEASUREMENT UNCERTAINTY FOR NORMAL SAR TESTS (300MHZ~3GHZ).....	117
16.2 MEASUREMENT UNCERTAINTY FOR NORMAL SAR TESTS (3~6GHZ)	118
16.3 MEASUREMENT UNCERTAINTY FOR FAST SAR TESTS (300MHZ~3GHZ).....	119
16.4 MEASUREMENT UNCERTAINTY FOR FAST SAR TESTS (3~6GHZ)	120
17 MAIN TEST INSTRUMENTS.....	121
ANNEX A GRAPH RESULTS.....	122
ANNEX B SYSTEM VERIFICATION RESULTS	170
ANNEX C SAR MEASUREMENT SETUP	181
ANNEX D POSITION OF THE WIRELESS DEVICE IN RELATION TO THE PHANTOM	187
ANNEX E EQUIVALENT MEDIA RECIPES	190
ANNEX F SYSTEM VALIDATION	191
ANNEX G PROBE CALIBRATION CERTIFICATE.....	192
ANNEX H DIPOLE CALIBRATION CERTIFICATE	202
ANNEX I ACCREDITATION CERTIFICATE.....	273

1 Test Laboratory

1.1 Testing Location

Company Name:	CTTL(Shouxiang)
Address:	No. 51 Shouxiang Science Building, Xueyuan Road, Haidian District, Beijing, P. R. China100191

1.2 Testing Environment

Temperature:	18°C~25°C,
Relative humidity:	30%~ 70%
Ground system resistance:	< 0.5 Ω
Ambient noise & Reflection:	< 0.012 W/kg

1.3 Project Data

Project Leader:	Qi Dianyuan
Test Engineer:	Lin Xiaojun
Testing Start Date:	March 5, 2021
Testing End Date:	March 13, 2021

1.4 Signature



Lin Xiaojun

(Prepared this test report)

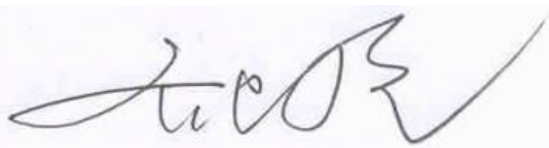

Qi Dianyuan

(Reviewed this test report)

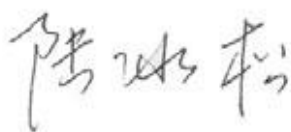

Lu Bingsong

Deputy Director of the laboratory
(Approved this test report)

2 Statement of Compliance

The maximum results of Specific Absorption Rate (SAR) found during testing for TCL Communication Ltd GSM/UMTS/LTE mobile phone T774B, T775B are as follows:

Table 2.1: Highest Reported SAR (1g)

Exposure Configuration	Technology Band	Highest Reported SAR 1g(W/kg)	Equipment Class
Head (Separation Distance 0mm)	GSM 850	0.38	PCE
	PCS 1900	0.10	
	UMTS FDD 2	0.25	
	UMTS FDD 4	0.20	
	UMTS FDD 5	0.27	
	LTE Band 7	0.68	
	LTE Band 12	0.18	
	LTE Band 13	0.22	
	LTE Band 25	0.16	
	LTE Band 26	0.28	
	LTE Band 41	0.56	
	LTE Band 66	0.31	
	LTE Band 71	0.15	
	WLAN 2.4 GHz	1.23	DTS
	WLAN 5 GHz	0.75	UNII
Hotspot (Separation Distance 10mm)	GSM 850	0.46	PCE
	PCS 1900	1.31	
	UMTS FDD 2	1.28	
	UMTS FDD 4	1.11	
	UMTS FDD 5	0.38	
	LTE Band 7	0.38	
	LTE Band 12	0.21	
	LTE Band 13	0.25	
	LTE Band 25	1.34	
	LTE Band 26	0.32	
	LTE Band 41	1.04	
	LTE Band 66	1.15	
	LTE Band 71	0.24	
	WLAN 2.4 GHz	0.33	DTS
	WLAN 5 GHz	0.87	UNII
Body-worn (Separation Distance 15mm)	LTE Band 7	1.15	PCE
	LTE Band 41	0.73	

The SAR values found for the Mobile Phone are below the maximum recommended levels of 1.6 W/kg as averaged over any 1g tissue according to the ANSI C95.1-1992.

For body operation, this device has been tested and meets FCC RF exposure guidelines when used with any accessory that contains no metal and which provides a minimum separation distance of 10 mm for hotspot and 15mm for body worn between this device and the body of the user. Use of other accessories may not ensure compliance with FCC RF exposure guidelines.

The EUT battery must be fully charged and checked periodically during the test to ascertain uniform power output.

The measurement together with the test system set-up is described in annex C of this test report. A detailed description of the equipment under test can be found in chapter 4 of this test report. The highest reported SAR value is obtained at the case of (**Table 2.1**), and the values are: **1.34 W/kg(1g)**.

Table 2.2: The sum of reported SAR values for Main antenna and WiFi-2.4G

	Position	Band	Cellular antenna	WiFi	Sum
Maximum reported SAR value for Body	Rear 10mm	LTEB41	1.04	0.33	1.37

Note1: we have evaluated and chose the highest value of WiFi 2.4G and 5G in the above table.

Table 2.3: The sum of reported SAR values for Main antenna + WiFi-5G

	Position	Band	Cellular antenna	WiFi-5G	Sum
Maximum reported SAR value for Body	Rear 10mm	LTEB41	1.04	0.42	1.46

Table 2.4: The sum of reported SAR values for Main antenna +BT

	Position	Band	Cellular antenna	BT	Sum
Maximum reported SAR value for Body	Bottom 10mm	LTEB25	1.34	<0.01	1.34

Note1: we have evaluated and chose the highest value of WiFi 2.4G and 5G in the above table.

Note2: we have evaluated and chose the highest value of body 10mm and 15mm in the above table.

According to the above tables, the highest sum of reported SAR values is **1.46 W/kg (1g)**. The detail for simultaneous transmission consideration is described in chapter 13.

According to the KDB648474 D04, the UMPC mini-tablet procedures must also be applied to test the SAR of all surfaces and edges with an antenna located at ≤ 25 mm from that surface or edge, in direct contact with a flat phantom, for 10-g extremity SAR according to the body-equivalent tissue dielectric parameters in KDB Publication 865664 D01 to address interactive hand use exposure conditions. When hotspot mode applies, 10-g extremity SAR is required only for the surfaces and edges with hotspot mode 1-g reported SAR > 1.2 W/kg

Table 2.5: 0mm Reported SAR for phablet (10g)

Exposure Configuration	Technology Band	Highest Reported SAR 10g(W/kg)	Limit 10g (W/kg)
10g extremity SAR (Separation Distance 0mm)	GSM1900	2.97	4.0
	LTE Band 7	2.85	4.0
	LTE Band 25	2.80	4.0
	LTE Band 41	1.79	4.0
	UMTS FDD 2	2.67	4.0

	WLAN2.4G	0.86	4.0
	WLAN5G	0.90	4.0

Table 2.6: The sum of reported SAR values for Main antenna and WiFi-2.4G

	Position	Band	Cellular antenna	WiFi	Sum
Maximum reported SAR value for Extremity SAR	Rear 0mm	LTEB7	2.85	0.86	3.71

Note1: we have evaluated and chose the highest value of WiFi 2.4G and 5G in the above table.

Table 2.7: The sum of reported SAR values for Main antenna + WiFi-5G

	Position	Band	Cellular antenna	WiFi-5G	Sum
Maximum reported SAR value for Extremity SAR	Rear 0mm	LTEB7	2.85	0.90	3.75

Table 2.8: The sum of reported SAR values for Main antenna +BT

	Position	Band	Cellular antenna	BT	Sum
Maximum reported SAR value for Extremity SAR	Bottom 0mm	GSM1900	2.97	<0.01	2.97



3 Client Information

3.1 Applicant Information

Company Name:	TCL Communication Ltd.
Address/Post:	5/F, Building 22E, 22 Science Park East Avenue, Hong Kong Science Park, Shatin, NT, Hong Kong
Contact Person:	Gong Zhizhou
E-mail:	zhizhou.gong@tcl.com
Telephone:	0086-755-36611722
Fax:	0086-75536612000-81722

3.2 Manufacturer Information

Company Name:	TCL Communication Ltd.
Address/Post:	5/F, Building 22E, 22 Science Park East Avenue, Hong Kong Science Park, Shatin, NT, Hong Kong
Contact Person:	Gong Zhizhou
E-mail:	zhizhou.gong@tcl.com
Telephone:	0086-755-36611722
Fax:	0086-75536612000-81722

4 Equipment Under Test (EUT) and Ancillary Equipment (AE)

4.1 About EUT

Description:	GSM/UMTS/LTE mobile phone
Model name:	T774B,T775B
Operating mode(s):	GSM850/900/1800/1900,WCDMA850/900/1700/1900/2100,LTE Band1/2/3/4/5/7/8/12/13/17/20/25/26/28/29/38/40/41/66/71,BT,Wi-Fi(2.4G/5G)
Tested Tx Frequency:	824 – 849 MHz (GSM 850)
	1850 – 1910 MHz (GSM 1900)
	824–849 MHz (WCDMA 850 Band V)
	1710 – 1755 MHz (WCDMA 1700 Band IV)
	1850–1910 MHz (WCDMA1900 Band II)
	2502.5 – 2567.5 MHz(LTE Band 7)
	699.7 – 715.3 MHz (LTE Band 12)
	779.5 –784.5 MHz (LTE Band 13)
	1850.7 – 1914.3 MHz (LTE Band 25)
	814.7 – 848.3 MHz (LTE Band 26)
	2535 – 2655MHz (LTE Band 41)
	1710.7 – 1779.3 MHz (LTE Band 66)
	665.5 – 695.5 MHz (LTE Band 71)
2412 – 2462 MHz (Wi-Fi 2.4G)	
5150-5825 MHz (Wi-Fi 5G)	
GPRS/EGPRS Multislot Class:	12
GPRS capability Class:	B
Test device Production information:	Production unit
Device type:	Portable device
Antenna type:	Embedded
Accessories/Body-worn configurations:	Headset
Hotspot mode:	Support
VoIP:	Support

4.2 Internal Identification of EUT used during the test

EUT ID*	IMEI	HW	SW Version
EUT1	351897970006106	03	v3.0.9DF2
EUT2	351897970006080	03	v3.0.9DF2
EUT3	351897970006098	03	v3.0.9DF2
EUT4	351897970000083	03	v3.0.9DF2
EUT5	351897970000091	03	v3.0.9DF2

*EUT ID: is used to identify the test sample in the lab internally.

Note: It is performed to test SAR with the EUT1-3 and conducted power with the EUT4-5.

4.3 Internal Identification of AE used during the test

AE ID*	Description	Model	SN	Manufacturer
AE1	Battery	TLp048A1	/	BYD
AE2	Battery	TLp048A7	/	VEKEN
AE3	Headset	WH35	/	JUWEI
AE4	Headset	WH70	/	Lianchuang

*AE ID: is used to identify the test sample in the lab internally.

5 TEST METHODOLOGY

5.1 Applicable Limit Regulations

ANSI C95.1–1992:IEEE Standard for Safety Levels with Respect to Human Exposure to Radio Frequency Electromagnetic Fields, 3 kHz to 300 GHz.

It specifies the maximum exposure limit of **1.6 W/kg** as averaged over any 1 gram of tissue for portable devices being used within 20 cm of the user in the uncontrolled environment.

5.2 Applicable Measurement Standards

IEEE 1528–2013: Recommended Practice for Determining the Peak Spatial-Average Specific Absorption Rate (SAR) in the Human Head from Wireless Communications Devices: Measurement Techniques.

KDB447498 D01: General RF Exposure Guidance v06: Mobile and Portable Devices RF Exposure Procedures and Equipment Authorization Policies.

KDB648474 D04 Handset SAR v01r03: SAR Evaluation Considerations for Wireless Handsets.

KDB941225 D01 SAR test for 3G devices v03r01: SAR Measurement Procedures for 3G Devices

KDB941225 D05 SAR for LTE Devices v02r05: SAR Evaluation Considerations for LTE Devices

KDB941225 D06 Hotspot Mode SAR v02r01: SAR Evaluation Procedures for Portable Devices with Wireless Router Capabilities

KDB248227 D01 802.11 Wi-Fi SAR v02r02: SAR GUIDANCE FOR IEEE 802.11 (Wi-Fi) TRANSMITTERS

KDB865664 D01 SAR measurement 100 MHz to 6 GHz v01r04: SAR Measurement Requirements for 100 MHz to 6 GHz.

KDB865664 D02 RF Exposure Reporting v01r02: RF Exposure Compliance Reporting and Documentation Considerations

6 Specific Absorption Rate (SAR)

6.1 Introduction

SAR is related to the rate at which energy is absorbed per unit mass in an object exposed to a radio field. The SAR distribution in a biological body is complicated and is usually carried out by experimental techniques or numerical modeling. The standard recommends limits for two tiers of groups, occupational/controlled and general population/uncontrolled, based on a person's awareness and ability to exercise control over his or her exposure. In general, occupational/controlled exposure limits are higher than the limits for general population/uncontrolled.

6.2 SAR Definition

The SAR definition is the time derivative (rate) of the incremental energy (dW) absorbed by (dissipated in) an incremental mass (dm) contained in a volume element (dv) of a given density (ρ). The equation description is as below:

$$SAR = \frac{d}{dt} \left(\frac{dW}{dm} \right) = \frac{d}{dt} \left(\frac{dW}{\rho dv} \right)$$

SAR is expressed in units of Watts per kilogram (W/kg)

SAR measurement can be either related to the temperature elevation in tissue by

$$SAR = c \left(\frac{\delta T}{\delta t} \right)$$

Where: C is the specific heat capacity, δT is the temperature rise and δt is the exposure duration, or related to the electrical field in the tissue by

$$SAR = \frac{\sigma |E|^2}{\rho}$$

Where: σ is the conductivity of the tissue, ρ is the mass density of tissue and E is the RMS electrical field strength.

However for evaluating SAR of low power transmitter, electrical field measurement is typically applied.

7 Tissue Simulating Liquids

7.1 Targets for tissue simulating liquid

Table 7.1: Targets for tissue simulating liquid

Frequency(MHz)	Liquid Type	Conductivity(σ)	$\pm 5\%$ Range	Permittivity(ϵ)	$\pm 5\%$ Range
750	Head	0.89	0.85~0.93	41.94	39.8~44.0
835	Head	0.90	0.86~0.95	41.5	39.4~43.6
1750	Head	1.37	1.30~1.44	40.08	38.1~42.1
1900	Head	1.40	1.33~1.47	40.0	38.0~42.0
2450	Head	1.80	1.71~1.89	39.2	37.2~41.2
2600	Head	1.96	1.86~2.06	39.01	37.1~41.0
5250	Head	4.71	4.47~4.95	35.93	34.13~37.73
5600	Head	5.07	4.82~5.32	35.53	33.8~37.3
5750	Head	5.22	4.96~5.48	35.36	33.59~37.13

7.2 Dielectric Performance

Table 7.2: Dielectric Performance of Tissue Simulating Liquid

Measurement Date yyyy/mm/dd	Frequency	Type	Permittivity ϵ	Drift (%)	Conductivity σ (S/m)	Drift (%)
2021/3/5	750 MHz	Head	42.5	1.34	0.89	0.00
2021/3/6	835 MHz	Head	40.69	-1.95	0.888	-1.33
2021/3/7	1750 MHz	Head	40.2	0.30	1.354	-1.17
2021/3/8	1900 MHz	Head	39.38	-1.55	1.411	0.79
2021/3/9	2450 MHz	Head	39.83	1.61	1.818	1.00
2021/3/10	2600 MHz	Head	39.01	0.00	1.956	-0.20
2021/3/11	5250 MHz	Head	36.07	0.39	4.729	0.40
2021/3/12	5600 MHz	Head	35.75	0.62	5.153	1.64
2021/3/13	5750 MHz	Head	35.73	1.05	5.201	-0.36

Note: The liquid temperature is 22.0°C

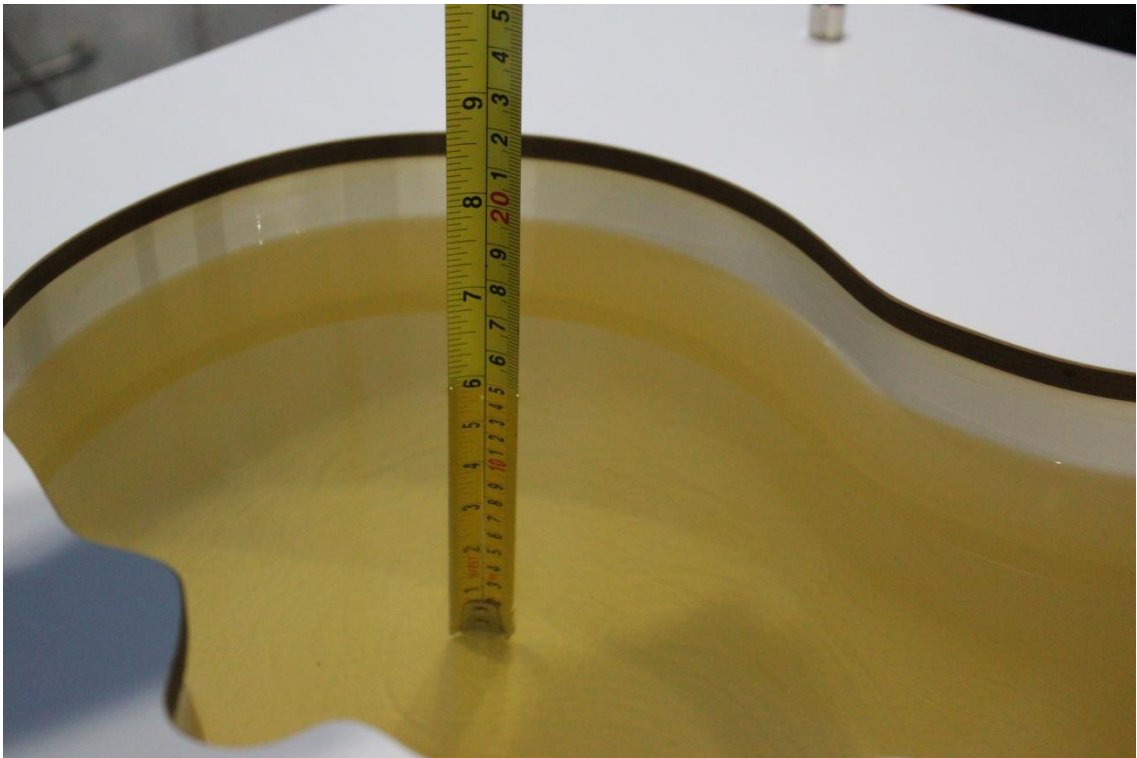

Picture 7-1 Liquid depth in the Head Phantom (750MHz)

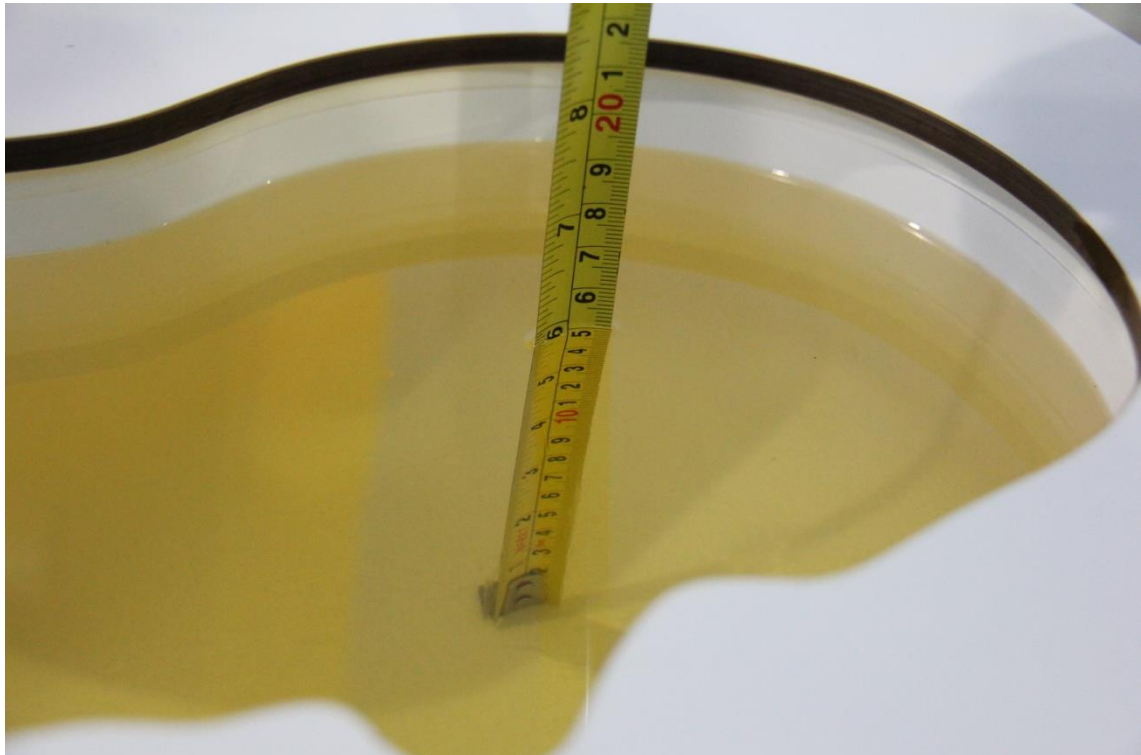

Picture 7-2 Liquid depth in the Head Phantom (835 MHz)

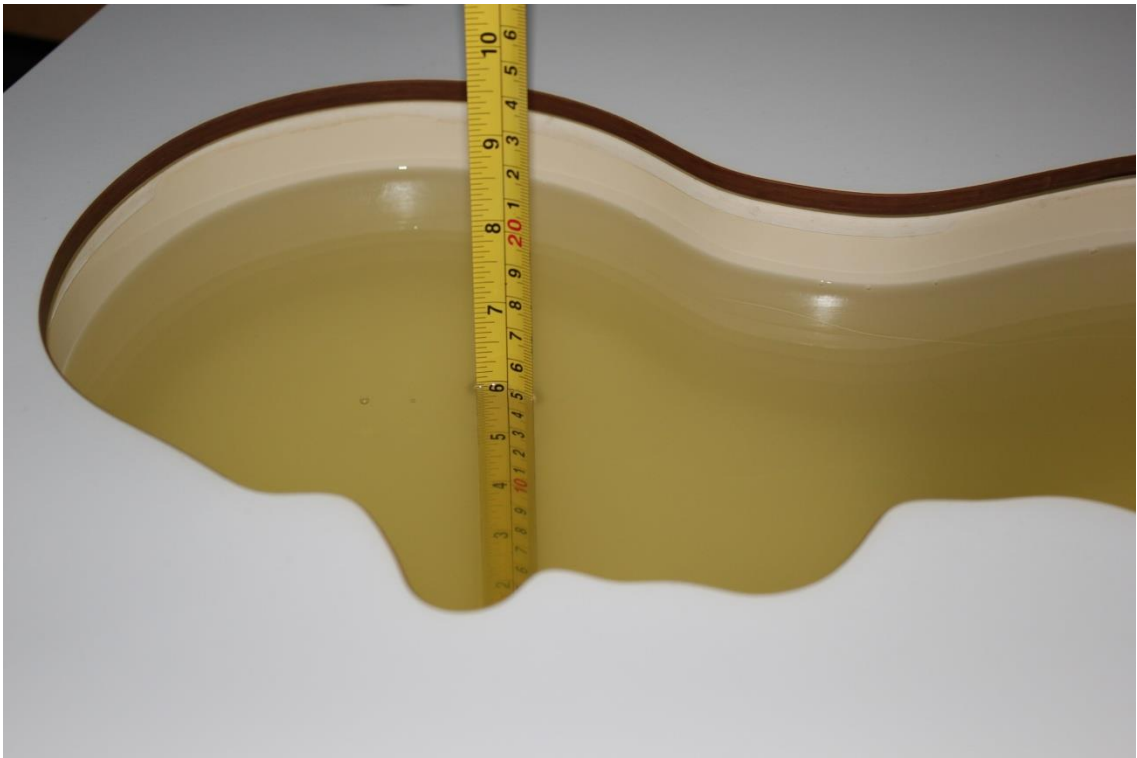

Picture 7-3 Liquid depth in the Head Phantom (1750 MHz)

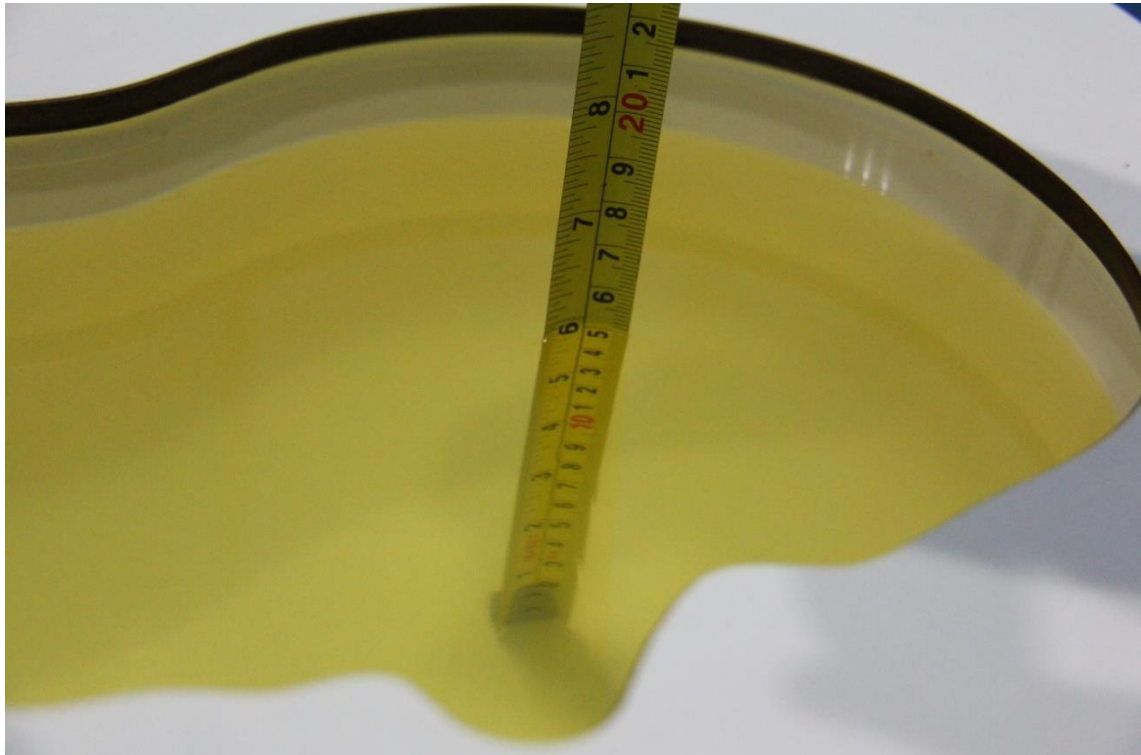

Picture 7-4 Liquid depth in the Head Phantom (1900 MHz)

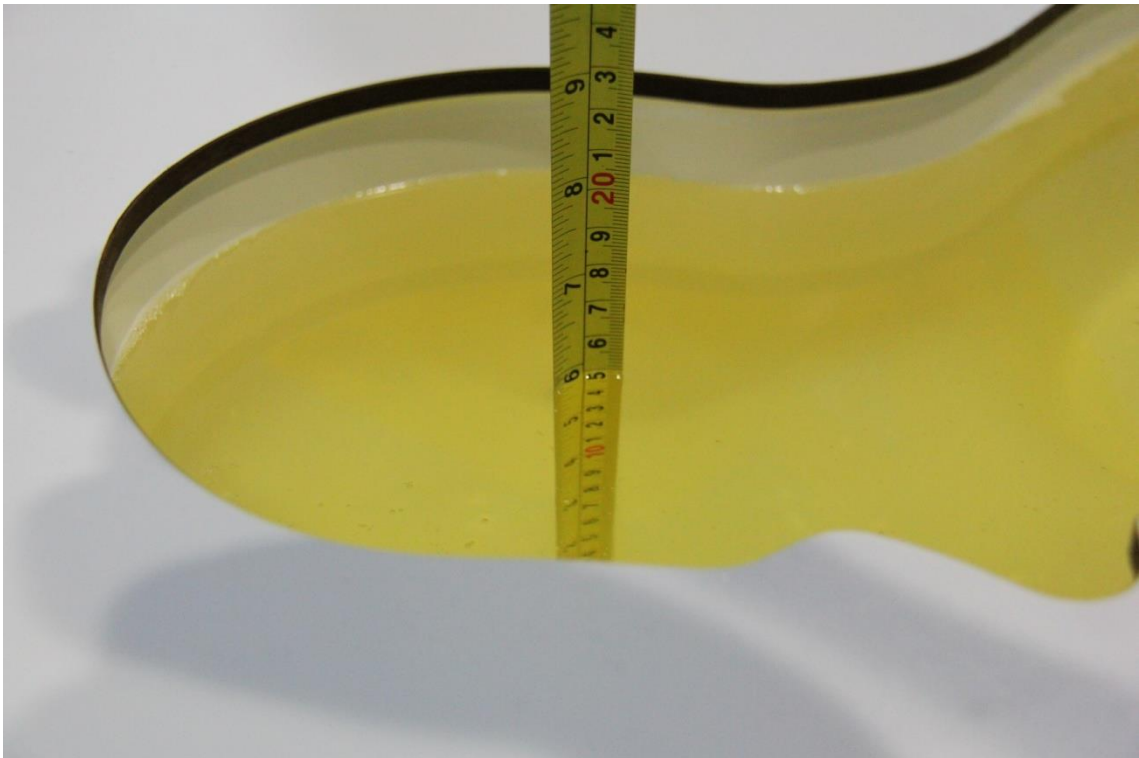

Picture 7-5 Liquid depth in the Head Phantom (2450MHz)



Picture 7-6 Liquid depth in the Head Phantom (2600 MHz)



Picture 7-7 Liquid depth in the Head Phantom (5GHz)

8 System verification

8.1 System Setup

In the simplified setup for system evaluation, the DUT is replaced by a calibrated dipole and the power source is replaced by a continuous wave that comes from a signal generator. The calibrated dipole must be placed beneath the flat phantom section of the SAM twin phantom with the correct distance holder. The distance holder should touch the phantom surface with a light pressure at the reference marking and be oriented parallel to the long side of the phantom. The equipment setup is shown below:

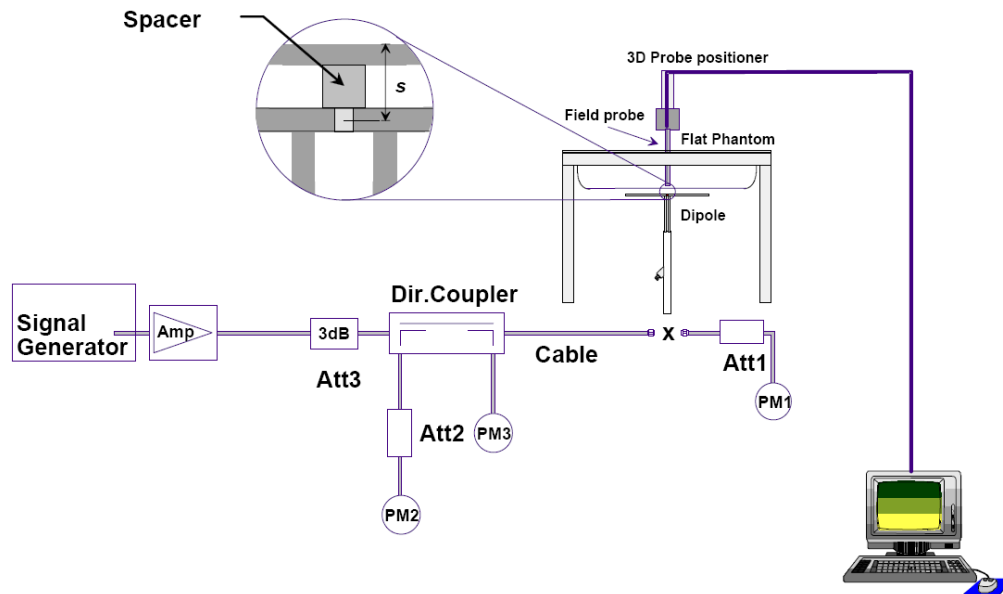

Picture 8.1 System Setup for System Evaluation

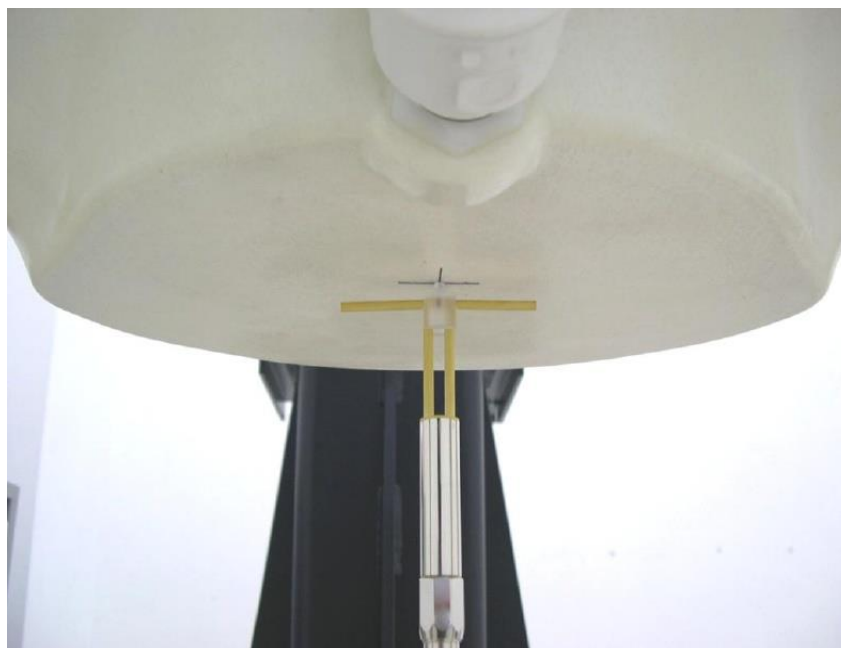

Picture 8.2 Photo of Dipole Setup

8.2 System Verification

SAR system verification is required to confirm measurement accuracy, according to the tissue dielectric media, probe calibration points and other system operating parameters required for measuring the SAR of a test device. The system verification must be performed for each frequency band and within the valid range of each probe calibration point required for testing the device.

The system verification results are required that the area scan estimated 1-g SAR is within 3% of the zoom scan 1-g SAR. The details are presented in annex B.

Table 8.1: System Verification of Head

Measurement Date (yyyy-mm-dd)	Frequency	Target value (W/kg)		Measured value (W/kg)		Deviation	
		10 g Average	1 g Average	10 g Average	1 g Average	10 g Average	1 g Average
2021/3/5	750 MHz	5.53	8.47	5.44	8.64	-1.63%	2.01%
2021/3/6	835 MHz	6.25	9.60	6.20	9.72	-0.80%	1.25%
2021/3/7	1750 MHz	19.1	36.5	19.48	36.36	1.99%	-0.38%
2021/3/8	1900 MHz	20.6	39.6	20.52	39.96	-0.39%	0.91%
2021/3/9	2450 MHz	24.5	52.5	24.8	52	1.22%	-0.95%
2021/3/10	2600 MHz	25.3	57.0	25.36	56.8	0.24%	-0.35%
2021/3/11	5250 MHz	22.9	80.5	23.2	80.0	1.14%	-0.62%
2021/3/12	5600 MHz	23.6	83.3	23.5	83.5	-0.34%	0.26%
2021/3/13	5750 MHz	22.7	80.4	23.0	79.6	1.32%	-1.00%

9 Measurement Procedures

9.1 Tests to be performed

In order to determine the highest value of the peak spatial-average SAR of a handset, all device positions, configurations and operational modes shall be tested for each frequency band according to steps 1 to 3 below. A flowchart of the test process is shown in picture 9.1.

Step 1: The tests described in 9.2 shall be performed at the channel that is closest to the centre of the transmit frequency band (f_c) for:

- a) all device positions (cheek and tilt, for both left and right sides of the SAM phantom, as described in annex D),
- b) all configurations for each device position in a), e.g., antenna extended and retracted, and
- c) all operational modes, e.g., analogue and digital, for each device position in a) and configuration in b) in each frequency band.

If more than three frequencies need to be tested according to 11.1 (i.e., $N_c > 3$), then all frequencies, configurations and modes shall be tested for all of the above test conditions.

Step 2: For the condition providing highest peak spatial-average SAR determined in Step 1, perform all tests described in 9.2 at all other test frequencies, i.e., lowest and highest frequencies. In addition, for all other conditions (device position, configuration and operational mode) where the peak spatial-average SAR value determined in Step 1 is within 3 dB of the applicable SAR limit, it is recommended that all other test frequencies shall be tested as well.

Step 3: Examine all data to determine the highest value of the peak spatial-average SAR found in Steps 1 to 2.

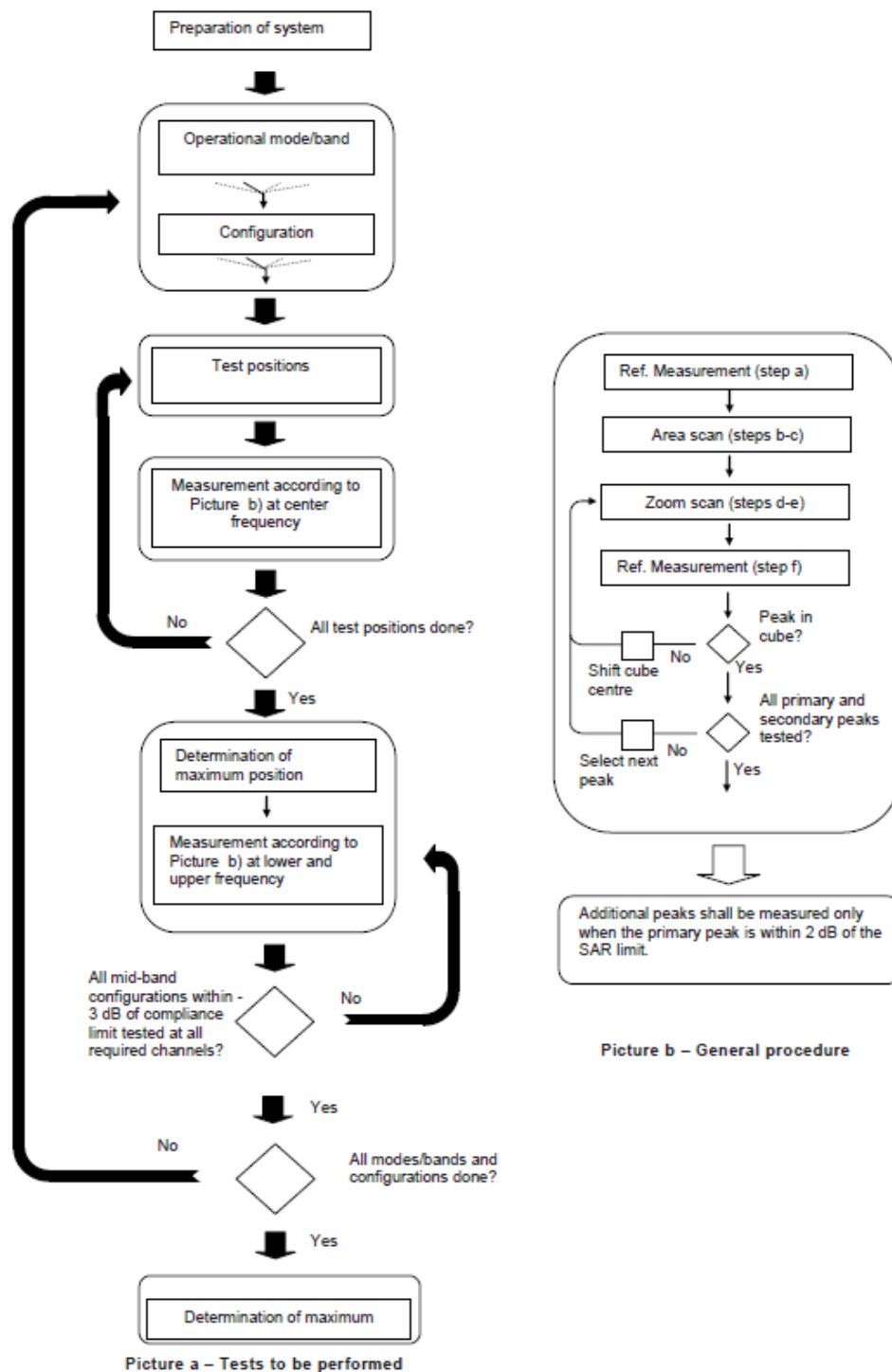

Picture 9.1 Block diagram of the tests to be performed

9.2 General Measurement Procedure

The area and zoom scan resolutions specified in the table below must be applied to the SAR measurements and fully documented in SAR reports to qualify for TCB approval. Probe boundary effect error compensation is required for measurements with the probe tip closer than half a probe tip diameter to the phantom surface. Both the probe tip diameter and sensor offset distance must satisfy measurement protocols; to ensure probe boundary effect errors are minimized and the

higher fields closest to the phantom surface can be correctly measured and extrapolated to the phantom surface for computing 1-g SAR. Tolerances of the post-processing algorithms must be verified by the test laboratory for the scan resolutions used in the SAR measurements, according to the reference distribution functions specified in IEEE Std 1528-2003. The results should be documented as part of the system validation records and may be requested to support test results when all the measurement parameters in the following table are not satisfied.

		≤ 3 GHz	> 3 GHz	
Maximum distance from closest measurement point (geometric center of probe sensors) to phantom surface		5 ± 1 mm	$\frac{1}{2} \cdot \delta \cdot \ln(2) \pm 0.5$ mm	
Maximum probe angle from probe axis to phantom surface normal at the measurement location		$30^\circ \pm 1^\circ$	$20^\circ \pm 1^\circ$	
Maximum area scan spatial resolution: Δx_{Area} , Δy_{Area}		≤ 2 GHz: ≤ 15 mm 2 – 3 GHz: ≤ 12 mm	3 – 4 GHz: ≤ 12 mm 4 – 6 GHz: ≤ 10 mm	
		When the x or y dimension of the test device, in the measurement plane orientation, is smaller than the above, the measurement resolution must be \leq the corresponding x or y dimension of the test device with at least one measurement point on the test device.		
Maximum zoom scan spatial resolution: Δx_{Zoom} , Δy_{Zoom}		≤ 2 GHz: ≤ 8 mm 2 – 3 GHz: ≤ 5 mm*	3 – 4 GHz: ≤ 5 mm* 4 – 6 GHz: ≤ 4 mm*	
Maximum zoom scan spatial resolution, normal to phantom surface	uniform grid: $\Delta z_{Zoom}(n)$	≤ 5 mm	3 – 4 GHz: ≤ 4 mm 4 – 5 GHz: ≤ 3 mm 5 – 6 GHz: ≤ 2 mm	
	graded grid	$\Delta z_{Zoom}(1)$: between 1 st two points closest to phantom surface	≤ 4 mm	3 – 4 GHz: ≤ 3 mm 4 – 5 GHz: ≤ 2.5 mm 5 – 6 GHz: ≤ 2 mm
		$\Delta z_{Zoom}(n>1)$: between subsequent points	$\leq 1.5 \cdot \Delta z_{Zoom}(n-1)$	
Minimum zoom scan volume	x, y, z	≥ 30 mm	3 – 4 GHz: ≥ 28 mm 4 – 5 GHz: ≥ 25 mm 5 – 6 GHz: ≥ 22 mm	
Note: δ is the penetration depth of a plane-wave at normal incidence to the tissue medium; see draft standard IEEE P1528-2011 for details. * When zoom scan is required and the <i>reported</i> SAR from the area scan based 1-g SAR estimation procedures of KDB 447498 is ≤ 1.4 W/kg, ≤ 8 mm, ≤ 7 mm and ≤ 5 mm zoom scan resolution may be applied, respectively, for 2 GHz to 3 GHz, 3 GHz to 4 GHz and 4 GHz to 6 GHz.				

9.3 WCDMA Measurement Procedures for SAR

The following procedures are applicable to WCDMA handsets operating under 3GPP Release99, Release 5 and Release 6. The default test configuration is to measure SAR with an established radio link between the DUT and a communication test set using a 12.2kbps RMC (reference measurement channel) configured in Test Loop Mode 1. SAR is selectively confirmed for other physical channel configurations (DPCCH & DPDCH_n), HSDPA and HSPA (HSUPA/HSDPA) modes according to output power, exposure conditions and device operating capabilities. Both uplink and downlink should be configured with the same RMC or AMR, when required. SAR for Release 5 HSDPA and Release 6 HSPA are measured using the applicable FRC (fixed reference channel) and E-DCH reference channel configurations. Maximum output power is verified according to applicable versions of 3GPP TS 34.121 and SAR must be measured according to these maximum output conditions. When Maximum Power Reduction (MPR) is not implemented according to Cubic Metric (CM) requirements for Release 6 HSPA, the following procedures do not apply.

For Release 5 HSDPA Data Devices:

Sub-test	β_c	β_d	β_d (SF)	β_c / β_d	β_{hs}	CM/dB
1	2/15	15/15	64	2/15	4/15	0.0
2	12/15	15/15	64	12/15	24/25	1.0
3	15/15	8/15	64	15/8	30/15	1.5
4	15/15	4/15	64	15/4	30/15	1.5

For Release 6 HSPA Data Devices

Sub-test	β_c	β_d	β_d (SF)	β_c / β_d	β_{hs}	β_{ec}	β_{ed}	β_{ed} (SF)	β_{ed} (codes)	CM (dB)	MPR (dB)	AG Index	E-TFCI
1	11/15	15/15	64	11/15	22/15	209/225	1039/225	4	1	1.5	1.5	20	75
2	6/15	15/15	64	6/15	12/15	12/15	12/15	4	1	1.5	1.5	12	67
3	15/15	9/15	64	15/9	30/15	30/15	$\beta_{ed1}:47/15$ $\beta_{ed2}:47/15$	4	2	1.5	1.5	15	92
4	2/15	15/15	64	2/15	4/15	4/15	56/75	4	1	1.5	1.5	17	71
5	15/15	15/15	64	15/15	24/15	30/15	134/15	4	1	1.5	1.5	21	81

Rel.8 DC-HSDPA (Cat 24)

SAR test exclusion for Rel.8 DC-HSDPA must satisfy the SAR test exclusion requirements of Rel.5 HSDPA. SAR test exclusion for DC-HSDPA devices is determined by power measurements according to the H-Set 12, Fixed Reference Channel (FRC) configuration in Table C.8.1.12 of 3GPP TS 34.121-1. A primary and a secondary serving HS-DSCH Cell are required to perform the power measurement and for the results to qualify for SAR test exclusion.

9.4 SAR Measurement for LTE

SAR tests for LTE are performed with a base station simulator, Rohde & Schwarz CMW500. Closed loop power control was used so the UE transmits with maximum output power during SAR testing. All powers were measured with the CMW 500.

It is performed for conducted power and SAR based on the KDB941225 D05.

SAR is evaluated separately according to the following procedures for the different test positions in each exposure condition – head, body, body-worn accessories and other use conditions. The procedures in the following subsections are applied separately to test each LTE frequency band.

1) QPSK with 1 RB allocation

Start with the largest channel bandwidth and measure SAR for QPSK with 1 RB allocation, using the RB offset and required test channel combination with the highest maximum output power among RB offsets at the upper edge, middle and lower edge of each required test channel. When the reported SAR is ≤ 0.8 W/kg, testing of the remaining RB offset configurations and required test channels is not required for 1 RB allocation; otherwise, SAR is required for the remaining required test channels and only for the RB offset configuration with the highest output power for that channel. When the reported SAR of a required test channel is > 1.45 W/kg, SAR is required for all three RB offset configurations for that required test channel.

2) QPSK with 50% RB allocation

The procedures required for 1 RB allocation in 1) are applied to measure the SAR for QPSK with 50% RB allocation.

3) QPSK with 100% RB allocation

For QPSK with 100% RB allocation, SAR is not required when the highest maximum output power for 100 % RB allocation is less than the highest maximum output power in 50% and 1 RB allocations and the highest reported SAR for 1 RB and 50% RB allocation in 1) and 2) are ≤ 0.8 W/kg. Otherwise, SAR is measured for the highest output power channel; and if the reported SAR is > 1.45 W/kg, the remaining required test channels must also be tested.

TDD test:

TDD testing is performed using guidance from FCC KDB 941225 D05 v02r05 and the SAR test guidance provided in April 2013 TCB works hop notes. TDD is tested at the highest duty factor using UL-DL configuration 0 with special subframe configuration 6 and applying the FDD LTE procedures in KDB 941225 D05 v02r05. SAR testing is performed using the extended cyclic prefix listed in 3GPP TS 36.211.

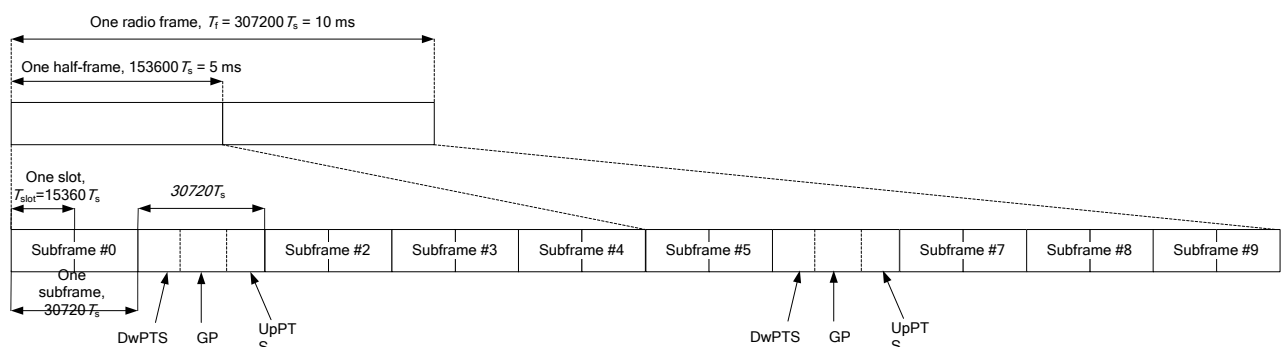

Figure 9.2: Frame structure type 2 (for 5 ms switch-point periodicity)

Table 9.1: Configuration of special subframe (lengths of DwPTS/GP/UpPTS)

Special subframe configuration	Normal cyclic prefix in downlink			Extended cyclic prefix in downlink		
	DwPTS	UpPTS		DwPTS	UpPTS	
		Normal cyclic prefix in uplink	Extended cyclic prefix in uplink		Normal cyclic prefix in uplink	Extended cyclic prefix in uplink
0	$6592 \cdot T_s$	$2192 \cdot T_s$	$2560 \cdot T_s$	$7680 \cdot T_s$	$2192 \cdot T_s$	$2560 \cdot T_s$
1	$19760 \cdot T_s$			$20480 \cdot T_s$		
2	$21952 \cdot T_s$			$23040 \cdot T_s$		
3	$24144 \cdot T_s$			$25600 \cdot T_s$		
4	$26336 \cdot T_s$	$4384 \cdot T_s$	$5120 \cdot T_s$	$7680 \cdot T_s$	$4384 \cdot T_s$	$5120 \cdot T_s$
5	$6592 \cdot T_s$			$20480 \cdot T_s$		
6	$19760 \cdot T_s$			$23040 \cdot T_s$		
7	$21952 \cdot T_s$			$12800 \cdot T_s$		
8	$24144 \cdot T_s$			-	-	-
9	$13168 \cdot T_s$			-	-	-

Table 9.2: Uplink-downlink configurations

Uplink-downlink configuration	Downlink-to-Uplink Switch-point periodicity	Subframe number									
		0	1	2	3	4	5	6	7	8	9
0	5 ms	D	S	U	U	U	D	S	U	U	U
1	5 ms	D	S	U	U	D	D	S	U	U	D
2	5 ms	D	S	U	D	D	D	S	U	D	D
3	10 ms	D	S	U	U	U	D	D	D	D	D
4	10 ms	D	S	U	U	D	D	D	D	D	D
5	10 ms	D	S	U	D	D	D	D	D	D	D
6	5 ms	D	S	U	U	U	D	S	U	U	D

Duty factor is calculated by:

$$\begin{aligned}
 \text{Duty factor} &= \text{uplink frame} \cdot 6 + \text{UpPTS} \cdot 2 / \text{one frame length} \\
 &= (30720 \cdot T_s \cdot 6 + 5120 \cdot T_s \cdot 2) / 307200 \cdot T_s \\
 &= 0.633
 \end{aligned}$$

According to the KDB 447498 D01, SAR should be evaluated at more than 3 frequencies for devices supporting transmit bands wider than 100MHz. Oct.2014 FCC-TCB conference notes (Dec. 2014 rev.) specifies the 5 test channels to use for 3GPP band 41 SAR evaluation.

9.5 Bluetooth & Wi-Fi Measurement Procedures for SAR

Normal network operating configurations are not suitable for measuring the SAR of 802.11 transmitters in general. Unpredictable fluctuations in network traffic and antenna diversity conditions can introduce undesirable variations in SAR results. The SAR for these devices should be measured using chipset based test mode software to ensure that the results are consistent and reliable.

Chipset based test mode software is hardware dependent and generally varies among manufacturers. The device operating parameters established in a test mode for SAR measurements must be identical to those programmed in production units, including output power levels, amplifier gain settings and other RF performance tuning parameters. The test frequencies should correspond to actual channel frequencies defined for domestic use. SAR for devices with switched diversity should be measured with only one antenna transmitting at a time during each SAR measurement, according to a fixed modulation and data rate. The same data pattern should be used for all measurements.

9.6 Power Drift

To control the output power stability during the SAR test, DASY4 system calculates the power drift by measuring the E-field at the same location at the beginning and at the end of the measurement for each test position. These drift values can be found in section 14 labeled as: (Power Drift [dB]). This ensures that the power drift during one measurement is within 5%.

10 Area Scan Based 1-g SAR

10.1 Requirement of KDB

According to the KDB447498 D01 v05, when the implementation is based the specific polynomial fit algorithm as presented at the 29th Bioelectromagnetics Society meeting (2007) and the estimated 1-gSAR is ≤ 1.2 W/kg, a zoom scan measurement is not required provided it is also not needed for any other purpose; for example, if the peak SAR location required for simultaneous transmission SAR test exclusion can be determined accurately by the SAR system or manually to discriminate between distinctive peaks and scattered noisy SAR distributions from area scans.

There must not be any warning or alert messages due to various measurement concerns identified by the SAR system; for example, noise in measurements, peaks too close to scan boundary, peaks are too sharp, spatial resolution and uncertainty issues etc. The SAR system verification must also demonstrate that the area scan estimated 1-g SAR is within 3% of the zoom scan 1-g SAR (See Annex B). When all the SAR results for each exposure condition in a frequency band and wireless mode are based on estimated 1-g SAR, the 1-g SAR for the highest SAR configuration must be determined by a zoom scan.

10.2 Fast SAR Algorithms

The approach is based on the area scan measurement applying a frequency dependent attenuation parameter. This attenuation parameter was empirically determined by analyzing a large number of phones. The MOTOROLA FAST SAR was developed and validated by the MOTOROLA Research Group in Ft. Lauderdale.

In the initial study, an approximation algorithm based on Linear fit was developed. The accuracy of the algorithm has been demonstrated across a broad frequency range (136-2450 MHz) and for both 1- and 10-g averaged SAR using a sample of 264 SAR measurements from 55 wireless handsets. For the sample size studied, the root-mean-squared errors of the algorithm are 1.2% and 5.8% for 1- and 10-g averaged SAR, respectively. The paper describing the algorithm in detail is expected to be published in August 2004 within the Special Issue of Transactions on MTT.

In the second step, the same research group optimized the fitting algorithm to an Polynomial fit whereby the frequency validity was extended to cover the range 30-6000MHz. Details of this study can be found in the BEMS 2007 Proceedings.

Both algorithms are implemented in DASY software.

11 Conducted Output Power

Table1: Summary of Receiver detection mechanism

Antenna	Receiver on (head scenario)	Receiver off (Body/other scenario)	Receiver off + Hotspot on (Body/other scenario)
Main antenna	Power Level A1	Power Level B1	Power Level C1

11.1 GSM Measurement result

During the process of testing, the EUT was controlled via Agilent Digital Radio Communication tester (E5515C) to ensure the maximum power transmission and proper modulation. This result contains conducted output power for the EUT. In all cases, the measured peak output power should be greater and within 5% than EMI measurement.

Table 11.1-1: The conducted power measurement results for GSM, GPRS and EGPRS- Level A1/B1

GSM 850 Speech (GMSK)	Measured Power (dBm)			Tune up	calculation	Averaged Power (dBm)		
	251	190	128			251	190	128
1 Txslot	32.45	32.43	32.43	34.00	/	/	/	/
GSM 850 GPRS (GMSK)	Measured Power (dBm)				calculation	Averaged Power (dBm)		
	251	190	128			251	190	128
1 Txslot	32.44	32.34	32.33	34.00	-9.03	23.41	23.31	23.30
2 Txslots	30.86	30.76	30.68	32.00	-6.02	24.84	24.74	24.66
3Txslots	29.32	29.20	29.14	31.00	-4.26	25.06	24.94	24.88
4 Txslots	28.05	27.93	27.86	29.50	-3.01	25.04	24.92	24.85
GSM 850 EGPRS (GMSK)	Measured Power (dBm)				calculation	Averaged Power (dBm)		
	251	190	128			251	190	128
1 Txslot	32.37	32.31	32.31	34.00	-9.03	23.34	23.28	23.28
2 Txslots	30.78	30.72	30.64	32.00	-6.02	24.76	24.70	24.62
3Txslots	29.24	29.15	29.11	31.00	-4.26	24.98	24.89	24.85
4 Txslots	27.96	27.89	27.82	29.50	-3.01	24.95	24.88	24.81
GSM 850 EGPRS (8PSK)	Measured Power (dBm)				calculation	Averaged Power (dBm)		
	251	190	128			251	190	128
1 Txslot	26.02	26.41	26.95	27.50	-9.03	16.99	17.38	17.92
2 Txslots	24.36	24.01	24.11	26.00	-6.02	18.34	17.99	18.09
3Txslots	22.67	22.61	22.82	24.50	-4.26	18.41	18.35	18.56
4 Txslots	21.51	21.62	21.82	23.50	-3.01	18.50	18.61	18.81

NOTES:

1) Division Factors

To average the power, the division factor is as follows:

1TX-slot = 1 transmit time slot out of 8 time slots=> conducted power divided by (8/1) => -9.03dB

2TX-slots = 2 transmit time slots out of 8 time slots=> conducted power divided by (8/2) => -6.02dB

3TX-slots = 3 transmit time slots out of 8 time slots=> conducted power divided by (8/3) => -4.26dB

4TX-slots = 4 transmit time slots out of 8 time slots=> conducted power divided by (8/4) => -3.01dB

According to the conducted power as above, the body measurements are performed with 3Txslots for GSM850

Table 11.1-2: The conducted power measurement results for GSM, GPRS and EGPRS [Level A1](#)

PCS1900 Speech (GMSK)	Measured Power (dBm)			Tune up	calculation	Averaged Power (dBm)		
	810	661	512			810	661	512
1 Txslot	28.61	28.76	28.83	30.50	/	/	/	/
PCS1900 GPRS (GMSK)	Measured Power (dBm)				calculation	Averaged Power (dBm)		
	810	661	512			810	661	512
1 Txslot	28.76	28.86	28.96	30.00	-9.03	19.73	19.83	19.93
2 Txslots	27.15	27.63	27.77	28.00	-6.02	21.13	21.61	21.75
3Txslots	25.26	25.38	25.59	26.50	-4.26	21.00	21.12	21.33
4 Txslots	24.01	24.26	24.40	26.00	-3.01	21.00	21.25	21.39
PCS1900 EGPRS (GMSK)	Measured Power (dBm)				calculation	Averaged Power (dBm)		
	810	661	512			810	661	512
1 Txslot	28.76	28.86	28.93	30.00	-9.03	19.73	19.83	19.90
2 Txslots	27.13	27.61	27.74	28.00	-6.02	21.11	21.59	21.72
3Txslots	25.25	25.37	25.55	26.50	-4.26	20.99	21.11	21.29
4 Txslots	24.00	24.25	24.37	26.00	-3.01	20.99	21.24	21.36
PCS1900 EGPRS (8PSK)	Measured Power (dBm)				calculation	Averaged Power (dBm)		
	810	661	512			810	661	512
1 Txslot	24.59	25.09	24.90	26.50	-9.03	15.56	16.06	15.87
2 Txslots	22.82	23.10	23.12	24.00	-6.02	16.80	17.08	17.10
3Txslots	21.82	21.79	22.11	22.50	-4.26	17.56	17.53	17.85
4 Txslots	20.25	20.63	20.54	21.50	-3.01	17.24	17.62	17.53

NOTES:

1) Division Factors

To average the power, the division factor is as follows:

1TX-slot = 1 transmit time slot out of 8 time slots=> conducted power divided by (8/1) => -9.03dB

2TX-slots = 2 transmit time slots out of 8 time slots=> conducted power divided by (8/2) => -6.02dB

3TX-slots = 3 transmit time slots out of 8 time slots=> conducted power divided by (8/3) => -4.26dB

4TX-slots = 4 transmit time slots out of 8 time slots=> conducted power divided by (8/4) => -3.01dB

According to the conducted power as above, the body measurements are performed with 2Txslots for GSM1900.