



SAR TEST REPORT

No. I20Z62131-SEM05

For

TCL Communication Ltd.

GSM/UMTS/LTE mobile phone

Model name: 4056S, 4056SPP, 4056V

With

Hardware Version: 03

Software Version: 5ERAZZ00

FCC ID: 2ACCJN048

Issued Date: 2021-5-7

Note:

The test results in this test report relate only to the devices specified in this report. This report shall not be reproduced except in full without the written approval of CTTL.

The report must not be used by the client to claim product certification, approval, or endorsement by NVLAP, NIST, or any agency of the U.S. Government.

Test Laboratory:

CTTL, Telecommunication Technology Labs, CAICT

No. 51, Xueyuan Road, Haidian District, Beijing, P. R. China 100191.

Tel:+86(0)10-62304633-2512, Fax:+86(0)10-62304633-2504

Email: ctl_terminals@caict.ac.cn, website: www.caict.ac.cn

**REPORT HISTORY**

Report Number	Revision	Issue Date	Description
I20Z62131-SEM05	Rev.0	2021-4-26	Initial creation of test report
I20Z62131-SEM05	Rev.1	2021-5-7	Update the information on Table I.3.3-1 of test report.

TABLE OF CONTENT

1 TEST LABORATORY	5
1.1 TESTING LOCATION	5
1.2 TESTING ENVIRONMENT.....	5
1.3 PROJECT DATA	5
1.4 SIGNATURE.....	5
2 STATEMENT OF COMPLIANCE	6
3 CLIENT INFORMATION	8
3.1 APPLICANT INFORMATION	8
3.2 MANUFACTURER INFORMATION	8
4 EQUIPMENT UNDER TEST (EUT) AND ANCILLARY EQUIPMENT (AE)	9
4.1 ABOUT EUT	9
4.2 INTERNAL IDENTIFICATION OF EUT USED DURING THE TEST	9
4.3 INTERNAL IDENTIFICATION OF AE USED DURING THE TEST	9
5 TEST METHODOLOGY	10
5.1 APPLICABLE LIMIT REGULATIONS	10
5.2 APPLICABLE MEASUREMENT STANDARDS	10
6 SPECIFIC ABSORPTION RATE (SAR)	11
6.1 INTRODUCTION.....	11
6.2 SAR DEFINITION.....	11
7 TISSUE SIMULATING LIQUIDS	12
7.1 TARGETS FOR TISSUE SIMULATING LIQUID.....	12
7.2 DIELECTRIC PERFORMANCE	12
8 SYSTEM VERIFICATION	16
8.1 SYSTEM SETUP.....	16
8.2 SYSTEM VERIFICATION.....	17
9 MEASUREMENT PROCEDURES	18
9.1 TESTS TO BE PERFORMED	18
9.2 GENERAL MEASUREMENT PROCEDURE.....	20
9.3 WCDMA MEASUREMENT PROCEDURES FOR SAR	21
9.4 SAR MEASUREMENT FOR LTE.....	22
9.5 BLUETOOTH & WI-FI MEASUREMENT PROCEDURES FOR SAR	22
9.6 POWER DRIFT.....	23
10 AREA SCAN BASED 1-G SAR	24
10.1 REQUIREMENT OF KDB.....	24
10.2 FAST SAR ALGORITHMS.....	24



11 CONDUCTED OUTPUT POWER.....	25
11.1 GSM MEASUREMENT RESULT	25
11.2 WCDMA MEASUREMENT RESULT	27
11.3 LTE MEASUREMENT RESULT	29
11.3 WI-FI AND BT MEASUREMENT RESULT	38
12 SIMULTANEOUS TX SAR CONSIDERATIONS.....	39
12.1 INTRODUCTION.....	39
12.2 TRANSMIT ANTENNA SEPARATION DISTANCES.....	39
12.3 SAR MEASUREMENT POSITIONS	40
12.4 STANDALONE SAR TEST EXCLUSION CONSIDERATIONS	40
13 EVALUATION OF SIMULTANEOUS.....	41
14 SAR TEST RESULT	42
14.1 SAR RESULTS FOR FAST SAR	43
14.2 SAR RESULTS FOR STANDARD PROCEDURE	51
14.3 WLAN EVALUATION FOR 2.4G	55
14.4 BT EVALUATION.....	58
15 SAR MEASUREMENT VARIABILITY.....	59
16 MEASUREMENT UNCERTAINTY	61
16.1 MEASUREMENT UNCERTAINTY FOR NORMAL SAR TESTS (300MHZ~3GHZ).....	61
16.2 MEASUREMENT UNCERTAINTY FOR NORMAL SAR TESTS (3~6GHZ)	62
16.3 MEASUREMENT UNCERTAINTY FOR FAST SAR TESTS (300MHZ~3GHZ).....	63
16.4 MEASUREMENT UNCERTAINTY FOR FAST SAR TESTS (3~6GHZ)	64
17 MAIN TEST INSTRUMENTS.....	65
ANNEX A GRAPH RESULTS.....	66
ANNEX B SYSTEM VERIFICATION RESULTS	95
ANNEX C SAR MEASUREMENT SETUP	101
ANNEX D POSITION OF THE WIRELESS DEVICE IN RELATION TO THE PHANTOM	107
ANNEX E EQUIVALENT MEDIA RECIPES.....	110
ANNEX F SYSTEM VALIDATION	111
ANNEX G PROBE CALIBRATION CERTIFICATE.....	112
ANNEX H DIPOLE CALIBRATION CERTIFICATE	134
ANNEX I VARIANT PRODUCT TEST.....	182
ANNEX J ACCREDITATION CERTIFICATE.....	240

1 Test Laboratory

1.1 Testing Location

Company Name:	CTTL(Shouxiang)
Address:	No. 51 Shouxiang Science Building, Xueyuan Road, Haidian District, Beijing, P. R. China100191

1.2 Testing Environment

Temperature:	18°C~25°C,
Relative humidity:	30%~ 70%
Ground system resistance:	< 0.5 Ω
Ambient noise & Reflection:	< 0.012 W/kg

1.3 Project Data

Project Leader:	Qi Dianyuan
Test Engineer:	Lin Xiaojun
Testing Start Date:	February 26, 2021
Testing End Date:	March 19, 2021

1.4 Signature



Lin Xiaojun

(Prepared this test report)

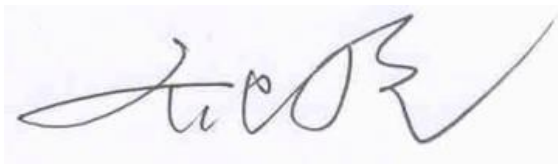

Qi Dianyuan

(Reviewed this test report)

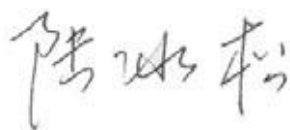

Lu Bingsong

Deputy Director of the laboratory

(Approved this test report)

2 Statement of Compliance

This EUT is a variant product and the report of original sample is No.I20Z62110-SEM01. We do the spot check on highest value point of the original report for head and body respectively, added LTE Band2/5/7/13, the SAR test result are presented in the annex I.

The maximum results of SAR found during testing for TCL Communication Ltd. GSM/UMTS/LTE mobile phone 4056S, 4056SPP, 4056V are as follows:

Table 2.1: Highest Reported SAR (1g)

Exposure Configuration	Technology Band	Highest Reported SAR 1g(W/kg)	Equipment Class
Head (Separation Distance 0mm)	GSM 850	0.54	PCE
	PCS 1900	0.29	
	UMTS FDD 2	0.64	
	UMTS FDD 4	0.61	
	UMTS FDD 5	0.78	
	LTE Band 2	0.72	
	LTE Band 5	0.83	
	LTE Band 7	0.70	
	LTE Band 12	0.61	
	LTE Band 13	0.43	
	LTE Band 66	0.44	
	WLAN 2.4 GHz	0.64	DTS
Hotspot (Separation Distance 10mm)	GSM 850	0.75	PCE
	PCS 1900	1.24	
	UMTS FDD 2	1.13	
	UMTS FDD 4	1.23	
	UMTS FDD 5	0.97	
	LTE Band 2	1.18	
	LTE Band 5	1.18	
	LTE Band 7	0.65	
	LTE Band 12	0.77	
	LTE Band 13	1.26	
	LTE Band 66	1.13	
	WLAN 2.4 GHz	0.23	DTS
Body-worn (Separation Distance 15mm)	UMTS FDD 2	1.25	PCE
	UMTS FDD 4	1.27	
	LTE Band 2	1.27	
	LTE Band 7	0.72	
	LTE Band 66	1.07	

The SAR values found for the Mobile Phone are below the maximum recommended levels of 1.6 W/kg as averaged over any 1g tissue according to the ANSI C95.1-1992.

For body operation, this device has been tested and meets FCC RF exposure guidelines when used with any accessory that contains no metal and which provides a minimum separation distance of 15 mm between this device and the body of the user. Use of other accessories may not ensure compliance with FCC RF exposure guidelines.

The EUT battery must be fully charged and checked periodically during the test to ascertain uniform power output.

The measurement together with the test system set-up is described in annex C of this test report. A detailed description of the equipment under test can be found in chapter 4 of this test report. The highest reported SAR value is obtained at the case of **(Table 2.1)**, and the values are: **1.27 W/kg(1g)**.

Table 2.2: The sum of reported SAR values for main antenna and WiFi

	Position	Main antenna	WiFi	Sum
Highest reported SAR value for Head	Right hand, Touch cheek (WCDMA850)	0.78	0.64	1.42
Highest reported SAR value for Body	Rear unfold 10mm (GSM1900)	1.24	0.23	1.47

Table 2.3: The sum of reported SAR values for main antenna and BT

	Position	Main antenna	BT	Sum
Maximum reported SAR value for Head	Right hand, Touch cheek (WCDMA850)	0.78	<0.01	0.78
Maximum reported SAR value for Body	Rear 15mm (WCDMA1700)	1.27	<0.01	1.27

According to the above tables, the highest sum of reported SAR values is **1.47 W/kg (1g)**. The detail for simultaneous transmission consideration is described in chapter 13.



3 Client Information

3.1 Applicant Information

Company Name:	TCL Communication Ltd.
Address/Post:	5/F, Building 22E, 22 Science Park East Avenue, Hong Kong Science Park, Shatin, NT, Hong Kong
Contact Person:	Gong Zhizhou
E-mail:	zhizhou.gong@tcl.com
Telephone:	0086-755-36611722
Fax:	0086-75536612000-81722

3.2 Manufacturer Information

Company Name:	TCL Communication Ltd.
Address/Post:	5/F, Building 22E, 22 Science Park East Avenue, Hong Kong Science Park, Shatin, NT, Hong Kong
Contact Person:	Gong Zhizhou
E-mail:	zhizhou.gong@tcl.com
Telephone:	0086-755-36611722
Fax:	0086-75536612000-81722

4 Equipment Under Test (EUT) and Ancillary Equipment (AE)

4.1 About EUT

Description:	GSM/UMTS/LTE mobile phone
Model name:	4056S, 4056SPP, 4056V
Operating mode(s):	GSM850/900/1800/1900, WCDMA850/900/1700/1900/2100 LTE Band 2/3/4/5/7/12/13/66, BT, Wi-Fi(2.4G)
Tested Tx Frequency:	824 – 849 MHz (GSM 850)
	1850 – 1910 MHz (GSM 1900)
	824–849 MHz (WCDMA 850 Band V)
	1710 – 1755 MHz (WCDMA 1700 Band IV)
	1850–1910 MHz (WCDMA1900 Band II)
	1860 – 1900 MHz (LTE Band 2)
	824.7 – 848.3 MHz (LTE Band 5)
	2502.5 – 2567.5 MHz (LTE Band 7)
	699.7 – 715.3 MHz (LTE Band 12)
	779.5 –784.5 MHz (LTE Band 13)
	1710.7 – 1779.3 MHz (LTE Band 66)
2412 – 2462 MHz (Wi-Fi 2.4G)	
GPRS/EGPRS Multislot Class:	12
GPRS capability Class:	B
Test device Production information:	Production unit
Device type:	Portable device
Antenna type:	Integrated antenna
Hotspot mode:	Support

4.2 Internal Identification of EUT used during the test

EUT ID*	IMEI	HW	SW Version
EUT1	015921000001503	03	5ERAZZ00
EUT2	015921000001487	03	5ERAZZ00
EUT3	015921000001560	03	5ERAZZ00
EUT4	015921000011486	03	5ERAZZ00
EUT5	015921000011304	03	5ERAZZ00

*EUT ID: is used to identify the test sample in the lab internally.

Note: It is performed to test SAR with the EUT1&2&3 and conducted power with the EUT4&5.

4.3 Internal Identification of AE used during the test

AE ID*	Description	Model	SN	Manufacturer
AE1	Battery	TLi017D1	/	BYD

*AE ID: is used to identify the test sample in the lab internally.

5 TEST METHODOLOGY

5.1 Applicable Limit Regulations

ANSI C95.1–1992: IEEE Standard for Safety Levels with Respect to Human Exposure to Radio Frequency Electromagnetic Fields, 3 kHz to 300 GHz.

It specifies the maximum exposure limit of **1.6 W/kg** as averaged over any 1 gram of tissue for portable devices being used within 20 cm of the user in the uncontrolled environment.

5.2 Applicable Measurement Standards

IEEE 1528–2013: Recommended Practice for Determining the Peak Spatial-Average Specific Absorption Rate (SAR) in the Human Head from Wireless Communications Devices: Measurement Techniques.

KDB447498 D01: General RF Exposure Guidance v06: Mobile and Portable Devices RF Exposure Procedures and Equipment Authorization Policies.

KDB648474 D04 Handset SAR v01r03: SAR Evaluation Considerations for Wireless Handsets.

KDB941225 D01 SAR test for 3G devices v03r01: SAR Measurement Procedures for 3G Devices

KDB941225 D05 SAR for LTE Devices v02r05: SAR Evaluation Considerations for LTE Devices

KDB941225 D06 Hotspot Mode SAR v02r01: SAR Evaluation Procedures for Portable Devices with Wireless Router Capabilities

KDB248227 D01 802.11 Wi-Fi SAR v02r02: SAR GUIDANCE FOR IEEE 802.11 (Wi-Fi) TRANSMITTERS

KDB865664 D01 SAR measurement 100 MHz to 6 GHz v01r04: SAR Measurement Requirements for 100 MHz to 6 GHz.

KDB865664 D02 RF Exposure Reporting v01r02: RF Exposure Compliance Reporting and Documentation Considerations

6 Specific Absorption Rate (SAR)

6.1 Introduction

SAR is related to the rate at which energy is absorbed per unit mass in an object exposed to a radio field. The SAR distribution in a biological body is complicated and is usually carried out by experimental techniques or numerical modeling. The standard recommends limits for two tiers of groups, occupational/controlled and general population/uncontrolled, based on a person's awareness and ability to exercise control over his or her exposure. In general, occupational/controlled exposure limits are higher than the limits for general population/uncontrolled.

6.2 SAR Definition

The SAR definition is the time derivative (rate) of the incremental energy (dW) absorbed by (dissipated in) an incremental mass (dm) contained in a volume element (dv) of a given density (ρ). The equation description is as below:

$$SAR = \frac{d}{dt} \left(\frac{dW}{dm} \right) = \frac{d}{dt} \left(\frac{dW}{\rho dv} \right)$$

SAR is expressed in units of Watts per kilogram (W/kg)

SAR measurement can be either related to the temperature elevation in tissue by

$$SAR = c \left(\frac{\delta T}{\delta t} \right)$$

Where: C is the specific heat capacity, δT is the temperature rise and δt is the exposure duration, or related to the electrical field in the tissue by

$$SAR = \frac{\sigma |E|^2}{\rho}$$

Where: σ is the conductivity of the tissue, ρ is the mass density of tissue and E is the RMS electrical field strength.

However for evaluating SAR of low power transmitter, electrical field measurement is typically applied.

7 Tissue Simulating Liquids

7.1 Targets for tissue simulating liquid

Table 7.1: Targets for tissue simulating liquid

Frequency(MHz)	Liquid Type	Conductivity(σ)	$\pm 5\%$ Range	Permittivity(ϵ)	$\pm 5\%$ Range
750	Head	0.89	0.85~0.93	41.94	39.8~44.0
835	Head	0.90	0.86~0.95	41.5	39.4~43.6
1750	Head	1.37	1.30~1.44	40.08	38.1~42.1
1900	Head	1.40	1.33~1.47	40.0	38.0~42.0
2450	Head	1.80	1.71~1.89	39.2	37.2~41.2

7.2 Dielectric Performance

Table 7.2: Dielectric Performance of Tissue Simulating Liquid

Measurement Date (yyyy-mm-dd)	Type	Frequency	Permittivity ϵ	Drift (%)	Conductivity σ (S/m)	Drift (%)
2021-2-26	Head	750 MHz	41.35	-1.41	0.888	-0.22
2021-2-27	Head	835 MHz	41.1	-0.96	0.892	-0.89
2021-2-28	Head	1750 MHz	40.82	1.85	1.377	0.51
2021-3-1	Head	1900 MHz	39.99	-0.02	1.428	2.00
2021-3-2	Head	2450 MHz	38.99	-0.54	1.78	-1.11

Note: The liquid temperature is 22.0°C

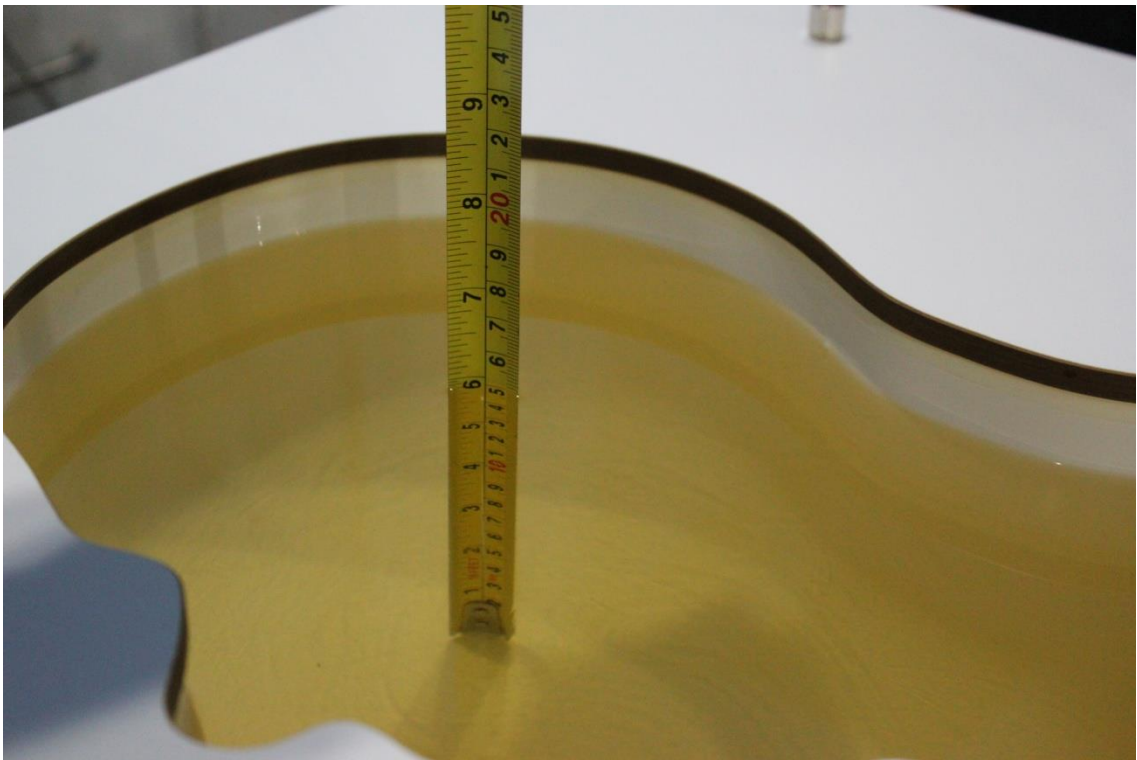

Picture 7-1 Liquid depth in the Head Phantom (750MHz)

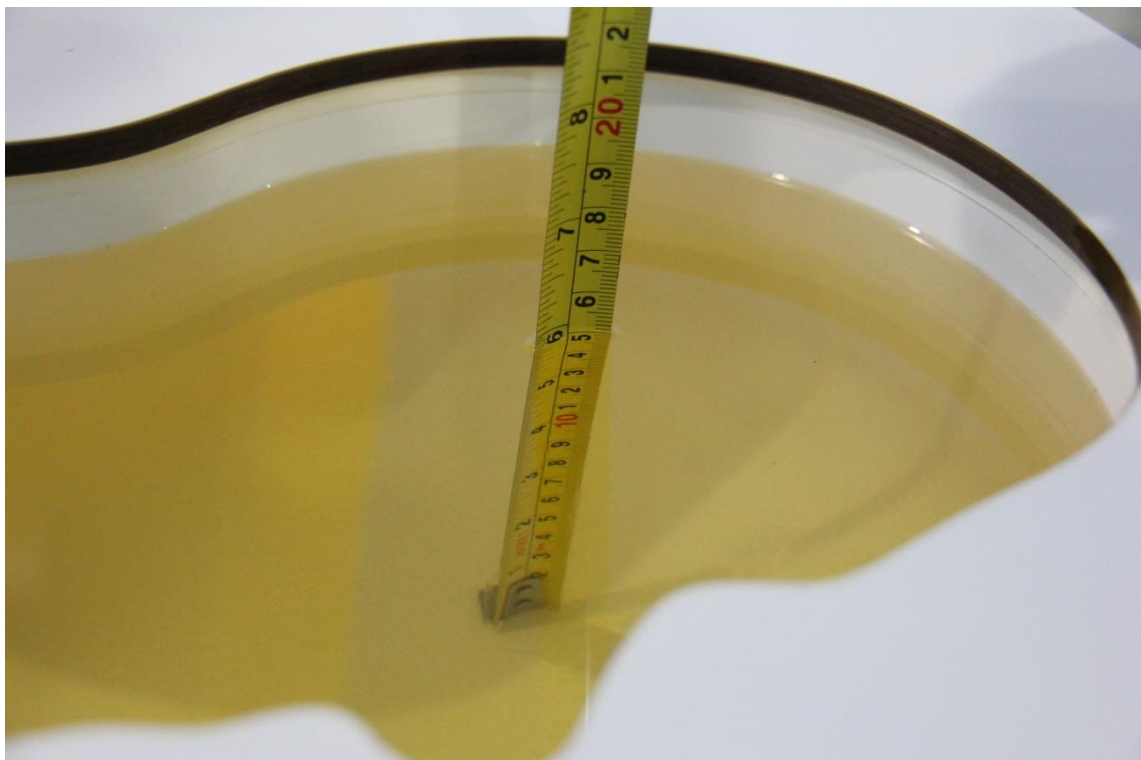

Picture 7-2 Liquid depth in the Head Phantom (835 MHz)

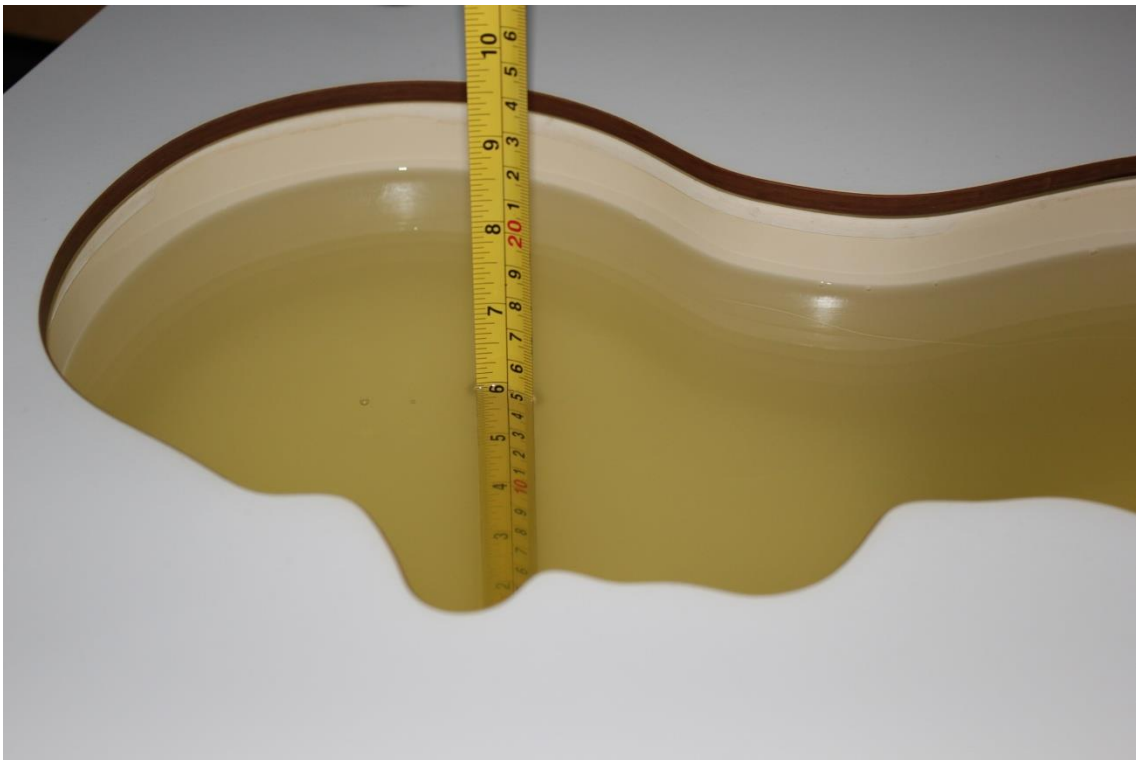

Picture 7-3 Liquid depth in the Head Phantom (1750 MHz)



Picture 7-4 Liquid depth in the Head Phantom (1900 MHz)

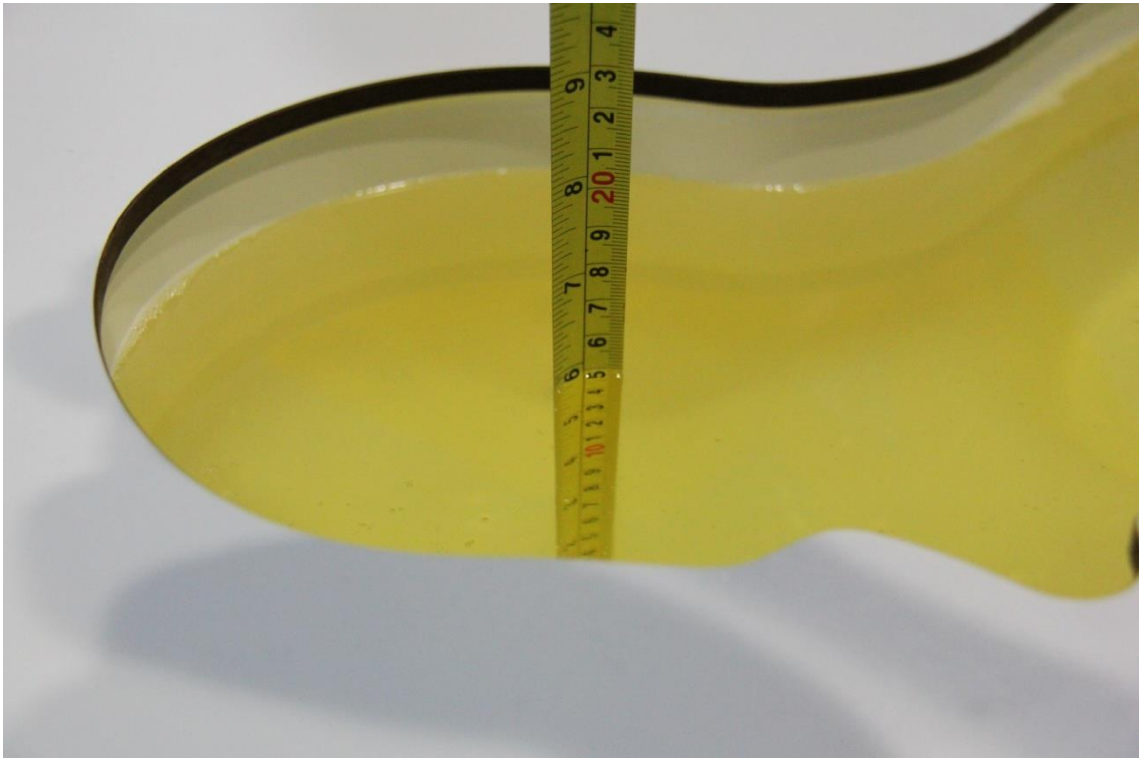

Picture 7-5 Liquid depth in the Head Phantom (2450MHz)



Picture 7-6 Liquid depth in the Head Phantom (2600 MHz)

8 System verification

8.1 System Setup

In the simplified setup for system evaluation, the DUT is replaced by a calibrated dipole and the power source is replaced by a continuous wave that comes from a signal generator. The calibrated dipole must be placed beneath the flat phantom section of the SAM twin phantom with the correct distance holder. The distance holder should touch the phantom surface with a light pressure at the reference marking and be oriented parallel to the long side of the phantom. The equipment setup is shown below:

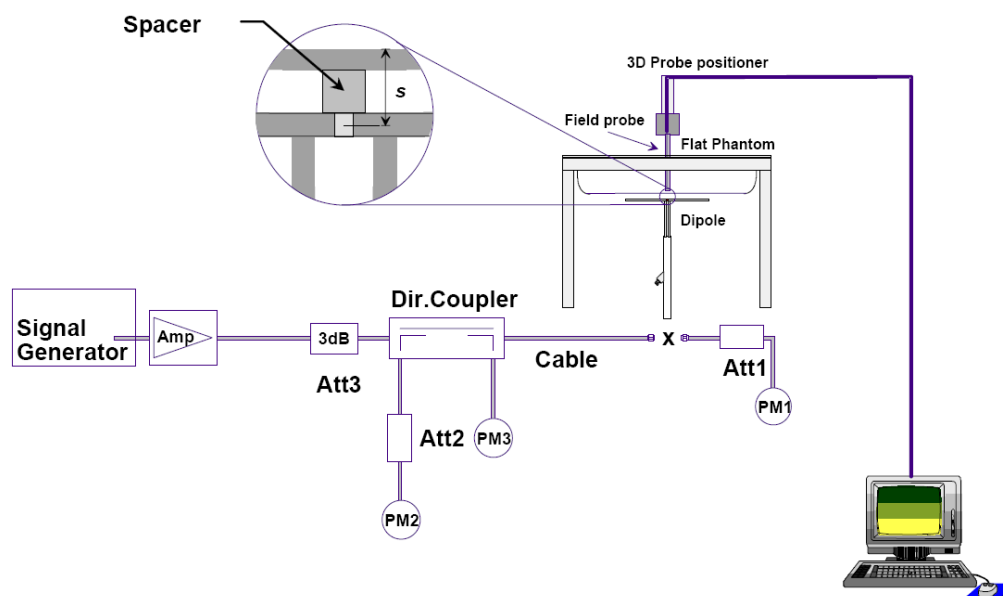

Picture 8.1 System Setup for System Evaluation



Picture 8.2 Photo of Dipole Setup

8.2 System Verification

SAR system verification is required to confirm measurement accuracy, according to the tissue dielectric media, probe calibration points and other system operating parameters required for measuring the SAR of a test device. The system verification must be performed for each frequency band and within the valid range of each probe calibration point required for testing the device.

The system verification results are required that the area scan estimated 1-g SAR is within 3% of the zoom scan 1-g SAR. The details are presented in annex B.

Table 8.1: System Verification of Head

Measurement Date (yyyy-mm-dd)	Frequency	Target value (W/kg)		Measured value(W/kg)		Deviation	
		10 g Average	1 g Average	10 g Average	1 g Average	10 g Average	1 g Average
2021/2/26	750 MHz	5.53	8.47	5.64	8.52	1.99%	0.59%
2021/2/27	835 MHz	6.25	9.60	6.28	9.48	0.48%	-1.25%
2021/2/28	1750 MHz	19.1	36.5	19.12	36.56	0.10%	0.16%
2021/3/1	1900 MHz	20.6	39.6	20.92	39.6	1.55%	0.00%
2021/3/2	2450 MHz	24.5	52.5	24.8	51.6	1.22%	-1.71%

9 Measurement Procedures

9.1 Tests to be performed

In order to determine the highest value of the peak spatial-average SAR of a handset, all device positions, configurations and operational modes shall be tested for each frequency band according to steps 1 to 3 below. A flowchart of the test process is shown in picture 9.1.

Step 1: The tests described in 9.2 shall be performed at the channel that is closest to the centre of the transmit frequency band (f_c) for:

- a) all device positions (cheek and tilt, for both left and right sides of the SAM phantom, as described in annex D),
- b) all configurations for each device position in a), e.g., antenna extended and retracted, and
- c) all operational modes, e.g., analogue and digital, for each device position in a) and configuration in b) in each frequency band.

If more than three frequencies need to be tested according to 11.1 (i.e., $N_c > 3$), then all frequencies, configurations and modes shall be tested for all of the above test conditions.

Step 2: For the condition providing highest peak spatial-average SAR determined in Step 1, perform all tests described in 9.2 at all other test frequencies, i.e., lowest and highest frequencies. In addition, for all other conditions (device position, configuration and operational mode) where the peak spatial-average SAR value determined in Step 1 is within 3 dB of the applicable SAR limit, it is recommended that all other test frequencies shall be tested as well.

Step 3: Examine all data to determine the highest value of the peak spatial-average SAR found in Steps 1 to 2.

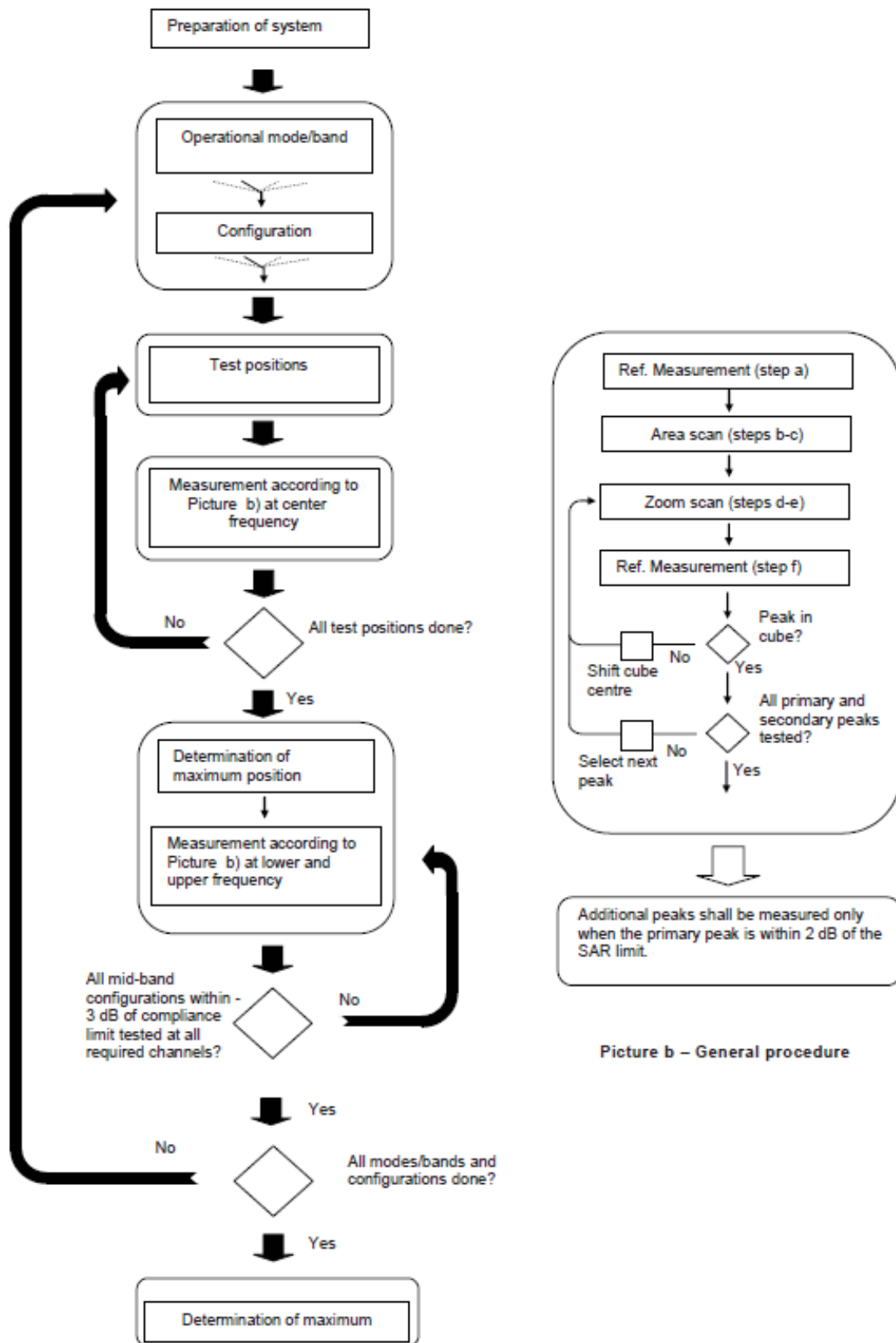

Picture a – Tests to be performed

Picture b – General procedure

Picture 9.1 Block diagram of the tests to be performed

9.2 General Measurement Procedure

The area and zoom scan resolutions specified in the table below must be applied to the SAR measurements and fully documented in SAR reports to qualify for TCB approval. Probe boundary effect error compensation is required for measurements with the probe tip closer than half a probe tip diameter to the phantom surface. Both the probe tip diameter and sensor offset distance must satisfy measurement protocols; to ensure probe boundary effect errors are minimized and the higher fields closest to the phantom surface can be correctly measured and extrapolated to the phantom surface for computing 1-g SAR. Tolerances of the post-processing algorithms must be verified by the test laboratory for the scan resolutions used in the SAR measurements, according to the reference distribution functions specified in IEEE Std 1528-2003. The results should be documented as part of the system validation records and may be requested to support test results when all the measurement parameters in the following table are not satisfied.

		≤ 3 GHz	> 3 GHz	
Maximum distance from closest measurement point (geometric center of probe sensors) to phantom surface		5 ± 1 mm	$\frac{1}{2} \cdot \delta \cdot \ln(2) \pm 0.5$ mm	
Maximum probe angle from probe axis to phantom surface normal at the measurement location		$30^\circ \pm 1^\circ$	$20^\circ \pm 1^\circ$	
Maximum area scan spatial resolution: Δx_{Area} , Δy_{Area}		≤ 2 GHz: ≤ 15 mm 2 – 3 GHz: ≤ 12 mm	3 – 4 GHz: ≤ 12 mm 4 – 6 GHz: ≤ 10 mm	
		When the x or y dimension of the test device, in the measurement plane orientation, is smaller than the above, the measurement resolution must be \leq the corresponding x or y dimension of the test device with at least one measurement point on the test device.		
Maximum zoom scan spatial resolution: Δx_{Zoom} , Δy_{Zoom}		≤ 2 GHz: ≤ 8 mm 2 – 3 GHz: ≤ 5 mm*	3 – 4 GHz: ≤ 5 mm* 4 – 6 GHz: ≤ 4 mm*	
Maximum zoom scan spatial resolution, normal to phantom surface	uniform grid: $\Delta z_{Zoom}(n)$	≤ 5 mm	3 – 4 GHz: ≤ 4 mm 4 – 5 GHz: ≤ 3 mm 5 – 6 GHz: ≤ 2 mm	
	graded grid	$\Delta z_{Zoom}(1)$: between 1 st two points closest to phantom surface	≤ 4 mm	3 – 4 GHz: ≤ 3 mm 4 – 5 GHz: ≤ 2.5 mm 5 – 6 GHz: ≤ 2 mm
		$\Delta z_{Zoom}(n>1)$: between subsequent points	$\leq 1.5 \cdot \Delta z_{Zoom}(n-1)$	
Minimum zoom scan volume	x, y, z	≥ 30 mm	3 – 4 GHz: ≥ 28 mm 4 – 5 GHz: ≥ 25 mm 5 – 6 GHz: ≥ 22 mm	
Note: δ is the penetration depth of a plane-wave at normal incidence to the tissue medium; see draft standard IEEE P1528-2011 for details. * When zoom scan is required and the <i>reported</i> SAR from the area scan based 1-g SAR estimation procedures of KDB 447498 is ≤ 1.4 W/kg, ≤ 8 mm, ≤ 7 mm and ≤ 5 mm zoom scan resolution may be applied, respectively, for 2 GHz to 3 GHz, 3 GHz to 4 GHz and 4 GHz to 6 GHz.				

9.3 WCDMA Measurement Procedures for SAR

The following procedures are applicable to WCDMA handsets operating under 3GPP Release99, Release 5 and Release 6. The default test configuration is to measure SAR with an established radio link between the DUT and a communication test set using a 12.2kbps RMC (reference measurement channel) configured in Test Loop Mode 1. SAR is selectively confirmed for other physical channel configurations (DPCCH & DPDCH_n), HSDPA and HSPA (HSUPA/HSDPA) modes according to output power, exposure conditions and device operating capabilities. Both uplink and downlink should be configured with the same RMC or AMR, when required. SAR for Release 5 HSDPA and Release 6 HSPA are measured using the applicable FRC (fixed reference channel) and E-DCH reference channel configurations. Maximum output power is verified according to applicable versions of 3GPP TS 34.121 and SAR must be measured according to these maximum output conditions. When Maximum Power Reduction (MPR) is not implemented according to Cubic Metric (CM) requirements for Release 6 HSPA, the following procedures do not apply.

For Release 5 HSDPA Data Devices:

Sub-test	β_c	β_d	β_d (SF)	β_c / β_d	β_{hs}	CM/dB
1	2/15	15/15	64	2/15	4/15	0.0
2	12/15	15/15	64	12/15	24/25	1.0
3	15/15	8/15	64	15/8	30/15	1.5
4	15/15	4/15	64	15/4	30/15	1.5

For Release 6 HSPA Data Devices

Sub-test	β_c	β_d	β_d (SF)	β_c / β_d	β_{hs}	β_{ec}	β_{ed}	β_{ed} (SF)	β_{ed} (codes)	CM (dB)	MPR (dB)	AG Index	E-TFCI
1	11/15	15/15	64	11/15	22/15	209/225	1039/225	4	1	1.5	1.5	20	75
2	6/15	15/15	64	6/15	12/15	12/15	12/15	4	1	1.5	1.5	12	67
3	15/15	9/15	64	15/9	30/15	30/15	$\beta_{ed1}:47/15$ $\beta_{ed2}:47/15$	4	2	1.5	1.5	15	92
4	2/15	15/15	64	2/15	4/15	4/15	56/75	4	1	1.5	1.5	17	71
5	15/15	15/15	64	15/15	24/15	30/15	134/15	4	1	1.5	1.5	21	81

Rel.8 DC-HSDPA (Cat 24)

SAR test exclusion for Rel.8 DC-HSDPA must satisfy the SAR test exclusion requirements of Rel.5 HSDPA. SAR test exclusion for DC-HSDPA devices is determined by power measurements according to the H-Set 12, Fixed Reference Channel (FRC) configuration in Table C.8.1.12 of 3GPP TS 34.121-1. A primary and a secondary serving HS-DSCH Cell are required to perform the power measurement and for the results to qualify for SAR test exclusion.

9.4 SAR Measurement for LTE

SAR tests for LTE are performed with a base station simulator, Rohde & Schwarz CMW500. Closed loop power control was used so the UE transmits with maximum output power during SAR testing. All powers were measured with the CMW 500.

It is performed for conducted power and SAR based on the KDB941225 D05.

SAR is evaluated separately according to the following procedures for the different test positions in each exposure condition – head, body, body-worn accessories and other use conditions. The procedures in the following subsections are applied separately to test each LTE frequency band.

1) QPSK with 1 RB allocation

Start with the largest channel bandwidth and measure SAR for QPSK with 1 RB allocation, using the RB offset and required test channel combination with the highest maximum output power among RB offsets at the upper edge, middle and lower edge of each required test channel. When the reported SAR is ≤ 0.8 W/kg, testing of the remaining RB offset configurations and required test channels is not required for 1 RB allocation; otherwise, SAR is required for the remaining required test channels and only for the RB offset configuration with the highest output power for that channel. When the reported SAR of a required test channel is > 1.45 W/kg, SAR is required for all three RB offset configurations for that required test channel.

2) QPSK with 50% RB allocation

The procedures required for 1 RB allocation in 1) are applied to measure the SAR for QPSK with 50% RB allocation.

3) QPSK with 100% RB allocation

For QPSK with 100% RB allocation, SAR is not required when the highest maximum output power for 100 % RB allocation is less than the highest maximum output power in 50% and 1 RB allocations and the highest reported SAR for 1 RB and 50% RB allocation in 1) and 2) are ≤ 0.8 W/kg. Otherwise, SAR is measured for the highest output power channel; and if the reported SAR is > 1.45 W/kg, the remaining required test channels must also be tested.

9.5 Bluetooth & Wi-Fi Measurement Procedures for SAR

Normal network operating configurations are not suitable for measuring the SAR of 802.11 transmitters in general. Unpredictable fluctuations in network traffic and antenna diversity conditions can introduce undesirable variations in SAR results. The SAR for these devices should be measured using chipset based test mode software to ensure that the results are consistent and reliable.

Chipset based test mode software is hardware dependent and generally varies among manufacturers. The device operating parameters established in a test mode for SAR measurements must be identical to those programmed in production units, including output power levels, amplifier gain settings and other RF performance tuning parameters. The test frequencies should correspond to actual channel frequencies defined for domestic use. SAR for devices with switched diversity should be measured with only one antenna transmitting at a time during each SAR measurement, according to a fixed modulation and data rate. The same data pattern should be used for all measurements.



9.6 Power Drift

To control the output power stability during the SAR test, DASY4 system calculates the power drift by measuring the E-field at the same location at the beginning and at the end of the measurement for each test position. These drift values can be found in section14 labeled as: (Power Drift [dB]). This ensures that the power drift during one measurement is within 5%.

10 Area Scan Based 1-g SAR

10.1 Requirement of KDB

According to the KDB447498 D01 v06, when the implementation is based the specific polynomial fit algorithm as presented at the 29th Bioelectromagnetics Society meeting (2007) and the estimated 1-gSAR is ≤ 1.2 W/kg, a zoom scan measurement is not required provided it is also not needed for any other purpose; for example, if the peak SAR location required for simultaneous transmission SAR test exclusion can be determined accurately by the SAR system or manually to discriminate between distinctive peaks and scattered noisy SAR distributions from area scans.

There must not be any warning or alert messages due to various measurement concerns identified by the SAR system; for example, noise in measurements, peaks too close to scan boundary, peaks are too sharp, spatial resolution and uncertainty issues etc. The SAR system verification must also demonstrate that the area scan estimated 1-g SAR is within 3% of the zoom scan 1-g SAR (See Annex B). When all the SAR results for each exposure condition in a frequency band and wireless mode are based on estimated 1-g SAR, the 1-g SAR for the highest SAR configuration must be determined by a zoom scan.

10.2 Fast SAR Algorithms

The approach is based on the area scan measurement applying a frequency dependent attenuation parameter. This attenuation parameter was empirically determined by analyzing a large number of phones. The MOTOROLA FAST SAR was developed and validated by the MOTOROLA Research Group in Ft. Lauderdale.

In the initial study, an approximation algorithm based on Linear fit was developed. The accuracy of the algorithm has been demonstrated across a broad frequency range (136-2450 MHz) and for both 1- and 10-g averaged SAR using a sample of 264 SAR measurements from 55 wireless handsets. For the sample size studied, the root-mean-squared errors of the algorithm are 1.2% and 5.8% for 1- and 10-g averaged SAR, respectively. The paper describing the algorithm in detail is expected to be published in August 2004 within the Special Issue of Transactions on MTT.

In the second step, the same research group optimized the fitting algorithm to an Polynomial fit whereby the frequency validity was extended to cover the range 30-6000MHz. Details of this study can be found in the BEMS 2007 Proceedings.

Both algorithms are implemented in DASY software.

11 Conducted Output Power

For Main antenna, there are two sets of tune-up power, Normal power and Low power, used for different use cases for W1700/1900 and LTE Band 25/66. Normal power status is applied for head test and body worn test of above bands. Low power status is applied for hotspot test of above bands. For other bands, Normal power status is applied for both head and body test.

11.1 GSM Measurement result

During the process of testing, the EUT was controlled via Agilent Digital Radio Communication tester (E5515C) to ensure the maximum power transmission and proper modulation. This result contains conducted output power for the EUT. In all cases, the measured peak output power should be greater and within 5% than EMI measurement.

Normal Power

Table 11.1-1: The conducted power measurement results for GSM, GPRS and EGPRS

GSM 850 Speech (GMSK)	Measured Power (dBm)			Tune up	calculation	Averaged Power (dBm)		
	251	190	128			251	190	128
1 Txslot	31.86	32.14	32.00	33.00	/	/	/	/
GSM 850 GPRS (GMSK)	Measured Power (dBm)				calculation	Averaged Power (dBm)		
	251	190	128			251	190	128
1 Txslot	31.87	32.09	31.97	33.00	-9.03	22.84	23.06	22.94
2 Txslots	28.43	28.36	28.41	29.50	-6.02	22.41	22.34	22.39
3Txslots	26.78	26.75	26.61	27.50	-4.26	22.52	22.49	22.35
4 Txslots	25.10	25.09	25.06	26.00	-3.01	22.09	22.08	22.05
GSM 850 EGPRS (GMSK)	Measured Power (dBm)				calculation	Averaged Power (dBm)		
	251	190	128			251	190	128
1 Txslot	31.81	32.05	31.90	33.00	-9.03	22.78	23.02	22.87
2 Txslots	28.36	28.30	28.32	29.50	-6.02	22.34	22.28	22.30
3Txslots	26.71	26.69	26.52	27.50	-4.26	22.45	22.43	22.26
4 Txslots	25.02	25.02	24.97	26.00	-3.01	22.01	22.01	21.96
GSM 850 EGPRS (8PSK)	Measured Power (dBm)				calculation	Averaged Power (dBm)		
	251	190	128			251	190	128
1 Txslot	25.58	25.61	25.67	27.00	-9.03	16.55	16.58	16.64
2 Txslots	23.76	23.81	23.89	25.00	-6.02	17.74	17.79	17.87
3Txslots	22.03	22.07	22.14	23.00	-4.26	17.77	17.81	17.88
4 Txslots	20.62	20.63	20.45	22.00	-3.01	17.61	17.62	17.44
PCS1900 Speech (GMSK)	Measured Power (dBm)			Tune up	calculation	Averaged Power (dBm)		
	810	661	512			810	661	512
1 Txslot	29.47	29.46	28.98	30.50	/	/	/	/
PCS1900 GPRS (GMSK)	Measured Power (dBm)				calculation	Averaged Power (dBm)		
	810	661	512			810	661	512
1 Txslot	29.48	29.39	28.82	30.50	-9.03	20.45	20.36	19.79
2 Txslots	26.66	26.30	25.76	27.50	-6.02	20.64	20.28	19.74

3Txslots	25.06	24.70	24.06	26.00	-4.26	20.80	20.44	19.80
4 Txslots	23.42	23.04	22.52	24.50	-3.01	20.41	20.03	19.51
PCS1900 EGPRS (GMSK)	Measured Power (dBm)				calculation	Averaged Power (dBm)		
	810	661	512			810	661	512
1 Txslot	29.48	29.40	28.81	30.50	-9.03	20.45	20.37	19.78
2 Txslots	26.67	26.32	25.74	27.50	-6.02	20.65	20.30	19.72
3Txslots	25.07	24.70	24.05	26.00	-4.26	20.81	20.44	19.79
4 Txslots	23.43	23.06	22.51	24.00	-3.01	20.42	20.05	19.50
PCS1900 EGPRS (8PSK)	Measured Power (dBm)				calculation	Averaged Power (dBm)		
	810	661	512			810	661	512
1 Txslot	24.50	24.21	24.05	26.00	-9.03	15.47	15.18	15.02
2 Txslots	23.23	22.96	22.93	24.00	-6.02	17.21	16.94	16.91
3Txslots	21.48	21.41	21.11	22.50	-4.26	17.22	17.15	16.85
4 Txslots	19.78	19.52	19.38	21.00	-3.01	16.77	16.51	16.37

NOTES:

1) Division Factors

To average the power, the division factor is as follows:

1TX-slot = 1 transmit time slot out of 8 time slots=> conducted power divided by (8/1) => -9.03dB

2TX-slots = 2 transmit time slots out of 8 time slots=> conducted power divided by (8/2) => -6.02dB

3TX-slots = 3 transmit time slots out of 8 time slots=> conducted power divided by (8/3) => -4.26dB

4TX-slots = 4 transmit time slots out of 8 time slots=> conducted power divided by (8/4) => -3.01dB

According to the conducted power as above, the body measurements are performed with 1Txslots for GSM850 and 3Txslots for GSM1900.

11.2 WCDMA Measurement result

Normal power

Table 11.2-1: The conducted Power for WCDMA

Item	band	FDDV result			
	ARFCN	4233 (846.6MHz)	4182 (836.4MHz)	4132 (826.4MHz)	Tune up
WCDMA	\	22.30	22.20	22.18	24.00
HSUPA	1	20.88	21.02	21.17	22.00
	2	20.22	20.12	20.01	21.50
	3	20.14	20.11	19.61	21.00
	4	20.23	20.58	20.54	22.00
	5	21.21	21.03	21.03	22.50
DC-HSDPA	1	21.16	21.08	21.13	23.00
	2	21.1	21.05	21.08	23.00
	3	20.62	20.54	20.56	22.50
	4	20.6	20.55	20.58	22.50
Item	band	FDDIV result			
	ARFCN	1513 (1752.6MHz)	1412 (1732.4MHz)	1312 (1712.4MHz)	
WCDMA	\	22.10	22.19	22.01	24.00
HSUPA	1	20.46	20.32	20.10	22.00
	2	19.71	19.64	19.81	21.50
	3	19.67	19.10	19.00	21.00
	4	20.1	20.39	20.12	22.00
	5	20.83	20.95	20.67	22.50
DC-HSDPA	1	20.96	20.87	20.83	22.50
	2	20.95	20.88	20.82	22.50
	3	20.46	20.38	20.32	22.00
	4	20.48	20.40	20.35	22.00
Item	band	FDDII result			
	ARFCN	9538 (1907.6MHz)	9400 (1880MHz)	9262 (1852.4MHz)	
WCDMA	\	22.16	22.28	22.21	23.00
HSUPA	1	20.94	20.84	20.58	22.50
	2	19.89	19.77	19.72	21.50
	3	19.79	19.26	20.10	21.00
	4	20.18	20.02	20.07	21.50
	5	20.86	20.80	20.87	22.50
DC-HSDPA	1	21	21.06	21.09	23.00
	2	21.06	21.30	21.00	23.00
	3	20.52	20.55	20.58	22.50
	4	20.51	20.54	20.56	22.50

Low power

Table 11.2-2: The conducted Power for WCDMA

Item	band	FDDIV result			
	ARFCN	1513 (1752.6MHz)	1412 (1732.4MHz)	1312 (1712.4MHz)	
WCDMA	\	19.34	19.48	19.26	20.00
HSUPA	1	17.76	18.25	18.01	19.00
	2	17.36	17.24	17.23	18.50
	3	16.5	17.03	17.03	18.00
	4	17.29	17.87	17.56	19.00
	5	18.2	18.23	18.04	19.50
DC-HSDPA	1	18.48	18.40	18.29	19.50
	2	18.39	18.32	18.26	19.50
	3	17.88	17.83	17.78	19.00
	4	17.9	17.84	17.80	19.00
Item	band	FDDII result			
	ARFCN	9538 (1907.6MHz)	9400 (1880MHz)	9262 (1852.4MHz)	
WCDMA	\	19.63	19.67	19.56	20.00
HSUPA	1	17.53	17.66	17.84	19.50
	2	16.98	16.88	17.35	18.00
	3	16.99	16.90	16.80	18.00
	4	17.04	17.30	17.84	18.50
	5	18.07	18.27	18.29	19.50
DC-HSDPA	1	18.47	18.52	18.52	20.00
	2	18.42	18.48	18.49	20.00
	3	17.96	18.01	18.03	19.50
	4	17.98	18.02	18.04	19.50

11.3 LTE Measurement result

Table 13.3-1: Maximum Power Reduction (MPR) for LTE- Normal Power

Modulation	Channel bandwidth / Transmission bandwidth configuration [RB]						MPR (dB)
	1.4 MHz	3 MHz	5 MHz	10 MHz	15 MHz	20 MHz	
QPSK	> 5	> 4	> 8	> 12	> 16	> 18	1
16 QAM	≤ 5	≤ 4	≤ 8	≤ 12	≤ 16	≤ 18	1
16 QAM	> 5	> 4	> 8	> 12	> 16	> 18	2

Table 13.3-2: The tune up for LTE – Normal Power

Band	Tune up
LTE Band 12	23.5
LTE Band 66	23.5

Table 13.3-3: Maximum Power Reduction (MPR) for LTE- Low Power

Modulation	Channel bandwidth / Transmission bandwidth configuration [RB]						MPR (dB)
	1.4 MHz	3 MHz	5 MHz	10 MHz	15 MHz	20 MHz	
QPSK	> 5	> 4	> 8	> 12	> 16	> 18	0
16 QAM	≤ 5	≤ 4	≤ 8	≤ 12	≤ 16	≤ 18	0
16 QAM	> 5	> 4	> 8	> 12	> 16	> 18	0

Table 13.3-4: The tune up for LTE – Low Power

Band	Tune up
LTE Band 66	20.5

Normal Power

Band 12					
Bandwidth (MHz)	RB allocation	Frequency (MHz)	QPSK	16QAM	
	RB offset (Start RB)		Actual output power (dBm)	Actual output power (dBm)	
1.4 MHz	1RB High (5)	715.3	22.24	20.83	
		707.5	22.15	20.98	
		699.7	22.13	21.49	
	1RB Middle (3)	715.3	22.31	21.59	
		707.5	22.26	21.28	
		699.7	22.26	21.37	
	1RB Low (0)	715.3	22.08	20.93	
		707.5	22.35	21.35	
		699.7	22.29	20.94	
	3RB High (3)	715.3	22.28	20.89	
		707.5	22.16	21.42	
		699.7	22.18	21.06	
	3RB Middle (1)	715.3	22.06	21.14	
		707.5	22.28	21.50	
		699.7	22.16	21.05	
	3RB Low (0)	715.3	22.08	21.15	
		707.5	22.51	21.31	
		699.7	22.17	21.09	
	6RB (0)	715.3	21.15	20.04	
		707.5	21.27	20.32	
		699.7	21.16	20.31	
	3 MHz	1RB High (14)	714.5	22.21	20.84
			707.5	22.18	21.13
			700.5	22.25	21.25
		1RB Middle (7)	714.5	22.18	21.46
			707.5	22.25	21.48
			700.5	22.55	21.25
1RB Low (0)		714.5	22.21	20.87	
		707.5	22.25	21.39	
		700.5	22.23	21.15	
8RB High (7)		714.5	21.38	20.19	
		707.5	21.25	20.13	
		700.5	21.21	20.15	
8RB Middle (4)		714.5	21.26	20.21	
		707.5	21.29	20.22	
		700.5	21.10	20.32	
8RB Low (0)		714.5	21.16	20.21	
		707.5	21.42	20.23	
		700.5	21.14	20.13	
15RB (0)		714.5	21.26	20.32	
		707.5	21.36	20.10	
		700.5	21.15	20.09	
5 MHz		1RB	713.5	21.95	20.59

	High (24)	707.5	22.19	20.97	
		701.5	22.08	21.09	
	1RB Middle (12)	713.5	22.28	20.60	
		707.5	22.38	21.10	
		701.5	22.62	21.07	
	1RB Low (0)	713.5	21.97	20.63	
		707.5	22.13	20.72	
		701.5	21.98	20.63	
	12RB High (13)	713.5	21.17	19.99	
		707.5	21.14	20.10	
		701.5	21.22	20.18	
	12RB Middle (6)	713.5	21.21	20.13	
		707.5	21.27	20.14	
		701.5	21.27	20.13	
	12RB Low (0)	713.5	21.26	20.05	
		707.5	21.27	20.18	
		701.5	21.17	20.08	
	25RB (0)	713.5	21.15	20.09	
		707.5	21.19	20.12	
		701.5	21.24	20.31	
	10 MHz	1RB High (49)	711	21.87	21.49
			707.5	22.03	20.94
			704	22.16	21.31
		1RB Middle (24)	711	22.51	21.72
			707.5	22.25	21.49
			704	22.52	21.89
		1RB Low (0)	711	21.98	21.55
			707.5	21.90	20.98
			704	22.22	20.98
		25RB High (25)	711	21.15	20.33
707.5			21.12	20.36	
704			21.30	20.26	
25RB Middle (12)		711	21.31	20.39	
		707.5	21.24	20.34	
		704	21.25	20.21	
25RB Low (0)		711	21.23	20.33	
		707.5	21.15	20.25	
		704	21.12	20.18	
50RB (0)		711	21.26	20.15	
		707.5	21.18	20.03	
		704	21.27	20.20	

Band 66				
Bandwidth (MHz)	RB allocation	Frequency (MHz)	QPSK	16QAM
	RB offset (Start RB)		Actual output power (dBm)	Actual output power (dBm)
1.4 MHz	1RB High (5)	1779.3	22.39	21.44
		1745	22.51	21.49
		1710.7	22.28	21.69
	1RB Middle (3)	1779.3	22.41	21.42
		1745	22.68	21.60
		1710.7	22.45	21.33
	1RB Low (0)	1779.3	22.37	21.30
		1745	22.42	21.34
		1710.7	22.28	21.07
	3RB High (3)	1779.3	22.63	21.48
		1745	22.45	21.59
		1710.7	22.51	21.56
	3RB Middle (1)	1779.3	22.20	21.76
		1745	22.42	21.35
		1710.7	22.24	21.43
	3RB Low (0)	1779.3	22.17	21.92
		1745	22.37	21.23
		1710.7	22.36	21.63
	6RB (0)	1779.3	21.42	20.52
		1745	21.50	20.73
		1710.7	21.30	20.32
3 MHz	1RB High (14)	1778.5	22.52	21.32
		1745	22.47	21.59
		1711.5	22.26	20.94
	1RB Middle (7)	1778.5	22.36	21.40
		1745	22.54	21.70
		1711.5	22.55	21.63
	1RB Low (0)	1778.5	22.45	21.40
		1745	22.57	21.60
		1711.5	22.35	21.64
	8RB High (7)	1778.5	21.56	20.26
		1745	21.55	20.79
		1711.5	21.57	20.34
	8RB Middle (4)	1778.5	21.53	20.30
		1745	21.52	20.65
		1711.5	21.22	20.42
	8RB Low (0)	1778.5	21.57	20.17
		1745	21.55	20.88
		1711.5	21.25	20.45
15RB (0)	1778.5	21.45	20.19	
	1745	21.46	20.79	
	1711.5	21.25	20.48	

5 MHz	1RB High (24)	1777.5	22.30	21.03	
		1745	22.36	21.10	
		1712.5	22.35	20.91	
	1RB Middle (12)	1777.5	22.54	21.41	
		1745	22.87	21.22	
		1712.5	22.48	21.00	
	1RB Low (0)	1777.5	22.39	21.21	
		1745	22.51	21.13	
		1712.5	22.39	21.04	
	12RB High (13)	1777.5	21.42	20.30	
		1745	21.56	20.55	
		1712.5	21.37	20.41	
	12RB Middle (6)	1777.5	21.48	20.38	
		1745	21.71	20.68	
		1712.5	21.53	20.29	
	12RB Low (0)	1777.5	21.42	20.25	
		1745	21.72	20.66	
		1712.5	21.44	20.23	
	25RB (0)	1777.5	21.44	20.42	
		1745	21.60	20.70	
		1712.5	21.41	20.40	
	10 MHz	1RB High (49)	1775	22.08	20.97
			1745	22.58	21.53
			1715	22.29	21.50
1RB Middle (24)		1775	22.39	21.00	
		1745	22.52	21.82	
		1715	22.47	21.80	
1RB Low (0)		1775	22.33	21.13	
		1745	22.62	21.70	
		1715	22.33	21.38	
25RB High (25)		1775	21.56	20.28	
		1745	21.54	20.45	
		1715	21.39	20.50	
25RB Middle (12)		1775	21.58	20.48	
		1745	21.62	20.80	
		1715	21.57	20.38	
25RB Low (0)		1775	21.53	20.48	
		1745	21.58	20.77	
		1715	21.48	20.44	
50RB (0)		1775	21.42	20.21	
		1745	21.46	20.46	
		1715	21.52	20.34	
15 MHz		1RB High (74)	1772.5	22.32	22.12
			1745	22.82	21.41
			1717.5	22.77	21.38
	1RB Middle (37)	1772.5	22.61	22.16	
		1745	23.05	21.83	
		1717.5	22.63	20.83	

	1RB Low (0)	1772.5	22.59	22.00
		1745	23.19	21.67
		1717.5	22.33	20.97
	36RB High (38)	1772.5	21.30	20.26
		1745	21.57	20.32
		1717.5	21.54	20.52
	36RB Middle (19)	1772.5	21.44	20.40
		1745	21.68	20.66
		1717.5	21.47	20.46
	36RB Low (0)	1772.5	21.40	20.33
		1745	21.68	20.62
		1717.5	21.39	20.38
	75RB (0)	1772.5	21.29	20.17
		1745	21.58	20.53
		1717.5	21.56	20.53
20 MHz	1RB High (99)	1770	22.49	21.31
		1745	22.44	21.58
		1720	22.52	21.40
	1RB Middle (50)	1770	22.83	21.51
		1745	22.78	21.62
		1720	22.46	20.93
	1RB Low (0)	1770	22.46	21.17
		1745	22.55	21.70
		1720	22.05	20.83
	50RB High (50)	1770	21.40	20.30
		1745	21.56	20.45
		1720	21.58	20.56
	50RB Middle (25)	1770	21.40	20.47
		1745	21.64	20.60
		1720	21.45	20.42
	50RB Low (0)	1770	21.32	20.27
		1745	21.65	20.59
		1720	21.38	20.42
	100RB (0)	1770	21.25	20.12
		1745	21.64	20.46
		1720	21.59	20.45

Low power

Table 11.3-2: The conducted Power for LTE

Band 66					
Bandwidth (MHz)	RB allocation	Frequency (MHz)	QPSK	16QAM	
	RB offset (Start RB)		Actual output power (dBm)	Actual output power (dBm)	
1.4 MHz	1RB High (5)	1779.3	19.77	19.87	
		1745	19.86	20.48	
		1710.7	19.54	19.27	
	1RB Middle (3)	1779.3	19.94	19.86	
		1745	20.17	19.89	
		1710.7	19.60	19.50	
	1RB Low (0)	1779.3	20.01	19.83	
		1745	19.96	19.87	
		1710.7	19.66	19.54	
	3RB High (3)	1779.3	19.88	20.02	
		1745	20.08	19.99	
		1710.7	19.49	19.50	
	3RB Middle (1)	1779.3	19.88	20.05	
		1745	20.04	19.94	
		1710.7	19.72	19.71	
	3RB Low (0)	1779.3	19.82	19.97	
		1745	20.01	20.01	
		1710.7	19.73	19.82	
	6RB (0)	1779.3	19.82	19.93	
		1745	19.98	20.19	
		1710.7	19.69	19.38	
	3 MHz	1RB High (14)	1778.5	19.89	19.94
			1745	19.93	19.96
			1711.5	19.64	19.95
1RB Middle (7)		1778.5	19.97	19.92	
		1745	20.18	20.40	
		1711.5	19.83	19.46	
1RB Low (0)		1778.5	19.76	19.98	
		1745	19.94	20.14	
		1711.5	19.65	19.75	
8RB High (7)		1778.5	19.82	19.94	
		1745	19.96	20.04	
		1711.5	19.60	19.68	
8RB Middle (4)		1778.5	19.91	19.81	
		1745	20.01	20.27	
		1711.5	19.63	19.73	
8RB Low (0)		1778.5	19.87	19.99	
		1745	20.03	20.28	
		1711.5	19.75	19.73	
15RB (0)		1778.5	19.88	19.87	
		1745	19.97	19.97	
		1711.5	19.71	19.77	

5 MHz	1RB High (24)	1777.5	19.89	19.52	
		1745	19.64	19.84	
		1712.5	19.49	19.22	
	1RB Middle (12)	1777.5	20.01	19.45	
		1745	20.06	20.04	
		1712.5	19.65	19.31	
	1RB Low (0)	1777.5	19.84	19.66	
		1745	19.72	19.45	
		1712.5	19.68	19.23	
	12RB High (13)	1777.5	19.81	19.83	
		1745	19.94	19.80	
		1712.5	19.58	19.47	
	12RB Middle (6)	1777.5	19.86	19.73	
		1745	19.96	19.92	
		1712.5	19.68	19.78	
	12RB Low (0)	1777.5	19.90	19.94	
		1745	20.02	19.89	
		1712.5	19.68	19.77	
	25RB (0)	1777.5	19.85	19.92	
		1745	20.03	19.91	
		1712.5	19.66	19.66	
	10 MHz	1RB High (49)	1775	19.69	19.67
			1745	20.18	20.05
			1715	19.65	20.08
1RB Middle (24)		1775	19.93	20.09	
		1745	20.33	20.26	
		1715	19.74	20.09	
1RB Low (0)		1775	19.87	19.73	
		1745	20.12	20.08	
		1715	19.45	19.89	
25RB High (25)		1775	19.77	19.82	
		1745	19.81	19.80	
		1715	19.75	19.92	
25RB Middle (12)		1775	19.88	19.95	
		1745	19.98	19.97	
		1715	19.66	19.81	
25RB Low (0)		1775	19.81	20.08	
		1745	20.01	20.00	
		1715	19.54	19.68	
50RB (0)		1775	19.71	19.74	
		1745	19.90	19.91	
		1715	19.62	19.67	
15 MHz		1RB High (74)	1772.5	20.00	19.84
			1745	19.68	20.24
			1717.5	19.73	20.41
	1RB Middle (37)	1772.5	20.07	20.14	
		1745	20.00	20.29	
		1717.5	19.49	20.38	

	1RB Low (0)	1772.5	20.06	19.92
		1745	20.15	19.95
		1717.5	19.52	20.17
	36RB High (38)	1772.5	19.82	19.57
		1745	19.88	20.02
		1717.5	19.78	19.68
	36RB Middle (19)	1772.5	19.92	19.85
		1745	19.97	20.09
		1717.5	19.68	19.62
	36RB Low (0)	1772.5	19.84	19.83
		1745	20.05	20.06
		1717.5	19.56	19.57
	75RB (0)	1772.5	19.76	19.71
		1745	19.91	19.92
		1717.5	19.83	19.80
20 MHz	1RB High (99)	1770	19.77	19.74
		1745	19.61	19.36
		1720	19.63	19.84
	1RB Middle (50)	1770	20.43	19.54
		1745	20.25	19.69
		1720	19.45	19.22
	1RB Low (0)	1770	19.70	19.21
		1745	20.08	19.76
		1720	19.31	19.00
	50RB High (50)	1770	19.64	19.60
		1745	19.94	19.90
		1720	19.85	19.85
	50RB Middle (25)	1770	19.80	19.87
		1745	20.08	19.93
		1720	19.73	19.78
	50RB Low (0)	1770	19.65	19.90
		1745	20.07	19.97
		1720	19.58	19.60
	100RB (0)	1770	19.67	19.56
		1745	19.93	19.80
		1720	19.82	19.88

11.3 Wi-Fi and BT Measurement result

The maximum output power of BT is 11.01dBm.

The maximum tune up of BT is 11.5dBm.

The average conducted power for Wi-Fi is as following:

802.11b(dBm)	
Channel\data rate	1Mbps
11(2462MHz)	19.22
6(2437MHz)	18.73
1(2412MHz)	19.10
Tune up	19.50
802.11g(dBm)	
Channel\data rate	6Mbps
11(2462MHz)	17.18
6(2437MHz)	16.68
1(2412MHz)	17.09
Tune up	17.50
802.11n(dBm)-20MHz	
Channel\data rate	MCS0
11(2462MHz)	16.31
6(2437MHz)	15.71
1(2412MHz)	16.22
Tune up	16.50
802.11n(dBm)-40MHz	
Channel\data rate	MCS0
9(2452MHz)	15.77
6(2437MHz)	15.89
3(2422MHz)	15.40
Tune up	16.50

12 Simultaneous TX SAR Considerations

12.1 Introduction

The following procedures adopted from “FCC SAR Considerations for Cell Phones with Multiple Transmitters” are applicable to handsets with built-in unlicensed transmitters such as 802.11 a/b/g and Bluetooth devices which may simultaneously transmit with the licensed transmitter. For this device, the BT and Wi-Fi can transmit simultaneous with other transmitters.

12.2 Transmit Antenna Separation Distances

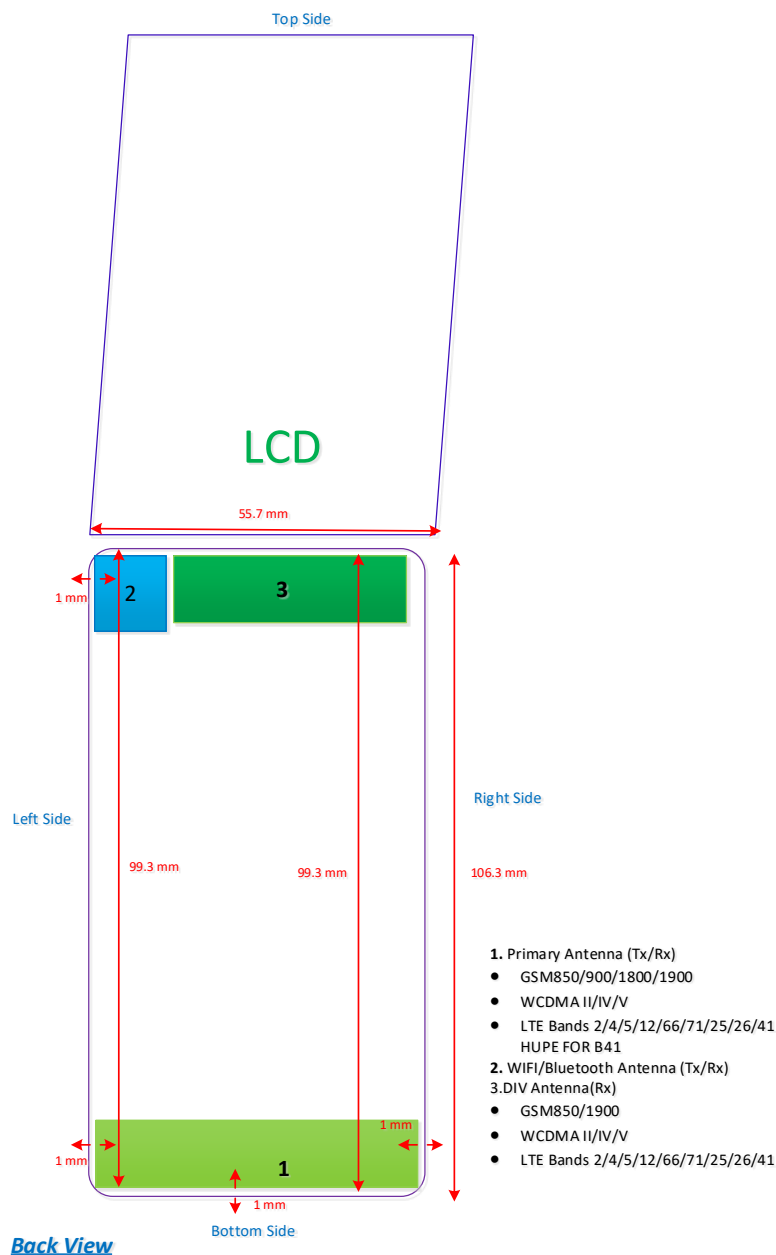

Picture 12.1 Antenna Locations

12.3 SAR Measurement Positions

According to the KDB941225 D06 Hot Spot SAR v01, the edges with less than 2.5 cm distance to the antennas need to be tested for SAR.

SAR measurement positions						
Mode	Front	Rear	Left edge	Right edge	Top edge	Bottom edge
Main antenna	Yes	Yes	Yes	Yes	No	Yes
WLAN	Yes	Yes	Yes	No	Yes	No

12.4 Standalone SAR Test Exclusion Considerations

Standalone 1-g head or body SAR evaluation by measurement or numerical simulation is not required when the corresponding SAR Exclusion Threshold condition, listed below, is satisfied. The 1-g SAR test exclusion threshold for 100 MHz to 6 GHz at test separation distances ≤ 50 mm are determined by:

$[(\text{max. power of channel, including tune-up tolerance, mW}) / (\text{min. test separation distance, mm})] \cdot [\sqrt{f(\text{GHz})}] \leq 3.0$ for 1-g SAR, where

- $f(\text{GHz})$ is the RF channel transmit frequency in GHz
- Power and distance are rounded to the nearest mW and mm before calculation
- The result is rounded to one decimal place for comparison

Table 12.1: Standalone SAR test exclusion considerations

Band/Mode	F(GHz)	Position	SAR test exclusion threshold(mW)	RF output power		SAR test exclusion
				dBm	mW	
Bluetooth	2.441	Head	9.60	11.5	14.13	No
		Body	19.20	11.5	14.13	Yes
2.4GHz WLAN	2.45	Head	9.58	19.5	89.13	No
		Body	19.17	19.5	89.13	No

13 Evaluation of Simultaneous

Table 13.1: The sum of reported SAR values for main antenna and WiFi

	Position	Main antenna	WiFi	Sum
Highest reported SAR value for Head	Right hand, Touch cheek (WCDMA850)	0.78	0.64	1.42
Highest reported SAR value for Body	Rear unfold 10mm (GSM1900)	1.24	0.23	1.47

Table 13.2: The sum of reported SAR values for main antenna and BT

	Position	Main antenna	BT	Sum
Maximum reported SAR value for Head	Right hand, Touch cheek (WCDMA850)	0.78	<0.01	0.78
Maximum reported SAR value for Body	Rear 15mm (WCDMA1700)	1.27	<0.01	1.27

14 SAR Test Result

It is determined by user manual for the distance between the EUT and the phantom bottom. The distance is 10 mm or 15mm and just applied to the condition of body worn accessory.

It is performed for all SAR measurements with area scan based 1-g SAR estimation (Fast SAR). A zoom scan measurement is added when the estimated 1-gSAR is the highest measured SAR in each exposure configuration, wireless mode and frequency band combination or more than 1.2W/kg.

The calculated SAR is obtained by the following formula:

$$\text{Reported SAR} = \text{Measured SAR} \times 10^{(P_{\text{Target}} - P_{\text{Measured}})/10}$$

Where P_{Target} is the power of manufacturing upper limit;

P_{Measured} is the measured power in chapter 11.

Table 14.1: Duty Cycle

Mode	Duty Cycle
Speech for GSM850/1900	1:8.3
GPRS&EGPRS for GSM850	1:8.3
GPRS&EGPRS for GSM1900	1:2.67
WCDMA<E FDD	1:1

14.1 SAR results for Fast SAR

Table 14.1-1: SAR Values (GSM850 MHz Band - Head)

Ambient Temperature: 22.9 °C						Liquid Temperature: 22.5°C					
Frequency		Side	Test Position	Figure No.	Conducted Power (dBm)	Max. tune-up Power (dBm)	Measured SAR(10g) (W/kg)	Reported SAR(10g) (W/kg)	Measured SAR(1g) (W/kg)	Reported SAR(1g) (W/kg)	Power Drift (dB)
Ch.	MHz										
251	848.8	Left	Touch	/	31.86	33.00	0.294	0.38	0.412	0.54	-0.01
190	836.6	Left	Touch	Fig.1	32.14	33.00	0.319	0.39	0.445	0.54	0.07
128	824.2	Left	Touch	/	32.00	33.00	0.285	0.36	0.401	0.50	0.00
190	836.6	Left	Tilt	/	32.14	33.00	0.163	0.20	0.218	0.27	-0.04
190	836.6	Right	Touch	/	32.14	33.00	0.210	0.26	0.308	0.38	0.01
190	836.6	Right	Tilt	/	32.14	33.00	0.220	0.27	0.301	0.37	-0.06

Table 14.1-2: SAR Values (GSM 850 MHz Band - Body)

Ambient Temperature: 22.9 °C						Liquid Temperature: 22.5°C					
Frequency		Mode (number of timeslots)	Test Position	Figure No./ Note	Conducted Power (dBm)	Max. tune-up Power (dBm)	Measured SAR(10g) (W/kg)	Reported SAR(10g) (W/kg)	Measured SAR(1g) (W/kg)	Reported SAR(1g) (W/kg)	Power Drift (dB)
Ch.	MHz										
190	836.6	GPRS (1)	Front	/	32.09	33.00	0.164	0.20	0.239	0.29	-0.08
251	848.8	GPRS (1)	Rear	Fig.2	31.87	33.00	0.429	0.56	0.579	0.75	-0.05
190	836.6	GPRS (1)	Rear	/	32.09	33.00	0.371	0.46	0.548	0.68	0.06
128	824.2	GPRS (1)	Rear	/	31.97	33.00	0.345	0.44	0.478	0.61	0.05
190	836.6	GPRS (1)	Rear unfold	/	32.09	33.00	0.296	0.36	0.540	0.67	-0.11
190	836.6	GPRS (1)	Left	/	32.09	33.00	0.131	0.16	0.207	0.26	0.01
190	836.6	GPRS (1)	Right	/	32.09	33.00	0.252	0.31	0.412	0.51	0.07
190	836.6	GPRS (1)	Bottom	/	32.09	33.00	0.054	0.07	0.090	0.11	0.06
251	848.8	EGPRS (1)	Rear	/	31.81	33.00	0.399	0.52	0.559	0.74	-0.05

Note: The distance between the EUT and the phantom bottom is 10mm.

Table 14.1-3: SAR Values (GSM 1900 MHz Band - Head)

Ambient Temperature: 22.9 °C						Liquid Temperature: 22.5°C					
Frequency		Side	Test Position	Figure No./ Note	Conducted Power (dBm)	Max. tune-up Power (dBm)	Measured SAR(10g) (W/kg)	Reported SAR(10g) (W/kg)	Measured SAR(1g) (W/kg)	Reported SAR(1g) (W/kg)	Power Drift (dB)
Ch.	MHz										
810	1909.8	Left	Touch	/	29.47	30.50	0.131	0.17	0.210	0.27	-0.08
661	1880	Left	Touch	Fig.3	29.46	30.50	0.145	0.18	0.228	0.29	-0.11
512	1850.2	Left	Touch	/	28.98	30.50	0.119	0.17	0.190	0.27	-0.05
661	1880	Left	Tilt	/	29.46	30.50	0.047	0.06	0.074	0.09	0.10
661	1880	Right	Touch	/	29.46	30.50	0.064	0.08	0.113	0.14	-0.04
661	1880	Right	Tilt	/	29.46	30.50	0.031	0.04	0.044	0.06	-0.03

Table 14.1-4: SAR Values (GSM 1900 MHz Band - Body)

Frequency		Mode (number of timeslots)	Test Position	Figure No./ Note	Conducte d Power (dBm)	Max. tune- up Power (dBm)	Measured SAR(10g) (W/kg)	Reported SAR(10g) (W/kg)	Measured SAR(1g) (W/kg)	Reported SAR(1g) (W/kg)	Power Drift (dB)
Ch.	MHz										
Ambient Temperature: 22.9 °C Liquid Temperature: 22.5 °C											
661	1880	GPRS (3)	Front	/	25.06	26.00	0.158	0.20	0.250	0.31	-0.11
810	1909.8	GPRS (3)	Rear	/	25.06	26.00	0.399	0.50	0.703	0.87	0.03
661	1880	GPRS (3)	Rear	/	24.70	26.00	0.434	0.59	0.718	0.97	0.09
512	1850.2	GPRS (3)	Rear	/	24.06	26.00	0.424	0.66	0.708	1.11	0.17
810	1909.8	GPRS (3)	Rear unfold	/	25.06	26.00	0.441	0.55	0.787	0.98	0.07
661	1880	GPRS (3)	Rear unfold	/	24.70	26.00	0.480	0.65	0.804	1.08	-0.05
512	1850.2	GPRS (3)	Rear unfold	Fig.4	24.06	26.00	0.469	0.73	0.793	1.24	-0.02
810	1909.8	GPRS (3)	Left	/	25.06	26.00	0.195	0.24	0.340	0.42	0.12
661	1880	GPRS (3)	Right	/	25.06	26.00	0.127	0.16	0.268	0.33	0.06
512	1850.2	GPRS (3)	Bottom	/	25.06	26.00	0.077	0.10	0.127	0.16	0.05
512	1850.2	EGPRS (3)	Rear unfold	/	24.05	26.00	0.442	0.69	0.768	1.20	0.11

Note: The distance between the EUT and the phantom bottom is 10mm.

Table 14.1-5: SAR Values (WCDMA 1900 MHz Band - Head)

Frequency		Side	Test Position	Figur e No.	Conducted Power (dBm)	Max. tune- up Power (dBm)	Measure d SAR(10g) (W/kg)	Reported SAR(10g) (W/kg)	Measure d SAR(1g) (W/kg)	Reporte d SAR(1g) (W/kg)	Power Drift (dB)
Ch.	MHz										
Ambient Temperature: 22.9 °C Liquid Temperature: 22.5 °C											
9938	1907.6	Left	Touch	/	22.16	23.00	0.303	0.37	0.504	0.61	-0.13
9800	1880	Left	Touch	Fig.5	22.28	23.00	0.316	0.37	0.518	0.61	-0.05
9662	1852.4	Left	Touch	/	22.21	23.00	0.275	0.33	0.449	0.54	-0.12
9800	1880	Left	Tilt	/	22.28	23.00	0.113	0.13	0.146	0.17	0.01
9800	1880	Right	Touch	/	22.28	23.00	0.132	0.16	0.201	0.24	-0.07
9800	1880	Right	Tilt	/	22.28	23.00	0.077	0.09	0.095	0.11	-0.04

Table 14.1-6: SAR Values (WCDMA 1900 MHz Band - Body)

Frequency		Test Position	Figur e No.	Conducted Power (dBm)	Max. tune-up Power (dBm)	Measured SAR(10g) (W/kg)	Reported SAR(10g) (W/kg)	Measured SAR(1g) (W/kg)	Reported SAR(1g) (W/kg)	Power Drift (dB)
Ch.	MHz									
Ambient Temperature: 22.9 °C Liquid Temperature: 22.5 °C										
9800	1880	Front	/	19.67	20.00	0.133	0.14	0.236	0.25	-0.07
9938	1907.6	Rear	/	19.63	20.00	0.448	0.49	0.779	0.85	0.03
9800	1880	Rear	/	19.67	20.00	0.537	0.58	0.944	1.02	-0.04
9662	1852.4	Rear	Fig.6	19.56	20.00	0.584	0.65	1.020	1.13	-0.05
9938	1907.6	Rear unfold		19.63	20.00	0.406	0.44	0.720	0.78	-0.09
9800	1880	Rear unfold		19.67	20.00	0.502	0.54	0.893	0.96	0.04
9662	1852.4	Rear unfold	/	19.56	20.00	0.575	0.64	0.969	1.07	-0.06

9800	1880	Left	/	19.67	20.00	0.199	0.21	0.344	0.37	0.01
9800	1880	Right	/	19.67	20.00	0.153	0.17	0.304	0.33	-0.05
9800	1880	Bottom	/	19.67	20.00	0.073	0.08	0.121	0.13	0.04

Note1: The distance between the EUT and the phantom bottom is 10mm

Table 14.1-7: SAR Values (WCDMA 1900 MHz Band - Body)

Frequency		Test Position	Figure No.	Conducted Power (dBm)	Max. tune-up Power (dBm)	Ambient Temperature: 22.9 °C		Liquid Temperature: 22.5 °C		Power Drift (dB)
Ch.	MHz					Measured SAR(10g) (W/kg)	Reported SAR(10g) (W/kg)	Measured SAR(1g) (W/kg)	Reported SAR(1g) (W/kg)	
9800	1880	Front	/	22.28	23.00	0.160	0.19	0.311	0.37	0.10
9938	1907.6	Rear	/	22.16	23.00	0.351	0.43	0.727	0.88	0.12
9800	1880	Rear	/	22.28	23.00	0.495	0.58	1.050	1.24	0.01
9662	1852.4	Rear	Fig.7	22.21	23.00	0.492	0.59	1.040	1.25	0.11
9938	1907.6	Rear unfold	/	22.16	23.00	0.342	0.41	0.714	0.87	0.16
9800	1880	Rear unfold	/	22.28	23.00	0.502	0.59	1.040	1.23	-0.04
9662	1852.4	Rear unfold	/	22.21	23.00	0.486	0.58	0.996	1.19	0.17
9662	1852.4	Rear	H	22.21	23.00	0.431	0.52	0.929	1.11	0.16

Note1: The distance between the EUT and the phantom bottom is 15mm

Table 14.1-8: SAR Values (WCDMA 1700 MHz Band - Head)

Frequency		Side	Test Position	Figure No.	Conducted Power (dBm)	Max. tune-up Power (dBm)	Ambient Temperature: 22.9 °C		Liquid Temperature: 22.5 °C		Power Drift (dB)
Ch.	MHz						Measured SAR(10g) (W/kg)	Reported SAR(10g) (W/kg)	Measured SAR(1g) (W/kg)	Reported SAR(1g) (W/kg)	
1513	1752.6	Left	Touch	/	22.10	24.00	0.221	0.34	0.306	0.47	-0.10
1412	1732.4	Left	Touch	/	22.19	24.00	0.206	0.31	0.278	0.42	0.04
1312	1712.4	Left	Touch	Fig.8	22.01	24.00	0.264	0.42	0.386	0.61	0.07
1412	1732.4	Left	Tilt	/	22.19	24.00	0.051	0.08	0.072	0.11	0.05
1412	1732.4	Right	Touch	/	22.19	24.00	0.143	0.22	0.194	0.29	0.06
1412	1732.4	Right	Tilt	/	22.19	24.00	0.034	0.05	0.046	0.07	-0.13

Table 14.1-9: SAR Values (WCDMA 1700 MHz Band - Body)

Frequency		Test Position	Figure No.	Conducted Power (dBm)	Max. tune-up Power (dBm)	Ambient Temperature: 22.9 °C		Liquid Temperature: 22.5 °C		Power Drift (dB)
Ch.	MHz					Measured SAR(10g) (W/kg)	Reported SAR(10g) (W/kg)	Measured SAR(1g) (W/kg)	Reported SAR(1g) (W/kg)	
1412	1732.5	Front	/	19.48	20.00	0.155	0.17	0.257	0.29	0.09
1513	1752.6	Rear	/	19.34	20.00	0.522	0.61	0.935	1.09	0.03
1412	1732.5	Rear	/	19.48	20.00	0.514	0.58	0.918	1.03	-0.05
1312	1712.4	Rear	Fig.9	19.26	20.00	0.575	0.68	1.04	1.23	0.12

1513	1752.6	Rear unfold	/	19.34	20.00	0.518	0.60	0.908	1.06	0.03
1412	1732.5	Rear unfold	/	19.48	20.00	0.510	0.57	0.891	1.00	-0.02
1312	1712.4	Rear unfold	/	19.26	20.00	0.568	0.67	1.00	1.19	0.09
1412	1732.5	Left	/	19.48	20.00	0.297	0.33	0.469	0.53	0.12
1412	1732.5	Right	/	19.48	20.00	0.058	0.07	0.095	0.11	0.13
1412	1732.5	Bottom	/	19.48	20.00	0.179	0.20	0.320	0.36	-0.05
1312	1712.4	Rear	H	19.26	20.00	0.538	0.64	0.962	1.14	0.02

Note1: The distance between the EUT and the phantom bottom is 10mm

Table 14.1-10: SAR Values (WCDMA 1700 MHz Band - Body)

Frequency		Test Position	Figure No.	Conducted Power (dBm)	Max. tune-up Power (dBm)	Measured SAR(10g) (W/kg)	Reported SAR(10g) (W/kg)	Measured SAR(1g) (W/kg)	Reported SAR(1g) (W/kg)	Power Drift (dB)
Ch.	MHz									
Ambient Temperature: 22.9 °C Liquid Temperature: 22.5 °C										
1412	1732.5	Front	/	22.19	24.00	0.131	0.20	0.218	0.33	-0.04
1513	1752.6	Rear	/	22.10	24.00	0.423	0.66	0.735	1.14	0.09
1412	1732.5	Rear	/	22.19	24.00	0.445	0.68	0.778	1.18	0.01
1312	1712.4	Rear	Fig.10	22.01	24.00	0.463	0.73	0.806	1.27	0.02
1513	1752.6	Rear unfold	/	22.10	24.00	0.395	0.61	0.664	1.03	0.16
1412	1732.5	Rear unfold	/	22.19	24.00	0.416	0.63	0.703	1.07	-0.04
1312	1712.4	Rear unfold	/	22.01	24.00	0.433	0.68	0.728	1.15	0.07
1312	1712.4	Rear	H	22.01	24.00	0.435	0.69	0.761	1.20	0.15

Note1: The distance between the EUT and the phantom bottom is 15mm

Table 14.1-11: SAR Values (WCDMA 850 MHz Band - Head)

Frequency		Side	Test Position	Figure No.	Conducted Power (dBm)	Max. tune-up Power (dBm)	Measured SAR(10g) (W/kg)	Reported SAR(10g) (W/kg)	Measured SAR(1g) (W/kg)	Reported SAR(1g) (W/kg)	Power Drift (dB)
Ch.	MHz										
Ambient Temperature: 22.9 °C Liquid Temperature: 22.5 °C											
4183	836.6	Left	Touch	/	22.20	24.00	0.240	0.36	0.387	0.59	0.10
4183	836.6	Left	Tilt	/	22.20	24.00	0.156	0.24	0.237	0.36	0.01
4233	846.6	Right	Touch	Fig.11	22.30	24.00	0.312	0.46	0.527	0.78	-0.05
4183	836.6	Right	Touch	/	22.20	24.00	0.291	0.44	0.494	0.75	0.03
4132	826.4	Right	Touch	/	22.18	24.00	0.273	0.42	0.466	0.71	0.08
4183	836.6	Right	Tilt	/	22.20	24.00	0.213	0.32	0.326	0.49	-0.13

Table 14.1-12: SAR Values (WCDMA 850 MHz Band - Body)

Frequency		Test Position	Figure No.	Conducted Power (dBm)	Max. tune-up Power (dBm)	Measured SAR(10g) (W/kg)	Reported SAR(10g) (W/kg)	Measured SAR(1g) (W/kg)	Reported SAR(1g) (W/kg)	Power Drift (dB)
Ch.	MHz									
Ambient Temperature: 22.9 °C Liquid Temperature: 22.5 °C										
4182	836.4	Front	/	22.20	24.00	0.156	0.24	0.216	0.33	0.06
4233	846.6	Rear	/	22.30	24.00	0.431	0.64	0.631	0.93	0.12
4182	836.4	Rear	/	22.20	24.00	0.426	0.64	0.618	0.94	0.06
4132	826.4	Rear	Fig.12	22.18	24.00	0.445	0.68	0.638	0.97	-0.06
4182	836.4	Rear unfold		22.20	24.00	0.257	0.39	0.472	0.71	-0.07
4182	836.4	Left	/	22.20	24.00	0.194	0.29	0.317	0.48	-0.13
4182	836.4	Right	/	22.20	24.00	0.266	0.40	0.396	0.60	-0.12
4182	836.4	Bottom	/	22.20	24.00	0.051	0.08	0.093	0.14	0.05

Note: The distance between the EUT and the phantom bottom is 10mm.

Table 14.1-13: SAR Values (LTE Band12 - Head)

Frequency		Mode	Side	Test Position	Figure No.	Conducted Power (dBm)	Max. tune-up Power (dBm)	Measured SAR(10g) (W/kg)	Reported SAR(10g) (W/kg)	Measured SAR(1g) (W/kg)	Reported SAR(1g) (W/kg)	Power Drift (dB)
Ch.	MHz											
Ambient Temperature: 22.9 °C Liquid Temperature: 22.5 °C												
23060	704	1RB_Mid	Left	Touch	/	22.52	23.50	0.216	0.27	0.403	0.51	-0.08
23060	704	1RB_Mid	Left	Tilt	/	22.52	23.50	0.146	0.18	0.207	0.26	-0.10
23060	704	1RB_Mid	Right	Touch	/	22.52	23.50	0.288	0.36	0.469	0.59	-0.11
23060	704	1RB_Mid	Right	Tilt	/	22.52	23.50	0.172	0.22	0.249	0.31	-0.01
23130	711	25RB_Mid	Left	Touch	/	21.31	22.50	0.197	0.26	0.352	0.46	0.04
23130	711	25RB_Mid	Left	Tilt	/	21.31	22.50	0.194	0.26	0.275	0.36	-0.03
23130	711	25RB_Mid	Right	Touch	Fig.13	21.31	22.50	0.283	0.37	0.464	0.61	0.06
23130	711	25RB_Mid	Right	Tilt	/	21.31	22.50	0.172	0.23	0.243	0.32	-0.11

Note1: The LTE mode is QPSK_10MHz.

Table 14.1-14: SAR Values (LTE Band12 - Body)

Frequency		Mode	Test Position	Figure No.	Conducted Power (dBm)	Max. tune-up Power (dBm)	Measured SAR(10g) (W/kg)	Reported SAR(10g) (W/kg)	Measured SAR(1g) (W/kg)	Reported SAR(1g) (W/kg)	Power Drift (dB)
Ch.	MHz										
Ambient Temperature: 22.9 °C Liquid Temperature: 22.5 °C											
23060	704	1RB_Mid	Front	/	22.52	23.50	0.228	0.29	0.289	0.36	0.12
23060	704	1RB_Mid	Rear	/	22.52	23.50	0.382	0.48	0.531	0.67	0.05
23060	704	1RB_Mid	Rear unfold	Fig.14	22.52	23.50	0.449	0.56	0.614	0.77	-0.05
23060	704	1RB_Mid	Left	/	22.52	23.50	0.214	0.27	0.288	0.36	-0.10
23060	704	1RB_Mid	Right	/	22.52	23.50	0.330	0.41	0.456	0.57	-0.02
23060	704	1RB_Mid	Bottom	/	22.52	23.50	0.164	0.21	0.233	0.29	0.13
23130	711	25RB_Mid	Front	/	21.31	22.50	0.201	0.26	0.249	0.33	-0.06
23130	711	25RB_Mid	Rear	/	21.31	22.50	0.331	0.44	0.477	0.63	0.08
23130	711	25RB_Mid	Rear unfold	/	21.31	22.50	0.453	0.60	0.572	0.75	0.06
23130	711	25RB_Mid	Left	/	21.31	22.50	0.178	0.23	0.237	0.31	-0.10
23130	711	25RB_Mid	Right	/	21.31	22.50	0.263	0.35	0.360	0.47	0.10
23130	711	25RB_Mid	Bottom	/	21.31	22.50	0.109	0.14	0.195	0.26	0.01

Note1: The distance between the EUT and the phantom bottom is 10mm

Note2: The LTE mode is QPSK_10MHz.

Table 14.1-15: SAR Values (LTE Band66- Head)

Frequency		Mode	Side	Test Position	Figure No.	Conducted Power (dBm)	Max. tune-up Power (dBm)	Measured SAR(10g) (W/kg)	Reported SAR(10g) (W/kg)	Measured SAR(1g) (W/kg)	Reported SAR(1g) (W/kg)	Power Drift (dB)
Ch.	MHz											
Ambient Temperature: 22.9 °C Liquid Temperature: 22.5 °C												
132572	1770	1RB_Mid	Left	Touch	Fig.15	22.83	23.50	0.244	0.28	0.377	0.44	-0.09
132572	1770	1RB_Mid	Left	Tilt	/	22.83	23.50	0.056	0.07	0.071	0.08	0.05
132572	1770	1RB_Mid	Right	Touch	/	22.83	23.50	0.145	0.17	0.191	0.22	-0.12
132572	1770	1RB_Mid	Right	Tilt	/	22.83	23.50	0.040	0.05	0.048	0.06	0.02
132322	1720	50RB_Low	Left	Touch	/	21.65	22.50	0.216	0.26	0.318	0.39	0.10
132322	1720	50RB_Low	Left	Tilt	/	21.65	22.50	0.047	0.06	0.058	0.07	0.13
132322	1720	50RB_Low	Right	Touch	/	21.65	22.50	0.122	0.15	0.155	0.19	0.01
132322	1720	50RB_Low	Right	Tilt	/	21.65	22.50	0.033	0.04	0.045	0.05	-0.13

Note1: The LTE mode is QPSK_20MHz.

Table 14.1-16: SAR Values (LTE Band66 - Body)

Frequency		Mode	Test Position	Figure No.	Conducted Power (dBm)	Max. tune-up Power (dBm)	Measured SAR(10g) (W/kg)	Reported SAR(10g) (W/kg)	Measured SAR(1g) (W/kg)	Reported SAR(1g) (W/kg)	Power Drift (dB)
Ch.	MHz										
Ambient Temperature: 22.9°C Liquid Temperature: 22.5°C											
132572	1770	1RB_Mid	Front	/	20.43	20.50	0.181	0.18	0.310	0.32	-0.01
132572	1770	1RB_Mid	Rear	/	20.43	20.50	0.466	0.47	0.841	0.85	0.12
132322	1745	1RB_Mid	Rear	/	20.25	20.50	0.556	0.59	0.989	1.05	-0.11
132072	1720	1RB_High	Rear	/	19.63	20.50	0.493	0.60	0.891	1.09	0.11
132572	1770	1RB_Mid	Rear unfold	/	20.43	20.50	0.476	0.48	0.841	0.85	-0.03
132322	1745	1RB_Mid	Rear unfold	/	20.25	20.50	0.504	0.53	0.887	0.94	-0.10
132072	1720	1RB_High	Rear unfold	/	19.63	20.50	0.388	0.47	0.672	0.82	-0.12
132572	1770	1RB_Mid	Left	/	20.43	20.50	0.290	0.29	0.532	0.54	-0.09
132572	1770	1RB_Mid	Right	/	20.43	20.50	0.077	0.08	0.139	0.14	0.07
132572	1770	1RB_Mid	Bottom	/	20.43	20.50	0.157	0.16	0.279	0.28	0.00
132572	1770	50RB_Mid	Front	/	20.08	20.50	0.178	0.20	0.304	0.33	-0.07
132572	1770	50RB_Mid	Rear	/	19.80	20.50	0.480	0.56	0.868	1.02	0.11
132322	1745	50RB_Mid	Rear	/	20.08	20.50	0.505	0.56	0.912	1.00	0.00
132072	1720	50RB_High	Rear	Fig.16	19.85	20.50	0.538	0.62	0.974	1.13	0.12
132572	1770	50RB_Mid	Rear unfold	/	19.80	20.50	0.482	0.57	0.852	1.00	0.09
132322	1745	50RB_Mid	Rear unfold	/	20.08	20.50	0.505	0.56	0.888	0.98	-0.13
132072	1720	50RB_High	Rear unfold	/	19.85	20.50	0.494	0.57	0.870	1.01	0.12
132572	1770	50RB_Mid	Left	/	20.08	20.50	0.298	0.33	0.548	0.60	0.10
132572	1770	50RB_Mid	Right	/	20.08	20.50	0.077	0.08	0.138	0.15	-0.12
132572	1770	50RB_Mid	Bottom	/	20.08	20.50	0.161	0.18	0.288	0.32	-0.11
132322	1745	100RB	Rear	/	19.93	20.50	0.497	0.57	0.890	1.01	0.03
132322	1745	100RB	Rear unfold	/	19.93	20.50	0.475	0.54	0.839	0.96	0.01

Note1: The distance between the EUT and the phantom bottom is 10mm

Note2: The LTE mode is QPSK_20MHz.

Table 14.1-17: SAR Values (LTE Band66 - Body)

Frequency		Mode	Test Position	Figure No.	Conducted Power (dBm)	Max. tune-up Power (dBm)	Measured SAR(10g) (W/kg)	Reported SAR(10g) (W/kg)	Measured SAR(1g) (W/kg)	Reported SAR(1g) (W/kg)	Power Drift (dB)
Ch.	MHz										
Ambient Temperature: 22.9°C					Liquid Temperature: 22.5°C						
132572	1770	1RB_Mid	Front	/	22.83	23.50	0.150	0.17	0.247	0.29	-0.12
132572	1770	1RB_Mid	Rear	/	22.83	23.50	0.395	0.46	0.685	0.80	-0.10
132322	1745	1RB_Mid	Rear	/	22.78	23.50	0.461	0.54	0.810	0.96	0.13
132072	1720	1RB_Mid	Rear	Fig.17	22.46	23.50	0.474	0.60	0.841	1.07	-0.02
132572	1770	1RB_Mid	Rear unfold	/	22.83	23.50	0.394	0.46	0.653	0.76	-0.12
132322	1745	50RB_Low	Front	/	21.65	22.50	0.121	0.15	0.199	0.24	0.11
132322	1745	50RB_Low	Rear	/	21.65	22.50	0.347	0.42	0.610	0.74	0.02
132322	1745	50RB_Low	Rear unfold	/	21.65	22.50	0.324	0.39	0.536	0.65	0.08
132322	1745	100RB	Rear	/	21.64	22.50	0.422	0.51	0.623	0.76	0.19

Note1: The distance between the EUT and the phantom bottom is 15mm

Note2: The LTE mode is QPSK_20MHz.

14.2 SAR results for Standard procedure

There is zoom scan measurement to be added for the highest measured SAR in each exposure configuration/band.

Table 14.2-1: SAR Values (GSM850 MHz Band - Head)

Ambient Temperature: 22.9 °C						Liquid Temperature: 22.5 °C					
Frequency		Side	Test Position	Figure No.	Conducted Power (dBm)	Max. tune-up Power (dBm)	Measured SAR(10g) (W/kg)	Reported SAR(10g) (W/kg)	Measured SAR(1g) (W/kg)	Reported SAR(1g) (W/kg)	Power Drift (dB)
Ch.	MHz										
190	836.6	Left	Touch	Fig.1	32.14	33.00	0.319	0.39	0.445	0.54	0.07

Table 14.2-2: SAR Values (GSM 850 MHz Band - Body)

Ambient Temperature: 22.9 °C						Liquid Temperature: 22.5 °C					
Frequency		Mode (number of timeslots)	Test Position	Figure No./ Note	Conducted Power (dBm)	Max. tune-up Power (dBm)	Measured SAR(10g) (W/kg)	Reported SAR(10g) (W/kg)	Measured SAR(1g) (W/kg)	Reported SAR(1g) (W/kg)	Power Drift (dB)
Ch.	MHz										
251	848.8	GPRS (1)	Rear	Fig.2	31.87	33.00	0.429	0.56	0.579	0.75	-0.05

Note: The distance between the EUT and the phantom bottom is 10mm.

Table 14.2-3: SAR Values (GSM 1900 MHz Band - Head)

Ambient Temperature: 22.9 °C						Liquid Temperature: 22.5 °C					
Frequency		Side	Test Position	Figure No./ Note	Conducted Power (dBm)	Max. tune-up Power (dBm)	Measured SAR(10g) (W/kg)	Reported SAR(10g) (W/kg)	Measured SAR(1g) (W/kg)	Reported SAR(1g) (W/kg)	Power Drift (dB)
Ch.	MHz										
661	1880	Left	Touch	Fig.3	29.46	30.50	0.145	0.18	0.228	0.29	-0.11

Table 14.2-4: SAR Values (GSM 1900 MHz Band - Body)

Ambient Temperature: 22.9 °C						Liquid Temperature: 22.5 °C					
Frequency		Mode (number of timeslots)	Test Position	Figure No./ Note	Conducted Power (dBm)	Max. tune-up Power (dBm)	Measured SAR(10g) (W/kg)	Reported SAR(10g) (W/kg)	Measured SAR(1g) (W/kg)	Reported SAR(1g) (W/kg)	Power Drift (dB)
Ch.	MHz										
512	1850.2	GPRS (3)	Rear unfold	Fig.4	24.06	26.00	0.469	0.73	0.793	1.24	-0.02

Note: The distance between the EUT and the phantom bottom is 10mm.

Table 14.2-5: SAR Values (WCDMA 1900 MHz Band - Head)

Ambient Temperature: 22.9 °C						Liquid Temperature: 22.5 °C					
Frequency		Side	Test Position	Figure No.	Conducted Power (dBm)	Max. tune-up Power (dBm)	Measured SAR(10g) (W/kg)	Reported SAR(10g) (W/kg)	Measured SAR(1g) (W/kg)	Reported SAR(1g) (W/kg)	Power Drift (dB)
Ch.	MHz										
9800	1880	Left	Touch	Fig.5	22.28	23.00	0.316	0.37	0.518	0.61	-0.05

Table 14.2-6: SAR Values (WCDMA 1900 MHz Band - Body)

Frequency		Test Position	Figure No.	Conducted Power (dBm)	Max. tune-up Power (dBm)	Measured SAR(10g) (W/kg)	Reported SAR(10g) (W/kg)	Measured SAR(1g) (W/kg)	Reported SAR(1g) (W/kg)	Power Drift (dB)
Ch.	MHz									
9662	1852.4	Rear	Fig.6	19.56	20.00	0.584	0.65	1.020	1.13	-0.05

Note1: The distance between the EUT and the phantom bottom is 10mm

Table 14.2-7: SAR Values (WCDMA 1900 MHz Band - Body)

Frequency		Test Position	Figure No.	Conducted Power (dBm)	Max. tune-up Power (dBm)	Measured SAR(10g) (W/kg)	Reported SAR(10g) (W/kg)	Measured SAR(1g) (W/kg)	Reported SAR(1g) (W/kg)	Power Drift (dB)
Ch.	MHz									
9662	1852.4	Rear	Fig.7	22.21	23.00	0.492	0.59	1.040	1.25	0.11

Note1: The distance between the EUT and the phantom bottom is 15mm

Table 14.2-8: SAR Values (WCDMA 1700 MHz Band - Head)

Frequency		Side	Test Position	Figure No.	Conducted Power (dBm)	Max. tune-up Power (dBm)	Measured SAR(10g) (W/kg)	Reported SAR(10g) (W/kg)	Measured SAR(1g) (W/kg)	Reported SAR(1g) (W/kg)	Power Drift (dB)
Ch.	MHz										
1312	1712.4	Left	Touch	Fig.8	22.01	24.00	0.264	0.42	0.386	0.61	0.07

Table 14.2-9: SAR Values (WCDMA 1700 MHz Band - Body)

Frequency		Test Position	Figure No.	Conducted Power (dBm)	Max. tune-up Power (dBm)	Measured SAR(10g) (W/kg)	Reported SAR(10g) (W/kg)	Measured SAR(1g) (W/kg)	Reported SAR(1g) (W/kg)	Power Drift (dB)
Ch.	MHz									
1312	1712.4	Rear	Fig.9	19.26	20.00	0.575	0.68	1.04	1.23	0.12

Note1: The distance between the EUT and the phantom bottom is 10mm

Table 14.2-10: SAR Values (WCDMA 1700 MHz Band - Body)

Frequency		Test Position	Figure No.	Conducted Power (dBm)	Max. tune-up Power (dBm)	Measured SAR(10g) (W/kg)	Reported SAR(10g) (W/kg)	Measured SAR(1g) (W/kg)	Reported SAR(1g) (W/kg)	Power Drift (dB)
Ch.	MHz									
1312	1712.4	Rear	Fig.10	22.01	24.00	0.463	0.73	0.806	1.27	0.02

Note1: The distance between the EUT and the phantom bottom is 15mm

Table 14.2-11: SAR Values (WCDMA 850 MHz Band - Head)

Frequency		Side	Test Position	Figure No.	Conducted Power (dBm)	Max. tune-up Power (dBm)	Measured SAR(10g) (W/kg)	Reported SAR(10g) (W/kg)	Measured SAR(1g) (W/kg)	Reported SAR(1g) (W/kg)	Power Drift (dB)	
Ch.	MHz											
		Ambient Temperature: 22.9 °C					Liquid Temperature: 22.5 °C					
4233	846.6	Right	Touch	Fig.11	22.30	24.00	0.312	0.46	0.527	0.78	-0.05	

Table 14.2-12: SAR Values (WCDMA 850 MHz Band - Body)

Frequency		Test Position	Figure No.	Conducted Power (dBm)	Max. tune-up Power (dBm)	Measured SAR(10g) (W/kg)	Reported SAR(10g) (W/kg)	Measured SAR(1g) (W/kg)	Reported SAR(1g) (W/kg)	Power Drift (dB)	
Ch.	MHz										
		Ambient Temperature: 22.9 °C					Liquid Temperature: 22.5 °C				
4132	826.4	Rear	Fig.12	22.18	24.00	0.445	0.68	0.638	0.97	-0.06	

Note: The distance between the EUT and the phantom bottom is 10mm.

Table 14.2-13: SAR Values (LTE Band12 - Head)

Frequency		Mode	Side	Test Position	Figure No.	Conducted Power (dBm)	Max. tune-up Power (dBm)	Measured SAR(10g) (W/kg)	Reported SAR(10g) (W/kg)	Measured SAR(1g) (W/kg)	Reported SAR(1g) (W/kg)	Power Drift (dB)
Ch.	MHz											
		Ambient Temperature: 22.9 °C					Liquid Temperature: 22.5 °C					
23130	711	25RB_Mid	Right	Touch	Fig.13	21.31	22.50	0.283	0.37	0.464	0.61	0.06

Note1: The LTE mode is QPSK_10MHz.

Table 14.2-14: SAR Values (LTE Band12 - Body)

Frequency		Mode	Test Position	Figure No.	Conducted Power (dBm)	Max. tune-up Power (dBm)	Measured SAR(10g) (W/kg)	Reported SAR(10g) (W/kg)	Measured SAR(1g) (W/kg)	Reported SAR(1g) (W/kg)	Power Drift (dB)	
Ch.	MHz											
		Ambient Temperature: 22.9 °C					Liquid Temperature: 22.5 °C					
23060	704	1RB_Mid	Rear unfold	Fig.14	22.52	23.50	0.449	0.56	0.614	0.77	-0.05	

Note1: The distance between the EUT and the phantom bottom is 10mm

Note2: The LTE mode is QPSK_10MHz.

Table 14.2-15: SAR Values (LTE Band66- Head)

Frequency		Mode	Side	Test Position	Figure No.	Conducted Power (dBm)	Max. tune-up Power (dBm)	Measured SAR(10g) (W/kg)	Reported SAR(10g) (W/kg)	Measured SAR(1g) (W/kg)	Reported SAR(1g) (W/kg)	Power Drift (dB)
Ch.	MHz											
132572	1770	1RB_Mid	Left	Touch	Fig.15	22.83	23.50	0.244	0.28	0.377	0.44	-0.09

Note1: The LTE mode is QPSK_20MHz.

Table 14.2-16: SAR Values (LTE Band66 - Body)

Frequency		Mode	Test Position	Figure No.	Conducted Power (dBm)	Max. tune-up Power (dBm)	Measured SAR(10g) (W/kg)	Reported SAR(10g) (W/kg)	Measured SAR(1g) (W/kg)	Reported SAR(1g) (W/kg)	Power Drift (dB)
Ch.	MHz										
132072	1720	50RB_High	Rear	Fig.16	19.85	20.50	0.538	0.62	0.974	1.13	0.12

Note1: The distance between the EUT and the phantom bottom is 10mm

Note2: The LTE mode is QPSK_20MHz.

Table 14.2-17: SAR Values (LTE Band66 - Body)

Frequency		Mode	Test Position	Figure No.	Conducted Power (dBm)	Max. tune-up Power (dBm)	Measured SAR(10g) (W/kg)	Reported SAR(10g) (W/kg)	Measured SAR(1g) (W/kg)	Reported SAR(1g) (W/kg)	Power Drift (dB)
Ch.	MHz										
132072	1720	1RB_Mid	Rear	Fig.17	22.46	23.50	0.474	0.60	0.841	1.07	-0.02

Note1: The distance between the EUT and the phantom bottom is 15mm

Note2: The LTE mode is QPSK_20MHz.

14.3 WLAN Evaluation for 2.4G

According to the KDB248227 D01, SAR is measured for 2.4GHz 802.11b DSSS using the initial test position procedure.

Head Evaluation

Table 14.3-1: SAR Values (WLAN - Head)– 802.11b (Fast SAR)

Frequency		Side	Test Position	Figure No.	Ambient Temperature: 22.9 °C		Liquid Temperature: 22.5°C				Power Drift (dB)
MHz	Ch.				Conducte d Power (dBm)	Max. tune-up Power (dBm)	Measured SAR(10g) (W/kg)	Reported SAR(10g) (W/kg)	Measured SAR(1g) (W/kg)	Reported SAR(1g)(W/kg)	
2462	11	Left	Touch	/	19.22	19.50	0.124	0.13	0.275	0.29	0.02
2462	11	Left	Tilt	/	19.22	19.50	<0.01	<0.01	<0.01	<0.01	/
2462	11	Right	Touch	/	19.22	19.50	0.318	0.34	0.615	0.66	0.16
2462	11	Right	Tilt	/	19.22	19.50	0.034	0.04	0.059	0.06	0.19

As shown above table, the initial test position for head is “Right Touch”. So the head SAR of WLAN is presented as below:

Table 14.3-2: SAR Values (WLAN - Head)– 802.11b (Full SAR)

Frequency		Side	Test Position	Figure No.	Ambient Temperature: 22.9 °C		Liquid Temperature: 22.5°C				Power Drift (dB)
MHz	Ch.				Conducte d Power (dBm)	Max. tune-up Power (dBm)	Measured SAR(10g) (W/kg)	Reported SAR(10g) (W/kg)	Measured SAR(1g) (W/kg)	Reported SAR(1g)(W/kg)	
2462	11	Left	Touch	/	19.22	19.50	0.167	0.18	0.328	0.35	0.02
2462	11	Right	Touch	Fig.18	19.22	19.50	0.309	0.33	0.603	0.64	0.16

Note1: When the reported SAR of the initial test position is > 0.4 W/kg, SAR is repeated for the 802.11 transmission mode configuration tested in the initial test position using subsequent highest estimated 1-g SAR conditions determined by area scans, on the highest maximum output power channel, until the reported SAR is ≤ 0.8 W/kg.

Note2: For all positions/configurations tested using the initial test position and subsequent test positions, when the reported SAR is > 0.8 W/kg, SAR is measured for these test positions/configurations on the subsequent next highest measured output power channel until the reported SAR is ≤ 1.2 W/kg or all required channels are tested.

According to the KDB248227 D01, The reported SAR must be scaled to 100% transmission duty factor to determine compliance at the maximum tune-up tolerance limit. The scaled reported SAR is presented as below.

Table 14.3-3: SAR Values (WLAN - Head) – 802.11b (Scaled Reported SAR)

Frequency		Side	Test Position	Ambient Temperature: 22.9 °C		Liquid Temperature: 22.5°C	
MHz	Ch.			Actual duty factor	maximum duty factor	Reported SAR (1g)(W/kg)	Scaled reported SAR (1g)(W/kg)
2462	11	Right	Touch	100%	100%	0.64	0.64

SAR is not required for OFDM because the 802.11b adjusted SAR ≤ 1.2 W/kg.

Body Evaluation
Table 14.3-4: SAR Values (WLAN - Body)– 802.11b (Fast SAR)

Frequency		Test Position	Figure No.	Conducted Power (dBm)	Max. tune-up Power (dBm)	Ambient Temperature: 22.9 °C		Liquid Temperature: 22.5 °C		Power Drift (dB)
MHz	Ch.					Measured SAR(10g) (W/kg)	Reported SAR(10g) (W/kg)	Measured SAR(1g) (W/kg)	Reported SAR(1g)(W/kg)	
2462	11	Front	/	19.22	19.50	0.044	0.05	0.086	0.09	0.01
2462	11	Rear	/	19.22	19.50	0.061	0.07	0.119	0.13	0.16
2462	11	Rear unfold	/	19.22	19.50	0.112	0.12	0.206	0.22	0.09
2462	11	Left	/	19.22	19.50	0.021	0.02	0.042	0.04	0.03
2462	11	Top	/	19.22	19.50	0.044	0.05	0.055	0.06	0.06

As shown above table, the initial test position for body is “Rear unfold”. So the body SAR of WLAN is presented as below:

Table 14.3-5: SAR Values (WLAN - Body)– 802.11b (Full SAR)

Frequency		Test Position	Figure No.	Conducted Power (dBm)	Max. tune-up Power (dBm)	Ambient Temperature: 22.9 °C		Liquid Temperature: 22.5 °C		Power Drift (dB)
MHz	Ch.					Measured SAR(10g) (W/kg)	Reported SAR(10g) (W/kg)	Measured SAR(1g) (W/kg)	Reported SAR(1g)(W/kg)	
2462	11	Rear	/	19.22	19.50	0.055	0.06	0.099	0.11	0.16
2462	11	Rear unfold	Fig.19	19.22	19.50	0.117	0.12	0.213	0.23	0.09

Note1: When the reported SAR of the initial test position is > 0.4 W/kg, SAR is repeated for the 802.11 transmission mode configuration tested in the initial test position using subsequent highest estimated 1-g SAR conditions determined by area scans, on the highest maximum output power channel, until the reported SAR is \leq 0.8 W/kg.

Note2: For all positions/configurations tested using the initial test position and subsequent test positions, when the reported SAR is > 0.8 W/kg, SAR is measured for these test positions/configurations on the subsequent next highest measured output power channel until the reported SAR is \leq 1.2 W/kg or all required channels are tested.

According to the KDB248227 D01, The reported SAR must be scaled to 100% transmission duty factor to determine compliance at the maximum tune-up tolerance limit. The scaled reported SAR is presented as below.

Table 14.3-6: SAR Values (WLAN - Body) – 802.11b (Scaled Reported SAR)

Frequency		Test Position	Ambient Temperature: 22.9 °C		Liquid Temperature: 22.5 °C	
MHz	Ch.		Actual duty factor	maximum duty factor	Reported SAR (1g)(W/kg)	Scaled reported SAR (1g)(W/kg)
2462	11	Rear unfold	100%	100%	0.23	0.23

SAR is not required for OFDM because the 802.11b adjusted SAR \leq 1.2 W/kg.

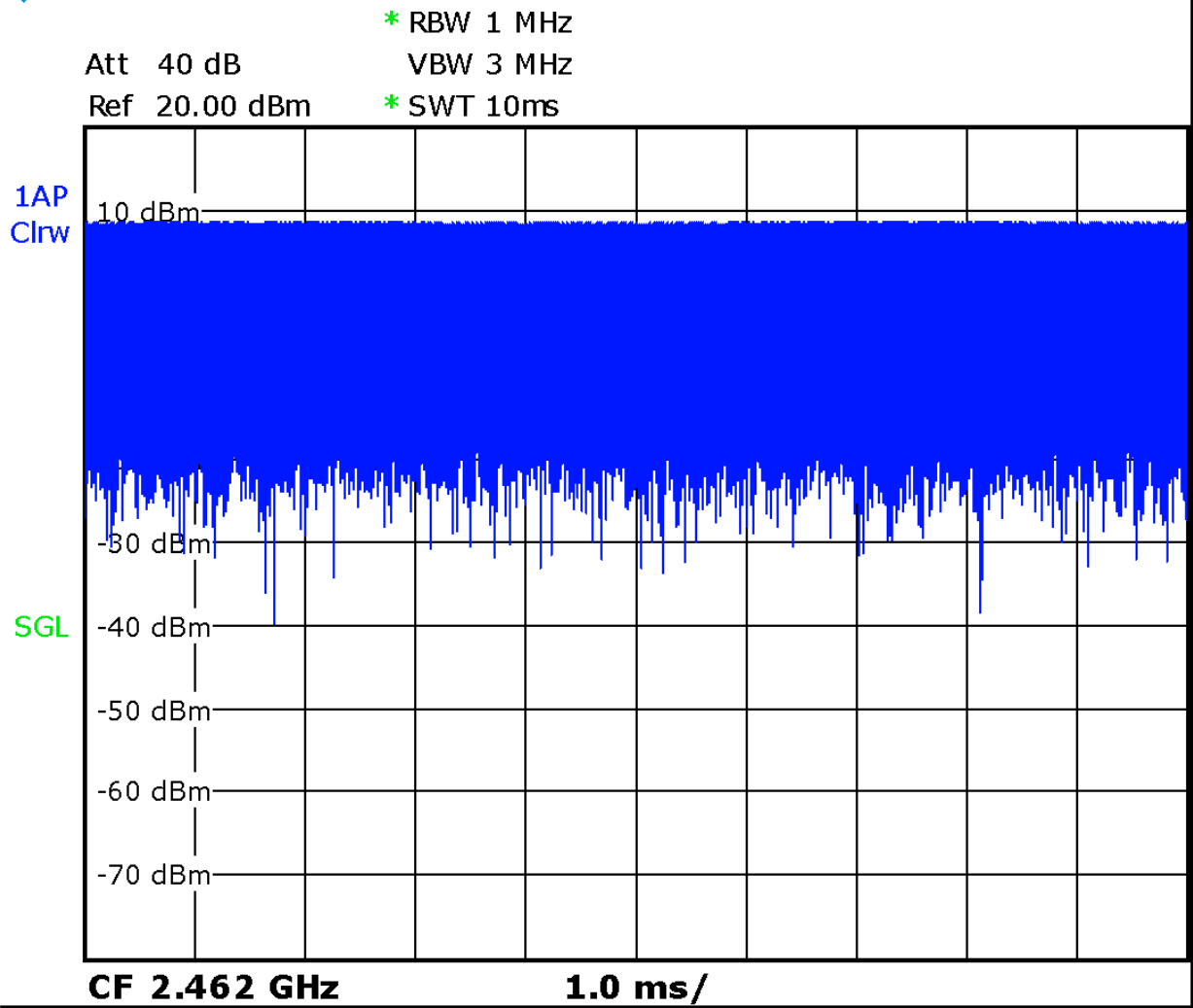

Picture 14.1 Duty factor plot

14.4 BT Evaluation

Table 14.5-1: SAR Values (Bluetooth - Head)

Frequency		Side	Test Position	Figure No.	Conducted Power (dBm)	Max. tune-up Power (dBm)	Measured SAR(10g) (W/kg)	Reported SAR(10g)(W/kg)	Measured SAR(1g) (W/kg)	Reported SAR(1g) (W/kg)	Power Drift (dB)
Ch.	MHz										
78	2480	Left	Touch	/	11.01	11.5	< 0.01	< 0.01	< 0.01	< 0.01	/
78	2480	Left	Tilt	/	11.01	11.5	< 0.01	< 0.01	< 0.01	< 0.01	/
78	2480	Right	Touch	/	11.01	11.5	< 0.01	< 0.01	< 0.01	< 0.01	/
78	2480	Right	Tilt	/	11.01	11.5	< 0.01	< 0.01	< 0.01	< 0.01	/

Table 14.1-2: SAR Values (GSM 850 MHz Band - Body)

Frequency		Test Position	Figure No.	Conducted Power (dBm)	Max. tune-up Power (dBm)	Measured SAR(10g) (W/kg)	Reported SAR(10g)(W/kg)	Measured SAR(1g) (W/kg)	Reported SAR(1g) (W/kg)	Power Drift (dB)
Ch.	MHz									
Ambient Temperature: 22.9 °C Liquid Temperature: 22.5 °C										
78	2480	Front	/	11.01	11.5	< 0.01	< 0.01	< 0.01	< 0.01	/
78	2480	Rear	/	11.01	11.5	< 0.01	< 0.01	< 0.01	< 0.01	/
78	2480	Rear unfold	/	11.01	11.5	< 0.01	< 0.01	< 0.01	< 0.01	/
78	2480	Left	/	11.01	11.5	< 0.01	< 0.01	< 0.01	< 0.01	/
78	2480	Right	/	11.01	11.5	< 0.01	< 0.01	< 0.01	< 0.01	/
78	2480	Bottom	/	11.01	11.5	< 0.01	< 0.01	< 0.01	< 0.01	/

Note: The distance between the EUT and the phantom bottom is 10mm.

15 SAR Measurement Variability

SAR measurement variability must be assessed for each frequency band, which is determined by the SAR probe calibration point and tissue-equivalent medium used for the device measurements. When both head and body tissue-equivalent media are required for SAR measurements in a frequency band, the variability measurement procedures should be applied to the tissue medium with the highest measured SAR, using the highest measured SAR configuration for that tissue-equivalent medium.

The following procedures are applied to determine if repeated measurements are required.

- 1) Repeated measurement is not required when the original highest measured SAR is < 0.80 W/kg; steps 2) through 4) do not apply.
- 2) When the original highest measured SAR is ≥ 0.80 W/kg, repeat that measurement once.
- 3) Perform a second repeated measurement only if the ratio of largest to smallest SAR for the original and first repeated measurements is > 1.20 or when the original or repeated measurement is ≥ 1.45 W/kg ($\sim 10\%$ from the 1-g SAR limit).
- 4) Perform a third repeated measurement only if the original, first or second repeated measurement is ≥ 1.5 W/kg and the ratio of largest to smallest SAR for the original, first and second repeated measurements is > 1.20 .

Table 15.1: SAR Measurement Variability for Body GSM1900 (1g)

Frequency		Test Position	Spacing (mm)	Original SAR (W/kg)	First Repeated SAR (W/kg)	The Ratio	Second Repeated SAR (W/kg)
Ch.	MHz						
661	1880	Rear unfold	10	0.804	0.769	1.05	/

Table 15.2: SAR Measurement Variability for Body W1900 (1g)

Frequency		Test Position	Spacing (mm)	Original SAR (W/kg)	First Repeated SAR (W/kg)	The Ratio	Second Repeated SAR (W/kg)
Ch.	MHz						
9262	1852.4	Rear	10	1.02	0.962	1.06	/
9262	1852.4	Rear	15	1.04	0.967	1.08	/

Table 15.3: SAR Measurement Variability for Body W1700 (1g)

Frequency		Test Position	Spacing (mm)	Original SAR (W/kg)	First Repeated SAR (W/kg)	The Ratio	Second Repeated SAR (W/kg)
Ch.	MHz						
1312	1712.4	Rear	10	1.04	0.978	1.06	/
1312	1712.4	Rear	15	0.806	0.769	1.05	/

Table 15.4: SAR Measurement Variability for Body LTE B66 (1g)

Frequency		Mode	Test Position	Spacing (mm)	Original SAR (W/kg)	First Repeated SAR (W/kg)	The Ratio	Second Repeated SAR (W/kg)
Ch.	MHz							
132072	1720	1RB_Mid	Rear	10	0.841	0.829	1.01	/
132072	1720	50RB_High	Rear	15	0.974	0.958	1.02	/