



FCC RF Test Report

APPLICANT : TCL Communication Ltd
EQUIPMENT : 5G NR/ LTE/WCDMA/GSM Mobile Phone
BRAND NAME : TCL
MODEL NAME : T790S
FCC ID : 2ACCJN042
STANDARD : FCC Part 15 Subpart C §15.247
CLASSIFICATION : (DSS) Spread Spectrum Transmitter

The product was received on May 19, 2020 and testing was completed on Aug. 03, 2020. We, Sporton International (Kunshan) Inc., would like to declare that the tested sample has been evaluated in accordance with the test procedures and has been in compliance with the applicable technical standards.

This report contains data that were produced under subcontract by Laboratory Sporton International (Shenzhen) Inc.

The test results in this report apply exclusively to the tested model / sample. Without written approval of Sporton International (Kunshan) Inc., the test report shall not be reproduced except in full.

Reviewed by: Jason Jia / Supervisor

Approved by: James Huang / Manager



Sporton International (Kunshan) Inc.

**No. 1098, Pengxi North Road, Kunshan Economic Development Zone Jiangsu Province 215300
People's Republic of China**



TABLE OF CONTENTS

REVISION HISTORY..... 3

SUMMARY OF TEST RESULT 4

1 GENERAL DESCRIPTION..... 5

 1.1 Applicant 5

 1.2 Manufacturer 5

 1.3 Product Feature of Equipment Under Test..... 5

 1.4 Product Specification of Equipment Under Test..... 6

 1.5 Modification of EUT 6

 1.6 Testing Location 6

 1.7 Test Software 7

 1.8 Applicable Standards..... 7

2 TEST CONFIGURATION OF EQUIPMENT UNDER TEST..... 8

 2.1 Carrier Frequency Channel 8

 2.2 Test Mode 9

 2.3 Connection Diagram of Test System 10

 2.4 Support Unit used in test configuration and system 11

 2.5 EUT Operation Test Setup 11

 2.6 Measurement Results Explanation Example..... 11

3 TEST RESULT 12

 3.1 Number of Channel Measurement 12

 3.2 Hopping Channel Separation Measurement 14

 3.3 Dwell Time Measurement..... 20

 3.4 20dB Bandwidth Measurement 22

 3.5 Output Power Measurement..... 28

 3.6 Conducted Band Edges Measurement..... 29

 3.7 Conducted Spurious Emission Measurement 36

 3.8 Radiated Band Edges and Spurious Emission Measurement 46

 3.9 AC Conducted Emission Measurement..... 50

 3.10 Antenna Requirements 52

4 LIST OF MEASURING EQUIPMENT..... 53

5 UNCERTAINTY OF EVALUATION..... 54

APPENDIX A. CONDUCTED TEST RESULTS

APPENDIX B. AC CONDUCTED EMISSION TEST RESULT

APPENDIX C. RADIATED SPURIOUS EMISSION

APPENDIX D. DUTY CYCLE PLOTS

APPENDIX E. SETUP PHOTOGRAPHS



SUMMARY OF TEST RESULT

| Report Section | FCC Rule | Description | Limit | Result | Remark |
|----------------|--------------------|--|----------------------------|--------|---|
| 3.1 | 15.247(a)(1) | Number of Channels | ≥ 15Chs | Pass | - |
| 3.2 | 15.247(a)(1) | Hopping Channel Separation | ≥ 2/3 of 20dB BW | Pass | - |
| 3.3 | 15.247(a)(1) | Dwell Time of Each Channel | ≤ 0.4sec in 31.6sec period | Pass | - |
| 3.4 | 15.247(a)(1) | 20dB Bandwidth | NA | Pass | - |
| 3.5 | 15.247(b)(1) | Peak Output Power | ≤ 125 mW | Pass | - |
| 3.6 | 15.247(d) | Conducted Band Edges | ≤ 20dBc | Pass | - |
| 3.7 | 15.247(d) | Conducted Spurious Emission | ≤ 20dBc | Pass | - |
| 3.8 | 15.247(d) | Radiated Band Edges and Radiated Spurious Emission | 15.209(a) & 15.247(d) | Pass | Under limit 7.39 dB at 34.850 MHz |
| 3.9 | 15.207 | AC Conducted Emission | 15.207(a) | Pass | Under limit 17.43 dB at 0.555 MHz |
| 3.10 | 15.203 & 15.247(b) | Antenna Requirement | N/A | Pass | - |

Declaration of Conformity:

The test results with all measurement uncertainty excluded are presented in accordance with the regulation limits or requirements declared by manufacturers.

Comments and Explanations:

The declared of product specification for EUT presented in the report are provided by the manufacturer, and the manufacturer takes all the responsibilities for the accuracy of product specification.



1 General Description

1.1 Applicant

TCL Communication Ltd

5/F, Building 22E, 22 Science Park East Avenue, Hong Kong Science Park, Shatin, NT, Hong Kong

1.2 Manufacturer

TCL Communication Ltd

5/F, Building 22E, 22 Science Park East Avenue, Hong Kong Science Park, Shatin, NT, Hong Kong

1.3 Product Feature of Equipment Under Test

| Product Feature | |
|---------------------------------|---|
| Equipment | 5G NR/ LTE/WCDMA/GSM Mobile Phone |
| Brand Name | TCL |
| Model Name | T790S |
| FCC ID | 2ACCJN042 |
| EUT supports Radios application | GSM/WCDMA/LTE/5G NR/NFC/GNSS WLAN 2.4GHz 802.11b/g/n HT20/HT40 WLAN 5GHz 802.11a/n HT20/HT40 WLAN 5GHz 802.11ac VHT20/VHT40/VHT80 Bluetooth BR/EDR/LE |
| IMEI Code | Conducted: N/A Conduction: 051749000013818 Radiation: 015749000013750 |
| HW Version | 03 |
| SW Version | 1B6GTWG0 |
| EUT Stage | Identical Prototype |

Remark: The above EUT's information was declared by manufacturer. Please refer to the specifications or user's manual for more detailed description.



1.4 Product Specification of Equipment Under Test

| Standards-related Product Specification | |
|--|--|
| Tx/Rx Frequency Range | 2402 MHz ~ 2480 MHz |
| Number of Channels | 79 |
| Carrier Frequency of Each Channel | 2402+n*1 MHz; n=0~78 |
| Maximum Output Power to Antenna | Bluetooth BR(1Mbps) : 12.98 dBm (0.0199 W) Bluetooth EDR (2Mbps) : 12.32 dBm (0.0171 W) Bluetooth EDR (3Mbps) : 12.70 dBm (0.0186 W) |
| Antenna Type / Gain | LDS Antenna with gain -4.0 dBi |
| Type of Modulation | Bluetooth BR (1Mbps) : GFSK Bluetooth EDR (2Mbps) : $\pi/4$ -DQPSK Bluetooth EDR (3Mbps) : 8-DPSK |

1.5 Modification of EUT

No modifications are made to the EUT during all test items.

1.6 Testing Location

Sporton International (Kunshan) Inc. is accredited to ISO/IEC 17025:2017 by American Association for Laboratory Accreditation with Certificate Number 5145.02.

| | | | |
|---------------------------|--|----------------------------|---------------------------------------|
| Test Firm | Sporton International (Kunshan) Inc. | | |
| Test Site Location | No. 1098, Pengxi North Road, Kunshan Economic Development Zone Jiangsu Province 215300 People's Republic of China TEL : +86-512-57900158 FAX : +86-512-57900958 | | |
| Test Site No. | Sporton Site No. | FCC Designation No. | FCC Test Firm Registration No. |
| | CO01-KS TH01-KS | CN1257 | 314309 |

Sporton International (Shenzhen) Inc. is accredited to ISO/IEC 17025:2017 by American Association for Laboratory Accreditation with Certificate Number 5145.01.

| | | | |
|---------------------------|--|----------------------------|---------------------------------------|
| Test Firm | Sporton International (Shenzhen) Inc. | | |
| Test Site Location | No. 3 Bldg the third floor of south, Shahe River west, Fengzeyuan Warehouse, Nanshan Shenzhen, 518055 People's Republic of China TEL: +86-755-33202398 | | |
| Test Site No. | Sporton Site No. | FCC Designation No. | FCC Test Firm Registration No. |
| | 03CH03-SZ | CN1256 | 421272 |

Note: Test data subcontracted: radiated spurious emissions in section 3.8 of this report



1.7 Test Software

| Item | Site | Manufacture | Name | Version |
|------|-----------|-------------|------|-------------|
| 1. | CO01-KS | AUDIX | E3 | 6.2009-8-24 |
| 2. | 03CH03-SZ | AUDIX | E3 | 6.2009-8-24 |

1.8 Applicable Standards

According to the specifications of the manufacturer, the EUT must comply with the requirements of the following standards:

- ♦ 47 CFR Part 15 Subpart C §15.247
- ♦ FCC KDB 558074 D01 15.247 Meas Guidance v05r02
- ♦ ANSI C63.10-2013

Remark:

1. All test items were verified and recorded according to the standards and without any deviation during the test.
2. This EUT has also been tested and complied with the requirements of FCC Part 15, Subpart B, recorded in a separate test report.



2 Test Configuration of Equipment Under Test

2.1 Carrier Frequency Channel

| Frequency Band | Channel | Freq. (MHz) | Channel | Freq. (MHz) | Channel | Freq. (MHz) |
|-----------------|---------|-------------|---------|-------------|---------|-------------|
| 2400-2483.5 MHz | 0 | 2402 | 27 | 2429 | 54 | 2456 |
| | 1 | 2403 | 28 | 2430 | 55 | 2457 |
| | 2 | 2404 | 29 | 2431 | 56 | 2458 |
| | 3 | 2405 | 30 | 2432 | 57 | 2459 |
| | 4 | 2406 | 31 | 2433 | 58 | 2460 |
| | 5 | 2407 | 32 | 2434 | 59 | 2461 |
| | 6 | 2408 | 33 | 2435 | 60 | 2462 |
| | 7 | 2409 | 34 | 2436 | 61 | 2463 |
| | 8 | 2410 | 35 | 2437 | 62 | 2464 |
| | 9 | 2411 | 36 | 2438 | 63 | 2465 |
| | 10 | 2412 | 37 | 2439 | 64 | 2466 |
| | 11 | 2413 | 38 | 2440 | 65 | 2467 |
| | 12 | 2414 | 39 | 2441 | 66 | 2468 |
| | 13 | 2415 | 40 | 2442 | 67 | 2469 |
| | 14 | 2416 | 41 | 2443 | 68 | 2470 |
| | 15 | 2417 | 42 | 2444 | 69 | 2471 |
| | 16 | 2418 | 43 | 2445 | 70 | 2472 |
| | 17 | 2419 | 44 | 2446 | 71 | 2473 |
| | 18 | 2420 | 45 | 2447 | 72 | 2474 |
| | 19 | 2421 | 46 | 2448 | 73 | 2475 |
| | 20 | 2422 | 47 | 2449 | 74 | 2476 |
| | 21 | 2423 | 48 | 2450 | 75 | 2477 |
| | 22 | 2424 | 49 | 2451 | 76 | 2478 |
| | 23 | 2425 | 50 | 2452 | 77 | 2479 |
| | 24 | 2426 | 51 | 2453 | 78 | 2480 |
| | 25 | 2427 | 52 | 2454 | - | - |
| | 26 | 2428 | 53 | 2455 | - | - |



2.2 Test Mode

- a. The EUT has been associated with peripherals and configuration operated in a manner tended to maximize its emission characteristics in a typical application. Frequency range investigated: conduction emission (150 kHz to 30 MHz), radiation emission (9 kHz to the 10th harmonic of the highest fundamental frequency or to 40 GHz, whichever is lower). For radiated measurement, pre-scanned in three orthogonal panels, X, Y, Z. The worst cases (Y plane) were recorded in this report, and the worst mode of radiated spurious emissions is Bluetooth 1Mbps mode, and recorded in this report.
- b. AC power line Conducted Emission was tested under maximum output power.

The following summary table is showing all test modes to demonstrate in compliance with the standard.

| Summary table of Test Cases | | | |
|--|---|---|---|
| Test Item | Data Rate / Modulation | | |
| | Bluetooth BR 1Mbps GFSK | Bluetooth EDR 2Mbps π/4-DQPSK | Bluetooth EDR 3Mbps 8-DPSK |
| Conducted Test Cases | Mode 1: CH00_2402 MHz Mode 2: CH39_2441 MHz Mode 3: CH78_2480 MHz | Mode 4: CH00_2402 MHz Mode 5: CH39_2441 MHz Mode 6: CH78_2480 MHz | Mode 7: CH00_2402 MHz Mode 8: CH39_2441 MHz Mode 9: CH78_2480 MHz |
| Radiated Test Cases | Bluetooth BR 1Mbps GFSK Mode 1: CH00_2402 MHz Mode 2: CH39_2441 MHz Mode 3: CH78_2480 MHz | | |
| AC Conducted Emission | Mode 1 : GSM850 Idle + Bluetooth Link + WLAN Link (2.4G) + USB Cable (Charging from Adapter) + Earphone | | |
| Remark: 1. For radiated test cases, the worst mode data rate 1Mbps was reported only, because this data rate has the highest RF output power at preliminary tests, and no other significantly frequencies found in conducted spurious emission. 2. For Radiated Test Cases, The tests were performed with Adapter, Earphone and USB Cable . | | | |

2.3 Connection Diagram of Test System

For Radiated Emission:

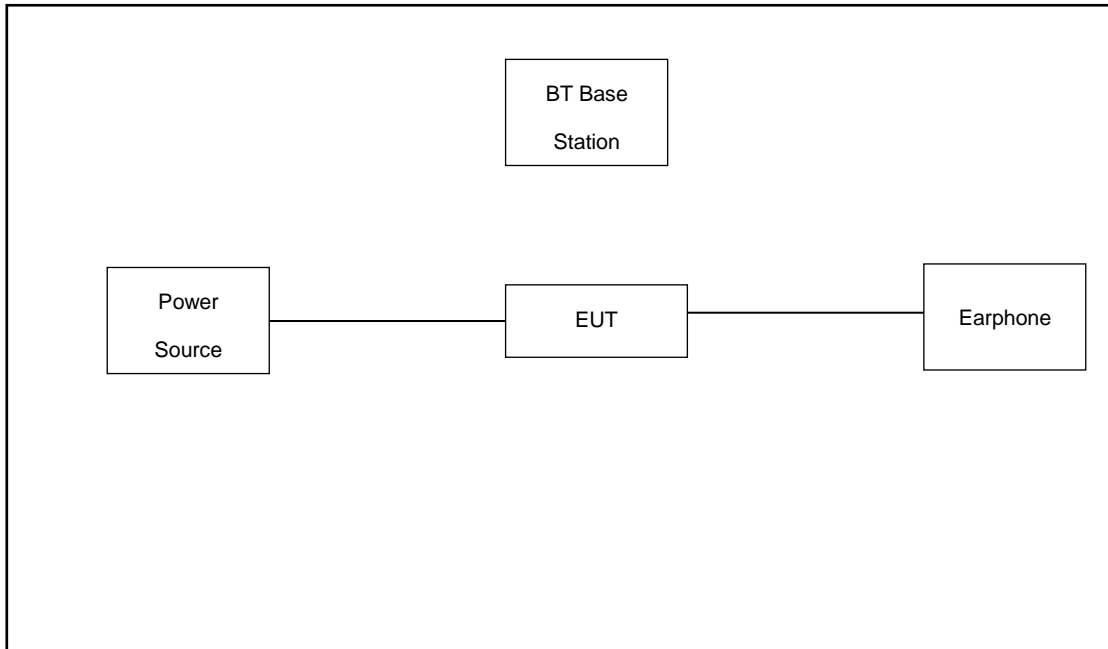

For Conducted Emission:

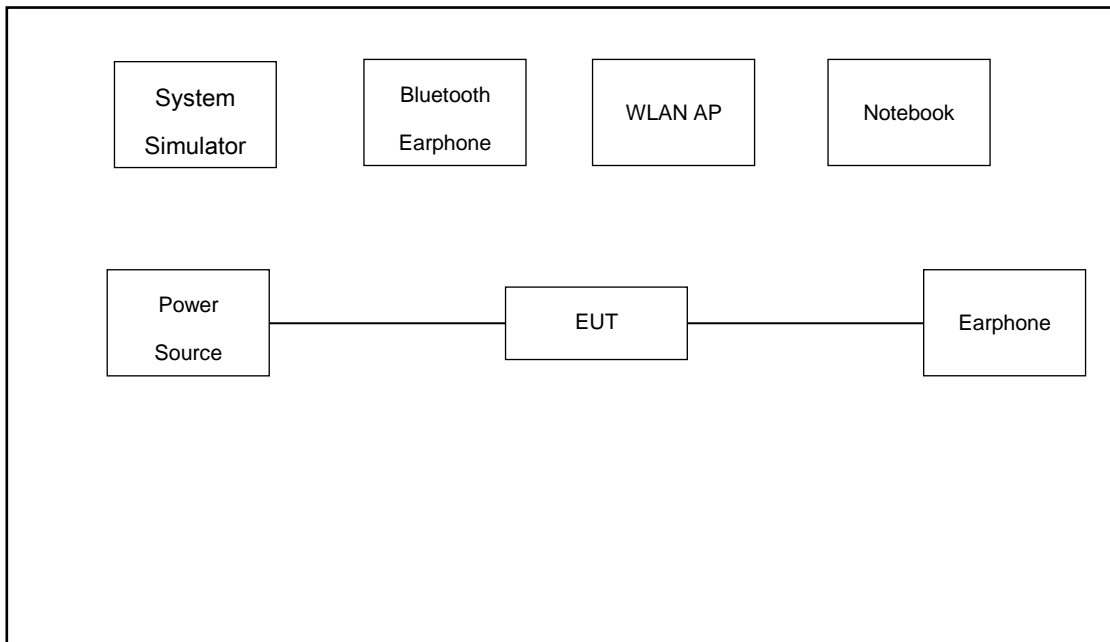

2.4 Support Unit used in test configuration and system

| Item | Equipment | Trade Name | Model Name | FCC ID | Data Cable | Power Cord |
|------|--------------------|------------|------------|---------------|------------|--|
| 1. | System Simulator | R&S | CMU 200 | N/A | N/A | Unshielded, 1.8 m |
| 2. | Bluetooth Station | R&S | CBT | N/A | N/A | Unshielded, 1.8m |
| 3. | WLAN AP | D-link | DIR-655 | KA21R655B1 | N/A | Unshielded, 1.8m |
| 4. | Notebook | Lenovo | G480 | QDS-BRCM1050I | N/A | AC I/P: Unshielded, 1.8 m DC O/P: Shielded, 1.8 m |
| 5. | Bluetooth Earphone | Lenovo | LBH308 | N/A | N/A | N/A |

2.5 EUT Operation Test Setup

For Bluetooth function, the engineering test program was provided and enabled to make EUT connect with Bluetooth base station to continuous transmit/receive.

For AC power line conducted emissions, the EUT was set to connect with the WLAN AP under large package sizes transmission.

2.6 Measurement Results Explanation Example

For all conducted test items:

The offset level is set in the spectrum analyzer to compensate the RF cable loss between EUT conducted output port and spectrum analyzer. With the offset compensation, the spectrum analyzer reading level is exactly the EUT RF output level.

Example:

The spectrum analyzer offset is derived from RF cable loss.

Offset = RF cable loss.

Following shows an offset computation example with cable loss 5.8 dB.

$$\begin{aligned} \text{Offset(dB)} &= \text{RF cable loss(dB)} . \\ &= 5.8 \text{ (dB)} \end{aligned}$$

3 Test Result

3.1 Number of Channel Measurement

3.1.1 Limits of Number of Hopping Frequency

Frequency hopping systems in the 2400-2483.5 MHz band shall use at least 15 channels.

3.1.2 Measuring Instruments

The measuring equipment is listed in the section 4 of this test report.

3.1.3 Test Procedure

1. The testing follows ANSI C63.10-2013 clause 7.8.3.
2. The RF output of EUT was connected to the spectrum analyzer by RF cable and attenuator. The path loss was compensated to the results for each measurement.
3. Set to the maximum power setting and enable the EUT transmit continuously.
4. Enable the EUT hopping function.
5. Use the following spectrum analyzer settings: Span = the frequency band of operation; RBW = 300kHz; VBW \geq RBW; Sweep = auto; Detector function = peak; Trace = max hold.
6. The number of hopping frequency used is defined as the number of total channel.
7. Record the measurement data derived from spectrum analyzer.

3.1.4 Test Setup



3.1.5 Test Result of Number of Hopping Frequency

Please refer to Appendix A.



Number of Hopping Channel Plot on Channel 00 - 78

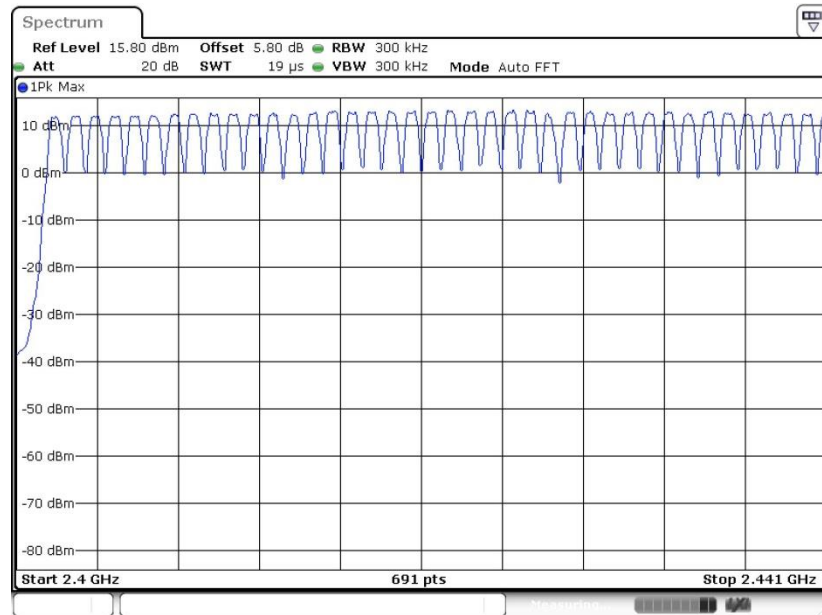

Date: 25 JUN.2020 15:01:03

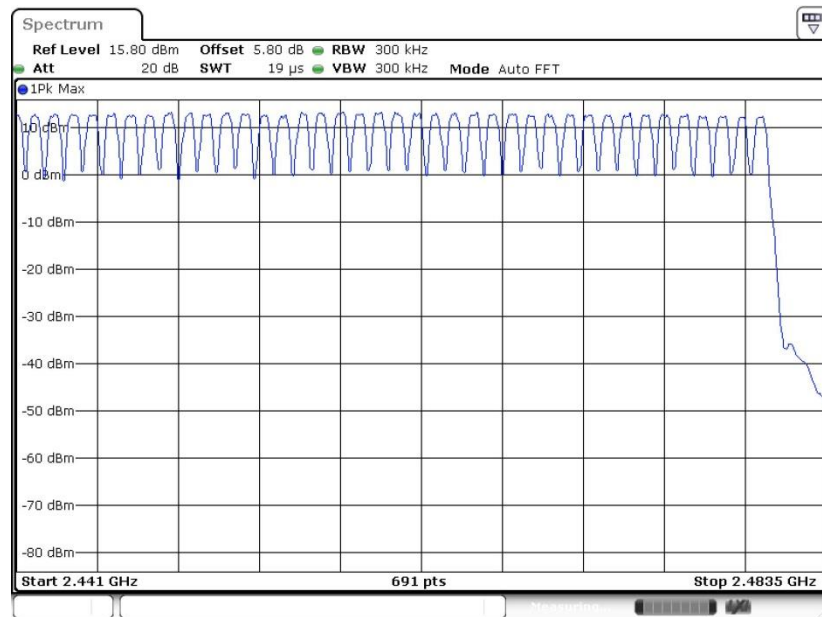

Date: 25 JUN.2020 15:01:13

3.2 Hopping Channel Separation Measurement

3.2.1 Limit of Hopping Channel Separation

Frequency hopping systems operating in the 2400-2483.5 MHz band may have hopping channel carrier frequencies that are separated by 25 kHz or two-thirds of the 20 dB bandwidth of the hopping channel, whichever is greater.

3.2.2 Measuring Instruments

The measuring equipment is listed in the section 4 of this test report.

3.2.3 Test Procedures

1. The testing follows ANSI C63.10-2013 clause 7.8.2.
2. The RF output of EUT was connected to the spectrum analyzer by RF cable and attenuator. The path loss was compensated to the results for each measurement.
3. Set to the maximum power setting and enable the EUT transmit continuously.
4. Enable the EUT hopping function.
5. Use the following spectrum analyzer settings:
Span = wide enough to capture the peaks of two adjacent channels;
RBW = 300kHz; VBW \geq RBW; Sweep = auto; Detector function = peak; Trace = max hold.
6. Measure and record the results in the test report.

3.2.4 Test Setup



3.2.5 Test Result of Hopping Channel Separation

Please refer to Appendix A.



<1Mbps>

Channel Separation Plot on Channel 00 - 01

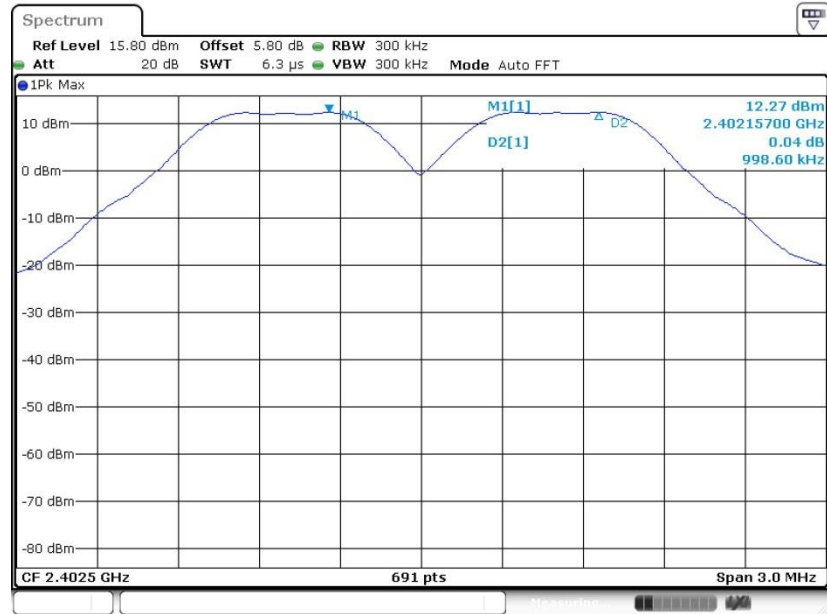

Date: 25 JUN.2020 15:00:45

Channel Separation Plot on Channel 39 - 40

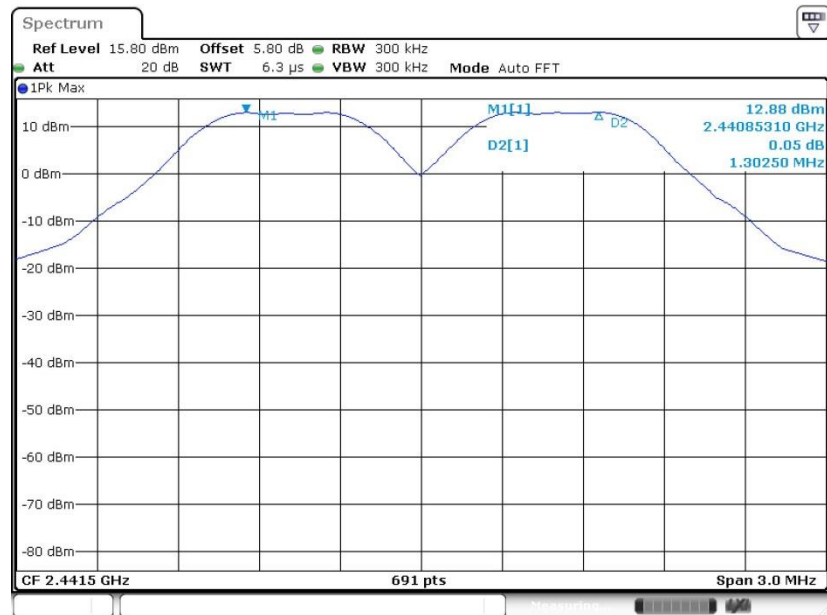

Date: 25 JUN.2020 15:04:33



Channel Separation Plot on Channel 77 - 78

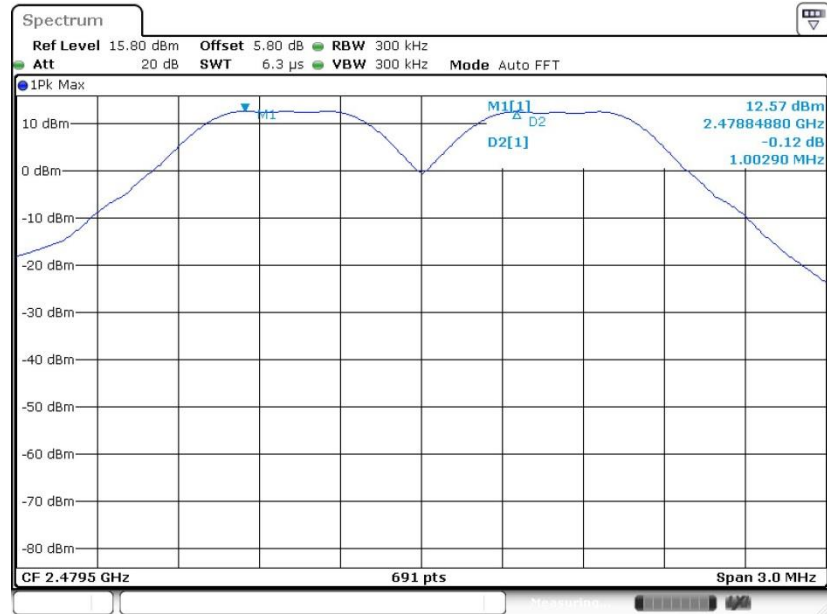

Date: 25 JUN 2020 15:08:48

<2Mbps>

Channel Separation Plot on Channel 00 - 01

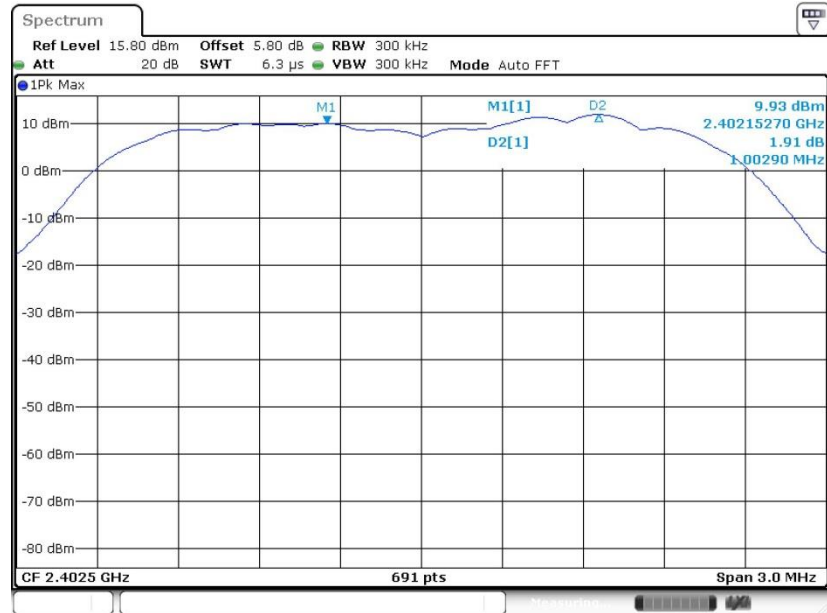

Date: 25 JUN 2020 15:13:52



Channel Separation Plot on Channel 39 - 40

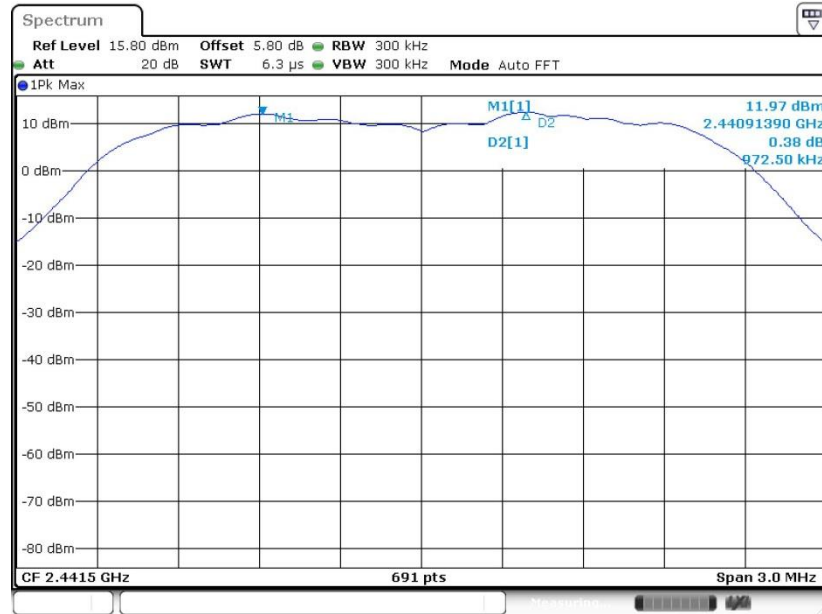

Date: 25 JUN 2020 15:17:58

Channel Separation Plot on Channel 77 - 78

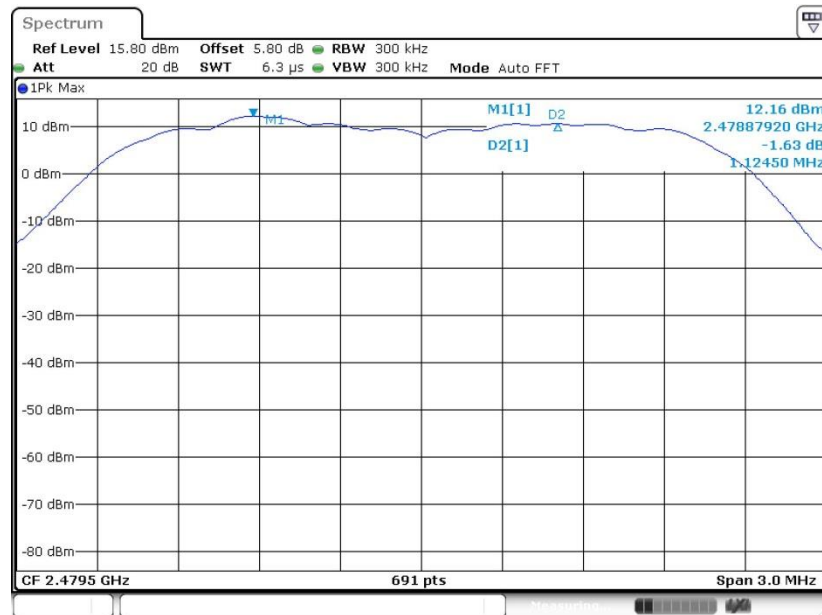

Date: 25 JUN 2020 15:22:21



<3Mbps>

Channel Separation Plot on Channel 00 - 01

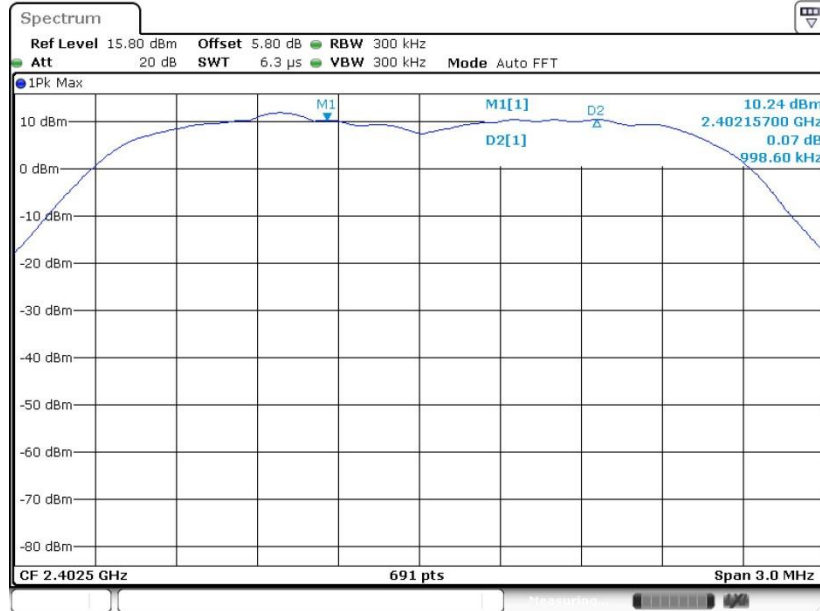

Date: 25 JUN.2020 17:58:15

Channel Separation Plot on Channel 39 - 40

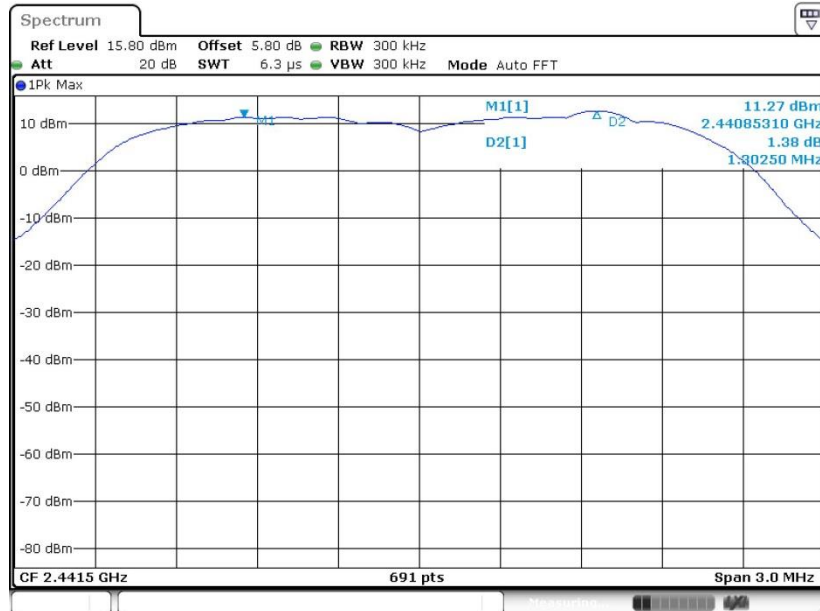

Date: 25 JUN.2020 18:00:04



Channel Separation Plot on Channel 77 - 78

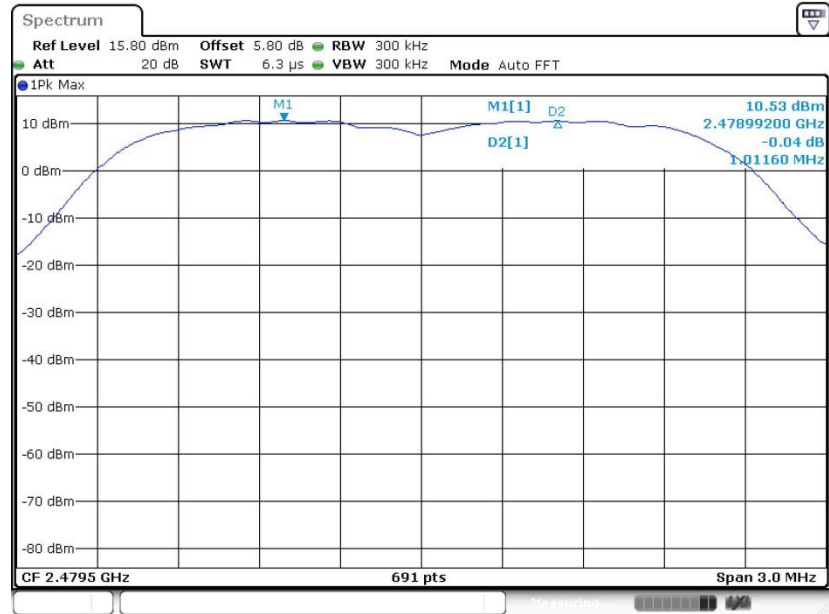

Date: 25 JUN 2020 15:56:38

3.3 Dwell Time Measurement

3.3.1 Limit of Dwell Time

The average time of occupancy on any channel shall not be greater than 0.4 seconds within a period of 0.4 seconds multiplied by the number of hopping channels employed.

3.3.2 Measuring Instruments

The measuring equipment is listed in the section 4 of this test report.

3.3.3 Test Procedures

1. The testing follows ANSI C63.10-2013 clause 7.8.4.
2. The RF output of EUT was connected to the spectrum analyzer by RF cable and attenuator. The path loss was compensated to the results for each measurement.
3. Set to the maximum power setting and enable the EUT transmit continuously.
4. Enable the EUT hopping function.
5. Use the following spectrum analyzer settings: Span = zero span, centered on a hopping channel; RBW = 1 MHz; VBW \geq RBW; Sweep = as necessary to capture the entire dwell time per hopping channel; Detector function = peak; Trace = max hold.
6. Measure and record the results in the test report.

3.3.4 Test Setup





3.3.5 Test Result of Dwell Time

Please refer to Appendix A.

Package Transfer Time Plot

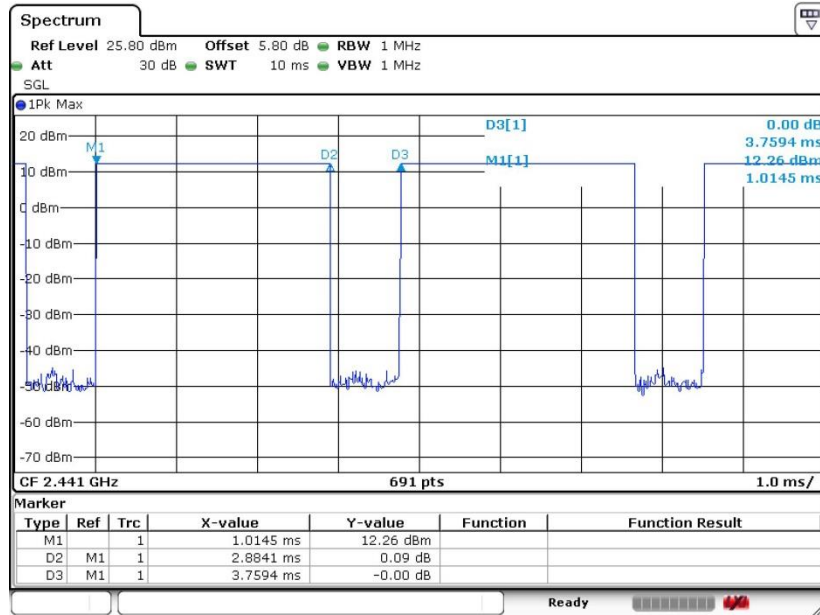

Date: 18 JUN.2020 12:49:59

Remark:

- In normal mode, hopping rate is 1600 hops/s with 6 slots (5 Transmit and 1 Receive slot) in 79 hopping channels.
With channel hopping rate (1600 / 6 / 79) in Occupancy Time Limit (0.4 x 79) (s), Hops Over Occupancy Time comes to (1600 / 6 / 79) x (0.4 x 79) = 106.67 hops.
- In AFH mode, hopping rate is 800 hops/s with 6 slots in 20 hopping channels.
With channel hopping rate (800 / 6 / 20) in Occupancy Time Limit (0.4 x 20) (s), Hops Over Occupancy Time comes to (800 / 6 / 20) x (0.4 x 20) = 53.33 hops.
- Dwell Time(s) = Hops Over Occupancy Time (hops) x Package Transfer Time

3.4 20dB Bandwidth Measurement

3.4.1 Limit of 20dB Bandwidth

Reporting only

3.4.2 Measuring Instruments

The measuring equipment is listed in the section 4 of this test report.

3.4.3 Test Procedures

1. The testing follows ANSI C63.10-2013 clause 6.9.2 and 6.9.3.
2. The RF output of EUT was connected to the spectrum analyzer by RF cable and attenuator. The path loss was compensated to the results for each measurement.
3. Set to the maximum power setting and enable the EUT transmit continuously.
4. Use the following spectrum analyzer settings for 20dB Bandwidth measurement.
Span = approximately 2 to 5 times the 20 dB bandwidth, centered on a hopping channel;
RBW \geq 1% of the 20 dB bandwidth; VBW \geq RBW; Sweep = auto; Detector function = peak;
Trace = max hold.
5. Measure and record the results in the test report.

3.4.4 Test Setup

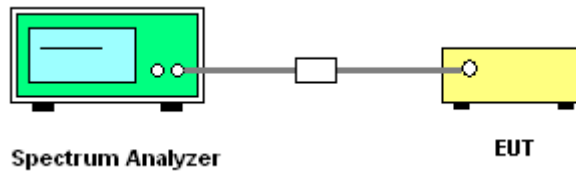

3.4.5 Test Result of 20dB Bandwidth

Please refer to Appendix A.



<1Mbps>

20 dB Bandwidth Plot on Channel 00

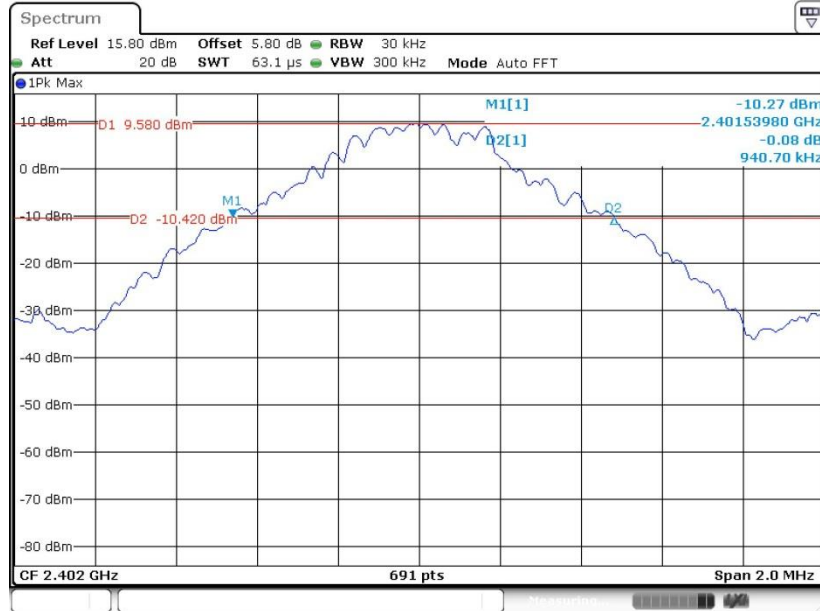

Date: 25 JUN 2020 14:57:23

20 dB Bandwidth Plot on Channel 39

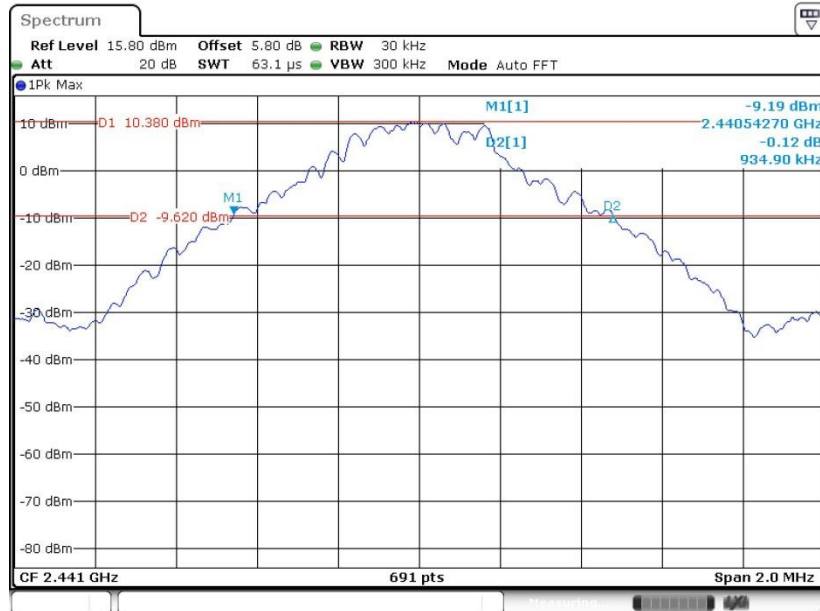

Date: 25 JUN 2020 15:02:16



20 dB Bandwidth Plot on Channel 78

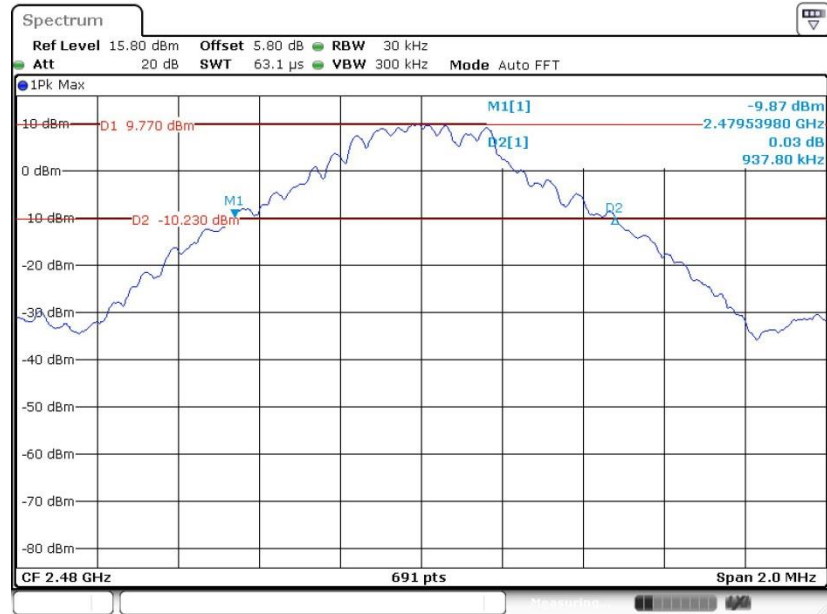

Date: 25 JUN.2020 15:05:35

<2Mbps>

20 dB Bandwidth Plot on Channel 00

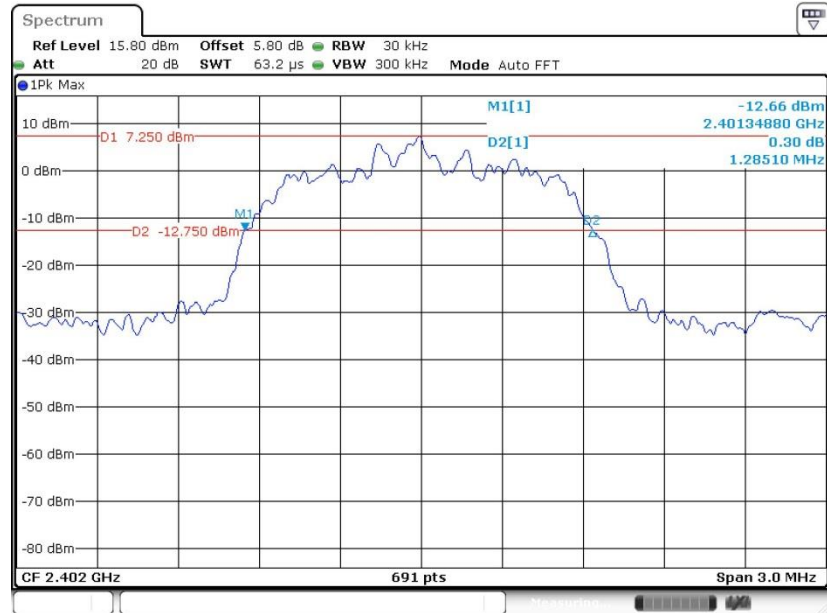

Date: 25 JUN.2020 15:09:41



20 dB Bandwidth Plot on Channel 39

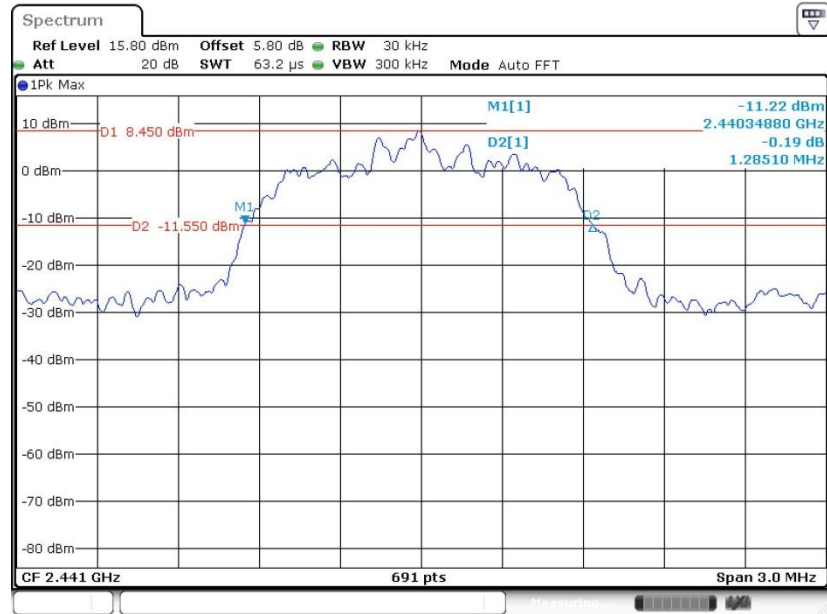

Date: 25 JUN.2020 15:14:45

20 dB Bandwidth Plot on Channel 78

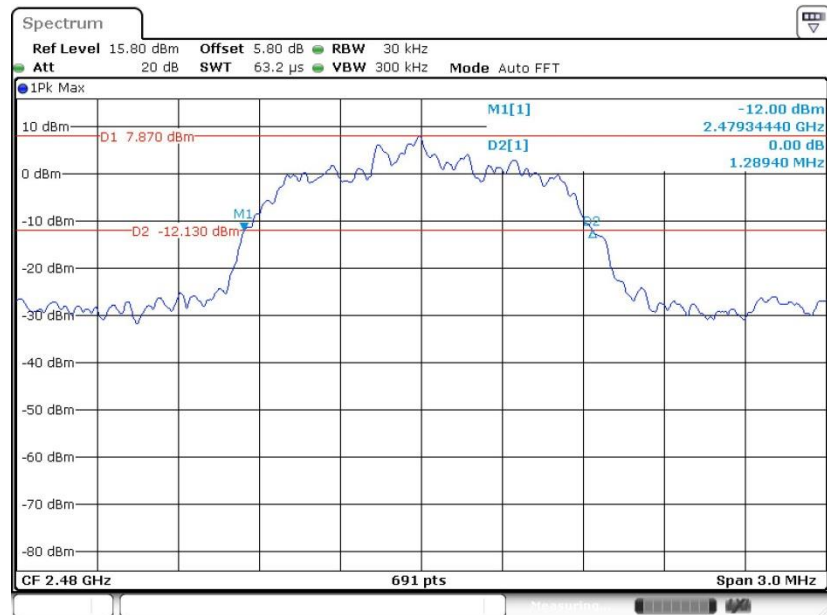

Date: 25 JUN.2020 15:18:57



<3Mbps>

20 dB Bandwidth Plot on Channel 00

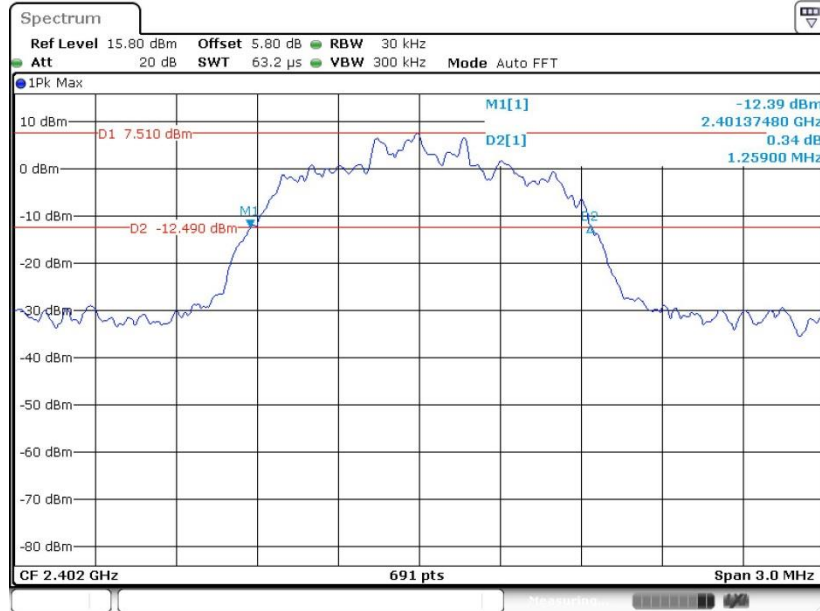

Date: 25 JUN.2020 17:56:49

20 dB Bandwidth Plot on Channel 39

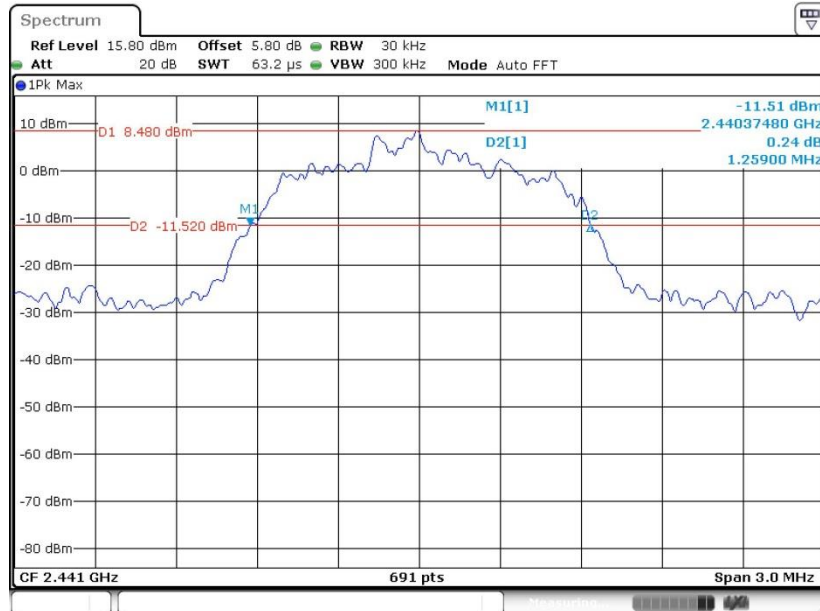

Date: 25 JUN.2020 15:36:38



20 dB Bandwidth Plot on Channel 78

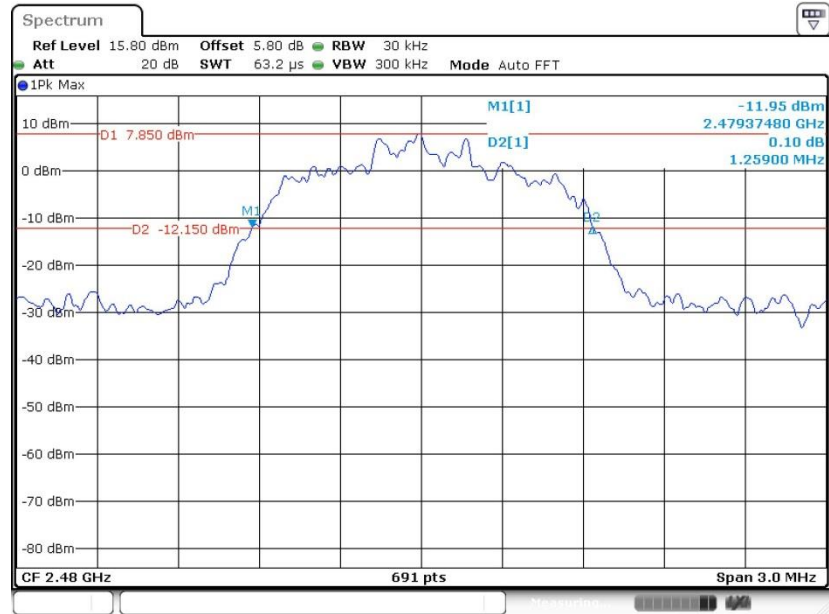

Date: 25 JUN.2020 15:43:56

3.5 Output Power Measurement

3.5.1 Limit of Output Power

The maximum peak conducted output power of the intentional radiator shall not exceed the following:

- (1) For frequency hopping systems operating in the 2400-2483.5 MHz band employing at least 75 non-overlapping hopping channels, and all frequency hopping systems in the 5725-5850 MHz band: 1 watt. For all other frequency hopping systems in the 2400-2483.5 MHz band 0.125 watts.

3.5.2 Measuring Instruments

The measuring equipment is listed in the section 4 of this test report.

3.5.3 Test Procedures

1. The testing follows ANSI C63.10-2013 clause 7.8.5.
2. The RF output of EUT was connected to the power meter by RF cable and attenuator. The path loss was compensated to the results for each measurement.
3. Set to the maximum power setting and enable the EUT transmit continuously.
4. Measure the conducted output power with cable loss and record the results in the test report.
5. Measure and record the results in the test report.

3.5.4 Test Setup

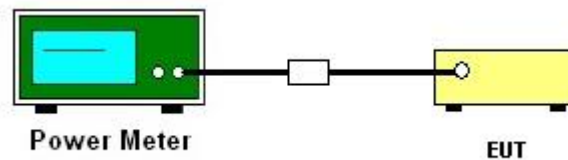

3.5.5 Test Result of Peak Output Power

Please refer to Appendix A.

3.6 Conducted Band Edges Measurement

3.6.1 Limit of Band Edges

In any 100 kHz bandwidth outside the intentional radiation frequency band, the radio frequency power shall be at least 20 dB below the highest level of the radiated power. In addition, radiated emissions which fall in the restricted bands must also comply with the radiated emission limits.

3.6.2 Measuring Instruments

The measuring equipment is listed in the section 4 of this test report.

3.6.3 Test Procedures

1. The testing follows ANSI C63.10-2013 clause 7.8.6.
2. Set to the maximum power setting and enable the EUT transmit continuously.
3. Set RBW = 100kHz, VBW = 300kHz. Band edge emissions must be at least 20 dB down from the highest emission level within the authorized band as measured with a 100kHz RBW. The attenuation shall be 30 dB instead of 20 dB when RMS conducted output power procedure is used.
4. Enable hopping function of the EUT and then repeat step 2. and 3.
5. Measure and record the results in the test report.

3.6.4 Test Setup





3.6.5 Test Result of Conducted Band Edges

<1Mbps>

Low Band Edge Plot on Channel 00

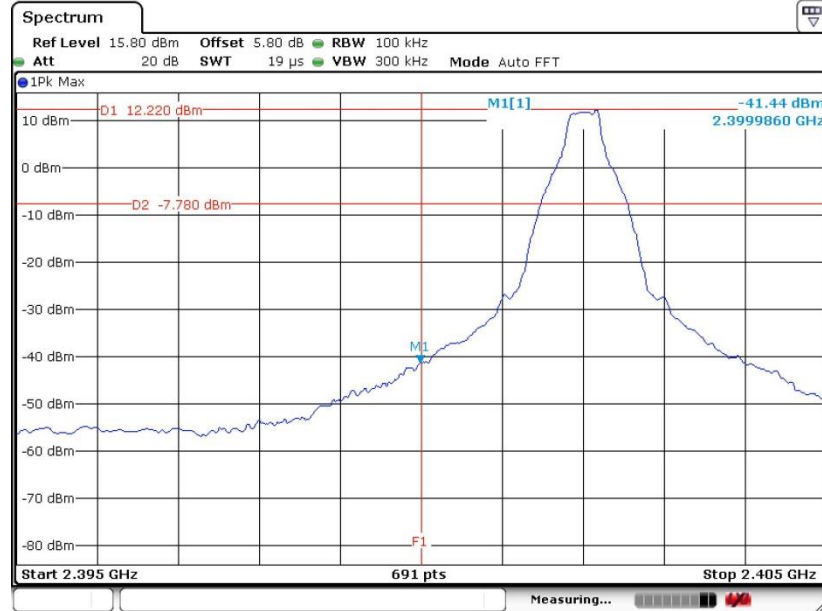

Date: 25 JUN.2020 14:57:59

High Band Edge Plot on Channel 78

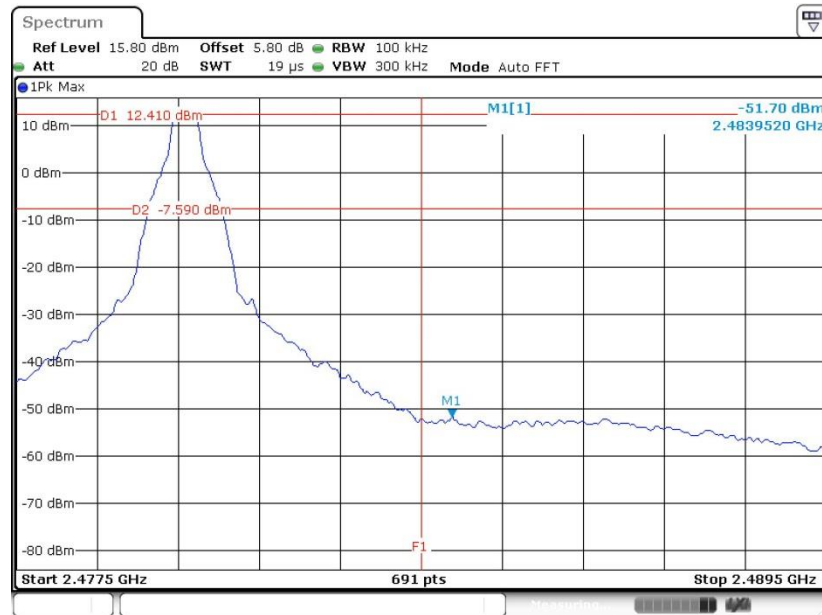

Date: 25 JUN.2020 15:06:11



<2Mbps>

Low Band Edge Plot on Channel 00

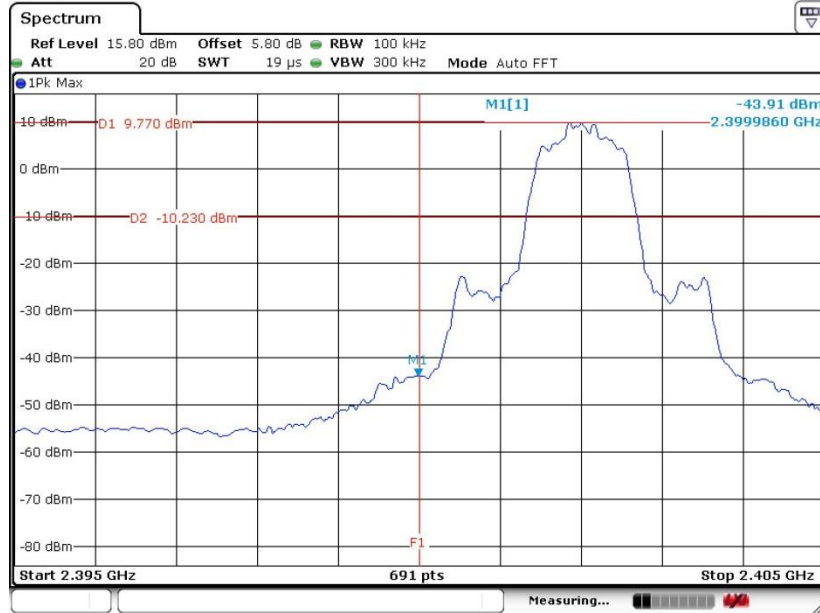

Date: 25 JUN.2020 15:10:04

High Band Edge Plot on Channel 78

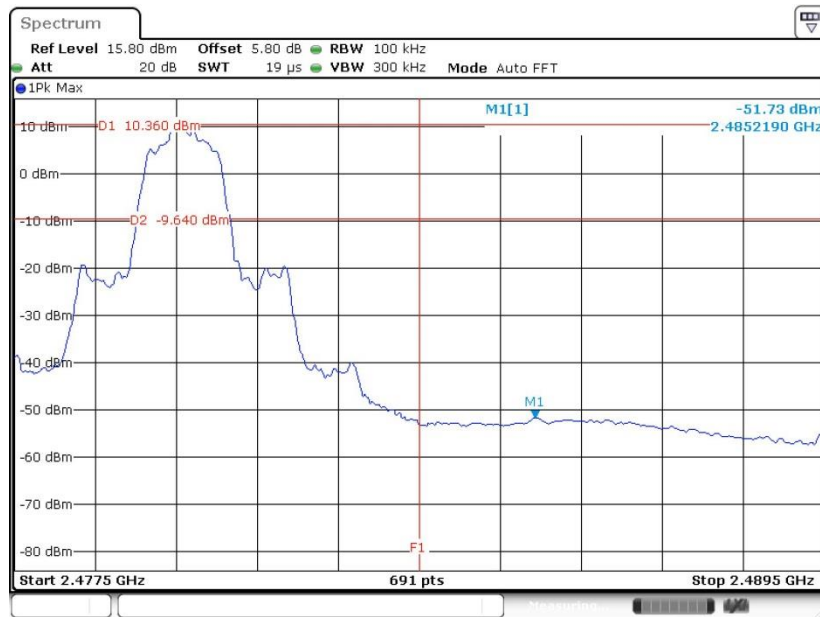

Date: 25 JUN.2020 15:19:14



<3Mbps>

Low Band Edge Plot on Channel 00

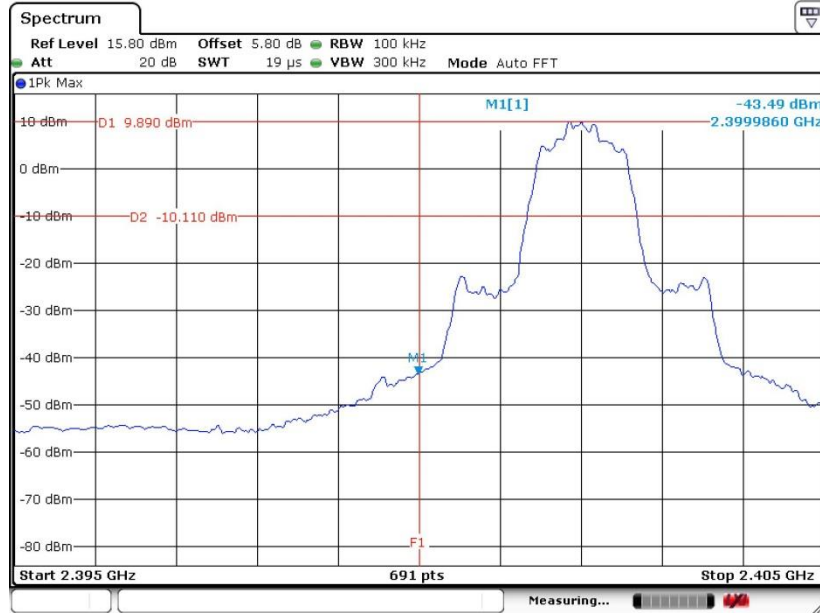

High Band Edge Plot on Channel 78

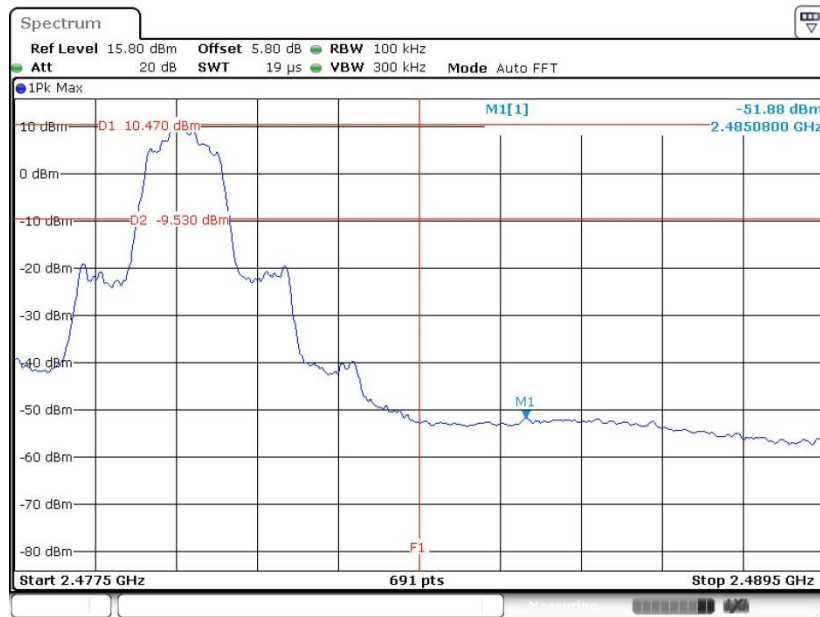



3.6.6 Test Result of Conducted Hopping Mode Band Edges

<1Mbps>

Hopping Mode Low Band Edge Plot

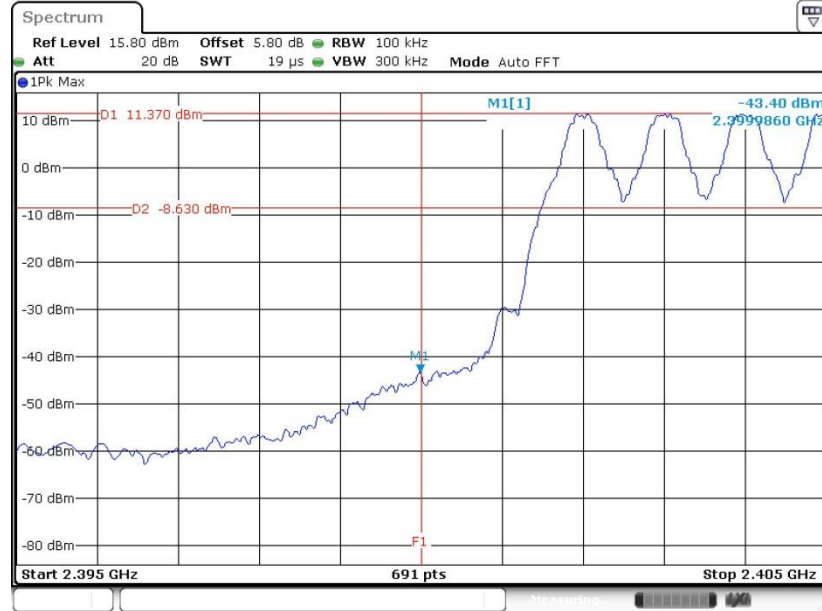

Date: 25 JUN.2020 14:58:27

Hopping Mode High Band Edge Plot

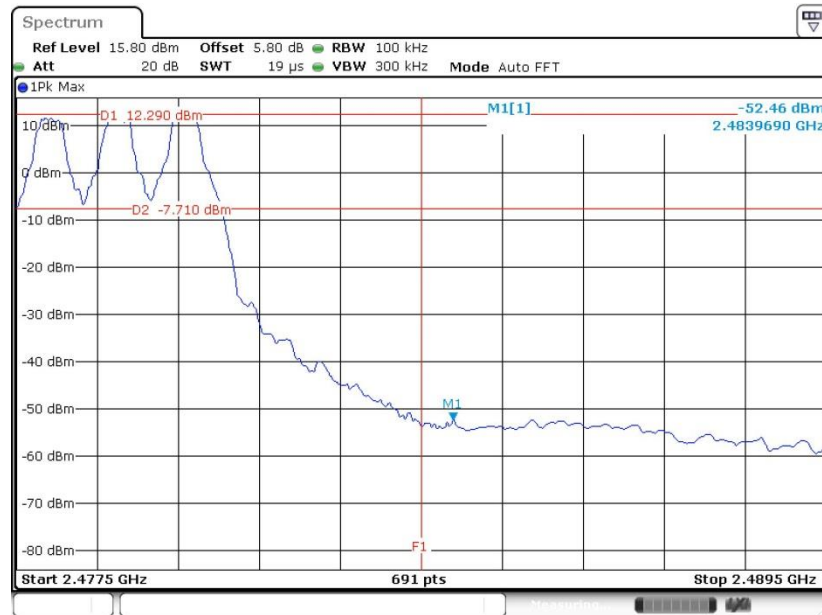

Date: 25 JUN.2020 15:06:19



<2Mbps>

Hopping Mode Low Band Edge Plot

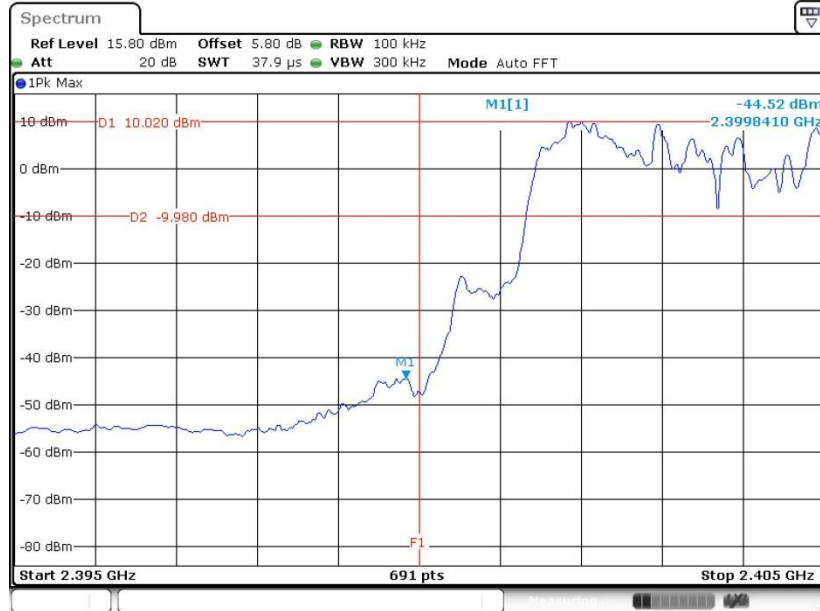

Date: 25 JUN.2020 17:54:24

Hopping Mode High Band Edge Plot

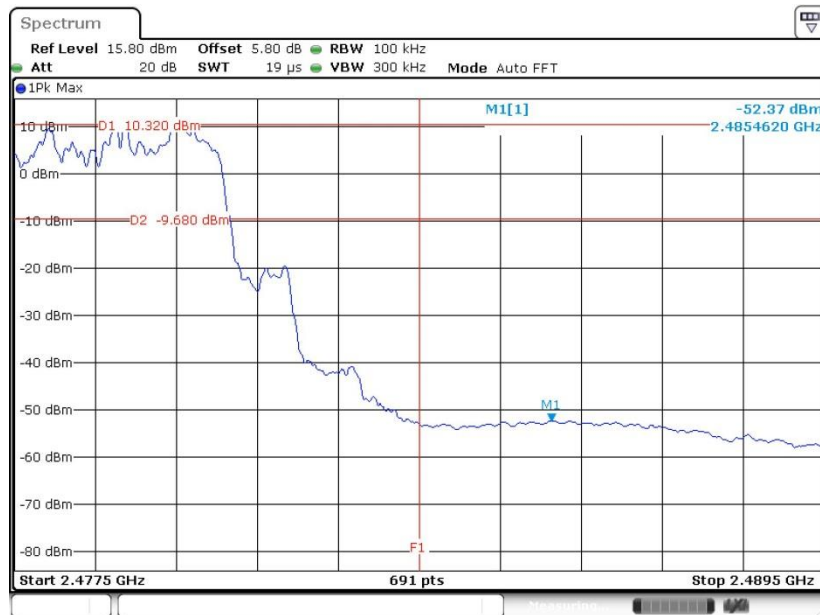

Date: 25 JUN.2020 15:19:38



<3Mbps>

Hopping Mode Low Band Edge Plot

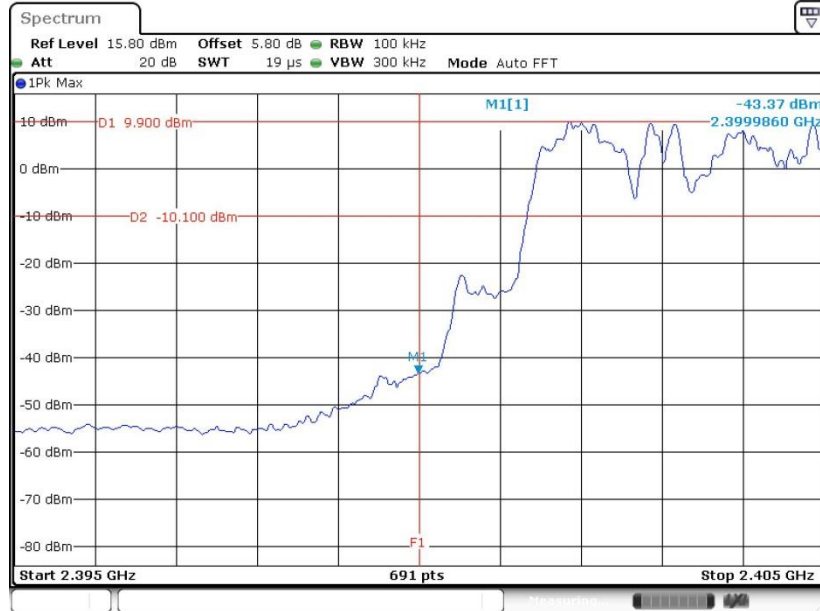

Date: 25 JUN.2020 15:53:52

Hopping Mode High Band Edge Plot



Date: 25 JUN.2020 15:54:30

3.7 Conducted Spurious Emission Measurement

3.7.1 Limit of Spurious Emission Measurement

In any 100 kHz bandwidth outside the intentional radiation frequency band, the radio frequency power shall be at least 20 dB below the highest level of the radiated power. In addition, radiated emissions which fall in the restricted bands must also comply with the radiated emission limits.

3.7.2 Measuring Instruments

The measuring equipment is listed in the section 4 of this test report.

3.7.3 Test Procedure

1. The testing follows ANSI C63.10-2013 clause 7.8.8.
2. The RF output of EUT was connected to the spectrum analyzer by RF cable and attenuator. The path loss was compensated to the results for each measurement.
3. Set to the maximum power setting and enable the EUT transmit continuously.
4. Set RBW = 100 kHz, VBW = 300kHz, scan up through 10th harmonic. All harmonics / spurs must be at least 20 dB down from the highest emission level within the authorized band as measured with a 100 kHz RBW.
5. Measure and record the results in the test report.
6. The RF fundamental frequency should be excluded against the limit line in the operating frequency band.

3.7.4 Test Setup

