



# SAR TEST REPORT

No. I20Z60764-SEM03

For

**TCL Communication Ltd**

**5G NR/ LTE/WCDMA/GSM Mobile Phone**

**Model name: T790W,T790Z**

With

**Hardware Version: 05**

**Software Version: 6BSEE000**

**FCC ID: 2ACCJN039**

**Issued Date: 2020-7-8**

**Note:**

The test results in this test report relate only to the devices specified in this report. This report shall not be reproduced except in full without the written approval of CTTL.

The report must not be used by the client to claim product certification, approval, or endorsement by NVLAP, NIST, or any agency of the U.S.Government.

**Test Laboratory:**

CTTL, Telecommunication Technology Labs, CAICT

No. 51, Xueyuan Road, Haidian District, Beijing, P. R. China 100191.

Tel:+86(0)10-62304633-2512, Fax:+86(0)10-62304633-2504

Email: [ctl\\_terminals@caict.ac.cn](mailto:ctl_terminals@caict.ac.cn), website: [www.caict.ac.cn](http://www.caict.ac.cn)

**REPORT HISTORY**

<b>Report Number</b>	<b>Revision</b>	<b>Issue Date</b>	<b>Description</b>
I20Z60764-SEM03	Rev.0	2020-7-2	Initial creation of test report
I20Z60764-SEM03	Rev.1	2020-7-8	Update the data of table 14.6-7 on page 180. Update the data of table 14.1-45 on page 152.

## TABLE OF CONTENT

<b>1 TEST LABORATORY .....</b>	<b>5</b>
1.1 TESTING LOCATION .....	5
1.2 TESTING ENVIRONMENT.....	5
1.3 PROJECT DATA .....	5
1.4 SIGNATURE.....	5
<b>2 STATEMENT OF COMPLIANCE .....</b>	<b>6</b>
<b>3 CLIENT INFORMATION .....</b>	<b>9</b>
3.1 APPLICANT INFORMATION .....	9
3.2 MANUFACTURER INFORMATION .....	9
<b>4 EQUIPMENT UNDER TEST (EUT) AND ANCILLARY EQUIPMENT (AE) .....</b>	<b>10</b>
4.1 ABOUT EUT .....	10
4.2 INTERNAL IDENTIFICATION OF EUT USED DURING THE TEST.....	11
4.3 INTERNAL IDENTIFICATION OF AE USED DURING THE TEST .....	11
<b>5 TEST METHODOLOGY .....</b>	<b>12</b>
5.1 APPLICABLE LIMIT REGULATIONS.....	12
5.2 APPLICABLE MEASUREMENT STANDARDS .....	12
<b>6 SPECIFIC ABSORPTION RATE (SAR).....</b>	<b>13</b>
6.1 INTRODUCTION.....	13
6.2 SAR DEFINITION.....	13
<b>7 TISSUE SIMULATING LIQUIDS .....</b>	<b>14</b>
7.1 TARGETS FOR TISSUE SIMULATING LIQUID.....	14
7.2 DIELECTRIC PERFORMANCE .....	14
<b>8 SYSTEM VERIFICATION .....</b>	<b>19</b>
8.1 SYSTEM SETUP.....	19
8.2 SYSTEM VERIFICATION.....	20
<b>9 MEASUREMENT PROCEDURES .....</b>	<b>21</b>
9.1 TESTS TO BE PERFORMED .....	21
9.2 GENERAL MEASUREMENT PROCEDURE.....	22
9.3 WCDMA MEASUREMENT PROCEDURES FOR SAR .....	24
9.4 SAR MEASUREMENT FOR LTE.....	25
9.5 BLUETOOTH & WI-FI MEASUREMENT PROCEDURES FOR SAR .....	27
9.6 POWER DRIFT.....	27
<b>10 AREA SCAN BASED 1-G SAR.....</b>	<b>28</b>
10.1 REQUIREMENT OF KDB.....	28
10.2 FAST SAR ALGORITHMS .....	28

<b>11 CONDUCTED OUTPUT POWER</b> .....	<b>29</b>
11.1 GSM MEASUREMENT RESULT .....	29
11.2 WCDMA MEASUREMENT RESULT .....	31
11.3 CDMA MEASUREMENT RESULT .....	33
11.4 LTE MEASUREMENT RESULT .....	35
11.4 Wi-Fi AND BT MEASUREMENT RESULT .....	123
11.5 NR 5G MEASUREMENT RESULT .....	125
<b>12 SIMULTANEOUS TX SAR CONSIDERATIONS</b> .....	<b>131</b>
12.1 INTRODUCTION.....	131
12.2 TRANSMIT ANTENNA SEPARATION DISTANCES.....	131
12.3 SAR MEASUREMENT POSITIONS .....	132
12.4 STANDALONE SAR TEST EXCLUSION CONSIDERATIONS .....	132
<b>13 EVALUATION OF SIMULTANEOUS</b> .....	<b>133</b>
<b>14 SAR TEST RESULT</b> .....	<b>135</b>
14.1 SAR RESULTS FOR FAST SAR .....	136
14.2 SAR RESULTS FOR STANDARD PROCEDURE .....	157
14.3 WLAN EVALUATION FOR 2.4G .....	167
14.4 WLAN EVALUATION FOR 5G.....	171
14.5 SAR RESULTS FOR FAST BT .....	177
14.6 SAR RESULTS FOR SUB6G.....	178
<b>15 SAR MEASUREMENT VARIABILITY</b> .....	<b>184</b>
<b>16 MEASUREMENT UNCERTAINTY</b> .....	<b>187</b>
16.1 MEASUREMENT UNCERTAINTY FOR NORMAL SAR TESTS (300MHZ~3GHZ).....	187
16.2 MEASUREMENT UNCERTAINTY FOR NORMAL SAR TESTS (3~6GHZ) .....	188
16.3 MEASUREMENT UNCERTAINTY FOR FAST SAR TESTS (300MHZ~3GHZ).....	189
16.4 MEASUREMENT UNCERTAINTY FOR FAST SAR TESTS (3~6GHZ) .....	190
<b>17 MAIN TEST INSTRUMENTS</b> .....	<b>191</b>
<b>ANNEX A GRAPH RESULTS</b> .....	<b>192</b>
<b>ANNEX B SYSTEM VERIFICATION RESULTS</b> .....	<b>270</b>
<b>ANNEX C SAR MEASUREMENT SETUP</b> .....	<b>287</b>
<b>ANNEX D POSITION OF THE WIRELESS DEVICE IN RELATION TO THE PHANTOM</b> .....	<b>293</b>
<b>ANNEX E EQUIVALENT MEDIA RECIPES</b> .....	<b>296</b>
<b>ANNEX F SYSTEM VALIDATION</b> .....	<b>297</b>
<b>ANNEX G PROBE CALIBRATION CERTIFICATE</b> .....	<b>298</b>
<b>ANNEX H DIPOLE CALIBRATION CERTIFICATE</b> .....	<b>321</b>
<b>ANNEX I ACCREDITATION CERTIFICATE</b> .....	<b>392</b>

## 1 Test Laboratory

### 1.1 Testing Location

Company Name:	CTTL(Shouxiang)
Address:	No. 51 Shouxiang Science Building, Xueyuan Road, Haidian District, Beijing, P. R. China100191

### 1.2 Testing Environment

Temperature:	18°C~25°C,
Relative humidity:	30%~ 70%
Ground system resistance:	< 0.5 $\Omega$
Ambient noise & Reflection:	< 0.012 W/kg

### 1.3 Project Data

Project Leader:	Qi Dianyuan
Test Engineer:	Lin Xiaojun
Testing Start Date:	June 4, 2020
Testing End Date:	June 19, 2020

### 1.4 Signature



---

Lin Xiaojun  
(Prepared this test report)

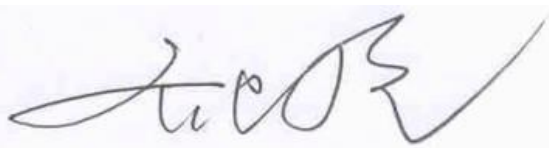

---

Qi Dianyuan  
(Reviewed this test report)

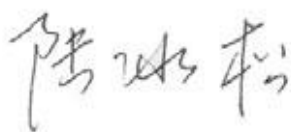

---

Lu Bingsong  
Deputy Director of the laboratory  
(Approved this test report)

## 2 Statement of Compliance

The maximum results of Specific Absorption Rate (SAR) found during testing for TCL Communication Ltd 5G NR/ LTE/WCDMA/GSM Mobile Phone T790W,T790Z are as follows:

**Table 2.1: Highest Reported SAR (1g)**

Exposure Configuration	Technology Band	Highest Reported SAR 1g(W/kg)	Equipment Class
Head (Separation Distance 0mm)	GSM 850	0.23	PCE
	PCS 1900	1.34	
	UMTS FDD 2	0.98	
	UMTS FDD 4	0.95	
	UMTS FDD 5	0.69	
	CDMA BC0	0.54	
	CDMA BC1	0.91	
	CDMA BC10	0.58	
	LTE Band 7	0.52	
	LTE Band 12	0.79	
	LTE Band 13	0.27	
	LTE Band 25	0.93	
	LTE Band 26	0.57	
	LTE Band 41(Power Class 3)	0.22	
	LTE Band 41(Power Class 2)	0.17	
	LTE Band 66	0.95	
	LTE Band 71	0.59	
	WLAN 2.4 GHz	0.82	DTS
WLAN 5 GHz	0.21	UNII	
Hotspot (Separation Distance 10mm)	GSM 850	0.44	PCE
	PCS 1900	0.95	
	UMTS FDD 2	1.05	
	UMTS FDD 4	0.80	
	UMTS FDD 5	0.96	
	CDMA BC0	0.70	
	CDMA BC1	0.96	
	CDMA BC10	0.75	
	LTE Band 7	1.00	
	LTE Band 12	0.70	
	LTE Band 13	0.40	
	LTE Band 25	1.05	
	LTE Band 26	1.12	
	LTE Band 41(Power Class 3)	0.50	
	LTE Band 41(Power Class 2)	0.33	
	LTE Band 66	0.41	
	LTE Band 71	0.86	
	WLAN 2.4 GHz	0.15	DTS
WLAN 5 GHz	0.76	UNII	
Body-worn (Separation Distance	UMTS FDD 2	0.38	PCE
	UMTS FDD 4	0.87	
	CDMA BC1	0.79	

15mm)	LTE Band 7	<b>0.46</b>
	LTE Band 25	<b>0.36</b>
	LTE Band 41(Power Class 3)	<b>0.27</b>
	LTE Band 41(Power Class 2)	<b>0.56</b>
	LTE Band 66	<b>0.77</b>

The SAR values found for the Mobile Phone are below the maximum recommended levels of 1.6 W/kg as averaged over any 1g tissue according to the ANSI C95.1-1992.

For body operation, this device has been tested and meets FCC RF exposure guidelines when used with any accessory that contains no metal and which provides a minimum separation distance of 10 mm for hotspot and 15mm for body worn between this device and the body of the user. Use of other accessories may not ensure compliance with FCC RF exposure guidelines.

The EUT battery must be fully charged and checked periodically during the test to ascertain uniform power output.

The measurement together with the test system set-up is described in annex C of this test report. A detailed description of the equipment under test can be found in chapter 4 of this test report. The highest reported SAR value is obtained at the case of **(Table 2.1)**, and the values are: **1.34 W/kg(1g)**.

**Table 2.2: The sum of reported SAR values for Main antenna and WiFi-2.4G**

	Position	Band	Cellular antenna	WiFi	Sum
<b>Highest reported SAR value for Head</b>	Right hand, Cheek	GSM1900	1.34	0.13	<b>1.47</b>

Note1: we have evaluated and chose the highest value of WiFi 2.4G and 5G in the above table.

**Table 2.3: The sum of reported SAR values for Main antenna + WiFi-5G+BT**

	Position	Band	Cellular antenna	WiFi-5G	BT	Sum
<b>Maximum reported SAR value for Body</b>	Rear 10mm	(ENDC N41+LTE Band2)	1.28	0.26	<0.01	<b>1.54</b>

Note1: we have evaluated and chose the highest value of WiFi 2.4G and 5G in the above table.

Note2: we have evaluated and chose the highest value of body 10mm and 15mm in the above table.

According to the above tables, the highest sum of reported SAR values is **1.54 W/kg (1g)**. The detail for simultaneous transmission consideration is described in chapter 13.

According to the KDB648474 D04, the UMPC mini-tablet procedures must also be applied to test the SAR of all surfaces and edges with an antenna located at  $\leq 25$  mm from that surface or edge, in direct contact with a flat phantom, for 10-g extremity SAR according to the body-equivalent tissue dielectric parameters in KDB Publication 865664 D01 to address interactive hand use exposure conditions. When hotspot mode applies, 10-g extremity SAR is required only for the surfaces and edges with hotspot mode 1-g reported SAR  $> 1.2$  W/kg

**Table 2.4: 0mm Reported SAR for phablet (10g)**

Exposure Configuration	Technology Band	Highest Reported SAR 10g(W/kg)	Limit 10g (W/kg)
10g extremity SAR (Separation Distance 0mm)	UMTS FDD 4	3.53	4.0
	UMTS FDD 2	1.91	4.0
	CDMA BC1	1.74	4.0
	LTE Band 7	3.95	4.0
	LTE Band 25	2.45	4.0
	ENDC N2+LTE Band12	3.05	4.0
	ENDC N66+LTE Band12	3.32	4.0





### 3 Client Information

#### 3.1 Applicant Information

Company Name:	TCL Communication Ltd.
Address/Post:	5/F, Building 22E, 22 Science Park East Avenue, Hong Kong Science Park, Shatin, NT, Hong Kong
Contact Person:	Gong Zhizhou
E-mail:	zhizhou.gong@tcl.com
Telephone:	0086-755-36611722
Fax:	0086-75536612000-81722

#### 3.2 Manufacturer Information

Company Name:	TCL Communication Ltd.
Address/Post:	5/F, Building 22E, 22 Science Park East Avenue, Hong Kong Science Park, Shatin, NT, Hong Kong
Contact Person:	Gong Zhizhou
E-mail:	zhizhou.gong@tcl.com
Telephone:	0086-755-36611722
Fax:	0086-75536612000-81722

## 4 Equipment Under Test (EUT) and Ancillary Equipment (AE)

### 4.1 About EUT

Description:	5G NR/ LTE/WCDMA/GSM Mobile Phone
Model name:	T790W,T790Z
Operating mode(s):	GSM850/900/1800/1900, WCDMA850/900/1700/1900/2100, CDMA BC0/1/10, LTE Band 1/3/5/7/8/20/28/38/40/41, BT, Wi-Fi(2.4G/5G),NR5G
Tested Tx Frequency:	824 – 849 MHz (GSM 850)
	1850 – 1910 MHz (GSM 1900)
	824–849 MHz (WCDMA 850 Band V)
	1710 – 1755 MHz (WCDMA 1700 Band IV)
	1850–1910 MHz (WCDMA1900 Band II)
	824.7 - 848.31 MHz (CDMA BC0)
	1851.25 - 1908.75 MHz (CDMA BC1)
	817.9 - 823.1 MHz (CDMA BC10)
	1850.7 – 1909.3 MHz(LTE Band 2)
	2502.5 – 2567.5 MHz(LTE Band 7)
	699.7 – 715.3 MHz (LTE Band 12)
	779.5 –784.5 MHz (LTE Band 13)
	1850.7 – 1914.3 MHz (LTE Band 25)
	814.7 – 848.3 MHz (LTE Band 26)
	2498.5 – 2687.5 MHz (LTE Band 41)
	1710.7 – 1779.3 MHz (LTE Band 66)
	665.5 – 695.5 MHz (LTE Band 71)
	2412 – 2462 MHz (Wi-Fi 2.4G)
	5150-5825 MHz (Wi-Fi 5G)
	1852.5 – 1907.5 MHz(n2)
1852.5 – 1912.5 MHz (n25)	
2506.02 – 2679.99 MHz (n41)	
1712.5 – 1777.5 MHz (n66)	
665.5 – 695.5 MHz n71)	
GPRS/EGPRS Multislot Class:	12
GPRS capability Class:	B
Test device Production information:	Production unit
Device type:	Portable device
Antenna type:	Integrated antenna
Accessories/Body-worn configurations:	Headset
Hotspot mode:	Support
VoIP:	Support

**4.2 Internal Identification of EUT used during the test**

EUT ID*	IMEI	HW	SW Version
EUT1	015710000201905	05	6BSEE000
EUT2	015710000201906	05	6BSEE000
EUT3	015710000201907	05	6BSEE000
EUT4	015710000201908	05	6BSEE000
EUT5	015710000201909	05	6BSEE000
EUT6	015710000201910	05	6BSEE000
EUT7	015710000201901	05	6BSEE000
EUT8	015710000201902	05	6BSEE000
EUT9	015710000201903	05	6BSEE000
EUT10	015710000201904	05	6BSEE000

\*EUT ID: is used to identify the test sample in the lab internally.

**Note:** It is performed to test SAR with the EUT1-6 and conducted power with the EUT7-10.

**4.3 Internal Identification of AE used during the test**

AE ID*	Description	Model	SN	Manufacturer
AE1	Battery	TLp043E1	/	BYD

\*AE ID: is used to identify the test sample in the lab internally.

## 5 TEST METHODOLOGY

### 5.1 Applicable Limit Regulations

**ANSI C95.1–1992:** IEEE Standard for Safety Levels with Respect to Human Exposure to Radio Frequency Electromagnetic Fields, 3 kHz to 300 GHz.

It specifies the maximum exposure limit of **1.6 W/kg** as averaged over any 1 gram of tissue for portable devices being used within 20 cm of the user in the uncontrolled environment.

### 5.2 Applicable Measurement Standards

**IEEE 1528–2013:** Recommended Practice for Determining the Peak Spatial-Average Specific Absorption Rate (SAR) in the Human Head from Wireless Communications Devices: Measurement Techniques.

**KDB447498 D01: General RF Exposure Guidance v06:** Mobile and Portable Devices RF Exposure Procedures and Equipment Authorization Policies.

**KDB648474 D04 Handset SAR v01r03:** SAR Evaluation Considerations for Wireless Handsets.

**KDB941225 D01 SAR test for 3G devices v03r01:** SAR Measurement Procedures for 3G Devices

**KDB941225 D05 SAR for LTE Devices v02r05:** SAR Evaluation Considerations for LTE Devices

**KDB941225 D06 Hotspot Mode SAR v02r01:** SAR Evaluation Procedures for Portable Devices with Wireless Router Capabilities

**KDB248227 D01 802.11 Wi-Fi SAR v02r02:** SAR GUIDANCE FOR IEEE 802.11 (Wi-Fi) TRANSMITTERS

**KDB865664 D01 SAR measurement 100 MHz to 6 GHz v01r04:** SAR Measurement Requirements for 100 MHz to 6 GHz.

**KDB865664 D02 RF Exposure Reporting v01r02:** RF Exposure Compliance Reporting and Documentation Considerations

## 6 Specific Absorption Rate (SAR)

### 6.1 Introduction

SAR is related to the rate at which energy is absorbed per unit mass in an object exposed to a radio field. The SAR distribution in a biological body is complicated and is usually carried out by experimental techniques or numerical modeling. The standard recommends limits for two tiers of groups, occupational/controlled and general population/uncontrolled, based on a person's awareness and ability to exercise control over his or her exposure. In general, occupational/controlled exposure limits are higher than the limits for general population/uncontrolled.

### 6.2 SAR Definition

The SAR definition is the time derivative (rate) of the incremental energy ( $dW$ ) absorbed by (dissipated in) an incremental mass ( $dm$ ) contained in a volume element ( $dv$ ) of a given density ( $\rho$ ). The equation description is as below:

$$SAR = \frac{d}{dt} \left( \frac{dW}{dm} \right) = \frac{d}{dt} \left( \frac{dW}{\rho dv} \right)$$

SAR is expressed in units of Watts per kilogram (W/kg)

SAR measurement can be either related to the temperature elevation in tissue by

$$SAR = c \left( \frac{\delta T}{\delta t} \right)$$

Where:  $C$  is the specific heat capacity,  $\delta T$  is the temperature rise and  $\delta t$  is the exposure duration, or related to the electrical field in the tissue by

$$SAR = \frac{\sigma |E|^2}{\rho}$$

Where:  $\sigma$  is the conductivity of the tissue,  $\rho$  is the mass density of tissue and  $E$  is the RMS electrical field strength.

However for evaluating SAR of low power transmitter, electrical field measurement is typically applied.

## 7 Tissue Simulating Liquids

### 7.1 Targets for tissue simulating liquid

**Table 7.1: Targets for tissue simulating liquid**

Frequency(MHz)	Liquid Type	Conductivity( $\sigma$ )	$\pm 5\%$ Range	Permittivity( $\epsilon$ )	$\pm 5\%$ Range
750	Head	0.89	0.85~0.93	41.94	39.8~44.0
835	Head	0.90	0.86~0.95	41.5	39.4~43.6
1750	Head	1.37	1.30~1.44	40.08	38.1~42.1
1900	Head	1.40	1.33~1.47	40.0	38.0~42.0
2450	Head	1.80	1.71~1.89	39.2	37.2~41.2
2600	Head	1.96	1.86~2.06	39.01	37.1~41.0
5250	Head	4.71	4.47~4.95	35.93	34.13~ 37.73
5600	Head	5.07	4.82~5.32	35.53	33.8~37.3
5750	Head	5.22	4.96~5.48	35.36	33.59~ 37.13

### 7.2 Dielectric Performance

**Table 7.2: Dielectric Performance of Tissue Simulating Liquid**

Measurement Date (yyyy-mm-dd)	Type	Frequency	Permittivity $\epsilon$	Drift (%)	Conductivity $\sigma$ (S/m)	Drift (%)
2020-6-4	Head	750 MHz	41.7	-0.57	0.898	0.90
2020-6-5	Head	750 MHz	41.71	-0.55	0.88	-1.12
2020-6-6	Head	835 MHz	41.6	0.24	0.901	0.11
2020-6-7	Head	835 MHz	41.55	0.12	0.884	-1.78
2020-6-8	Head	1750 MHz	40.68	1.50	1.38	0.73
2020-6-9	Head	1750 MHz	39.85	-0.57	1.383	0.95
2020-6-10	Head	1900 MHz	39.55	-1.13	1.39	-0.71
2020-6-11	Head	1900 MHz	40.09	0.23	1.401	0.07
2020-6-12	Head	1900 MHz	39.37	-1.58	1.4	0.00
2020-6-13	Head	2450 MHz	39.05	-0.38	1.784	-0.89
2020-6-14	Head	2600 MHz	39.57	1.44	1.966	0.31
2020-6-15	Head	2600 MHz	39.6	1.51	1.974	0.71
2020-6-16	Head	2600 MHz	38.46	-1.41	1.956	-0.20
2020-6-17	Head	5250 MHz	35.58	-0.97	4.667	-0.91
2020-6-18	Head	5600 MHz	36.18	1.83	5.097	0.53
2020-6-19	Head	5750 MHz	35.35	-0.03	5.324	1.99

Note: The liquid temperature is 22.0°C

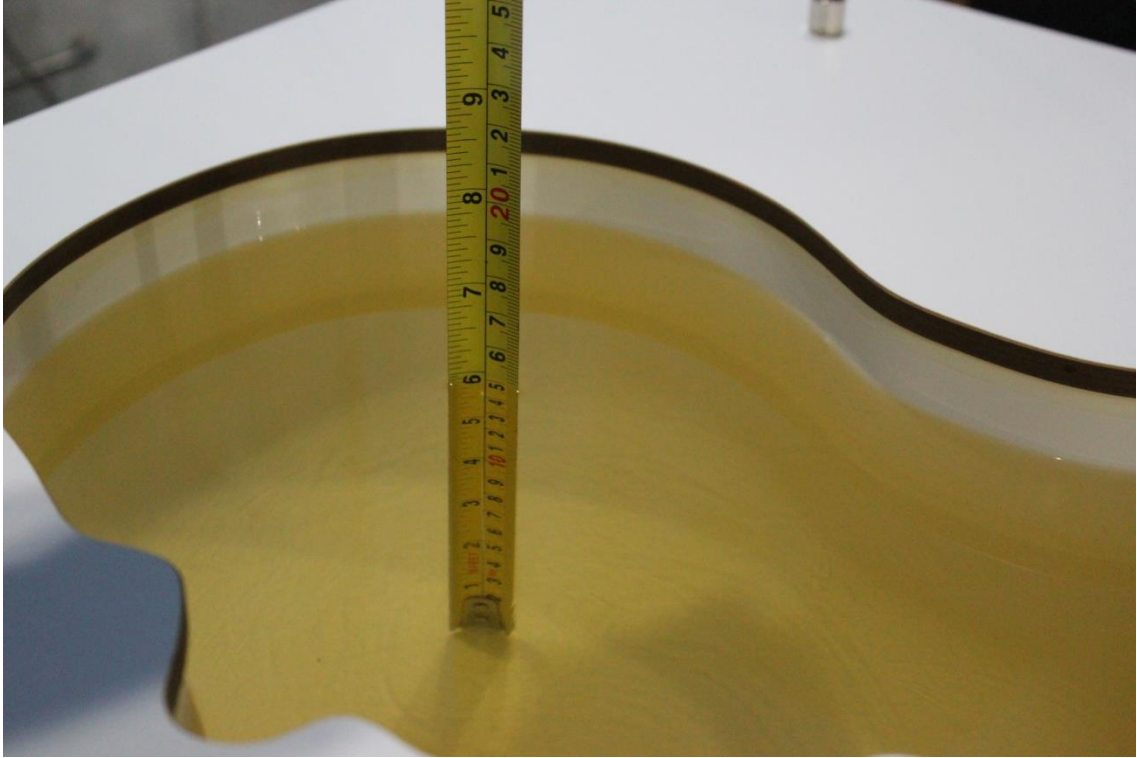

**Picture 7-1 Liquid depth in the Head Phantom (750MHz)**

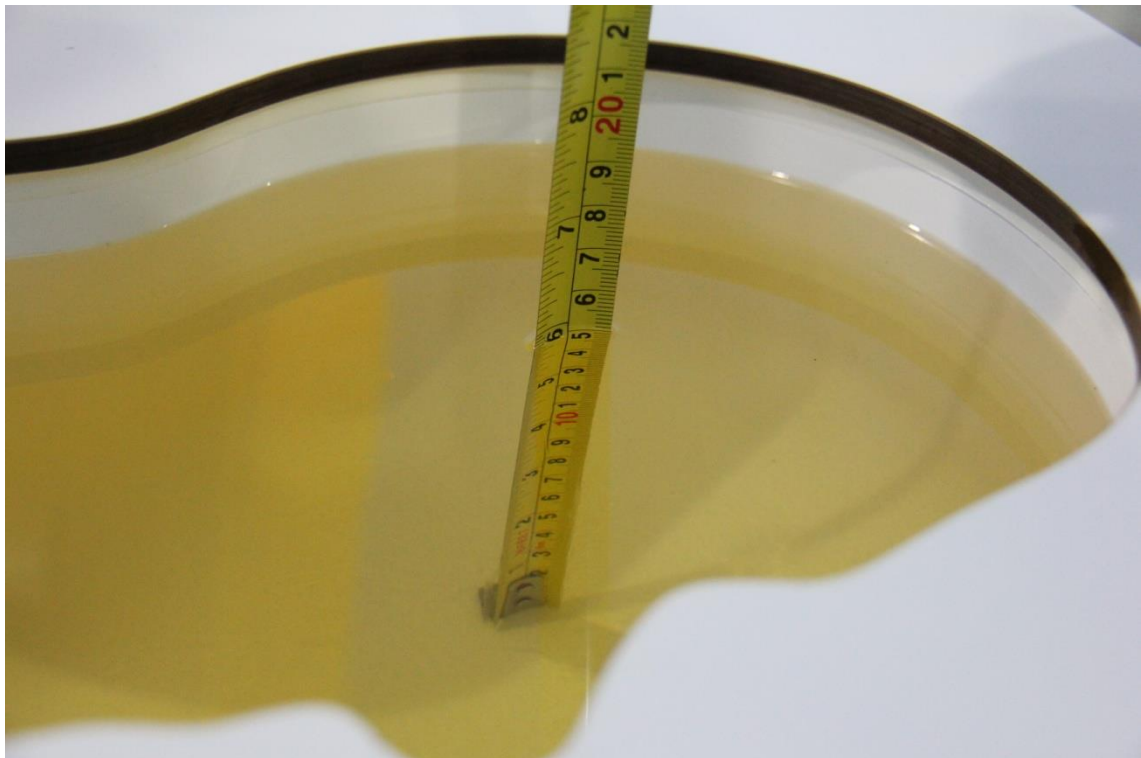

**Picture 7-2 Liquid depth in the Head Phantom (835 MHz)**

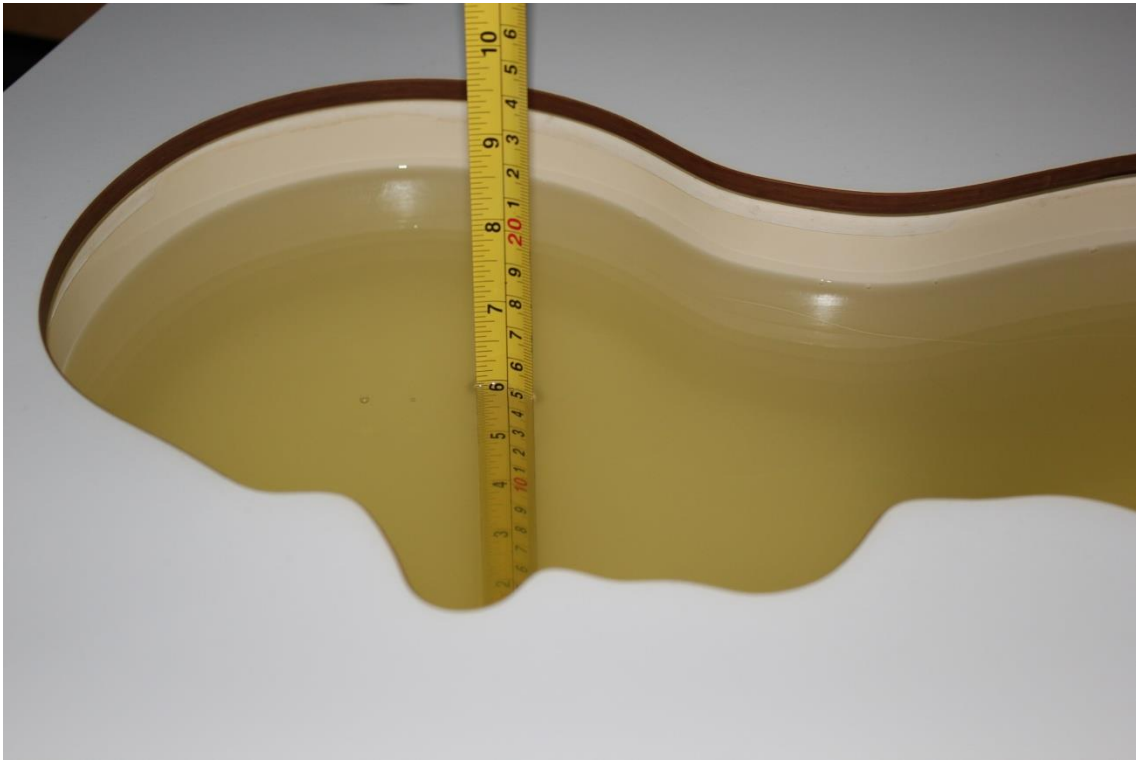

**Picture 7-3 Liquid depth in the Head Phantom (1750 MHz)**

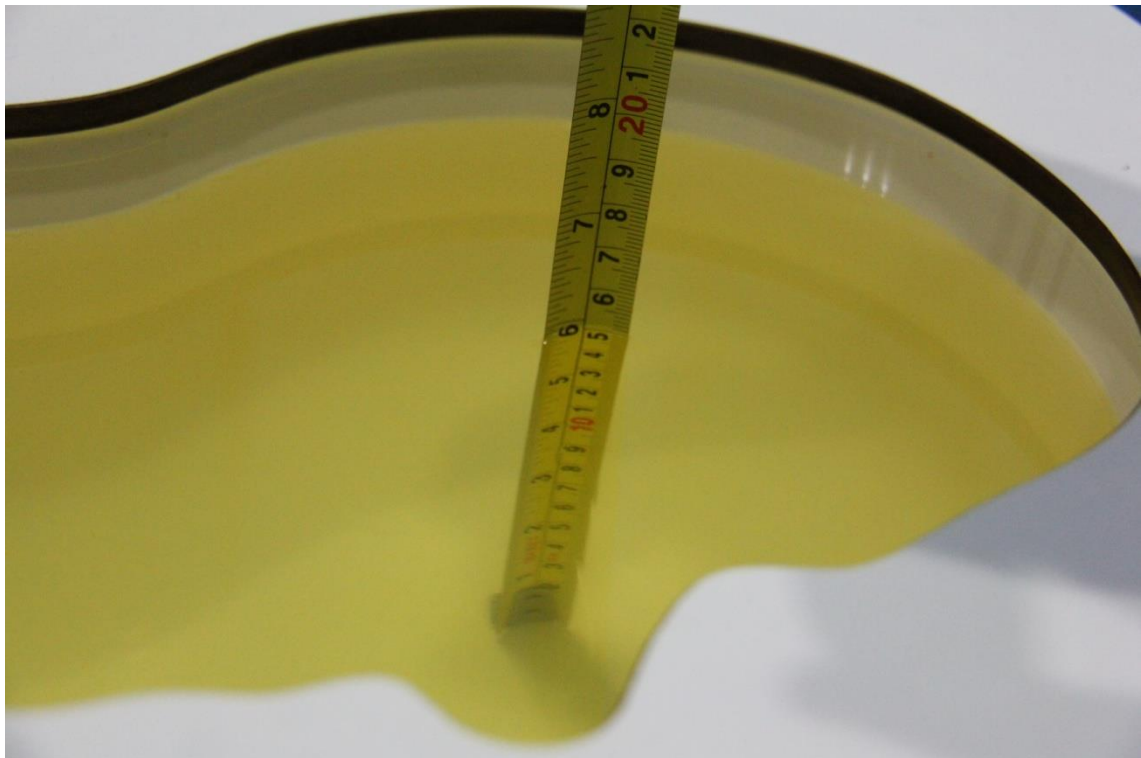

**Picture 7-4 Liquid depth in the Head Phantom (1900 MHz)**



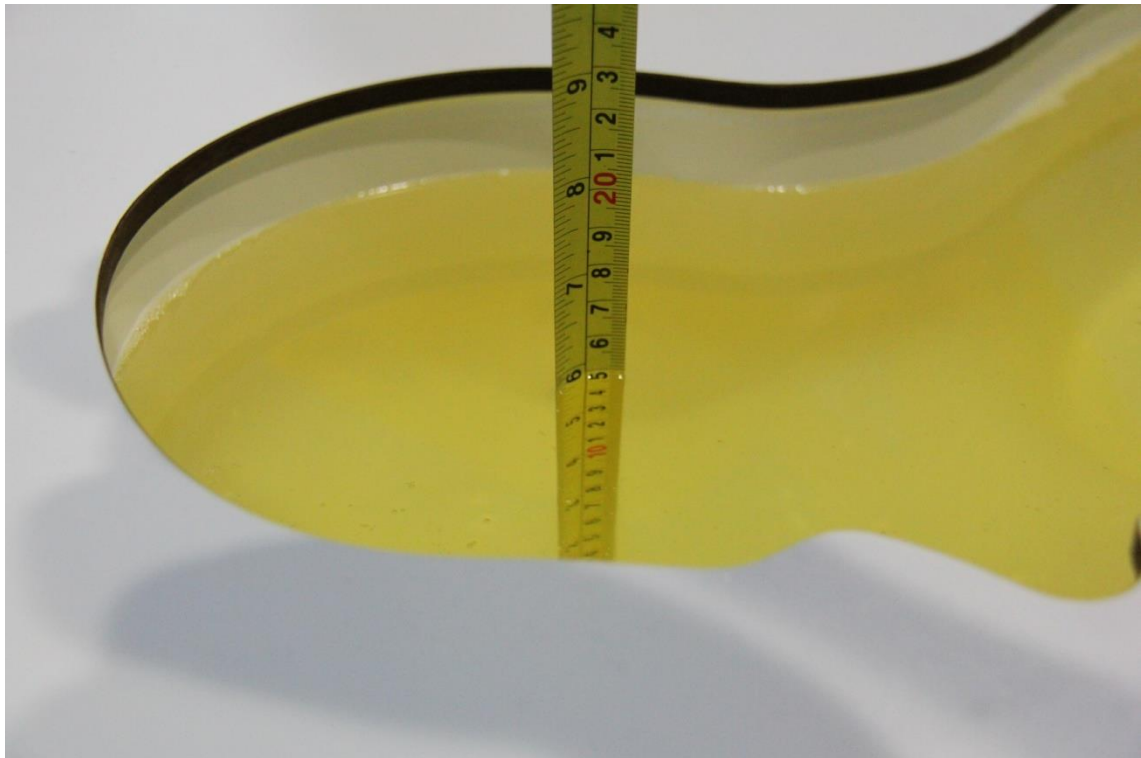

**Picture 7-5 Liquid depth in the Head Phantom (2450MHz)**



**Picture 7-6 Liquid depth in the Head Phantom (2600 MHz)**



Picture 7-7 Liquid depth in the Head Phantom (5GHz)

## 8 System verification

### 8.1 System Setup

In the simplified setup for system evaluation, the DUT is replaced by a calibrated dipole and the power source is replaced by a continuous wave that comes from a signal generator. The calibrated dipole must be placed beneath the flat phantom section of the SAM twin phantom with the correct distance holder. The distance holder should touch the phantom surface with a light pressure at the reference marking and be oriented parallel to the long side of the phantom. The equipment setup is shown below:

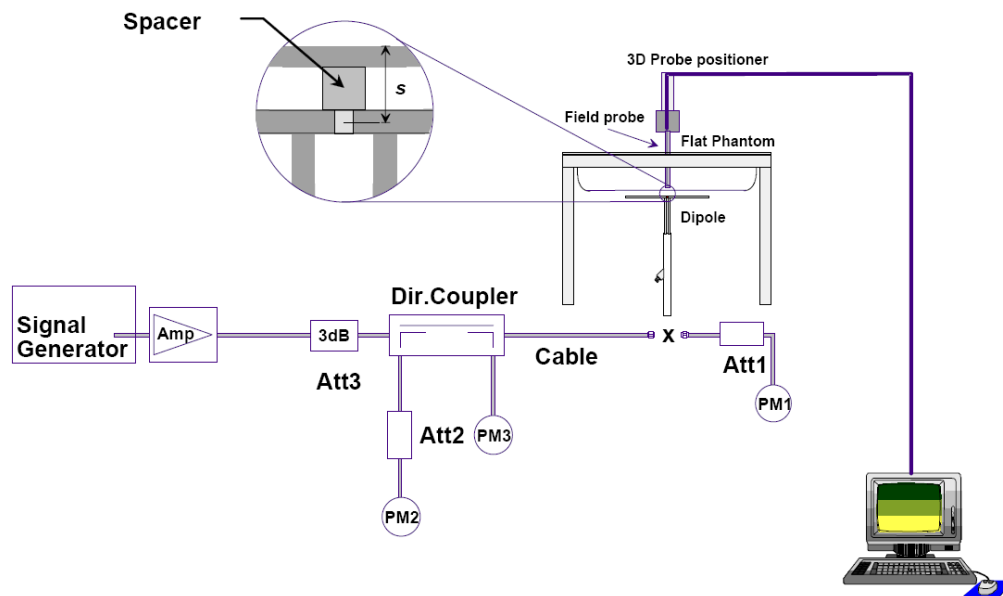

Picture 8.1 System Setup for System Evaluation



Picture 8.2 Photo of Dipole Setup

## 8.2 System Verification

SAR system verification is required to confirm measurement accuracy, according to the tissue dielectric media, probe calibration points and other system operating parameters required for measuring the SAR of a test device. The system verification must be performed for each frequency band and within the valid range of each probe calibration point required for testing the device.

The system verification results are required that the area scan estimated 1-g SAR is within 3% of the zoom scan 1-g SAR. The details are presented in annex B.

**Table 8.1: System Verification of Head**

Measurement Date (yyyy-mm-dd)	Frequency	Target value (W/kg)		Measured value(W/kg)		Deviation	
		10 g Average	1 g Average	10 g Average	1 g Average	10 g Average	1 g Average
2020-6-4	750 MHz	5.57	8.57	5.52	8.56	-0.90%	-0.12%
2020-6-5	750 MHz	5.57	8.57	5.64	8.44	1.26%	-1.52%
2020-6-6	835 MHz	6.29	9.70	6.28	9.8	-0.16%	1.03%
2020-6-7	835 MHz	6.29	9.70	6.28	9.52	-0.16%	-1.86%
2020-6-8	1750 MHz	19.3	36.6	19.4	36.04	0.52%	-1.53%
2020-6-9	1750 MHz	19.3	36.6	19.08	36.6	-1.14%	0.00%
2020-6-10	1900 MHz	20.8	39.7	20.6	40.28	-0.96%	1.46%
2020-6-11	1900 MHz	20.8	39.7	20.8	40.16	0.00%	1.16%
2020-6-12	1900 MHz	20.8	39.7	20.92	38.92	0.58%	-1.96%
2020-6-13	2450 MHz	24.2	51.6	24.64	52.56	1.82%	1.86%
2020-6-14	2600 MHz	25.1	55.8	25.24	56.68	0.56%	1.58%
2020-6-15	2600 MHz	25.1	55.8	25.24	54.92	0.56%	-1.58%
2020-6-16	2600 MHz	25.1	55.8	25.52	56	1.67%	0.36%
2020-6-17	5250 MHz	23.2	80.4	23.3	79.4	0.34%	-1.19%
2020-6-18	5600 MHz	24.1	84.5	24.1	84.7	0.08%	0.21%
2020-6-19	5750 MHz	23.0	80.4	23.4	80.4	1.57%	-0.05%

## 9 Measurement Procedures

### 9.1 Tests to be performed

In order to determine the highest value of the peak spatial-average SAR of a handset, all device positions, configurations and operational modes shall be tested for each frequency band according to steps 1 to 3 below. A flowchart of the test process is shown in picture 9.1.

**Step 1:** The tests described in 9.2 shall be performed at the channel that is closest to the centre of the transmit frequency band ( $f_c$ ) for:

- a) all device positions (cheek and tilt, for both left and right sides of the SAM phantom, as described in annex D),
- b) all configurations for each device position in a), e.g., antenna extended and retracted, and
- c) all operational modes, e.g., analogue and digital, for each device position in a) and configuration in b) in each frequency band.

If more than three frequencies need to be tested according to 11.1 (i.e.,  $N_c > 3$ ), then all frequencies, configurations and modes shall be tested for all of the above test conditions.

**Step 2:** For the condition providing highest peak spatial-average SAR determined in Step 1, perform all tests described in 9.2 at all other test frequencies, i.e., lowest and highest frequencies. In addition, for all other conditions (device position, configuration and operational mode) where the peak spatial-average SAR value determined in Step 1 is within 3 dB of the applicable SAR limit, it is recommended that all other test frequencies shall be tested as well.

**Step 3:** Examine all data to determine the highest value of the peak spatial-average SAR found in Steps 1 to 2.

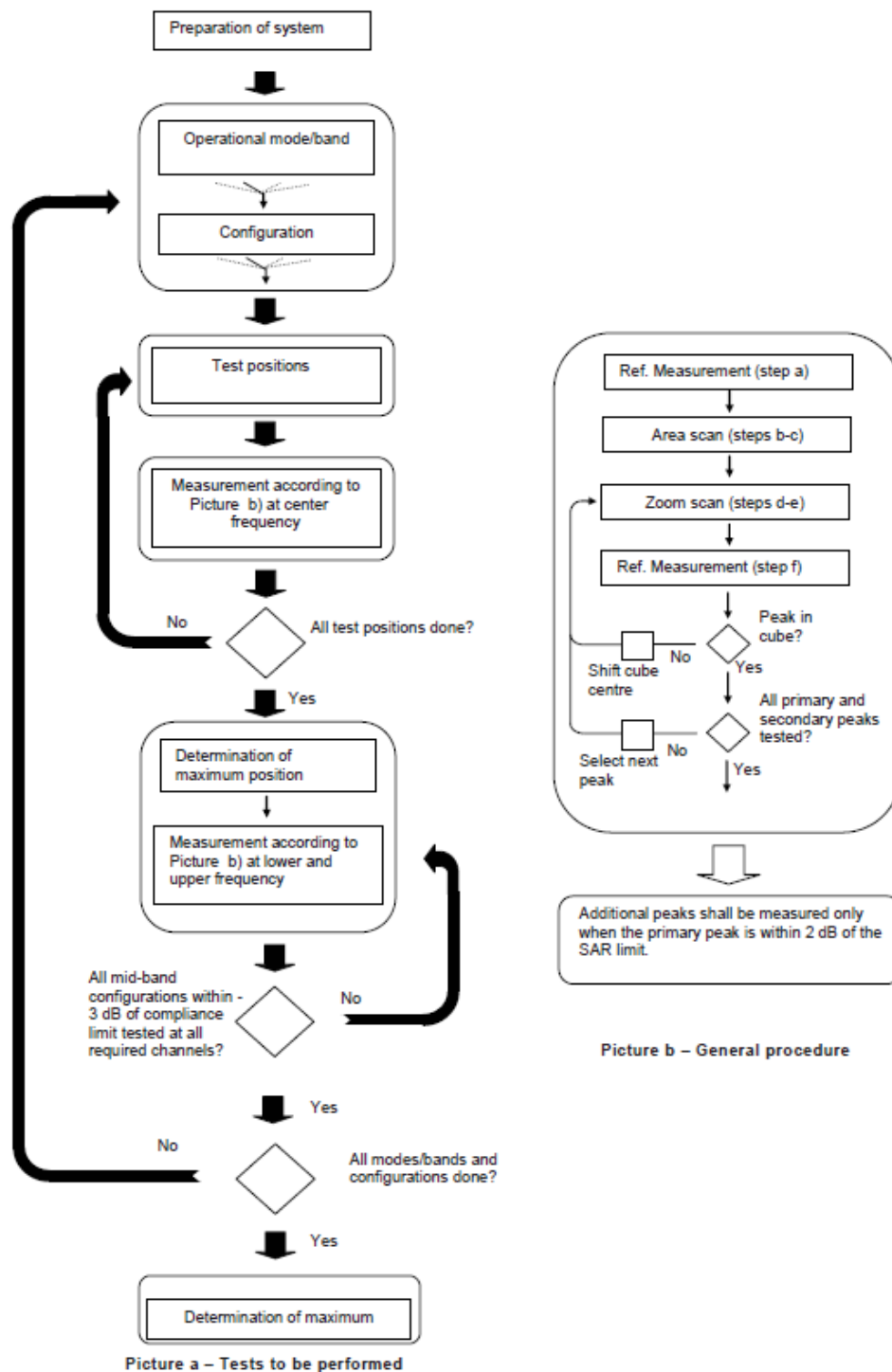

Picture 9.1 Block diagram of the tests to be performed

## 9.2 General Measurement Procedure

The area and zoom scan resolutions specified in the table below must be applied to the SAR measurements and fully documented in SAR reports to qualify for TCB approval. Probe boundary effect error compensation is required for measurements with the probe tip closer than half a probe tip diameter to the phantom surface. Both the probe tip diameter and sensor offset distance must satisfy measurement protocols; to ensure probe boundary effect errors are minimized and the

higher fields closest to the phantom surface can be correctly measured and extrapolated to the phantom surface for computing 1-g SAR. Tolerances of the post-processing algorithms must be verified by the test laboratory for the scan resolutions used in the SAR measurements, according to the reference distribution functions specified in IEEE Std 1528-2003. The results should be documented as part of the system validation records and may be requested to support test results when all the measurement parameters in the following table are not satisfied.

		$\leq 3$ GHz	$> 3$ GHz	
Maximum distance from closest measurement point (geometric center of probe sensors) to phantom surface		$5 \pm 1$ mm	$\frac{1}{2} \cdot \delta \cdot \ln(2) \pm 0.5$ mm	
Maximum probe angle from probe axis to phantom surface normal at the measurement location		$30^\circ \pm 1^\circ$	$20^\circ \pm 1^\circ$	
Maximum area scan spatial resolution: $\Delta x_{Area}$ , $\Delta y_{Area}$		$\leq 2$ GHz: $\leq 15$ mm 2 – 3 GHz: $\leq 12$ mm	3 – 4 GHz: $\leq 12$ mm 4 – 6 GHz: $\leq 10$ mm	
		When the x or y dimension of the test device, in the measurement plane orientation, is smaller than the above, the measurement resolution must be $\leq$ the corresponding x or y dimension of the test device with at least one measurement point on the test device.		
Maximum zoom scan spatial resolution: $\Delta x_{Zoom}$ , $\Delta y_{Zoom}$		$\leq 2$ GHz: $\leq 8$ mm 2 – 3 GHz: $\leq 5$ mm*	3 – 4 GHz: $\leq 5$ mm* 4 – 6 GHz: $\leq 4$ mm*	
Maximum zoom scan spatial resolution, normal to phantom surface	uniform grid: $\Delta z_{Zoom}(n)$	$\leq 5$ mm	3 – 4 GHz: $\leq 4$ mm 4 – 5 GHz: $\leq 3$ mm 5 – 6 GHz: $\leq 2$ mm	
	graded grid	$\Delta z_{Zoom}(1)$ : between 1 <sup>st</sup> two points closest to phantom surface	$\leq 4$ mm	3 – 4 GHz: $\leq 3$ mm 4 – 5 GHz: $\leq 2.5$ mm 5 – 6 GHz: $\leq 2$ mm
		$\Delta z_{Zoom}(n>1)$ : between subsequent points	$\leq 1.5 \cdot \Delta z_{Zoom}(n-1)$	
Minimum zoom scan volume	x, y, z	$\geq 30$ mm	3 – 4 GHz: $\geq 28$ mm 4 – 5 GHz: $\geq 25$ mm 5 – 6 GHz: $\geq 22$ mm	
Note: $\delta$ is the penetration depth of a plane-wave at normal incidence to the tissue medium; see draft standard IEEE P1528-2011 for details. * When zoom scan is required and the <i>reported</i> SAR from the area scan based 1-g SAR estimation procedures of KDB 447498 is $\leq 1.4$ W/kg, $\leq 8$ mm, $\leq 7$ mm and $\leq 5$ mm zoom scan resolution may be applied, respectively, for 2 GHz to 3 GHz, 3 GHz to 4 GHz and 4 GHz to 6 GHz.				

### 9.3 WCDMA Measurement Procedures for SAR

The following procedures are applicable to WCDMA handsets operating under 3GPP Release99, Release 5 and Release 6. The default test configuration is to measure SAR with an established radio link between the DUT and a communication test set using a 12.2kbps RMC (reference measurement channel) configured in Test Loop Mode 1. SAR is selectively confirmed for other physical channel configurations (DPCCH & DPDCH<sub>n</sub>), HSDPA and HSPA (HSUPA/HSDPA) modes according to output power, exposure conditions and device operating capabilities. Both uplink and downlink should be configured with the same RMC or AMR, when required. SAR for Release 5 HSDPA and Release 6 HSPA are measured using the applicable FRC (fixed reference channel) and E-DCH reference channel configurations. Maximum output power is verified according to applicable versions of 3GPP TS 34.121 and SAR must be measured according to these maximum output conditions. When Maximum Power Reduction (MPR) is not implemented according to Cubic Metric (CM) requirements for Release 6 HSPA, the following procedures do not apply.

#### For Release 5 HSDPA Data Devices:

Sub-test	$\beta_c$	$\beta_d$	$\beta_d$ (SF)	$\beta_c / \beta_d$	$\beta_{hs}$	CM/dB
1	2/15	15/15	64	2/15	4/15	0.0
2	12/15	15/15	64	12/15	24/25	1.0
3	15/15	8/15	64	15/8	30/15	1.5
4	15/15	4/15	64	15/4	30/15	1.5

#### For Release 6 HSPA Data Devices

Sub-test	$\beta_c$	$\beta_d$	$\beta_d$ (SF)	$\beta_c / \beta_d$	$\beta_{hs}$	$\beta_{ec}$	$\beta_{ed}$	$\beta_{ed}$ (SF)	$\beta_{ed}$ (codes)	CM (dB)	MPR (dB)	AG Index	E-TFCI
1	11/15	15/15	64	11/15	22/15	209/225	1039/225	4	1	1.5	1.5	20	75
2	6/15	15/15	64	6/15	12/15	12/15	12/15	4	1	1.5	1.5	12	67
3	15/15	9/15	64	15/9	30/15	30/15	$\beta_{ed1}:47/15$ $\beta_{ed2}:47/15$	4	2	1.5	1.5	15	92
4	2/15	15/15	64	2/15	4/15	4/15	56/75	4	1	1.5	1.5	17	71
5	15/15	15/15	64	15/15	24/15	30/15	134/15	4	1	1.5	1.5	21	81

#### Rel.8 DC-HSDPA (Cat 24)

SAR test exclusion for Rel.8 DC-HSDPA must satisfy the SAR test exclusion requirements of Rel.5 HSDPA. SAR test exclusion for DC-HSDPA devices is determined by power measurements according to the H-Set 12, Fixed Reference Channel (FRC) configuration in Table C.8.1.12 of 3GPP TS 34.121-1. A primary and a secondary serving HS-DSCH Cell are required to perform the power measurement and for the results to qualify for SAR test exclusion.



## 9.4 SAR Measurement for LTE

SAR tests for LTE are performed with a base station simulator, Rohde & Schwarz CMW500. Closed loop power control was used so the UE transmits with maximum output power during SAR testing. All powers were measured with the CMW 500.

It is performed for conducted power and SAR based on the KDB941225 D05.

SAR is evaluated separately according to the following procedures for the different test positions in each exposure condition – head, body, body-worn accessories and other use conditions. The procedures in the following subsections are applied separately to test each LTE frequency band.

### 1) QPSK with 1 RB allocation

Start with the largest channel bandwidth and measure SAR for QPSK with 1 RB allocation, using the RB offset and required test channel combination with the highest maximum output power among RB offsets at the upper edge, middle and lower edge of each required test channel. When the reported SAR is  $\leq 0.8$  W/kg, testing of the remaining RB offset configurations and required test channels is not required for 1 RB allocation; otherwise, SAR is required for the remaining required test channels and only for the RB offset configuration with the highest output power for that channel. When the reported SAR of a required test channel is  $> 1.45$  W/kg, SAR is required for all three RB offset configurations for that required test channel.

### 2) QPSK with 50% RB allocation

The procedures required for 1 RB allocation in 1) are applied to measure the SAR for QPSK with 50% RB allocation.

### 3) QPSK with 100% RB allocation

For QPSK with 100% RB allocation, SAR is not required when the highest maximum output power for 100 % RB allocation is less than the highest maximum output power in 50% and 1 RB allocations and the highest reported SAR for 1 RB and 50% RB allocation in 1) and 2) are  $\leq 0.8$  W/kg. Otherwise, SAR is measured for the highest output power channel; and if the reported SAR is  $> 1.45$  W/kg, the remaining required test channels must also be tested.

## TDD test:

TDD testing is performed using guidance from FCC KDB 941225 D05 v02r05 and the SAR test guidance provided in April 2013 TCB works hop notes. TDD is tested at the highest duty factor using UL-DL configuration 0 with special subframe configuration 6 and applying the FDD LTE procedures in KDB 941225 D05 v02r05. SAR testing is performed using the extended cyclic prefix listed in 3GPP TS 36.211.

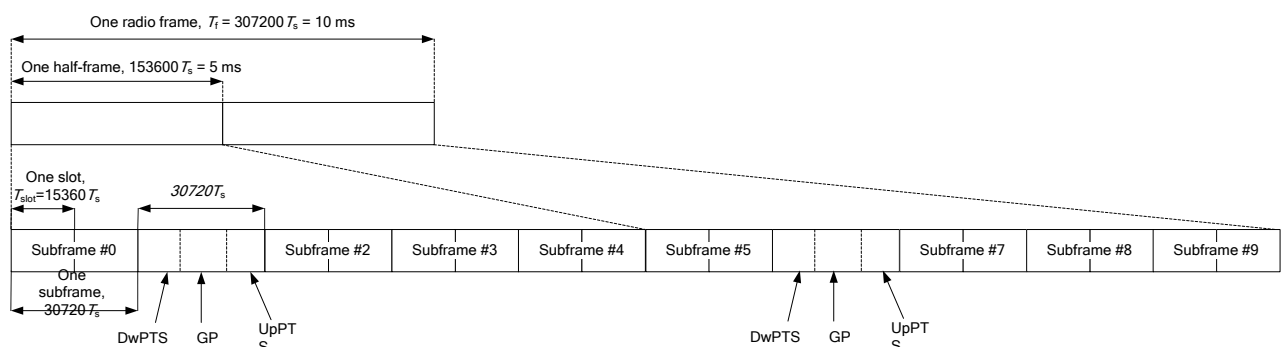

Figure 9.2: Frame structure type 2 (for 5 ms switch-point periodicity)

**Table 9.1: Configuration of special subframe (lengths of DwPTS/GP/UpPTS)**

Special subframe configuration	Normal cyclic prefix in downlink			Extended cyclic prefix in downlink		
	DwPTS	UpPTS		DwPTS	UpPTS	
		Normal cyclic prefix in uplink	Extended cyclic prefix in uplink		Normal cyclic prefix in uplink	Extended cyclic prefix in uplink
0	$6592 \cdot T_s$	$2192 \cdot T_s$	$2560 \cdot T_s$	$7680 \cdot T_s$	$2192 \cdot T_s$	$2560 \cdot T_s$
1	$19760 \cdot T_s$			$20480 \cdot T_s$		
2	$21952 \cdot T_s$			$23040 \cdot T_s$		
3	$24144 \cdot T_s$			$25600 \cdot T_s$		
4	$26336 \cdot T_s$	$4384 \cdot T_s$	$5120 \cdot T_s$	$7680 \cdot T_s$	$4384 \cdot T_s$	$5120 \cdot T_s$
5	$6592 \cdot T_s$			$20480 \cdot T_s$		
6	$19760 \cdot T_s$			$23040 \cdot T_s$		
7	$21952 \cdot T_s$			$12800 \cdot T_s$		
8	$24144 \cdot T_s$			-	-	-
9	$13168 \cdot T_s$			-	-	-

**Table 9.2: Uplink-downlink configurations**

Uplink-downlink configuration	Downlink-to-Uplink Switch-point periodicity	Subframe number									
		0	1	2	3	4	5	6	7	8	9
0	5 ms	D	S	U	U	U	D	S	U	U	U
1	5 ms	D	S	U	U	D	D	S	U	U	D
2	5 ms	D	S	U	D	D	D	S	U	D	D
3	10 ms	D	S	U	U	U	D	D	D	D	D
4	10 ms	D	S	U	U	D	D	D	D	D	D
5	10 ms	D	S	U	D	D	D	D	D	D	D
6	5 ms	D	S	U	U	U	D	S	U	U	D

Duty factor is calculated by:

$$\begin{aligned}
 \text{Duty factor} &= \text{uplink frame} \cdot 6 + \text{UpPTS} \cdot 2 / \text{one frame length} \\
 &= (30720 \cdot T_s + 6 + 5120 \cdot T_s \cdot 2) / 307200 \cdot T_s \\
 &= 0.633
 \end{aligned}$$

According to the KDB 447498 D01, SAR should be evaluated at more than 3 frequencies for devices supporting transmit bands wider than 100MHz. Oct.2014 FCC-TCB conference notes (Dec. 2014 rev.) specifies the 5 test channels to use for 3GPP band 41 SAR evaluation.

## 9.5 Bluetooth & Wi-Fi Measurement Procedures for SAR

Normal network operating configurations are not suitable for measuring the SAR of 802.11 transmitters in general. Unpredictable fluctuations in network traffic and antenna diversity conditions can introduce undesirable variations in SAR results. The SAR for these devices should be measured using chipset based test mode software to ensure that the results are consistent and reliable.

Chipset based test mode software is hardware dependent and generally varies among manufacturers. The device operating parameters established in a test mode for SAR measurements must be identical to those programmed in production units, including output power levels, amplifier gain settings and other RF performance tuning parameters. The test frequencies should correspond to actual channel frequencies defined for domestic use. SAR for devices with switched diversity should be measured with only one antenna transmitting at a time during each SAR measurement, according to a fixed modulation and data rate. The same data pattern should be used for all measurements.

## 9.6 Power Drift

To control the output power stability during the SAR test, DASY4 system calculates the power drift by measuring the E-field at the same location at the beginning and at the end of the measurement for each test position. These drift values can be found in section 14 labeled as: (Power Drift [dB]). This ensures that the power drift during one measurement is within 5%.

## 10 Area Scan Based 1-g SAR

### 10.1 Requirement of KDB

According to the KDB447498 D01 v05, when the implementation is based the specific polynomial fit

algorithm as presented at the 29th Bioelectromagnetics Society meeting (2007) and the estimated 1-gSAR is  $\leq 1.2$  W/kg, a zoom scan measurement is not required provided it is also not needed for any other purpose; for example, if the peak SAR location required for simultaneous transmission SAR test exclusion can be determined accurately by the SAR system or manually to discriminate between distinctive peaks and scattered noisy SAR distributions from area scans.

There must not be any warning or alert messages due to various measurement concerns identified by the SAR system; for example, noise in measurements, peaks too close to scan boundary, peaks are too sharp, spatial resolution and uncertainty issues etc. The SAR system verification must also demonstrate that the area scan estimated 1-g SAR is within 3% of the zoom scan 1-g SAR (See Annex B). When all the SAR results for each exposure condition in a frequency band and wireless mode are based on estimated 1-g SAR, the 1-g SAR for the highest SAR configuration must be determined by a zoom scan.

### 10.2 Fast SAR Algorithms

The approach is based on the area scan measurement applying a frequency dependent attenuation parameter. This attenuation parameter was empirically determined by analyzing a large number of phones. The MOTOROLA FAST SAR was developed and validated by the MOTOROLA Research Group in Ft. Lauderdale.

In the initial study, an approximation algorithm based on Linear fit was developed. The accuracy of the algorithm has been demonstrated across a broad frequency range (136-2450 MHz) and for both 1- and 10-g averaged SAR using a sample of 264 SAR measurements from 55 wireless handsets. For the sample size studied, the root-mean-squared errors of the algorithm are 1.2% and 5.8% for 1- and 10-g averaged SAR, respectively. The paper describing the algorithm in detail is expected to be published in August 2004 within the Special Issue of Transactions on MTT.

In the second step, the same research group optimized the fitting algorithm to an Polynomial fit whereby the frequency validity was extended to cover the range 30-6000MHz. Details of this study can be found in the BEMS 2007 Proceedings.

Both algorithms are implemented in DASY software.

## 11 Conducted Output Power

Table1: Summary of Receiver detection mechanism

Antenna	Receiver on (head scenario)	Receiver off + Hotspot on (Body/other scenario)	Receiver off (Body/other scenario)
Main antenna	Power Level A1	Power Level B1	Power Level C1

### 11.1 GSM Measurement result

During the process of testing, the EUT was controlled via Agilent Digital Radio Communication tester (E5515C) to ensure the maximum power transmission and proper modulation. This result contains conducted output power for the EUT. In all cases, the measured peak output power should be greater and within 5% than EMI measurement.

Table 11.1-1: The conducted power measurement results for GSM, GPRS and EGPRS- Level A1/B1/C1

GSM 850 Speech (GMSK)	Measured Power (dBm)			Tune up	calculation	Averaged Power (dBm)		
	251	190	128			251	190	128
1 Txslot	32.20	32.45	32.27	33.50	/	/	/	/
GSM 850 GPRS (GMSK)	Measured Power (dBm)				calculation	Averaged Power (dBm)		
	251	190	128			251	190	128
1 Txslot	32.74	32.91	32.48	33.50	-9.03	23.71	23.88	23.45
<b>2 Txslots</b>	<b>30.12</b>	<b>30.19</b>	<b>30.10</b>	<b>30.50</b>	<b>-6.02</b>	<b>24.10</b>	<b>24.17</b>	<b>24.08</b>
3Txslots	28.19	28.24	28.11	29.00	-4.26	23.93	23.98	23.85
4 Txslots	26.91	27.16	26.50	27.50	-3.01	23.90	24.15	23.49
GSM 850 EGPRS (GMSK)	Measured Power (dBm)				calculation	Averaged Power (dBm)		
	251	190	128			251	190	128
1 Txslot	32.69	32.86	32.45	33.50	-9.03	23.66	23.83	23.42
2 Txslots	<b>30.05</b>	<b>30.12</b>	<b>30.05</b>	<b>30.50</b>	<b>-6.02</b>	<b>24.03</b>	<b>24.10</b>	<b>24.03</b>
3Txslots	28.11	28.15	28.06	29.00	-4.26	23.85	23.89	23.80
4 Txslots	26.84	27.08	26.44	27.50	-3.01	23.83	24.07	23.43
GSM 850 EGPRS (8PSK)	Measured Power (dBm)				calculation	Averaged Power (dBm)		
	251	190	128			251	190	128
1 Txslot	27.23	27.21	27.34	27.50	-9.03	18.20	18.18	18.31
2 Txslots	25.99	26.06	25.91	26.50	-6.02	19.97	20.04	19.89
3Txslots	24.31	24.41	23.96	24.50	-4.26	20.05	20.15	19.70
4 Txslots	22.70	22.79	22.32	23.00	-3.01	19.69	19.78	19.31

#### NOTES:

1) Division Factors

To average the power, the division factor is as follows:

1TX-slot = 1 transmit time slot out of 8 time slots=> conducted power divided by (8/1) => -9.03dB

2TX-slots = 2 transmit time slots out of 8 time slots=> conducted power divided by (8/2) => -6.02dB

3TX-slots = 3 transmit time slots out of 8 time slots=> conducted power divided by (8/3) => -4.26dB

4TX-slots = 4 transmit time slots out of 8 time slots=> conducted power divided by (8/4) => -3.01dB

**According to the conducted power as above, the body measurements are performed with 2Txslots for GSM850**

**Table 11.1-3: The conducted power measurement results for GSM, GPRS and EGPRS Level A1/B1/C1**

PCS1900 Speech (GMSK)	Measured Power (dBm)			Tune up	calculation	Averaged Power (dBm)		
	810	661	512			810	661	512
1 Txslot	30.60	30.84	30.70	31.00	/	/	/	/
PCS1900 GPRS (GMSK)	Measured Power (dBm)				calculation	Averaged Power (dBm)		
	810	661	512			810	661	512
1 Txslot	30.64	30.84	30.70	31.00	-9.03	21.61	21.81	21.67
<b>2 Txslots</b>	<b>28.60</b>	<b>28.29</b>	<b>28.11</b>	<b>28.70</b>	<b>-6.02</b>	<b>22.58</b>	<b>22.27</b>	<b>22.09</b>
3Txslots	26.62	26.16	26.01	27.00	-4.26	22.36	21.90	21.75
4 Txslots	24.93	25.21	25.08	25.50	-3.01	21.92	22.20	22.07
PCS1900 EGPRS (GMSK)	Measured Power (dBm)				calculation	Averaged Power (dBm)		
	810	661	512			810	661	512
1 Txslot	30.61	30.82	30.69	31.00	-9.03	21.58	21.79	21.66
<b>2 Txslots</b>	<b>28.57</b>	<b>28.18</b>	<b>28.04</b>	<b>28.70</b>	<b>-6.02</b>	<b>22.55</b>	<b>22.16</b>	<b>22.02</b>
3Txslots	26.58	26.12	25.98	27.00	-4.26	22.32	21.86	21.72
4 Txslots	24.89	25.15	25.04	25.50	-3.01	21.88	22.14	22.03
PCS1900 EGPRS (8PSK)	Measured Power (dBm)				calculation	Averaged Power (dBm)		
	810	661	512			810	661	512
1 Txslot	26.20	26.28	26.13	27.00	-9.03	17.17	17.25	17.10
2 Txslots	25.72	26.03	25.67	26.20	-6.02	19.70	20.01	19.65
3Txslots	24.35	24.29	23.84	25.00	-4.26	20.09	20.03	19.58
4 Txslots	22.72	22.66	22.60	23.00	-3.01	19.71	19.65	19.59

NOTES:

1) Division Factors

To average the power, the division factor is as follows:

1TX-slot = 1 transmit time slot out of 8 time slots=> conducted power divided by (8/1) => -9.03dB

2TX-slots = 2 transmit time slots out of 8 time slots=> conducted power divided by (8/2) => -6.02dB

3TX-slots = 3 transmit time slots out of 8 time slots=> conducted power divided by (8/3) => -4.26dB

4TX-slots = 4 transmit time slots out of 8 time slots=> conducted power divided by (8/4) => -3.01dB

**According to the conducted power as above, the body measurements are performed with 2Txslots for GSM1900.**

## 11.2 WCDMA Measurement result

**Table 11.2-1: The conducted Power for WCDMA Level A1/B1/C1**

Item	band	FDDV result			
	ARFCN	4132 (826.4MHz)	4182 (836.4MHz)	4233 (846.6MHz)	Tune up
WCDMA	\	24.29	24.39	24.26	24.70
HSUPA	1	22.98	23.29	23.09	24.00
	2	21.23	21.36	21.26	22.00
	3	22.07	22.31	22.25	23.00
	4	21.21	21.26	21.09	22.00
	5	23.04	23.33	23.24	24.00
DC-HSDPA	1	22.19	22.31	22.25	23.00
	2	22.22	22.27	22.21	23.00
	3	21.58	21.78	21.76	22.00
	4	21.62	21.78	21.73	22.00

**Table 11.2-2: The conducted Power for WCDMA Level A1**

Item	band	FDDIV result			
	ARFCN	1312 (1712.4MHz)	1412 (1732.4MHz)	1513 (1752.6MHz)	
WCDMA	\	20.63	20.78	20.72	21.00
HSUPA	1	19.31	19.43	19.36	19.50
	2	17.48	17.35	17.41	18.50
	3	18.37	18.44	18.36	19.50
	4	17.38	17.43	17.32	18.50
	5	19.44	19.39	19.30	20.50
DC-HSDPA	1	18.54	18.58	18.53	19.50
	2	18.53	18.59	18.54	19.50
	3	18.01	18.10	18.05	19.00
	4	18.03	18.09	18.02	19.00
Item	band	FDDII result			
	ARFCN	9262 (1852.4MHz)	9400 (1880MHz)	9538 (1907.6MHz)	
WCDMA	\	20.63	20.78	20.72	21.00
HSUPA	1	19.31	19.43	19.36	19.50
	2	17.48	17.35	17.41	18.50
	3	18.37	18.44	18.36	19.50
	4	17.38	17.43	17.32	18.50
	5	19.44	19.39	19.30	20.50
DC-HSDPA	1	18.54	18.58	18.53	19.50
	2	18.53	18.59	18.54	19.50
	3	18.01	18.10	18.05	19.00
	4	18.03	18.09	18.02	19.00

**Table 11.2-2: The conducted Power for WCDMA Level B1**

Item	band	FDDIV result			
	ARFCN	1312 (1712.4MHz)	1412 (1732.4MHz)	1513 (1752.6MHz)	
WCDMA	\	21.85	21.74	21.78	22.00
HSUPA	1	20.37	20.40	20.36	21.50
	2	18.42	18.38	18.39	19.50
	3	19.47	19.39	19.43	20.50
	4	18.49	18.40	18.42	19.50
	5	20.47	20.34	20.41	21.50
DC-HSDPA	1	20.36	20.38	20.41	21.50
	2	20.37	20.40	20.43	21.50
	3	19.85	19.89	19.90	21.00
	4	19.85	19.90	19.92	21.00
Item	band	FDDII result			
	ARFCN	9262 (1852.4MHz)	9400 (1880MHz)	9538 (1907.6MHz)	
WCDMA	\	21.77	21.81	21.65	22.00
HSUPA	1	20.43	20.39	20.32	21.50
	2	18.47	18.44	18.38	19.50
	3	19.39	19.35	19.37	20.50
	4	18.38	18.48	18.40	19.50
	5	20.33	20.37	20.40	21.50
DC-HSDPA	1	20.36	20.43	20.32	21.50
	2	20.39	20.40	20.33	21.50
	3	19.86	19.87	19.84	21.00
	4	19.9	19.91	19.84	21.00

**Table 11.2-2: The conducted Power for WCDMA Level C1**

Item	band	FDDIV result			
	ARFCN	1312 (1712.4MHz)	1412 (1732.4MHz)	1513 (1752.6MHz)	
WCDMA	\	24.42	24.46	24.39	24.70
HSUPA	1	23.38	23.40	23.42	24.00
	2	21.28	21.36	21.38	22.00
	3	22.42	22.37	22.33	23.00
	4	21.4	21.32	21.35	22.00
	5	23.36	23.41	23.38	24.00
DC-HSDPA	1	23.35	23.38	23.42	24.00
	2	23.36	23.40	23.45	24.00
	3	22.88	22.86	22.91	23.00
	4	22.87	22.88	22.89	23.00
Item	band	FDDII result			



	ARFCN	9262 (1852.4MHz)	9400 (1880MHz)	9538 (1907.6MHz)	
WCDMA	\	24.06	24.14	24.07	24.20
HSUPA	1	22.83	22.85	22.74	23.50
	2	20.84	20.94	20.84	21.50
	3	21.86	21.87	21.78	22.50
	4	20.88	20.91	20.77	21.50
	5	22.87	22.88	22.81	23.50
DC-HSDPA	1	22.85	22.80	22.77	23.50
	2	22.72	22.87	22.80	23.00
	3	22.18	22.40	22.31	23.00
	4	22.15	22.40	22.29	23.00

### 11.3 CDMA Measurement result

Table 11.3-1: The conducted Power for CDMA- Level A1/B1/C1

Mode	CDMA BC0			
	777 (848.31MHz)	384 (836.52MHz)	1013 (824.7MHz)	Tune up
SO55/RC3	24.66	24.70	24.67	25.00
SO55/RC1	24.69	24.73	24.71	25.00
SO32/RC3(FCH only)	24.65	24.70	24.66	25.00
SO32/RC3(FCH+SCH <sub>n</sub> )	24.64	24.69	24.65	25.00
EVDO Rev.0	24.78	24.81	24.80	25.00
EVDO Rev.A	24.82	24.79	24.95	25.00
Mode	CDMA BC10			
	684 (823.1MHz)	580 (820.5MHz)	476(817.9MHz)	Tune up
SO55/RC3	24.69	24.70	24.64	25.00
SO55/RC1	24.73	24.72	24.68	25.00
SO32/RC3(FCH only)	24.70	24.70	24.65	25.00
SO32/RC3(FCH+SCH <sub>n</sub> )	24.71	24.69	24.64	25.00
EVDO Rev.0	24.86	24.85	24.87	25.00
EVDO Rev.A	24.99	24.99	24.97	25.00

Table 11.3-1: The conducted Power for CDMA- Level A1

Mode	CDMA BC1			
	1175 (1908.75MHz)	600 (1880MHz)	25 (1851.25MHz)	Tune up
SO55/RC3	21.11	21.17	21.12	21.50
SO55/RC1	21.16	21.23	21.13	21.50
SO32/RC3(FCH only)	21.13	21.17	21.10	21.50
SO32/RC3(FCH+SCH <sub>n</sub> )	21.14	21.18	21.12	21.50
EVDO Rev.0	21.14	21.13	21.22	21.50
EVDO Rev.A	21.04	21.15	21.03	21.50

**Table 11.3-1: The conducted Power for CDMA- Level B1**

Mode	CDMA BC1			
	1175 (1908.75MHz)	600 (1880MHz)	25 (1851.25MHz)	Tune up
SO55/RC3	21.13	21.16	21.10	21.50
SO55/RC1	21.17	21.21	21.14	21.50
SO32/RC3(FCH only)	21.14	21.24	21.11	21.50
SO32/RC3(FCH+SCH <sub>n</sub> )	21.11	21.17	21.10	21.50
EVDO Rev.0	21.07	21.14	21.16	21.50
EVDO Rev.A	21.09	21.15	21.19	21.50

**Table 11.3-1: The conducted Power for CDMA- Level C1**

Mode	CDMA BC1			
	1175 (1908.75MHz)	600 (1880MHz)	25 (1851.25MHz)	Tune up
SO55/RC3	24.71	24.74	24.68	25.00
SO55/RC1	24.78	24.82	24.75	25.00
SO32/RC3(FCH only)	24.72	24.75	24.70	25.00
SO32/RC3(FCH+SCH <sub>n</sub> )	24.73	24.74	24.69	25.00
EVDO Rev.0	23.93	23.89	23.83	25.00
EVDO Rev.A	24.05	24.01	23.97	25.00

## 11.4 LTE Measurement result

**Table 11.4-1: Maximum Power Reduction (MPR) for LTE-Normal Power**

Modulation	Channel bandwidth / Transmission bandwidth configuration [RB]						MPR (dB)
	1.4	3	5	10	15	20	
	MHz	MHz	MHz	MHz	MHz	MHz	
QPSK	> 5	> 4	> 8	> 12	> 16	> 18	1
16 QAM	≤ 5	≤ 4	≤ 8	≤ 12	≤ 16	≤ 18	1
16 QAM	> 5	> 4	> 8	> 12	> 16	> 18	2
64 QAM	≤ 5	≤ 4	≤ 8	≤ 12	≤ 16	≤ 18	2
64 QAM	> 5	> 4	> 8	> 12	> 16	> 18	3

**Table 11.4-2: Maximum Power Reduction (MPR) for LTE-Low Power**

Modulation	Channel bandwidth / Transmission bandwidth configuration [RB]						MPR (dB)
	1.4	3	5	10	15	20	
	MHz	MHz	MHz	MHz	MHz	MHz	
QPSK	> 5	> 4	> 8	> 12	> 16	> 18	0
16 QAM	≤ 5	≤ 4	≤ 8	≤ 12	≤ 16	≤ 18	0
16 QAM	> 5	> 4	> 8	> 12	> 16	> 18	0
64 QAM	≤ 5	≤ 4	≤ 8	≤ 12	≤ 16	≤ 18	0
64 QAM	> 5	> 4	> 8	> 12	> 16	> 18	0

**Table 11.4-3: The tune up for LTE- Power Level A1/B1/C1**

Band	Tune up
LTE Band 12	24.7
LTE Band 13	24.7
LTE Band 26	24.7
LTE Band 71	24.7

**Table 11.4-4: The tune up for LTE- Power Level A1**

Band	Tune up
LTE Band 7	21.2
LTE Band 25	20.7
LTE Band 41 PC3	21.2
LTE Band 41 PC2	21.2
LTE Band 66	20.7

**Table 11.4-5: The tune up for LTE- Power Level B1**

Band	Tune up
LTE Band 7	21.7

LTE Band 25	21.7
LTE Band 41 PC3	22
LTE Band 41 PC2	22
LTE Band 66	21.7

**Table 11.4-6: The tune up for LTE– Power Level C1**

Band	Tune up
LTE Band 7	23.5
LTE Band 25	24.7
LTE Band 41 PC3	25
LTE Band 41 PC2	27.7
LTE Band 66	25

**Table 11.4-7: The tune up for LTE in ENDC mode– Power Level A1**

Band	Tune up
LTE Band 2	19
LTE Band 12	19
LTE Band 66	19

**Table 11.4-8: The tune up for LTE in ENDC mode– Power Level B1**

Band	Tune up
LTE Band 2	19
LTE Band 12	18.5
LTE Band 66	19

**Table 11.4-9: The tune up for LTE in ENDC mode– Power Level C1**

Band	Tune up
LTE Band 2	21
LTE Band 12	21
LTE Band 66	21

**Table 11.4-10: The tune up for LTE in ENDC mode(n66 only)– Power Level A1/C1**

Band	Tune up
LTE Band 2	21

**Table 11.4-11: The tune up for LTE in ENDC mode(n66 only)– Power Level B1**

Band	Tune up
LTE Band 2	19

## Power Level A1/B1/C1

Table 11.3-1: The conducted Power for LTE

Band 12					
Bandwidth (MHz)	RB allocation	Frequency (MHz)	QPSK	16QAM	64QAM
	RB offset (Start RB)		Actual output power (dBm)	Actual output power (dBm)	Actual output power (dBm)
1.4 MHz	1RB High (5)	715.3	23.81	22.94	22.69
		707.5	23.94	23.06	21.20
		699.7	23.86	23.32	21.45
	1RB Middle (3)	715.3	23.88	22.98	21.17
		707.5	23.98	23.09	21.39
		699.7	23.91	23.39	21.49
	1RB Low (0)	715.3	23.86	22.97	21.31
		707.5	23.92	23.03	21.48
		699.7	23.89	23.37	21.37
	3RB High (3)	715.3	23.84	23.09	21.12
		707.5	23.88	22.95	21.15
		699.7	23.86	23.01	21.18
	3RB Middle (1)	715.3	23.87	23.13	21.23
		707.5	23.87	22.98	20.98
		699.7	23.93	23.12	21.09
	3RB Low (0)	715.3	23.83	23.12	21.24
		707.5	23.83	23.02	21.43
		699.7	23.87	23.14	21.09
	6RB (0)	715.3	22.93	22.07	20.11
		707.5	22.91	22.07	20.09
		699.7	22.93	21.86	20.12
3 MHz	1RB High (14)	714.5	23.92	22.85	21.11
		707.5	24.02	23.41	21.63
		700.5	23.87	22.94	21.31
	1RB Middle (7)	714.5	23.95	22.92	21.43
		707.5	24.00	23.42	21.85
		700.5	23.87	22.96	21.45
	1RB Low (0)	714.5	23.96	22.97	21.56
		707.5	24.00	23.48	21.46
		700.5	23.99	23.08	21.06
	8RB High (7)	714.5	22.97	22.08	20.30
		707.5	23.02	22.08	20.24
		700.5	22.95	21.97	20.24
	8RB Middle (4)	714.5	23.04	22.15	20.48
		707.5	23.04	22.16	20.33
		700.5	23.01	22.05	20.32
	8RB Low (0)	714.5	22.96	22.08	20.50
		707.5	22.98	22.12	20.29

	15RB (0)	700.5	23.03	22.07	20.23	
		714.5	22.97	22.01	20.30	
		707.5	22.98	22.06	20.22	
		700.5	22.98	21.98	20.07	
5 MHz	1RB High (24)	713.5	23.92	23.46	21.96	
		707.5	24.03	23.16	21.17	
		701.5	24.06	23.18	20.98	
	1RB Middle (12)	713.5	24.00	23.55	21.39	
		707.5	24.00	23.16	21.42	
		701.5	24.02	23.12	21.24	
	1RB Low (0)	713.5	23.91	23.53	21.60	
		707.5	24.03	23.19	21.30	
		701.5	24.11	23.16	21.14	
	12RB High (13)	713.5	22.98	22.13	20.30	
		707.5	23.03	22.08	20.25	
		701.5	22.97	22.03	21.20	
	12RB Middle (6)	713.5	23.03	22.20	20.49	
		707.5	23.04	22.07	20.35	
		701.5	23.02	22.07	20.35	
	12RB Low (0)	713.5	22.99	22.13	20.52	
		707.5	23.06	22.10	20.27	
		701.5	23.02	22.14	20.12	
	25RB (0)	713.5	23.08	22.12	20.36	
		707.5	23.03	21.95	20.09	
		701.5	23.05	22.05	19.95	
	10 MHz	1RB High (49)	711	24.22	23.24	20.95
			707.5	24.30	23.61	21.47
			704	24.25	23.31	21.26
1RB Middle (24)		711	24.18	23.26	21.22	
		707.5	24.31	23.63	21.40	
		704	24.29	23.34	20.97	
1RB Low (0)		711	24.15	23.22	21.31	
		707.5	24.12	23.69	21.40	
		704	24.20	23.38	21.33	
25RB High (25)		711	23.28	22.34	20.45	
		707.5	23.34	22.32	20.28	
		704	23.32	22.43	20.06	
25RB Middle (12)		711	23.37	22.44	20.58	
		707.5	23.29	22.36	20.36	
		704	23.38	22.44	20.15	
25RB Low (0)		711	23.35	22.38	20.43	
		707.5	23.32	22.37	20.14	
		704	23.29	22.39	20.12	
50RB (0)		711	23.39	22.36	20.20	
		707.5	23.32	22.33	20.15	
		704	23.36	22.38	19.96	

Band 13					
Bandwidth (MHz)	RB allocation	Frequency (MHz)	QPSK	16QAM	64QAM
	RB offset (Start RB)		Actual output power (dBm)	Actual output power (dBm)	Actual output power (dBm)
5 MHz	1RB High (24)	784.5	23.93	23.16	22.36
		782	23.93	23.21	22.21
		779.5	23.95	23.51	22.13
	1RB Middle (12)	784.5	23.92	23.10	21.96
		782	23.96	23.09	22.23
		779.5	23.87	23.43	22.20
	1RB Low (0)	784.5	23.92	23.04	21.84
		782	23.83	23.09	22.16
		779.5	23.85	23.41	21.37
	12RB High (13)	784.5	23.04	22.12	21.15
		782	23.05	22.14	21.09
		779.5	23.04	22.22	21.08
	12RB Middle (6)	784.5	23.08	22.14	21.15
		782	23.02	22.09	21.12
		779.5	23.01	22.17	21.16
	12RB Low (0)	784.5	23.08	22.18	21.18
		782	22.97	22.05	21.13
		779.5	22.95	22.10	21.03
25RB (0)	784.5	23.05	22.03	21.11	
	782	23.00	22.04	21.08	
	779.5	23.08	22.13	21.01	
10 MHz	1RB High (49)	782	24.02	23.32	22.43
	1RB Middle (24)	782	23.92	23.32	21.78
	1RB Low (0)	782	23.88	23.21	20.92
	25RB High (25)	782	23.07	22.13	21.12
	25RB Middle (12)	782	23.05	22.07	21.23
	25RB Low (0)	782	23.03	22.03	21.02
	50RB (0)	782	23.02	22.06	21.09

Band 26						
Bandwidth (MHz)	RB allocation	Frequency (MHz)	QPSK	16QAM	64QAM	
	RB offset (Start RB)		Actual output power (dBm)	Actual output power (dBm)	Actual output power (dBm)	
1.4 MHz	1RB High (5)	848.3	23.54	22.53	22.65	
		831.5	23.91	23.34	22.09	
		814.7	23.94	23.05	20.96	
	1RB Middle (3)	848.3	23.49	22.51	22.64	
		831.5	23.98	23.42	22.22	
		814.7	23.98	23.06	20.99	
	1RB Low (0)	848.3	23.34	22.38	22.59	
		831.5	23.90	23.34	22.20	
		814.7	23.91	23.01	20.98	
	3RB High (3)	848.3	23.44	22.55	22.53	
		831.5	23.95	23.14	22.05	
		814.7	23.84	23.22	21.08	
	3RB Middle (1)	848.3	23.43	22.53	22.47	
		831.5	24.01	23.25	22.11	
		814.7	23.92	23.28	21.09	
	3RB Low (0)	848.3	23.30	22.46	20.98	
		831.5	23.90	23.12	22.06	
		814.7	23.82	23.19	21.08	
	6RB (0)	848.3	22.42	21.63	21.44	
		831.5	22.96	21.91	20.91	
		814.7	22.99	22.19	19.95	
	3 MHz	1RB High (14)	847.5	23.56	22.53	21.91
			831.5	24.03	22.97	21.84
			815.5	24.02	23.01	21.75
		1RB Middle (7)	847.5	23.27	22.30	22.66
			831.5	24.05	23.00	22.02
			815.5	24.02	23.03	22.03
1RB Low (0)		847.5	23.41	22.50	21.50	
		831.5	24.01	22.99	21.98	
		815.5	23.96	22.93	22.08	
8RB High (7)		847.5	22.43	21.53	21.48	
		831.5	23.06	22.14	20.90	
		815.5	23.07	22.19	21.52	
8RB Middle (4)		847.5	22.35	21.49	21.51	
		831.5	23.07	22.22	21.04	
		815.5	23.06	22.22	21.04	
8RB Low (0)		847.5	22.35	21.49	21.52	
		831.5	23.05	22.15	21.07	
		815.5	23.04	22.15	21.07	



	15RB (0)	847.5	22.33	21.40	21.39	
		831.5	23.04	22.12	20.99	
		815.5	23.09	22.12	20.96	
5 MHz	1RB High (24)	846.5	23.60	22.62	21.89	
		831.5	24.01	23.64	21.75	
		816.5	23.90	22.97	20.94	
	1RB Middle (12)	846.5	23.43	22.48	20.73	
		831.5	23.99	23.61	21.95	
		816.5	24.05	23.13	21.06	
	1RB Low (0)	846.5	24.00	23.05	21.18	
		831.5	23.95	23.58	22.09	
		816.5	24.01	23.08	21.03	
	12RB High (13)	846.5	22.29	21.45	20.05	
		831.5	23.03	22.18	20.84	
		816.5	22.79	22.03	19.96	
	12RB Middle (6)	846.5	22.40	21.56	20.65	
		831.5	23.10	22.26	21.01	
		816.5	22.97	22.18	20.07	
	12RB Low (0)	846.5	22.61	21.77	19.70	
		831.5	23.08	22.22	21.05	
		816.5	23.02	22.17	20.04	
	25RB (0)	846.5	22.49	21.57	20.53	
		831.5	23.06	22.17	20.74	
		816.5	22.93	21.92	19.95	
	10 MHz	1RB High (49)	844	23.74	22.51	22.70
			831.5	24.07	23.47	21.45
			820	23.92	22.99	21.43
1RB Middle (24)		844	23.89	23.00	21.21	
		831.5	24.06	23.41	21.93	
		820	23.89	23.15	21.14	
1RB Low (0)		844	23.95	23.04	21.25	
		831.5	24.01	23.41	21.98	
		820	23.93	23.11	21.32	
25RB High (25)		844	22.57	21.75	21.64	
		831.5	23.03	22.06	20.71	
		820	23.02	22.12	20.25	
25RB Middle (12)		844	22.97	22.01	20.11	
		831.5	23.11	22.19	21.00	
		820	23.06	22.25	20.27	
25RB Low (0)		844	23.03	22.02	20.54	
		831.5	23.04	22.10	20.99	
		820	22.79	22.01	20.10	
50RB (0)		844	22.95	21.93	20.13	
		831.5	23.08	22.09	20.75	
		820	23.02	22.00	20.66	
15 MHz		1RB High (74)	841.5	23.59	22.53	21.62
			831.5	23.93	23.34	21.44
			822.5	23.96	23.51	21.85

	1RB Middle (37)	1907.5	23.92	23.02	21.37
		1882.5	23.94	23.38	22.05
		1857.5	23.94	23.45	21.74
	1RB Low (0)	1907.5	23.91	22.95	21.88
		1882.5	23.93	23.34	22.13
		1857.5	23.99	23.37	21.23
	36RB High (38)	1907.5	22.87	21.92	20.00
		1882.5	23.04	22.06	20.71
		1857.5	23.04	22.06	20.71
	36RB Middle (19)	1907.5	22.94	21.95	20.60
		1882.5	23.06	22.12	20.64
		1857.5	23.10	22.09	20.60
	36RB Low (0)	1907.5	23.03	22.02	20.84
		1882.5	23.04	22.04	20.98
		1857.5	22.95	22.07	20.30
	75RB (0)	1907.5	22.99	21.97	20.12
		1882.5	23.06	22.09	20.69
		1857.5	23.08	22.09	20.56

Band 71						
Bandwidth (MHz)	RB allocation	Frequency (MHz)	QPSK	16QAM	64QAM	
	RB offset (Start RB)		Actual output power (dBm)	Actual output power (dBm)	Actual output power (dBm)	
5 MHz	1RB High (24)	695.5	23.74	23.33	21.98	
		680.5	23.83	23.05	21.71	
		665.5	23.81	22.88	21.53	
	1RB Middle (12)	695.5	23.81	23.43	22.09	
		680.5	23.85	23.05	21.71	
		665.5	23.86	22.90	21.56	
	1RB Low (0)	695.5	23.90	23.50	22.16	
		680.5	23.86	23.24	21.90	
		665.5	23.69	22.65	21.31	
	12RB High (13)	695.5	22.82	22.02	20.68	
		680.5	22.85	21.90	20.56	
		665.5	22.75	21.75	20.40	
	12RB Middle (6)	695.5	22.89	22.04	20.69	
		680.5	22.85	21.91	20.57	
		665.5	22.80	21.88	20.53	
	12RB Low (0)	695.5	22.93	22.06	20.72	
		680.5	22.87	21.99	20.65	
		665.5	22.72	21.77	20.43	
	25RB (0)	695.5	22.86	21.94	20.60	
		680.5	22.85	21.81	20.47	
		665.5	22.82	21.72	20.38	
	10 MHz	1RB High (49)	693	23.76	23.16	21.82
			680.5	23.68	22.84	21.50
			668	23.86	22.84	21.50
1RB Middle (24)		693	23.86	23.23	21.89	
		680.5	23.80	22.86	21.52	
		668	23.77	22.83	21.49	
1RB Low (0)		693	23.89	23.26	21.92	
		680.5	23.68	22.85	21.51	
		668	23.94	22.81	21.47	
25RB High (25)		693	22.92	21.98	20.64	
		680.5	22.90	22.03	20.69	
		668	22.87	21.84	20.50	
25RB Middle (12)		693	22.95	22.00	20.65	
		680.5	22.84	21.95	20.61	
		668	22.85	21.79	20.45	
25RB Low (0)		693	22.86	21.98	20.64	
		680.5	22.83	21.95	20.61	
		668	22.95	21.77	20.43	
50RB		693	22.93	21.86	20.52	

	(0)	680.5	22.80	21.87	20.53
		668	22.93	21.83	20.49
15 MHz	1RB High (74)	690.5	23.86	22.86	21.52
		680.5	23.89	23.37	22.03
		670.5	23.92	23.38	22.03
	1RB Middle (37)	690.5	23.90	22.89	21.55
		680.5	23.89	23.33	21.99
		670.5	23.91	23.36	22.02
	1RB Low (0)	690.5	23.89	22.94	21.60
		680.5	23.87	23.34	21.99
		670.5	24.00	23.39	22.05
	36RB High (38)	690.5	22.96	21.89	20.55
		680.5	22.93	21.99	20.64
		670.5	22.95	21.93	20.59
	36RB Middle (19)	690.5	22.96	21.97	20.63
		680.5	22.97	22.00	20.66
		670.5	22.96	21.92	20.58
	36RB Low (0)	690.5	22.87	21.84	20.50
		680.5	22.93	21.99	20.65
		670.5	22.87	21.89	20.55
	75RB (0)	690.5	22.98	21.94	20.60
		680.5	22.89	21.90	20.55
		670.5	22.89	21.93	20.59
20 MHz	1RB High (99)	688	24.03	23.59	22.25
		683	24.27	23.59	22.24
		673	24.52	23.67	22.33
	1RB Middle (50)	688	24.26	23.56	22.22
		683	24.30	23.65	22.31
		673	24.33	23.34	22.00
	1RB Low (0)	688	24.41	23.64	22.30
		683	24.39	23.60	22.26
		673	24.67	23.33	21.98
	50RB High (50)	688	23.35	22.07	20.73
		683	23.43	22.12	20.78
		673	23.62	22.38	21.03
	50RB Middle (25)	688	23.53	22.30	20.96
		683	23.63	22.35	21.01
		673	23.67	22.50	21.16
	50RB Low (0)	688	23.57	22.32	20.98
		683	23.61	22.31	20.97
		673	23.66	22.50	21.16
	100RB (0)	688	23.51	22.27	20.92
		683	23.53	22.26	20.91
		673	23.61	22.52	21.18

## Power Level A1

Band 7						
Bandwidth (MHz)	RB allocation	Frequency (MHz)	QPSK	16QAM	64QAM	
	RB offset (Start RB)		Actual output power (dBm)	Actual output power (dBm)	Actual output power (dBm)	
5 MHz	1RB High (24)	2567.5	20.71	20.72	20.84	
		2535	20.68	20.62	20.62	
		2502.5	20.42	20.87	20.59	
	1RB Middle (12)	2567.5	20.63	20.65	20.84	
		2535	20.65	20.56	20.70	
		2502.5	20.40	20.77	20.72	
	1RB Low (0)	2567.5	20.67	20.67	20.81	
		2535	20.61	20.54	20.64	
		2502.5	20.40	20.79	20.77	
	12RB High (13)	2567.5	20.73	20.61	20.73	
		2535	20.63	20.53	20.60	
		2502.5	20.53	20.45	20.70	
	12RB Middle (6)	2567.5	20.74	20.61	20.71	
		2535	20.61	20.45	20.49	
		2502.5	20.54	20.47	20.69	
	12RB Low (0)	2567.5	20.73	20.61	20.71	
		2535	20.55	20.48	20.54	
		2502.5	20.53	20.46	20.68	
	25RB (0)	2567.5	20.75	20.49	20.67	
		2535	20.62	20.45	20.46	
		2502.5	20.53	20.41	20.65	
	10 MHz	1RB High (49)	2565	20.66	20.40	20.65
			2535	20.56	20.72	20.65
			2505	20.49	20.24	20.75
1RB Middle (24)		2565	20.61	20.30	20.88	
		2535	20.56	20.74	20.55	
		2505	20.39	20.22	20.59	
1RB Low (0)		2565	20.60	20.37	20.68	
		2535	20.50	20.69	20.55	
		2505	20.41	20.25	20.68	
25RB High (25)		2565	20.76	20.54	20.69	
		2535	20.70	20.52	20.52	
		2505	20.55	20.46	20.69	
25RB Middle (12)		2565	20.69	20.47	20.55	
		2535	20.61	20.49	20.49	
		2505	20.55	20.44	20.67	
25RB Low (0)		2565	20.66	20.50	20.39	
		2535	20.58	20.43	20.51	
		2505	20.52	20.41	20.66	

	50RB (0)	2565	20.71	20.46	20.43	
		2535	20.56	20.40	20.55	
		2505	20.48	20.36	20.62	
15 MHz	1RB High (74)	2562.5	20.66	20.51	20.85	
		2535	20.66	20.87	20.86	
		2507.5	20.50	20.76	20.75	
	1RB Middle (37)	2562.5	20.64	20.48	20.64	
		2535	20.61	20.86	20.52	
		2507.5	20.49	20.84	20.66	
	1RB Low (0)	2562.5	20.59	20.40	20.66	
		2535	20.57	20.77	20.69	
		2507.5	20.49	20.75	20.73	
	36RB High (38)	2562.5	20.75	20.53	20.57	
		2535	20.68	20.55	20.59	
		2507.5	20.57	20.38	20.60	
	36RB Middle (19)	2562.5	20.69	20.51	20.48	
		2535	20.64	20.49	20.53	
		2507.5	20.54	20.37	20.58	
	36RB Low (0)	2562.5	20.63	20.46	20.60	
		2535	20.59	20.45	20.63	
		2507.5	20.45	20.27	20.47	
	75RB (0)	2562.5	20.64	20.46	20.38	
		2535	20.57	20.43	20.48	
		2507.5	20.54	20.36	20.62	
	20 MHz	1RB High (99)	2560	20.66	21.01	20.76
			2535	20.67	20.90	20.31
			2510	20.47	20.75	20.76
		1RB Middle (50)	2560	20.62	21.00	20.69
			2535	20.61	20.97	20.64
			2510	20.41	20.71	20.64
1RB Low (0)		2560	20.63	21.11	20.68	
		2535	20.52	21.01	20.71	
		2510	20.38	20.66	20.70	
50RB High (50)		2560	20.74	20.58	20.42	
		2535	20.69	20.53	20.65	
		2510	20.59	20.37	20.65	
50RB Middle (25)		2560	20.66	20.52	20.47	
		2535	20.62	20.37	20.61	
		2510	20.59	20.38	20.64	
50RB Low (0)		2560	20.64	20.50	20.57	
		2535	20.59	20.43	20.60	
		2510	20.49	20.27	20.57	
100RB (0)		2560	20.64	20.54	20.55	
		2535	20.58	20.42	20.43	
		2510	20.59	20.41	20.66	

Band 25					
Bandwidth (MHz)	RB allocation	Frequency (MHz)	QPSK	16QAM	64QAM
	RB offset (Start RB)		Actual output power (dBm)	Actual output power (dBm)	Actual output power (dBm)
1.4 MHz	1RB High (5)	1914.3	20.45	20.30	20.46
		1882.5	20.45	20.57	20.70
		1850.7	20.34	20.20	20.62
	1RB Middle (3)	1914.3	20.47	20.31	20.41
		1882.5	20.47	20.62	20.56
		1850.7	20.38	20.19	20.61
	1RB Low (0)	1914.3	20.39	20.22	20.48
		1882.5	20.38	20.50	20.44
		1850.7	20.29	20.13	20.66
	3RB High (3)	1914.3	20.41	20.24	20.42
		1882.5	20.40	20.36	20.40
		1850.7	20.32	20.36	20.39
	3RB Middle (1)	1914.3	20.40	20.26	20.46
		1882.5	20.45	20.38	20.41
		1850.7	20.33	20.36	20.40
	3RB Low (0)	1914.3	20.33	20.19	20.40
		1882.5	20.35	20.35	20.35
		1850.7	20.24	20.28	20.42
	6RB (0)	1914.3	20.42	20.32	19.85
		1882.5	20.45	20.09	20.33
		1850.7	20.43	20.32	20.21
3 MHz	1RB High (14)	1913.5	20.56	20.28	20.53
		1882.5	20.58	20.70	20.66
		1851.5	20.46	20.32	20.66
	1RB Middle (7)	1913.5	20.46	20.25	20.56
		1882.5	20.55	20.66	20.60
		1851.5	20.37	20.20	20.54
	1RB Low (0)	1913.5	20.41	20.22	20.43
		1882.5	20.40	20.51	20.44
		1851.5	20.35	20.21	20.70
	8RB High (7)	1913.5	20.59	20.39	19.98
		1882.5	20.60	20.40	20.41
		1851.5	20.52	20.28	19.88
	8RB Middle (4)	1913.5	20.61	20.40	20.10
		1882.5	20.57	20.39	20.46
		1851.5	20.57	20.32	20.39
	8RB Low (0)	1913.5	20.51	20.32	20.23
		1882.5	20.47	20.24	20.39
		1851.5	20.45	20.20	20.47

	15RB (0)	1913.5	20.58	20.34	20.11	
		1882.5	20.49	20.27	20.53	
		1851.5	20.53	20.18	20.43	
5 MHz	1RB High (24)	1912.5	20.63	20.50	20.66	
		1882.5	20.47	20.68	20.60	
		1852.5	20.52	20.48	20.69	
	1RB Middle (12)	1912.5	20.58	20.48	20.59	
		1882.5	20.46	20.64	20.51	
		1852.5	20.52	20.45	20.58	
	1RB Low (0)	1912.5	20.62	20.48	20.59	
		1882.5	20.32	20.68	20.56	
		1852.5	20.50	20.53	20.63	
	12RB High (13)	1912.5	20.61	20.34	20.13	
		1882.5	20.60	20.45	20.55	
		1852.5	20.53	20.31	20.51	
	12RB Middle (6)	1912.5	20.57	20.37	20.41	
		1882.5	20.52	20.36	20.39	
		1852.5	20.49	20.32	20.45	
	12RB Low (0)	1912.5	20.50	20.27	20.46	
		1882.5	20.44	20.30	20.42	
		1852.5	20.45	20.23	20.40	
	25RB (0)	1912.5	20.55	20.31	20.32	
		1882.5	20.48	20.30	20.33	
		1852.5	20.47	20.18	20.43	
	10 MHz	1RB High (49)	1910	20.46	20.15	20.68
			1882.5	20.54	20.61	20.45
			1855	20.27	20.06	20.51
1RB Middle (24)		1910	20.48	20.19	20.51	
		1882.5	20.47	20.52	20.32	
		1855	20.31	20.18	20.47	
1RB Low (0)		1910	20.49	20.58	20.42	
		1882.5	20.68	20.65	20.49	
		1855	20.25	20.38	20.41	
25RB High (25)		1910	20.56	20.29	20.43	
		1882.5	20.60	20.33	20.49	
		1855	20.53	20.34	20.43	
25RB Middle (12)		1910	20.56	20.25	20.51	
		1882.5	20.50	20.28	20.31	
		1855	20.55	20.34	20.40	
25RB Low (0)		1910	20.54	20.26	20.39	
		1882.5	20.47	20.29	20.35	
		1855	20.51	20.30	20.37	
50RB (0)		1910	20.59	20.18	20.34	
		1882.5	20.50	20.19	20.40	
		1855	20.51	20.31	20.34	
15 MHz		1RB High (74)	1907.5	20.37	20.24	20.52
			1882.5	20.52	20.57	20.50
			1857.5	20.44	20.68	20.67



	1RB Middle (37)	1907.5	20.50	20.35	20.46	
		1882.5	20.49	20.67	20.65	
		1857.5	20.47	20.61	20.37	
	1RB Low (0)	1907.5	20.52	20.33	20.42	
		1882.5	20.45	20.63	20.46	
		1857.5	20.61	20.63	20.20	
	36RB High (38)	1907.5	20.57	20.27	20.43	
		1882.5	20.53	20.30	20.47	
		1857.5	20.53	20.17	20.45	
	36RB Middle (19)	1907.5	20.55	20.24	20.40	
		1882.5	20.51	20.25	20.46	
		1857.5	20.55	20.22	20.52	
	36RB Low (0)	1907.5	20.54	20.23	20.49	
		1882.5	20.52	20.25	20.43	
		1857.5	20.45	20.17	20.38	
	75RB (0)	1907.5	20.50	20.20	20.33	
		1882.5	20.46	20.22	20.41	
		1857.5	20.48	20.23	20.41	
	20 MHz	1RB High (99)	1905	20.36	20.64	20.54
			1882.5	20.45	20.56	20.50
			1860	20.32	20.62	20.37
		1RB Middle (50)	1905	20.42	20.56	20.49
			1882.5	20.46	20.59	20.65
			1860	20.28	20.67	20.51
		1RB Low (0)	1905	20.40	20.62	20.45
			1882.5	20.41	20.54	20.61
			1860	20.30	20.67	20.30
50RB High (50)		1905	20.55	20.29	20.40	
		1882.5	20.56	20.25	20.41	
		1860	20.51	20.21	20.47	
50RB Middle (25)		1905	20.61	20.34	20.50	
		1882.5	20.54	20.19	20.41	
		1860	20.52	20.28	20.43	
50RB Low (0)		1905	20.51	20.24	20.34	
		1882.5	20.50	20.18	20.37	
		1860	20.47	20.21	20.43	
100RB (0)		1905	20.55	20.16	20.09	
		1882.5	20.52	20.19	20.45	
		1860	20.58	20.28	20.47	

Band 41 – PC2					
Bandwidth (MHz)	RB allocation	Frequency (MHz)	QPSK	16QAM	64QAM
	RB offset (Start RB)		Actual output power (dBm)	Actual output power (dBm)	Actual output power (dBm)
5 MHz	1RB High (24)	2687.5	20.39	20.75	20.86
		2640.3	20.44	20.94	21.05
		2593	20.44	20.80	20.91
		2545.8	20.43	20.79	20.90
		2498.5	20.37	20.90	21.01
	1RB Middle (12)	2687.5	20.38	20.81	20.92
		2640.3	20.41	20.95	21.06
		2593	20.42	20.82	20.93
		2545.8	20.36	20.70	20.81
		2498.5	20.31	20.87	20.98
	1RB Low (0)	2687.5	20.35	20.75	20.86
		2640.3	20.43	20.93	21.04
		2593	20.40	20.72	20.83
		2545.8	20.36	20.71	20.82
		2498.5	20.33	20.87	20.98
	12RB High (13)	2687.5	20.49	20.49	20.60
		2640.3	20.51	20.65	20.76
		2593	20.62	20.66	20.77
		2545.8	20.52	20.59	20.70
		2498.5	20.48	20.54	20.65
	12RB Middle (6)	2687.5	20.50	20.53	20.64
		2640.3	20.53	20.63	20.74
		2593	20.63	20.68	20.79
		2545.8	20.52	20.60	20.71
		2498.5	20.50	20.58	20.69
	12RB Low (0)	2687.5	20.43	20.45	20.56
		2640.3	20.51	20.65	20.76
		2593	20.53	20.60	20.71
		2545.8	20.50	20.58	20.69
		2498.5	20.44	20.59	20.70
25RB (0)	2687.5	20.45	20.52	20.63	
	2640.3	20.52	20.53	20.64	

		2593	20.52	20.55	20.66
		2545.8	20.50	20.61	20.72
		2498.5	20.44	20.45	20.56
10 MHz	1RB High (49)	2685	20.28	20.92	21.03
		2639	20.36	20.97	21.08
		2593	20.41	20.83	20.94
		2547	20.46	20.89	21.00
		2501	20.29	20.90	21.01
	1RB Middle (24)	2685	20.42	20.84	20.95
		2639	20.24	21.06	21.07
		2593	20.53	20.84	20.95
		2547	20.33	20.96	21.07
		2501	20.25	20.61	20.72
	1RB Low (0)	2685	20.38	21.00	21.11
		2639	20.39	21.07	21.10
		2593	20.49	20.78	20.89
		2547	20.40	20.85	20.96
		2501	20.23	20.63	20.74
	25RB High (25)	2685	20.45	20.49	20.60
		2639	20.44	20.56	20.67
		2593	20.62	20.64	20.75
		2547	20.52	20.59	20.70
		2501	20.47	20.50	20.61
	25RB Middle (12)	2685	20.49	20.54	20.65
		2639	20.52	20.59	20.70
		2593	20.50	20.57	20.68
		2547	20.56	20.62	20.73
		2501	20.48	20.54	20.65
	25RB Low (0)	2685	20.47	20.50	20.61
		2639	20.57	20.62	20.73
		2593	20.51	20.58	20.69
		2547	20.48	20.50	20.61
		2501	20.48	20.51	20.62
50RB (0)	2685	20.48	20.54	20.65	
	2639	20.46	20.53	20.64	
	2593	20.50	20.54	20.65	
	2547	20.52	20.62	20.73	
	2501	20.46	20.49	20.60	
15 MHz	1RB High (74)	2682.5	20.41	20.96	21.07
		2637.8	20.40	20.86	20.97
		2593	20.53	20.81	20.92

		2548.3	20.44	20.84	20.95
		2503.5	20.23	20.69	20.80
	1RB Middle (37)	2682.5	20.34	20.81	20.92
		2637.8	20.33	20.84	20.95
		2593	20.45	20.69	20.80
		2548.3	20.40	20.80	20.91
		2503.5	20.23	20.66	20.77
		1RB Low (0)	2682.5	20.37	20.83
	2637.8		20.37	20.83	20.94
	2593		20.44	20.71	20.82
	2548.3		20.40	20.82	20.93
	2503.5		20.27	20.55	20.66
	36RB High (38)	2682.5	20.43	20.44	20.55
		2637.8	20.47	20.53	20.64
		2593	20.57	20.55	20.66
		2548.3	20.52	20.52	20.63
		2503.5	20.42	20.49	20.60
	36RB Middle (19)	2682.5	20.48	20.51	20.62
		2637.8	20.45	20.52	20.63
		2593	20.48	20.49	20.60
		2548.3	20.51	20.52	20.63
		2503.5	20.43	20.50	20.61
	36RB Low (0)	2682.5	20.49	20.51	20.62
		2637.8	20.55	20.58	20.69
		2593	20.50	20.47	20.58
		2548.3	20.43	20.41	20.52
		2503.5	20.33	20.40	20.51
	75RB (0)	2682.5	20.47	20.52	20.63
2637.8		20.42	20.46	20.57	
2593		20.45	20.49	20.60	
2548.3		20.53	20.53	20.64	
2503.5		20.42	20.41	20.52	
20 MHz	1RB High (99)	2680	20.46	20.60	20.71
		2636.5	20.40	20.70	20.81
		2593	20.50	20.97	21.08
		2549.5	20.35	20.82	20.93
		2506	20.26	20.53	20.64
	1RB Middle (50)	2680	20.34	20.61	20.72
		2636.5	20.36	20.62	20.73
		2593	20.41	20.84	20.95
		2549.5	20.34	20.72	20.83
		2506	20.28	20.61	20.72

	1RB Low (0)	2680	20.47	20.66	20.77
		2636.5	20.50	20.64	20.75
		2593	20.44	20.92	21.03
		2549.5	20.39	20.64	20.75
		2506	20.28	20.67	20.78
	50RB High (50)	2680	20.41	20.42	20.53
		2636.5	20.44	20.47	20.58
		2593	20.56	20.61	20.72
		2549.5	20.48	20.48	20.59
		2506	20.45	20.48	20.59
	50RB Middle (25)	2680	20.48	20.49	20.60
		2636.5	20.48	20.49	20.60
		2593	20.51	20.55	20.66
		2549.5	20.50	20.52	20.63
		2506	20.45	20.49	20.60
	50RB Low (0)	2680	20.45	20.48	20.59
		2636.5	20.54	20.60	20.71
		2593	20.49	20.53	20.64
		2549.5	20.39	20.38	20.49
		2506	20.36	20.39	20.50
100RB (0)	2680	20.50	20.50	20.61	
	2636.5	20.52	20.44	20.55	
	2593	20.54	20.46	20.57	
	2549.5	20.51	20.49	20.60	
	2506	20.45	20.49	20.60	

Band 41 – PC3					
Bandwidth (MHz)	RB allocation	Frequency (MHz)	QPSK	16QAM	64QAM
	RB offset (Start RB)		Actual output power (dBm)	Actual output power (dBm)	Actual output power (dBm)
5 MHz	1RB High (24)	2687.5	20.48	20.67	20.80
		2640.3	20.52	20.48	20.61
		2593	20.54	20.55	20.68
		2545.8	20.52	20.67	20.80
		2498.5	20.45	20.44	20.57
	1RB Middle (12)	2687.5	20.33	20.63	20.76
		2640.3	20.47	20.49	20.62
		2593	20.56	20.53	20.66
		2545.8	20.42	20.64	20.77
		2498.5	20.40	20.45	20.58
	1RB Low (0)	2687.5	20.43	20.61	20.74
		2640.3	20.53	20.48	20.61
		2593	20.44	20.48	20.61
		2545.8	20.45	20.66	20.79
		2498.5	20.44	20.41	20.54
	12RB High (13)	2687.5	20.51	20.55	20.68
		2640.3	20.57	20.55	20.68
		2593	20.55	20.57	20.70
		2545.8	20.56	20.63	20.76
		2498.5	20.48	20.52	20.65
	12RB Middle (6)	2687.5	20.52	20.55	20.68
		2640.3	20.56	20.57	20.70
		2593	20.60	20.59	20.72
		2545.8	20.58	20.64	20.77
		2498.5	20.54	20.56	20.69
	12RB Low (0)	2687.5	20.48	20.51	20.64
		2640.3	20.56	20.55	20.68
		2593	20.51	20.49	20.62
		2545.8	20.55	20.64	20.77
		2498.5	20.49	20.52	20.65
25RB	2687.5	20.47	20.48	20.61	

	(0)	2640.3	20.55	20.52	20.65
		2593	20.53	20.56	20.69
		2545.8	20.55	20.58	20.71
		2498.5	20.51	20.48	20.61
10 MHz	1RB High (49)	2685	20.32	20.55	20.68
		2639	20.47	20.47	20.60
		2593	20.45	20.64	20.77
		2547	20.47	20.57	20.70
		2501	20.40	20.43	20.56
	1RB Middle (24)	2685	20.42	20.44	20.57
		2639	20.47	20.49	20.62
		2593	20.40	20.65	20.78
		2547	20.44	20.41	20.54
		2501	20.38	20.38	20.51
	1RB Low (0)	2685	20.33	20.37	20.50
		2639	20.46	20.43	20.56
		2593	20.36	20.64	20.77
		2547	20.28	20.48	20.61
		2501	20.36	20.54	20.67
	25RB High (25)	2685	20.55	20.55	20.68
		2639	20.51	20.50	20.63
		2593	20.61	20.64	20.77
		2547	20.55	20.61	20.74
		2501	20.50	20.46	20.59
	25RB Middle (12)	2685	20.63	20.53	20.66
		2639	20.53	20.47	20.60
		2593	20.54	20.57	20.70
		2547	20.60	20.60	20.73
		2501	20.50	20.48	20.61
	25RB Low (0)	2685	20.46	20.51	20.64
		2639	20.56	20.57	20.70
		2593	20.49	20.47	20.60
2547		20.51	20.54	20.67	
2501		20.48	20.50	20.63	
50RB (0)	2685	20.62	20.52	20.65	
	2639	20.49	20.51	20.64	
	2593	20.52	20.54	20.67	
	2547	20.56	20.56	20.69	
	2501	20.49	20.52	20.65	
15 MHz	1RB High (74)	2682.5	20.37	20.64	20.77
		2637.8	20.63	20.53	20.66

		2593	20.58	20.40	20.53
		2548.3	20.32	20.43	20.56
		2503.5	20.30	20.32	20.45
	1RB Middle (37)	2682.5	20.28	20.54	20.67
		2637.8	20.45	20.53	20.66
		2593	20.42	20.25	20.38
		2548.3	20.28	20.48	20.61
		2503.5	20.29	20.27	20.40
		1RB Low (0)	2682.5	20.31	20.63
	2637.8		20.35	20.56	20.69
	2593		20.31	20.41	20.54
	2548.3		20.26	20.56	20.69
	2503.5		20.30	20.07	20.20
	36RB High (38)	2682.5	20.41	20.47	20.60
		2637.8	20.49	20.47	20.60
		2593	20.59	20.41	20.54
		2548.3	20.51	20.56	20.69
		2503.5	20.44	20.42	20.55
	36RB Middle (19)	2682.5	20.49	20.52	20.65
		2637.8	20.48	20.48	20.61
		2593	20.50	20.43	20.56
		2548.3	20.49	20.56	20.69
		2503.5	20.40	20.45	20.58
	36RB Low (0)	2682.5	20.50	20.52	20.65
		2637.8	20.53	20.56	20.69
		2593	20.48	20.34	20.47
		2548.3	20.44	20.46	20.59
		2503.5	20.31	20.37	20.50
	75RB (0)	2682.5	20.48	20.50	20.63
		2637.8	20.49	20.46	20.59
2593		20.48	20.46	20.59	
2548.3		20.48	20.50	20.63	
2503.5		20.36	20.46	20.59	
20 MHz	1RB High (99)	2680	20.43	20.42	20.55
		2636.5	20.48	20.63	20.76
		2593	20.59	20.41	20.54
		2549.5	20.41	20.28	20.41
		2506	20.33	20.46	20.59
	1RB Middle (50)	2680	20.33	20.27	20.40
		2636.5	20.37	20.50	20.63
		2593	20.45	20.42	20.55
		2549.5	20.35	20.33	20.46



	1RB Low (0)	2506	20.29	20.46	20.59
		2680	20.45	20.32	20.45
		2636.5	20.54	20.69	20.82
		2593	20.45	20.48	20.61
		2549.5	20.37	20.29	20.42
		2506	20.30	20.56	20.69
	50RB High (50)	2680	20.42	20.45	20.58
		2636.5	20.45	20.51	20.64
		2593	20.56	20.57	20.70
		2549.5	20.53	20.51	20.64
		2506	20.44	20.51	20.64
	50RB Middle (25)	2680	20.49	20.51	20.64
		2636.5	20.50	20.51	20.64
		2593	20.47	20.47	20.60
		2549.5	20.52	20.53	20.66
		2506	20.48	20.51	20.64
	50RB Low (0)	2680	20.48	20.50	20.63
		2636.5	20.54	20.60	20.73
		2593	20.49	20.49	20.62
		2549.5	20.42	20.46	20.59
		2506	20.39	20.44	20.57
	100RB (0)	2680	20.51	20.52	20.65
		2636.5	20.47	20.47	20.60
		2593	20.49	20.51	20.64
		2549.5	20.52	20.53	20.66
2506		20.47	20.47	20.60	

Band 66					
Bandwidth (MHz)	RB allocation	Frequency (MHz)	QPSK	16QAM	64QAM
	RB offset (Start RB)		Actual output power (dBm)	Actual output power (dBm)	Actual output power (dBm)
1.4 MHz	1RB High (5)	1779.3	20.35	20.55	20.47
		1745	20.34	20.22	20.27
		1710.7	20.43	20.33	20.28
	1RB Middle (3)	1779.3	20.40	20.59	20.45
		1745	20.40	20.29	20.35
		1710.7	20.44	20.40	20.45
	1RB Low (0)	1779.3	20.36	20.56	20.27
		1745	20.35	20.18	20.45
		1710.7	20.34	20.34	20.17
	3RB High (3)	1779.3	20.32	20.30	20.31
		1745	20.35	20.36	20.25
		1710.7	20.36	20.30	20.34
	3RB Middle (1)	1779.3	20.34	20.43	20.23
		1745	20.36	20.40	20.30
		1710.7	20.40	20.32	20.40
	3RB Low (0)	1779.3	20.31	20.33	20.30
		1745	20.33	20.35	20.25
		1710.7	20.33	20.30	20.28
	6RB (0)	1779.3	20.40	20.10	20.12
		1745	20.39	20.38	20.22
		1710.7	20.46	20.37	20.21
3 MHz	1RB High (14)	1778.5	20.39	20.67	20.41
		1745	20.41	20.21	20.56
		1711.5	20.43	20.23	20.37
	1RB Middle (7)	1778.5	20.36	20.62	20.39
		1745	20.44	20.24	20.39
		1711.5	20.41	20.24	20.42
	1RB Low (0)	1778.5	20.43	20.61	20.44
		1745	20.35	20.22	20.19
		1711.5	20.46	20.26	20.45
	8RB High (7)	1778.5	20.49	20.32	20.21
		1745	20.44	20.25	20.12
		1711.5	20.53	20.39	20.33
	8RB Middle	1778.5	20.51	20.40	20.30
		1745	20.48	20.32	20.23

	(4)	1711.5	20.58	20.43	20.39	
	8RB Low (0)	1778.5	20.48	20.36	20.24	
		1745	20.42	20.21	20.25	
		1711.5	20.53	20.40	20.32	
	15RB (0)	1778.5	20.48	20.31	20.23	
		1745	20.45	20.21	20.13	
		1711.5	20.54	20.34	20.33	
	5 MHz	1RB High (24)	1777.5	20.32	20.32	20.35
			1745	20.43	20.63	20.33
1712.5			20.46	20.48	20.10	
1RB Middle (12)		1777.5	20.40	20.36	20.39	
		1745	20.41	20.68	20.39	
		1712.5	20.49	20.46	20.49	
1RB Low (0)		1777.5	20.38	20.43	20.68	
		1745	20.36	20.64	20.50	
		1712.5	20.49	20.44	20.47	
12RB High (13)		1777.5	20.48	20.34	20.30	
		1745	20.44	20.38	20.31	
		1712.5	20.53	20.36	20.33	
12RB Middle (6)		1777.5	20.51	20.40	20.34	
		1745	20.44	20.35	20.21	
		1712.5	20.53	20.39	20.36	
12RB Low (0)		1777.5	20.49	20.33	20.38	
		1745	20.41	20.31	20.27	
		1712.5	20.55	20.35	20.34	
25RB (0)		1777.5	20.46	20.27	20.20	
		1745	20.49	20.29	20.23	
		1712.5	20.50	20.29	20.28	
10 MHz		1RB High (49)	1775	20.45	20.57	20.33
			1745	20.23	20.16	20.33
			1715	20.55	20.28	20.53
	1RB Middle (24)	1775	20.42	20.57	20.37	
		1745	20.36	20.15	20.40	
		1715	20.47	20.18	20.46	
	1RB Low (0)	1775	20.46	20.70	20.29	
		1745	20.45	20.30	20.49	
		1715	20.50	20.20	20.50	
	25RB High (25)	1775	20.51	20.30	20.30	
		1745	20.45	20.42	20.29	
		1715	20.56	20.32	20.33	
	25RB Middle (12)	1775	20.45	20.26	20.28	
		1745	20.43	20.29	20.23	
		1715	20.57	20.37	20.26	
	25RB Low (0)	1775	20.44	20.24	20.18	
		1745	20.38	20.27	20.20	
		1715	20.54	20.30	20.36	
50RB (0)	1775	20.39	20.24	20.31		
	1745	20.44	20.16	20.25		

15 MHz	1RB High (74)	1715	20.48	20.28	20.40
		1772.5	20.46	20.69	20.45
		1745	20.41	20.25	20.45
	1RB Middle (37)	1717.5	20.52	20.64	20.33
		1772.5	20.46	20.67	20.54
		1745	20.43	20.26	20.28
	1RB Low (0)	1717.5	20.48	20.68	20.26
		1772.5	20.49	20.69	20.34
		1745	20.36	20.17	20.23
	36RB High (38)	1717.5	20.45	20.65	20.40
		1772.5	20.48	20.26	20.40
		1745	20.48	20.26	20.29
	36RB Middle (19)	1717.5	20.56	20.36	20.35
		1772.5	20.48	20.19	20.29
		1745	20.44	20.24	20.27
	36RB Low (0)	1717.5	20.57	20.40	20.39
		1772.5	20.44	20.21	20.24
		1745	20.40	20.18	20.28
	75RB (0)	1717.5	20.52	20.34	20.36
		1772.5	20.42	20.20	20.29
		1745	20.43	20.12	20.23
20 MHz	1RB High (99)	1717.5	20.50	20.35	20.31
		1770	20.35	20.64	20.29
		1745	20.45	20.67	20.40
	1RB Middle (50)	1720	20.48	20.65	20.34
		1770	20.35	20.61	20.37
		1745	20.40	20.60	20.31
	1RB Low (0)	1720	20.45	20.61	20.36
		1770	20.43	20.68	20.39
		1745	20.40	20.66	20.31
	50RB High (50)	1720	20.43	20.66	20.39
		1770	20.48	20.28	20.36
		1745	20.50	20.28	20.24
	50RB Middle (25)	1720	20.55	20.28	20.29
		1770	20.45	20.27	20.25
		1745	20.44	20.25	20.25
	50RB Low (0)	1720	20.59	20.30	20.36
		1770	20.41	20.24	20.24
		1745	20.42	20.21	20.19
	100RB (0)	1720	20.47	20.15	20.24
		1770	20.44	20.23	20.17
		1745	20.42	20.24	20.24
		1720	20.60	20.38	20.26

## Power Level B1

Band 7					
Bandwidth (MHz)	RB allocation	Frequency (MHz)	QPSK	16QAM	64QAM
	RB offset (Start RB)		Actual output power (dBm)	Actual output power (dBm)	Actual output power (dBm)
5 MHz	1RB High (24)	2567.5	21.64	21.49	21.66
		2535	21.49	21.64	21.70
		2502.5	21.43	21.30	21.66
	1RB Middle (12)	2567.5	21.62	21.46	21.62
		2535	21.41	21.64	21.45
		2502.5	21.38	21.17	21.60
	1RB Low (0)	2567.5	21.66	21.47	21.62
		2535	21.35	21.58	21.58
		2502.5	21.34	21.20	21.69
	12RB High (13)	2567.5	21.63	21.43	20.78
		2535	21.59	21.38	21.47
		2502.5	21.48	21.20	21.55
	12RB Middle (6)	2567.5	21.61	21.41	20.71
		2535	21.48	21.30	21.40
		2502.5	21.48	21.19	21.59
	12RB Low (0)	2567.5	21.64	21.38	20.65
		2535	21.46	21.34	21.36
		2502.5	21.45	21.20	21.50
	25RB (0)	2567.5	21.61	21.37	20.58
		2535	21.53	21.24	21.27
		2502.5	21.48	21.09	21.60
10 MHz	1RB High (49)	2565	21.36	21.20	21.69
		2535	21.60	21.25	21.64
		2505	21.41	21.49	21.62
	1RB Middle (24)	2565	21.44	21.18	21.63
		2535	21.42	21.09	21.40
		2505	21.36	21.38	21.67
	1RB Low (0)	2565	21.34	21.23	21.41
		2535	21.27	21.02	21.45
		2505	21.28	21.37	21.66
	25RB High (25)	2565	21.63	21.42	20.56
		2535	21.59	21.28	21.35
		2505	21.43	21.15	21.51
	25RB Middle (12)	2565	21.56	21.34	20.43
		2535	21.52	21.21	21.39
		2505	21.47	21.26	21.51
25RB	2565	21.51	21.33	20.27	

	Low (0)	2535	21.50	21.21	21.16	
		2505	21.43	21.18	21.51	
	50RB (0)	2565	21.50	21.24	20.36	
		2535	21.49	21.15	21.22	
		2505	21.47	21.19	21.56	
15 MHz	1RB High (74)	2562.5	21.56	21.30	21.65	
		2535	21.56	21.66	21.54	
		2507.5	21.41	21.49	21.49	
	1RB Middle (37)	2562.5	21.57	21.28	21.39	
		2535	21.55	21.65	21.37	
		2507.5	21.42	21.55	21.50	
	1RB Low (0)	2562.5	21.51	21.18	21.62	
		2535	21.43	21.59	21.65	
		2507.5	21.38	21.45	21.61	
	36RB High (38)	2562.5	21.62	21.28	20.47	
		2535	21.57	21.34	21.45	
		2507.5	21.48	21.13	21.49	
	36RB Middle (19)	2562.5	21.56	21.26	20.36	
		2535	21.52	21.28	21.40	
		2507.5	21.50	21.11	21.55	
	36RB Low (0)	2562.5	21.54	21.23	20.50	
		2535	21.50	21.23	21.04	
		2507.5	21.37	20.99	21.40	
	75RB (0)	2562.5	21.52	21.24	20.32	
		2535	21.49	21.21	21.25	
		2507.5	21.45	21.10	21.50	
	20 MHz	1RB High (99)	2560	21.55	21.67	21.59
			2535	21.58	21.66	21.27
			2510	21.41	21.42	21.53
		1RB Middle (50)	2560	21.50	21.67	21.33
			2535	21.48	21.63	21.33
			2510	21.38	21.45	21.49
		1RB Low (0)	2560	21.49	21.64	21.51
			2535	21.38	21.59	21.61
			2510	21.32	21.39	21.56
50RB High (50)		2560	21.64	21.34	20.29	
		2535	21.59	21.32	21.43	
		2510	21.50	21.10	21.50	
50RB Middle (25)		2560	21.57	21.29	20.36	
		2535	21.53	21.23	21.30	
		2510	21.50	21.10	21.56	
50RB Low (0)		2560	21.54	21.25	20.78	
		2535	21.49	21.19	20.91	
		2510	21.37	20.99	21.40	
100RB (0)		2560	21.55	21.23	20.44	
		2535	21.49	21.21	21.25	
		2510	21.52	21.13	21.50	

Band 25					
Bandwidth (MHz)	RB allocation	Frequency (MHz)	QPSK	16QAM	64QAM
	RB offset (Start RB)		Actual output power (dBm)	Actual output power (dBm)	Actual output power (dBm)
1.4 MHz	1RB High (5)	1914.3	21.38	21.60	21.12
		1882.5	21.36	21.28	21.65
		1850.7	21.41	21.32	21.56
	1RB Middle (3)	1914.3	21.45	21.61	20.68
		1882.5	21.39	21.29	21.56
		1850.7	21.43	21.34	21.67
	1RB Low (0)	1914.3	21.35	21.54	20.72
		1882.5	21.29	21.19	21.45
		1850.7	21.34	21.22	21.51
	3RB High (3)	1914.3	21.38	21.36	20.75
		1882.5	21.40	21.39	21.45
		1850.7	21.34	21.24	21.27
	3RB Middle (1)	1914.3	21.39	21.41	20.88
		1882.5	21.40	21.43	21.52
		1850.7	21.33	21.30	20.78
	3RB Low (0)	1914.3	21.34	21.32	20.87
		1882.5	21.33	21.38	21.46
		1850.7	21.28	21.18	21.29
	6RB (0)	1914.3	21.40	21.08	19.76
		1882.5	21.44	21.40	21.37
		1850.7	21.40	21.32	21.28
3 MHz	1RB High (14)	1913.5	21.49	20.61	21.20
		1882.5	21.53	21.38	21.64
		1851.5	21.51	21.33	21.66
	1RB Middle (7)	1913.5	21.40	21.63	21.25
		1882.5	21.46	21.32	21.57
		1851.5	21.45	21.32	21.56
	1RB Low (0)	1913.5	21.39	21.57	21.54
		1882.5	21.31	21.24	21.63
		1851.5	21.40	21.33	21.67
	8RB High (7)	1913.5	21.57	21.31	19.98
		1882.5	21.56	21.38	21.52
		1851.5	21.54	21.42	21.45
	8RB Middle (4)	1913.5	21.58	21.36	20.12
		1882.5	21.58	21.38	21.48
		1851.5	21.53	21.40	21.41
8RB	1913.5	21.52	21.30	20.21	

	Low (0)	1882.5	21.41	21.23	21.44	
		1851.5	21.43	21.31	21.32	
	15RB (0)	1913.5	21.52	21.33	21.39	
		1882.5	21.46	21.20	21.33	
		1851.5	21.49	21.33	21.39	
5 MHz	1RB High (24)	1912.5	21.63	21.47	21.11	
		1882.5	21.49	21.63	21.48	
		1852.5	21.51	21.55	21.52	
	1RB Middle (12)	1912.5	21.62	21.51	21.50	
		1882.5	21.50	21.60	21.60	
		1852.5	21.45	21.59	21.50	
	1RB Low (0)	1912.5	21.64	21.52	21.69	
		1882.5	21.37	21.64	21.47	
		1852.5	21.51	21.59	21.61	
	12RB High (13)	1912.5	21.57	21.26	20.07	
		1882.5	21.59	21.52	20.33	
		1852.5	21.56	21.35	20.16	
	12RB Middle (6)	1912.5	21.56	21.37	20.39	
		1882.5	21.52	21.42	20.45	
		1852.5	21.53	21.37	20.38	
	12RB Low (0)	1912.5	21.49	21.34	20.67	
		1882.5	21.45	21.39	21.42	
		1852.5	21.48	21.29	21.39	
	25RB (0)	1912.5	21.52	21.32	20.20	
		1882.5	21.50	21.33	21.36	
		1852.5	21.51	21.24	21.36	
	10 MHz	1RB High (49)	1910	21.63	21.19	21.14
			1882.5	21.53	21.67	21.67
			1855	21.26	21.49	21.51
1RB Middle (24)		1910	21.53	21.22	21.46	
		1882.5	21.52	21.65	21.51	
		1855	21.34	21.22	21.30	
1RB Low (0)		1910	21.67	21.22	21.57	
		1882.5	21.41	21.51	21.51	
		1855	21.28	21.34	21.45	
25RB High (25)		1910	21.62	21.44	20.29	
		1882.5	21.59	21.45	20.31	
		1855	21.54	21.40	20.37	
25RB Middle (12)		1910	21.55	21.31	20.71	
		1882.5	21.55	21.31	20.71	
		1855	21.53	21.42	20.82	
25RB Low (0)		1910	21.54	21.29	20.82	
		1882.5	21.51	21.25	21.45	
		1855	21.50	21.36	21.39	
50RB (0)		1910	21.57	21.31	20.27	
		1882.5	21.51	21.31	21.39	
		1855	21.49	21.28	21.43	
15 MHz		1RB	1907.5	21.47	21.28	21.14



	High (74)	1882.5	21.57	21.61	21.37
		1857.5	21.46	21.67	21.36
	1RB Middle (37)	1907.5	21.51	21.31	21.41
		1882.5	21.55	21.63	21.59
	1RB Low (0)	1857.5	21.51	21.61	21.38
		1907.5	21.58	21.44	21.32
		1882.5	21.57	21.68	21.44
	36RB High (38)	1857.5	21.51	21.63	21.21
		1907.5	21.60	21.34	20.61
		1882.5	21.60	21.41	21.37
	36RB Middle (19)	1857.5	21.56	21.30	21.19
		1907.5	21.57	21.31	20.77
		1882.5	21.55	21.39	21.43
	36RB Low (0)	1857.5	21.59	21.35	21.45
		1907.5	21.55	21.37	20.58
		1882.5	21.58	21.39	21.33
	75RB (0)	1857.5	21.52	21.22	21.36
		1907.5	21.57	21.29	20.34
		1882.5	21.49	21.36	21.37
	20 MHz	1RB High (99)	1857.5	21.57	21.33
1905			21.61	21.66	21.24
1882.5			21.62	21.68	21.42
1RB Middle (50)		1860	21.49	21.57	21.25
		1905	21.52	21.64	21.43
		1882.5	21.64	21.69	21.43
1RB Low (0)		1860	21.56	21.65	21.47
		1905	21.65	21.69	21.24
		1882.5	21.69	21.63	21.51
50RB High (50)		1860	21.59	21.64	21.47
		1905	21.68	21.45	20.57
		1882.5	21.69	21.47	20.59
50RB Middle (25)		1860	21.63	21.35	20.85
		1905	21.67	21.52	20.62
		1882.5	21.66	21.44	20.53
50RB Low (0)		1860	21.68	21.39	21.22
		1905	21.67	21.44	20.31
		1882.5	21.63	21.42	21.46
100RB (0)		1860	21.58	21.27	21.36
		1905	21.63	21.40	19.97
	1882.5	21.61	21.37	21.32	
		1860	21.65	21.38	20.97

Band 41 – PC2					
Bandwidth (MHz)	RB allocation	Frequency (MHz)	QPSK	16QAM	64QAM
	RB offset (Start RB)		Actual output power (dBm)	Actual output power (dBm)	Actual output power (dBm)
5 MHz	1RB High (24)	2687.5	21.41	21.84	21.77
		2640.3	21.48	21.75	21.68
		2593	21.58	21.80	21.73
		2545.8	21.46	21.94	21.87
		2498.5	21.38	21.64	21.57
	1RB Middle (12)	2687.5	21.34	21.81	21.74
		2640.3	21.38	21.73	21.66
		2593	21.59	21.79	21.72
		2545.8	21.37	21.90	21.83
		2498.5	21.29	21.60	21.53
	1RB Low (0)	2687.5	21.37	21.87	21.80
		2640.3	21.47	21.73	21.66
		2593	21.50	21.74	21.67
		2545.8	21.38	21.71	21.64
		2498.5	21.42	21.63	21.56
	12RB High (13)	2687.5	21.52	21.57	21.50
		2640.3	21.54	21.64	21.57
		2593	21.59	21.60	21.53
		2545.8	21.57	21.57	21.50
		2498.5	21.48	21.51	21.44
	12RB Middle (6)	2687.5	21.46	21.58	21.51
		2640.3	21.56	21.67	21.60
		2593	21.61	21.63	21.56
		2545.8	21.54	21.65	21.58
		2498.5	21.47	21.56	21.49
	12RB Low (0)	2687.5	21.51	21.52	21.45
		2640.3	21.54	21.64	21.57
		2593	21.54	21.51	21.44
		2545.8	21.58	21.61	21.54
		2498.5	21.48	21.52	21.45
	25RB (0)	2687.5	21.47	21.48	21.41
		2640.3	21.55	21.56	21.49

		2593	21.54	21.56	21.49
		2545.8	21.54	21.55	21.48
		2498.5	21.45	21.45	21.38
10 MHz	1RB High (49)	2685	21.38	21.89	21.82
		2639	21.33	21.87	21.80
		2593	21.46	21.79	21.72
		2547	21.56	21.89	21.82
		2501	21.36	21.72	21.65
	1RB Middle (24)	2685	21.39	21.87	21.80
		2639	21.40	21.65	21.58
		2593	21.46	21.76	21.69
		2547	21.51	21.88	21.81
		2501	21.30	21.75	21.68
	1RB Low (0)	2685	21.38	21.81	21.74
		2639	21.53	21.92	21.85
		2593	21.37	21.69	21.62
		2547	21.48	21.86	21.79
		2501	21.33	21.87	21.80
	25RB High (25)	2685	21.49	21.45	21.38
		2639	21.49	21.56	21.49
		2593	21.62	21.62	21.55
		2547	21.55	21.55	21.48
		2501	21.46	21.50	21.43
	25RB Middle (12)	2685	21.54	21.50	21.43
		2639	21.51	21.61	21.54
		2593	21.56	21.53	21.46
		2547	21.57	21.57	21.50
		2501	21.48	21.55	21.48
	25RB Low (0)	2685	21.47	21.45	21.38
		2639	21.59	21.61	21.54
		2593	21.51	21.51	21.44
		2547	21.48	21.46	21.39
		2501	21.43	21.49	21.42
50RB (0)	2685	21.49	21.47	21.40	
	2639	21.48	21.55	21.48	
	2593	21.53	21.47	21.40	
	2547	21.55	21.58	21.51	
	2501	21.43	21.50	21.43	
15 MHz	1RB High (74)	2682.5	21.35	21.96	21.89
		2637.8	21.37	21.78	21.71
		2593	21.54	21.82	21.75

		2548.3	21.38	21.80	21.73
		2503.5	21.19	21.69	21.62
	1RB Middle (37)	2682.5	21.29	21.73	21.66
		2637.8	21.27	21.76	21.69
		2593	21.39	21.76	21.69
		2548.3	21.28	21.75	21.68
		2503.5	21.17	21.63	21.56
		1RB Low (0)	2682.5	21.30	21.81
	2637.8		21.37	21.77	21.70
	2593		21.41	21.75	21.68
	2548.3		21.29	21.75	21.68
	2503.5		21.20	21.56	21.49
	36RB High (38)	2682.5	21.40	21.31	21.24
		2637.8	21.44	21.51	21.44
		2593	21.53	21.55	21.48
		2548.3	21.50	21.51	21.44
		2503.5	21.44	21.47	21.40
	36RB Middle (19)	2682.5	21.47	21.48	21.41
		2637.8	21.43	21.49	21.42
		2593	21.46	21.49	21.42
		2548.3	21.48	21.51	21.44
		2503.5	21.40	21.49	21.42
	36RB Low (0)	2682.5	21.45	21.45	21.38
		2637.8	21.51	21.54	21.47
		2593	21.46	21.46	21.39
		2548.3	21.40	21.40	21.33
		2503.5	21.33	21.38	21.31
	75RB (0)	2682.5	21.47	21.45	21.38
2637.8		21.45	21.40	21.33	
2593		21.42	21.51	21.44	
2548.3		21.43	21.55	21.48	
2503.5		21.41	21.44	21.37	
20 MHz	1RB High (99)	2680	21.43	21.56	21.49
		2636.5	21.57	21.73	21.66
		2593	21.44	21.96	21.89
		2549.5	21.36	21.74	21.67
		2506	21.38	21.61	21.54
	1RB Middle (50)	2680	21.32	21.60	21.53
		2636.5	21.49	21.65	21.58
		2593	21.41	21.84	21.77
		2549.5	21.43	21.70	21.63
		2506	21.37	21.54	21.47

	1RB Low (0)	2680	21.45	21.62	21.55
		2636.5	21.57	21.69	21.62
		2593	21.46	21.91	21.84
		2549.5	21.42	21.58	21.51
		2506	21.30	21.66	21.59
	50RB High (50)	2680	21.41	21.39	21.32
		2636.5	21.45	21.45	21.38
		2593	21.54	21.63	21.56
		2549.5	21.47	21.48	21.41
		2506	21.43	21.47	21.40
	50RB Middle (25)	2680	21.48	21.47	21.40
		2636.5	21.47	21.47	21.40
		2593	21.45	21.54	21.47
		2549.5	21.48	21.50	21.43
		2506	21.45	21.46	21.39
	50RB Low (0)	2680	21.44	21.46	21.39
		2636.5	21.54	21.53	21.46
		2593	21.49	21.54	21.47
		2549.5	21.38	21.38	21.31
		2506	21.32	21.38	21.31
100RB (0)	2680	21.44	21.50	21.43	
	2636.5	21.47	21.43	21.36	
	2593	21.47	21.48	21.41	
	2549.5	21.46	21.46	21.39	
	2506	21.40	21.48	21.41	

Band 41 – PC3					
Bandwidth (MHz)	RB allocation	Frequency (MHz)	QPSK	16QAM	64QAM
	RB offset (Start RB)		Actual output power (dBm)	Actual output power (dBm)	Actual output power (dBm)
5 MHz	1RB High (24)	2687.5	21.33	21.63	21.76
		2640.3	21.50	21.46	21.59
		2593	21.53	21.54	21.67
		2545.8	21.44	21.64	21.77
		2498.5	21.42	21.45	21.58
	1RB Middle (12)	2687.5	21.33	21.65	21.78
		2640.3	21.46	21.46	21.59
		2593	21.53	21.49	21.62
		2545.8	21.40	21.66	21.79
		2498.5	21.39	21.45	21.58
	1RB Low (0)	2687.5	21.37	21.61	21.74
		2640.3	21.47	21.52	21.65
		2593	21.44	21.45	21.58
		2545.8	21.36	21.64	21.77
		2498.5	21.46	21.42	21.55
	12RB High (13)	2687.5	21.52	21.52	21.65
		2640.3	21.58	21.61	21.74
		2593	21.63	21.57	21.70
		2545.8	21.56	21.65	21.78
		2498.5	21.49	21.49	21.62
	12RB Middle (6)	2687.5	21.48	21.56	21.69
		2640.3	21.56	21.63	21.76
		2593	21.63	21.56	21.69
		2545.8	21.61	21.65	21.78
		2498.5	21.52	21.55	21.68
	12RB Low (0)	2687.5	21.49	21.51	21.64
		2640.3	21.57	21.57	21.70
		2593	21.55	21.51	21.64
2545.8		21.57	21.59	21.72	
2498.5		21.49	21.51	21.64	
25RB	2687.5	21.51	21.51	21.64	

	(0)	2640.3	21.53	21.54	21.67
		2593	21.53	21.54	21.67
		2545.8	21.53	21.57	21.70
		2498.5	21.48	21.47	21.60
10 MHz	1RB High (49)	2685	21.39	21.44	21.57
		2639	21.45	21.63	21.76
		2593	21.49	21.51	21.64
		2547	21.43	21.53	21.66
		2501	21.37	21.59	21.72
	1RB Middle (24)	2685	21.46	21.41	21.54
		2639	21.43	21.60	21.73
		2593	21.45	21.52	21.65
		2547	21.45	21.51	21.64
		2501	21.33	21.50	21.63
	1RB Low (0)	2685	21.35	21.45	21.58
		2639	21.42	21.62	21.75
		2593	21.42	21.47	21.60
		2547	21.35	21.42	21.55
		2501	21.29	21.51	21.64
	25RB High (25)	2685	21.51	21.48	21.61
		2639	21.49	21.54	21.67
		2593	21.60	21.58	21.71
		2547	21.57	21.53	21.66
		2501	21.47	21.52	21.65
	25RB Middle (12)	2685	21.60	21.51	21.64
		2639	21.51	21.51	21.64
		2593	21.57	21.52	21.65
		2547	21.60	21.54	21.67
		2501	21.49	21.41	21.54
	25RB Low (0)	2685	21.61	21.46	21.59
		2639	21.56	21.50	21.63
		2593	21.53	21.53	21.66
		2547	21.53	21.44	21.57
		2501	21.49	21.41	21.54
	50RB (0)	2685	21.51	21.52	21.65
		2639	21.51	21.57	21.70
2593		21.54	21.51	21.64	
2547		21.55	21.58	21.71	
2501		21.47	21.48	21.61	
15 MHz	1RB High (74)	2682.5	21.44	21.23	21.36
		2637.8	21.45	21.54	21.67

		2593	21.51	21.53	21.66
		2548.3	21.44	21.37	21.50
		2503.5	21.28	21.51	21.64
	1RB Middle (37)	2682.5	21.35	21.25	21.38
		2637.8	21.39	21.52	21.65
		2593	21.38	21.37	21.50
		2548.3	21.36	21.26	21.39
		2503.5	21.31	21.48	21.61
	1RB Low (0)	2682.5	21.37	21.41	21.54
		2637.8	21.40	21.56	21.69
		2593	21.46	21.27	21.40
		2548.3	21.40	21.30	21.43
		2503.5	21.32	21.36	21.49
	36RB High (38)	2682.5	21.43	21.07	21.20
		2637.8	21.49	21.52	21.65
		2593	21.51	21.57	21.70
		2548.3	21.50	21.32	21.45
		2503.5	21.47	21.50	21.63
	36RB Middle (19)	2682.5	21.47	21.21	21.34
		2637.8	21.51	21.50	21.63
		2593	21.49	21.49	21.62
		2548.3	21.51	21.41	21.54
		2503.5	21.45	21.50	21.63
	36RB Low (0)	2682.5	21.52	21.23	21.36
		2637.8	21.57	21.57	21.70
		2593	21.49	21.50	21.63
		2548.3	21.42	21.44	21.57
		2503.5	21.36	21.40	21.53
	75RB (0)	2682.5	21.49	21.36	21.49
		2637.8	21.48	21.48	21.61
2593		21.38	21.52	21.65	
2548.3		21.50	21.43	21.56	
2503.5		21.47	21.47	21.60	
20 MHz	1RB High (99)	2680	21.50	21.37	21.50
		2636.5	21.52	21.43	21.56
		2593	21.58	21.69	21.82
		2549.5	21.41	21.47	21.60
		2506	21.33	21.28	21.41
	1RB Middle (50)	2680	21.39	21.34	21.47
		2636.5	21.41	21.43	21.56
		2593	21.42	21.58	21.71
		2549.5	21.38	21.44	21.57



		2506	21.30	21.28	21.41
	1RB Low (0)	2680	21.49	21.42	21.55
		2636.5	21.52	21.42	21.55
		2593	21.52	21.67	21.80
		2549.5	21.40	21.40	21.53
		2506	21.37	21.23	21.36
		50RB High (50)	2680	21.45	21.41
	2636.5		21.46	21.51	21.64
	2593		21.58	21.66	21.79
	2549.5		21.49	21.50	21.63
	2506		21.46	21.52	21.65
	50RB Middle (25)	2680	21.51	21.51	21.64
		2636.5	21.50	21.50	21.63
		2593	21.51	21.57	21.70
		2549.5	21.49	21.52	21.65
		2506	21.47	21.52	21.65
	50RB Low (0)	2680	21.50	21.48	21.61
		2636.5	21.58	21.60	21.73
		2593	21.52	21.56	21.69
		2549.5	21.35	21.40	21.53
		2506	21.41	21.40	21.53
	100RB (0)	2680	21.51	21.48	21.61
		2636.5	21.49	21.52	21.65
		2593	21.52	21.53	21.66
		2549.5	21.50	21.53	21.66
		2506	21.46	21.50	21.63

Band 66						
Bandwidth (MHz)	RB allocation	Frequency (MHz)	QPSK	16QAM	64QAM	
	RB offset (Start RB)		Actual output power (dBm)	Actual output power (dBm)	Actual output power (dBm)	
1.4 MHz	1RB High (5)	1779.3	21.36	21.53	21.15	
		1745	21.37	21.22	21.33	
		1710.7	21.44	21.33	21.44	
	1RB Middle (3)	1779.3	21.38	21.59	21.41	
		1745	21.40	21.23	21.25	
		1710.7	21.47	21.40	21.47	
	1RB Low (0)	1779.3	21.32	21.55	21.32	
		1745	21.34	21.20	21.39	
		1710.7	21.44	21.35	21.51	
	3RB High (3)	1779.3	21.33	21.33	21.29	
		1745	21.32	21.32	21.20	
		1710.7	21.39	21.27	21.33	
	3RB Middle (1)	1779.3	21.36	21.44	21.30	
		1745	21.38	21.38	21.20	
		1710.7	21.45	21.34	21.41	
	3RB Low (0)	1779.3	21.34	21.37	21.29	
		1745	21.34	21.34	21.27	
		1710.7	21.39	21.27	21.35	
	6RB (0)	1779.3	21.41	21.07	21.16	
		1745	21.42	21.38	21.42	
		1710.7	21.46	21.38	21.43	
	3 MHz	1RB High (14)	1778.5	21.51	21.57	21.38
			1745	21.52	21.23	21.49
			1711.5	21.53	21.27	21.60
		1RB Middle (7)	1778.5	21.52	21.58	21.43
			1745	21.47	21.23	21.32
			1711.5	21.52	21.30	21.38
1RB Low (0)		1778.5	21.48	21.60	21.46	
		1745	20.98	21.21	21.46	
		1711.5	21.31	21.30	21.61	
8RB High (7)		1778.5	21.54	21.31	21.32	
		1745	21.49	21.23	21.24	
		1711.5	21.54	21.41	21.35	
8RB Middle		1778.5	21.59	21.34	21.30	
		1745	21.49	21.29	21.32	

	(4)	1711.5	21.63	21.46	21.34	
	8RB Low (0)	1778.5	21.58	21.32	21.35	
		1745	21.44	21.21	21.25	
		1711.5	21.55	21.42	21.26	
	15RB (0)	1778.5	21.62	21.27	21.27	
		1745	21.50	21.22	21.29	
		1711.5	21.56	21.36	21.27	
	5 MHz	1RB High (24)	1777.5	21.45	21.38	21.42
			1745	21.34	21.68	21.49
1712.5			21.50	21.49	21.45	
1RB Middle (12)		1777.5	21.47	21.43	21.38	
		1745	21.37	21.60	21.42	
		1712.5	21.50	21.58	21.35	
1RB Low (0)		1777.5	21.48	21.43	21.49	
		1745	21.25	21.64	21.42	
		1712.5	21.54	21.48	21.55	
12RB High (13)		1777.5	21.39	21.31	21.27	
		1745	21.44	21.37	21.33	
		1712.5	21.55	21.36	21.31	
12RB Middle (6)		1777.5	21.44	21.32	21.29	
		1745	21.40	21.37	21.31	
		1712.5	21.58	21.42	21.38	
12RB Low (0)		1777.5	21.45	21.32	21.36	
		1745	21.37	21.33	21.25	
		1712.5	21.53	21.38	21.31	
25RB (0)		1777.5	21.48	21.27	21.18	
		1745	21.45	21.31	21.45	
		1712.5	21.54	21.25	21.40	
10 MHz		1RB High (49)	1775	21.37	21.13	21.21
			1745	21.35	21.57	21.68
			1715	21.27	21.34	21.57
	1RB Middle (24)	1775	21.34	21.05	21.39	
		1745	21.43	21.53	21.64	
		1715	21.37	21.24	21.34	
	1RB Low (0)	1775	21.41	21.44	21.28	
		1745	21.47	21.62	21.34	
		1715	21.30	21.33	21.50	
	25RB High (25)	1775	21.43	21.29	21.29	
		1745	21.44	21.25	21.32	
		1715	21.48	21.39	21.30	
	25RB Middle (12)	1775	21.41	21.19	21.30	
		1745	21.40	21.27	21.22	
		1715	21.56	21.41	21.35	
	25RB Low (0)	1775	21.40	21.21	21.07	
		1745	21.39	21.21	21.25	
		1715	21.50	21.36	21.27	
	50RB (0)	1775	21.43	21.12	21.21	
		1745	21.43	21.20	21.29	

15 MHz	1RB High (74)	1715	21.48	21.28	21.33	
		1772.5	21.37	21.09	21.42	
		1745	21.37	21.56	21.49	
	1RB Middle (37)	1717.5	21.41	21.61	21.46	
		1772.5	21.40	21.18	21.27	
		1745	21.37	21.62	21.42	
	1RB Low (0)	1717.5	21.46	21.65	21.33	
		1772.5	21.36	21.16	21.30	
		1745	21.30	21.61	21.39	
	36RB High (38)	1717.5	21.42	21.63	21.28	
		1772.5	21.44	21.19	21.33	
		1745	21.45	21.30	21.36	
	36RB Middle (19)	1717.5	21.51	21.28	21.33	
		1772.5	21.39	21.18	21.16	
		1745	21.39	21.22	21.23	
	36RB Low (0)	1717.5	21.55	21.29	21.30	
		1772.5	21.39	21.14	21.11	
		1745	21.37	21.19	21.31	
	75RB (0)	1717.5	21.52	21.27	21.36	
		1772.5	21.34	21.18	21.29	
		1745	21.35	21.18	21.18	
	20 MHz	1RB High (99)	1717.5	21.46	21.29	21.23
			1770	21.38	21.55	21.38
			1745	21.35	21.57	21.61
		1RB Middle (50)	1720	21.40	21.70	21.50
			1770	21.32	21.59	21.30
			1745	21.36	21.54	21.61
1RB Low (0)		1720	21.32	21.64	21.48	
		1770	21.37	21.60	21.48	
		1745	21.34	21.53	21.35	
50RB High (50)		1720	21.41	21.69	21.53	
		1770	21.46	21.23	21.37	
		1745	21.44	21.17	21.35	
50RB Middle (25)		1720	21.48	21.31	21.33	
		1770	21.40	21.15	21.18	
		1745	21.39	21.11	21.29	
50RB Low (0)		1720	21.50	21.34	21.42	
		1770	21.37	21.16	21.37	
		1745	21.34	21.13	21.28	
100RB (0)		1720	21.44	21.22	21.27	
		1770	21.38	21.17	21.36	
		1745	21.35	21.12	21.30	
			1720	21.50	21.32	21.45

## Power Level C1

Band 7						
Bandwidth (MHz)	RB allocation	Frequency (MHz)	QPSK	16QAM	64QAM	
	RB offset (Start RB)		Actual output power (dBm)	Actual output power (dBm)	Actual output power (dBm)	
5 MHz	1RB High (24)	2567.5	22.81	22.14	20.58	
		2535	22.82	22.11	20.55	
		2502.5	22.77	22.33	20.77	
	1RB Middle (12)	2567.5	22.73	22.11	20.55	
		2535	22.82	22.07	20.51	
		2502.5	22.71	22.28	20.72	
	1RB Low (0)	2567.5	22.76	22.07	20.51	
		2535	22.79	22.02	20.46	
		2502.5	22.72	22.29	20.73	
	12RB High (13)	2567.5	21.96	21.09	19.53	
		2535	21.98	21.04	19.48	
		2502.5	21.80	21.01	19.45	
	12RB Middle (6)	2567.5	21.91	21.09	19.53	
		2535	21.90	21.02	19.46	
		2502.5	21.82	20.97	19.41	
	12RB Low (0)	2567.5	21.92	21.06	19.50	
		2535	21.92	21.01	19.45	
		2502.5	21.82	20.99	19.43	
	25RB (0)	2567.5	21.91	20.96	19.40	
		2535	21.92	20.96	19.40	
		2502.5	21.84	20.90	19.34	
	10 MHz	1RB High (49)	2565	22.85	21.90	20.34
			2535	22.81	22.23	20.67
			2505	22.84	21.82	20.26
1RB Middle (24)		2565	22.77	21.84	20.28	
		2535	22.75	22.20	20.64	
		2505	22.73	21.72	20.16	
1RB Low (0)		2565	22.74	21.83	20.27	
		2535	22.84	22.23	20.67	
		2505	22.75	21.79	20.23	
25RB High (25)		2565	21.92	21.08	19.52	
		2535	21.98	21.05	19.49	
		2505	21.88	20.92	19.36	
25RB Middle (12)		2565	21.94	20.98	19.42	
		2535	21.90	21.00	19.44	
		2505	21.87	20.98	19.42	
25RB	2565	21.89	20.98	19.42		

	Low (0)	2535	21.90	20.98	19.42	
		2505	21.81	20.92	19.36	
	50RB (0)	2565	21.91	20.91	19.35	
		2535	21.92	20.95	19.39	
		2505	21.85	20.87	19.31	
15 MHz	1RB High (74)	2562.5	22.98	22.49	20.93	
		2535	22.83	21.87	20.31	
		2507.5	22.87	22.24	20.68	
	1RB Middle (37)	2562.5	22.95	22.44	20.88	
		2535	22.85	21.91	20.35	
		2507.5	22.83	22.25	20.69	
	1RB Low (0)	2562.5	22.91	22.37	20.81	
		2535	22.83	21.85	20.29	
		2507.5	22.83	22.21	20.65	
	36RB High (38)	2562.5	21.99	20.98	19.42	
		2535	21.94	21.00	19.44	
		2507.5	21.86	20.90	19.34	
	36RB Middle (19)	2562.5	21.90	20.92	19.36	
		2535	21.87	20.92	19.36	
		2507.5	21.91	20.96	19.40	
	36RB Low (0)	2562.5	21.92	20.90	19.34	
		2535	21.85	20.86	19.30	
		2507.5	21.78	20.82	19.26	
	75RB (0)	2562.5	21.92	20.92	19.36	
		2535	21.86	20.85	19.29	
		2507.5	21.86	20.93	19.37	
	20 MHz	1RB High (99)	2560	22.85	22.40	20.84
			2535	22.88	22.30	20.74
			2510	22.80	22.42	20.86
		1RB Middle (50)	2560	22.85	22.39	20.83
			2535	22.82	22.30	20.74
			2510	22.68	22.41	20.85
		1RB Low (0)	2560	22.82	22.38	20.82
			2535	22.80	22.25	20.69
			2510	22.64	22.26	20.70
50RB High (50)		2560	21.96	21.03	19.47	
		2535	21.98	20.94	19.38	
		2510	21.92	20.92	19.36	
50RB Middle (25)		2560	21.93	20.98	19.42	
		2535	21.91	20.88	19.32	
		2510	21.91	20.93	19.37	
50RB Low (0)		2560	21.92	20.96	19.40	
		2535	21.87	20.86	19.30	
		2510	21.80	20.80	19.24	
100RB (0)		2560	21.92	20.90	19.34	
		2535	21.90	20.87	19.31	
		2510	21.91	20.92	19.36	

Band 25					
Bandwidth (MHz)	RB allocation RB offset (Start RB)	Frequency (MHz)	QPSK	16QAM	64QAM
			Actual output power (dBm)	Actual output power (dBm)	Actual output power (dBm)
1.4 MHz	1RB High (5)	1914.3	23.27	22.21	21.41
		1882.5	23.62	22.01	21.58
		1850.7	23.58	22.19	21.53
	1RB Middle (3)	1914.3	23.34	22.32	21.50
		1882.5	23.64	22.00	22.56
		1850.7	23.58	22.23	22.46
	1RB Low (0)	1914.3	23.35	21.91	21.55
		1882.5	23.54	21.94	22.48
		1850.7	23.48	22.18	22.34
	3RB High (3)	1914.3	23.05	21.93	21.69
		1882.5	23.58	21.91	22.56
		1850.7	23.53	21.96	22.37
	3RB Middle (1)	1914.3	23.23	21.96	20.84
		1882.5	23.59	21.95	22.47
		1850.7	23.57	22.04	22.42
	3RB Low (0)	1914.3	23.15	21.91	20.87
		1882.5	23.50	21.91	22.36
		1850.7	23.48	21.96	22.29
	6RB (0)	1914.3	22.30	20.99	20.83
		1882.5	22.60	20.94	21.22
		1850.7	22.57	20.71	21.15
3 MHz	1RB High (14)	1913.5	23.47	22.17	21.06
		1882.5	23.77	23.14	22.54
		1851.5	23.69	22.72	22.53
	1RB Middle (7)	1913.5	23.59	22.39	21.24
		1882.5	23.66	23.04	22.57
		1851.5	23.58	22.65	22.48
	1RB Low (0)	1913.5	23.57	22.62	21.25
		1882.5	23.56	22.94	22.38
		1851.5	23.59	22.62	22.44
	8RB High (7)	1913.5	22.74	21.76	20.04
		1882.5	22.79	21.84	21.47
		1851.5	22.70	21.73	21.37
	8RB Middle (4)	1913.5	22.70	21.83	20.16
		1882.5	22.78	21.82	21.52
1851.5		22.66	21.73	21.38	
8RB	1913.5	22.63	21.78	21.19	

	Low (0)	1882.5	22.63	21.66	21.34	
		1851.5	22.61	21.65	21.28	
	15RB (0)	1913.5	22.69	21.78	20.14	
		1882.5	22.68	21.71	21.36	
		1851.5	22.66	21.64	21.31	
5 MHz	1RB High (24)	1912.5	23.44	22.43	20.73	
		1882.5	23.62	22.91	22.55	
		1852.5	23.64	23.20	22.52	
	1RB Middle (12)	1912.5	23.70	22.81	21.22	
		1882.5	23.59	22.93	22.54	
		1852.5	23.57	23.16	22.46	
	1RB Low (0)	1912.5	23.68	22.91	21.61	
		1882.5	23.55	22.81	22.42	
		1852.5	23.61	23.20	22.38	
	12RB High (13)	1912.5	22.54	21.74	19.98	
		1882.5	22.72	21.82	21.50	
		1852.5	22.66	21.81	21.38	
	12RB Middle (6)	1912.5	22.69	21.75	20.34	
		1882.5	22.66	21.78	21.40	
		1852.5	22.67	21.79	21.39	
	12RB Low (0)	1912.5	22.65	21.73	20.59	
		1882.5	22.61	21.69	21.34	
		1852.5	22.58	21.74	21.33	
	25RB (0)	1912.5	22.74	21.64	20.12	
		1882.5	22.62	21.64	21.36	
		1852.5	22.64	21.72	21.39	
	10 MHz	1RB High (49)	1910	23.58	22.55	21.18
			1882.5	23.60	23.10	22.29
			1855	23.68	22.60	22.25
1RB Middle (24)		1910	23.65	22.73	22.01	
		1882.5	23.62	23.00	22.41	
		1855	23.59	22.62	22.43	
1RB Low (0)		1910	23.62	22.72	21.77	
		1882.5	23.66	23.07	21.48	
		1855	23.64	22.62	22.18	
25RB High (25)		1910	22.74	21.77	21.31	
		1882.5	22.74	21.79	21.48	
		1855	22.68	21.76	21.39	
25RB Middle (12)		1910	22.68	21.67	21.30	
		1882.5	22.66	21.71	21.45	
		1855	22.68	21.78	21.43	
25RB Low (0)		1910	22.59	21.66	20.94	
		1882.5	22.63	21.72	21.43	
		1855	22.64	21.73	21.32	
50RB (0)		1910	22.65	21.62	20.37	
		1882.5	22.65	21.68	21.39	
		1855	22.60	21.71	21.25	
15 MHz		1RB	1907.5	23.61	22.84	21.30



	High (74)	1882.5	23.66	22.65	22.56
		1857.5	23.50	22.98	22.63
	1RB Middle (37)	1907.5	23.77	23.22	21.74
		1882.5	23.67	22.70	22.37
	1RB Low (0)	1857.5	23.60	22.98	22.43
		1907.5	23.78	23.03	21.22
		1882.5	23.68	22.70	21.92
	36RB High (38)	1857.5	23.57	23.00	22.49
		1907.5	22.72	21.73	20.62
		1882.5	22.73	21.73	21.46
	36RB Middle (19)	1857.5	22.61	21.61	21.21
		1907.5	22.70	21.70	20.73
		1882.5	22.69	21.73	21.36
	36RB Low (0)	1857.5	22.67	21.70	21.51
		1907.5	22.70	21.67	20.58
		1882.5	22.69	21.63	21.47
	75RB (0)	1857.5	22.64	21.68	21.30
		1907.5	22.66	21.68	20.36
		1882.5	22.66	21.65	21.27
	20 MHz	1RB High (99)	1857.5	22.64	21.66
1905			22.93	22.73	20.99
1882.5			23.56	23.19	22.35
1RB Middle (50)		1860	23.48	23.21	21.45
		1905	22.88	22.90	21.07
		1882.5	23.48	23.18	22.43
1RB Low (0)		1860	23.59	23.04	22.29
		1905	23.09	23.11	21.24
		1882.5	23.47	23.17	22.18
50RB High (50)		1860	23.56	23.14	22.51
		1905	22.73	21.72	19.72
		1882.5	22.73	21.77	21.43
50RB Middle (25)		1860	22.61	21.68	20.73
		1905	22.79	21.76	19.75
		1882.5	22.67	21.76	21.32
50RB Low (0)		1860	22.65	21.70	21.17
		1905	22.66	21.66	20.36
		1882.5	22.68	21.71	21.37
100RB (0)		1860	22.57	21.63	21.30
		1905	22.45	21.64	19.89
	1882.5	22.69	21.72	21.06	
		1860	22.65	21.66	20.96

Band 41 – PC2					
Bandwidth (MHz)	RB allocation	Frequency (MHz)	QPSK	16QAM	64QAM
	RB offset (Start RB)		Actual output power (dBm)	Actual output power (dBm)	Actual output power (dBm)
5 MHz	1RB High (24)	2687.5	26.65	26.23	25.61
		2640.3	26.67	25.98	25.36
		2593	26.66	25.97	25.35
		2545.8	26.47	25.96	25.34
		2498.5	26.40	25.70	25.08
	1RB Middle (12)	2687.5	26.62	26.21	25.59
		2640.3	26.65	26.00	25.38
		2593	26.60	25.99	25.37
		2545.8	26.44	25.99	25.37
	1RB Low (0)	2498.5	26.37	25.68	25.06
		2687.5	26.61	26.11	25.49
		2640.3	26.68	25.97	25.35
		2593	26.57	25.89	25.27
	12RB High (13)	2545.8	26.40	25.87	25.25
		2498.5	26.45	25.73	25.11
		2687.5	25.74	24.84	24.22
		2640.3	25.75	24.81	24.19
		2593	25.71	24.69	24.07
	12RB Middle (6)	2545.8	25.58	24.69	24.07
		2498.5	25.53	24.54	23.92
		2687.5	25.74	24.87	24.25
		2640.3	25.79	24.82	24.20
		2593	25.75	24.75	24.13
	12RB Low (0)	2545.8	25.61	24.76	24.14
		2498.5	25.53	24.58	23.96
		2687.5	25.75	24.81	24.19
		2640.3	25.74	24.78	24.16
		2593	25.65	24.63	24.01
	25RB (0)	2545.8	25.55	24.69	24.07
		2498.5	25.48	24.53	23.91
2687.5		25.73	24.77	24.15	
		2640.3	25.76	24.79	24.17

		2593	25.66	24.65	24.03
		2545.8	25.57	24.61	23.99
		2498.5	25.47	24.48	23.86
10 MHz	1RB High (49)	2685	26.55	26.20	25.58
		2639	26.71	26.04	25.42
		2593	26.48	26.13	25.51
		2547	26.46	26.00	25.38
		2501	26.45	25.71	25.09
	1RB Middle (24)	2685	26.52	25.94	25.32
		2639	26.71	25.99	25.37
		2593	26.64	26.10	25.48
		2547	26.41	25.97	25.35
		2501	26.29	25.68	25.06
	1RB Low (0)	2685	26.54	25.95	25.33
		2639	26.64	26.03	25.41
		2593	26.60	26.12	25.50
		2547	26.42	25.99	25.37
		2501	26.45	25.63	25.01
	25RB High (25)	2685	25.74	24.81	24.19
		2639	25.73	24.74	24.12
		2593	25.73	24.77	24.15
		2547	25.60	24.66	24.04
		2501	25.48	24.50	23.88
	25RB Middle (12)	2685	25.74	24.82	24.20
		2639	25.76	24.74	24.12
		2593	25.67	24.72	24.10
		2547	25.66	24.70	24.08
		2501	25.53	24.52	23.90
	25RB Low (0)	2685	25.75	24.78	24.16
		2639	25.78	24.79	24.17
		2593	25.63	24.69	24.07
		2547	25.54	24.57	23.95
		2501	25.48	24.55	23.93
50RB (0)	2685	25.72	24.76	24.14	
	2639	25.67	24.69	24.07	
	2593	25.64	24.68	24.06	
	2547	25.60	24.66	24.04	
	2501	25.48	24.51	23.89	
15 MHz	1RB High (74)	2682.5	26.61	26.06	25.44
		2637.8	26.64	25.98	25.36
		2593	26.64	26.15	25.53

		2548.3	26.47	25.83	25.21
		2503.5	26.28	25.58	24.96
	1RB Middle (37)	2682.5	26.54	26.04	25.42
		2637.8	26.56	25.90	25.28
		2593	26.50	26.04	25.42
		2548.3	26.34	25.82	25.20
		2503.5	26.29	25.57	24.95
		1RB Low (0)	2682.5	26.56	26.10
	2637.8		26.62	25.97	25.35
	2593		26.50	26.03	25.41
	2548.3		26.38	25.79	25.17
	2503.5		26.31	25.54	24.92
	36RB High (38)	2682.5	25.62	24.68	24.06
		2637.8	25.65	24.66	24.04
		2593	25.71	24.68	24.06
		2548.3	25.56	24.62	24.00
		2503.5	25.43	24.44	23.82
	36RB Middle (19)	2682.5	25.70	24.75	24.13
		2637.8	25.63	24.64	24.02
		2593	25.62	24.62	24.00
		2548.3	25.57	24.61	23.99
		2503.5	25.42	24.42	23.80
	36RB Low (0)	2682.5	25.72	24.75	24.13
		2637.8	25.71	24.73	24.11
		2593	25.62	24.59	23.97
		2548.3	25.47	24.53	23.91
		2503.5	25.36	24.32	23.70
	75RB (0)	2682.5	25.72	24.71	24.09
2637.8		25.57	24.62	24.00	
2593		25.60	24.65	24.03	
2548.3		25.53	24.55	23.93	
2503.5		25.42	24.40	23.78	
20 MHz	1RB High (99)	2680	26.63	26.17	25.55
		2636.5	26.72	25.93	25.31
		2593	26.61	25.79	25.17
		2549.5	26.40	25.90	25.28
		2506	26.37	25.61	24.99
	1RB Middle (50)	2680	26.50	26.04	25.42
		2636.5	26.63	25.88	25.26
		2593	26.52	25.73	25.11
		2549.5	26.32	25.87	25.25
		2506	26.31	25.61	24.99

	1RB Low (0)	2680	26.61	26.14	25.52
		2636.5	26.69	25.97	25.35
		2593	26.61	25.75	25.13
		2549.5	26.33	25.83	25.21
		2506	26.37	25.62	25.00
	50RB High (50)	2680	25.64	24.72	24.10
		2636.5	25.64	24.65	24.03
		2593	25.68	24.72	24.10
		2549.5	25.53	24.59	23.97
		2506	25.46	24.44	23.82
	50RB Middle (25)	2680	25.69	24.79	24.17
		2636.5	25.63	24.63	24.01
		2593	25.64	24.64	24.02
		2549.5	25.54	24.58	23.96
		2506	25.45	24.45	23.83
	50RB Low (0)	2680	25.68	24.75	24.13
		2636.5	25.72	24.73	24.11
		2593	25.56	24.64	24.02
		2549.5	25.43	24.51	23.89
		2506	25.36	24.37	23.75
100RB (0)	2680	25.73	24.69	24.07	
	2636.5	25.66	24.60	23.98	
	2593	25.63	24.58	23.96	
	2549.5	25.58	24.54	23.92	
	2506	25.46	24.42	23.80	

Band 41 – PC3					
Bandwidth (MHz)	RB allocation	Frequency (MHz)	QPSK	16QAM	64QAM
	RB offset (Start RB)		Actual output power (dBm)	Actual output power (dBm)	Actual output power (dBm)
5 MHz	1RB High (24)	2687.5	24.26	23.60	22.82
		2640.3	24.41	23.34	22.56
		2593	24.45	23.49	22.71
		2545.8	24.32	23.58	22.80
		2498.5	24.34	23.30	22.52
	1RB Middle (12)	2687.5	24.24	23.62	22.84
		2640.3	24.36	23.39	22.61
		2593	24.47	23.48	22.70
		2545.8	24.33	23.54	22.76
		2498.5	24.27	23.34	22.56
	1RB Low (0)	2687.5	24.25	23.51	22.73
		2640.3	24.42	23.40	22.62
		2593	24.39	23.42	22.64
		2545.8	24.25	23.51	22.73
		2498.5	24.32	23.31	22.53
	12RB High (13)	2687.5	23.43	22.48	21.70
		2640.3	23.49	22.48	21.70
		2593	23.49	22.53	21.75
		2545.8	23.40	22.50	21.72
		2498.5	23.38	22.42	21.64
	12RB Middle (6)	2687.5	23.42	22.49	21.71
		2640.3	23.50	22.54	21.76
		2593	23.53	22.51	21.73
		2545.8	23.43	22.53	21.75
		2498.5	23.39	22.40	21.62
	12RB Low (0)	2687.5	23.42	22.49	21.71
		2640.3	23.49	22.49	21.71
		2593	23.42	22.44	21.66
		2545.8	23.40	22.51	21.73
		2498.5	23.41	22.42	21.64
25RB	2687.5	23.41	22.39	21.61	

	(0)	2640.3	23.49	22.47	21.69
		2593	23.46	22.48	21.70
		2545.8	23.43	22.44	21.66
		2498.5	23.38	22.36	21.58
10 MHz	1RB High (49)	2685	24.26	23.44	22.66
		2639	24.33	23.40	22.62
		2593	24.32	23.45	22.67
		2547	24.37	23.48	22.70
		2501	24.25	23.33	22.55
	1RB Middle (24)	2685	24.27	23.63	22.85
		2639	24.37	23.37	22.59
		2593	24.43	23.39	22.61
		2547	24.34	23.43	22.65
		2501	24.30	23.27	22.49
	1RB Low (0)	2685	24.27	23.46	22.68
		2639	24.32	23.38	22.60
		2593	24.28	23.43	22.65
		2547	24.26	23.49	22.71
		2501	24.27	23.26	22.48
	25RB High (25)	2685	23.39	22.48	21.70
		2639	23.44	22.45	21.67
		2593	23.49	22.51	21.73
		2547	23.49	22.46	21.68
		2501	23.38	22.40	21.62
25RB Middle (12)	2685	23.42	22.43	21.65	
	2639	23.44	22.45	21.67	
	2593	23.47	22.43	21.65	
	2547	23.48	22.51	21.73	
	2501	23.38	22.37	21.59	
25RB Low (0)	2685	23.38	22.67	21.89	
	2639	23.49	22.53	21.75	
	2593	23.36	22.44	21.66	
	2547	23.40	22.55	21.77	
	2501	23.36	22.37	21.59	
50RB (0)	2685	23.39	22.70	21.92	
	2639	23.41	22.42	21.64	
	2593	23.42	22.43	21.65	
	2547	23.44	22.48	21.70	
	2501	23.39	22.36	21.58	
15 MHz	1RB High (74)	2682.5	24.23	23.55	22.77
		2637.8	24.42	23.38	22.60

		2593	24.44	23.49	22.71
		2548.3	24.30	23.42	22.64
		2503.5	24.28	23.25	22.47
	1RB Middle (37)	2682.5	24.14	23.41	22.63
		2637.8	24.38	23.43	22.65
		2593	24.34	23.41	22.63
		2548.3	24.20	23.41	22.63
		2503.5	24.26	23.19	22.41
		1RB Low (0)	2682.5	24.20	23.42
	2637.8		24.31	23.40	22.62
	2593		24.29	23.47	22.69
	2548.3		24.23	23.52	22.74
	2503.5		24.21	23.05	22.27
	36RB High (38)	2682.5	23.32	22.35	21.57
		2637.8	23.40	22.42	21.64
		2593	23.50	22.43	21.65
		2548.3	23.42	22.48	21.70
		2503.5	23.38	22.31	21.53
	36RB Middle (19)	2682.5	23.43	22.42	21.64
		2637.8	23.40	22.40	21.62
		2593	23.40	22.41	21.63
		2548.3	23.40	22.43	21.65
		2503.5	23.35	22.40	21.62
	36RB Low (0)	2682.5	23.43	22.42	21.64
		2637.8	23.42	22.46	21.68
		2593	23.42	22.35	21.57
		2548.3	23.35	22.38	21.60
		2503.5	23.26	22.28	21.50
	75RB (0)	2682.5	23.39	22.45	21.67
		2637.8	23.36	22.44	21.66
2593		23.37	22.37	21.59	
2548.3		23.41	22.44	21.66	
2503.5		23.39	22.37	21.59	
20 MHz	1RB High (99)	2680	24.45	23.33	22.55
		2636.5	24.39	23.30	22.52
		2593	24.52	23.61	22.83
		2549.5	24.36	23.33	22.55
		2506	24.25	23.23	22.45
	1RB Middle (50)	2680	24.31	23.23	22.45
		2636.5	24.37	23.33	22.55
		2593	24.36	23.49	22.71
		2549.5	24.35	23.34	22.56



		2506	24.25	23.19	22.41
	1RB Low (0)	2680	24.42	23.35	22.57
		2636.5	24.45	23.29	22.51
		2593	24.45	23.58	22.80
		2549.5	24.34	23.32	22.54
		2506	24.24	23.32	22.54
		50RB High (50)	2680	23.36	22.37
	2636.5		23.41	22.45	21.67
	2593		23.52	22.54	21.76
	2549.5		23.44	22.41	21.63
	2506		23.34	22.42	21.64
	50RB Middle (25)	2680	23.44	22.42	21.64
		2636.5	23.45	22.43	21.65
		2593	23.45	22.50	21.72
		2549.5	23.45	22.44	21.66
		2506	23.37	22.41	21.63
	50RB Low (0)	2680	23.46	22.43	21.65
		2636.5	23.51	22.53	21.75
		2593	23.45	22.45	21.67
		2549.5	23.35	22.33	21.55
		2506	23.29	22.33	21.55
	100RB (0)	2680	23.46	22.42	21.64
		2636.5	23.47	22.44	21.66
		2593	23.43	22.41	21.63
		2549.5	23.43	22.44	21.66
		2506	23.40	22.40	21.62

Band 66					
Bandwidth (MHz)	RB allocation	Frequency (MHz)	QPSK	16QAM	64QAM
	RB offset (Start RB)		Actual output power (dBm)	Actual output power (dBm)	Actual output power (dBm)
1.4 MHz	1RB High (5)	1779.3	24.02	23.39	22.37
		1745	23.99	23.10	22.31
		1710.7	24.00	23.17	22.38
	1RB Middle (3)	1779.3	24.10	23.51	22.46
		1745	24.06	23.10	22.28
		1710.7	24.08	23.25	22.40
	1RB Low (0)	1779.3	24.04	23.43	22.39
		1745	24.01	23.09	22.29
		1710.7	23.99	23.19	22.18
	3RB High (3)	1779.3	23.95	23.21	22.37
		1745	23.99	23.23	22.24
		1710.7	24.00	23.13	22.22
	3RB Middle (1)	1779.3	23.98	23.30	22.35
		1745	24.01	23.30	22.41
		1710.7	24.03	23.21	22.24
	3RB Low (0)	1779.3	23.97	23.25	22.24
		1745	24.02	23.21	22.26
		1710.7	23.96	23.18	22.22
	6RB (0)	1779.3	23.02	21.99	21.19
		1745	23.02	22.24	21.28
		1710.7	23.08	22.29	21.33
3 MHz	1RB High (14)	1778.5	24.03	23.49	22.34
		1745	24.04	23.15	22.48
		1711.5	24.12	23.14	22.46
	1RB Middle (7)	1778.5	24.03	23.47	22.39
		1745	23.99	23.12	22.41
		1711.5	24.16	23.10	22.27
	1RB Low (0)	1778.5	24.02	23.47	22.50
		1745	23.96	23.12	22.40
		1711.5	24.14	23.19	22.23
	8RB High (7)	1778.5	23.08	22.20	21.28
		1745	23.09	22.16	21.33
		1711.5	23.17	22.31	21.37
	8RB Middle	1778.5	23.17	22.22	21.36
		1745	23.12	22.19	21.28

	(4)	1711.5	23.18	22.34	21.48	
	8RB Low (0)	1778.5	23.17	22.22	21.36	
		1745	23.07	22.12	21.21	
		1711.5	23.19	22.33	21.26	
	15RB (0)	1778.5	23.10	22.16	21.32	
		1745	23.10	22.07	21.21	
		1711.5	23.20	22.26	21.21	
	5 MHz	1RB High (24)	1777.5	24.09	23.22	22.39
			1745	23.95	23.62	22.54
1712.5			24.11	23.31	22.63	
1RB Middle (12)		1777.5	24.08	23.26	22.44	
		1745	24.00	23.62	22.50	
		1712.5	24.09	23.35	22.39	
1RB Low (0)		1777.5	24.10	23.26	22.41	
		1745	23.92	23.53	22.20	
		1712.5	24.10	23.30	22.22	
12RB High (13)		1777.5	23.01	22.13	21.30	
		1745	23.03	22.22	21.24	
		1712.5	23.11	22.20	21.38	
12RB Middle (6)		1777.5	23.08	22.20	21.40	
		1745	23.03	22.17	21.27	
		1712.5	23.17	22.25	21.41	
12RB Low (0)		1777.5	23.06	22.18	21.38	
		1745	22.97	22.11	21.24	
		1712.5	23.17	22.22	21.27	
25RB (0)		1777.5	23.10	22.10	21.27	
		1745	23.05	22.11	21.23	
		1712.5	23.15	22.11	21.20	
10 MHz		1RB High (49)	1775	24.05	23.12	22.38
			1745	24.04	23.43	22.19
			1715	23.98	23.00	22.65
	1RB Middle (24)	1775	24.01	22.99	22.38	
		1745	23.97	23.37	22.34	
		1715	23.97	23.08	22.45	
	1RB Low (0)	1775	23.97	23.09	21.75	
		1745	23.99	23.41	22.23	
		1715	23.93	23.10	22.61	
	25RB High (25)	1775	23.09	22.07	21.23	
		1745	23.04	22.10	21.31	
		1715	23.07	22.22	21.43	
	25RB Middle (12)	1775	23.03	22.05	21.23	
		1745	23.01	22.11	21.22	
		1715	23.17	22.23	21.34	
	25RB Low (0)	1775	23.05	22.02	20.97	
		1745	22.99	22.08	21.15	
		1715	23.10	22.19	21.27	
	50RB (0)	1775	22.99	21.98	21.21	
		1745	22.96	22.06	21.20	

15 MHz	1RB High (74)	1715	23.09	22.16	21.36	
		1772.5	23.97	23.28	22.58	
		1745	24.04	23.49	22.46	
	1RB Middle (37)	1717.5	24.12	23.61	22.26	
		1772.5	24.03	23.22	21.88	
		1745	24.09	23.49	22.47	
	1RB Low (0)	1717.5	24.12	23.64	22.47	
		1772.5	24.06	23.09	22.29	
		1745	24.02	23.46	22.20	
	36RB High (38)	1717.5	24.06	23.55	22.24	
		1772.5	23.12	22.11	21.28	
		1745	23.08	22.15	21.29	
	36RB Middle (19)	1717.5	23.14	22.15	21.41	
		1772.5	23.07	22.08	21.07	
		1745	23.03	22.11	21.27	
	36RB Low (0)	1717.5	23.18	22.15	21.39	
		1772.5	23.02	22.04	21.00	
		1745	23.03	22.08	21.22	
	75RB (0)	1717.5	23.17	22.15	21.29	
		1772.5	23.01	22.03	21.24	
		1745	22.98	22.06	21.19	
	20 MHz	1RB High (99)	1717.5	23.16	22.13	21.24
			1770	24.02	23.48	22.42
			1745	24.06	23.49	22.30
		1RB Middle (50)	1720	24.10	23.67	22.43
			1770	24.03	23.69	21.69
			1745	24.01	23.46	22.26
1RB Low (0)		1720	24.04	23.64	22.53	
		1770	24.07	23.58	22.42	
		1745	24.04	23.52	22.21	
50RB High (50)		1720	24.14	23.65	22.16	
		1770	23.14	22.16	21.33	
		1745	23.13	22.08	21.31	
50RB Middle (25)		1720	23.14	22.18	21.24	
		1770	23.09	22.09	21.06	
		1745	23.06	22.03	21.24	
50RB Low (0)		1720	23.21	22.20	21.37	
		1770	23.05	22.05	21.28	
		1745	23.07	22.01	21.32	
100RB (0)		1720	23.08	22.08	21.37	
		1770	23.04	22.06	21.21	
		1745	23.07	22.00	21.22	
			1720	23.15	22.22	21.34

**LTE in ENDC mode– Power Level A1**

Band 2					
Bandwidth (MHz)	RB allocation RB offset (Start RB)	Frequency (MHz)	QPSK	16QAM	64QAM
			Actual output power (dBm)	Actual output power (dBm)	Actual output power (dBm)
1.4 MHz	1RB High (5)	1909.3	18.29	18.25	17.84
		1880	18.27	18.24	17.90
		1850.7	18.27	18.16	18.06
	1RB Middle (3)	1909.3	18.27	18.10	18.05
		1880	18.24	18.12	18.02
		1850.7	18.21	18.23	17.94
	1RB Low (0)	1909.3	18.25	18.10	17.97
		1880	18.10	18.10	17.99
		1850.7	18.27	18.14	18.02
	3RB High (3)	1909.3	18.15	18.20	17.86
		1880	18.25	18.13	17.93
		1850.7	18.23	18.15	17.95
	3RB Middle (1)	1909.3	18.13	18.24	17.91
		1880	18.28	18.24	17.91
		1850.7	18.20	18.29	17.98
	3RB Low (0)	1909.3	18.27	18.27	17.86
		1880	18.19	18.19	17.92
		1850.7	18.16	18.29	17.91
	6RB (0)	1909.3	18.15	18.24	17.74
		1880	18.11	18.20	17.91
		1850.7	18.14	18.17	17.89
3 MHz	1RB High (14)	1908.5	18.16	18.28	18.04
		1880	18.11	18.20	18.07
		1851.5	18.27	18.16	17.89
	1RB Middle (7)	1908.5	18.20	18.28	18.08
		1880	18.25	18.13	18.17
		1851.5	18.29	18.19	18.10
	1RB Low (0)	1908.5	18.23	18.18	18.00
		1880	18.16	18.13	18.11
		1851.5	18.30	18.30	18.04
	8RB High (7)	1908.5	18.12	18.19	17.95
		1880	18.25	18.22	17.96
		1851.5	18.26	18.30	18.03
	8RB Middle (4)	1908.5	18.25	18.12	17.92
		1880	18.29	18.27	17.98
1851.5		18.23	18.23	18.02	
8RB	1908.5	18.28	18.29	17.83	

	Low (0)	1880	18.11	18.15	17.91	
		1851.5	18.10	18.10	18.02	
	15RB (0)	1908.5	18.28	18.20	17.86	
		1880	18.16	18.24	17.88	
		1851.5	18.29	18.23	17.96	
5 MHz	1RB High (24)	1907.5	18.04	18.34	17.97	
		1880	18.09	18.40	17.91	
		1852.5	18.14	18.72	17.96	
	1RB Middle (12)	1907.5	18.04	18.33	18.00	
		1880	18.09	18.36	18.05	
		1852.5	18.13	18.71	18.09	
	1RB Low (0)	1907.5	18.01	18.28	18.00	
		1880	17.99	18.28	17.94	
		1852.5	18.23	18.72	18.13	
	12RB High (13)	1907.5	18.13	18.22	17.86	
		1880	18.16	18.25	17.99	
		1852.5	18.20	18.36	18.01	
	12RB Middle (6)	1907.5	18.13	18.23	17.91	
		1880	18.09	18.19	17.99	
		1852.5	18.19	18.34	18.01	
	12RB Low (0)	1907.5	18.08	18.16	17.89	
		1880	18.08	18.18	17.88	
		1852.5	18.13	18.29	17.92	
	25RB (0)	1907.5	18.09	18.08	17.84	
		1880	18.08	18.12	17.91	
		1852.5	18.16	18.25	17.97	
	10 MHz	1RB High (49)	1905	18.03	18.03	18.09
			1880	18.13	18.54	18.06
			1855	18.08	18.09	18.41
		1RB Middle (24)	1905	18.04	17.99	18.03
			1880	18.08	18.52	17.99
			1855	18.01	18.12	18.07
		1RB Low (0)	1905	18.07	18.14	17.93
			1880	18.21	18.51	17.97
			1855	18.00	18.01	17.89
25RB High (25)		1905	18.14	18.19	17.97	
		1880	18.18	18.23	18.26	
		1855	18.18	18.27	18.01	
25RB Middle (12)		1905	18.07	18.10	17.91	
		1880	18.16	18.20	17.92	
		1855	18.16	18.27	17.91	
25RB Low (0)		1905	18.04	18.08	17.77	
		1880	18.09	18.11	17.84	
		1855	18.13	18.30	17.99	
50RB (0)		1905	18.05	18.06	17.91	
		1880	18.18	18.18	17.93	
		1855	18.09	18.28	17.95	
15 MHz		1RB	1902.5	18.13	18.59	18.08

	High (74)	1880	18.03	18.03	18.06	
		1857.5	18.14	18.57	18.01	
	1RB Middle (37)	1902.5	18.09	18.76	17.88	
		1880	18.11	18.09	18.07	
	1RB Low (0)	1857.5	18.12	18.55	18.04	
		1902.5	18.18	18.60	18.16	
		1880	18.08	18.04	18.04	
	36RB High (38)	1857.5	18.09	18.53	17.95	
		1902.5	18.16	18.18	17.98	
		1880	18.22	18.23	17.97	
	36RB Middle (19)	1857.5	18.27	18.22	17.87	
		1902.5	18.19	18.12	17.96	
		1880	18.12	18.15	17.93	
	36RB Low (0)	1857.5	18.19	18.28	17.89	
		1902.5	18.05	18.03	17.88	
		1880	18.03	18.06	17.88	
	75RB (0)	1857.5	18.19	18.23	17.92	
		1902.5	18.04	18.08	17.88	
		1880	18.09	18.08	17.94	
	20 MHz	1RB High (99)	1857.5	18.18	18.19	17.94
			1900	18.30	18.96	17.89
			1880	18.31	18.74	18.04
		1RB Middle (50)	1860	18.34	18.70	17.95
			1900	18.36	18.72	17.94
1880			18.31	18.73	18.12	
1RB Low (0)		1860	18.32	18.83	18.05	
		1900	18.33	18.85	17.97	
		1880	18.36	18.73	18.06	
50RB High (50)		1860	18.33	18.95	17.94	
		1900	18.47	18.47	17.87	
		1880	18.47	18.42	17.97	
50RB Middle (25)		1860	18.51	18.51	18.06	
		1900	18.44	18.51	17.91	
		1880	18.41	18.36	17.92	
50RB Low (0)		1860	18.51	18.51	17.99	
		1900	18.33	18.39	17.81	
		1880	18.36	18.30	17.93	
100RB (0)		1860	18.36	18.40	17.87	
		1900	18.35	18.40	17.92	
		1880	18.38	18.39	17.87	
			1860	18.46	18.48	17.90

Band 12						
Bandwidth (MHz)	RB allocation	Frequency (MHz)	QPSK	16QAM	64QAM	
	RB offset (Start RB)		Actual output power (dBm)	Actual output power (dBm)	Actual output power (dBm)	
1.4 MHz	1RB High (5)	715.3	17.65	17.86	17.71	
		707.5	17.77	17.96	17.70	
		699.7	17.67	18.19	17.72	
	1RB Middle (3)	715.3	17.75	17.89	17.89	
		707.5	17.85	18.01	17.85	
		699.7	17.79	18.20	17.78	
	1RB Low (0)	715.3	17.70	17.86	17.83	
		707.5	17.78	17.91	17.71	
		699.7	17.74	18.21	17.75	
	3RB High (3)	715.3	17.68	17.94	17.63	
		707.5	17.73	17.87	17.60	
		699.7	17.73	17.93	17.61	
	3RB Middle (1)	715.3	17.74	18.07	17.75	
		707.5	17.70	17.89	17.77	
		699.7	17.78	18.04	17.78	
	3RB Low (0)	715.3	17.66	17.96	17.70	
		707.5	17.70	17.87	17.70	
		699.7	17.75	18.01	17.65	
	6RB (0)	715.3	17.78	17.98	17.56	
		707.5	17.79	17.94	17.58	
		699.7	17.82	17.70	17.54	
	3 MHz	1RB High (14)	714.5	17.75	17.83	17.64
			707.5	17.85	17.81	17.88
			700.5	17.77	18.20	17.82
		1RB Middle (7)	714.5	17.76	17.90	17.86
			707.5	17.80	17.82	17.81
			700.5	17.83	18.23	17.84
1RB Low (0)		714.5	17.82	17.97	18.05	
		707.5	17.85	17.86	17.89	
		700.5	17.85	18.34	17.93	
8RB High (7)		714.5	17.84	17.93	17.70	
		707.5	17.91	18.02	17.74	
		700.5	17.82	17.91	17.17	
8RB Middle (4)		714.5	17.91	17.96	17.71	
		707.5	17.93	18.12	17.72	
		700.5	17.87	17.98	17.71	
8RB Low (0)		714.5	17.85	17.94	17.71	
		707.5	17.91	18.01	17.80	
		700.5	17.87	18.02	17.73	



	15RB (0)	714.5	17.82	17.80	17.60	
		707.5	17.87	17.92	17.65	
		700.5	17.85	17.93	17.66	
5 MHz	1RB High (24)	713.5	17.84	18.01	17.79	
		707.5	18.00	18.10	17.99	
		701.5	17.71	18.42	17.98	
	1RB Middle (12)	713.5	17.88	18.11	17.86	
		707.5	17.94	18.07	17.85	
		701.5	17.73	18.38	17.74	
	1RB Low (0)	713.5	17.88	17.98	17.97	
		707.5	17.99	18.10	17.85	
		701.5	17.77	18.46	17.91	
	12RB High (13)	713.5	17.84	17.93	17.69	
		707.5	17.93	18.00	17.75	
		701.5	17.83	18.01	17.65	
	12RB Middle (6)	713.5	17.91	17.99	17.67	
		707.5	17.91	17.98	17.74	
		701.5	17.85	18.05	17.80	
	12RB Low (0)	713.5	17.90	17.98	17.78	
		707.5	18.08	17.99	17.78	
		701.5	17.89	18.07	17.75	
	25RB (0)	713.5	17.89	17.86	17.69	
		707.5	17.88	17.90	17.70	
		701.5	17.88	17.96	17.73	
	10 MHz	1RB High (49)	711	17.73	17.87	17.69
			707.5	17.99	17.81	17.95
			704	17.97	18.37	17.86
1RB Middle (24)		711	17.84	17.96	17.77	
		707.5	17.90	17.84	17.73	
		704	17.85	18.24	17.79	
1RB Low (0)		711	17.78	17.96	17.94	
		707.5	17.87	17.80	18.00	
		704	17.91	18.28	17.89	
25RB High (25)		711	17.95	18.04	17.83	
		707.5	17.97	18.03	17.79	
		704	17.95	18.01	17.65	
25RB Middle (12)		711	17.95	18.06	17.79	
		707.5	17.94	18.00	17.80	
		704	18.01	18.05	17.76	
25RB Low (0)		711	17.95	18.02	17.73	
		707.5	17.95	18.00	17.70	
		704	17.90	17.99	17.64	
50RB (0)		711	17.93	17.99	17.79	
		707.5	17.95	17.94	17.72	
		704	18.00	18.02	17.83	

Band 66						
Bandwidth (MHz)	RB allocation	Frequency (MHz)	QPSK	16QAM	64QAM	
	RB offset (Start RB)		Actual output power (dBm)	Actual output power (dBm)	Actual output power (dBm)	
1.4 MHz	1RB High (5)	1779.3	18.27	18.42	17.92	
		1745	18.23	18.68	17.88	
		1710.7	18.26	18.42	17.96	
	1RB Middle (3)	1779.3	18.32	18.44	18.06	
		1745	18.34	18.79	17.94	
		1710.7	18.34	18.48	18.05	
	1RB Low (0)	1779.3	18.28	18.40	17.97	
		1745	18.25	18.70	18.00	
		1710.7	18.25	18.40	18.06	
	3RB High (3)	1779.3	18.21	18.34	17.91	
		1745	18.26	18.49	17.77	
		1710.7	18.26	18.54	17.81	
	3RB Middle (1)	1779.3	18.26	18.37	17.86	
		1745	18.29	18.54	18.01	
		1710.7	18.31	18.61	17.91	
	3RB Low (0)	1779.3	18.21	18.34	17.95	
		1745	18.29	18.51	17.87	
		1710.7	18.25	18.57	17.84	
	6RB (0)	1779.3	18.33	18.43	17.91	
		1745	18.33	18.24	17.88	
		1710.7	18.37	18.57	17.81	
	3 MHz	1RB High (14)	1778.5	18.32	18.27	18.04
			1745	18.39	18.75	18.02
			1711.5	18.35	18.42	18.09
		1RB Middle (7)	1778.5	18.27	18.39	17.96
			1745	18.36	18.74	17.97
			1711.5	18.36	18.46	17.95
1RB Low (0)		1778.5	18.33	18.45	18.05	
		1745	18.31	18.72	18.00	
		1711.5	18.36	18.52	18.09	
8RB High (7)		1778.5	18.38	18.47	17.91	
		1745	18.41	18.47	17.98	
		1711.5	18.47	18.47	17.95	
8RB Middle (4)		1778.5	18.43	18.50	17.91	
		1745	18.42	18.48	17.97	
		1711.5	18.50	18.54	17.95	
8RB Low (0)		1778.5	18.42	18.50	17.90	
		1745	18.37	18.43	17.85	
		1711.5	18.47	18.49	17.95	

	15RB (0)	1778.5	18.44	18.43	17.93	
		1745	18.40	18.43	17.84	
		1711.5	18.46	18.41	17.92	
5 MHz	1RB High (24)	1777.5	18.38	18.54	17.98	
		1745	18.31	18.91	17.95	
		1712.5	18.44	18.64	17.96	
	1RB Middle (12)	1777.5	18.36	18.60	18.02	
		1745	18.31	18.91	18.01	
		1712.5	18.46	18.67	17.98	
	1RB Low (0)	1777.5	18.43	18.61	17.86	
		1745	18.19	18.90	18.08	
		1712.5	18.46	18.58	18.12	
	12RB High (13)	1777.5	18.36	18.48	17.93	
		1745	18.38	18.52	17.91	
		1712.5	18.44	18.48	17.90	
	12RB Middle (6)	1777.5	18.40	18.53	17.98	
		1745	18.36	18.48	17.95	
		1712.5	18.51	18.52	17.92	
	12RB Low (0)	1777.5	18.40	18.50	17.95	
		1745	18.35	18.48	17.93	
		1712.5	18.47	18.53	17.94	
	25RB (0)	1777.5	18.43	18.41	17.86	
		1745	18.42	18.47	17.90	
		1712.5	18.47	18.40	17.87	
	10 MHz	1RB High (49)	1775	18.45	18.29	18.03
			1745	18.37	18.70	18.03
			1715	18.16	18.65	17.81
1RB Middle (24)		1775	18.36	18.28	17.98	
		1745	18.33	18.70	17.92	
		1715	18.27	18.39	17.94	
1RB Low (0)		1775	18.36	18.30	17.95	
		1745	18.37	18.76	17.91	
		1715	18.46	18.47	18.23	
25RB High (25)		1775	18.44	18.44	17.92	
		1745	18.40	18.48	17.95	
		1715	18.41	18.53	17.84	
25RB Middle (12)		1775	18.38	18.39	17.94	
		1745	18.37	18.42	17.83	
		1715	18.46	18.52	17.93	
25RB Low (0)		1775	18.38	18.37	17.79	
		1745	18.36	18.40	17.91	
		1715	18.42	18.54	17.86	
50RB (0)		1775	18.35	18.27	17.80	
		1745	18.29	18.36	17.86	
		1715	18.44	18.48	17.90	
15 MHz		1RB High (74)	1772.5	18.35	18.90	17.89
			1745	18.40	18.33	17.97
			1717.5	18.44	18.80	18.14

	1RB Middle (37)	1772.5	18.37	18.89	18.00	
		1745	18.32	18.33	18.14	
		1717.5	18.39	18.79	17.74	
	1RB Low (0)	1772.5	18.40	18.85	17.95	
		1745	18.32	18.23	17.87	
		1717.5	18.38	18.76	18.05	
	36RB High (38)	1772.5	18.39	18.38	17.92	
		1745	18.40	18.37	17.96	
		1717.5	18.49	18.51	17.89	
	36RB Middle (19)	1772.5	18.37	18.33	17.84	
		1745	18.34	18.33	17.89	
		1717.5	18.50	18.50	17.85	
	36RB Low (0)	1772.5	18.29	18.29	17.79	
		1745	18.30	18.28	17.90	
		1717.5	18.45	18.46	17.90	
	75RB (0)	1772.5	18.32	18.32	17.92	
		1745	18.33	18.28	17.89	
		1717.5	18.42	18.46	17.89	
	<b>20 MHz</b>	1RB High (99)	1770	18.34	18.76	17.93
			1745	18.33	18.76	18.04
			1720	18.41	18.94	18.13
		1RB Middle (50)	1770	18.35	18.81	17.89
			1745	18.30	18.74	17.91
			1720	18.39	18.95	17.92
		1RB Low (0)	1770	18.37	18.92	18.01
			1745	18.42	18.80	18.13
			1720	18.46	18.91	18.09
50RB High (50)		1770	18.45	18.44	17.89	
		1745	18.48	18.42	17.94	
		1720	18.54	18.51	17.92	
50RB Middle (25)		1770	18.40	18.40	17.96	
		1745	18.41	18.33	17.96	
		1720	18.56	18.57	17.99	
50RB Low (0)		1770	18.39	18.38	17.88	
		1745	18.39	18.38	17.92	
		1720	18.47	18.47	17.86	
100RB (0)		1770	18.41	18.39	17.96	
		1745	18.41	18.42	17.87	
		1720	18.52	18.52	17.88	

## LTE in ENDC mode– Power Level B1

Band 2					
Bandwidth (MHz)	RB allocation	Frequency (MHz)	QPSK	16QAM	64QAM
	RB offset (Start RB)		Actual output power (dBm)	Actual output power (dBm)	Actual output power (dBm)
1.4 MHz	1RB High (5)	1909.3	18.20	18.36	17.89
		1880	18.37	18.49	17.91
		1850.7	18.34	18.76	17.84
	1RB Middle (3)	1909.3	18.25	18.40	17.95
		1880	18.41	18.54	18.07
		1850.7	18.40	18.80	18.07
	1RB Low (0)	1909.3	18.16	18.32	17.90
		1880	18.34	18.49	17.89
		1850.7	18.34	18.73	17.93
	3RB High (3)	1909.3	18.22	18.51	17.91
		1880	18.27	18.48	17.88
		1850.7	18.36	18.56	17.90
	3RB Middle (1)	1909.3	18.26	18.52	17.86
		1880	18.33	18.51	18.14
		1850.7	18.37	18.53	18.04
	3RB Low (0)	1909.3	18.19	18.49	17.91
		1880	18.26	18.41	17.95
		1850.7	18.36	18.60	17.87
	6RB (0)	1909.3	18.28	18.48	17.83
		1880	18.37	18.53	17.78
		1850.7	18.41	18.32	17.86
3 MHz	1RB High (14)	1908.5	18.29	18.44	17.93
		1880	18.37	18.42	18.11
		1851.5	18.43	18.86	18.10
	1RB Middle (7)	1908.5	18.24	18.36	18.03
		1880	18.36	18.34	18.09
		1851.5	18.44	18.82	18.05
	1RB Low (0)	1908.5	18.28	18.39	17.91
		1880	18.27	18.39	18.16
		1851.5	18.41	18.80	18.04
	8RB High (7)	1908.5	18.40	18.44	17.87
		1880	18.45	18.57	17.94
		1851.5	18.47	18.58	18.03
	8RB Middle (4)	1908.5	18.40	18.46	17.98
		1880	18.47	18.57	18.02
		1851.5	18.47	18.59	17.95
	8RB Low (0)	1908.5	18.34	18.46	17.91
		1880	18.41	18.53	17.92
		1851.5	18.43	18.55	18.03

	15RB (0)	1908.5	18.38	18.35	17.88	
		1880	18.39	18.47	17.90	
		1851.5	18.46	18.54	17.87	
5 MHz	1RB High (24)	1907.5	18.42	18.64	18.00	
		1880	18.49	18.67	18.14	
		1852.5	18.44	18.63	17.92	
	1RB Middle (12)	1907.5	18.34	18.59	17.96	
		1880	18.42	18.68	18.22	
		1852.5	18.37	18.81	17.90	
	1RB Low (0)	1907.5	18.37	18.50	18.00	
		1880	18.41	18.60	18.09	
		1852.5	18.30	18.67	18.11	
	12RB High (13)	1907.5	18.39	18.52	17.99	
		1880	18.48	18.55	18.00	
		1852.5	18.47	18.64	18.01	
	12RB Middle (6)	1907.5	18.43	18.49	17.96	
		1880	18.41	18.54	17.90	
		1852.5	18.51	18.64	17.96	
	12RB Low (0)	1907.5	18.35	18.45	17.96	
		1880	18.38	18.47	17.87	
		1852.5	18.48	18.62	17.99	
	25RB (0)	1907.5	18.42	18.37	17.90	
		1880	18.40	18.45	17.85	
		1852.5	18.49	18.55	17.94	
	10 MHz	1RB High (49)	1905	18.23	18.36	17.87
			1880	18.44	18.37	18.18
			1855	18.42	18.84	18.08
		1RB Middle (24)	1905	18.22	18.37	17.93
			1880	18.32	18.36	18.10
			1855	18.36	18.84	17.92
1RB Low (0)		1905	18.19	18.41	18.02	
		1880	18.45	18.09	17.86	
		1855	18.48	18.83	18.02	
25RB High (25)		1905	18.43	18.56	17.91	
		1880	18.49	18.51	18.04	
		1855	18.49	18.54	18.10	
25RB Middle (12)		1905	18.34	18.44	17.94	
		1880	18.45	18.44	17.88	
		1855	18.49	18.56	18.03	
25RB Low (0)		1905	18.31	18.41	17.80	
		1880	18.40	18.40	17.88	
		1855	18.43	18.54	17.98	
50RB (0)		1905	18.34	18.40	17.91	
		1880	18.36	18.39	17.93	
		1855	18.48	18.52	17.99	
15 MHz		1RB High (74)	1902.5	18.33	18.41	17.97
			1880	18.41	18.77	17.92
			1857.5	18.42	18.81	17.93

	1RB Middle (37)	1902.5	18.44	18.48	17.98	
		1880	18.36	18.82	18.15	
		1857.5	18.40	18.98	18.08	
	1RB Low (0)	1902.5	18.42	18.41	18.03	
		1880	18.36	18.84	17.93	
		1857.5	18.37	18.75	17.91	
	36RB High (38)	1902.5	18.51	18.48	17.97	
		1880	18.53	18.57	18.09	
		1857.5	18.55	18.51	17.99	
	36RB Middle (19)	1902.5	18.45	18.48	18.00	
		1880	18.44	18.49	17.89	
		1857.5	18.54	18.47	17.91	
	36RB Low (0)	1902.5	18.35	18.36	17.79	
		1880	18.39	18.44	17.89	
		1857.5	18.48	18.42	17.95	
	75RB (0)	1902.5	18.38	18.36	17.78	
		1880	18.40	18.48	17.86	
		1857.5	18.48	18.47	17.92	
	20 MHz	1RB High (99)	1900	18.31	18.87	17.80
			1880	18.33	18.76	17.97
			1860	18.34	18.99	17.98
		1RB Middle (50)	1900	18.44	18.73	17.79
			1880	18.26	18.72	18.09
			1860	18.34	18.83	17.88
		1RB Low (0)	1900	18.35	18.82	18.00
			1880	18.30	18.69	17.98
			1860	18.27	18.92	17.99
50RB High (50)		1900	18.43	18.45	17.99	
		1880	18.48	18.40	17.97	
		1860	18.54	18.51	17.95	
50RB Middle (25)		1900	18.45	18.47	17.98	
		1880	18.38	18.36	17.88	
		1860	18.52	18.51	17.96	
50RB Low (0)		1900	18.33	18.37	17.81	
		1880	18.34	18.31	17.96	
		1860	18.36	18.37	17.93	
100RB (0)		1900	18.40	18.42	17.89	
		1880	18.34	18.42	17.93	
		1860	18.44	18.52	17.88	

Band 12						
Bandwidth (MHz)	RB allocation	Frequency (MHz)	QPSK	16QAM	64QAM	
	RB offset (Start RB)		Actual output power (dBm)	Actual output power (dBm)	Actual output power (dBm)	
1.4 MHz	1RB High (5)	715.3	17.65	17.82	17.48	
		707.5	17.79	17.94	17.65	
		699.7	17.71	18.15	17.63	
	1RB Middle (3)	715.3	17.75	17.87	17.68	
		707.5	17.87	18.03	17.70	
		699.7	17.78	18.21	17.69	
	1RB Low (0)	715.3	17.73	17.88	17.67	
		707.5	17.76	17.91	17.60	
		699.7	17.74	18.21	17.57	
	3RB High (3)	715.3	17.69	17.95	17.54	
		707.5	17.76	17.91	17.55	
		699.7	17.71	17.95	17.48	
	3RB Middle (1)	715.3	17.73	18.04	17.54	
		707.5	17.72	17.86	17.56	
		699.7	17.80	18.04	17.49	
	3RB Low (0)	715.3	17.66	18.00	17.49	
		707.5	17.69	17.83	17.52	
		699.7	17.78	17.96	17.50	
	6RB (0)	715.3	17.81	17.97	17.37	
		707.5	17.80	17.97	17.43	
		699.7	17.77	17.70	17.37	
	3 MHz	1RB High (14)	714.5	17.72	17.83	17.63
			707.5	17.86	17.85	17.71
			700.5	17.79	18.18	17.53
		1RB Middle (7)	714.5	17.75	17.89	17.78
			707.5	17.81	17.83	17.65
			700.5	17.82	18.22	17.62
1RB Low (0)		714.5	17.83	17.95	17.69	
		707.5	17.80	17.85	17.78	
		700.5	17.88	18.33	17.70	
8RB High (7)		714.5	17.85	17.90	17.43	
		707.5	17.87	18.04	17.55	
		700.5	17.86	17.93	17.52	
8RB Middle (4)		714.5	17.92	17.99	17.54	
		707.5	17.97	18.04	17.54	
		700.5	17.90	18.00	17.52	
8RB Low (0)		714.5	17.86	17.92	17.49	
		707.5	17.91	18.03	17.63	
		700.5	17.91	18.02	17.57	
15RB		714.5	17.85	17.81	17.45	



	(0)	707.5	17.88	17.90	17.56	
		700.5	17.87	17.97	17.49	
5 MHz	1RB High (24)	713.5	17.78	18.45	17.71	
		707.5	17.95	18.13	17.85	
		701.5	17.95	18.06	17.72	
	1RB Middle (12)	713.5	17.82	18.41	17.77	
		707.5	17.90	18.04	17.65	
		701.5	17.89	18.04	17.67	
	1RB Low (0)	713.5	17.78	18.44	17.51	
		707.5	17.90	18.07	17.75	
		701.5	17.96	18.08	17.61	
	12RB High (13)	713.5	17.88	18.01	17.53	
		707.5	17.94	17.97	17.50	
		701.5	17.81	17.95	17.51	
	12RB Middle (6)	713.5	17.93	18.06	17.53	
		707.5	17.91	17.97	17.61	
		701.5	17.90	17.99	17.55	
	12RB Low (0)	713.5	17.89	18.05	17.55	
		707.5	17.91	17.98	17.63	
		701.5	17.89	17.99	17.64	
	25RB (0)	713.5	17.90	18.03	17.51	
		707.5	17.91	17.86	17.48	
		701.5	17.87	17.92	17.50	
	10 MHz	1RB High (49)	711	17.74	17.84	17.55
			707.5	17.98	17.85	17.72
			704	17.95	18.34	17.61
1RB Middle (24)		711	17.81	17.86	17.70	
		707.5	17.91	17.84	17.51	
		704	17.89	18.24	17.53	
1RB Low (0)		711	17.82	17.96	17.68	
		707.5	17.88	17.80	17.63	
		704	17.88	18.29	17.76	
25RB High (25)		711	17.97	18.08	17.55	
		707.5	17.96	18.02	17.54	
		704	17.94	18.07	17.50	
25RB Middle (12)		711	17.93	18.04	17.60	
		707.5	17.97	17.98	17.57	
		704	17.99	18.01	17.55	
25RB Low (0)		711	17.96	18.05	17.60	
		707.5	17.97	18.04	17.47	
		704	17.94	17.96	17.51	
50RB (0)		711	17.93	17.99	17.62	
		707.5	17.93	17.93	17.41	
		704	17.97	18.02	17.60	

Band 66						
Bandwidth (MHz)	RB allocation	Frequency (MHz)	QPSK	16QAM	64QAM	
	RB offset (Start RB)		Actual output power (dBm)	Actual output power (dBm)	Actual output power (dBm)	
1.4 MHz	1RB High (5)	1779.3	18.28	18.43	17.91	
		1745	18.27	18.71	17.94	
		1710.7	18.26	18.44	18.00	
	1RB Middle (3)	1779.3	18.37	18.47	18.11	
		1745	18.34	18.74	17.98	
		1710.7	18.36	18.47	18.02	
	1RB Low (0)	1779.3	18.35	18.42	18.11	
		1745	18.29	18.75	17.99	
		1710.7	18.28	18.42	18.01	
	3RB High (3)	1779.3	18.27	18.35	17.96	
		1745	18.29	18.50	17.89	
		1710.7	18.29	18.55	17.90	
	3RB Middle (1)	1779.3	18.27	18.39	17.76	
		1745	18.33	18.57	18.02	
		1710.7	18.33	18.61	17.93	
	3RB Low (0)	1779.3	18.23	18.33	17.95	
		1745	18.29	18.53	17.95	
		1710.7	18.27	18.58	17.90	
	6RB (0)	1779.3	18.33	18.46	17.85	
		1745	18.33	18.27	17.85	
		1710.7	18.41	18.58	17.83	
	3 MHz	1RB High (14)	1778.5	18.33	18.28	18.03
			1745	18.38	18.80	18.02
			1711.5	18.36	18.47	18.01
1RB Middle (7)		1778.5	18.30	18.41	17.99	
		1745	18.42	18.76	17.96	
		1711.5	18.35	18.48	17.98	
1RB Low (0)		1778.5	18.33	18.45	18.13	
		1745	18.33	18.72	18.02	
		1711.5	18.39	18.53	17.98	
8RB High (7)		1778.5	18.38	18.51	17.96	
		1745	18.41	18.48	17.94	
		1711.5	18.49	18.49	17.92	
8RB Middle (4)		1778.5	18.42	18.50	17.95	
		1745	18.41	18.54	17.98	
		1711.5	18.47	18.56	17.97	
8RB Low (0)		1778.5	18.46	18.53	17.85	
		1745	18.37	18.43	17.86	
		1711.5	18.48	18.50	17.89	
15RB	1778.5	18.43	18.42	17.81		

	(0)	1745	18.40	18.49	17.82	
		1711.5	18.49	18.45	17.87	
5 MHz	1RB High (24)	1777.5	18.34	18.53	18.12	
		1745	18.29	18.99	18.01	
		1712.5	18.46	18.66	17.97	
		1777.5	18.43	18.60	18.06	
	1RB Middle (12)	1745	18.35	18.99	17.98	
		1712.5	18.48	18.66	17.95	
		1777.5	18.47	18.60	18.06	
	1RB Low (0)	1745	18.22	18.91	17.91	
		1712.5	18.46	18.67	18.02	
		1777.5	18.38	18.49	17.97	
	12RB High (13)	1745	18.42	18.52	17.93	
		1712.5	18.44	18.48	17.86	
		1777.5	18.40	18.55	17.89	
	12RB Middle (6)	1745	18.41	18.51	17.95	
		1712.5	18.52	18.54	18.00	
		1777.5	18.40	18.51	17.92	
	12RB Low (0)	1745	18.38	18.51	17.88	
		1712.5	18.44	18.52	17.88	
		1777.5	18.40	18.43	17.88	
	25RB (0)	1745	18.43	18.47	17.86	
		1712.5	18.49	18.39	17.93	
		1775	18.45	18.08	17.93	
	10 MHz	1RB High (49)	1745	18.34	18.76	18.23
			1715	18.18	18.44	17.68
1775			18.41	18.34	18.04	
1RB Middle (24)		1745	18.36	18.74	17.91	
		1715	18.31	18.40	17.99	
		1775	18.40	18.39	18.05	
1RB Low (0)		1745	18.33	18.79	18.00	
		1715	18.35	18.41	18.00	
		1775	18.39	18.42	17.93	
25RB High (25)		1745	18.41	18.44	17.85	
		1715	18.45	18.52	17.95	
		1775	18.38	18.35	17.76	
25RB Middle (12)		1745	18.36	18.37	17.93	
		1715	18.48	18.54	17.94	
		1775	18.33	18.37	17.82	
25RB Low (0)		1745	18.32	18.41	17.88	
		1715	18.40	18.51	17.89	
		1775	18.36	18.33	17.78	
50RB (0)		1745	18.28	18.39	17.85	
		1715	18.45	18.47	17.83	
		1772.5	18.38	18.99	17.87	
15 MHz		1RB High (74)	1745	18.41	18.34	17.93
			1717.5	18.46	18.83	18.21
			1772.5	18.40	18.95	17.96
	1RB	1772.5	18.40	18.95	17.96	

	Middle (37)	1745	18.42	18.39	18.08	
		1717.5	18.47	18.84	17.87	
	1RB Low (0)	1772.5	18.48	18.90	17.94	
		1745	18.35	18.31	17.90	
		1717.5	18.39	18.76	17.98	
	36RB High (38)	1772.5	18.47	18.41	17.96	
		1745	18.45	18.45	17.94	
		1717.5	18.55	18.52	17.96	
	36RB Middle (19)	1772.5	18.44	18.34	17.91	
		1745	18.40	18.40	17.92	
		1717.5	18.53	18.58	17.94	
	36RB Low (0)	1772.5	18.38	18.34	17.86	
		1745	18.37	18.33	17.93	
		1717.5	18.48	18.52	17.89	
	75RB (0)	1772.5	18.36	18.36	17.89	
		1745	18.37	18.33	17.85	
		1717.5	18.48	18.49	17.90	
	<b>20 MHz</b>	1RB High (99)	1770	18.40	18.81	18.08
			1745	18.43	18.78	18.11
			1720	18.42	18.96	18.20
		1RB Middle (50)	1770	18.34	18.80	17.96
			1745	18.35	18.78	18.08
			1720	18.39	18.97	18.13
		1RB Low (0)	1770	18.43	18.92	18.18
			1745	18.43	18.84	18.04
			1720	18.47	18.92	17.91
		50RB High (50)	1770	18.42	18.42	17.94
1745			18.49	18.43	17.98	
1720			18.52	18.53	17.91	
50RB Middle (25)		1770	18.38	18.41	18.01	
		1745	18.41	18.36	17.89	
		1720	18.56	18.54	17.94	
50RB Low (0)		1770	18.39	18.38	17.94	
		1745	18.43	18.35	17.93	
		1720	18.45	18.42	17.90	
100RB (0)		1770	18.37	18.36	17.94	
		1745	18.42	18.40	17.88	
		1720	18.54	18.55	17.94	

**LTE in ENDC mode– Power Level C1**

Band 2						
Bandwidth (MHz)	RB allocation RB offset (Start RB)	Frequency (MHz)	QPSK	16QAM	64QAM	
			Actual output power (dBm)	Actual output power (dBm)	Actual output power (dBm)	
1.4 MHz	1RB High (5)	1909.3	20.03	20.09	17.93	
		1880	20.05	20.19	17.85	
		1850.7	20.04	20.48	17.87	
	1RB Middle (3)	1909.3	19.99	20.13	18.04	
		1880	20.09	20.28	17.97	
		1850.7	20.10	20.54	18.01	
	1RB Low (0)	1909.3	19.91	20.04	18.00	
		1880	20.09	20.19	18.08	
		1850.7	20.02	20.46	18.03	
	3RB High (3)	1909.3	19.95	20.21	17.93	
		1880	19.99	20.19	18.01	
		1850.7	20.01	20.29	18.02	
	3RB Middle (1)	1909.3	19.95	20.23	17.92	
		1880	20.05	20.20	18.16	
		1850.7	20.08	20.37	17.97	
	3RB Low (0)	1909.3	19.88	20.18	17.92	
		1880	19.99	20.15	17.94	
		1850.7	20.05	20.31	18.06	
	6RB (0)	1909.3	20.02	20.23	17.74	
		1880	20.05	20.25	17.81	
		1850.7	20.10	20.04	17.80	
	3 MHz	1RB High (14)	1908.5	20.05	20.20	18.10
			1880	20.17	20.20	18.08
			1851.5	20.13	20.62	18.06
		1RB Middle (7)	1908.5	19.98	20.18	18.09
			1880	20.08	20.18	17.91
			1851.5	20.15	20.56	17.93
1RB Low (0)		1908.5	20.01	20.21	18.05	
		1880	20.03	20.13	17.93	
		1851.5	20.12	20.57	18.10	
8RB High (7)		1908.5	20.11	20.17	17.91	
		1880	20.19	20.31	18.04	
		1851.5	20.22	20.29	18.03	
8RB Middle (4)		1908.5	20.13	20.20	17.98	
		1880	20.19	20.32	18.00	
		1851.5	20.20	20.33	18.09	
8RB Low (0)		1908.5	20.08	20.17	17.94	
		1880	20.10	20.23	17.95	
		1851.5	20.13	20.29	18.01	
15RB		1908.5	20.13	20.09	17.93	

	(0)	1880	20.14	20.15	17.85	
		1851.5	20.20	20.26	17.91	
5 MHz	1RB High (24)	1907.5	20.11	20.32	18.08	
		1880	20.23	20.41	18.17	
		1852.5	20.12	20.77	18.06	
	1RB Middle (12)	1907.5	20.10	20.31	18.19	
		1880	20.22	20.35	18.18	
		1852.5	20.10	20.64	18.09	
	1RB Low (0)	1907.5	20.07	20.32	18.06	
		1880	20.14	20.29	18.28	
		1852.5	20.04	20.75	18.12	
	12RB High (13)	1907.5	20.12	20.20	17.99	
		1880	20.19	20.28	18.08	
		1852.5	20.16	20.33	18.04	
	12RB Middle (6)	1907.5	20.18	20.21	18.02	
		1880	20.13	20.25	18.02	
		1852.5	20.17	20.34	18.09	
	12RB Low (0)	1907.5	20.11	20.19	17.99	
		1880	20.07	20.20	17.98	
		1852.5	20.11	20.31	18.06	
	25RB (0)	1907.5	20.12	20.10	17.96	
		1880	20.10	20.15	17.92	
		1852.5	20.16	20.25	18.04	
	10 MHz	1RB High (49)	1905	19.90	20.13	18.13
			1880	20.15	20.10	18.12
			1855	20.16	20.52	18.16
1RB Middle (24)		1905	19.96	20.12	18.08	
		1880	20.06	20.09	18.01	
		1855	20.08	20.56	18.15	
1RB Low (0)		1905	19.94	20.15	17.89	
		1880	20.09	19.93	17.94	
		1855	20.14	20.46	18.02	
25RB High (25)		1905	20.17	20.25	18.04	
		1880	20.23	20.26	18.06	
		1855	20.21	20.25	18.01	
25RB Middle (12)		1905	20.10	20.15	18.00	
		1880	20.17	20.17	17.98	
		1855	20.17	20.25	17.90	
25RB Low (0)		1905	20.07	20.17	17.95	
		1880	20.13	20.13	17.91	
		1855	20.15	20.26	18.02	
50RB (0)		1905	20.08	20.13	17.92	
		1880	20.15	20.07	17.96	
		1855	20.20	20.25	18.00	
15 MHz		1RB High (74)	1902.5	20.08	20.48	18.16
			1880	20.12	20.62	18.11
			1857.5	20.14	20.13	18.03
	1RB	1902.5	20.13	20.54	18.22	

	Middle (37)	1880	20.14	20.75	18.06	
		1857.5	20.11	20.10	17.97	
	1RB Low (0)	1902.5	20.11	20.51	18.13	
		1880	20.12	20.69	17.94	
		1857.5	20.08	20.19	18.13	
	36RB High (38)	1902.5	20.19	20.25	18.04	
		1880	20.24	20.22	18.06	
		1857.5	20.22	20.24	18.04	
	36RB Middle (19)	1902.5	20.18	20.25	18.01	
		1880	20.12	20.15	17.98	
		1857.5	20.22	20.22	18.06	
	36RB Low (0)	1902.5	20.10	20.12	18.02	
		1880	20.10	20.11	17.97	
		1857.5	20.15	20.16	18.06	
	75RB (0)	1902.5	20.09	20.12	17.87	
		1880	20.10	20.12	17.99	
		1857.5	20.19	20.17	17.92	
	20 MHz	1RB High (99)	1900	20.30	20.86	18.30
			1880	20.35	20.84	18.34
			1860	20.26	20.81	18.35
		1RB Middle (50)	1900	20.30	20.85	18.11
			1880	20.41	20.85	18.03
			1860	20.33	20.78	18.24
		1RB Low (0)	1900	20.33	20.94	18.29
			1880	20.45	20.85	18.29
			1860	20.29	20.75	18.11
		50RB High (50)	1900	20.43	20.48	18.07
1880			20.46	20.50	18.09	
1860			20.46	20.45	18.01	
50RB Middle (25)		1900	20.45	20.51	18.07	
		1880	20.40	20.43	17.98	
		1860	20.46	20.47	17.99	
50RB Low (0)		1900	20.34	20.40	17.97	
		1880	20.35	20.41	17.99	
		1860	20.36	20.33	18.01	
100RB (0)		1900	20.30	20.41	17.95	
		1880	20.37	20.37	18.00	
		1860	20.44	20.50	17.98	

Band 12					
Bandwidth (MHz)	RB allocation	Frequency (MHz)	QPSK	16QAM	64QAM
	RB offset (Start RB)		Actual output power (dBm)	Actual output power (dBm)	Actual output power (dBm)
1.4 MHz	1RB High (5)	715.3	19.67	19.72	19.54
		707.5	19.74	20.21	19.69
		699.7	19.63	19.82	19.51
	1RB Middle (3)	715.3	19.66	19.75	19.80
		707.5	19.76	20.22	19.70
		699.7	19.65	19.84	19.63
	1RB Low (0)	715.3	19.72	19.81	19.74
		707.5	19.80	20.23	19.59
		699.7	19.76	19.98	19.61
	3RB High (3)	715.3	19.77	19.93	19.59
		707.5	19.81	19.95	19.61
		699.7	19.77	19.82	19.54
	3RB Middle (1)	715.3	19.79	19.99	19.55
		707.5	19.83	19.95	19.57
		699.7	19.77	19.91	19.70
	3RB Low (0)	715.3	19.77	19.96	19.61
		707.5	19.79	19.93	19.50
		699.7	19.81	19.89	19.61
	6RB (0)	715.3	19.72	19.85	19.45
		707.5	19.76	19.86	19.46
		699.7	19.82	19.78	19.41
3 MHz	1RB High (14)	714.5	19.78	19.76	19.64
		707.5	19.85	20.25	19.65
		700.5	19.74	19.86	19.76
	1RB Middle (7)	714.5	19.77	19.79	19.72
		707.5	19.87	20.26	19.72
		700.5	19.76	19.88	19.71
	1RB Low (0)	714.5	19.83	19.85	19.69
		707.5	19.91	20.27	19.81
		700.5	19.87	20.02	19.86
	8RB High (7)	714.5	19.88	19.97	19.55
		707.5	19.92	19.99	19.58
		700.5	19.88	19.86	19.57
	8RB Middle (4)	714.5	19.90	20.03	19.61
		707.5	19.94	19.99	19.64
		700.5	19.88	19.95	19.63
	8RB Low (0)	714.5	19.88	20.00	19.51
		707.5	19.90	19.97	19.60
		700.5	19.92	19.93	19.68
	15RB (0)	714.5	19.83	19.89	19.49
		707.5	19.87	19.90	19.59



		700.5	19.93	19.82	19.60	
5 MHz	1RB High (24)	713.5	19.93	20.06	19.69	
		707.5	19.83	20.51	19.69	
		701.5	19.86	20.08	19.67	
	1RB Middle (12)	713.5	19.92	20.05	19.61	
		707.5	19.88	20.46	19.78	
		701.5	19.82	20.00	19.60	
	1RB Low (0)	713.5	19.96	20.04	19.82	
		707.5	19.82	20.46	19.81	
		701.5	19.90	20.10	19.87	
	12RB High (13)	713.5	19.87	19.94	19.57	
		707.5	19.95	20.09	19.63	
		701.5	19.86	19.93	19.54	
	12RB Middle (6)	713.5	19.94	20.02	19.66	
		707.5	19.94	20.00	19.67	
		701.5	19.96	19.98	19.67	
	12RB Low (0)	713.5	19.88	19.96	19.67	
		707.5	19.94	20.05	19.66	
		701.5	19.97	20.01	19.65	
	25RB (0)	713.5	19.95	19.95	19.61	
		707.5	19.94	19.96	19.57	
		701.5	19.92	19.87	19.64	
	10 MHz	1RB High (49)	711	19.82	20.31	19.62
			707.5	19.90	19.92	19.66
			704	19.92	19.91	19.76
1RB Middle (24)		711	19.85	20.15	19.52	
		707.5	19.88	19.91	19.64	
		704	19.82	19.81	19.71	
1RB Low (0)		711	19.84	20.22	19.96	
		707.5	19.70	19.89	19.70	
		704	19.78	19.84	19.74	
25RB High (25)		711	19.94	19.99	19.51	
		707.5	19.96	20.07	19.61	
		704	20.01	19.99	19.54	
25RB Middle (12)		711	19.94	19.99	19.62	
		707.5	19.94	20.05	19.63	
		704	20.00	20.00	19.73	
25RB Low (0)		711	20.00	19.96	19.57	
		707.5	20.03	20.04	19.59	
		704	19.95	19.91	19.64	
50RB (0)		711	20.00	19.94	19.55	
		707.5	19.97	19.93	19.44	
		704	20.04	19.98	19.58	

Band 66						
Bandwidth (MHz)	RB allocation	Frequency (MHz)	QPSK	16QAM	64QAM	
	RB offset (Start RB)		Actual output power (dBm)	Actual output power (dBm)	Actual output power (dBm)	
1.4 MHz	1RB High (5)	1779.3	20.31	20.37	20.04	
		1745	20.31	20.49	19.99	
		1710.7	20.36	20.82	19.96	
	1RB Middle (3)	1779.3	20.35	20.49	20.10	
		1745	20.42	20.52	20.11	
		1710.7	20.44	20.86	19.98	
	1RB Low (0)	1779.3	20.26	20.42	19.95	
		1745	20.35	20.49	20.11	
		1710.7	20.35	20.83	20.04	
	3RB High (3)	1779.3	20.26	20.63	19.95	
		1745	20.27	20.45	19.95	
		1710.7	20.35	20.57	19.88	
	3RB Middle (1)	1779.3	20.34	20.66	19.94	
		1745	20.33	20.49	20.05	
		1710.7	20.45	20.68	19.93	
	3RB Low (0)	1779.3	20.28	20.52	19.92	
		1745	20.24	20.42	19.96	
		1710.7	20.39	20.61	19.94	
	6RB (0)	1779.3	20.42	20.56	19.82	
		1745	20.37	20.52	19.84	
		1710.7	20.41	20.32	19.53	
	3 MHz	1RB High (14)	1778.5	20.32	20.44	20.07
			1745	20.35	20.42	20.15
			1711.5	20.43	20.85	19.99
		1RB Middle (7)	1778.5	20.30	20.43	20.02
			1745	20.33	20.40	20.01
			1711.5	20.49	20.84	19.91
1RB Low (0)		1778.5	20.38	20.50	20.16	
		1745	20.28	20.43	20.01	
		1711.5	20.47	20.86	20.15	
8RB High (7)		1778.5	20.40	20.48	19.93	
		1745	20.45	20.55	19.99	
		1711.5	20.48	20.60	19.82	
8RB Middle (4)		1778.5	20.46	20.55	20.01	
		1745	20.48	20.61	19.98	
		1711.5	20.52	20.63	19.81	
8RB Low (0)		1778.5	20.53	20.51	19.94	
		1745	20.36	20.51	19.93	
		1711.5	20.47	20.58	19.76	
15RB (0)		1778.5	20.45	20.42	19.96	
		1745	20.43	20.48	19.91	

5 MHz	1RB High (24)	1711.5	20.49	20.55	19.95
		1777.5	20.40	20.56	20.04
		1745	20.45	20.63	20.17
	1RB Middle (12)	1712.5	20.35	20.84	20.13
		1777.5	20.37	20.74	19.98
		1745	20.44	20.65	20.08
	1RB Low (0)	1712.5	20.45	20.76	20.03
		1777.5	20.40	20.69	20.30
		1745	20.41	20.58	20.08
	12RB High (13)	1712.5	20.36	20.83	20.09
		1777.5	20.44	20.52	19.93
		1745	20.45	20.55	19.91
	12RB Middle (6)	1712.5	20.43	20.62	19.84
		1777.5	20.49	20.59	20.02
		1745	20.38	20.51	19.92
	12RB Low (0)	1712.5	20.51	20.68	19.86
		1777.5	20.48	20.55	19.99
		1745	20.40	20.49	19.98
	25RB (0)	1712.5	20.51	20.60	19.76
		1777.5	20.47	20.43	19.89
		1745	20.49	20.47	19.84
10 MHz	1RB High (49)	1712.5	20.50	20.56	19.64
		1775	20.43	20.21	19.94
		1745	20.40	20.78	19.99
	1RB Middle (24)	1715	20.49	20.42	20.24
		1775	20.38	20.43	19.99
		1745	20.38	20.76	20.14
	1RB Low (0)	1715	20.36	20.42	19.87
		1775	20.41	20.38	19.85
		1745	20.47	20.84	20.11
	25RB High (25)	1715	20.45	20.58	20.13
		1775	20.45	20.48	19.92
		1745	20.44	20.48	19.93
	25RB Middle (12)	1715	20.46	20.58	19.87
		1775	20.43	20.45	19.87
		1745	20.38	20.42	19.84
	25RB Low (0)	1715	20.49	20.60	19.88
		1775	20.41	20.43	19.63
		1745	20.37	20.43	19.90
	50RB (0)	1715	20.46	20.55	19.81
		1775	20.42	20.36	19.78
		1745	20.40	20.36	19.92
15 MHz	1RB High (74)	1715	20.44	20.53	19.91
		1772.5	20.35	20.77	20.08
		1745	20.38	20.86	20.06
	1RB Middle	1717.5	20.34	20.45	20.00
		1772.5	20.38	20.86	19.92
		1745	20.38	20.99	20.01

	(37)	1717.5	20.40	20.41	19.92	
	1RB Low (0)	1772.5	20.39	20.80	20.05	
		1745	20.33	20.77	19.85	
		1717.5	20.34	20.33	19.96	
	36RB High (38)	1772.5	20.44	20.55	20.01	
		1745	20.45	20.44	19.93	
		1717.5	20.47	20.51	19.89	
	36RB Middle (19)	1772.5	20.41	20.47	19.59	
		1745	20.39	20.38	19.88	
		1717.5	20.47	20.54	19.92	
	36RB Low (0)	1772.5	20.38	20.41	19.28	
		1745	20.36	20.32	19.89	
		1717.5	20.46	20.50	19.88	
	75RB (0)	1772.5	20.38	20.39	19.54	
		1745	20.33	20.34	19.84	
		1717.5	20.46	20.49	19.93	
	<b>20 MHz</b>	1RB High (99)	1770	20.29	20.76	19.83
			1745	20.33	20.78	19.88
			1720	20.40	20.85	20.11
		1RB Middle (50)	1770	20.32	20.81	20.00
			1745	20.32	20.79	20.01
			1720	20.38	20.93	19.99
		1RB Low (0)	1770	20.40	20.96	20.00
			1745	20.39	20.78	20.07
1720			20.44	20.98	19.86	
50RB High (50)		1770	20.42	20.47	19.76	
		1745	20.51	20.43	19.90	
		1720	20.48	20.54	19.89	
50RB Middle (25)		1770	20.39	20.41	19.39	
		1745	20.41	20.39	19.87	
		1720	20.50	20.59	19.95	
50RB Low (0)		1770	20.38	20.40	19.31	
		1745	20.38	20.37	19.99	
		1720	20.41	20.51	19.82	
100RB (0)		1770	20.36	20.43	19.40	
		1745	20.37	20.46	19.87	
		1720	20.50	20.56	19.93	

## LTE in ENDC mode– Power Level A1

Band 2					
Bandwidth (MHz)	RB allocation RB offset (Start RB)	Frequency (MHz)	QPSK	16QAM	64QAM
			Actual output power (dBm)	Actual output power (dBm)	Actual output power (dBm)
1.4 MHz	1RB High (5)	1909.3	20.29	20.45	20.51
		1880	20.41	20.55	20.61
		1850.7	20.40	20.84	20.90
	1RB Middle (3)	1909.3	20.35	20.49	20.55
		1880	20.45	20.64	20.70
		1850.7	20.46	20.90	20.96
	1RB Low (0)	1909.3	20.27	20.40	20.46
		1880	20.45	20.55	20.61
		1850.7	20.38	20.82	20.88
	3RB High (3)	1909.3	20.31	20.57	20.63
		1880	20.35	20.55	20.61
		1850.7	20.37	20.65	20.71
	3RB Middle (1)	1909.3	20.31	20.59	20.65
		1880	20.41	20.56	20.62
		1850.7	20.44	20.73	20.79
	3RB Low (0)	1909.3	20.24	20.54	20.60
		1880	20.35	20.51	20.57
		1850.7	20.41	20.67	20.73
	6RB (0)	1909.3	20.38	20.59	20.65
		1880	20.41	20.61	20.67
		1850.7	20.46	20.40	20.46
3 MHz	1RB High (14)	1908.5	20.41	20.56	20.62
		1880	20.53	20.56	20.62
		1851.5	20.49	20.98	20.62
	1RB Middle (7)	1908.5	20.34	20.54	20.60
		1880	20.44	20.54	20.60
		1851.5	20.51	20.92	20.98
	1RB Low (0)	1908.5	20.37	20.57	20.63
		1880	20.39	20.49	20.55
		1851.5	20.48	20.93	20.99
	8RB High (7)	1908.5	20.47	20.53	20.59
		1880	20.55	20.67	20.73
		1851.5	20.58	20.65	20.71
	8RB Middle (4)	1908.5	20.49	20.56	20.62
		1880	20.55	20.68	20.74
		1851.5	20.56	20.69	20.75
	8RB Low (0)	1908.5	20.44	20.53	20.59
		1880	20.46	20.59	20.65
		1851.5	20.49	20.65	20.71
	15RB (0)	1908.5	20.49	20.45	20.51
		1880	20.50	20.51	20.57
		1851.5	20.56	20.62	20.68

5 MHz	1RB High (24)	1907.5	20.47	20.68	20.74	
		1880	20.59	20.77	20.83	
		1852.5	20.48	20.93	20.84	
	1RB Middle (12)	1907.5	20.46	20.67	20.73	
		1880	20.58	20.71	20.77	
		1852.5	20.46	21.00	20.86	
	1RB Low (0)	1907.5	20.43	20.68	20.74	
		1880	20.50	20.65	20.71	
		1852.5	20.40	20.71	20.68	
	12RB High (13)	1907.5	20.48	20.56	20.62	
		1880	20.55	20.64	20.70	
		1852.5	20.52	20.69	20.75	
	12RB Middle (6)	1907.5	20.54	20.57	20.63	
		1880	20.49	20.61	20.67	
		1852.5	20.53	20.70	20.76	
	12RB Low (0)	1907.5	20.47	20.55	20.61	
		1880	20.43	20.56	20.62	
		1852.5	20.47	20.67	20.73	
	25RB (0)	1907.5	20.48	20.46	20.52	
		1880	20.46	20.51	20.57	
		1852.5	20.52	20.61	20.67	
	10 MHz	1RB High (49)	1905	20.26	20.49	20.55
			1880	20.51	20.46	20.52
			1855	20.52	20.88	20.94
1RB Middle (24)		1905	20.32	20.48	20.54	
		1880	20.42	20.45	20.51	
		1855	20.44	20.92	20.98	
1RB Low (0)		1905	20.30	20.51	20.57	
		1880	20.45	20.29	20.35	
		1855	20.50	20.82	20.88	
25RB High (25)		1905	20.53	20.61	20.67	
		1880	20.59	20.62	20.68	
		1855	20.57	20.61	20.67	
25RB Middle (12)		1905	20.46	20.51	20.57	
		1880	20.53	20.53	20.59	
		1855	20.53	20.61	20.67	
25RB Low (0)		1905	20.43	20.53	20.59	
		1880	20.49	20.49	20.55	
		1855	20.51	20.62	20.68	
50RB (0)		1905	20.44	20.49	20.55	
		1880	20.51	20.43	20.49	
		1855	20.56	20.61	20.67	
15 MHz		1RB High (74)	1902.5	20.44	20.84	20.90
			1880	20.48	20.98	20.82
			1857.5	20.50	20.49	20.55
	1RB Middle (37)	1902.5	20.49	20.90	20.96	
		1880	20.50	20.76	20.89	
		1857.5	20.47	20.46	20.52	

	1RB Low (0)	1902.5	20.47	20.87	20.93
		1880	20.48	20.65	20.71
		1857.5	20.44	20.55	20.61
	36RB High (38)	1902.5	20.55	20.61	20.67
		1880	20.60	20.58	20.64
		1857.5	20.58	20.60	20.66
	36RB Middle (19)	1902.5	20.54	20.61	20.67
		1880	20.48	20.51	20.57
		1857.5	20.58	20.58	20.64
	36RB Low (0)	1902.5	20.46	20.48	20.54
		1880	20.46	20.47	20.53
		1857.5	20.51	20.52	20.58
75RB (0)	1902.5	20.45	20.48	20.54	
	1880	20.46	20.48	20.54	
	1857.5	20.55	20.53	20.59	
20 MHz	1RB High (99)	1900	20.71	20.97	20.93
		1880	20.62	20.94	20.94
		1860	20.66	20.98	20.89
	1RB Middle (50)	1900	20.80	20.58	20.64
		1880	20.77	20.62	20.68
		1860	20.92	20.74	20.80
	1RB Low (0)	1900	20.81	20.98	20.63
		1880	20.65	20.88	20.94
		1860	20.79	20.61	20.67
	50RB High (50)	1900	20.82	20.63	20.69
		1880	20.82	20.58	20.64
		1860	20.81	20.64	20.70
	50RB Middle (25)	1900	20.76	20.56	20.62
		1880	20.82	20.60	20.66
		1860	20.70	20.53	20.59
	50RB Low (0)	1900	20.83	20.66	20.72
		1880	20.96	20.77	20.26
		1860	20.97	20.79	20.85
	100RB (0)	1900	20.84	20.69	20.64
		1880	20.98	20.77	20.70
		1860	20.95	20.71	20.78

## LTE in ENDC mode– Power Level C1

Band 2					
Bandwidth (MHz)	RB allocation RB offset (Start RB)	Frequency (MHz)	QPSK	16QAM	64QAM
			Actual output power (dBm)	Actual output power (dBm)	Actual output power (dBm)
1.4 MHz	1RB High (5)	1909.3	18.34	18.30	18.63
		1880	18.46	18.40	18.73
		1850.7	18.45	18.69	18.92
	1RB Middle (3)	1909.3	18.40	18.34	18.67
		1880	18.50	18.49	18.82
		1850.7	18.51	18.75	18.96
	1RB Low (0)	1909.3	18.32	18.25	18.58
		1880	18.50	18.40	18.73
		1850.7	18.43	18.67	18.97
	3RB High (3)	1909.3	18.36	18.42	18.75
		1880	18.40	18.40	18.73
		1850.7	18.42	18.50	18.83
	3RB Middle (1)	1909.3	18.36	18.44	18.77
		1880	18.46	18.41	18.74
		1850.7	18.49	18.58	18.91
	3RB Low (0)	1909.3	18.29	18.39	18.72
		1880	18.40	18.36	18.69
		1850.7	18.46	18.52	18.85
6RB (0)	1909.3	18.43	18.44	18.77	
	1880	18.46	18.46	18.79	
	1850.7	18.51	18.25	18.58	
3 MHz	1RB High (14)	1908.5	18.46	18.41	18.74
		1880	18.58	18.41	18.74
		1851.5	18.54	18.83	18.96
	1RB Middle (7)	1908.5	18.39	18.39	18.72
		1880	18.49	18.39	18.72
		1851.5	18.56	18.77	18.91
	1RB Low (0)	1908.5	18.42	18.42	18.75
		1880	18.44	18.34	18.67
		1851.5	18.53	18.78	18.95
	8RB High (7)	1908.5	18.52	18.38	18.71
		1880	18.60	18.52	18.85
		1851.5	18.63	18.50	18.83
	8RB Middle (4)	1908.5	18.54	18.41	18.74
		1880	18.60	18.53	18.86
		1851.5	18.61	18.54	18.87
	8RB Low (0)	1908.5	18.49	18.38	18.71
		1880	18.51	18.44	18.77
		1851.5	18.54	18.50	18.83
15RB (0)	1908.5	18.54	18.30	18.63	
	1880	18.55	18.36	18.69	
	1851.5	18.61	18.47	18.80	



5 MHz	1RB High (24)	1907.5	18.52	18.53	18.86	
		1880	18.64	18.62	18.95	
		1852.5	18.53	18.98	18.93	
	1RB Middle (12)	1907.5	18.51	18.52	18.85	
		1880	18.63	18.56	18.89	
		1852.5	18.51	18.85	18.98	
	1RB Low (0)	1907.5	18.48	18.53	18.86	
		1880	18.55	18.50	18.83	
		1852.5	18.45	18.96	18.92	
	12RB High (13)	1907.5	18.53	18.41	18.74	
		1880	18.60	18.49	18.82	
		1852.5	18.57	18.54	18.87	
	12RB Middle (6)	1907.5	18.59	18.42	18.75	
		1880	18.54	18.46	18.79	
		1852.5	18.58	18.55	18.88	
	12RB Low (0)	1907.5	18.52	18.40	18.73	
		1880	18.48	18.41	18.74	
		1852.5	18.52	18.52	18.85	
	25RB (0)	1907.5	18.53	18.31	18.64	
		1880	18.51	18.36	18.69	
		1852.5	18.57	18.46	18.79	
	10 MHz	1RB High (49)	1905	18.31	18.34	18.67
			1880	18.56	18.31	18.64
			1855	18.57	18.73	18.94
1RB Middle (24)		1905	18.37	18.33	18.66	
		1880	18.47	18.30	18.63	
		1855	18.49	18.77	18.90	
1RB Low (0)		1905	18.35	18.36	18.69	
		1880	18.50	18.14	18.47	
		1855	18.55	18.67	18.92	
25RB High (25)		1905	18.58	18.46	18.79	
		1880	18.64	18.47	18.80	
		1855	18.62	18.46	18.79	
25RB Middle (12)		1905	18.51	18.36	18.69	
		1880	18.58	18.38	18.71	
		1855	18.58	18.46	18.79	
25RB Low (0)		1905	18.48	18.38	18.71	
		1880	18.54	18.34	18.67	
		1855	18.56	18.47	18.80	
50RB (0)		1905	18.49	18.34	18.67	
		1880	18.56	18.28	18.61	
		1855	18.61	18.46	18.79	
15 MHz		1RB High (74)	1902.5	18.49	18.69	18.92
			1880	18.53	18.83	18.96
			1857.5	18.55	18.34	18.67
	1RB Middle (37)	1902.5	18.54	18.75	18.88	
		1880	18.55	18.96	18.82	
		1857.5	18.52	18.31	18.64	

	1RB Low (0)	1902.5	18.52	18.72	18.95
		1880	18.53	18.90	18.75
		1857.5	18.49	18.40	18.73
	36RB High (38)	1902.5	18.60	18.46	18.79
		1880	18.65	18.43	18.76
		1857.5	18.63	18.45	18.78
	36RB Middle (19)	1902.5	18.59	18.46	18.79
		1880	18.53	18.36	18.69
		1857.5	18.63	18.43	18.76
	36RB Low (0)	1902.5	18.51	18.33	18.66
		1880	18.51	18.32	18.65
		1857.5	18.56	18.37	18.70
75RB (0)	1902.5	18.50	18.33	18.66	
	1880	18.51	18.33	18.66	
	1857.5	18.60	18.38	18.71	
20 MHz	1RB High (99)	1900	18.76	18.95	18.99
		1880	18.67	18.92	18.96
		1860	18.71	18.96	18.84
	1RB Middle (50)	1900	18.86	18.81	18.70
		1880	18.82	18.81	18.65
		1860	18.95	18.92	18.75
	1RB Low (0)	1900	18.70	18.96	18.90
		1880	18.84	18.69	18.63
		1860	18.87	18.71	18.65
	50RB High (50)	1900	18.87	18.66	18.60
		1880	18.86	18.72	18.66
		1860	18.81	18.64	18.58
	50RB Middle (25)	1900	18.87	18.68	18.62
		1880	18.75	18.61	18.55
		1860	18.88	18.74	18.68
	50RB Low (0)	1900	18.86	18.84	18.55
		1880	18.87	18.99	18.58
		1860	18.92	18.99	18.67
	100RB (0)	1900	18.89	18.84	18.48
		1880	18.94	18.94	18.95
		1860	18.99	18.88	19.00

Uplink maximum output power is measured with downlink carrier aggregation active, using the channel with highest measured maximum output power when downlink carrier aggregation is inactive. SAR test is not required since maximum output power when downlink carrier aggregation active is not more than ¼ dB higher than the maximum output power measured when downlink carrier aggregation inactive.

## 11.4 Wi-Fi and BT Measurement result

The maximum output power of BT is 11.20dBm.

The maximum tune up of BT is 11dBm.

Low power for WLAN by Simultaneous transmission.

The average conducted power for Wi-Fi is as following:

**The conducted output power for WiFi 2.4G MIMO Normal power is as following:**

FCC		
802.11b	Channel\data rate	1Mbps
WLAN2450	11(2462MHz)	22.25
	6(2437(MHz)	22.20
	1(2412MHz)	22.06
	Tune up	22.50
802.11g	Channel\data rate	6Mbps
WLAN2450	11(2462MHz)	21.19
	6(2437(MHz)	21.26
	1(2412MHz)	21.08
	Tune up	21.50
802.11n-20MHz	Channel\data rate	MCS0
WLAN2450	11(2462MHz)	20.49
	6(2437(MHz)	20.57
	1(2412MHz)	20.43
	Tune up	21.00
802.11n-40MHz	Channel\data rate	MCS0
WLAN2450	9(2452MHz)	19.99
	6(2437MHz)	20.47
	3(2422MHz)	20.38
	Tune up	21.00

**The conducted output power for WiFi 2.4G Antenna4 Low power is as following:**

FCC		
802.11b	Channel\data rate	1Mbps
WLAN2450	11(2462MHz)	19.21
	6(2437(MHz)	19.20
	1(2412MHz)	19.02
	Tune up	19.50
802.11g	Channel\data rate	6Mbps
WLAN2450	11(2462MHz)	18.20
	6(2437(MHz)	18.24
	1(2412MHz)	18.25
	Tune up	19.00
802.11n-20MHz	Channel\data rate	MCS0
WLAN2450	11(2462MHz)	17.64
	6(2437(MHz)	17.65
	1(2412MHz)	17.47
	Tune up	19.00
802.11n-40MHz	Channel\data rate	MCS0
WLAN2450	9(2452MHz)	17.14
	6(2437MHz)	17.52
	3(2422MHz)	17.32
	Tune up	19.00

The conducted output power for WiFi 5G MIMO Normal power is as following:

802.11a(dBm)	
Channel\data rate	6Mbps
36(5180 MHz)	19.30
40(5200 MHz)	19.17
44(5220 MHz)	18.94
48(5240 MHz)	18.90
52(5260 MHz)	18.85
56(5280 MHz)	18.56
60(5300 MHz)	18.63
64(5320 MHz)	18.73
100(5500 MHz)	18.94
104(5520 MHz)	19.15
108(5540 MHz)	19.42
112(5560 MHz)	19.79
116(5580 MHz)	19.96
120(5600 MHz)	19.90
124(5620 MHz)	19.74
128(5640 MHz)	19.62
132(5660 MHz)	19.43
136(5680 MHz)	19.15
140(5700 MHz)	19.56
144(5720 MHz)	19.88
149(5745 MHz)	19.80
153(5765 MHz)	19.93
157(5785 MHz)	19.87
161(5805 MHz)	19.47
165(5825 MHz)	19.12
Tune up	20.50

The conducted output power for WiFi 5G MIMO Low power is as following:

802.11a(dBm)	
Channel\data rate	6Mbps
36(5180 MHz)	16.62
40(5200 MHz)	16.32
44(5220 MHz)	15.70
48(5240 MHz)	15.47
Tune up	17.00
52(5260 MHz)	15.27
56(5280 MHz)	15.11
60(5300 MHz)	15.11
64(5320 MHz)	15.25
Tune up	15.50
100(5500 MHz)	15.94
104(5520 MHz)	16.13
108(5540 MHz)	16.20
112(5560 MHz)	16.50
116(5580 MHz)	16.12
120(5600 MHz)	16.18
124(5620 MHz)	16.14
128(5640 MHz)	16.28
132(5660 MHz)	16.10
136(5680 MHz)	15.90
140(5700 MHz)	16.34
144(5720 MHz)	16.65
Tune up	17.00
149(5745 MHz)	16.61
153(5765 MHz)	17.10
157(5785 MHz)	17.15
161(5805 MHz)	16.80
165(5825 MHz)	16.61
Tune up	17.50

## 11.5 NR 5G Measurement result

### Maximum Target Power for Production Unit – Level A1

No.	Test Freq Description	5G-n2						Tune up	Power Results (dBm)
		SCS (kHz)	NR BW (MHz)	Modulation	RB allocation	NR Test Freq. (MHz)	NR Test CH.		n2
1	High	15	5	DFT-s-OFDM QPSK	Edge_1RB_Right	1907.5	381500	20.3	19.75
2	Middle	15	5	DFT-s-OFDM QPSK	Inner_Full	1880	376000	20.3	19.83
3	Low	15	5	DFT-s-OFDM QPSK	Edge_1RB_Left	1852.5	370500	20.3	20.05
4	High	15	20	DFT-s-OFDM QPSK	Edge_1RB_Right	1900	380000	20.3	19.82
5	Middle	15	20	DFT-s-OFDM QPSK	Inner_Full	1880	376000	20.3	19.95
6	Low	15	20	DFT-s-OFDM QPSK	Edge_1RB_Left	1860	372000	20.3	20.10

According to the table above, the maximum power configuration is selected as the default test configuration

No.	Test Freq Description	5G-n2						Tune up	Power Results (dBm)
		SCS (kHz)	NR BW (MHz)	Modulation	RB allocation	NR Test Freq. (MHz)	NR Test CH.		n2
1	default	15	20	DFT-s-OFDM PI/2 BPSK1	Edge_1RB_Left	1860	372000	20.3	20.09
2	default	15	20	DFT-s-OFDM 16QAM	Edge_1RB_Left	1860	372000	20.3	20.03
3	default	15	20	DFT-s-OFDM 64QAM	Edge_1RB_Left	1860	372000	20.3	19.79
4	default	15	20	DFT-s-OFDM 256QAM	Edge_1RB_Left	1860	372000	18.8	18.78
5	default	15	20	CP-OFDM QPSK	Edge_1RB_Left	1860	372000	20.3	19.94
6	default	15	20	CP-OFDM 16QAM	Edge_1RB_Left	1860	372000	20.3	20.07
7	default	15	20	CP-OFDM 64QAM	Edge_1RB_Left	1860	372000	19.8	19.78
8	default	15	20	CP-OFDM 256QAM	Edge_1RB_Left	1860	372000	16.8	16.74
9	default	15	20	DFT-s-OFDM QPSK	Edge_Full_Right	1860	372000	20.3	20.05
10	default	15	20	DFT-s-OFDM QPSK	Edge_Full_Left	1860	372000	20.3	20.03
11	default	15	20	DFT-s-OFDM QPSK	Inner_1RB_Right	1860	372000	20.3	20.04
12	default	15	20	DFT-s-OFDM QPSK	Inner_1RB_Left	1860	372000	20.3	20.06
13	default	15	20	DFT-s-OFDM QPSK	Outer_Full	1860	372000	20.3	19.96
14	Low	15	10	DFT-s-OFDM QPSK	Edge_1RB_Left	1855	371000	20.3	19.97
15	Low	15	15	DFT-s-OFDM QPSK	Edge_1RB_Left	1857.5	371500	20.3	19.89

No.	Test Freq Description	5G-n66						Tune up	Power Results (dBm)
		SCS (kHz)	NR BW (MHz)	Modulation	RB allocation	NR Test Freq. (MHz)	NR Test CH.		n66
1	High	15	5	DFT-s-OFDM QPSK	Edge_1RB_Right	1777.5	355500	20.7	19.66
2	Middle	15	5	DFT-s-OFDM QPSK	Inner_Full	1745	349000	20.7	19.83
3	Low	15	5	DFT-s-OFDM QPSK	Edge_1RB_Left	1712.5	342500	20.7	19.77
4	High	15	20	DFT-s-OFDM QPSK	Edge_1RB_Right	1770	354000	20.7	19.75
5	Middle	15	20	DFT-s-OFDM QPSK	Inner_Full	1745	349000	20.7	19.77
6	Low	15	20	DFT-s-OFDM QPSK	Edge_1RB_Left	1720	344000	20.7	20.04

According to the table above, the maximum power configuration is selected as the default test configuration

No.	Test Freq Description	5G-n66						Tune up	Power Results (dBm)
		SCS (kHz)	NR BW (MHz)	Modulation	RB allocation	NR Test Freq. (MHz)	NR Test CH.		n66
1	default	15	20	DFT-s-OFDM PI/2 BPSK1	Edge_1RB_Left	1720	344000	20.7	19.92
2	default	15	20	DFT-s-OFDM 16QAM	Edge_1RB_Left	1720	344000	20.7	19.93
3	default	15	20	DFT-s-OFDM 64QAM	Edge_1RB_Left	1720	344000	20.7	19.95
4	default	15	20	DFT-s-OFDM 256QAM	Edge_1RB_Left	1720	344000	19.2	19.17
5	default	15	20	CP-OFDM QPSK	Edge_1RB_Left	1720	344000	20.7	19.84
6	default	15	20	CP-OFDM 16QAM	Edge_1RB_Left	1720	344000	20.7	19.93
7	default	15	20	CP-OFDM 64QAM	Edge_1RB_Left	1720	344000	20.2	19.74
8	default	15	20	CP-OFDM 256QAM	Edge_1RB_Left	1720	344000	17.2	17.19
9	default	15	20	DFT-s-OFDM QPSK	Edge_Full_Right	1720	344000	20.7	20.4
10	default	15	20	DFT-s-OFDM QPSK	Edge_Full_Left	1720	344000	20.7	20.38
11	default	15	20	DFT-s-OFDM QPSK	Inner_1RB_Right	1720	344000	20.7	20.09
12	default	15	20	DFT-s-OFDM QPSK	Inner_1RB_Left	1720	344000	20.7	20.08
13	default	15	20	DFT-s-OFDM QPSK	Outer_Full	1720	344000	20.7	19.8
14	default	15	10	DFT-s-OFDM QPSK	Edge_Full_Right	1715	343000	20.7	20.38
15	default	15	15	DFT-s-OFDM QPSK	Edge_Full_Right	1717.5	343500	20.7	20.18

**Maximum Target Power for Production Unit – Level B1**

No.	Test Freq Description	5G-n2						Tune up	Power Results (dBm)
		SCS (kHz)	NR BW (MHz)	Modulation	RB allocation	NR Test Freq. (MHz)	NR Test CH.		n2
1	High	15	5	DFT-s-OFDM QPSK	Edge_1RB_Right	1907.5	381500	21.4	20.77
2	Middle	15	5	DFT-s-OFDM QPSK	Inner_Full	1880	376000	21.4	21.11
3	Low	15	5	DFT-s-OFDM QPSK	Edge_1RB_Left	1852.5	370500	21.4	21.05
4	High	15	20	DFT-s-OFDM QPSK	Edge_1RB_Right	1900	380000	21.4	20.76
5	Middle	15	20	DFT-s-OFDM QPSK	Inner_Full	1880	376000	21.4	20.95
6	Low	15	20	DFT-s-OFDM QPSK	Edge_1RB_Left	1860	372000	21.4	21.14

According to the table above, the maximum power configuration is selected as the default test configuration

No.	Test Freq Description	5G-n2						Tune up	Power Results (dBm)
		SCS (kHz)	NR BW (MHz)	Modulation	RB allocation	NR Test Freq. (MHz)	NR Test CH.		n2
1	default	15	20	DFT-s-OFDM PI/2 BPSK1	Edge_1RB_Left	1860	372000	21.4	21.05
2	default	15	20	DFT-s-OFDM 16QAM	Edge_1RB_Left	1860	372000	21.4	20.99
3	default	15	20	DFT-s-OFDM 64QAM	Edge_1RB_Left	1860	372000	20.9	20.79
4	default	15	20	DFT-s-OFDM 256QAM	Edge_1RB_Left	1860	372000	18.9	18.74
5	default	15	20	CP-OFDM QPSK	Edge_1RB_Left	1860	372000	20.4	20.37
6	default	15	20	CP-OFDM 16QAM	Edge_1RB_Left	1860	372000	20.4	20.34
7	default	15	20	CP-OFDM 64QAM	Edge_1RB_Left	1860	372000	19.9	19.82
8	default	15	20	CP-OFDM 256QAM	Edge_1RB_Left	1860	372000	16.9	19.81
9	default	15	20	DFT-s-OFDM QPSK	Edge_Full_Right	1860	372000	21.4	21.06
10	default	15	20	DFT-s-OFDM QPSK	Edge_Full_Left	1860	372000	21.4	21.02
11	default	15	20	DFT-s-OFDM QPSK	Inner_1RB_Right	1860	372000	21.4	21.13
12	default	15	20	DFT-s-OFDM QPSK	Inner_1RB_Left	1860	372000	21.4	21.08
13	default	15	20	DFT-s-OFDM QPSK	Outer_Full	1860	372000	21.4	20.99
14	default	15	10	DFT-s-OFDM QPSK	Edge_1RB_Left	1855	371000	21.4	21.07
15	default	15	15	DFT-s-OFDM QPSK	Edge_1RB_Left	1857.5	371500	21.4	21.03

No.	Test Freq Description	5G-n66						Tune up	Power Results (dBm)
		SCS (kHz)	NR BW (MHz)	Modulation	RB allocation	NR Test Freq. (MHz)	NR Test CH.		n66
1	High	15	5	DFT-s-OFDM QPSK	Edge_1RB_Right	1777.5	355500	21.7	20.62
2	Middle	15	5	DFT-s-OFDM QPSK	Inner_Full	1745	349000	21.7	20.78
3	Low	15	5	DFT-s-OFDM QPSK	Edge_1RB_Left	1712.5	342500	21.7	20.75
4	High	15	20	DFT-s-OFDM QPSK	Edge_1RB_Right	1770	354000	21.7	20.73
5	Middle	15	20	DFT-s-OFDM QPSK	Inner_Full	1745	349000	21.7	20.75
6	Low	15	20	DFT-s-OFDM QPSK	Edge_1RB_Left	1720	344000	21.7	20.95

According to the table above, the maximum power configuration is selected as the default test configuration

No.	Test Freq Description	5G-n66						Tune up	Power Results (dBm)
		SCS (kHz)	NR BW (MHz)	Modulation	RB allocation	NR Test Freq. (MHz)	NR Test CH.		n66
1	default	15	20	DFT-s-OFDM PI/2 BPSK1	Edge_1RB_Left	1720	344000	21.7	20.93
2	default	15	20	DFT-s-OFDM 16QAM	Edge_1RB_Left	1720	344000	21.7	20.89
3	default	15	20	DFT-s-OFDM 64QAM	Edge_1RB_Left	1720	344000	21.2	20.91
4	default	15	20	DFT-s-OFDM 256QAM	Edge_1RB_Left	1720	344000	19.2	19.16
5	default	15	20	CP-OFDM QPSK	Edge_1RB_Left	1720	344000	20.7	20.67
6	default	15	20	CP-OFDM 16QAM	Edge_1RB_Left	1720	344000	20.7	20.63
7	default	15	20	CP-OFDM 64QAM	Edge_1RB_Left	1720	344000	20.2	20.19
8	default	15	20	CP-OFDM 256QAM	Edge_1RB_Left	1720	344000	17.2	17.17
9	default	15	20	DFT-s-OFDM QPSK	Edge_Full_Right	1720	344000	21.7	21.41
10	default	15	20	DFT-s-OFDM QPSK	Edge_Full_Left	1720	344000	21.7	21.34
11	default	15	20	DFT-s-OFDM QPSK	Inner_1RB_Right	1720	344000	21.7	21.09
12	default	15	20	DFT-s-OFDM QPSK	Inner_1RB_Left	1720	344000	21.7	21.06
13	default	15	20	DFT-s-OFDM QPSK	Outer_Full	1720	344000	21.7	20.83
14	default	15	10	DFT-s-OFDM QPSK	Edge_Full_Right	1715	343000	21.7	21.34
15	default	15	15	DFT-s-OFDM QPSK	Edge_Full_Right	1717.5	343500	21.7	21.27

**Maximum Target Power for Production Unit – Level C1**

No.	Test Freq Description	5G-n2						Tune up	Power Results (dBm)	
		SCS (kHz)	NR BW (MHz)	Modulation	RB allocation	NR Test Freq. (MHz)	NR Test CH.		n2	
1	High	15	5	DFT-s-OFDM QPSK	Edge_1RB_Right	1907.5	381500	23.5	22.75	
2	Middle	15	5	DFT-s-OFDM QPSK	Inner_Full	1880	376000	24.5	23.10	
3	Low	15	5	DFT-s-OFDM QPSK	Edge_1RB_Left	1852.5	370500	23.5	22.96	
4	High	15	20	DFT-s-OFDM QPSK	Edge_1RB_Right	1900	380000	23.5	22.80	
5	Middle	15	20	DFT-s-OFDM QPSK	Inner_Full	1880	376000	24.5	23.26	
6	Low	15	20	DFT-s-OFDM QPSK	Edge_1RB_Left	1860	372000	23.5	22.98	

According to the table above, the maximum power configuration is selected as the default test configuration

No.	Test Freq Description	5G-n2						Tune up	Power Results (dBm)	
		SCS (kHz)	NR BW (MHz)	Modulation	RB allocation	NR Test Freq. (MHz)	NR Test CH.		n2	
1	default	15	20	DFT-s-OFDM PI/2 BPSK1	Inner_Full	1880	376000	24.5	23.19	
2	default	15	20	DFT-s-OFDM 16QAM	Inner_Full	1880	376000	23.5	22.93	
3	default	15	20	DFT-s-OFDM 64QAM	Inner_Full	1880	376000	22	21.43	
4	default	15	20	DFT-s-OFDM 256QAM	Inner_Full	1880	376000	20	19.44	
5	default	15	20	CP-OFDM QPSK	Inner_Full	1880	376000	23	22.41	
6	default	15	20	CP-OFDM 16QAM	Inner_Full	1880	376000	22.5	21.94	
7	default	15	20	CP-OFDM 64QAM	Inner_Full	1880	376000	21	20.47	
8	default	15	20	CP-OFDM 256QAM	Inner_Full	1880	376000	18	17.48	
9	default	15	20	DFT-s-OFDM QPSK	Edge_Full_Right	1880	376000	23.5	22.50	
10	default	15	20	DFT-s-OFDM QPSK	Edge_Full_Left	1880	376000	23.5	23.09	
11	default	15	20	DFT-s-OFDM QPSK	Inner_1RB_Right	1880	376000	24.5	22.75	
12	default	15	20	DFT-s-OFDM QPSK	Inner_1RB_Left	1880	376000	24.5	23.1	
13	default	15	20	DFT-s-OFDM QPSK	Outer_Full	1880	376000	23.5	22.90	
14	default	15	10	DFT-s-OFDM QPSK	Inner_Full	1880	376000	24.5	23.1	
15	default	15	15	DFT-s-OFDM QPSK	Inner_Full	1880	376000	24.5	23.12	

No.	Test Freq Description	5G-n66						Tune up	Power Results (dBm)	
		SCS (kHz)	NR BW (MHz)	Modulation	RB allocation	NR Test Freq. (MHz)	NR Test CH.		n66	
1	High	15	5	DFT-s-OFDM QPSK	Edge_1RB_Right	1777.5	355500	23.5	22.65	
2	Middle	15	5	DFT-s-OFDM QPSK	Inner_Full	1745	349000	24.5	23.24	
3	Low	15	5	DFT-s-OFDM QPSK	Edge_1RB_Left	1712.5	342500	23.5	22.75	
4	High	15	20	DFT-s-OFDM QPSK	Edge_1RB_Right	1770	354000	23.5	22.73	
5	Middle	15	20	DFT-s-OFDM QPSK	Inner_Full	1745	349000	24.5	23.27	
6	Low	15	20	DFT-s-OFDM QPSK	Edge_1RB_Left	1720	344000	23.5	21.08	

According to the table above, the maximum power configuration is selected as the default test configuration

No.	Test Freq Description	5G-n66						Tune up	Power Results (dBm)	
		SCS (kHz)	NR BW (MHz)	Modulation	RB allocation	NR Test Freq. (MHz)	NR Test CH.		n66	
1	default	15	20	DFT-s-OFDM PI/2 BPSK1	Inner_Full	1745	349000	24.5	23.24	
2	default	15	20	DFT-s-OFDM 16QAM	Inner_Full	1745	349000	23.5	22.97	
3	default	15	20	DFT-s-OFDM 64QAM	Inner_Full	1745	349000	22	21.48	
4	default	15	20	DFT-s-OFDM 256QAM	Inner_Full	1745	349000	20	19.43	
5	default	15	20	CP-OFDM QPSK	Inner_Full	1745	349000	23	22.48	
6	default	15	20	CP-OFDM 16QAM	Inner_Full	1745	349000	22.5	21.97	
7	default	15	20	CP-OFDM 64QAM	Inner_Full	1745	349000	21	20.43	
8	default	15	20	CP-OFDM 256QAM	Inner_Full	1745	349000	18	17.49	
9	default	15	20	DFT-s-OFDM QPSK	Edge_Full_Right	1745	349000	23.5	22.97	
10	default	15	20	DFT-s-OFDM QPSK	Edge_Full_Left	1745	349000	23.5	22.91	
11	default	15	20	DFT-s-OFDM QPSK	Inner_1RB_Right	1745	349000	24.5	23.17	
12	default	15	20	DFT-s-OFDM QPSK	Inner_1RB_Left	1745	349000	24.5	23.09	
13	default	15	20	DFT-s-OFDM QPSK	Outer_Full	1745	349000	23.5	22.84	
14	default	15	10	DFT-s-OFDM QPSK	Inner_Full	1745	349000	24.5	23.07	
15	default	15	15	DFT-s-OFDM QPSK	Inner_Full	1745	349000	24.5	23.14	

**Maximum Target Power for Production Unit – Level A1**

No.	Test Freq Description	5G-n25						Tune up	Power Results (dBm)
		SCS (kHz)	NR BW (MHz)	Modulation	RB allocation	NR Test Freq. (MHz)	NR Test CH.		
1	High	15	5	DFT-s-OFDM QPSK	Edge_1RB_Right	1912.5	382500	23	22.91
2	Middle	15	5	DFT-s-OFDM QPSK	Inner_Full	1882.5	376500	24	23.10
3	Low	15	5	DFT-s-OFDM QPSK	Edge_1RB_Left	1852.5	370500	23	22.83
4	High	15	20	DFT-s-OFDM QPSK	Edge_1RB_Right	1905	381000	23	22.65
5	Middle	15	20	DFT-s-OFDM QPSK	Inner_Full	1882.5	376500	24	<b>23.20</b>
6	Low	15	20	DFT-s-OFDM QPSK	Edge_1RB_Left	1860	372000	23	22.73

According to the table above, the maximum power configuration is selected as the default test configuration

No.	Test Freq Description	5G-n25						Tune up	Power Results (dBm)
		SCS (kHz)	NR BW (MHz)	Modulation	RB allocation	NR Test Freq. (MHz)	NR Test CH.		
1	Low	15	20	DFT-s-OFDM PI/2 BPSK1	Inner_Full	1882.5	376500	24	23.18
2	Low	15	20	DFT-s-OFDM 16QAM	Inner_Full	1882.5	376500	23	21.28
3	Low	15	20	DFT-s-OFDM 64QAM	Inner_Full	1882.5	376500	21.5	21.29
4	Low	15	20	DFT-s-OFDM 256QAM	Inner_Full	1882.5	376500	19.5	18.88
5	Low	15	20	CP-OFDM QPSK	Inner_Full	1882.5	376500	22.5	21.29
6	Low	15	20	CP-OFDM 16QAM	Inner_Full	1882.5	376500	22	21.27
7	Low	15	20	CP-OFDM 64QAM	Inner_Full	1882.5	376500	20.5	20.46
8	Low	15	20	CP-OFDM 256QAM	Inner_Full	1882.5	376500	17.5	17.48
9	Low	15	20	DFT-s-OFDM QPSK	Edge_Full_Right	1882.5	376500	23	21.34
10	Low	15	20	DFT-s-OFDM QPSK	Edge_Full_Left	1882.5	376500	23	21.04
11	Low	15	20	DFT-s-OFDM QPSK	Inner_1RB_Right	1882.5	376500	24	23.16
12	Low	15	20	DFT-s-OFDM QPSK	Inner_1RB_Left	1882.5	376500	24	23.11
13	Low	15	20	DFT-s-OFDM QPSK	Outer_Full	1882.5	376500	23	21.26
14	default	15	10	DFT-s-OFDM QPSK	Inner_Full	1882.5	376500	24	23.11
15	default	15	15	DFT-s-OFDM QPSK	Inner_Full	1882.5	376500	24	23.07

No.	Test Freq Description	5G-n41						Tune up	Power Results
		SCS (kHz)	NR BW (MHz)	Modulation	RB allocation	NR Test Freq. (MHz)	NR Test CH.		
1	High	30	20	DFT-s-OFDM QPSK	Edge_1RB_Right	2679.99	535998	24.2	23.50
2	Middle-1	30	20	DFT-s-OFDM QPSK	Inner_Full	2636.49	527298	27.7	26.82
3	Middle-2	30	20	DFT-s-OFDM QPSK	Inner_Full	2592.99	518598	27.7	26.43
4	Middle-3	30	20	DFT-s-OFDM QPSK	Inner_Full	2549.51	509902	27.7	26.95
5	Low	30	20	DFT-s-OFDM QPSK	Edge_1RB_Left	2506.02	501204	24.2	23.66
6	High	30	100	DFT-s-OFDM QPSK	Edge_1RB_Right	2640	528000	24.2	23.76
7	Middle	30	100	DFT-s-OFDM QPSK	Inner_Full	2616.51	523302	27.7	26.83
8	Middle	30	100	DFT-s-OFDM QPSK	Inner_Full	2592.99	518598	27.7	26.91
9	Middle	30	100	DFT-s-OFDM QPSK	Inner_Full	2569.5	513900	27.7	<b>26.96</b>
10	Low	30	100	DFT-s-OFDM QPSK	Edge_1RB_Left	2546.01	509202	24.2	23.88

According to the table above, the maximum power configuration is selected as the default test configuration

No.	Test Freq Description	5G-n41						Tune up	Power Results
		SCS (kHz)	NR BW (MHz)	Modulation	RB allocation	NR Test Freq. (MHz)	NR Test CH.		
1	Middle-1	30	100	DFT-s-OFDM PI/2 BPSK1	Inner_Full	2569.5	513900	27.7	26.92
2	Middle-1	30	100	DFT-s-OFDM 16QAM	Inner_Full	2569.5	513900	26.7	26.19
3	Middle-1	30	100	DFT-s-OFDM 64QAM	Inner_Full	2569.5	513900	25.2	24.74
4	Middle-1	30	100	DFT-s-OFDM 256QAM	Inner_Full	2569.5	513900	23.2	22.84
5	Middle-1	30	100	CP-OFDM QPSK	Inner_Full	2569.5	513900	26.2	25.56
6	Middle-1	30	100	CP-OFDM 16QAM	Inner_Full	2569.5	513900	25.7	25.22
7	Middle-1	30	100	CP-OFDM 64QAM	Inner_Full	2569.5	513900	24.2	23.92
8	Middle-1	30	100	CP-OFDM 256QAM	Inner_Full	2569.5	513900	21.2	21.08
9	Middle-1	30	100	DFT-s-OFDM QPSK	Edge_Full_Right	2569.5	513900	24.2	24.11
10	Middle-1	30	100	DFT-s-OFDM QPSK	Edge_Full_Left	2569.5	513900	24.2	23.76
11	Middle-1	30	100	DFT-s-OFDM QPSK	Inner_1RB_Right	2569.5	513900	27.7	26.37
12	Middle-1	30	100	DFT-s-OFDM QPSK	Inner_1RB_Left	2569.5	513900	27.7	26.77
13	Middle-1	30	100	DFT-s-OFDM QPSK	Outer_Full	2569.5	513900	26.7	26.20
14	default	30	40	DFT-s-OFDM QPSK	Inner_Full	2554.5	510900	27.7	25.96
15	default	30	50	DFT-s-OFDM QPSK	Inner_Full	2557	511401	27.7	25.79
16	default	30	60	DFT-s-OFDM QPSK	Inner_Full	2559.5	511899	27.7	26.23
16	default	30	80	DFT-s-OFDM QPSK	Inner_Full	2564.51	512900	27.7	26.04
16	default	30	90	DFT-s-OFDM QPSK	Inner_Full	2567	513399	27.7	26.07



**Maximum Target Power for Production Unit – Level C1**

No.	Test Freq Description	5G-n25						Tune up	Power Results (dBm)
		SCS (kHz)	NR BW (MHz)	Modulation	RB allocation	NR Test Freq. (MHz)	NR Test CH.		
1	High	15	5	DFT-s-OFDM QPSK	Edge_1RB_Right	1912.5	382500	21.7	21.16
2	Middle	15	5	DFT-s-OFDM QPSK	Inner_Full	1882.5	376500	21.7	21.14
3	Low	15	5	DFT-s-OFDM QPSK	Edge_1RB_Left	1852.5	370500	21.7	21.06
4	High	15	20	DFT-s-OFDM QPSK	Edge_1RB_Right	1905	381000	21.7	20.73
5	Middle	15	20	DFT-s-OFDM QPSK	Inner_Full	1882.5	376500	21.7	21.15
6	Low	15	20	DFT-s-OFDM QPSK	Edge_1RB_Left	1860	372000	21.7	20.76

According to the table above, the maximum power configuration is selected as the default test configuration

No.	Test Freq Description	5G-n25						Tune up	Power Results (dBm)
		SCS (kHz)	NR BW (MHz)	Modulation	RB allocation	NR Test Freq. (MHz)	NR Test CH.		
1	Low	15	5	DFT-s-OFDM Pi/2 BPSK1	Edge_1RB_Right	1912.5	382500	21.7	21.14
2	Low	15	5	DFT-s-OFDM 16QAM	Edge_1RB_Right	1912.5	382500	21.7	21.09
3	Low	15	5	DFT-s-OFDM 64QAM	Edge_1RB_Right	1912.5	382500	21.7	21.02
4	Low	15	5	DFT-s-OFDM 256QAM	Edge_1RB_Right	1912.5	382500	20.2	19.86
5	Low	15	5	CP-OFDM QPSK	Edge_1RB_Right	1912.5	382500	21.7	21.13
6	Low	15	5	CP-OFDM 16QAM	Edge_1RB_Right	1912.5	382500	21.7	21.11
7	Low	15	5	CP-OFDM 64QAM	Edge_1RB_Right	1912.5	382500	21.2	20.86
8	Low	15	5	CP-OFDM 256QAM	Edge_1RB_Right	1912.5	382500	18.2	17.85
9	Low	15	5	DFT-s-OFDM 16QAM	Edge_Full_Right	1912.5	382500	21.7	21.10
10	Low	15	5	DFT-s-OFDM 16QAM	Edge_Full_Left	1912.5	382500	21.7	21.02
11	Low	15	5	DFT-s-OFDM 16QAM	Inner_1RB_Right	1912.5	382500	21.7	21.10
12	Low	15	5	DFT-s-OFDM 16QAM	Inner_1RB_Left	1912.5	382500	21.7	20.97
13	Low	15	5	DFT-s-OFDM 16QAM	Outer_Full	1912.5	382500	21.7	19.38
14	default	15	10	DFT-s-OFDM QPSK	Edge_1RB_Right	1910	382000	21.7	21.08
15	default	15	15	DFT-s-OFDM QPSK	Edge_1RB_Right	1907.5	381500	21.7	21.06

No.	Test Freq Description	5G-n41						QRCT设置信道	Tune up	Power Results
		SCS (kHz)	NR BW (MHz)	Modulation	RB allocation	NR Test Freq. (MHz)	NR Test CH.			
1	High	30	20	DFT-s-OFDM QPSK	Edge_1RB_Right	2679.99	535998	534162	23	22.05
2	Middle-1	30	20	DFT-s-OFDM QPSK	Inner_Full	2636.49	527298	525462	23	22.09
3	Middle-2	30	20	DFT-s-OFDM QPSK	Inner_Full	2592.99	518598	516762	23	22.07
4	Middle-3	30	20	DFT-s-OFDM QPSK	Inner_Full	2549.51	509902	508065	23	22.05
5	Low	30	20	DFT-s-OFDM QPSK	Edge_1RB_Left	2506.02	501204	499368	23	21.76
6	High	30	100	DFT-s-OFDM QPSK	Edge_1RB_Right	2640	528000	518172	23	22.30
7	Middle	30	100	DFT-s-OFDM QPSK	Inner_Full	2616.51	523302	513471	23	22.22
8	Middle	30	100	DFT-s-OFDM QPSK	Inner_Full	2592.99	518598	508770	23	22.25
9	Middle	30	100	DFT-s-OFDM QPSK	Inner_Full	2569.5	513900	504072	23	22.26
10	Low	30	100	DFT-s-OFDM QPSK	Edge_1RB_Left	2546.01	509202	499374	23	22.45

According to the table above, the maximum power configuration is selected as the default test configuration

No.	Test Freq Description	5G-n41						Tune up	Power Results	
		SCS (kHz)	NR BW (MHz)	Modulation	RB allocation	NR Test Freq. (MHz)	NR Test CH.			
1	Low	30	100	DFT-s-OFDM Pi/2 BPSK1	Edge_1RB_Left	2546.01	509202	499374	23	22.33
2	Low	30	100	DFT-s-OFDM 16QAM	Edge_1RB_Left	2546.01	509202	499374	23	22.89
3	Low	30	100	DFT-s-OFDM 64QAM	Edge_1RB_Left	2546.01	509202	499374	23	22.34
4	Low	30	100	DFT-s-OFDM 256QAM	Edge_1RB_Left	2546.01	509202	499374	23	22.64
5	Low	30	100	CP-OFDM QPSK	Edge_1RB_Left	2546.01	509202	499374	23	22.27
6	Low	30	100	CP-OFDM 16QAM	Edge_1RB_Left	2546.01	509202	499374	23	22.13
7	Low	30	100	CP-OFDM 64QAM	Edge_1RB_Left	2546.01	509202	499374	23	22.26
8	Low	30	100	CP-OFDM 256QAM	Edge_1RB_Left	2546.01	509202	499374	22.5	21.05
9	Low	30	100	DFT-s-OFDM 16QAM	Edge_Full_Right	2546.01	509202	499374	23	21.85
10	Low	30	100	DFT-s-OFDM 16QAM	Edge_Full_Left	2546.01	509202	499374	23	22.34
11	Low	30	100	DFT-s-OFDM 16QAM	Inner_1RB_Right	2546.01	509202	499374	23	21.83
12	Low	30	100	DFT-s-OFDM 16QAM	Inner_1RB_Left	2546.01	509202	499374	23	22.35
13	Low	30	100	DFT-s-OFDM 16QAM	Outer_Full	2546.01	509202	499374	23	22.14
14	default	30	40	DFT-s-OFDM 16QAM	Edge_1RB_Left	2516.01	503202	499386	23	22.67
15	default	30	50	DFT-s-OFDM 16QAM	Edge_1RB_Left	2521.02	504204	499416	23	22.64
16	default	30	60	DFT-s-OFDM 16QAM	Edge_1RB_Left	2526	505200	499368	23	22.55
16	default	30	80	DFT-s-OFDM 16QAM	Edge_1RB_Left	2536.02	507204	499392	23	22.70
16	default	30	90	DFT-s-OFDM 16QAM	Edge_1RB_Left	2541	508200	499380	23	22.63

**Maximum Target Power for Production Unit – Level A1/B1/C1**

No.	Test Freq Description	5G-n71						Tune up	Power Results (dBm) n71
		SCS (kHz)	NR BW (MHz)	Modulation	RB allocation	NR Test Freq. (MHz)	NR Test CH.		
1	High	15	5	DFT-s-OFDM QPSK	Edge_1RB_Right	695.5	139100	23	22.56
2	Middle	15	5	DFT-s-OFDM QPSK	Inner_Full	680.5	136100	24	23.02
3	Low	15	5	DFT-s-OFDM QPSK	Edge_1RB_Left	665.5	133100	23	22.84
4	High	15	20	DFT-s-OFDM QPSK	Edge_1RB_Right	688	137600	23	22.64
5	Middle	15	20	DFT-s-OFDM QPSK	Inner_Full	680.5	136100	24	23.05
6	Low	15	20	DFT-s-OFDM QPSK	Edge_1RB_Left	673	134600	23	22.97

According to the table above, the maximum power configuration is selected as the default test configuration

No.	Test Freq Description	5G-n71						Tune up	Power Results (dBm) n71
		SCS (kHz)	NR BW (MHz)	Modulation	RB allocation	NR Test Freq. (MHz)	NR Test CH.		
1	default	15	20	DFT-s-OFDM PI/2 BPSK1	Inner_Full	680.5	136100	24	23.02
2	default	15	20	DFT-s-OFDM 16QAM	Inner_Full	680.5	136100	23	22.94
3	default	15	20	DFT-s-OFDM 64QAM	Inner_Full	680.5	136100	21.5	21.46
4	default	15	20	DFT-s-OFDM 256QAM	Inner_Full	680.5	136100	19.5	19.42
5	default	15	20	CP-OFDM QPSK	Inner_Full	680.5	136100	22.5	22.43
6	default	15	20	CP-OFDM 16QAM	Inner_Full	680.5	136100	22	21.91
7	default	15	20	CP-OFDM 64QAM	Inner_Full	680.5	136100	20.5	20.41
8	default	15	20	CP-OFDM 256QAM	Inner_Full	680.5	136100	17.5	17.42
9	default	15	20	DFT-s-OFDM QPSK	Edge_Full_Right	680.5	136100	23	22.63
10	default	15	20	DFT-s-OFDM QPSK	Edge_Full_Left	680.5	136100	23	22.88
11	default	15	20	DFT-s-OFDM QPSK	Inner_1RB_Right	680.5	136100	24	22.77
12	default	15	20	DFT-s-OFDM QPSK	Inner_1RB_Left	680.5	136100	24	23.04
13	default	15	20	DFT-s-OFDM QPSK	Outer_Full	680.5	136100	23	22.94
14	default	15	10	DFT-s-OFDM QPSK	Inner_Full	680.5	136100	24	23.01
15	default	15	15	DFT-s-OFDM QPSK	Inner_Full	680.5	136100	24	22.94

## 12 Simultaneous TX SAR Considerations

### 12.1 Introduction

The following procedures adopted from “FCC SAR Considerations for Cell Phones with Multiple Transmitters” are applicable to handsets with built-in unlicensed transmitters such as 802.11 a/b/g and Bluetooth devices which may simultaneously transmit with the licensed transmitter.

For this device, the BT and Wi-Fi can transmit simultaneous with other transmitters.

### 12.2 Transmit Antenna Separation Distances

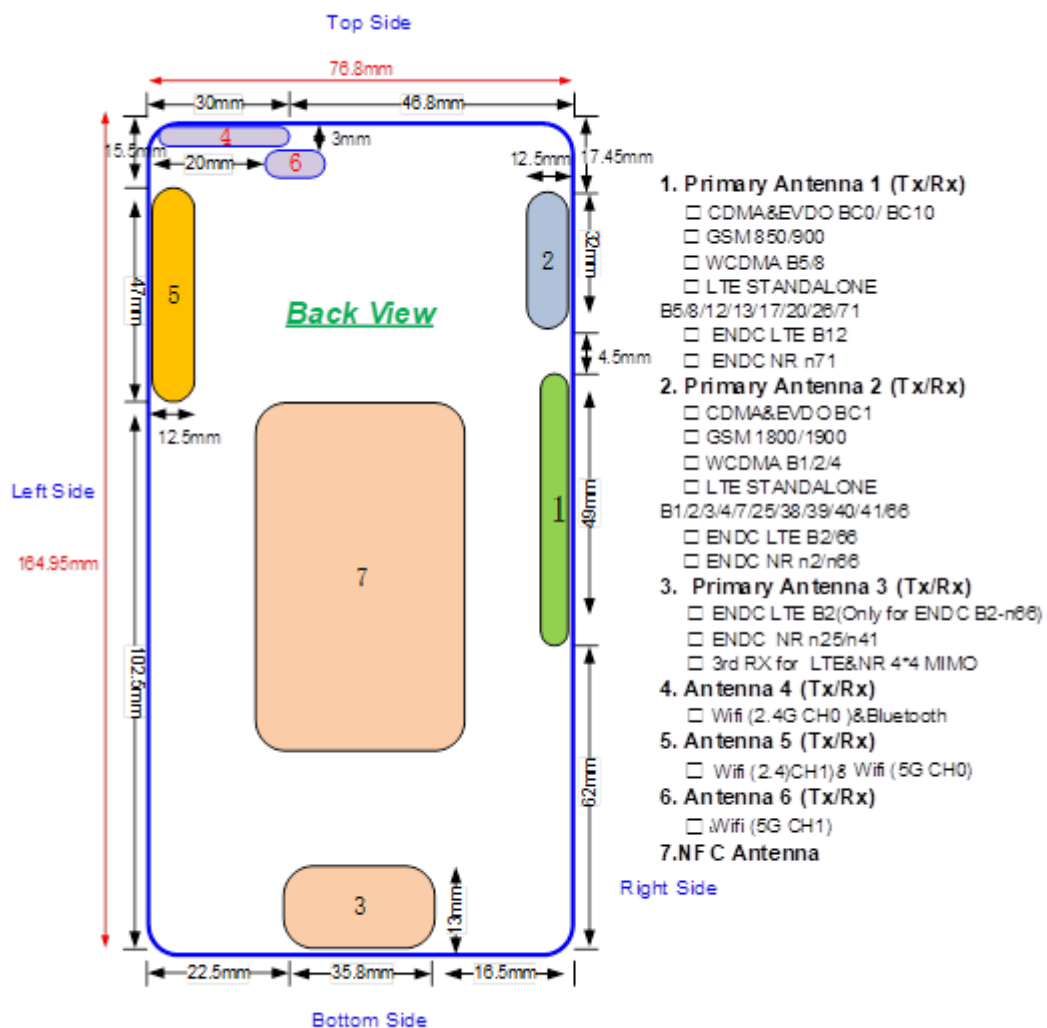

Picture 12.1 Antenna Locations

### 12.3 SAR Measurement Positions

According to the KDB941225 D06 Hot Spot SAR v01, the edges with less than 2.5 cm distance to the antennas need to be tested for SAR.

SAR measurement positions						
Mode	Front	Rear	Left edge	Right edge	Top edge	Bottom edge
ANT1	Yes	Yes	Yes	No	No	No
ANT2	Yes	Yes	Yes	No	Yes	No
ANT3	Yes	Yes	Yes	Yes	No	Yes
ANT4	Yes	Yes	No	Yes	Yes	No
ANT5	Yes	Yes	No	Yes	Yes	No
ANT6	Yes	Yes	No	Yes	Yes	No

### 12.4 Standalone SAR Test Exclusion Considerations

Standalone 1-g head or body SAR evaluation by measurement or numerical simulation is not required when the corresponding SAR Exclusion Threshold condition, listed below, is satisfied. The 1-g SAR test exclusion threshold for 100 MHz to 6 GHz at test separation distances  $\leq 50$  mm are determined by:

$$\left[ \frac{\text{max. power of channel, including tune-up tolerance, mW}}{\text{min. test separation distance, mm}} \right] \cdot \sqrt{f(\text{GHz})} \leq 3.0$$
 for 1-g SAR, where

- $f(\text{GHz})$  is the RF channel transmit frequency in GHz
- Power and distance are rounded to the nearest mW and mm before calculation
- The result is rounded to one decimal place for comparison

**Table 12.1: Standalone SAR test exclusion considerations**

Band/Mode	F(GHz)	Position	SAR test exclusion threshold(mW)	RF output power		SAR test exclusion
				dBm	mW	
Bluetooth	2.441	Head	9.60	12	15.85	No
		Body	19.20	12	15.85	Yes
2.4GHz WLAN	2.45	Head	9.58	23	199.53	No
		Body	19.17	23	199.53	No
5GHz WLAN	5.2	Head	6.58	20.5	112.20	No
		Body	13.16	20.5	112.20	No
	5.3	Head	6.52	20.5	112.20	No
		Body	13.03	20.5	112.20	No
	5.6	Head	6.34	20.5	112.20	No
		Body	12.68	20.5	112.20	No
	5.8	Head	6.23	20.5	112.20	No
		Body	12.46	20.5	112.20	No

### 13 Evaluation of Simultaneous

**Table 13.1: The sum of SAR values for Main antenna + WiFi-2.4G**

	Position	Band	Cellular antenna	WiFi-2.4G	Sum
<b>Highest reported SAR value for Head</b>	Right hand, Cheek	GSM1900	1.34	0.13	<b>1.47</b>
<b>Highest SAR value for Body</b>	Rear 10mm	ENDC N41+LTE Band2	1.26	0.15	<b>1.41</b>

**Table 13.2: The sum of SAR values for Main antenna + WiFi-5G**

	Position	Band	Cellular antenna	WiFi-5G	Sum
<b>Highest SAR value for Head</b>	Right hand, Cheek	GSM1900	1.34	0.12	<b>1.46</b>
<b>Maximum reported SAR value for Body</b>	Rear 10mm	ENDC N41+LTE Band2	1.28	0.26	<b>1.54</b>

**Table 13.3: The sum of SAR values for Main antenna + WiFi-5G +BT**

	Position	Band	Cellular antenna	WiFi-5G	BT	Sum
<b>Highest SAR value for Head</b>	Right hand, Cheek	GSM1900	1.34	0.12	<0.01	<b>1.46</b>
<b>Maximum reported SAR value for Body</b>	Rear 10mm	(ENDC N41+LTE Band2)	1.28	0.26	<0.01	<b>1.54</b>

Note1: the test positions of above tables are for the worse case that have been evaluated.

[1] – The head SAR of BT is too low to get it, so the “<0.01” is used to indicate the head SAR of BT.

	LTE	NR	Position	Reported SAR 1g(W/kg)
ENDC	LTE Band 12	N2	Head	<b>0.91</b>
	LTE Band 66	N25	Head	<b>0.76</b>
	LTE Band 2	N66	Head	<b>0.66</b>
	LTE Band 12	N66	Head	<b>0.79</b>
	LTE Band 2	N71	Head	<b>0.98</b>
	LTE Band 66	N71	Head	<b>1.02</b>
	LTE Band 2	N41	Head	<b>0.73</b>
	LTE Band 66	N41	Head	<b>0.79</b>

	LTE	NR	Position	Reported SAR 1g(W/kg)
ENDC	LTE Band 12	N2	Body 10mm	<b>1.39</b>
	LTE Band 66	N25	Body 10mm	<b>1.04</b>
	LTE Band 2	N66	Body 10mm	<b>0.73</b>
	LTE Band 12	N66	Body 10mm	<b>1.19</b>
	LTE Band 2	N71	Body 10mm	<b>1.13</b>
	LTE Band 66	N71	Body 10mm	<b>1.01</b>
	LTE Band 2	N41	Body 10mm	<b>1.28</b>
	LTE Band 66	N41	Body 10mm	<b>1.10</b>

	LTE	NR	Position	Reported SAR 1g(W/kg)
ENDC	LTE Band 12	N2	Body 15mm	<b>1.01</b>
	LTE Band 2	N66	Body 15mm	<b>0.53</b>
	LTE Band 12	N66	Body 15mm	<b>0.91</b>

**Conclusion:**

According to the above tables, the sum of reported SAR values is <math>< 1.6\text{W/kg}</math>. So the simultaneous transmission SAR with volume scans is not required.

## 14 SAR Test Result

It is determined by user manual for the distance between the EUT and the phantom bottom. The distance is 10 mm or 15mm and just applied to the condition of body worn accessory.

It is performed for all SAR measurements with area scan based 1-g SAR estimation (Fast SAR). A zoom scan measurement is added when the estimated 1-gSAR is the highest measured SAR in each exposure configuration, wireless mode and frequency band combination or more than 1.2W/kg.

The calculated SAR is obtained by the following formula:

$$\text{Reported SAR} = \text{Measured SAR} \times 10^{(P_{\text{Target}} - P_{\text{Measured}})/10}$$

Where  $P_{\text{Target}}$  is the power of manufacturing upper limit;

$P_{\text{Measured}}$  is the measured power in chapter 11.

**Table 14.1: Duty Cycle**

<b>Mode</b>	<b>Duty Cycle</b>
Speech for GSM850/1900	1:4
GPRS&EGPRS for GSM850/1900	1:4
WCDMA&LTE FDD	1:1
LTE B41 PC2	1:2.309
LTE B41 PC3	1:1.58

### 14.1 SAR results for Fast SAR

**Table 14.1-1: SAR Values (GSM 850 MHz Band - Head)**

Frequency		Side	Test Position	Figure No./Note	Conducted Power (dBm)	Max. tune-up Power (dBm)	Measured SAR(10g) (W/kg)	Reported SAR(10g) (W/kg)	Measured SAR(1g) (W/kg)	Reported SAR(1g) (W/kg)	Power Drift (dB)
Ch.	MHz										
251	848.8	Left	Touch	/	30.12	30.50	0.11	<b>0.12</b>	0.19	<b>0.21</b>	0.01
190	836.6	Left	Touch	Fig.1	30.19	30.50	0.121	<b>0.13</b>	0.217	<b>0.23</b>	-0.03
128	824.2	Left	Touch		30.10	30.50	0.114	<b>0.12</b>	0.196	<b>0.21</b>	0.08
190	836.6	Left	Tilt	/	30.19	30.50	0.023	<b>0.02</b>	0.031	<b>0.03</b>	-0.04
190	836.6	Right	Touch	/	30.19	30.50	0.046	<b>0.05</b>	0.075	<b>0.08</b>	0.11
190	836.6	Right	Tilt		30.19	30.50	0.013	<b>0.01</b>	0.017	<b>0.02</b>	0.12

Note: the head SAR of GSM850 is tested with GPRS (2Txslots) mode because of VoIP.

**Table 14.1-2: SAR Values (GSM 850 MHz Band - Body)**

Frequency		Mode (number of timeslots)	Test Position	Figure No./Note	Conducted Power (dBm)	Max. tune-up Power (dBm)	Measured SAR(10g) (W/kg)	Reported SAR(10g) (W/kg)	Measured SAR(1g) (W/kg)	Reported SAR(1g) (W/kg)	Power Drift (dB)
Ch.	MHz										
190	836.6	GPRS (2)	Front	/	30.19	30.50	0.078	<b>0.08</b>	0.126	<b>0.14</b>	-0.03
190	836.6	GPRS (2)	Rear	/	30.19	30.50	0.153	<b>0.16</b>	0.251	<b>0.27</b>	-0.08
251	848.8	GPRS (2)	Left	/	30.12	30.50	0.227	<b>0.25</b>	0.406	<b>0.44</b>	-0.05
190	836.6	GPRS (2)	Left	Fig.2	30.19	30.50	0.234	<b>0.25</b>	0.411	<b>0.44</b>	0.07
128	824.2	GPRS (2)	Left	/	30.10	30.50	0.225	<b>0.25</b>	0.401	<b>0.44</b>	-0.01
128	824.2	EGPRS (2)	Left	/	30.05	30.50	0.221	<b>0.25</b>	0.397	<b>0.44</b>	0.05

Note: The distance between the EUT and the phantom bottom is 10mm.

**Table 14.1-3: SAR Values (GSM 1900 MHz Band - Head)**

Frequency		Side	Test Position	Figure No./Note	Conducted Power (dBm)	Max. tune-up Power (dBm)	Measured SAR(10g) (W/kg)	Reported SAR(10g) (W/kg)	Measured SAR(1g) (W/kg)	Reported SAR(1g) (W/kg)	Power Drift (dB)
Ch.	MHz										
661	1880	Left	Touch	/	28.29	28.70	0.223	<b>0.25</b>	0.362	<b>0.40</b>	-0.01
661	1880	Left	Tilt	/	28.29	28.70	0.159	<b>0.17</b>	0.278	<b>0.31</b>	-0.06
810	1909.8	Right	Touch	Fig.3	28.60	28.70	0.488	<b>0.50</b>	1.01	<b>1.03</b>	-0.13
661	1880	Right	Touch	/	28.29	28.70	0.58	<b>0.64</b>	1.220	<b>1.34</b>	-0.08
512	1850.2	Right	Touch	/	28.11	28.70	0.528	<b>0.60</b>	1.04	<b>1.19</b>	0.05
661	1880	Right	Tilt	/	28.29	28.70	0.154	<b>0.17</b>	0.271	<b>0.30</b>	-0.07

Note: the head SAR of GSM1900 is tested with GPRS (2Txslots) mode because of VoIP.



**Table 14.1-4: SAR Values (GSM 1900 MHz Band - Body)**

Frequency		Mode (number of timeslots)	Test Position	Figure No./ Note	Conducted Power (dBm)	Max. tune-up Power (dBm)	Measured SAR(10g) (W/kg)	Reported SAR(10g) (W/kg)	Measured SAR(1g) (W/kg)	Reported SAR(1g) (W/kg)	Power Drift (dB)
Ch.	MHz										
Ambient Temperature: 22.9 °C						Liquid Temperature: 22.5 °C					
661	1880	GPRS (2)	Front	/	28.29	28.70	0.211	<b>0.23</b>	0.369	<b>0.41</b>	0.00
661	1880	GPRS (2)	Rear	/	28.29	28.70	0.395	<b>0.43</b>	0.773	<b>0.85</b>	-0.03
810	1909.8	GPRS (2)	Left	/	28.60	28.70	0.403	<b>0.41</b>	0.787	<b>0.81</b>	-0.07
661	1880	GPRS (2)	Left	Fig.4	28.29	28.70	0.438	<b>0.48</b>	0.862	<b>0.95</b>	-0.11
512	1850.2	GPRS (2)	Left	/	28.11	28.70	0.411	<b>0.47</b>	0.8	<b>0.92</b>	0.07
661	1880	GPRS (2)	Top	/	28.29	28.70	0.04	<b>0.04</b>	0.067	<b>0.07</b>	0.04
810	1909.8	EGPRS (2)	Left	/	28.18	28.70	0.417	<b>0.47</b>	0.822	<b>0.93</b>	0.03

Note: The distance between the EUT and the phantom bottom is 10mm.

**Table 14.1-5: SAR Values (WCDMA 850 MHz Band - Head)**

Frequency		Side	Test Position	Figure No./N ote	Conducted Power (dBm)	Max. tune-up Power (dBm)	Measure d SAR(10g ) (W/kg)	Reported SAR(10g) (W/kg)	Measured SAR(1g) (W/kg)	Reporte d SAR(1g) (W/kg)	Power Drift (dB)
Ch.	MHz										
Ambient Temperature: 22.9 °C						Liquid Temperature: 22.5 °C					
4233	846.6	Left	Touch	/	24.29	24.70	0.222	<b>0.24</b>	0.402	<b>0.44</b>	0.01
4182	836.4	Left	Touch	/	24.39	24.70	0.293	<b>0.31</b>	0.53	<b>0.57</b>	0.11
4132	826.4	Left	Touch	Fig.5	24.26	24.70	0.344	<b>0.38</b>	0.622	<b>0.69</b>	0.13
4182	836.4	Left	Tilt	/	24.39	24.70	0.054	<b>0.06</b>	0.076	<b>0.08</b>	0.10
4182	836.4	Right	Touch	/	24.39	24.70	0.154	<b>0.17</b>	0.241	<b>0.26</b>	-0.09
4182	836.4	Right	Tilt	/	24.39	24.70	0.061	<b>0.07</b>	0.08	<b>0.09</b>	0.13

**Table 14.1-6: SAR Values (WCDMA 850 MHz Band - Body)**

Frequency		Test Position	Figure No./ Note	Conducted Power (dBm)	Max. tune-up Power (dBm)	Measured SAR(10g) (W/kg)	Reported SAR(10g) (W/kg)	Measured SAR(1g) (W/kg)	Reported SAR(1g) (W/kg)	Power Drift (dB)	
Ch.	MHz										
Ambient Temperature: 22.9 °C						Liquid Temperature: 22.5 °C					
4182	836.4	Front	/	24.39	24.70	0.275	<b>0.30</b>	0.467	<b>0.50</b>	-0.13	
4182	836.4	Rear		24.39	24.70	0.348	<b>0.37</b>	0.578	<b>0.62</b>	-0.02	
4233	846.6	Left	Fig.6	24.29	24.70	0.471	<b>0.52</b>	0.84	<b>0.92</b>	0.13	
4182	836.4	Left		24.39	24.70	0.51	<b>0.55</b>	0.894	<b>0.96</b>	-0.10	
4132	826.4	Left	/	24.26	24.70	0.496	<b>0.55</b>	0.862	<b>0.95</b>	-0.07	

Note: The distance between the EUT and the phantom bottom is 10mm.

**Table 14.1-7: SAR Values (WCDMA 1700 MHz Band - Head)**

Frequency		Side	Test Position	Figure No./Note	Conducted Power (dBm)	Max. tune-up Power (dBm)	Measured SAR(10g) (W/kg)	Reported SAR(10g) (W/kg)	Measured SAR(1g) (W/kg)	Reported SAR(1g) (W/kg)	Power Drift (dB)
Ch.	MHz										
Ambient Temperature: 22.9 °C      Liquid Temperature: 22.5 °C											
1412	1732.4	Left	Touch	/	20.75	21.00	0.179	<b>0.19</b>	0.251	<b>0.27</b>	-0.13
1412	1732.4	Left	Tilt	/	20.75	21.00	0.136	<b>0.14</b>	0.194	<b>0.21</b>	0.13
1513	1752.6	Right	Touch	Fig.7	20.79	21.00	0.489	<b>0.51</b>	0.902	<b>0.95</b>	-0.04
1412	1732.4	Right	Touch	/	20.75	21.00	0.442	<b>0.47</b>	0.814	<b>0.86</b>	0.06
1312	1712.4	Right	Touch	/	20.75	21.00	0.412	<b>0.44</b>	0.753	<b>0.80</b>	0.07
1412	1732.4	Right	Tilt	/	20.75	21.00	0.18	<b>0.19</b>	0.29	<b>0.31</b>	-0.04

**Table 14.1-8: SAR Values (WCDMA 1700 MHz Band - Body)**

Frequency		Test Position	Figure No./ Note	Conducted Power (dBm)	Max. tune-up Power (dBm)	Measured SAR(10g) (W/kg)	Reported SAR(10g) (W/kg)	Measured SAR(1g) (W/kg)	Reported SAR(1g) (W/kg)	Power Drift (dB)
Ch.	MHz									
Ambient Temperature: 22.9 °C      Liquid Temperature: 22.5 °C										
1412	1732.4	Front	/	21.74	22.00	0.15	<b>0.16</b>	0.283	<b>0.30</b>	0.12
1412	1732.4	Rear	/	21.74	22.00	0.267	<b>0.28</b>	0.478	<b>0.51</b>	0.06
1513	1752.6	Left	/	21.85	22.00	0.318	<b>0.33</b>	0.632	<b>0.65</b>	-0.13
1412	1732.4	Left	/	21.74	22.00	0.347	<b>0.37</b>	0.688	<b>0.73</b>	0.09
1312	1712.4	Left	Fig.8	21.78	22.00	0.385	<b>0.41</b>	0.756	<b>0.80</b>	0.02
1412	1732.4	Top	/	21.74	22.00	0.085	<b>0.09</b>	0.142	<b>0.15</b>	0.01
1513	1752.6	Left	Note2	24.42	24.70	2.72	<b>2.90</b>	6.61	<b>7.05</b>	0.08
1412	1732.4	Left	Note2	24.46	24.70	2.97	<b>3.14</b>	7.2	<b>7.61</b>	0.14
1312	1712.4	Left	Note2	24.39	24.70	3.29	<b>3.53</b>	7.91	<b>8.50</b>	0.09

Note1: The distance between the EUT and the phantom bottom is 10mm.

Note2: The distance between the EUT and the phantom bottom is 0mm.

**Table 14.1-9: SAR Values (WCDMA 1700 MHz Band - Body)**

Frequency		Test Position	Figure No./ Note	Conducted Power (dBm)	Max. tune-up Power (dBm)	Measured SAR(10g) (W/kg)	Reported SAR(10g) (W/kg)	Measured SAR(1g) (W/kg)	Reported SAR(1g) (W/kg)	Power Drift (dB)
Ch.	MHz									
Ambient Temperature: 22.9 °C      Liquid Temperature: 22.5 °C										
1412	1732.4	Front	/	24.46	24.70	0.202	<b>0.21</b>	0.291	<b>0.31</b>	-0.08
1513	1752.6	Rear	/	24.42	24.70	0.385	<b>0.41</b>	0.614	<b>0.65</b>	0.05
1412	1732.4	Rear	/	24.46	24.70	0.474	<b>0.50</b>	0.791	<b>0.84</b>	0.00
1312	1712.4	Rear	Fig.9	24.39	24.70	0.463	<b>0.50</b>	0.806	<b>0.87</b>	0.07

Note1: The distance between the EUT and the phantom bottom is 15mm.

**Table 14.1-10: SAR Values (WCDMA 1900 MHz Band - Head)**

Frequency		Side	Test Position	Figure No./ Note	Conducted Power (dBm)	Max. tune-up Power (dBm)	Measured SAR(10g) (W/kg)	Reported SAR(10g) (W/kg)	Measured SAR(1g) (W/kg)	Reported SAR(1g) (W/kg)	Power Drift (dB)
Ch.	MHz										
Ambient Temperature: 22.9 °C      Liquid Temperature: 22.5 °C											
9400	1880	Left	Touch	/	20.78	21.00	0.195	<b>0.21</b>	0.3	<b>0.32</b>	-0.10
9400	1880	Left	Tilt	/	20.78	21.00	0.125	<b>0.13</b>	0.192	<b>0.20</b>	0.00
9538	1907.6	Right	Touch	/	20.63	21.00	0.451	<b>0.49</b>	0.875	<b>0.95</b>	-0.11
9400	1880	Right	Touch	/	20.78	21.00	0.459	<b>0.48</b>	0.885	<b>0.93</b>	0.04
9262	1852.4	Right	Touch	Fig.10	20.72	21.00	0.484	<b>0.52</b>	0.919	<b>0.98</b>	-0.04
9400	1880	Right	Tilt	/	20.78	21.00	0.214	<b>0.23</b>	0.387	<b>0.41</b>	-0.11

**Table 14.1-11: SAR Values (WCDMA 1900 MHz Band - Body)**

Frequency		Test Position	Figure No./ Note	Conducted Power (dBm)	Max. tune-up Power (dBm)	Measured SAR(10g) (W/kg)	Reported SAR(10g) (W/kg)	Measured SAR(1g) (W/kg)	Reported SAR(1g) (W/kg)	Power Drift (dB)
Ch.	MHz									
Ambient Temperature: 22.9 °C      Liquid Temperature: 22.5 °C										
9400	1880	Front	/	21.81	22.00	0.179	<b>0.19</b>	0.336	<b>0.35</b>	0.01
9400	1880	Rear	/	21.81	22.00	0.27	<b>0.28</b>	0.476	<b>0.50</b>	-0.12
9538	1907.6	Left	Fig.11	21.77	22.00	0.509	<b>0.54</b>	0.999	<b>1.05</b>	-0.13
9400	1880	Left	/	21.81	22.00	0.468	<b>0.49</b>	0.938	<b>0.98</b>	-0.02
9262	1852.4	Left	/	21.65	22.00	0.49	<b>0.53</b>	0.961	<b>1.04</b>	0.02
9400	1880	Top	/	21.81	22.00	0.093	<b>0.10</b>	0.158	<b>0.17</b>	0.09
9538	1907.6	Left	Note2	24.06	24.20	1.85	<b>1.91</b>	4.33	<b>4.47</b>	0.08

Note1: The distance between the EUT and the phantom bottom is 10mm.

Note2: The distance between the EUT and the phantom bottom is 10mm.

**Table 14.1-12: SAR Values (WCDMA 1900 MHz Band - Body)**

Frequency		Test Position	Figure No./ Note	Conducted Power (dBm)	Max. tune-up Power (dBm)	Measured SAR(10g) (W/kg)	Reported SAR(10g) (W/kg)	Measured SAR(1g) (W/kg)	Reported SAR(1g) (W/kg)	Power Drift (dB)
Ch.	MHz									
Ambient Temperature: 22.9 °C      Liquid Temperature: 22.5 °C										
9400	1880	Front	/	24.37	24.20	0.067	<b>0.06</b>	0.099	<b>0.10</b>	0.13
9538	1907.6	Rear	/	24.06	24.20	0.177	<b>0.18</b>	0.256	<b>0.26</b>	0.05
9400	1880	Rear	Fig.12	24.14	24.20	0.21	<b>0.21</b>	0.375	<b>0.38</b>	-0.04
9262	1852.4	Rear	/	24.07	24.20	0.178	<b>0.18</b>	0.265	<b>0.27</b>	0.04

Note1: The distance between the EUT and the phantom bottom is 15mm.

**Table 14.1-13: SAR Values (CDMA BC0 - Head)**

Frequency		Side	Test Position	Figure No.	Conducted Power (dBm)	Max. tune-up Power (dBm)	Measured SAR(10g) (W/kg)	Reported SAR(10g) (W/kg)	Measured SAR(1g) (W/kg)	Reported SAR(1g) (W/kg)	Power Drift (dB)
Ch.	MHz										
Ambient Temperature: 22.9 °C      Liquid Temperature: 22.5 °C											
777	848.31	Left	Touch	/	24.66	25	0.148	<b>0.16</b>	0.272	<b>0.29</b>	0.13
384	836.52	Left	Touch	/	24.7	25	0.228	<b>0.24</b>	0.419	<b>0.45</b>	-0.07
1013	824.7	Left	Touch	Fig.13	24.67	25	0.279	<b>0.30</b>	0.505	<b>0.54</b>	-0.04
384	836.52	Left	Tilt	/	24.7	25	0.05	<b>0.05</b>	0.071	<b>0.08</b>	-0.01
1013	824.7	Right	Touch	/	24.7	25	0.147	<b>0.16</b>	0.237	<b>0.25</b>	0.06
384	836.52	Right	Tilt	/	24.7	25	0.043	<b>0.05</b>	0.065	<b>0.07</b>	0.04

**Table 14.1-14: SAR Values (CDMA BC0 - Body)**

Frequency		Test Position	Figure No.	Conducted Power (dBm)	Max. tune-up Power (dBm)	Measured SAR(10g) (W/kg)	Reported SAR(10g) (W/kg)	Measured SAR(1g) (W/kg)	Reported SAR(1g) (W/kg)	Power Drift (dB)
Ch.	MHz									
Ambient Temperature: 22.9 °C      Liquid Temperature: 22.5 °C										
384	836.52	Front	/	24.7	25	0.273	<b>0.29</b>	0.431	<b>0.46</b>	-0.02
384	836.52	Rear	/	24.7	25	0.339	<b>0.36</b>	0.537	<b>0.58</b>	-0.12
777	848.31	Left	/	24.65	25	0.308	<b>0.33</b>	0.63	<b>0.68</b>	0.05
384	836.52	Left	/	24.7	25	0.328	<b>0.35</b>	0.619	<b>0.66</b>	0.07
1013	824.7	Left	Fig.14	24.66	25	0.34	<b>0.37</b>	0.646	<b>0.70</b>	0.03

Note1: The distance between the EUT and the phantom bottom is 10mm

**Table 14.1-15: SAR Values (CDMA BC1 - Head)**

Frequency		Side	Test Position	Figure No.	Conducted Power (dBm)	Max. tune-up Power (dBm)	Measured SAR(10g) (W/kg)	Reported SAR(10g) (W/kg)	Measured SAR(1g) (W/kg)	Reported SAR(1g) (W/kg)	Power Drift (dB)
Ch.	MHz										
Ambient Temperature: 22.9 °C      Liquid Temperature: 22.5 °C											
1175	1908.75	Left	Touch	/	21.11	21.5	0.333	<b>0.36</b>	0.605	<b>0.66</b>	0.12
600	1880	Left	Touch	Fig.15	21.17	21.5	0.464	<b>0.50</b>	0.846	<b>0.91</b>	0.07
25	1851.25	Left	Touch		21.12	21.5	0.401	<b>0.44</b>	0.729	<b>0.80</b>	0.03
600	1880	Left	Tilt	/	21.17	21.5	0.162	<b>0.17</b>	0.296	<b>0.32</b>	-0.02
600	1880	Right	Touch		21.17	21.5	0.23	<b>0.25</b>	0.419	<b>0.45</b>	0.04
600	1880	Right	Tilt	/	21.17	21.5	0.182	<b>0.20</b>	0.341	<b>0.37</b>	0.04

**Table 14.1-16: SAR Values (CDMA BC1 - Body)**

Frequency		Test Position	Figure No.	Conducted Power (dBm)	Max. tune-up Power (dBm)	Ambient Temperature: 22.9 °C		Liquid Temperature: 22.5 °C		Power Drift (dB)
Ch.	MHz					Measured SAR(10g) (W/kg)	Reported SAR(10g) (W/kg)	Measured SAR(1g) (W/kg)	Reported SAR(1g) (W/kg)	
600	1880	Front	/	21.24	21.5	0.156	<b>0.17</b>	0.277	<b>0.29</b>	0.03
600	1880	Rear	/	21.24	21.5	0.382	<b>0.41</b>	0.709	<b>0.75</b>	-0.11
1175	1908.75	Left	/	21.14	21.5	0.379	<b>0.41</b>	0.748	<b>0.81</b>	0.01
600	1880	Left	/	21.24	21.5	0.402	<b>0.43</b>	0.778	<b>0.83</b>	-0.06
25	1851.25	Left	Fig.16	21.11	21.5	0.45	<b>0.49</b>	0.881	<b>0.96</b>	-0.10
600	1880	Top	/	21.24	21.5	0.019	<b>0.02</b>	0.031	<b>0.03</b>	0.00
25	1851.25	Left	Note2	24.7	25	1.62	<b>1.74</b>	3.85	<b>4.13</b>	0.02

Note1: The distance between the EUT and the phantom bottom is 10mm

Note2: The distance between the EUT and the phantom bottom is 0mm

**Table 14.1-17: SAR Values (CDMA BC1 - Body)**

Frequency		Test Position	Figure No.	Conducted Power (dBm)	Max. tune-up Power (dBm)	Ambient Temperature: 22.9 °C		Liquid Temperature: 22.5 °C		Power Drift (dB)
Ch.	MHz					Measured SAR(10g) (W/kg)	Reported SAR(10g) (W/kg)	Measured SAR(1g) (W/kg)	Reported SAR(1g) (W/kg)	
600	1880	Front	/	24.75	25	0.268	<b>0.28</b>	0.481	<b>0.51</b>	-0.08
1175	1908.75	Rear	/	24.72	25	0.356	<b>0.38</b>	0.64	<b>0.68</b>	0.07
600	1880	Rear	/	24.75	25	0.386	<b>0.41</b>	0.69	<b>0.73</b>	0.01
25	1851.25	Rear	Fig.17	24.7	25	0.414	<b>0.44</b>	0.733	<b>0.79</b>	-0.06

Note1: The distance between the EUT and the phantom bottom is 15mm

**Table 14.1-18: SAR Values (CDMA BC10 - Head)**

Frequency		Side	Test Position	Figure No.	Conducted Power (dBm)	Max. tune-up Power (dBm)	Ambient Temperature: 22.9 °C		Liquid Temperature: 22.5 °C		Power Drift (dB)
Ch.	MHz						Measured SAR(10g) (W/kg)	Reported SAR(10g) (W/kg)	Measured SAR(1g) (W/kg)	Reported SAR(1g) (W/kg)	
684	823.1	Left	Touch	/	24.69	25	0.269	<b>0.29</b>	0.491	<b>0.53</b>	-0.02
580	820.5	Left	Touch	/	24.7	25	0.293	<b>0.31</b>	0.533	<b>0.57</b>	0.09
476	817.9	Left	Touch	Fig.18	24.64	25	0.292	<b>0.32</b>	0.534	<b>0.58</b>	-0.09
580	820.5	Left	Tilt	/	24.7	25	0.054	<b>0.06</b>	0.069	<b>0.07</b>	-0.04
580	820.5	Right	Touch	/	24.7	25	0.067	<b>0.07</b>	0.104	<b>0.11</b>	0.08
580	820.5	Right	Tilt	/	24.7	25	0.046	<b>0.05</b>	0.066	<b>0.07</b>	-0.10

**Table 14.1-19: SAR Values (CDMA BC0 - Body)**

Ambient Temperature: 22.9 °C					Liquid Temperature: 22.5 °C					
Frequency		Test Position	Figure No.	Conducted Power (dBm)	Max. tune-up Power (dBm)	Measured SAR(10g) (W/kg)	Reported SAR(10g) (W/kg)	Measured SAR(1g) (W/kg)	Reported SAR(1g) (W/kg)	Power Drift (dB)
Ch.	MHz									
580	820.5	Front	/	24.7	25	0.167	<b>0.18</b>	0.295	<b>0.32</b>	0.12
580	820.5	Rear		24.7	25	0.239	<b>0.26</b>	0.422	<b>0.45</b>	0.08
684	823.1	Left		24.7	25	0.331	<b>0.35</b>	0.634	<b>0.68</b>	0.06
580	820.5	Left		24.7	25	0.338	<b>0.36</b>	0.657	<b>0.70</b>	-0.12
476	817.9	Left	Fig.19	24.65	25	0.363	<b>0.39</b>	0.696	<b>0.75</b>	-0.06

Note1: The distance between the EUT and the phantom bottom is 10mm

**Table 14.1-20: SAR Values (LTE Band7 - Head)**

Ambient Temperature: 22.9 °C					Liquid Temperature: 22.5 °C							
Frequency		Mode	Side	Test Position	Figure No./ Note	Conducted Power (dBm)	Max. tune-up Power (dBm)	Measured SAR(10g) (W/kg)	Reported SAR(10g) (W/kg)	Measured SAR(1g) (W/kg)	Reported SAR(1g) (W/kg)	Power Drift (dB)
Ch.	MHz											
21100	2535	1RB_High	Left	Touch	/	20.67	21.20	0.068	<b>0.08</b>	0.143	<b>0.16</b>	0.05
21100	2535	1RB_High	Left	Tilt	/	20.67	21.20	0.047	<b>0.05</b>	0.103	<b>0.12</b>	0.01
21100	2535	1RB_High	Right	Touch	/	20.67	21.20	0.217	<b>0.25</b>	0.464	<b>0.52</b>	0.09
21100	2535	1RB_High	Right	Tilt	/	20.67	21.20	0.102	<b>0.12</b>	0.227	<b>0.26</b>	0.12
21100	2535	50RB_High	Left	Touch	/	20.74	21.20	0.071	<b>0.08</b>	0.148	<b>0.16</b>	0.02
21100	2535	50RB_High	Left	Tilt	/	20.74	21.20	0.048	<b>0.05</b>	0.105	<b>0.12</b>	0.05
21100	2535	50RB_High	Right	Touch	Fig.20	20.74	21.20	0.221	<b>0.25</b>	0.47	<b>0.52</b>	-0.01
21100	2535	50RB_High	Right	Tilt	/	20.74	21.20	0.105	<b>0.12</b>	0.235	<b>0.26</b>	0.02

Note1: The LTE mode is QPSK\_20MHz.

**Table 14.1-21: SAR Values (LTE Band7 - Body)**

Ambient Temperature: 22.9 °C					Liquid Temperature: 22.5 °C						
Frequency		Mode	Test Position	Figure No./ Note	Conducted Power (dBm)	Max. tune-up Power (dBm)	Measured SAR(10g) (W/kg)	Reported SAR(10g) (W/kg)	Measured SAR(1g) (W/kg)	Reported SAR(1g) (W/kg)	Power Drift (dB)
Ch.	MHz										
21100	2535	1RB_High	Front	/	21.58	21.70	0.069	<b>0.07</b>	0.133	<b>0.14</b>	0.12
21350	2560	1RB_High	Rear	Fig.21	21.55	21.70	0.412	<b>0.43</b>	0.966	<b>1.00</b>	0.05
21100	2535	1RB_High	Rear	/	21.58	21.70	0.348	<b>0.36</b>	0.817	<b>0.84</b>	0.05
20850	2510	1RB_High	Rear	/	21.41	21.70	0.352	<b>0.38</b>	0.828	<b>0.89</b>	0.11
21100	2535	1RB_High	Left	/	21.58	21.70	0.225	<b>0.23</b>	0.473	<b>0.49</b>	0.07
21100	2535	1RB_High	Top	/	21.64	21.70	0.03	<b>0.03</b>	0.054	<b>0.05</b>	-0.09
21350	2560	50RB_High	Front	/	21.64	21.70	0.076	<b>0.08</b>	0.147	<b>0.15</b>	-0.06
21350	2560	50RB_High	Rear	/	21.64	21.70	0.41	<b>0.42</b>	0.956	<b>0.97</b>	-0.01

21100	2535	50RB_High	Rear	/	21.59	21.70	0.361	<b>0.37</b>	0.827	<b>0.85</b>	-0.12
20850	2510	50RB_High	Rear	/	21.50	21.70	0.335	<b>0.35</b>	0.78	<b>0.82</b>	0.02
21350	2560	50RB_High	Left	/	21.64	21.70	0.2	<b>0.20</b>	0.424	<b>0.43</b>	0.07
21350	2560	50RB_High	Top	/	21.64	21.70	0.027	<b>0.03</b>	0.047	<b>0.05</b>	-0.03
21350	2560	100RB	Rear	/	21.55	21.70	0.394	<b>0.41</b>	0.914	<b>0.95</b>	0.15
21350	2560	1RB_High	Rear	Note3	22.85	23.50	3.4	<b>3.95</b>	10.6	<b>12.31</b>	0.08
21100	2535	1RB_High	Rear	Note3	22.88	23.50	2.87	<b>3.31</b>	8.97	<b>10.35</b>	0.02
20850	2510	1RB_High	Rear	Note3	22.80	23.50	2.9	<b>3.41</b>	9.09	<b>10.68</b>	0.14

Note1: The distance between the EUT and the phantom bottom is 10mm.

Note2: The distance between the EUT and the phantom bottom is 0mm.

Note3: The LTE mode is QPSK\_20MHz.

**Table 14.1-22: SAR Values (LTE Band7 - Body)**

Ambient Temperature: 22.9 °C						Liquid Temperature: 22.5 °C					
Frequency		Mode	Test Position	Figure No./ Note	Conducted Power (dBm)	Max. tune-up Power (dBm)	Measured SAR(10g) (W/kg)	Reported SAR(10g) (W/kg)	Measured SAR(1g) (W/kg)	Reported SAR(1g) (W/kg)	Power Drift (dB)
Ch.	MHz										
21100	2535	1RB_High	Front	/	22.88	23.50	0.043	<b>0.05</b>	0.079	<b>0.09</b>	0.13
21100	2535	1RB_High	Rear	Fig.22	22.88	23.50	0.194	<b>0.22</b>	0.400	<b>0.46</b>	0.12
21100	2535	50RB_High	Front	/	21.98	22.50	0.034	<b>0.04</b>	0.061	<b>0.07</b>	0.04
21100	2535	50RB_High	Rear	/	21.98	22.50	0.173	<b>0.20</b>	0.357	<b>0.40</b>	0.00

Note1: The distance between the EUT and the phantom bottom is 15mm.

**Table 14.1-23: SAR Values (LTE Band12 - Head)**

Ambient Temperature: 22.9 °C						Liquid Temperature: 22.5 °C						
Frequency		Mode	Side	Test Position	Figure No.	Conducted Power (dBm)	Max. tune-up Power (dBm)	Measured SAR(10g) (W/kg)	Reported SAR(10g) (W/kg)	Measured SAR(1g) (W/kg)	Reported SAR(1g) (W/kg)	Power Drift (dB)
Ch.	MHz											
23095	707.5	1RB_Mid	Left	Touch	Fig.23	24.31	24.70	0.402	<b>0.44</b>	0.723	<b>0.79</b>	-0.07
23095	707.5	1RB_Mid	Left	Tilt	/	24.31	24.70	0.081	<b>0.09</b>	0.113	<b>0.12</b>	-0.05
23095	707.5	1RB_Mid	Right	Touch	/	24.31	24.70	0.192	<b>0.21</b>	0.341	<b>0.37</b>	0.03
23095	707.5	1RB_Mid	Right	Tilt	/	24.31	24.70	0.037	<b>0.04</b>	0.062	<b>0.07</b>	-0.13
23060	704	25RB_Mid	Left	Touch	/	23.38	23.70	0.329	<b>0.35</b>	0.591	<b>0.64</b>	-0.08
23060	704	25RB_Mid	Left	Tilt	/	23.38	23.70	0.058	<b>0.06</b>	0.084	<b>0.09</b>	0.06
23060	704	25RB_Mid	Right	Touch	/	23.38	23.70	0.136	<b>0.15</b>	0.247	<b>0.27</b>	0.13
23060	704	25RB_Mid	Right	Tilt	/	23.38	23.70	0.046	<b>0.05</b>	0.065	<b>0.07</b>	0.13

Note1: The LTE mode is QPSK\_10MHz.

**Table 14.1-24: SAR Values (LTE Band12 - Body)**

Ambient Temperature: 22.9 °C						Liquid Temperature: 22.5 °C					
Frequency		Mode	Test Position	Figure No.	Conducted Power (dBm)	Max. tune-up Power (dBm)	Measured SAR(10g) (W/kg)	Reported SAR(10g) (W/kg)	Measured SAR(1g) (W/kg)	Reported SAR(1g) (W/kg)	Power Drift (dB)
Ch.	MHz										
23095	707.5	1RB_Mid	Front	/	24.31	24.70	0.295	<b>0.32</b>	0.466	<b>0.51</b>	0.00
23095	707.5	1RB_Mid	Rear	/	24.31	24.70	0.382	<b>0.42</b>	0.602	<b>0.66</b>	-0.07
23095	707.5	1RB_Mid	Left	Fig.24	24.29	24.70	0.373	<b>0.41</b>	0.639	<b>0.70</b>	0.05
23060	704	25RB_Mid	Front	/	23.38	23.70	0.231	<b>0.25</b>	0.365	<b>0.39</b>	-0.08
23060	704	25RB_Mid	Rear	/	23.38	23.70	0.295	<b>0.32</b>	0.467	<b>0.50</b>	0.00
23060	704	25RB_Mid	Left	/	23.38	23.70	0.306	<b>0.33</b>	0.524	<b>0.56</b>	0.05

Note1: The distance between the EUT and the phantom bottom is 10mm.

Note2: The LTE mode is QPSK\_10MHz.

**Table 14.1-25: SAR Values (LTE Band13 - Head)**

Ambient Temperature: 22.9 °C						Liquid Temperature: 22.5 °C						
Frequency		Mode	Side	Test Position	Figure No.	Conducted Power (dBm)	Max. tune-up Power (dBm)	Measured SAR(10g) (W/kg)	Reported SAR(10g) (W/kg)	Measured SAR(1g) (W/kg)	Reported SAR(1g) (W/kg)	Power Drift (dB)
Ch.	MHz											
23230	782	1RB_High	Left	Touch	Fig.25	24.02	24.70	0.125	<b>0.15</b>	0.232	<b>0.27</b>	0.00
23230	782	1RB_High	Left	Tilt	/	24.02	24.70	0.022	<b>0.03</b>	0.033	<b>0.04</b>	0.10
23230	782	1RB_High	Right	Touch	/	24.02	24.70	0.066	<b>0.08</b>	0.109	<b>0.13</b>	0.13
23230	782	1RB_High	Right	Tilt	/	24.02	24.70	0.019	<b>0.02</b>	0.025	<b>0.03</b>	-0.05
23230	782	25RB_High	Left	Touch	/	23.07	23.70	0.117	<b>0.14</b>	0.202	<b>0.23</b>	-0.10
23230	782	25RB_High	Left	Tilt	/	23.07	23.70	0.022	<b>0.03</b>	0.029	<b>0.03</b>	-0.01
23230	782	25RB_High	Right	Touch	/	23.07	23.70	0.049	<b>0.06</b>	0.083	<b>0.10</b>	0.03
23230	782	25RB_High	Right	Tilt	/	23.07	23.70	0.015	<b>0.02</b>	0.021	<b>0.02</b>	0.07

Note1: The LTE mode is QPSK\_10MHz.

**Table 14.1-26: SAR Values (LTE Band13 - Body)**

Ambient Temperature: 22.9 °C						Liquid Temperature: 22.5 °C					
Frequency		Mode	Test Position	Figure No.	Conducted Power (dBm)	Max. tune-up Power (dBm)	Measured SAR(10g) (W/kg)	Reported SAR(10g) (W/kg)	Measured SAR(1g) (W/kg)	Reported SAR(1g) (W/kg)	Power Drift (dB)
Ch.	MHz										
23230	782	1RB_Mid	Front	/	24.02	24.70	0.148	<b>0.17</b>	0.235	<b>0.27</b>	-0.07
23230	782	1RB_Mid	Rear	/	24.02	24.70	0.192	<b>0.22</b>	0.309	<b>0.36</b>	-0.08
23230	782	1RB_Mid	Left	Fig.26	24.02	24.70	0.196	<b>0.23</b>	0.343	<b>0.40</b>	-0.10
23230	782	25RB_Mid	Front	/	23.07	23.70	0.114	<b>0.13</b>	0.184	<b>0.21</b>	-0.08
23230	782	25RB_Mid	Rear	/	23.07	23.70	0.156	<b>0.18</b>	0.251	<b>0.29</b>	0.02
23230	782	25RB_Mid	Left	/	23.07	23.70	0.158	<b>0.18</b>	0.287	<b>0.33</b>	0.10



Note1: The distance between the EUT and the phantom bottom is 10mm.

Note2: The LTE mode is QPSK\_10MHz.

**Table 14.1-27: SAR Values (LTE Band25 - Head)**

Ambient Temperature: 22.9 °C						Liquid Temperature: 22.5°C						
Frequency		Mode	Side	Test Position	Figure No.	Conducted Power (dBm)	Max. tune-up Power (dBm)	Measured SAR(10g) (W/kg)	Reported SAR(10g) (W/kg)	Measured SAR(1g) (W/kg)	Reported SAR(1g) (W/kg)	Power Drift (dB)
Ch.	MHz											
26365	1882.5	1RB_Mid	Left	Touch	/	20.46	20.70	0.142	<b>0.15</b>	0.233	<b>0.25</b>	0.04
26365	1882.5	1RB_Mid	Left	Tilt	/	20.46	20.70	0.081	<b>0.09</b>	0.131	<b>0.14</b>	-0.06
26590	1905	1RB_Mid	Right	Touch	/	20.42	20.70	0.33	<b>0.35</b>	0.67	<b>0.71</b>	0.01
26365	1882.5	1RB_Mid	Right	Touch	/	20.46	20.70	0.362	<b>0.38</b>	0.772	<b>0.82</b>	0.04
26140	1860	1RB_High	Right	Touch	Fig.27	20.32	20.70	0.42	<b>0.46</b>	0.849	<b>0.93</b>	0.06
26365	1882.5	1RB_Mid	Right	Tilt	/	20.46	20.70	0.101	<b>0.11</b>	0.18	<b>0.19</b>	0.06
26590	1905	50RB_Mid	Left	Touch	/	20.61	20.70	0.145	<b>0.15</b>	0.227	<b>0.23</b>	0.07
26590	1905	50RB_Mid	Left	Tilt	/	20.61	20.70	0.081	<b>0.08</b>	0.134	<b>0.14</b>	0.08
26590	1905	50RB_Mid	Right	Touch	/	20.61	20.70	0.4	<b>0.41</b>	0.806	<b>0.82</b>	-0.12
26365	1882.5	50RB_High	Right	Touch	/	20.56	20.70	0.316	<b>0.33</b>	0.602	<b>0.62</b>	0.12
26140	1860	50RB_Mid	Right	Touch	/	20.52	20.70	0.325	<b>0.34</b>	0.67	<b>0.70</b>	0.05
26365	1882.5	50RB_Mid	Right	Tilt	/	20.61	20.70	0.119	<b>0.12</b>	0.223	<b>0.23</b>	-0.03
26140	1860	100RB	Right	Touch	/	20.58	20.70	0.331	<b>0.34</b>	0.714	<b>0.73</b>	0.18

Note1: The LTE mode is QPSK\_20MHz.

**Table 14.1-28: SAR Values (LTE Band25 - Body)**

Ambient Temperature: 22.9 °C						Liquid Temperature: 22.5°C					
Frequency		Mode	Test Position	Figure No.	Conducted Power (dBm)	Max. tune-up Power (dBm)	Measured SAR(10g) (W/kg)	Reported SAR(10g) (W/kg)	Measured SAR(1g) (W/kg)	Reported SAR(1g) (W/kg)	Power Drift (dB)
Ch.	MHz										
26365	1882.5	1RB_Low	Front	/	21.69	21.70	0.175	<b>0.18</b>	0.346	<b>0.35</b>	-0.10
26365	1882.5	1RB_Low	Rear	/	21.69	21.70	0.385	<b>0.39</b>	0.73	<b>0.73</b>	-0.05
26590	1905	1RB_Low	Left	/	21.65	21.70	0.429	<b>0.43</b>	0.829	<b>0.84</b>	-0.06
26365	1882.5	1RB_Low	Left	/	21.69	21.70	0.44	<b>0.44</b>	0.882	<b>0.88</b>	0.01
26140	1860	1RB_Low	Left	Fig.28	21.59	21.70	0.518	<b>0.53</b>	1.02	<b>1.05</b>	-0.08
26365	1882.5	1RB_Low	Top	/	21.69	21.70	0.135	<b>0.14</b>	0.226	<b>0.23</b>	-0.06
26365	1882.5	50RB_High	Front	/	21.69	21.70	0.161	<b>0.16</b>	0.297	<b>0.30</b>	-0.11
26590	1905	50RB_High	Rear	/	21.68	21.70	0.374	<b>0.38</b>	0.724	<b>0.73</b>	-0.10
26365	1882.5	50RB_High	Rear	/	21.69	21.70	0.434	<b>0.44</b>	0.842	<b>0.84</b>	0.04
26140	1860	50RB_Mid	Rear	/	21.68	21.70	0.408	<b>0.41</b>	0.777	<b>0.78</b>	0.09
26590	1905	50RB_High	Left	/	21.68	21.70	0.443	<b>0.45</b>	0.875	<b>0.88</b>	-0.11
26365	1882.5	50RB_High	Left	/	21.69	21.70	0.432	<b>0.43</b>	0.855	<b>0.86</b>	-0.02

26140	1860	50RB_Mid	Left	/	21.68	21.70	0.497	<b>0.50</b>	0.994	<b>1.00</b>	-0.08
26365	1882.5	50RB_High	Top	/	21.69	21.70	0.125	<b>0.13</b>	0.214	<b>0.21</b>	0.00
26140	1860	100RB	Rear	/	21.65	21.70	0.371	<b>0.38</b>	0.722	<b>0.73</b>	0.15
26140	1860	100RB	Left	/	21.65	21.70	0.391	<b>0.40</b>	0.766	<b>0.77</b>	0.07
26590	1905	1RB_Low	Left	Note2	23.09	24.70	1.57	<b>2.27</b>	1.99	<b>2.88</b>	0.08
26365	1882.5	1RB_High	Left	Note2	23.56	24.70	1.61	<b>2.09</b>	2.12	<b>2.76</b>	0.14
26140	1860	1RB_Mid	Left	Note2	23.59	24.70	1.9	<b>2.45</b>	2.45	<b>3.16</b>	-0.26

Note1: The distance between the EUT and the phantom bottom is 10mm

Note2: The distance between the EUT and the phantom bottom is 0mm

**Table 14.1-29: SAR Values (LTE Band25 - Body)**

Ambient Temperature: 22.9 °C      Liquid Temperature: 22.5 °C											
Frequency		Mode	Test Position	Figure No.	Conducted Power (dBm)	Max. tune-up Power (dBm)	Measured SAR(10g) (W/kg)	Reported SAR(10g) (W/kg)	Measured SAR(1g) (W/kg)	Reported SAR(1g) (W/kg)	Power Drift (dB)
Ch.	MHz										
26140	1860	1RB_Mid	Front	/	23.59	24.70	0.075	<b>0.10</b>	0.119	<b>0.15</b>	0.08
26140	1860	1RB_Mid	Rear	Fig.29	23.59	24.70	0.158	<b>0.20</b>	0.281	<b>0.36</b>	0.12
26590	1905	50RB_Mid	Front	/	22.79	23.70	0.06	<b>0.07</b>	0.095	<b>0.12</b>	0.06
26590	1905	50RB_Mid	Rear	/	22.79	23.70	0.104	<b>0.13</b>	0.17	<b>0.21</b>	0.09

Note1: The distance between the EUT and the phantom bottom is 15mm

**Table 14.1-30: SAR Values (LTE Band26 - Head)**

Ambient Temperature: 22.9 °C      Liquid Temperature: 22.5 °C												
Frequency		Mode	Side	Test Position	Figure No.	Conducted Power (dBm)	Max. tune-up Power (dBm)	Measured SAR(10g) (W/kg)	Reported SAR(10g) (W/kg)	Measured SAR(1g) (W/kg)	Reported SAR(1g) (W/kg)	Power Drift (dB)
Ch.	MHz											
26775	822.5	1RB_Low	Left	Touch	/	23.99	24.70	0.182	<b>0.21</b>	0.334	<b>0.39</b>	-0.08
26775	822.5	1RB_Low	Left	Tilt	/	23.99	24.70	0.037	<b>0.04</b>	0.058	<b>0.07</b>	0.02
26775	822.5	1RB_Low	Right	Touch	/	23.99	24.70	0.114	<b>0.13</b>	0.198	<b>0.23</b>	0.07
26775	822.5	1RB_Low	Right	Tilt	/	23.99	24.70	0.024	<b>0.03</b>	0.038	<b>0.04</b>	-0.06
26775	822.5	36RB_Mid	Left	Touch	Fig.30	23.10	23.70	0.275	<b>0.32</b>	0.497	<b>0.57</b>	0.13
26775	822.5	36RB_Mid	Left	Tilt	/	23.10	23.70	0.033	<b>0.04</b>	0.052	<b>0.06</b>	-0.12
26775	822.5	36RB_Mid	Right	Touch	/	23.10	23.70	0.159	<b>0.18</b>	0.281	<b>0.32</b>	-0.12
26775	822.5	36RB_Mid	Right	Tilt	/	23.10	23.70	0.03	<b>0.03</b>	0.044	<b>0.05</b>	0.12

Note1: The LTE mode is QPSK\_15MHz.

**Table 14.1-31: SAR Values (LTE Band26 - Body)**

Ambient Temperature: 22.9 °C						Liquid Temperature: 22.5°C					
Frequency		Mode	Test Position	Figure No.	Conducted Power (dBm)	Max. tune-up Power (dBm)	Measured SAR(10g) (W/kg)	Reported SAR(10g) (W/kg)	Measured SAR(1g) (W/kg)	Reported SAR(1g) (W/kg)	Power Drift (dB)
Ch.	MHz										
26775	822.5	1RB_Low	Front	/	23.99	24.70	0.291	<b>0.34</b>	0.499	<b>0.59</b>	-0.12
26775	822.5	1RB_Low	Rear	/	23.99	24.70	0.32	<b>0.38</b>	0.549	<b>0.65</b>	0.09
26965	841.5	1RB_Mid	Left	/	23.92	24.70	0.438	<b>0.52</b>	0.796	<b>0.95</b>	0.04
26865	831.5	1RB_Mid	Left	Fig.31	23.94	24.70	0.534	<b>0.64</b>	0.941	<b>1.12</b>	0.10
26775	822.5	1RB_Low	Left	/	23.99	24.70	0.519	<b>0.61</b>	0.939	<b>1.11</b>	0.12
26775	822.5	36RB_Mid	Front	/	23.10	23.70	0.24	<b>0.28</b>	0.417	<b>0.48</b>	0.03
26775	822.5	36RB_Mid	Rear	/	23.10	23.70	0.23	<b>0.26</b>	0.383	<b>0.44</b>	-0.05
26775	822.5	36RB_Mid	Left	/	23.10	23.70	0.358	<b>0.41</b>	0.656	<b>0.75</b>	0.11
26775	822.5	75RB	Left	/	23.08	23.70	0.269	<b>0.31</b>	0.607	<b>0.70</b>	-0.16

Note1: The distance between the EUT and the phantom bottom is 10mm.

Note2: The LTE mode is QPSK\_15MHz.

**Table 14.1-32: SAR Values (LTE Band41 PC2 - Head)**

Ambient Temperature: 22.9 °C						Liquid Temperature: 22.5°C						
Frequency		Mode	Side	Test Position	Figure No.	Conducted Power (dBm)	tune-up Power (dBm)	Measured SAR(10g) (W/kg)	Reported SAR(10g) (W/kg)	Measured SAR(1g) (W/kg)	Reported SAR(1g) (W/kg)	Power Drift (dB)
Ch.	MHz											
40620	2593	1RB_High	Left	Touch	/	20.50	21.20	0.023	<b>0.03</b>	0.044	<b>0.05</b>	-0.11
40620	2593	1RB_High	Left	Tilt	/	20.50	21.20	0.018	<b>0.02</b>	0.04	<b>0.05</b>	0.08
40620	2593	1RB_High	Right	Touch	/	20.50	21.20	0.067	<b>0.08</b>	0.144	<b>0.17</b>	0.12
40620	2593	1RB_High	Right	Tilt	/	20.50	21.20	0.027	<b>0.03</b>	0.056	<b>0.07</b>	0.11
40620	2593	50RB_High	Left	Touch	/	20.56	21.20	0.025	<b>0.03</b>	0.049	<b>0.06</b>	0.07
40620	2593	50RB_High	Left	Tilt	/	20.56	21.20	0.019	<b>0.02</b>	0.04	<b>0.05</b>	-0.13
40620	2593	50RB_High	Right	Touch	Fig.32	20.56	21.20	0.071	<b>0.08</b>	0.15	<b>0.17</b>	0.09
40620	2593	50RB_High	Right	Tilt	/	20.56	21.20	0.027	<b>0.03</b>	0.057	<b>0.07</b>	-0.09

Note1: The LTE mode is QPSK\_20MHz.

**Table 14.1-33: SAR Values (LTE Band41 PC2 - Body)**

Ambient Temperature: 22.9 °C						Liquid Temperature: 22.5°C					
Frequency		Mode	Test Position	Figure No.	Conducted Power (dBm)	tune-up Power (dBm)	Measured SAR(10g) (W/kg)	Reported SAR(10g) (W/kg)	Measured SAR(1g) (W/kg)	Reported SAR(1g) (W/kg)	Power Drift (dB)
Ch.	MHz										
41055	2636.5	1RB_Mid	Front	/	21.57	22.00	0.035	<b>0.04</b>	0.061	<b>0.07</b>	-0.07
41055	2636.5	1RB_Mid	Rear	/	21.57	22.00	0.122	<b>0.13</b>	0.287	<b>0.32</b>	-0.05
41055	2636.5	1RB_Mid	Left	/	21.57	22.00	0.091	<b>0.10</b>	0.179	<b>0.20</b>	-0.08

41055	2636.5	1RB_Mid	Top	/	21.57	22.00	0.049	<b>0.05</b>	0.096	<b>0.11</b>	-0.13
40620	2593	50RB_High	Front	/	21.54	22.00	0.034	<b>0.04</b>	0.062	<b>0.07</b>	-0.08
40620	2593	50RB_High	Rear	Fig.33	21.54	22.00	0.127	<b>0.14</b>	0.299	<b>0.33</b>	-0.13
40620	2593	50RB_High	Left	/	21.54	22.00	0.095	<b>0.11</b>	0.184	<b>0.20</b>	0.03
40620	2593	50RB_High	Top	/	21.54	22.00	0.047	<b>0.05</b>	0.09	<b>0.10</b>	0.10

Note1: The distance between the EUT and the phantom bottom is 10mm.

Note4: The LTE mode is QPSK\_20MHz.

**Table 14.1-34: SAR Values (LTE Band41 PC2 - Body)**

Ambient Temperature: 22.9 °C						Liquid Temperature: 22.5 °C					
Frequency		Mode	Test Position	Figure No.	Conducted Power (dBm)	tune-up Power (dBm)	Measured SAR(10g) (W/kg)	Reported SAR(10g) (W/kg)	Measured SAR(1g) (W/kg)	Reported SAR(1g) (W/kg)	Power Drift (dB)
Ch.	MHz										
41055	2636.5	1RB_High	Front	/	26.72	27.70	0.043	<b>0.05</b>	0.083	<b>0.10</b>	0.11
41055	2636.5	1RB_High	Rear	Fig.34	26.72	27.70	0.212	<b>0.27</b>	0.447	<b>0.56</b>	0.01
41055	2636.5	50RB_Low	Front	/	25.72	26.70	0.036	<b>0.05</b>	0.07	<b>0.09</b>	-0.06
41055	2636.5	50RB_Low	Rear	/	25.72	26.70	0.175	<b>0.22</b>	0.368	<b>0.46</b>	0.00

Note1: The distance between the EUT and the phantom bottom is 15mm.

Note4: The LTE mode is QPSK\_20MHz.

**Table 14.1-35: SAR Values (LTE Band41 PC3 - Head)**

Ambient Temperature: 22.9 °C						Liquid Temperature: 22.5 °C						
Frequency		Mode	Side	Test Position	Figure No.	Conducted Power (dBm)	tune-up Power (dBm)	Measured SAR(10g) (W/kg)	Reported SAR(10g) (W/kg)	Measured SAR(1g) (W/kg)	Reported SAR(1g) (W/kg)	Power Drift (dB)
Ch.	MHz											
40620	2593	1RB_High	Left	Touch	/	20.59	21.20	0.029	<b>0.03</b>	0.053	<b>0.06</b>	-0.05
40620	2593	1RB_High	Left	Tilt	/	20.59	21.20	0.024	<b>0.03</b>	0.048	<b>0.06</b>	-0.09
40620	2593	1RB_High	Right	Touch	/	20.59	21.20	0.086	<b>0.10</b>	0.174	<b>0.20</b>	0.03
40620	2593	1RB_High	Right	Tilt	/	20.59	21.20	0.034	<b>0.04</b>	0.07	<b>0.08</b>	-0.05
40620	2593	50RB_High	Left	Touch	/	20.56	21.20	0.033	<b>0.04</b>	0.059	<b>0.07</b>	0.03
40620	2593	50RB_High	Left	Tilt	/	20.56	21.20	0.023	<b>0.03</b>	0.045	<b>0.05</b>	0.13
40620	2593	50RB_High	Right	Touch	Fig.35	20.56	21.20	0.092	<b>0.11</b>	0.19	<b>0.22</b>	-0.03
40620	2593	50RB_High	Right	Tilt	/	20.56	21.20	0.033	<b>0.04</b>	0.068	<b>0.08</b>	-0.07

Note1: The LTE mode is QPSK\_20MHz.

**Table 14.1-36: SAR Values (LTE Band41 PC3 - Body)**

Ambient Temperature: 22.9 °C						Liquid Temperature: 22.5 °C					
Frequency		Mode	Test Position	Figure No.	Conducted Power (dBm)	tune-up Power (dBm)	Measured SAR(10g) (W/kg)	Reported SAR(10g) (W/kg)	Measured SAR(1g) (W/kg)	Reported SAR(1g) (W/kg)	Power Drift (dB)
Ch.	MHz										
40620	2593	1RB_High	Front	/	21.58	22.00	0.029	<b>0.03</b>	0.059	<b>0.06</b>	0.10
40620	2593	1RB_High	Rear	/	21.58	22.00	0.186	<b>0.20</b>	0.435	<b>0.48</b>	-0.07

40620	2593	1RB_High	Left	/	21.58	22.00	0.099	<b>0.11</b>	0.206	<b>0.23</b>	-0.13
40620	2593	1RB_High	Top	/	21.58	22.00	0.051	<b>0.06</b>	0.101	<b>0.11</b>	0.02
40620	2593	50RB_High	Front	/	21.58	22.00	0.03	<b>0.03</b>	0.061	<b>0.07</b>	0.05
40620	2593	50RB_High	Rear	Fig.36	21.58	22.00	0.192	<b>0.21</b>	0.45	<b>0.50</b>	-0.07
40620	2593	50RB_High	Left	/	21.58	22.00	0.099	<b>0.11</b>	0.206	<b>0.23</b>	0.05
40620	2593	50RB_High	Top	/	21.58	22.00	0.052	<b>0.06</b>	0.103	<b>0.11</b>	-0.05

Note1: The distance between the EUT and the phantom bottom is 10mm.

Note2: The LTE mode is QPSK\_20MHz.

**Table 14.1-37: SAR Values (LTE Band41 PC3 - Body)**

Ambient Temperature: 22.9 °C						Liquid Temperature: 22.5 °C					
Frequency		Mode	Test Position	Figure No.	Conduct ed Power (dBm)	tune-up Power (dBm)	Measured SAR(10g) (W/kg)	Reported SAR(10g) (W/kg)	Measured SAR(1g) (W/kg)	Reported SAR(1g) (W/kg)	Power Drift (dB)
Ch.	MHz										
40620	2593	1RB_High	Front	/	24.52	25.00	0.024	<b>0.03</b>	0.045	<b>0.05</b>	0.12
40620	2593	1RB_High	Rear	/	24.52	25.00	0.107	<b>0.12</b>	0.228	<b>0.25</b>	0.11
40620	2593	50RB_High	Front	/	23.52	24.00	0.025	<b>0.03</b>	0.047	<b>0.05</b>	0.00
40620	2593	50RB_High	Rear	Fig.37	23.52	24.00	0.113	<b>0.13</b>	0.24	<b>0.27</b>	0.02

Note1: The distance between the EUT and the phantom bottom is 15mm.

Note2: The LTE mode is QPSK\_20MHz.

**Table 14.1-38: SAR Values (LTE Band66 - Head)**

Ambient Temperature: 22.9 °C						Liquid Temperature: 22.5 °C						
Frequency		Mode	Side	Test Position	Figure No.	Conduct ed Power (dBm)	Max. tune-up Power (dBm)	Measured SAR(10g) (W/kg)	Reported SAR(10g) (W/kg)	Measure d SAR(1g) (W/kg)	Reporte d SAR(1g) (W/kg)	Powe r Drift (dB)
Ch.	MHz											
132072	1720	1RB_High	Left	Touch	/	20.48	20.70	0.245	<b>0.26</b>	0.408	<b>0.43</b>	0.02
132072	1720	1RB_High	Left	Tilt	/	20.48	20.70	0.282	<b>0.30</b>	0.481	<b>0.51</b>	-0.04
132572	1770	1RB_Low	Right	Touch	Fig.38	20.43	20.70	0.489	<b>0.52</b>	0.896	<b>0.95</b>	0.04
132322	1745	1RB_High	Right	Touch	/	20.45	20.70	0.436	<b>0.46</b>	0.745	<b>0.79</b>	0.09
132072	1720	1RB_High	Right	Touch	/	20.48	20.70	0.447	<b>0.47</b>	0.762	<b>0.80</b>	-0.08
132072	1720	1RB_High	Right	Tilt	/	20.48	20.70	0.169	<b>0.18</b>	0.279	<b>0.29</b>	0.02
132072	1720	50RB_Mid	Left	Touch	/	20.59	20.70	0.202	<b>0.21</b>	0.283	<b>0.29</b>	0.12
132072	1720	50RB_Mid	Left	Tilt	/	20.59	20.70	0.137	<b>0.14</b>	0.206	<b>0.21</b>	0.12
132072	1720	50RB_Mid	Right	Touch	/	20.59	20.70	0.347	<b>0.36</b>	0.617	<b>0.63</b>	0.09
132072	1720	50RB_Mid	Right	Tilt	/	20.59	20.70	0.12	<b>0.12</b>	0.191	<b>0.20</b>	0.00
132072	1720	100RB	Right	Touch	/	20.60	20.70	0.326	<b>0.33</b>	0.582	<b>0.60</b>	0.06

Note1: The LTE mode is QPSK\_20MHz.

**Table 14.1-39: SAR Values (LTE Band66 - Body)**

Ambient Temperature: 22.9°C						Liquid Temperature: 22.5°C					
Frequency		Mode	Test Position	Figure No.	Conducted Power (dBm)	Max. tune-up Power (dBm)	Measured SAR(10g) (W/kg)	Reported SAR(10g) (W/kg)	Measured SAR(1g) (W/kg)	Reported SAR(1g) (W/kg)	Power Drift (dB)
Ch.	MHz										
132072	1720	1RB_Low	Front	/	21.41	21.70	0.07	<b>0.07</b>	0.111	<b>0.12</b>	-0.08
132072	1720	1RB_Low	Rear	Fig.39	21.41	21.70	0.218	<b>0.23</b>	0.388	<b>0.41</b>	-0.14
132072	1720	1RB_Low	Left		21.41	21.70	0.12	<b>0.13</b>	0.203	<b>0.22</b>	0.03
132072	1720	1RB_Low	Top		21.41	21.70	0.049	<b>0.05</b>	0.073	<b>0.08</b>	-0.06
132072	1720	50RB_Mid	Front	/	21.50	21.70	0.075	<b>0.08</b>	0.116	<b>0.12</b>	-0.07
132072	1720	50RB_Mid	Rear	/	21.50	21.70	0.109	<b>0.11</b>	0.169	<b>0.18</b>	-0.04
132072	1720	50RB_Mid	Left		21.50	21.70	0.131	<b>0.14</b>	0.227	<b>0.24</b>	0.02
132072	1720	50RB_Mid	Top	/	21.50	21.70	0.012	<b>0.01</b>	0.017	<b>0.02</b>	-0.01

Note1: The distance between the EUT and the phantom bottom is 10mm

Note2: The LTE mode is QPSK\_20MHz.

**Table 14.1-40: SAR Values (LTE Band66 - Body)**

Ambient Temperature: 22.9°C						Liquid Temperature: 22.5°C					
Frequency		Mode	Test Position	Figure No.	Conducted Power (dBm)	Max. tune-up Power (dBm)	Measured SAR(10g) (W/kg)	Reported SAR(10g) (W/kg)	Measured SAR(1g) (W/kg)	Reported SAR(1g) (W/kg)	Power Drift (dB)
Ch.	MHz										
132072	1720	1RB_Low	Front	/	24.14	25.10	0.281	<b>0.35</b>	0.526	<b>0.66</b>	0.06
132072	1720	1RB_Low	Rear	Fig.40	24.14	25.10	0.359	<b>0.45</b>	0.614	<b>0.77</b>	-0.18
132072	1720	50RB_Mid	Front	/	23.21	24.10	0.211	<b>0.26</b>	0.392	<b>0.48</b>	-0.11
132072	1720	50RB_Mid	Rear	/	23.21	24.10	0.284	<b>0.35</b>	0.508	<b>0.62</b>	-0.12

Note1: The distance between the EUT and the phantom bottom is 15mm

Note2: The LTE mode is QPSK\_20MHz.

**Table 14.1-41: SAR Values (LTE Band71 - Head)**

Ambient Temperature: 22.9°C						Liquid Temperature: 22.5°C						
Frequency		Mode	Side	Test Position	Figure No.	Conducted Power (dBm)	Max. tune-up Power (dBm)	Measured SAR(10g) (W/kg)	Reported SAR(10g) (W/kg)	Measured SAR(1g) (W/kg)	Reported SAR(1g) (W/kg)	Power Drift (dB)
Ch.	MHz											
133222	673	1RB_Low	Left	Touch	Fig.41	24.67	24.70	0.326	<b>0.33</b>	0.582	<b>0.59</b>	0.05
133222	673	1RB_Low	Left	Tilt	/	24.67	24.70	0.077	<b>0.08</b>	0.108	<b>0.11</b>	-0.06
133222	673	1RB_Low	Right	Touch	/	24.67	24.70	0.182	<b>0.18</b>	0.333	<b>0.34</b>	-0.12
133222	673	1RB_Low	Right	Tilt	/	24.67	24.70	0.044	<b>0.04</b>	0.069	<b>0.07</b>	0.02
133222	673	50RB_Mid	Left	Touch	/	23.67	23.70	0.305	<b>0.31</b>	0.574	<b>0.58</b>	0.01
133222	673	50RB_Mid	Left	Tilt	/	23.67	23.70	0.066	<b>0.07</b>	0.091	<b>0.09</b>	0.06

133222	673	50RB_Mid	Right	Touch	/	23.67	23.70	0.154	<b>0.16</b>	0.284	<b>0.29</b>	0.11
133222	673	50RB_Mid	Right	Tilt	/	23.67	23.70	0.038	<b>0.04</b>	0.062	<b>0.06</b>	-0.07

Note1: The LTE mode is QPSK\_20MHz.

**Table 14.1-42: SAR Values (LTE Band71 - Body)**

Ambient Temperature: 22.9 °C						Liquid Temperature: 22.5 °C					
Frequency		Mode	Test Position	Figure No.	Conducted Power (dBm)	Max. tune-up Power (dBm)	Measured SAR(10g) (W/kg)	Reported SAR(10g) (W/kg)	Measured SAR(1g) (W/kg)	Reported SAR(1g) (W/kg)	Power Drift (dB)
Ch.	MHz										
133222	673	1RB_Mid	Front	/	24.67	24.70	0.439	<b>0.44</b>	0.623	<b>0.63</b>	0.02
133222	673	1RB_Mid	Rear	/	24.67	24.70	0.362	<b>0.36</b>	0.491	<b>0.49</b>	-0.01
133372	688	1RB_Low	Left	/	24.41	24.70	0.471	<b>0.50</b>	0.751	<b>0.80</b>	0.17
133322	683	1RB_Low	Left	/	24.39	24.70	0.429	<b>0.46</b>	0.735	<b>0.79</b>	0.07
133222	673	1RB_Mid	Left	Fig.42	24.67	24.70	0.521	<b>0.52</b>	0.851	<b>0.86</b>	-0.11
133222	673	50RB_Mid	Front	/	23.67	23.70	0.354	<b>0.36</b>	0.502	<b>0.51</b>	-0.11
133222	673	50RB_Mid	Rear	/	23.67	23.70	0.318	<b>0.32</b>	0.436	<b>0.44</b>	-0.05
133222	673	50RB_Mid	Left	/	23.67	23.70	0.405	<b>0.41</b>	0.675	<b>0.68</b>	-0.07
133222	673	100RB	Left	/	23.61	23.70	0.394	<b>0.40</b>	0.651	<b>0.66</b>	0.01

Note1: The distance between the EUT and the phantom bottom is 10mm.

Note2: The LTE mode is QPSK\_20MHz.

**Table 14.1-43: SAR Values (LTE Band2 - Head)**

Ambient Temperature: 22.9 °C						Liquid Temperature: 22.5 °C						
Frequency		Mode	Side	Test Position	Figure No.	Conducted Power (dBm)	Max. tune-up Power (dBm)	Measured SAR(10g) (W/kg)	Reported SAR(10g) (W/kg)	Measured SAR(1g) (W/kg)	Reported SAR(1g) (W/kg)	Power Drift (dB)
Ch.	MHz											
18900	1880	1RB_Low	Left	Touch	/	18.36	19	0.145	<b>0.17</b>	0.249	<b>0.29</b>	0.07
18900	1880	1RB_Low	Left	Tilt	/	18.36	19	0.119	<b>0.14</b>	0.208	<b>0.24</b>	0.08
18900	1880	1RB_Low	Right	Touch	/	18.36	19	0.257	<b>0.30</b>	0.534	<b>0.62</b>	0.02
18900	1880	1RB_Low	Right	Tilt	/	18.36	19	0.086	<b>0.10</b>	0.164	<b>0.19</b>	-0.02
18700	1860	50RB_High	Left	Touch	/	18.51	19	0.137	<b>0.15</b>	0.236	<b>0.26</b>	-0.03
18700	1860	50RB_High	Left	Tilt	/	18.51	19	0.111	<b>0.12</b>	0.193	<b>0.22</b>	0.11
18700	1860	50RB_High	Right	Touch	/	18.51	19	0.239	<b>0.27</b>	0.497	<b>0.56</b>	-0.04
18700	1860	50RB_High	Right	Tilt	/	18.51	19	0.087	<b>0.10</b>	0.165	<b>0.18</b>	-0.07

Note1: The LTE mode is QPSK\_20MHz.

Note2: The data is used for END C

**Table 14.1-44: SAR Values (LTE Band2 - Body)**

Ambient Temperature: 22.9 °C						Liquid Temperature: 22.5 °C					
Frequency		Mode	Test Position	Figure No.	Conducted Power (dBm)	Max. tune-up Power (dBm)	Measured SAR(10g) (W/kg)	Reported SAR(10g) (W/kg)	Measured SAR(1g) (W/kg)	Reported SAR(1g) (W/kg)	Power Drift (dB)
Ch.	MHz										
19100	1900	1RB_Mid	Front	/	18.44	19	0.115	<b>0.13</b>	0.201	<b>0.23</b>	-0.03
19100	1900	1RB_Mid	Rear	/	18.44	19	0.232	<b>0.26</b>	0.429	<b>0.49</b>	-0.09
19100	1900	1RB_Mid	Left	/	18.44	19	0.230	<b>0.26</b>	0.433	<b>0.49</b>	-0.05
19100	1900	1RB_Mid	Top	/	18.44	19	0.053	<b>0.06</b>	0.089	<b>0.10</b>	-0.05
18700	1860	50RB_High	Front	/	18.54	19	0.117	<b>0.13</b>	0.207	<b>0.23</b>	0.05
18700	1860	50RB_High	Rear	/	18.54	19	0.236	<b>0.26</b>	0.413	<b>0.46</b>	0.10
18700	1860	50RB_High	Left	/	18.54	19	0.234	<b>0.26</b>	0.437	<b>0.49</b>	-0.11
18700	1860	50RB_High	Top	/	18.54	19	0.057	<b>0.06</b>	0.095	<b>0.11</b>	0.08
19100	1900	1RB_Mid	Rear	Note2	20.3	21	1.310	<b>1.54</b>	2.950	<b>3.47</b>	-0.03

Note1: The distance between the EUT and the phantom bottom is 10mm

Note2: The distance between the EUT and the phantom bottom is 0mm

Note3: The LTE mode is QPSK\_20MHz.

Note4: The data is used for ENDC

**Table 14.1-45: SAR Values (LTE Band2 - Body)**

Ambient Temperature: 22.9 °C						Liquid Temperature: 22.5 °C					
Frequency		Mode	Test Position	Figure No.	Conducted Power (dBm)	Max. tune-up Power (dBm)	Measured SAR(10g) (W/kg)	Reported SAR(10g) (W/kg)	Measured SAR(1g) (W/kg)	Reported SAR(1g) (W/kg)	Power Drift (dB)
Ch.	MHz										
18900	1880	1RB_Low	Front	/	20.45	21	0.100	<b>0.11</b>	0.177	<b>0.20</b>	0.01
18900	1880	1RB_Low	Rear	/	20.45	21	0.249	<b>0.28</b>	0.450	<b>0.51</b>	-0.06
18700	1860	50RB_High	Front	/	20.46	21	0.100	<b>0.11</b>	0.161	<b>0.18</b>	0.11
18700	1860	50RB_High	Rear	/	20.46	21	0.250	<b>0.28</b>	0.456	<b>0.52</b>	0.06

Note1: The distance between the EUT and the phantom bottom is 15mm

Note2: The LTE mode is QPSK\_20MHz.

Note3: The data is used for ENDC

**Table 14.1-46: SAR Values (LTE Band12 - Head)**

Ambient Temperature: 22.9 °C						Liquid Temperature: 22.5 °C						
Frequency		Mode	Side	Test Position	Figure No.	Conducted Power (dBm)	Max. tune-up Power (dBm)	Measured SAR(10g) (W/kg)	Reported SAR(10g) (W/kg)	Measured SAR(1g) (W/kg)	Reported SAR(1g) (W/kg)	Power Drift (dB)
Ch.	MHz											
23095	707.5	1RB_High	Left	Touch	/	17.99	19	0.143	<b>0.18</b>	0.263	<b>0.33</b>	0.09



23095	707.5	1RB_High	Left	Tilt	/	17.99	19	0.038	<b>0.05</b>	0.058	<b>0.07</b>	-0.10
23095	707.5	1RB_High	Right	Touch	/	17.99	19	0.054	<b>0.07</b>	0.101	<b>0.13</b>	0.00
23095	707.5	1RB_High	Right	Tilt	/	17.99	19	0.030	<b>0.04</b>	0.045	<b>0.06</b>	-0.01
23060	704	25RB_Mid	Left	Touch	/	18.01	19	0.144	<b>0.18</b>	0.265	<b>0.33</b>	-0.08
23060	704	25RB_Mid	Left	Tilt	/	18.01	19	0.038	<b>0.05</b>	0.055	<b>0.07</b>	-0.01
23060	704	25RB_Mid	Right	Touch	/	18.01	19	0.055	<b>0.07</b>	0.100	<b>0.13</b>	-0.01
23060	704	25RB_Mid	Right	Tilt	/	18.01	19	0.029	<b>0.04</b>	0.045	<b>0.06</b>	-0.02

Note1: The LTE mode is QPSK\_10MHz.

Note2: The data is used for ENDC

**Table 14.1-47: SAR Values (LTE Band12 - Body)**

Ambient Temperature: 22.9°C						Liquid Temperature: 22.5°C					
Frequency		Mode	Test Position	Figure No.	Conducted Power (dBm)	Max. tune-up Power (dBm)	Measured SAR(10g) (W/kg)	Reported SAR(10g) (W/kg)	Measured SAR(1g) (W/kg)	Reported SAR(1g) (W/kg)	Power Drift (dB)
Ch.	MHz										
23095	707.5	1RB_High	Front	/	17.98	18.5	0.168	<b>0.19</b>	0.268	<b>0.30</b>	0.05
23095	707.5	1RB_High	Rear	/	17.98	18.5	0.262	<b>0.30</b>	0.417	<b>0.47</b>	0.08
23095	707.5	1RB_High	Left		17.98	18.5	0.343	<b>0.39</b>	0.578	<b>0.65</b>	0.05
23060	704	25RB_Mid	Front	/	17.99	18.5	0.165	<b>0.19</b>	0.265	<b>0.30</b>	0.02
23060	704	25RB_Mid	Rear	/	17.99	18.5	0.259	<b>0.29</b>	0.417	<b>0.47</b>	-0.12
23060	704	25RB_Mid	Left		17.99	18.5	0.340	<b>0.38</b>	0.575	<b>0.65</b>	0.02

Note1: The distance between the EUT and the phantom bottom is 10mm

Note2: The LTE mode is QPSK\_10MHz.

Note3: The data is used for ENDC

**Table 14.1-48: SAR Values (LTE Band12 - Body)**

Ambient Temperature: 22.9°C						Liquid Temperature: 22.5°C					
Frequency		Mode	Test Position	Figure No.	Conducted Power (dBm)	Max. tune-up Power (dBm)	Measured SAR(10g) (W/kg)	Reported SAR(10g) (W/kg)	Measured SAR(1g) (W/kg)	Reported SAR(1g) (W/kg)	Power Drift (dB)
Ch.	MHz										
23060	704	1RB_High	Front	/	24.14	25.10	0.281	<b>0.35</b>	0.526	<b>0.66</b>	0.06
23060	704	1RB_High	Rear	Fig.40	24.14	25.10	0.359	<b>0.45</b>	0.614	<b>0.77</b>	-0.18
23095	707.5	25RB_Low	Front	/	23.21	24.10	0.211	<b>0.26</b>	0.392	<b>0.48</b>	-0.11
23095	707.5	25RB_Low	Rear	/	23.21	24.10	0.284	<b>0.35</b>	0.508	<b>0.62</b>	-0.12

Note1: The distance between the EUT and the phantom bottom is 15mm

Note2: The LTE mode is QPSK\_10MHz.

Note3: The data is used for ENDC

**Table 14.1-49: SAR Values (LTE Band66 - Head)**

Frequency		Mode	Side	Test Position	Figure No.	Conducted Power (dBm)	Max. tune-up Power (dBm)	Measured SAR(10g) (W/kg)	Reported SAR(10g) (W/kg)	Measured SAR(1g) (W/kg)	Reported SAR(1g) (W/kg)	Power Drift (dB)
Ch.	MHz											
Ambient Temperature: 22.9°C      Liquid Temperature: 22.5°C												
132072	1720	1RB_Low	Left	Touch	/	18.46	19	0.166	<b>0.19</b>	0.278	<b>0.31</b>	0.12
132072	1720	1RB_Low	Left	Tilt	/	18.46	19	0.096	<b>0.11</b>	0.164	<b>0.19</b>	0.12
132072	1720	1RB_Low	Right	Touch	/	18.46	19	0.283	<b>0.32</b>	0.558	<b>0.63</b>	0.00
132072	1720	1RB_Low	Right	Tilt	/	18.46	19	0.096	<b>0.11</b>	0.163	<b>0.18</b>	-0.08
132072	1720	50RB_Mid	Left	Touch	/	18.56	19	0.179	<b>0.20</b>	0.296	<b>0.33</b>	-0.06
132072	1720	50RB_Mid	Left	Tilt	/	18.56	19	0.108	<b>0.12</b>	0.186	<b>0.21</b>	0.10
132072	1720	50RB_Mid	Right	Touch	/	18.56	19	0.309	<b>0.34</b>	0.615	<b>0.68</b>	-0.05
132072	1720	50RB_Mid	Right	Tilt	/	18.56	19	0.108	<b>0.12</b>	0.186	<b>0.21</b>	0.12

Note1: The LTE mode is QPSK\_20MHz.

Note2: The data is used for ENDC

**Table 14.1-50: SAR Values (LTE Band66 - Body)**

Frequency		Mode	Test Position	Figure No.	Conducted Power (dBm)	Max. tune-up Power (dBm)	Measured SAR(10g) (W/kg)	Reported SAR(10g) (W/kg)	Measured SAR(1g) (W/kg)	Reported SAR(1g) (W/kg)	Power Drift (dB)
Ch.	MHz										
Ambient Temperature: 22.9°C      Liquid Temperature: 22.5°C											
132072	1720	1RB_Low	Front	/	18.47	19	0.059	<b>0.07</b>	0.116	<b>0.13</b>	-0.05
132072	1720	1RB_Low	Rear	/	18.47	19	0.126	<b>0.14</b>	0.235	<b>0.27</b>	-0.01
132072	1720	1RB_Low	Left	/	18.47	19	0.158	<b>0.18</b>	0.304	<b>0.34</b>	0.00
132072	1720	1RB_Low	Top	/	18.47	19	0.000	<b>0.00</b>	0.072	<b>0.08</b>	-0.07
132072	1720	50RB_Mid	Front	/	18.56	19	0.042	<b>0.05</b>	0.131	<b>0.14</b>	0.04
132072	1720	50RB_Mid	Rear	/	18.56	19	0.138	<b>0.15</b>	0.258	<b>0.29</b>	0.12
132072	1720	50RB_Mid	Left	/	18.56	19	0.176	<b>0.19</b>	0.338	<b>0.37</b>	0.10
132072	1720	50RB_Mid	Top	/	18.56	19	0.045	<b>0.05</b>	0.077	<b>0.09</b>	-0.12

Note1: The distance between the EUT and the phantom bottom is 10mm

Note2: The LTE mode is QPSK\_20MHz.

Note3: The data is used for ENDC

**Table 14.1-51: SAR Values (LTE Band66 - Body)**

Ambient Temperature: 22.9 °C						Liquid Temperature: 22.5 °C					
Frequency		Mode	Test Position	Figure No.	Conducted Power (dBm)	Max. tune-up Power (dBm)	Measured SAR(10g) (W/kg)	Reported SAR(10g) (W/kg)	Measured SAR(1g) (W/kg)	Reported SAR(1g) (W/kg)	Power Drift (dB)
Ch.	MHz										
132072	1720	1RB_Low	Front	/	20.44	21	0.055	<b>0.06</b>	0.077	<b>0.09</b>	-0.01
132072	1720	1RB_Low	Rear	/	20.44	21	0.117	<b>0.13</b>	0.184	<b>0.21</b>	-0.12
132322	1745	50RB_High	Front	/	20.51	21	0.057	<b>0.06</b>	0.086	<b>0.10</b>	0.10
132322	1745	50RB_High	Rear	/	20.51	21	0.131	<b>0.15</b>	0.207	<b>0.23</b>	0.06

Note1: The distance between the EUT and the phantom bottom is 15mm

Note2: The LTE mode is QPSK\_20MHz.

Note3: The data is used for ENDC

**Table 14.1-52: SAR Values (LTE Band2 - Head)**

Ambient Temperature: 22.9 °C						Liquid Temperature: 22.5 °C						
Frequency		Mode	Side	Test Position	Figure No.	Conducted Power (dBm)	Max. tune-up Power (dBm)	Measured SAR(10g) (W/kg)	Reported SAR(10g) (W/kg)	Measured SAR(1g) (W/kg)	Reported SAR(1g) (W/kg)	Power Drift (dB)
Ch.	MHz											
18700	1860	1RB_Mid	Left	Touch	/	20.92	21.00	<0.01	<b>&lt;0.01</b>	<0.01	<b>&lt;0.01</b>	/
18700	1860	1RB_Mid	Left	Tilt	/	20.92	21.00	<0.01	<b>&lt;0.01</b>	<0.01	<b>&lt;0.01</b>	/
18700	1860	1RB_Mid	Right	Touch	/	20.92	21.00	<0.01	<b>&lt;0.01</b>	<0.01	<b>&lt;0.01</b>	/
18700	1860	1RB_Mid	Right	Tilt	/	20.92	21.00	<0.01	<b>&lt;0.01</b>	<0.01	<b>&lt;0.01</b>	/
18700	1860	50RB_Low	Left	Touch	/	20.97	21.00	0.03	<b>0.03</b>	0.046	<b>0.05</b>	0.14
18700	1860	50RB_Low	Left	Tilt	/	20.97	21.00	<0.01	<b>&lt;0.01</b>	<0.01	<b>&lt;0.01</b>	/
18700	1860	50RB_Low	Right	Touch	/	20.97	21.00	<0.01	<b>&lt;0.01</b>	<0.01	<b>&lt;0.01</b>	/
18700	1860	50RB_Low	Right	Tilt	/	20.97	21.00	<0.01	<b>&lt;0.01</b>	<0.01	<b>&lt;0.01</b>	/

Note1: The LTE mode is QPSK\_20MHz.

Note2: The data is used for ENDC-n66

**Table 14.1-53: SAR Values (LTE Band2 - Body)**

Ambient Temperature: 22.9 °C						Liquid Temperature: 22.5 °C					
Frequency		Mode	Test Position	Figure No.	Conducted Power (dBm)	Max. tune-up Power (dBm)	Measured SAR(10g) (W/kg)	Reported SAR(10g) (W/kg)	Measured SAR(1g) (W/kg)	Reported SAR(1g) (W/kg)	Power Drift (dB)
Ch.	MHz										
18700	1860	1RB_Mid	Front	/	18.95	19.00	0.121	<b>0.12</b>	0.216	<b>0.22</b>	-0.02
18700	1860	1RB_Mid	Rear	/	18.95	19.00	0.141	<b>0.14</b>	0.253	<b>0.26</b>	-0.04
18700	1860	1RB_Mid	Left	/	18.95	19.00	<0.01	<b>&lt;0.01</b>	<0.01	<b>&lt;0.01</b>	/

18700	1860	1RB_Mid	Right		18.95	19.00	<0.01	<b>&lt;0.01</b>	<0.01	<b>&lt;0.01</b>	/
18700	1860	1RB_Mid	Bottom	/	18.95	19.00	0.159	<b>0.16</b>	0.303	<b>0.31</b>	0.06
18700	1860	50RB_Low	Front	/	18.92	19.00	0.128	<b>0.13</b>	0.236	<b>0.24</b>	-0.09
18700	1860	50RB_Low	Rear	/	18.92	19.00	0.146	<b>0.15</b>	0.265	<b>0.27</b>	0.07
18700	1860	50RB_Low	Left	/	18.92	19.00	0.012	<b>0.01</b>	0.024	<b>0.02</b>	0.02
18700	1860	50RB_Low	Right		18.92	19.00	<0.01	<b>&lt;0.01</b>	<0.01	<b>&lt;0.01</b>	/
18700	1860	50RB_Low	Bottom	/	18.92	19.00	0.158	<b>0.16</b>	0.297	<b>0.30</b>	-0.10

Note1: The distance between the EUT and the phantom bottom is 10mm

Note2: The LTE mode is QPSK\_20MHz.

Note3: The data is used for ENDC-n66

**Table 14.1-54: SAR Values (LTE Band2 - Body)**

Frequency		Mode	Test Position	Figure No.	Conduct ed Power (dBm)	Ambient Temperature: 22.9 °C		Liquid Temperature: 22.5 °C		Power Drift (dB)	
Ch.	MHz					Max. tune-up Power (dBm)	Measured SAR(10g) (W/kg)	Reported SAR(10g) (W/kg)	Measured SAR(1g) (W/kg)		Reported SAR(1g) (W/kg)
18700	1860	1RB_Mid	Front	/	20.92	21.00	0.113	<b>0.12</b>	0.193	<b>0.11</b>	-0.07
18700	1860	1RB_Mid	Rear	/	20.92	21.00	0.131	<b>0.13</b>	0.225	<b>0.13</b>	0.07
18700	1860	50RB_Low	Front	/	20.97	21.00	0.11	<b>0.11</b>	0.188	<b>0.11</b>	0.07
18700	1860	50RB_Low	Rear	/	20.97	21.00	0.137	<b>0.14</b>	0.238	<b>0.14</b>	0.12

Note1: The distance between the EUT and the phantom bottom is 15mm

Note2: The LTE mode is QPSK\_20MHz.

Note3: The data is used for ENDC-n66

## 14.2 SAR results for Standard procedure

There is zoom scan measurement to be added for the highest measured SAR in each exposure configuration/band.

**Table 14.2-1: SAR Values (GSM 850 MHz Band - Head)**

Ambient Temperature: 22.9 °C						Liquid Temperature: 22.5 °C					
Frequency		Side	Test Position	Figure No./Note	Conducted Power (dBm)	Max. tune-up Power (dBm)	Measured SAR(10g) (W/kg)	Reported SAR(10g) (W/kg)	Measured SAR(1g) (W/kg)	Reported SAR(1g) (W/kg)	Power Drift (dB)
Ch.	MHz										
190	836.6	Left	Touch	Fig.1	30.19	30.50	0.121	<b>0.13</b>	0.217	<b>0.23</b>	-0.03

Note: the head SAR of GSM850 is tested with GPRS (2Txslots) mode because of VoIP.

**Table 14.2-2: SAR Values (GSM 850 MHz Band - Body)**

Ambient Temperature: 22.9 °C						Liquid Temperature: 22.5 °C					
Frequency		Mode (number of timeslots)	Test Position	Figure No./Note	Conducted Power (dBm)	Max. tune-up Power (dBm)	Measured SAR(10g) (W/kg)	Reported SAR(10g) (W/kg)	Measured SAR(1g) (W/kg)	Reported SAR(1g) (W/kg)	Power Drift (dB)
Ch.	MHz										
190	836.6	GPRS (2)	Left	Fig.2	30.19	30.50	0.234	<b>0.25</b>	0.411	<b>0.44</b>	0.07

Note: The distance between the EUT and the phantom bottom is 10mm.

**Table 14.2-3: SAR Values (GSM 1900 MHz Band - Head)**

Ambient Temperature: 22.9 °C						Liquid Temperature: 22.5 °C					
Frequency		Side	Test Position	Figure No./Note	Conducted Power (dBm)	Max. tune-up Power (dBm)	Measured SAR(10g) (W/kg)	Reported SAR(10g) (W/kg)	Measured SAR(1g) (W/kg)	Reported SAR(1g) (W/kg)	Power Drift (dB)
Ch.	MHz										
661	1880	Right	Touch	/	28.29	28.70	0.58	<b>0.64</b>	1.220	<b>1.34</b>	-0.08

Note: the head SAR of GSM1900 is tested with GPRS (2Txslots) mode because of VoIP.

**Table 14.2-4: SAR Values (GSM 1900 MHz Band - Body)**

Ambient Temperature: 22.9 °C						Liquid Temperature: 22.5 °C					
Frequency		Mode (number of timeslots)	Test Position	Figure No./Note	Conducted Power (dBm)	Max. tune-up Power (dBm)	Measured SAR(10g) (W/kg)	Reported SAR(10g) (W/kg)	Measured SAR(1g) (W/kg)	Reported SAR(1g) (W/kg)	Power Drift (dB)
Ch.	MHz										
661	1880	GPRS (2)	Left	Fig.4	28.29	28.70	0.438	<b>0.48</b>	0.862	<b>0.95</b>	-0.11

Note: The distance between the EUT and the phantom bottom is 10mm.

**Table 14.2-5: SAR Values (WCDMA 850 MHz Band - Head)**

Ambient Temperature: 22.9 °C						Liquid Temperature: 22.5 °C					
Frequency		Side	Test Position	Figure No./Note	Conducted Power (dBm)	Max. tune-up Power (dBm)	Measured SAR(10g) (W/kg)	Reported SAR(10g) (W/kg)	Measured SAR(1g) (W/kg)	Reported SAR(1g) (W/kg)	Power Drift (dB)
Ch.	MHz										
4132	826.4	Left	Touch	Fig.5	24.26	24.70	0.344	<b>0.38</b>	0.622	<b>0.69</b>	0.13

**Table 14.2-6: SAR Values (WCDMA 850 MHz Band - Body)**

Frequency		Test Position	Figure No./ Note	Conducted Power (dBm)	Max. tune-up Power (dBm)	Measured SAR(10g) (W/kg)	Reported SAR(10g) (W/kg)	Measured SAR(1g) (W/kg)	Reported SAR(1g) (W/kg)	Power Drift (dB)
Ch.	MHz									
4182	836.4	Left		24.39	24.70	0.51	<b>0.55</b>	0.894	<b>0.96</b>	-0.10

Note: The distance between the EUT and the phantom bottom is 10mm.

**Table 14.2-7: SAR Values (WCDMA 1700 MHz Band - Head)**

Frequency		Side	Test Position	Figure No./Note	Conducted Power (dBm)	Max. tune-up Power (dBm)	Measured SAR(10g) (W/kg)	Reported SAR(10g) (W/kg)	Measured SAR(1g) (W/kg)	Reported SAR(1g) (W/kg)	Power Drift (dB)
Ch.	MHz										
1513	1752.6	Right	Touch	Fig.7	20.79	21.00	0.489	<b>0.51</b>	0.902	<b>0.95</b>	-0.04

**Table 14.2-8: SAR Values (WCDMA 1700 MHz Band - Body)**

Frequency		Test Position	Figure No./ Note	Conducted Power (dBm)	Max. tune-up Power (dBm)	Measured SAR(10g) (W/kg)	Reported SAR(10g) (W/kg)	Measured SAR(1g) (W/kg)	Reported SAR(1g) (W/kg)	Power Drift (dB)
Ch.	MHz									
1312	1712.4	Left	Fig.8	21.78	22.00	0.385	<b>0.41</b>	0.756	<b>0.80</b>	0.02

Note1: The distance between the EUT and the phantom bottom is 10mm.

**Table 14.2-9: SAR Values (WCDMA 1700 MHz Band - Body)**

Frequency		Test Position	Figure No./ Note	Conducted Power (dBm)	Max. tune-up Power (dBm)	Measured SAR(10g) (W/kg)	Reported SAR(10g) (W/kg)	Measured SAR(1g) (W/kg)	Reported SAR(1g) (W/kg)	Power Drift (dB)
Ch.	MHz									
1312	1712.4	Rear	Fig.9	24.39	24.70	0.463	<b>0.50</b>	0.806	<b>0.87</b>	0.07

Note1: The distance between the EUT and the phantom bottom is 15mm.

**Table 14.2-10: SAR Values (WCDMA 1900 MHz Band - Head)**

Frequency		Side	Test Position	Figure No./ Note	Conducted Power (dBm)	Max. tune-up Power (dBm)	Measured SAR(10g) (W/kg)	Reported SAR(10g) (W/kg)	Measured SAR(1g) (W/kg)	Reported SAR(1g) (W/kg)	Power Drift (dB)
Ch.	MHz										
9262	1852.4	Right	Touch	Fig.10	20.72	21.00	0.484	<b>0.52</b>	0.919	<b>0.98</b>	-0.04

**Table 14.2-11: SAR Values (WCDMA 1900 MHz Band - Body)**

Frequency		Test Position	Figure No./ Note	Conducted Power (dBm)	Max. tune-up Power (dBm)	Measured SAR(10g) (W/kg)	Reported SAR(10g) (W/kg)	Measured SAR(1g) (W/kg)	Reported SAR(1g) (W/kg)	Power Drift (dB)	
Ch.	MHz										
		Ambient Temperature: 22.9 °C				Liquid Temperature: 22.5 °C					
9538	1907.6	Left	Fig.11	21.77	22.00	0.509	<b>0.54</b>	0.999	<b>1.05</b>	-0.13	

Note1: The distance between the EUT and the phantom bottom is 10mm.

**Table 14.2-12: SAR Values (WCDMA 1900 MHz Band - Body)**

Frequency		Test Position	Figure No./ Note	Conducted Power (dBm)	Max. tune-up Power (dBm)	Measured SAR(10g) (W/kg)	Reported SAR(10g) (W/kg)	Measured SAR(1g) (W/kg)	Reported SAR(1g) (W/kg)	Power Drift (dB)	
Ch.	MHz										
		Ambient Temperature: 22.9 °C				Liquid Temperature: 22.5 °C					
9400	1880	Rear	Fig.12	24.14	24.20	0.21	<b>0.21</b>	0.375	<b>0.38</b>	-0.04	

Note1: The distance between the EUT and the phantom bottom is 15mm.

**Table 14.2-13: SAR Values (CDMA BC0 - Head)**

Frequency		Side	Test Position	Figure No.	Conducted Power (dBm)	Max. tune-up Power (dBm)	Measured SAR(10g) (W/kg)	Reported SAR(10g) (W/kg)	Measured SAR(1g) (W/kg)	Reported SAR(1g) (W/kg)	Power Drift (dB)
Ch.	MHz										
		Ambient Temperature: 22.9 °C				Liquid Temperature: 22.5 °C					
1013	824.7	Left	Touch	Fig.13	24.67	25	0.279	<b>0.30</b>	0.505	<b>0.54</b>	-0.04

**Table 14.2-14: SAR Values (CDMA BC0 - Body)**

Frequency		Test Position	Figure No.	Conducted Power (dBm)	Max. tune-up Power (dBm)	Measured SAR(10g) (W/kg)	Reported SAR(10g) (W/kg)	Measured SAR(1g) (W/kg)	Reported SAR(1g) (W/kg)	Power Drift (dB)	
Ch.	MHz										
		Ambient Temperature: 22.9 °C				Liquid Temperature: 22.5 °C					
1013	824.7	Left	Fig.14	24.66	25	0.34	<b>0.37</b>	0.646	<b>0.70</b>	0.03	

Note1: The distance between the EUT and the phantom bottom is 10mm

**Table 14.2-15: SAR Values (CDMA BC1 - Head)**

Frequency		Side	Test Position	Figure No.	Conducted Power (dBm)	Max. tune-up Power (dBm)	Measured SAR(10g) (W/kg)	Reported SAR(10g) (W/kg)	Measured SAR(1g) (W/kg)	Reported SAR(1g) (W/kg)	Power Drift (dB)
Ch.	MHz										
		Ambient Temperature: 22.9 °C				Liquid Temperature: 22.5 °C					
600	1880	Left	Touch	Fig.15	21.17	21.5	0.464	<b>0.50</b>	0.846	<b>0.91</b>	0.07

**Table 14.2-16: SAR Values (CDMA BC1 - Body)**

Ambient Temperature: 22.9 °C					Liquid Temperature: 22.5°C					
Frequency		Test Position	Figure No.	Conducted Power (dBm)	Max. tune-up Power (dBm)	Measured SAR(10g) (W/kg)	Reported SAR(10g) (W/kg)	Measured SAR(1g) (W/kg)	Reported SAR(1g) (W/kg)	Power Drift (dB)
Ch.	MHz									
25	1851.25	Left	Fig.16	21.11	21.5	0.45	<b>0.49</b>	0.881	<b>0.96</b>	-0.10

Note1: The distance between the EUT and the phantom bottom is 10mm

**Table 14.2-17: SAR Values (CDMA BC1 - Body)**

Ambient Temperature: 22.9 °C					Liquid Temperature: 22.5°C					
Frequency		Test Position	Figure No.	Conducted Power (dBm)	Max. tune-up Power (dBm)	Measured SAR(10g) (W/kg)	Reported SAR(10g) (W/kg)	Measured SAR(1g) (W/kg)	Reported SAR(1g) (W/kg)	Power Drift (dB)
Ch.	MHz									
25	1851.25	Rear	Fig.17	24.7	25	0.414	<b>0.44</b>	0.733	<b>0.79</b>	-0.06

Note1: The distance between the EUT and the phantom bottom is 15mm

**Table 14.2-18: SAR Values (CDMA BC10 - Head)**

Ambient Temperature: 22.9 °C					Liquid Temperature: 22.5°C						
Frequency		Side	Test Position	Figure No.	Conducted Power (dBm)	Max. tune-up Power (dBm)	Measured SAR(10g) (W/kg)	Reported SAR(10g) (W/kg)	Measured SAR(1g) (W/kg)	Reported SAR(1g) (W/kg)	Power Drift (dB)
Ch.	MHz										
476	817.9	Left	Touch	Fig.18	24.64	25	0.292	<b>0.32</b>	0.534	<b>0.58</b>	-0.09

**Table 14.2-19: SAR Values (CDMA BC0 - Body)**

Ambient Temperature: 22.9 °C					Liquid Temperature: 22.5°C					
Frequency		Test Position	Figure No.	Conducted Power (dBm)	Max. tune-up Power (dBm)	Measured SAR(10g) (W/kg)	Reported SAR(10g) (W/kg)	Measured SAR(1g) (W/kg)	Reported SAR(1g) (W/kg)	Power Drift (dB)
Ch.	MHz									
476	817.9	Left	Fig.19	24.65	25	0.363	<b>0.39</b>	0.696	<b>0.75</b>	-0.06

Note1: The distance between the EUT and the phantom bottom is 10mm



**Table 14.2-20: SAR Values (LTE Band7 - Head)**

Frequency		Mode	Side	Test Position	Figure No./ Note	Conducted Power (dBm)	Max. tune-up Power (dBm)	Measured SAR(10g) (W/kg)	Reported SAR(10g) (W/kg)	Measured SAR(1g) (W/kg)	Reported SAR(1g) (W/kg)	Power Drift (dB)
Ch.	MHz											
21100	2535	50RB_High	Right	Touch	Fig.20	20.74	21.20	0.221	<b>0.25</b>	0.47	<b>0.52</b>	-0.01

Note1: The LTE mode is QPSK\_20MHz.

**Table 14.2-21: SAR Values (LTE Band7 - Body)**

Frequency		Mode	Test Position	Figure No./ Note	Conducted Power (dBm)	Max. tune-up Power (dBm)	Measured SAR(10g) (W/kg)	Reported SAR(10g) (W/kg)	Measured SAR(1g) (W/kg)	Reported SAR(1g) (W/kg)	Power Drift (dB)
Ch.	MHz										
21350	2560	1RB_High	Rear	Fig.21	21.55	21.70	0.412	<b>0.43</b>	0.966	<b>1.00</b>	0.05

Note1: The distance between the EUT and the phantom bottom is 10mm.

Note3: The LTE mode is QPSK\_20MHz.

**Table 14.2-22: SAR Values (LTE Band7 - Body)**

Frequency		Mode	Test Position	Figure No./ Note	Conducted Power (dBm)	Max. tune-up Power (dBm)	Measured SAR(10g) (W/kg)	Reported SAR(10g) (W/kg)	Measured SAR(1g) (W/kg)	Reported SAR(1g) (W/kg)	Power Drift (dB)
Ch.	MHz										
21100	2535	1RB_High	Rear	Fig.22	22.88	23.50	0.194	<b>0.22</b>	0.400	<b>0.46</b>	0.12

Note1: The distance between the EUT and the phantom bottom is 15mm.

**Table 14.2-23: SAR Values (LTE Band12 - Head)**

Frequency		Mode	Side	Test Position	Figure No.	Conducted Power (dBm)	Max. tune-up Power (dBm)	Measured SAR(10g) (W/kg)	Reported SAR(10g) (W/kg)	Measured SAR(1g) (W/kg)	Reported SAR(1g) (W/kg)	Power Drift (dB)
Ch.	MHz											
23095	707.5	1RB_Mid	Left	Touch	Fig.23	24.31	24.70	0.402	<b>0.44</b>	0.723	<b>0.79</b>	-0.07

Note1: The LTE mode is QPSK\_10MHz.

**Table 14.2-24: SAR Values (LTE Band12 - Body)**

Ambient Temperature: 22.9 °C						Liquid Temperature: 22.5 °C					
Frequency		Mode	Test Position	Figure No.	Conducted Power (dBm)	Max. tune-up Power (dBm)	Measured SAR(10g) (W/kg)	Reported SAR(10g) (W/kg)	Measured SAR(1g) (W/kg)	Reported SAR(1g) (W/kg)	Power Drift (dB)
Ch.	MHz										
23095	707.5	1RB_Mid	Left	Fig.24	24.29	24.70	0.373	<b>0.41</b>	0.639	<b>0.70</b>	0.05

Note1: The distance between the EUT and the phantom bottom is 10mm.

Note2: The LTE mode is QPSK\_10MHz.

**Table 14.2-25: SAR Values (LTE Band13 - Head)**

Ambient Temperature: 22.9 °C						Liquid Temperature: 22.5 °C						
Frequency		Mode	Side	Test Position	Figure No.	Conducted Power (dBm)	Max. tune-up Power (dBm)	Measured SAR(10g) (W/kg)	Reported SAR(10g) (W/kg)	Measured SAR(1g) (W/kg)	Reported SAR(1g) (W/kg)	Power Drift (dB)
Ch.	MHz											
23230	782	1RB_High	Left	Touch	Fig.25	24.02	24.70	0.125	<b>0.15</b>	0.232	<b>0.27</b>	0.00

Note1: The LTE mode is QPSK\_10MHz.

**Table 14.2-26: SAR Values (LTE Band13 - Body)**

Ambient Temperature: 22.9 °C						Liquid Temperature: 22.5 °C					
Frequency		Mode	Test Position	Figure No.	Conducted Power (dBm)	Max. tune-up Power (dBm)	Measured SAR(10g) (W/kg)	Reported SAR(10g) (W/kg)	Measured SAR(1g) (W/kg)	Reported SAR(1g) (W/kg)	Power Drift (dB)
Ch.	MHz										
23230	782	1RB_Mid	Left	Fig.26	24.02	24.70	0.196	<b>0.23</b>	0.343	<b>0.40</b>	-0.10

Note1: The distance between the EUT and the phantom bottom is 10mm.

Note2: The LTE mode is QPSK\_10MHz.

**Table 14.2-27: SAR Values (LTE Band25 - Head)**

Ambient Temperature: 22.9 °C						Liquid Temperature: 22.5 °C						
Frequency		Mode	Side	Test Position	Figure No.	Conducted Power (dBm)	Max. tune-up Power (dBm)	Measured SAR(10g) (W/kg)	Reported SAR(10g) (W/kg)	Measured SAR(1g) (W/kg)	Reported SAR(1g) (W/kg)	Power Drift (dB)
Ch.	MHz											
26140	1860	1RB_High	Right	Touch	Fig.27	20.32	20.70	0.42	<b>0.46</b>	0.849	<b>0.93</b>	0.06

Note1: The LTE mode is QPSK\_20MHz.

**Table 14.2-28: SAR Values (LTE Band25 - Body)**

Ambient Temperature: 22.9 °C					Liquid Temperature: 22.5°C						
Frequency		Mode	Test Position	Figure No.	Conducted Power (dBm)	Max. tune-up Power (dBm)	Measured SAR(10g) (W/kg)	Reported SAR(10g) (W/kg)	Measured SAR(1g) (W/kg)	Reported SAR(1g) (W/kg)	Power Drift (dB)
Ch.	MHz										
26140	1860	1RB_Low	Left	Fig.28	21.59	21.70	0.518	<b>0.53</b>	1.02	<b>1.05</b>	-0.08

Note1: The distance between the EUT and the phantom bottom is 10mm

**Table 14.2-29: SAR Values (LTE Band25 - Body)**

Ambient Temperature: 22.9 °C					Liquid Temperature: 22.5°C						
Frequency		Mode	Test Position	Figure No.	Conducted Power (dBm)	Max. tune-up Power (dBm)	Measured SAR(10g) (W/kg)	Reported SAR(10g) (W/kg)	Measured SAR(1g) (W/kg)	Reported SAR(1g) (W/kg)	Power Drift (dB)
Ch.	MHz										
26140	1860	1RB_Mid	Rear	Fig.29	23.59	24.70	0.158	<b>0.20</b>	0.281	<b>0.36</b>	0.12

Note1: The distance between the EUT and the phantom bottom is 15mm

**Table 14.2-30: SAR Values (LTE Band26 - Head)**

Ambient Temperature: 22.9 °C					Liquid Temperature: 22.5°C							
Frequency		Mode	Side	Test Position	Figure No.	Conducted Power (dBm)	Max. tune-up Power (dBm)	Measured SAR(10g) (W/kg)	Reported SAR(10g) (W/kg)	Measured SAR(1g) (W/kg)	Reported SAR(1g) (W/kg)	Power Drift (dB)
Ch.	MHz											
26775	822.5	36RB_Mid	Left	Touch	Fig.30	23.10	23.70	0.275	<b>0.32</b>	0.497	<b>0.57</b>	0.13

Note1: The LTE mode is QPSK\_15MHz.

**Table 14.2-31: SAR Values (LTE Band26 - Body)**

Ambient Temperature: 22.9 °C					Liquid Temperature: 22.5°C						
Frequency		Mode	Test Position	Figure No.	Conducted Power (dBm)	Max. tune-up Power (dBm)	Measured SAR(10g) (W/kg)	Reported SAR(10g) (W/kg)	Measured SAR(1g) (W/kg)	Reported SAR(1g) (W/kg)	Power Drift (dB)
Ch.	MHz										
26865	831.5	1RB_Mid	Left	Fig.31	23.94	24.70	0.534	<b>0.64</b>	0.941	<b>1.12</b>	0.10

Note1: The distance between the EUT and the phantom bottom is 10mm.

Note2: The LTE mode is QPSK\_15MHz.

**Table 14.2-32: SAR Values (LTE Band41 PC2 - Head)**

Ambient Temperature: 22.9 °C						Liquid Temperature: 22.5°C						
Frequency		Mode	Side	Test Position	Figure No.	Conducted Power (dBm)	tune-up Power (dBm)	Measured SAR(10g) (W/kg)	Reported SAR(10g) (W/kg)	Measured SAR(1g) (W/kg)	Reported SAR(1g) (W/kg)	Power Drift (dB)
Ch.	MHz											
40620	2593	50RB_High	Right	Touch	Fig.32	20.56	21.20	0.071	<b>0.08</b>	0.15	<b>0.17</b>	0.09

Note1: The LTE mode is QPSK\_20MHz.

**Table 14.2-33: SAR Values (LTE Band41 PC2 - Body)**

Ambient Temperature: 22.9 °C						Liquid Temperature: 22.5°C					
Frequency		Mode	Test Position	Figure No.	Conducted Power (dBm)	tune-up Power (dBm)	Measured SAR(10g) (W/kg)	Reported SAR(10g) (W/kg)	Measured SAR(1g) (W/kg)	Reported SAR(1g) (W/kg)	Power Drift (dB)
Ch.	MHz										
40620	2593	50RB_High	Rear	Fig.33	21.54	22.00	0.127	<b>0.14</b>	0.299	<b>0.33</b>	-0.13

Note1: The distance between the EUT and the phantom bottom is 10mm.

Note4: The LTE mode is QPSK\_20MHz.

**Table 14.2-34: SAR Values (LTE Band41 PC2 - Body)**

Ambient Temperature: 22.9 °C						Liquid Temperature: 22.5°C					
Frequency		Mode	Test Position	Figure No.	Conducted Power (dBm)	tune-up Power (dBm)	Measured SAR(10g) (W/kg)	Reported SAR(10g) (W/kg)	Measured SAR(1g) (W/kg)	Reported SAR(1g) (W/kg)	Power Drift (dB)
Ch.	MHz										
41055	2636.5	1RB_High	Rear	Fig.34	26.72	27.70	0.212	<b>0.27</b>	0.447	<b>0.56</b>	0.01

Note1: The distance between the EUT and the phantom bottom is 15mm.

Note4: The LTE mode is QPSK\_20MHz.

**Table 14.2-35: SAR Values (LTE Band41 PC3 - Head)**

Ambient Temperature: 22.9 °C						Liquid Temperature: 22.5°C						
Frequency		Mode	Side	Test Position	Figure No.	Conducted Power (dBm)	tune-up Power (dBm)	Measured SAR(10g) (W/kg)	Reported SAR(10g) (W/kg)	Measured SAR(1g) (W/kg)	Reported SAR(1g) (W/kg)	Power Drift (dB)
Ch.	MHz											
40620	2593	50RB_High	Right	Touch	Fig.35	20.56	21.20	0.092	<b>0.11</b>	0.19	<b>0.22</b>	-0.03

Note1: The LTE mode is QPSK\_20MHz.

**Table 14.2-36: SAR Values (LTE Band41 PC3 - Body)**

Ambient Temperature: 22.9 °C						Liquid Temperature: 22.5°C					
Frequency		Mode	Test Position	Figure No.	Conducted Power (dBm)	tune-up Power (dBm)	Measured SAR(10g) (W/kg)	Reported SAR(10g) (W/kg)	Measured SAR(1g) (W/kg)	Reported SAR(1g) (W/kg)	Power Drift (dB)
Ch.	MHz										
40620	2593	50RB_High	Rear	Fig.36	21.58	22.00	0.192	<b>0.21</b>	0.45	<b>0.50</b>	-0.07

Note1: The distance between the EUT and the phantom bottom is 10mm.

Note2: The LTE mode is QPSK\_20MHz.

**Table 14.2-37: SAR Values (LTE Band41 PC3 - Body)**

Frequency		Mode	Test Position	Figure No.	Ambient Temperature: 22.9 °C		Liquid Temperature: 22.5 °C		Measured SAR(1g) (W/kg)	Reported SAR(1g) (W/kg)	Power Drift (dB)
Ch.	MHz				Conduct ed Power (dBm)	tune-up Power (dBm)	Measured SAR(10g) (W/kg)	Reported SAR(10g) (W/kg)			
40620	2593	50RB_High	Rear	Fig.37	23.52	24.00	0.113	<b>0.13</b>	0.24	<b>0.27</b>	0.02

Note1: The distance between the EUT and the phantom bottom is 15mm.

Note2: The LTE mode is QPSK\_20MHz.

**Table 14.2-38: SAR Values (LTE Band66 - Head)**

Frequency		Mode	Side	Test Position	Figure No.	Ambient Temperature: 22.9 °C		Liquid Temperature: 22.5 °C		Measured SAR(1g) (W/kg)	Reported SAR(1g) (W/kg)	Power Drift (dB)
Ch.	MHz					Conduct ed Power (dBm)	Max. tune-up Power (dBm)	Measured SAR(10g) (W/kg)	Reported SAR(10g) (W/kg)			
132572	1770	1RB_Low	Right	Touch	Fig.38	20.43	20.70	0.489	<b>0.52</b>	0.896	<b>0.95</b>	0.04

Note1: The LTE mode is QPSK\_20MHz.

**Table 14.2-39: SAR Values (LTE Band66 - Body)**

Frequency		Mode	Test Position	Figure No.	Ambient Temperature: 22.9 °C		Liquid Temperature: 22.5 °C		Measured SAR(1g) (W/kg)	Reported SAR(1g) (W/kg)	Power Drift (dB)
Ch.	MHz				Conduct ed Power (dBm)	Max. tune-up Power (dBm)	Measured SAR(10g) (W/kg)	Reported SAR(10g) (W/kg)			
132072	1720	1RB_Low	Rear	Fig.39	21.41	21.70	0.218	<b>0.23</b>	0.388	<b>0.41</b>	-0.14

Note1: The distance between the EUT and the phantom bottom is 10mm

Note2: The LTE mode is QPSK\_20MHz.

**Table 14.2-40: SAR Values (LTE Band66 - Body)**

Frequency		Mode	Test Position	Figure No.	Ambient Temperature: 22.9 °C		Liquid Temperature: 22.5 °C		Measured SAR(1g) (W/kg)	Reported SAR(1g) (W/kg)	Power Drift (dB)
Ch.	MHz				Conduct ed Power (dBm)	Max. tune-up Power (dBm)	Measured SAR(10g) (W/kg)	Reported SAR(10g) (W/kg)			
132072	1720	1RB_Low	Rear	Fig.40	24.14	25.10	0.359	<b>0.45</b>	0.614	<b>0.77</b>	-0.18

Note1: The distance between the EUT and the phantom bottom is 15mm

Note2: The LTE mode is QPSK\_20MHz.

**Table 14.2-41: SAR Values (LTE Band71 - Head)**

Frequency		Mode	Side	Test Position	Figure No.	Conducted Power (dBm)	Max. tune-up Power (dBm)	Measured SAR(10g) (W/kg)	Reported SAR(10g) (W/kg)	Measured SAR(1g) (W/kg)	Reported SAR(1g) (W/kg)	Power Drift (dB)
Ch.	MHz											
133222	673	1RB_Low	Left	Touch	Fig.41	24.67	24.70	0.326	<b>0.33</b>	0.582	<b>0.59</b>	0.05

Note1: The LTE mode is QPSK\_20MHz.

**Table 14.2-42: SAR Values (LTE Band71 - Body)**

Frequency		Mode	Test Position	Figure No.	Conducted Power (dBm)	Max. tune-up Power (dBm)	Measured SAR(10g) (W/kg)	Reported SAR(10g) (W/kg)	Measured SAR(1g) (W/kg)	Reported SAR(1g) (W/kg)	Power Drift (dB)
Ch.	MHz										
133222	673	1RB_Mid	Left	Fig.42	24.67	24.70	0.521	<b>0.52</b>	0.851	<b>0.86</b>	-0.11

Note1: The distance between the EUT and the phantom bottom is 10mm.

Note2: The LTE mode is QPSK\_20MHz.

### 14.3 WLAN Evaluation for 2.4G

According to the KDB248227 D01, SAR is measured for 2.4GHz 802.11b DSSS using the initial test position procedure.

#### Normal Power

#### Head Evaluation- Normal Power

**Table 14.3-1: SAR Values (WLAN - Head)– 802.11b (Fast SAR)**

Frequency		Side	Test Position	Figure No./ Note	Conducte d Power (dBm)	Max. tune-up Power (dBm)	Measured SAR(10g) (W/kg)	Reported SAR(10g) (W/kg)	Measured SAR(1g) (W/kg)	Reported SAR(1g)( W/kg)	Power Drift (dB)
MHz	Ch.										
Ambient Temperature: 22.9 °C      Liquid Temperature: 22.5 °C											
2462	11	Left	Touch	/	22.25	23.00	0.348	<b>0.41</b>	0.686	<b>0.82</b>	0.04
2462	11	Left	Tilt	/	22.25	23.00	0.172	<b>0.20</b>	0.345	<b>0.41</b>	-0.11
2462	11	Right	Touch	/	22.25	23.00	0.208	<b>0.25</b>	0.401	<b>0.48</b>	-0.12
2462	11	Right	Tilt	/	22.25	23.00	0.065	<b>0.08</b>	0.122	<b>0.14</b>	0.04

As shown above table, the initial test position for head is “Left Touch”. So the head SAR of WLAN is presented as below:

**Table 14.3-2: SAR Values (WLAN - Head)– 802.11b (Full SAR)**

Frequency		Side	Test Position	Figure No./ Note	Conducte d Power (dBm)	Max. tune-up Power (dBm)	Measured SAR(10g) (W/kg)	Reported SAR(10g) (W/kg)	Measured SAR(1g) (W/kg)	Reported SAR(1g)( W/kg)	Power Drift (dB)
MHz	Ch.										
Ambient Temperature: 22.9 °C      Liquid Temperature: 22.5 °C											
2462	11	Left	Touch	Fig.43	22.25	23.00	0.335	<b>0.40</b>	0.683	<b>0.81</b>	0.04
2437	6	Left	Touch		22.20	23.00	0.324	<b>0.39</b>	0.669	<b>0.80</b>	0.14
2462	11	Left	Tilt		22.25	23.00	0.21	<b>0.25</b>	0.386	<b>0.46</b>	-0.12

Note1: When the reported SAR of the initial test position is > 0.4 W/kg, SAR is repeated for the 802.11 transmission mode configuration tested in the initial test position using subsequent highest estimated 1-g SAR conditions determined by area scans, on the highest maximum output power channel, until the reported SAR is ≤ 0.8 W/kg.  
 Note2: For all positions/configurations tested using the initial test position and subsequent test positions, when the reported SAR is > 0.8 W/kg, SAR is measured for these test positions/configurations on the subsequent next highest measured output power channel until the reported SAR is ≤ 1.2 W/kg or all required channels are tested.

According to the KDB248227 D01, The reported SAR must be scaled to 100% transmission duty factor to determine compliance at the maximum tune-up tolerance limit. The scaled reported SAR is presented as below.

**Table 14.3-3: SAR Values (WLAN - Head) – 802.11b (Scaled Reported SAR)**

Frequency		Side	Test Position	Actual duty factor	maximum duty factor	Reported SAR (1g)(W/kg)	Scaled reported SAR (1g)(W/kg)
MHz	Ch.						
Ambient Temperature: 22.9 °C      Liquid Temperature: 22.5 °C							
2462	12	Left	Tilt	99.28%	100%	<b>0.81</b>	<b>0.82</b>

SAR is not required for OFDM because the 802.11b adjusted SAR ≤ 1.2 W/kg.

**Body Evaluation- Normal Power**
**Table 14.3-4: SAR Values (WLAN - Body)– 802.11b (Fast SAR)**

Frequency		Test Position	Figure No./ Note	Conducted Power (dBm)	Max. tune-up Power (dBm)	Ambient Temperature: 22.9°C		Liquid Temperature: 22.5°C		Power Drift (dB)
MHz	Ch.					Measured SAR(10g) (W/kg)	Reported SAR(10g) (W/kg)	Measured SAR(1g) (W/kg)	Reported SAR(1g)(W/kg)	
2462	11	Front	/	22.25	23.00	0.045	<b>0.05</b>	0.084	<b>0.10</b>	0.07
2462	11	Rear	/	22.25	23.00	0.073	<b>0.09</b>	0.138	<b>0.16</b>	-0.11
2462	11	Right	/	22.25	23.00	0.059	<b>0.07</b>	0.112	<b>0.13</b>	-0.02
2462	11	Top	/	22.25	23.00	0.02	<b>0.02</b>	0.039	<b>0.05</b>	-0.05

As shown above table, the initial test position for body is “Rear”. So the body SAR of WLAN is presented as below:

**Table 14.3-5: SAR Values (WLAN - Body)– 802.11b (Full SAR)**

Frequency		Test Position	Figure No./ Note	Conducted Power (dBm)	Max. tune-up Power (dBm)	Ambient Temperature: 22.9°C		Liquid Temperature: 22.5°C		Power Drift (dB)
MHz	Ch.					Measured SAR(10g) (W/kg)	Reported SAR(10g) (W/kg)	Measured SAR(1g) (W/kg)	Reported SAR(1g)(W/kg)	
2462	11	Rear	Fig.44	22.25	23.00	0.062	<b>0.07</b>	0.124	<b>0.15</b>	-0.11

Note1: When the reported SAR of the initial test position is > 0.4 W/kg, SAR is repeated for the 802.11 transmission mode configuration tested in the initial test position using subsequent highest estimated 1-g SAR conditions determined by area scans, on the highest maximum output power channel, until the reported SAR is  $\leq$  0.8 W/kg.

Note2: For all positions/configurations tested using the initial test position and subsequent test positions, when the reported SAR is > 0.8 W/kg, SAR is measured for these test positions/configurations on the subsequent next highest measured output power channel until the reported SAR is  $\leq$  1.2 W/kg or all required channels are tested.

According to the KDB248227 D01, The reported SAR must be scaled to 100% transmission duty factor to determine compliance at the maximum tune-up tolerance limit. The scaled reported SAR is presented as below.

**Table 14.3-6: SAR Values (WLAN - Body) – 802.11b (Scaled Reported SAR)**

Frequency		Test Position	Ambient Temperature: 22.9°C		Liquid Temperature: 22.5°C	
MHz	Ch.		Actual duty factor	maximum duty factor	Reported SAR (1g)(W/kg)	Scaled reported SAR (1g)(W/kg)
2462	11	Rear	99.28%	100%	<b>0.15</b>	<b>0.15</b>

SAR is not required for OFDM because the 802.11b adjusted SAR  $\leq$  1.2 W/kg.



**Head Evaluation- Low Power**
**Table 14.3-7: SAR Values (WLAN - Head)– 802.11b (Fast SAR)**

Frequency		Side	Test Position	Figure No./ Note	Conducte d Power (dBm)	Max. tune-up Power (dBm)	Measured SAR(10g) (W/kg)	Reported SAR(10g) (W/kg)	Measured SAR(1g) (W/kg)	Reported SAR(1g)( W/kg)	Power Drift (dB)
MHz	Ch.										
		Ambient Temperature: 22.9 °C					Liquid Temperature: 22.5°C				
2462	11	Left	Touch	/	19.21	19.50	0.198	<b>0.21</b>	0.362	<b>0.39</b>	0.01
2462	11	Left	Tilt	/	19.21	19.50	0.062	<b>0.07</b>	0.121	<b>0.13</b>	0.08
2462	11	Right	Touch	/	19.21	19.50	0.071	<b>0.08</b>	0.142	<b>0.15</b>	-0.10
2462	11	Right	Tilt	/	19.21	19.50	0.037	<b>0.04</b>	0.064	<b>0.07</b>	0.06

As shown above table, the initial test position for head is “Left Touch”. So the head SAR of WLAN is presented as below:

**Table 14.3-8: SAR Values (WLAN - Head)– 802.11b (Full SAR)**

Frequency		Side	Test Position	Figure No./ Note	Conducte d Power (dBm)	Max. tune-up Power (dBm)	Measured SAR(10g) (W/kg)	Reported SAR(10g) (W/kg)	Measured SAR(1g) (W/kg)	Reported SAR(1g)( W/kg)	Power Drift (dB)
MHz	Ch.										
		Ambient Temperature: 22.9 °C					Liquid Temperature: 22.5°C				
2462	11	Left	Touch	/	19.21	19.50	0.213	<b>0.23</b>	0.407	<b>0.44</b>	0.01
2462	11	Left	Tilt	/	19.21	19.50	0.066	<b>0.07</b>	0.118	<b>0.13</b>	-0.10

Note1: When the reported SAR of the initial test position is > 0.4 W/kg, SAR is repeated for the 802.11 transmission mode configuration tested in the initial test position using subsequent highest estimated 1-g SAR conditions determined by area scans, on the highest maximum output power channel, until the reported SAR is  $\leq$  0.8 W/kg.

Note2: For all positions/configurations tested using the initial test position and subsequent test positions, when the reported SAR is > 0.8 W/kg, SAR is measured for these test positions/configurations on the subsequent next highest measured output power channel until the reported SAR is  $\leq$  1.2 W/kg or all required channels are tested.

According to the KDB248227 D01, The reported SAR must be scaled to 100% transmission duty factor to determine compliance at the maximum tune-up tolerance limit. The scaled reported SAR is presented as below.

**Table 14.3-9: SAR Values (WLAN - Head) – 802.11b (Scaled Reported SAR)**

Frequency		Side	Test Position	Actual duty factor	maximum duty factor	Reported SAR (1g)(W/kg)	Scaled reported SAR (1g)(W/kg)	
MHz	Ch.							
		Ambient Temperature: 22.9 °C					Liquid Temperature: 22.5°C	
2462	11	Left	Touch	99.28%	100%	<b>0.44</b>	<b>0.44</b>	

SAR is not required for OFDM because the 802.11b adjusted SAR  $\leq$  1.2 W/kg.

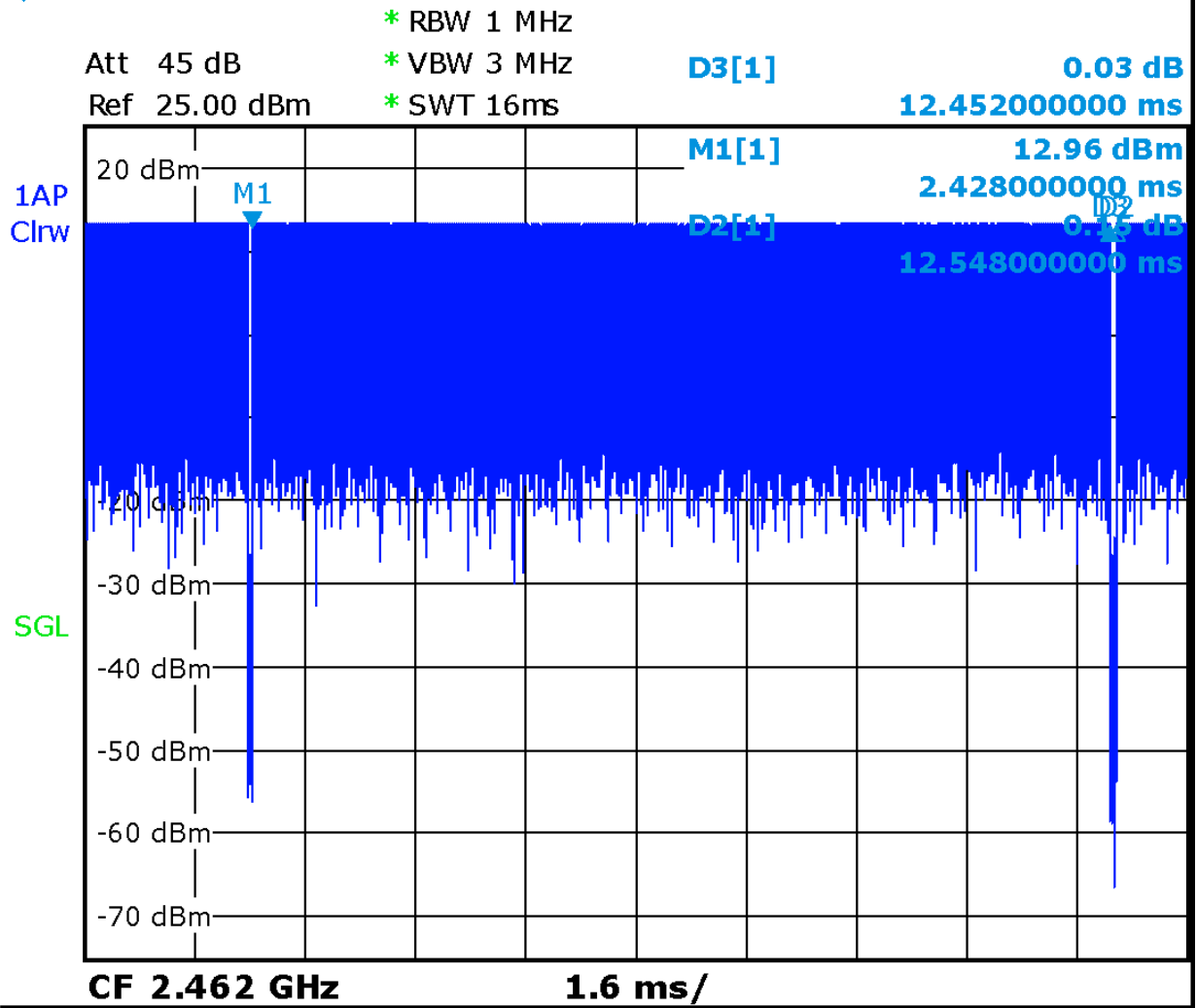

Picture 14.1 Duty factor plot for head

## 14.4 WLAN Evaluation For 5G

**Table 14.4-1: OFDM mode specified maximum output power of WLAN antenna**

802.11 mode	a	g	n		ac			
Ch. BW(MHz)	20	20	20	40	20	40	80	160
U-NII-1	X		X	X	X	X	X	
U-NII-2A	X		X	X	X	X	X	
U-NII-2C	X		X	X	X	X	X	
U-NII-3	X		X	X	X	X	X	
§ 15.247 (5.8 GHz)								

X: maximum(conducted) output power(mW), including tolerance, specified for production units

**Table 14.4-2: Maximum output power specified of WLAN antenna for Normal Power**

802.11 mode	a	g	n		ac			
Ch. BW(MHz)	20	20	20	40	20	40	80	160
U-NII-1	112		100	100	89	100	100	
U-NII-2A	112		100	100	89	100	100	
U-NII-2C	112		100	100	89	100	100	
U-NII-3	112		100	100	89	100	100	
§ 15.247 (5.8 GHz)								

- The maximum output power specified for production units is the same for all channels, modulations and data rates in each channel bandwidth configuration of the 802.11a/g/n/ac modes.
- The **blue highlighted** cells represent highest output configurations in each standalone or aggregated frequency band, with tune-up tolerance included.

**Table 14.4-3: Maximum output power specified of WLAN antenna for Low Power**

802.11 mode	a	g	n		ac			
Ch. BW(MHz)	20	20	20	40	20	40	80	160
U-NII-1	50		50	45	50	45	45	
U-NII-2A	35		35	32	35	32	32	
U-NII-2C	50		50	45	50	45	45	
U-NII-3	56		56	50	56	50	50	
§ 15.247 (5.8 GHz)								

- The maximum output power specified for production units is the same for all channels, modulations and data rates in each channel bandwidth configuration of the 802.11a/g/n/ac modes.
- The **blue highlighted** cells represent highest output configurations in each standalone or aggregated frequency band, with tune-up tolerance included.

**Table 14.4-4: Maximum output power measured of WLAN antenna, for the applicable OFDM configurations according to the default power measurement procedures for selection initial test configurations - Normal Power**

802.11 mode	a	n		ac		
BW(MHz)	20	20	40	20	40	80
U-NII-1	<b>36</b> /40/44/48 <b>85</b> /83/78/78	36/40/44/48 Lower power	38/46 Lower power	36/40/44/48 Lower power	38/46 Lower power	42 Lower power
U-NII-2A	<b>52</b> /56/60/64 <b>77</b> /72/73/75	52/56/60/64 Lower power	54/62 Lower power	52/56/60/64 Lower power	54/62 Lower power	58 Lower power
U-NII-2C	100/104/108/112 <b>78</b> /82/88/95 <b>116</b> /120/124/128 <b>99</b> /98/94/92 132/136/140/144 <b>88</b> /82/90/97	100/104/108/112 2 116/132/136/144 0 Lower power	102/110/134 Lower power	100/104/108 /112 116/132/136 /140 Lower power	102/110/134 Lower power	106 Lower power
U-NII-3	149/ <b>153</b> /157/161/165 <b>95</b> /98/97/89/82	149/153/157/161/165 1/165 Lower power	151/159 Lower power	149/153/157/161/165 Lower power	151/159 Lower power	155 Lower power

- The **bold numbers** is the maximum output measured power (mW).
- Channels with measured maximum power within 0.25dB are considered to have the same measured output. Channels selected for initial test configuration are **highlighted in yellow**.

**Table 14.4-5: Maximum output power measured of WLAN antenna, for the applicable OFDM configurations according to the default power measurement procedures for selection initial test configurations – Low Power**

802.11 mode	a	n		ac		
BW(MHz)	20	20	40	20	40	80
U-NII-1	<b>36</b> /40/44/48 <b>46</b> /43/37/35	36/40/44/48 Lower power	38/46 Lower power	36/40/44/48 Lower power	38/46 Lower power	42 Lower power
U-NII-2A	<b>52</b> /56/60/64 <b>34</b> /32/32/33	52/56/60/64 Lower power	54/62 Lower power	52/56/60/64 Lower power	54/62 Lower power	58 Lower power
U-NII-2C	100/104/108/112 <b>39</b> /41/42/45 116/120/124/128 <b>41</b> /41/41/42	100/104/108/112 2 116/132/136/144 0 Lower power	102/110/134 Lower power	100/104/108 /112 116/132/136 /140 Lower power	102/110/134 Lower power	106 Lower power

	132/136/140/ <b>144</b> <b>41/39/43/46</b>	Lower power		Lower power		
<b>U-NII-3</b>	149/153/ <b>157</b> /161/165 <b>46/51/52/48/46</b>	149/153/157/16 1/165 Lower power	151/159 Lower power	149/153/157 /161/165 Lower power	151/159 Lower power	155 Lower power
<ul style="list-style-type: none"> <li>● The <b>bold numbers</b> is the maximum output measured power (mW).</li> <li>● Channels with measured maximum power within 0.25dB are considered to have the same measured output. Channels selected for initial test configuration are <b>highlighted in yellow</b>.</li> </ul>						

**Table 14.4-6: Reported SAR of initial test configuration for Normal Power Head**

802.11 mode	a	n		ac		
BW(MHz)	20	20	40	20	40	80
<b>U-NII-1</b>	36/40/44/48 UNII-2A exclusion applied	36/40/44/48	38/46	36/40/44/48	38/46	42
<b>U-NII-2A</b>	<b>52</b> /56/60/64 0.21	52/56/60/64	54/62	52/56/60/64	54/62	58
<b>U-NII-2C</b>	100/104/108/112/ <b>116</b> /120/124 /128/132/136/140/144 0.18	100/104/108/112 116/132/136/140	102/110/118/ 126/134	100/104/108/112 116/132/136/140	102/110 /134	106
<b>U-NII-3</b>	149/ <b>153</b> /157/161/165 0.21	149/153/157/161/ 165	151/159	149/153/157/161 /165	151/159	155

Highest measured output power channel tested initially are in **yellow highlight**.

The tune up of UNII-1 is less than UNII-2A. SAR is measured for UNII-2A band first. Adjusted SAR of UNII-2A band is ≤ 1.2 W/kg. SAR is not required for UNII-1 band.

**Table 14.4-7: Reported SAR of initial test configuration for Normal Power Body**

802.11 mode	a	n		ac		
BW(MHz)	20	20	40	20	40	80
<b>U-NII-1</b>	36/40/44/48 UNII-2A exclusion applied	36/40/44/48	38/46	36/40/44/48	38/46	42
<b>U-NII-2A</b>	<b>52</b> /56/60/64 0.75	52/56/60/64	54/62	52/56/60/64	54/62	58
<b>U-NII-2C</b>	100/104/108/112/ <b>116</b> /120/124 /128/132/136/140/144 0.30	100/104/108/112 116/132/136/140	102/110/118/ 126/134	100/104/108/112 116/132/136/140	102/110 /134	106
<b>U-NII-3</b>	149/ <b>153</b> /157/161/165 0.44	149/153/157/161/ 165	151/159	149/153/157/161 /165	151/159	155

Highest measured output power channel tested initially are in **yellow highlight**.

The tune up of UNII-1 is less than UNII-2A. SAR is measured for UNII-2A band first. Adjusted SAR of UNII-2A band is ≤ 1.2 W/kg. SAR is not required for UNII-1 band.

**Table 14.4-8: Reported SAR of initial test configuration for Low Power Body**

802.11 mode	a	n		ac		
BW(MHz)	20	20	40	20	40	80
U-NII-1	36/40/44/48 UNII-2A exclusion applied	36/40/44/48	38/46	36/40/44/48	38/46	42
U-NII-2A	52/56/60/64 0.26	52/56/60/64	54/62	52/56/60/64	54/62	58
U-NII-2C	100/104/108/112/116/120/124 /128/132/136/140/144 0.14	100/104/108/112 116/132/136/140	102/110/118/ 126/134	100/104/108/112 116/132/136/140	102/110 /134	106
U-NII-3	149/153/157/161/165 0.20	149/153/157/161/ 165	151/159	149/153/157/161 /165	151/159	155

Highest measured output power channel tested initially are in yellow highlight.

The tune up of UNII-1 is less than UNII-2A. SAR is measured for UNII-2A band first. Adjusted SAR of UNII-2A band is ≤ 1.2 W/kg. SAR is not required for UNII-1 band.

**Table 14.4-9: SAR Values (WLAN - Normal Power Head)**

Frequency		Side	Test Position	Figure No.	Conducted Power (dBm)	Max. tune-up Power (dBm)	Measured SAR(10g) (W/kg)	Reported SAR(10g) (W/kg)	Measured SAR(1g) (W/kg)	Reported SAR(1g) (W/kg)	Power Drift (dB)
MHz	Ch.										
52	5260	Left	Touch	/	18.85	20.50	0.052	0.08	0.142	0.21	0.06
52	5260	Left	Tilt	/	18.85	20.50	0.047	0.07	0.139	0.20	-0.09
52	5260	Right	Touch	/	18.85	20.50	0.029	0.04	0.082	0.12	-0.11
52	5260	Right	Tilt	/	18.85	20.50	0.025	0.04	0.075	0.11	-0.10
116	5580	Left	Touch	/	19.96	20.50	0.057	0.06	0.163	0.18	0.06
116	5580	Left	Tilt	/	19.96	20.50	0.053	0.06	0.16	0.18	-0.06
116	5580	Right	Touch	/	19.96	20.50	0.014	0.02	0.059	0.07	-0.12
116	5580	Right	Tilt	/	19.96	20.50	0.021	0.02	0.071	0.08	-0.11
153	5765	Left	Touch	Fig.45	19.93	20.50	0.065	0.07	0.182	0.21	0.12
153	5765	Left	Tilt	/	19.93	20.50	0.052	0.06	0.155	0.18	0.01
153	5765	Right	Touch	/	19.93	20.50	0.013	0.01	0.058	0.07	0.10
153	5765	Right	Tilt	/	19.93	20.50	0.026	0.03	0.072	0.08	-0.11

**Table 14.4-10: SAR Values (WLAN - Normal Power Body)**

Frequency		Test Position	Figure No.	Conducted Power (dBm)	Max. tune-up Power (dBm)	Measured SAR(10g) (W/kg)	Reported SAR(10g) (W/kg)	Measured SAR(1g) (W/kg)	Reported SAR(1g) (W/kg)	Power Drift (dB)
MHz	Ch.									
52	5260	Front	/	18.85	20.50	0.028	0.04	0.12	0.18	0.13
52	5260	Rear	Fig.46	18.85	20.50	0.162	0.24	0.511	0.75	0.10
52	5260	Right	/	18.85	20.50	0.091	0.13	0.264	0.39	-0.08
52	5260	Top	/	18.85	20.50	0.032	0.05	0.083	0.12	-0.02
116	5580	Front	/	19.96	20.50	0.033	0.04	0.1	0.11	-0.10

116	5580	Rear	/	19.96	20.50	0.124	<b>0.14</b>	0.268	<b>0.30</b>	-0.08
116	5580	Right	/	19.96	20.50	0.062	<b>0.07</b>	0.118	<b>0.13</b>	0.12
116	5580	Top	/	19.96	20.50	0.028	<b>0.03</b>	0.102	<b>0.12</b>	-0.02
153	5765	Front	/	19.93	20.50	0.036	<b>0.04</b>	0.116	<b>0.13</b>	0.02
153	5765	Rear	/	19.93	20.50	0.155	<b>0.18</b>	0.386	<b>0.44</b>	-0.02
153	5765	Right	/	19.93	20.50	0.067	<b>0.08</b>	0.133	<b>0.15</b>	0.05
153	5765	Top	/	19.93	20.50	0.032	<b>0.04</b>	0.063	<b>0.07</b>	-0.12

Note1: The distance between the EUT and the phantom bottom is 10mm.

**Table 14.4-11: SAR Values (WLAN - Low Power Body)**

Frequency		Test Position	Figure No.	Conducted Power (dBm)	Max. tune-up Power (dBm)	Measured SAR(10g) (W/kg)	Reported SAR(10g) (W/kg)	Measured SAR(1g) (W/kg)	Reported SAR(1g) (W/kg)	Power Drift (dB)
MHz	Ch.									
52	5260	Front	/	15.27	15.50	0.013	<b>0.01</b>	0.058	<b>0.06</b>	-0.09
52	5260	Rear	/	15.27	15.50	0.074	<b>0.08</b>	0.247	<b>0.26</b>	0.08
52	5260	Right	/	15.27	15.50	0.042	<b>0.04</b>	0.128	<b>0.13</b>	0.02
52	5260	Top	/	15.27	15.50	0.015	<b>0.02</b>	0.04	<b>0.04</b>	0.04
144	5720	Front	/	16.65	17.00	0.015	<b>0.02</b>	0.048	<b>0.05</b>	-0.10
144	5720	Rear	/	16.65	17.00	0.057	<b>0.06</b>	0.13	<b>0.14</b>	0.07
144	5720	Rear	/	16.65	17.00	0.028	<b>0.03</b>	0.057	<b>0.06</b>	-0.05
144	5720	Right	/	16.65	17.00	0.013	<b>0.01</b>	0.049	<b>0.05</b>	0.05
144	5720	Top	/	17.15	17.50	0.016	<b>0.02</b>	0.056	<b>0.06</b>	-0.07
157	5785	Front	/	17.15	17.50	0.071	<b>0.08</b>	0.187	<b>0.20</b>	0.10
157	5785	Rear	/	17.15	17.50	0.031	<b>0.03</b>	0.064	<b>0.07</b>	0.11
157	5785	Right	/	17.15	17.50	0.015	<b>0.02</b>	0.03	<b>0.03</b>	0.13
157	5785	Top	/	15.27	15.50	0.013	<b>0.01</b>	0.058	<b>0.06</b>	-0.09

Note1: The distance between the EUT and the phantom bottom is 10mm.

According to the KDB248227 D01, The reported SAR must be scaled to 100% transmission duty factor to determine compliance at the maximum tune-up tolerance limit. The scaled reported SAR is presented as below.

**Table 14.4-12: SAR Values (WLAN - Normal Power Head) - Scaled Reported SAR**

Frequency		Side	Test Position	Actual duty factor	maximum duty factor	Reported SAR (1g) (W/kg)	Scaled reported SAR (1g) (W/kg)
MHz	Ch.						
153	5765	Left	Touch	98.69%	100%	<b>0.21</b>	<b>0.21</b>

**Table 14.4-13: SAR Values (WLAN - Normal Power Body) – Scaled Reported SAR**

Frequency		Test Position	D (mm)	Actual duty factor	maximum duty factor	Reported SAR (1g) (W/kg)	Scaled reported SAR (1g) (W/kg)
MHz	Ch.						
52	5260	Rear	10	98.68%	100%	<b>0.75</b>	<b>0.76</b>

**Table 14.4-14: SAR Values (WLAN - Low Power Body) – Scaled Reported SAR**

Frequency		Test Position	D (mm)	Actual duty factor	maximum duty factor	Reported SAR (1g) (W/kg)	Scaled reported SAR (1g) (W/kg)
MHz	Ch.						
52	5260	Rear	10	98.68%	100%	<b>0.26</b>	<b>0.26</b>

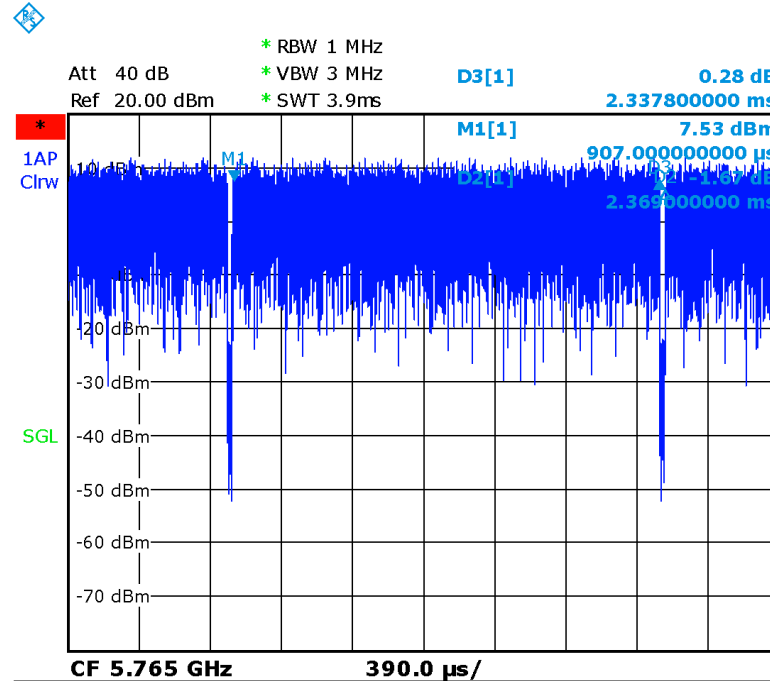
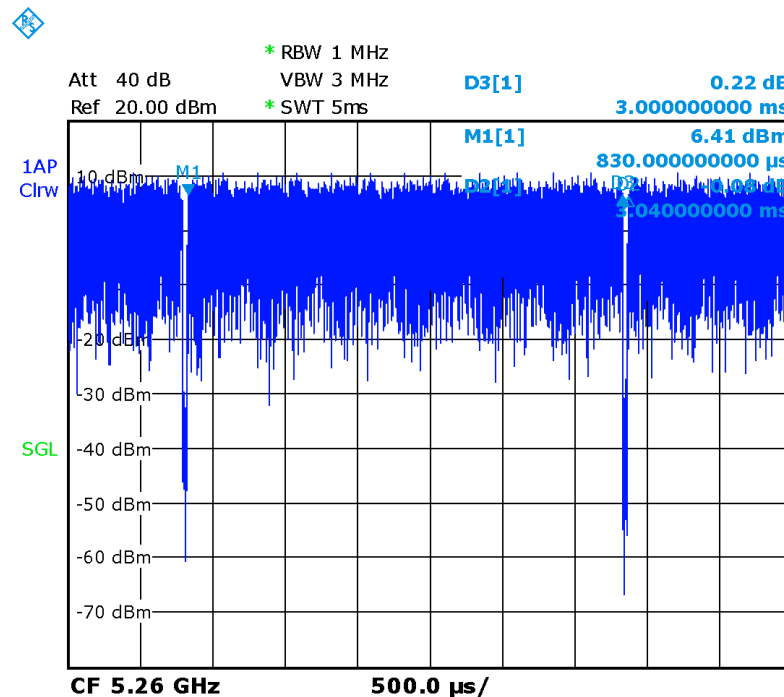
**Picture 14.3 The plot of duty factor for Normal Power SISO antenna5 Head**

**Picture 14.4 The plot of duty factor for Normal Power MIMO Head**



### 14.5 SAR results for Fast BT

**Table 15.5-1: SAR Values (Bluetooth - Head)**

Frequency		Side	Test Position	Figure No.	Conducted Power (dBm)	Max. tune-up Power (dBm)	Measured SAR(10g) (W/kg)	Reported SAR(10g) (W/kg)	Measured SAR(1g) (W/kg)	Reported SAR(1g) (W/kg)	Power Drift (dB)
Ch.	MHz										
78	2480	Left	Touch	/	11.20	12	< 0.01	<b>&lt; 0.01</b>	< 0.01	<b>&lt; 0.01</b>	/
78	2480	Left	Tilt	/	11.20	12	< 0.01	<b>&lt; 0.01</b>	< 0.01	<b>&lt; 0.01</b>	/
78	2480	Right	Touch	/	11.20	12	< 0.01	<b>&lt; 0.01</b>	< 0.01	<b>&lt; 0.01</b>	/
78	2480	Right	Tilt	/	11.20	12	< 0.01	<b>&lt; 0.01</b>	< 0.01	<b>&lt; 0.01</b>	/

**Table 15.5-2: SAR Values (Bluetooth - Body)**

Frequency		Test Position	Figure No.	Conducted Power (dBm)	Max. tune-up Power (dBm)	Measured SAR(10g) (W/kg)	Reported SAR(10g) (W/kg)	Measured SAR(1g) (W/kg)	Reported SAR(1g) (W/kg)	Power Drift (dB)
Ch	MHz									
Ambient Temperature: 22.2 °C      Liquid Temperature: 22 °C										
78	2480	Front	/	11.20	12	< 0.01	<b>&lt; 0.01</b>	< 0.01	<b>&lt; 0.01</b>	/
78	2480	Rear	/	11.20	12	< 0.01	<b>&lt; 0.01</b>	< 0.01	<b>&lt; 0.01</b>	/
78	2480	Left	/	11.20	12	< 0.01	<b>&lt; 0.01</b>	< 0.01	<b>&lt; 0.01</b>	/
78	2480	Right	/	11.20	12	< 0.01	<b>&lt; 0.01</b>	< 0.01	<b>&lt; 0.01</b>	/
78	2480	Bottom	/	11.20	12	< 0.01	<b>&lt; 0.01</b>	< 0.01	<b>&lt; 0.01</b>	/
78	2480	Top	/	11.20	12	< 0.01	<b>&lt; 0.01</b>	< 0.01	<b>&lt; 0.01</b>	/

Note1: The distance between the EUT and the phantom bottom is 10mm

## 14.6 SAR results for SUB6G

According to the conducted power, the main measurement DFT, verify the CP at the maximum position.

**Table 14.6-1: SAR Values (NR5G n2-Head)**

Frequency		Ambient Temperature: 22.2 °C				Liquid Temperature: 22 °C					
Ch.	MHz	Side	Test Position	Figure No./Note	Conducted Power (dBm)	Max. tune-up Power (dBm)	Measured SAR(10g) (W/kg)	Reported SAR(10g) (W/kg)	Measured SAR(1g) (W/kg)	Reported SAR(1g) (W/kg)	Power Drift (dB)
372000	1860	Left	Cheek	/	20.1	20.3	0.167	<b>0.17</b>	0.272	<b>0.28</b>	0.15
372000	1860	Left	Tilt	/	20.1	20.3	0.12	<b>0.13</b>	0.208	<b>0.22</b>	0.03
372000	1860	Right	Cheek	Fig.47	20.1	20.3	0.356	<b>0.37</b>	0.749	<b>0.78</b>	0.05
372000	1860	Right	Tilt	/	20.1	20.3	0.140	<b>0.15</b>	0.250	<b>0.26</b>	-0.07
372000	1860	Right	Cheek	CP-OFDM	20.07	20.3	0.323	<b>0.34</b>	0.620	<b>0.65</b>	0.08

**Table 14.6-2: SAR Values (NR5G n2-Body)**

Frequency		Ambient Temperature: 22.2 °C				Liquid Temperature: 22 °C					
Ch.	MHz	Test Position	Figure No./Note	Conducted Power (dBm)	Max. tune-up Power (dBm)	Measured SAR(10g) (W/kg)	Reported SAR(10g)(W/kg)	Measured SAR(1g) (W/kg)	Reported SAR(1g) (W/kg)	Power Drift (dB)	
372000	1860	Front	/	21.14	21.4	0.134	<b>0.14</b>	0.242	<b>0.26</b>	0.09	
372000	1860	Rear	/	21.14	21.4	0.312	<b>0.33</b>	0.584	<b>0.62</b>	0.13	
380000	1900	Left	/	20.76	21.4	0.317	<b>0.37</b>	0.631	<b>0.73</b>	0.09	
376000	1880	Left	/	20.95	21.4	0.329	<b>0.36</b>	0.642	<b>0.71</b>	0.15	
372000	1860	Left	Fig.48	21.14	21.4	0.355	<b>0.38</b>	0.698	<b>0.74</b>	0.13	
372000	1860	Top	/	21.14	21.4	0.076	<b>0.08</b>	0.126	<b>0.13</b>	-0.08	
376000	1880	Left	Note1	22.8	23.5	1.71	<b>2.01</b>	3.86	<b>4.54</b>	0.06	
372000	1860	Left	Note1	23.26	24.5	1.86	<b>2.47</b>	4.30	<b>5.72</b>	0.05	
372000	1860	Left	Note1	22.98	23.5	2.22	<b>2.50</b>	5.31	<b>5.99</b>	0.09	
372000	1860	Left	CP-OFDM	20.37	20.4	0.340	<b>0.34</b>	0.640	<b>0.64</b>	0.16	

Note: The distance between the EUT and the phantom bottom is 10mm

Note1: The distance between the EUT and the phantom bottom is 0mm

**Table 14.6-3: SAR Values (NR5G n2-Body)**

Frequency		Ambient Temperature: 22.2 °C				Liquid Temperature: 22 °C				
Ch.	MHz	Test Position	Figure No./ Note	Conducted Power (dBm)	Max. tune-up Power (dBm)	Measured SAR(10g) (W/kg)	Reported SAR(10g)(W/kg)	Measured SAR(1g) (W/kg)	Reported SAR(1g) (W/kg)	Power Drift (dB)
376000	1880	Front	/	23.26	24.5	0.114	<b>0.15</b>	0.202	<b>0.27</b>	0.09
376000	1880	Rear	Fig.49	23.26	24.5	0.211	<b>0.28</b>	0.367	<b>0.49</b>	-0.03
376000	1880	Rear	CP-OFDM	22.41	22.9	0.180	<b>0.20</b>	0.323	<b>0.36</b>	0.19

Note: The distance between the EUT and the phantom bottom is 15mm

**Table 14.6-4: SAR Values (NR5G n25-Head)**

Frequency		Ambient Temperature: 22.2 °C				Liquid Temperature: 22 °C					
Ch.	MHz	Side	Test Position	Figure No./Note	Conducted Power (dBm)	Max. tune-up Power (dBm)	Measured SAR(10g) (W/kg)	Reported SAR(10g) (W/kg)	Measured SAR(1g) (W/kg)	Reported SAR(1g) (W/kg)	Power Drift (dB)
376500	1882.5	Left	Cheek	/	23.2	24.5	0.062	<b>0.08</b>	0.010	<b>0.01</b>	0.03
376500	1882.5	Left	Tilt	/	23.2	24.5	0.027	<b>0.04</b>	0.045	<b>0.06</b>	0.07
376500	1882.5	Right	Cheek	Fig.50	23.2	24.5	0.04	<b>0.05</b>	0.062	<b>0.08</b>	-0.01
376500	1882.5	Right	Tilt	/	23.2	24.5	0.029	<b>0.04</b>	0.05	<b>0.07</b>	-0.11
376500	1882.5	Right	Cheek	CP-OFDM	21.29	22.5	0.035	<b>0.05</b>	0.055	<b>0.07</b>	0.06

**Table 14.6-5: SAR Values (NR5G n25-Body)**

Frequency		Ambient Temperature: 22.2 °C				Liquid Temperature: 22 °C				
Ch.	MHz	Test Position	Figure No./ Note	Conducted Power (dBm)	Max. tune-up Power (dBm)	Measured SAR(10g) (W/kg)	Reported SAR(10g)(W/kg)	Measured SAR(1g) (W/kg)	Reported SAR(1g) (W/kg)	Power Drift (dB)
382500	1912.5	Front	/	21.16	21.7	0.259	<b>0.29</b>	0.462	<b>0.52</b>	0.12
382500	1912.5	Rear	Fig.51	21.16	21.7	0.366	<b>0.41</b>	0.663	<b>0.75</b>	0.03
382500	1912.5	Left	/	21.16	21.7	0.040	<b>0.05</b>	0.066	<b>0.07</b>	0.07
382500	1912.5	Right	/	21.16	21.7	0.032	<b>0.04</b>	0.064	<b>0.07</b>	0.11
382500	1912.5	Bottom	/	21.16	21.7	0.347	<b>0.39</b>	0.625	<b>0.71</b>	-0.10
382500	1912.5	Rear	CP-OFDM	21.13	21.7	0.354	<b>0.40</b>	0.649	<b>0.74</b>	0.08

Note: The distance between the EUT and the phantom bottom is 10mm

**Table 14.6-6: SAR Values (NR5G n41-Head)**

Frequency		Side	Test Position	Figure No./Note	Conducted Power (dBm)	Max. tune-up Power (dBm)	Measured SAR(10g) (W/kg)	Reported SAR(10g) (W/kg)	Measured SAR(1g) (W/kg)	Reported SAR(1g) (W/kg)	Power Drift (dB)
Ch.	MHz										
Ambient Temperature: 22.2 °C      Liquid Temperature: 22 °C											
513900	2569.5	Left	Cheek	Fig.52	26.96	27	0.07	<b>0.07</b>	0.132	<b>0.13</b>	0.03
513900	2569.5	Left	Tilt	/	26.96	27	0.049	<b>0.05</b>	0.100	<b>0.10</b>	-0.06
513900	2569.5	Right	Cheek		26.96	27	0.054	<b>0.05</b>	0.110	<b>0.11</b>	0.04
513900	2569.5	Right	Tilt	/	26.96	27	0.027	<b>0.03</b>	0.052	<b>0.05</b>	0.07
513900	2569.5	Right	Cheek	CP-OFDM	25.56	26.2	0.051	<b>0.06</b>	0.104	<b>0.12</b>	0.02

**Table 14.6-7: SAR Values (NR5G n41-Body)**

Frequency		Test Position	Figure No./Note	Conducted Power (dBm)	Max. tune-up Power (dBm)	Measured SAR(10g) (W/kg)	Reported SAR(10g)(W/kg)	Measured SAR(1g) (W/kg)	Reported SAR(1g) (W/kg)	Power Drift (dB)
Ch.	MHz									
Ambient Temperature: 22.2 °C      Liquid Temperature: 22 °C										
509202	2546.01	Front	/	22.89	23	0.145	<b>0.15</b>	0.277	<b>0.28</b>	-0.07
528000	2640	Rear	/	22.5	23	0.332	<b>0.37</b>	0.667	<b>0.75</b>	0.08
523302	2616.51	Rear	/	22.42	23	0.281	<b>0.32</b>	0.603	<b>0.69</b>	0.14
518598	2592.99	Rear	/	22.45	23	0.289	<b>0.33</b>	0.631	<b>0.72</b>	0.06
513900	2569.5	Rear	/	22.46	23	0.293	<b>0.33</b>	0.639	<b>0.72</b>	0.09
509202	2546.01	Rear	Fig.53	22.89	23	0.384	<b>0.39</b>	0.748	<b>0.77</b>	0.13
509202	2546.01	Left	/	22.89	23	0.033	<b>0.03</b>	0.059	<b>0.06</b>	-0.02
509202	2546.01	Right	/	22.89	23	0.052	<b>0.05</b>	0.095	<b>0.10</b>	0.12
509202	2546.01	Bottom	/	22.89	23	0.354	<b>0.36</b>	0.705	<b>0.72</b>	-0.10
509202	2546.01	Rear	CP-OFDM	22.27	23	0.329	<b>0.39</b>	0.657	<b>0.78</b>	0.17

Note: The distance between the EUT and the phantom bottom is 10mm

**Table 14.6-8: SAR Values (NR5G n41 - Head) - Scaled Reported SAR**

Frequency		Side	Test Position	Actual duty factor	maximum duty factor	Reported SAR (1g) (W/kg)	Scaled reported SAR (1g) (W/kg)
MHz	Ch.						
513900	2569.5	Left	Cheek	90.48%	92.5%	<b>0.13</b>	<b>0.13</b>

**Table 14.9-9: SAR Values (NR5G n41- Body) – Scaled Reported SAR**

Frequency		Test Position	D (mm)	Actual duty factor	maximum duty factor	Reported SAR (1g) (W/kg)	Scaled reported SAR (1g) (W/kg)
MHz	Ch.						
509202	2546.01	Rear	10	90.48%	92.5%	<b>0.77</b>	<b>0.79</b>

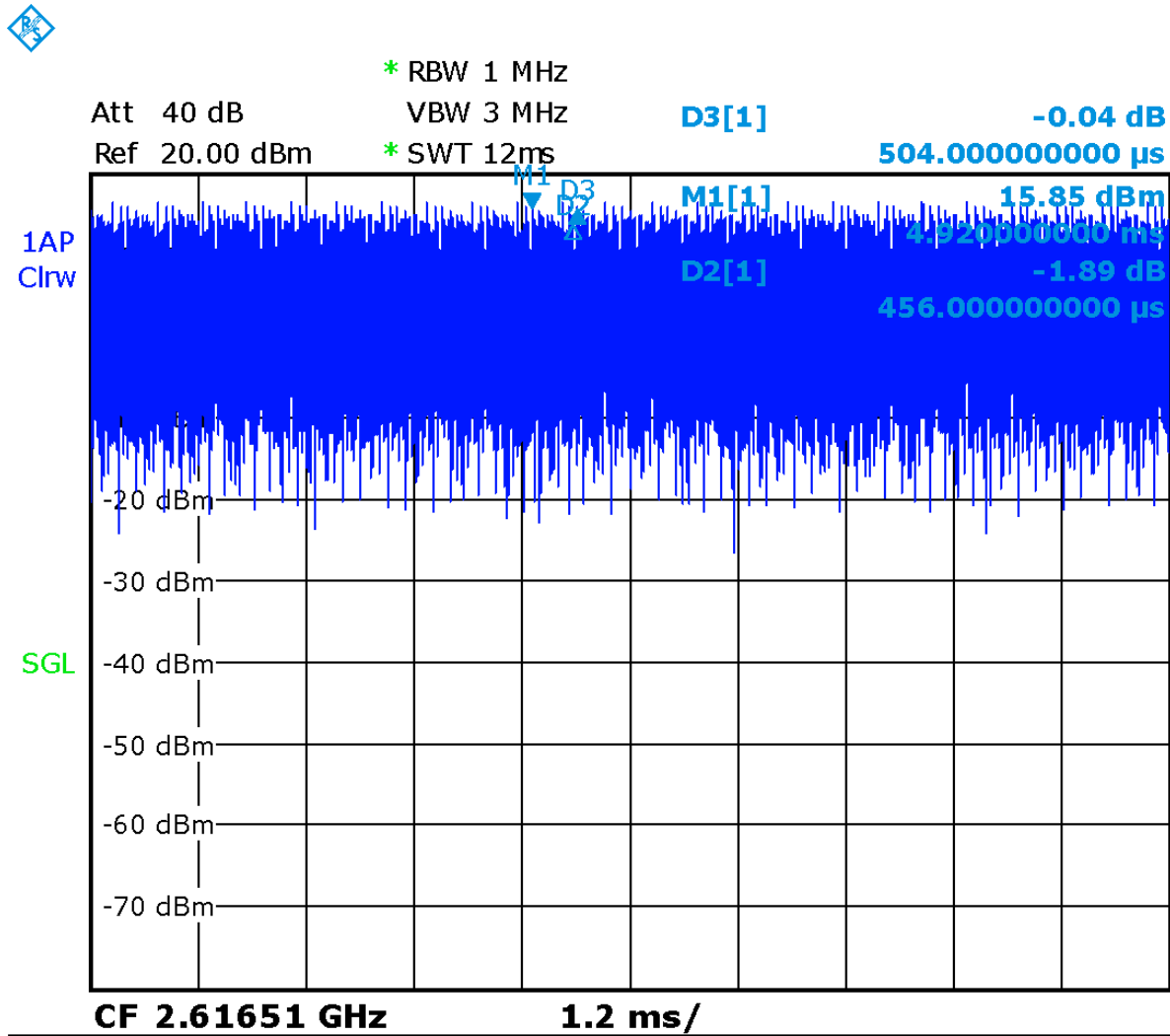

Picture 14.5 The plot of duty factor for n41

Table 14.6-10: SAR Values (NR5G n66-Head)

Frequency		Ambient Temperature: 22.2°C Liquid Temperature: 22°C									
Ch.	MHz	Side	Test Position	Figure No./Note	Conducted Power (dBm)	Max. tune-up Power (dBm)	Measured SAR(10g) (W/kg)	Reported SAR(10g) (W/kg)	Measured SAR(1g) (W/kg)	Reported SAR(1g) (W/kg)	Power Drift (dB)
344000	1720	Left	Cheek	/	20.4	20.7	0.149	<b>0.16</b>	0.243	<b>0.26</b>	0.12
344000	1720	Left	Tilt	/	20.4	20.7	0.119	<b>0.13</b>	0.212	<b>0.23</b>	-0.01
344000	1720	Right	Cheek	Fig.54	20.4	20.7	0.309	<b>0.33</b>	0.615	<b>0.66</b>	0.08
344000	1720	Right	Tilt	/	20.4	20.7	0.103	<b>0.11</b>	0.188	<b>0.20</b>	0.04
344000	1720	Right	Cheek	CP-OFDM	19.93	20.7	0.228	<b>0.27</b>	0.423	<b>0.51</b>	0.01

**Table 14.6-11: SAR Values (NR5G n66-Body)**

Frequency		Ambient Temperature: 22.2 °C					Liquid Temperature: 22 °C				
Ch.	MHz	Test Position	Figure No./ Note	Conducted Power (dBm)	Max. tune-up Power (dBm)	Measured SAR(10g) (W/kg)	Reported SAR(10g)(W/kg)	Measured SAR(1g) (W/kg)	Reported SAR(1g) (W/kg)	Power Drift (dB)	
344000	1720	Front	/	21.41	21.7	0.101	<b>0.11</b>	0.190	<b>0.20</b>	0.08	
344000	1720	Rear	/	21.41	21.7	0.234	<b>0.25</b>	0.429	<b>0.46</b>	0.07	
344000	1720	Left	Fig.55	21.41	21.7	0.264	<b>0.28</b>	0.509	<b>0.54</b>	-0.08	
344000	1720	Top	/	21.41	21.7	0.068	<b>0.07</b>	0.115	<b>0.12</b>	-0.03	
344000	1720	Left	CP-OFDM	20.67	20.7	0.227	<b>0.23</b>	0.447	<b>0.45</b>	0.09	

Note: The distance between the EUT and the phantom bottom is 10mm

**Table 14.6-12: SAR Values (NR5G n66-Body)**

Frequency		Ambient Temperature: 22.2 °C					Liquid Temperature: 22 °C				
Ch.	MHz	Test Position	Figure No./ Note	Conducted Power (dBm)	Max. tune-up Power (dBm)	Measured SAR(10g) (W/kg)	Reported SAR(10g)(W/kg)	Measured SAR(1g) (W/kg)	Reported SAR(1g) (W/kg)	Power Drift (dB)	
349000	1745	Front	/	23.27	24.5	0.091	<b>0.12</b>	0.154	<b>0.20</b>	0.12	
349000	1745	Rear	Fig.56	23.27	24.5	0.176	<b>0.23</b>	0.293	<b>0.39</b>	0.00	
349000	1745	Rear	CP-OFDM	22.48	22.7	0.136	<b>0.14</b>	0.284	<b>0.30</b>	0.08	

Note: The distance between the EUT and the phantom bottom is 15mm

**Table 14.6-13: SAR Values (NR5G n71-Head)**

Frequency		Ambient Temperature: 22.2 °C					Liquid Temperature: 22 °C				
Ch.	MHz	Side	Test Position	Figure No./Note	Conducted Power (dBm)	Max. tune-up Power (dBm)	Measured SAR(10g) (W/kg)	Reported SAR(10g) (W/kg)	Measured SAR(1g) (W/kg)	Reported SAR(1g) (W/kg)	Power Drift (dB)
134600	673	Left	Cheek	Fig.57	23.05	24.5	0.272	<b>0.38</b>	0.495	<b>0.69</b>	0.05
134600	673	Left	Tilt	/	23.05	24.5	0.062	<b>0.09</b>	0.089	<b>0.12</b>	-0.10
134600	673	Right	Cheek	/	23.05	24.5	0.113	<b>0.16</b>	0.205	<b>0.29</b>	-0.07
134600	673	Right	Tilt	/	23.05	24.5	0.047	<b>0.07</b>	0.07	<b>0.10</b>	0.04
134600	673	Right	Cheek	CP-OFDM	22.43	22.5	0.234	<b>0.24</b>	0.42	<b>0.43</b>	0.05

**Table 14.6-14: SAR Values (NR5G n71-Body)**

Frequency		Ambient Temperature: 22.2 °C				Liquid Temperature: 22 °C				
Ch.	MHz	Test Position	Figure No./ Note	Conducted Power (dBm)	Max. tune-up Power (dBm)	Measured SAR(10g) (W/kg)	Reported SAR(10g)(W/kg)	Measured SAR(1g) (W/kg)	Reported SAR(1g) (W/kg)	Power Drift (dB)
134600	673	Front	/	23.05	24.5	0.148	<b>0.21</b>	0.244	<b>0.34</b>	0.01
134600	673	Rear	/	23.05	24.5	0.185	<b>0.26</b>	0.311	<b>0.43</b>	0.04
134600	673	Left	Fig.58	23.05	24.5	0.253	<b>0.35</b>	0.455	<b>0.64</b>	0.04
134600	673	Left	CP-OFDM	22.43	22.5	0.225	<b>0.23</b>	0.411	<b>0.42</b>	0.06

Note: The distance between the EUT and the phantom bottom is 10mm

## 15 SAR Measurement Variability

SAR measurement variability must be assessed for each frequency band, which is determined by the SAR probe calibration point and tissue-equivalent medium used for the device measurements. When both head and body tissue-equivalent media are required for SAR measurements in a frequency band, the variability measurement procedures should be applied to the tissue medium with the highest measured SAR, using the highest measured SAR configuration for that tissue-equivalent medium.

The following procedures are applied to determine if repeated measurements are required.

- 1) Repeated measurement is not required when the original highest measured SAR is  $< 0.80$  W/kg; steps 2) through 4) do not apply.
- 2) When the original highest measured SAR is  $\geq 0.80$  W/kg, repeat that measurement once.
- 3) Perform a second repeated measurement only if the ratio of largest to smallest SAR for the original and first repeated measurements is  $> 1.20$  or when the original or repeated measurement is  $\geq 1.45$  W/kg ( $\sim 10\%$  from the 1-g SAR limit).
- 4) Perform a third repeated measurement only if the original, first or second repeated measurement is  $\geq 1.5$  W/kg and the ratio of largest to smallest SAR for the original, first and second repeated measurements is  $> 1.20$ .

**Table 15.1: SAR Measurement Variability for Head GSM1900 (1g)**

Frequency		Side	Test Position	Original SAR (W/kg)	First Repeated SAR (W/kg)	The Ratio	Second Repeated SAR (W/kg)
Ch.	MHz						
661	1880	Right	Cheek	1.22	1.17	1.04	/

**Table 15.2: SAR Measurement Variability for Body GSM1900 (1g)**

Frequency		Test Position	Spacing (mm)	Original SAR (W/kg)	First Repeated SAR (W/kg)	The Ratio	Second Repeated SAR (W/kg)
Ch.	MHz						
661	1880	Left	10	0.862	0.841	1.02	/

**Table 15.3: SAR Measurement Variability for Body W850 (1g)**

Frequency		Test Position	Spacing (mm)	Original SAR (W/kg)	First Repeated SAR (W/kg)	The Ratio	Second Repeated SAR (W/kg)
Ch.	MHz						
4182	836.4	Left	10	0.894	0.857	1.04	/

**Table 15.4: SAR Measurement Variability for Head W1700 (1g)**

Frequency		Side	Test Position	Original SAR (W/kg)	First Repeated SAR (W/kg)	The Ratio	Second Repeated SAR (W/kg)
Ch.	MHz						
1513	1752.6	Right	Cheek	0.902	0.879	1.03	/



**Table 15.5: SAR Measurement Variability for Body W1700 (1g)**

Frequency		Test Position	Spacing (mm)	Original SAR (W/kg)	First Repeated SAR (W/kg)	The Ratio	Second Repeated SAR (W/kg)
Ch.	MHz						
1312	1712.4	Left	15	0.806	0.769	1.05	/

**Table 15.6: SAR Measurement Variability for Head W1900 (1g)**

Frequency		Side	Test Position	Original SAR (W/kg)	First Repeated SAR (W/kg)	The Ratio	Second Repeated SAR (W/kg)
Ch.	MHz						
9262	1852.4	Right	Cheek	0.919	0.883	1.04	/

**Table 15.7: SAR Measurement Variability for Body W1900 (1g)**

Frequency		Test Position	Spacing (mm)	Original SAR (W/kg)	First Repeated SAR (W/kg)	The Ratio	Second Repeated SAR (W/kg)
Ch.	MHz						
9538	1907.6	Left	10	0.999	0.962	1.04	/

**Table 15.8: SAR Measurement Variability for Head CDMA BC1 (1g)**

Frequency		Side	Test Position	Original SAR (W/kg)	First Repeated SAR (W/kg)	The Ratio	Second Repeated SAR (W/kg)
Ch.	MHz						
600	1880	Left	Cheek	0.846	0.811	1.04	/

**Table 15.9: SAR Measurement Variability for Body CDMA BC1 (1g)**

Frequency		Test Position	Spacing (mm)	Original SAR (W/kg)	First Repeated SAR (W/kg)	The Ratio	Second Repeated SAR (W/kg)
Ch.	MHz						
25	1851.25	Left	10	0.881	0.842	1.05	/

**Table 15.10: SAR Measurement Variability for Body LTE B7 (1g)**

Frequency		Mode	Test Position	Spacing (mm)	Original SAR (W/kg)	First Repeated SAR (W/kg)	The Ratio	Second Repeated SAR (W/kg)
Ch.	MHz							
21350	2560	1RB_High	Rear	10	0.966	0.932	1.04	/

**Table 15.11: SAR Measurement Variability for Head LTE B25 (1g)**

Frequency		Mode	Side	Test Position	Original SAR (W/kg)	First Repeated SAR (W/kg)	The Ratio	Second Repeated SAR (W/kg)
Ch.	MHz							
26140	1860	1RB_High	Right	Cheek	0.849	0.811	1.05	/

**Table 15.12: SAR Measurement Variability for Body LTE B25 (1g)**

Frequency		Mode	Test Position	Spacing (mm)	Original SAR (W/kg)	First Repeated SAR (W/kg)	The Ratio	Second Repeated SAR (W/kg)
Ch.	MHz							
26140	1860	1RB_Low	Rear	10	1.02	0.964	1.06	/

**Table 15.13: SAR Measurement Variability for Body LTE B26 (1g)**

Frequency		Mode	Test Position	Spacing (mm)	Original SAR (W/kg)	First Repeated SAR (W/kg)	The Ratio	Second Repeated SAR (W/kg)
Ch.	MHz							
26865	831.5	1RB_Mid	Left	10	0.941	0.907	1.04	/

**Table 15.14: SAR Measurement Variability for Head LTE B66 (1g)**

Frequency		Mode	Side	Test Position	Original SAR (W/kg)	First Repeated SAR (W/kg)	The Ratio	Second Repeated SAR (W/kg)
Ch.	MHz							
132572	1770	1RB_Low	Right	Cheek	0.896	0.847	1.06	/

**Table 15.15: SAR Measurement Variability for Body LTE B71 (1g)**

Frequency		Mode	Test Position	Spacing (mm)	Original SAR (W/kg)	First Repeated SAR (W/kg)	The Ratio	Second Repeated SAR (W/kg)
Ch.	MHz							
133222	673	1RB_Low	Left	10	0.851	0.814	1.05	/

## 16 Measurement Uncertainty

### 16.1 Measurement Uncertainty for Normal SAR Tests (300MHz~3GHz)

No.	Error Description	Type	Uncertainty value	Probably Distribution	Div.	(Ci) 1g	(Ci) 10g	Std. Unc. (1g)	Std. Unc. (10g)	Degree of freedom
<b>Measurement system</b>										
1	Probe calibration	B	6.0	N	1	1	1	6.0	6.0	$\infty$
2	Isotropy	B	4.7	R	$\sqrt{3}$	0.7	0.7	1.9	1.9	$\infty$
3	Boundary effect	B	1.0	R	$\sqrt{3}$	1	1	0.6	0.6	$\infty$
4	Linearity	B	4.7	R	$\sqrt{3}$	1	1	2.7	2.7	$\infty$
5	Detection limit	B	1.0	N	1	1	1	0.6	0.6	$\infty$
6	Readout electronics	B	0.3	R	$\sqrt{3}$	1	1	0.3	0.3	$\infty$
7	Response time	B	0.8	R	$\sqrt{3}$	1	1	0.5	0.5	$\infty$
8	Integration time	B	2.6	R	$\sqrt{3}$	1	1	1.5	1.5	$\infty$
9	RF ambient conditions-noise	B	0	R	$\sqrt{3}$	1	1	0	0	$\infty$
10	RFambient conditions-reflection	B	0	R	$\sqrt{3}$	1	1	0	0	$\infty$
11	Probe positioned mech. restrictions	B	0.4	R	$\sqrt{3}$	1	1	0.2	0.2	$\infty$
12	Probe positioning with respect to phantom shell	B	2.9	R	$\sqrt{3}$	1	1	1.7	1.7	$\infty$
13	Post-processing	B	1.0	R	$\sqrt{3}$	1	1	0.6	0.6	$\infty$
<b>Test sample related</b>										
14	Test sample positioning	A	3.3	N	1	1	1	3.3	3.3	71
15	Device holder uncertainty	A	3.4	N	1	1	1	3.4	3.4	5
16	Drift of output power	B	5.0	R	$\sqrt{3}$	1	1	2.9	2.9	$\infty$
<b>Phantom and set-up</b>										
17	Phantom uncertainty	B	4.0	R	$\sqrt{3}$	1	1	2.3	2.3	$\infty$
18	Liquid conductivity (target)	B	5.0	R	$\sqrt{3}$	0.64	0.43	1.8	1.2	$\infty$
19	Liquid conductivity (meas.)	A	2.06	N	1	0.64	0.43	1.32	0.89	43
20	Liquid permittivity (target)	B	5.0	R	$\sqrt{3}$	0.6	0.49	1.7	1.4	$\infty$
21	Liquid permittivity (meas.)	A	1.6	N	1	0.6	0.49	1.0	0.8	521

Combined standard uncertainty	$u_c = \sqrt{\sum_{i=1}^{21} c_i^2 u_i^2}$						9.55	9.43	257
Expanded uncertainty (confidence interval of 95 %)	$u_e = 2u_c$						19.1	18.9	

### 16.2 Measurement Uncertainty for Normal SAR Tests (3~6GHz)

No.	Error Description	Type	Uncertainty value	Probably Distribution	Div.	(Ci) 1g	(Ci) 10g	Std. Unc. (1g)	Std. Unc. (10g)	Degree of freedom
<b>Measurement system</b>										
1	Probe calibration	B	6.55	N	1	1	1	6.55	6.55	$\infty$
2	Isotropy	B	4.7	R	$\sqrt{3}$	0.7	0.7	1.9	1.9	$\infty$
3	Boundary effect	B	2.0	R	$\sqrt{3}$	1	1	1.2	1.2	$\infty$
4	Linearity	B	4.7	R	$\sqrt{3}$	1	1	2.7	2.7	$\infty$
5	Detection limit	B	1.0	R	$\sqrt{3}$	1	1	0.6	0.6	$\infty$
6	Readout electronics	B	0.3	R	$\sqrt{3}$	1	1	0.3	0.3	$\infty$
7	Response time	B	0.8	R	$\sqrt{3}$	1	1	0.5	0.5	$\infty$
8	Integration time	B	2.6	R	$\sqrt{3}$	1	1	1.5	1.5	$\infty$
9	RF ambient conditions-noise	B	0	R	$\sqrt{3}$	1	1	0	0	$\infty$
10	RF ambient conditions-reflection	B	0	R	$\sqrt{3}$	1	1	0	0	$\infty$
11	Probe positioned mech. restrictions	B	0.8	R	$\sqrt{3}$	1	1	0.5	0.5	$\infty$
12	Probe positioning with respect to phantom shell	B	6.7	R	$\sqrt{3}$	1	1	3.9	3.9	$\infty$
13	Post-processing	B	4.0	R	$\sqrt{3}$	1	1	2.3	2.3	$\infty$
<b>Test sample related</b>										
14	Test sample positioning	A	3.3	N	1	1	1	3.3	3.3	71
15	Device holder uncertainty	A	3.4	N	1	1	1	3.4	3.4	5
16	Drift of output power	B	5.0	R	$\sqrt{3}$	1	1	2.9	2.9	$\infty$
<b>Phantom and set-up</b>										
17	Phantom uncertainty	B	4.0	R	$\sqrt{3}$	1	1	2.3	2.3	$\infty$
18	Liquid conductivity (target)	B	5.0	R	$\sqrt{3}$	0.64	0.43	1.8	1.2	$\infty$
19	Liquid conductivity (meas.)	A	2.06	N	1	0.64	0.43	1.32	0.89	43
20	Liquid permittivity (target)	B	5.0	R	$\sqrt{3}$	0.6	0.49	1.7	1.4	$\infty$

21	Liquid permittivity (meas.)	A	1.6	N	1	0.6	0.49	1.0	0.8	521
Combined standard uncertainty		$u_c = \sqrt{\sum_{i=1}^{21} c_i^2 u_i^2}$						10.7	10.6	257
Expanded uncertainty (confidence interval of 95 %)		$u_e = 2u_c$						21.4	21.1	

### 16.3 Measurement Uncertainty for Fast SAR Tests (300MHz~3GHz)

No.	Error Description	Type	Uncertainty value	Probably Distribution	Div.	(Ci) 1g	(Ci) 10g	Std. Unc. (1g)	Std. Unc. (10g)	Degree of freedom
<b>Measurement system</b>										
1	Probe calibration	B	6.0	N	1	1	1	6.0	6.0	$\infty$
2	Isotropy	B	4.7	R	$\sqrt{3}$	0.7	0.7	1.9	1.9	$\infty$
3	Boundary effect	B	1.0	R	$\sqrt{3}$	1	1	0.6	0.6	$\infty$
4	Linearity	B	4.7	R	$\sqrt{3}$	1	1	2.7	2.7	$\infty$
5	Detection limit	B	1.0	R	$\sqrt{3}$	1	1	0.6	0.6	$\infty$
6	Readout electronics	B	0.3	R	$\sqrt{3}$	1	1	0.3	0.3	$\infty$
7	Response time	B	0.8	R	$\sqrt{3}$	1	1	0.5	0.5	$\infty$
8	Integration time	B	2.6	R	$\sqrt{3}$	1	1	1.5	1.5	$\infty$
9	RF ambient conditions-noise	B	0	R	$\sqrt{3}$	1	1	0	0	$\infty$
10	RFambient conditions-reflection	B	0	R	$\sqrt{3}$	1	1	0	0	$\infty$
11	Probe positioned mech. Restrictions	B	0.4	R	$\sqrt{3}$	1	1	0.2	0.2	$\infty$
12	Probe positioning with respect to phantom shell	B	2.9	R	$\sqrt{3}$	1	1	1.7	1.7	$\infty$
13	Post-processing	B	1.0	R	$\sqrt{3}$	1	1	0.6	0.6	$\infty$
14	Fast SAR z-Approximation	B	7.0	R	$\sqrt{3}$	1	1	4.0	4.0	$\infty$
<b>Test sample related</b>										
15	Test sample positioning	A	3.3	N	1	1	1	3.3	3.3	71
16	Device holder uncertainty	A	3.4	N	1	1	1	3.4	3.4	5
17	Drift of output power	B	5.0	R	$\sqrt{3}$	1	1	2.9	2.9	$\infty$
<b>Phantom and set-up</b>										
18	Phantom uncertainty	B	4.0	R	$\sqrt{3}$	1	1	2.3	2.3	$\infty$
19	Liquid conductivity (target)	B	5.0	R	$\sqrt{3}$	0.64	0.43	1.8	1.2	$\infty$

20	Liquid conductivity (meas.)	A	2.06	N	1	0.64	0.43	1.32	0.89	43
21	Liquid permittivity (target)	B	5.0	R	$\sqrt{3}$	0.6	0.49	1.7	1.4	$\infty$
22	Liquid permittivity (meas.)	A	1.6	N	1	0.6	0.49	1.0	0.8	521
Combined standard uncertainty		$u_c' = \sqrt{\sum_{i=1}^{22} c_i^2 u_i^2}$						10.4	10.3	257
Expanded uncertainty (confidence interval of 95 %)		$u_e = 2u_c$						20.8	20.6	

#### 16.4 Measurement Uncertainty for Fast SAR Tests (3~6GHz)

No.	Error Description	Type	Uncertainty value	Probably Distribution	Div.	(Ci) 1g	(Ci) 10g	Std. Unc. (1g)	Std. Unc. (10g)	Degree of freedom
<b>Measurement system</b>										
1	Probe calibration	B	6.55	N	1	1	1	6.55	6.55	$\infty$
2	Isotropy	B	4.7	R	$\sqrt{3}$	0.7	0.7	1.9	1.9	$\infty$
3	Boundary effect	B	2.0	R	$\sqrt{3}$	1	1	1.2	1.2	$\infty$
4	Linearity	B	4.7	R	$\sqrt{3}$	1	1	2.7	2.7	$\infty$
5	Detection limit	B	1.0	R	$\sqrt{3}$	1	1	0.6	0.6	$\infty$
6	Readout electronics	B	0.3	R	$\sqrt{3}$	1	1	0.3	0.3	$\infty$
7	Response time	B	0.8	R	$\sqrt{3}$	1	1	0.5	0.5	$\infty$
8	Integration time	B	2.6	R	$\sqrt{3}$	1	1	1.5	1.5	$\infty$
9	RF ambient conditions-noise	B	0	R	$\sqrt{3}$	1	1	0	0	$\infty$
10	RFambient conditions-reflection	B	0	R	$\sqrt{3}$	1	1	0	0	$\infty$
11	Probe positioned mech. Restrictions	B	0.8	R	$\sqrt{3}$	1	1	0.5	0.5	$\infty$
12	Probe positioning with respect to phantom shell	B	6.7	R	$\sqrt{3}$	1	1	3.9	3.9	$\infty$
13	Post-processing	B	1.0	R	$\sqrt{3}$	1	1	0.6	0.6	$\infty$
14	Fast SAR z-Approximation	B	14.0	R	$\sqrt{3}$	1	1	8.1	8.1	$\infty$
<b>Test sample related</b>										
15	Test sample positioning	A	3.3	N	1	1	1	3.3	3.3	71
16	Device holder uncertainty	A	3.4	N	1	1	1	3.4	3.4	5

17	Drift of output power	B	5.0	R	$\sqrt{3}$	1	1	2.9	2.9	$\infty$
<b>Phantom and set-up</b>										
18	Phantom uncertainty	B	4.0	R	$\sqrt{3}$	1	1	2.3	2.3	$\infty$
19	Liquid conductivity (target)	B	5.0	R	$\sqrt{3}$	0.64	0.43	1.8	1.2	$\infty$
20	Liquid conductivity (meas.)	A	2.06	N	1	0.64	0.43	1.32	0.89	43
21	Liquid permittivity (target)	B	5.0	R	$\sqrt{3}$	0.6	0.49	1.7	1.4	$\infty$
22	Liquid permittivity (meas.)	A	1.6	N	1	0.6	0.49	1.0	0.8	521
Combined standard uncertainty		$u_c = \sqrt{\sum_{i=1}^{22} c_i^2 u_i^2}$						13.5	13.4	257
Expanded uncertainty (confidence interval of 95 %)		$u_e = 2u_c$						27.0	26.8	

## 17 MAIN TEST INSTRUMENTS

**Table 17.1: List of Main Instruments**

No.	Name	Type	Serial Number	Calibration Date	Valid Period
01	Network analyzer	E5071C	MY46110673	February 10, 2020	One year
02	Power meter	NRP2	106277	September 4, 2019	One year
03	Power sensor	NRP8S	104291		
04	Signal Generator	E4438C	MY49071430	February 25, 2020	One Year
05	Amplifier	60S1G4	0331848	No Calibration Requested	
07	BTS	CMW500	166370	June 27, 2019	One year
08	E-field Probe	SPEAG EX3DV4	3617	January 30, 2020	One year
09	DAE	SPEAG DAE4	777	January 8, 2020	One year
10	Dipole Validation Kit	SPEAG D750V3	1017	July 18,2019	One year
11	Dipole Validation Kit	SPEAG D835V2	4d069	July 18,2019	One year
12	Dipole Validation Kit	SPEAG D1750V2	1003	July 16,2019	One year
13	Dipole Validation Kit	SPEAG D1900V2	5d101	July 17,2019	One year
15	Dipole Validation Kit	SPEAG D2450V2	853	July 17,2019	One year
16	Dipole Validation Kit	SPEAG D2600V2	1012	July 17,2019	One year
17	Dipole Validation Kit	SPEAG D5GHzV2	1060	July 22, 2019	One year

\*\*\*END OF REPORT BODY\*\*\*

## ANNEX A Graph Results

### GSM850\_CH190 Left Cheek

Date: 6/6/2020

Electronics: DAE4 Sn777

Medium: head 835 MHz

Medium parameters used:  $f = 836.6$ ;  $\sigma = 0.903$  mho/m;  $\epsilon_r = 41.6$ ;  $\rho = 1000$  kg/m<sup>3</sup>

Ambient Temperature: 22.5°C, Liquid Temperature: 22.3°C

Communication System: GSM850 836.6 Duty Cycle: 1: 4

Probe: EX3DV4 – SN3617 ConvF(9.66,9.66,9.66)

**Area Scan (71x121x1):** Interpolated grid: dx=1.000 mm, dy=1.000 mm

Maximum value of SAR (interpolated) = 0.336 W/kg

**Zoom Scan (7x7x7)/Cube 0:** Measurement grid: dx=5mm, dy=5mm, dz=5mm

Reference Value = 5.262 V/m; Power Drift = -0.03 dB

Peak SAR (extrapolated) = 0.402 W/kg

**SAR(1 g) = 0.217 W/kg; SAR(10 g) = 0.121 W/kg**

Maximum value of SAR (measured) = 0.231 W/kg

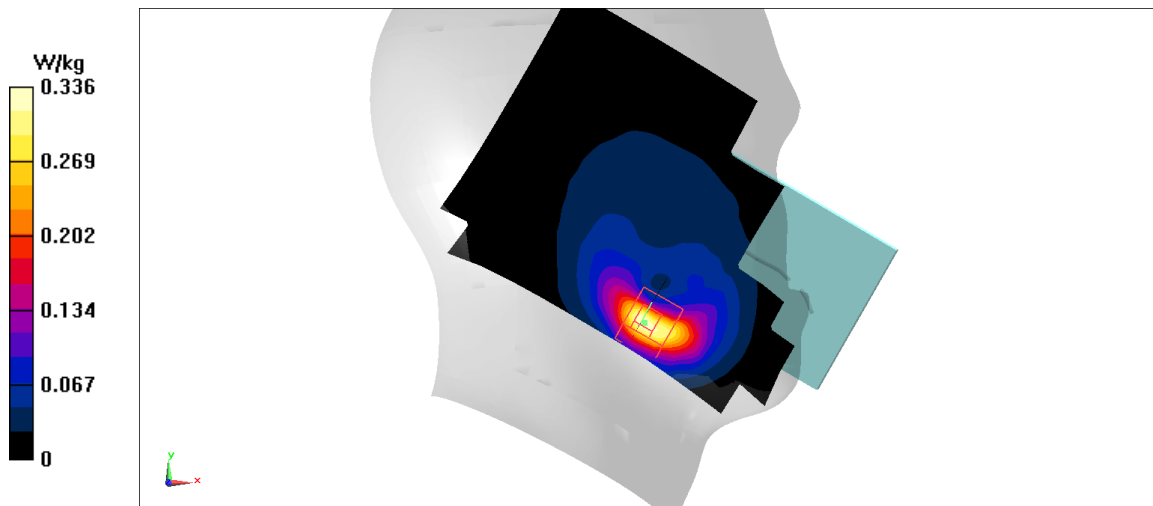

Fig A.1



**GSM850\_CH190 Left**

Date: 6/6/2020

Electronics: DAE4 Sn777

Medium: head 835 MHz

Medium parameters used:  $f = 836.6$ ;  $\sigma = 0.903$  mho/m;  $\epsilon_r = 41.6$ ;  $\rho = 1000$  kg/m<sup>3</sup>

Ambient Temperature: 22.5°C, Liquid Temperature: 22.3°C

Communication System: GSM850 836.6 Duty Cycle: 1: 4

Probe: EX3DV4 – SN3617 ConvF(9.66,9.66,9.66)

**Area Scan (71x121x1):** Interpolated grid: dx=1.000 mm, dy=1.000 mm

Maximum value of SAR (interpolated) = 0.62 W/kg

**Zoom Scan (7x7x7)/Cube 0:** Measurement grid: dx=5mm, dy=5mm, dz=5mm

Reference Value = 23.73 V/m; Power Drift = 0.07 dB

Peak SAR (extrapolated) = 0.774 W/kg

**SAR(1 g) = 0.411 W/kg; SAR(10 g) = 0.234 W/kg**

Maximum value of SAR (measured) = 0.627 W/kg

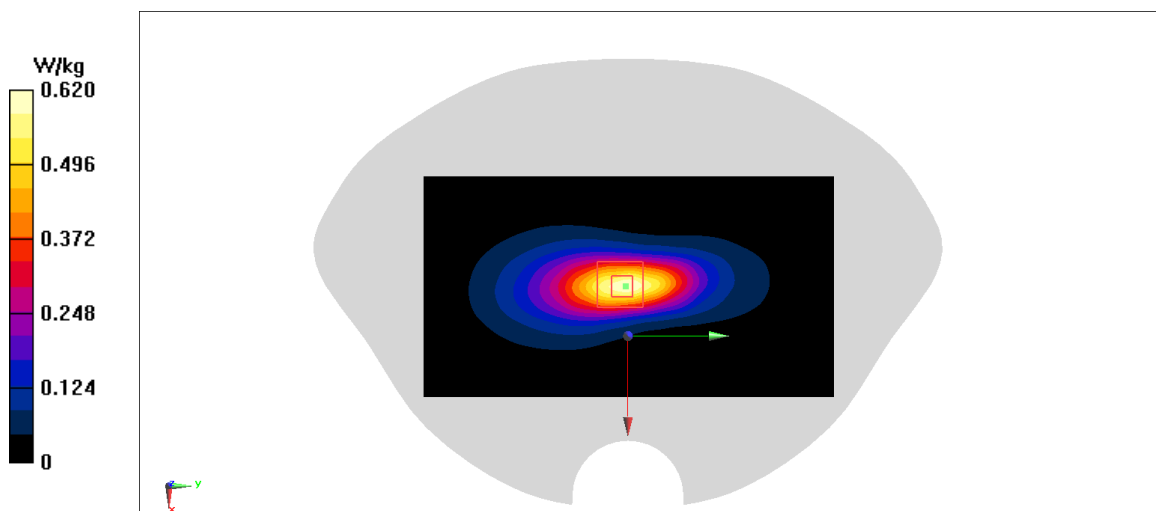
**Fig A.2**

**PCS1900\_CH661 Right Cheek**

Date: 6/10/2020

Electronics: DAE4 Sn777

Medium: head 1900 MHz

Medium parameters used:  $f = 1880$ ;  $\sigma = 1.371$  mho/m;  $\epsilon_r = 39.57$ ;  $\rho = 1000$  kg/m<sup>3</sup>

Ambient Temperature: 22.5°C, Liquid Temperature: 22.3°C

Communication System: PCS1900 1880 Duty Cycle: 1: 4

Probe: EX3DV4 – SN3617 ConvF(8.14,8.14,8.14)

**Area Scan (71x121x1):** Interpolated grid: dx=1.000 mm, dy=1.000 mm

Maximum value of SAR (interpolated) = 1.98 W/kg

**Zoom Scan (7x7x7)/Cube 0:** Measurement grid: dx=5mm, dy=5mm, dz=5mm

Reference Value = 13.92 V/m; Power Drift = -0.08 dB

Peak SAR (extrapolated) = 2.55 W/kg

**SAR(1 g) = 1.22 W/kg; SAR(10 g) = 0.58 W/kg**

Maximum value of SAR (measured) = 1.33 W/kg

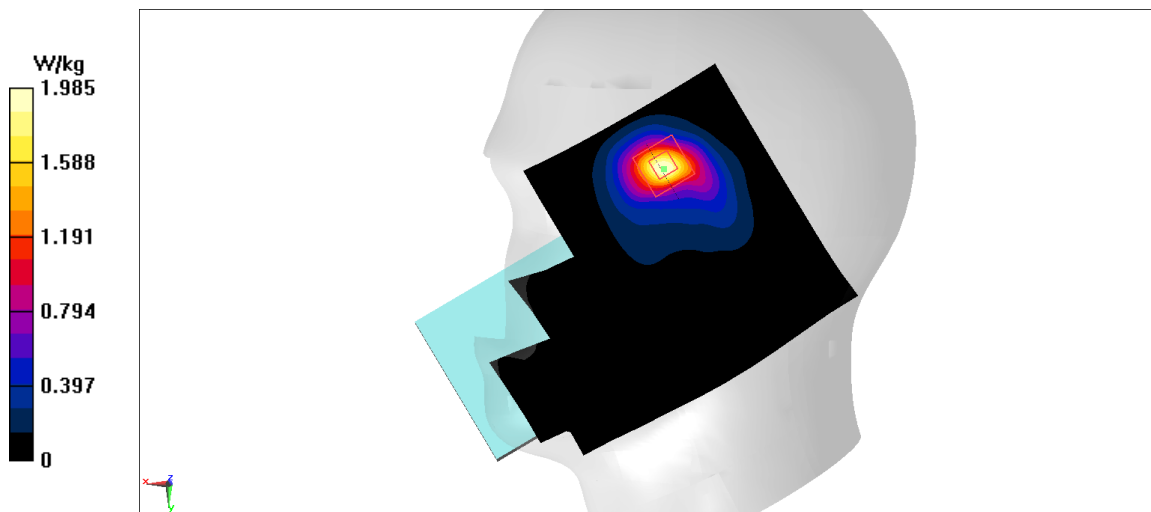
**Fig A.3**

**PCS1900\_CH661 Left**

Date: 6/10/2020

Electronics: DAE4 Sn777

Medium: head 1900 MHz

Medium parameters used:  $f = 1880$ ;  $\sigma = 1.371$  mho/m;  $\epsilon_r = 39.57$ ;  $\rho = 1000$  kg/m<sup>3</sup>

Ambient Temperature: 22.5°C, Liquid Temperature: 22.3°C

Communication System: PCS1900 1880 Duty Cycle: 1: 4

Probe: EX3DV4 – SN3617 ConvF(8.14,8.14,8.14)

**Area Scan (71x121x1):** Interpolated grid: dx=1.000 mm, dy=1.000 mm

Maximum value of SAR (interpolated) = 1.34 W/kg

**Zoom Scan (7x7x7)/Cube 0:** Measurement grid: dx=5mm, dy=5mm, dz=5mm

Reference Value = 10.1 V/m; Power Drift = -0.11 dB

Peak SAR (extrapolated) = 1.64 W/kg

**SAR(1 g) = 0.862 W/kg; SAR(10 g) = 0.438 W/kg**

Maximum value of SAR (measured) = 1.35 W/kg

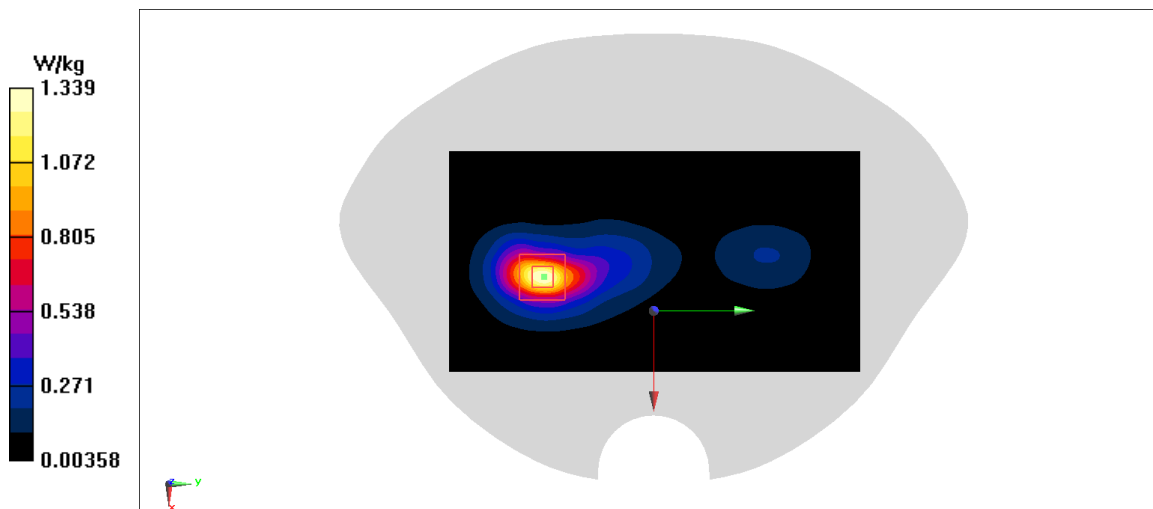

**Fig A.4**

**WCDMA1900-BII\_CH9262 Right Cheek**

Date: 6/10/2020

Electronics: DAE4 Sn777

Medium: head 1900 MHz

Medium parameters used:  $f = 1852.4$ ;  $\sigma = 1.344$  mho/m;  $\epsilon_r = 39.61$ ;  $\rho = 1000$  kg/m<sup>3</sup>

Ambient Temperature: 22.5°C, Liquid Temperature: 22.3°C

Communication System: WCDMA1900-BII 1852.4 Duty Cycle: 1: 1

Probe: EX3DV4 – SN3617 ConvF(8.14,8.14,8.14)

**Area Scan (71x121x1):** Interpolated grid: dx=1.000 mm, dy=1.000 mm

Maximum value of SAR (interpolated) = 0.933 W/kg

**Zoom Scan (7x7x7)/Cube 0:** Measurement grid: dx=5mm, dy=5mm, dz=5mm

Reference Value = 9.844 V/m; Power Drift = -0.04 dB

Peak SAR (extrapolated) = 1.84 W/kg

**SAR(1 g) = 0.919 W/kg; SAR(10 g) = 0.484 W/kg**

Maximum value of SAR (measured) = 1.03 W/kg

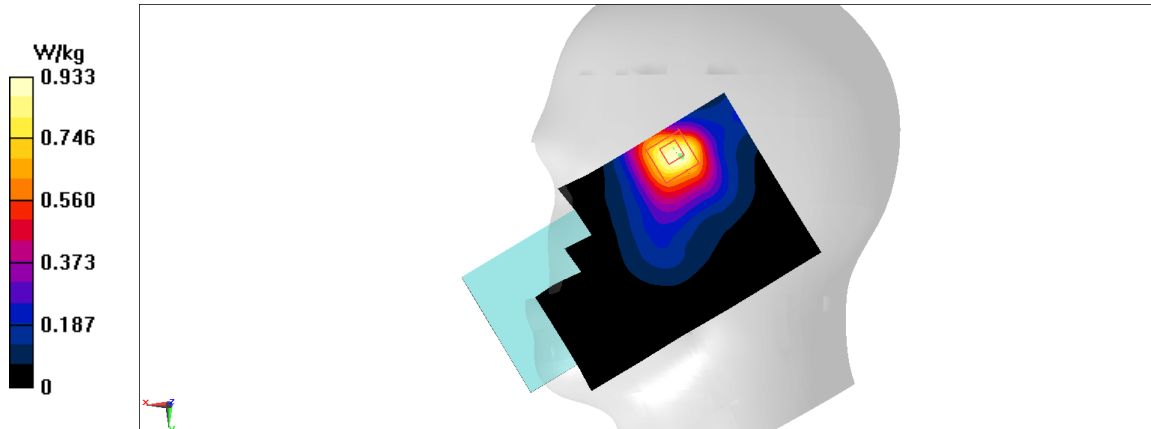

Fig A.5

**WCDMA1900-BII\_CH9538 Left**

Date: 6/10/2020

Electronics: DAE4 Sn777

Medium: head 1900 MHz

Medium parameters used:  $f = 1907.6$ ;  $\sigma = 1.398$  mho/m;  $\epsilon_r = 39.54$ ;  $\rho = 1000$  kg/m<sup>3</sup>

Ambient Temperature: 22.5°C, Liquid Temperature: 22.3°C

Communication System: WCDMA1900-BII 1907.6 Duty Cycle: 1: 1

Probe: EX3DV4 – SN3617 ConvF(8.14,8.14,8.14)

**Area Scan (71x121x1):** Interpolated grid: dx=1.000 mm, dy=1.000 mm

Maximum value of SAR (interpolated) = 1.62 W/kg

**Zoom Scan (7x7x7)/Cube 0:** Measurement grid: dx=5mm, dy=5mm, dz=5mm

Reference Value = 8.911 V/m; Power Drift = -0.13 dB

Peak SAR (extrapolated) = 1.84 W/kg

**SAR(1 g) = 0.999 W/kg; SAR(10 g) = 0.509 W/kg**

Maximum value of SAR (measured) = 1.11 W/kg

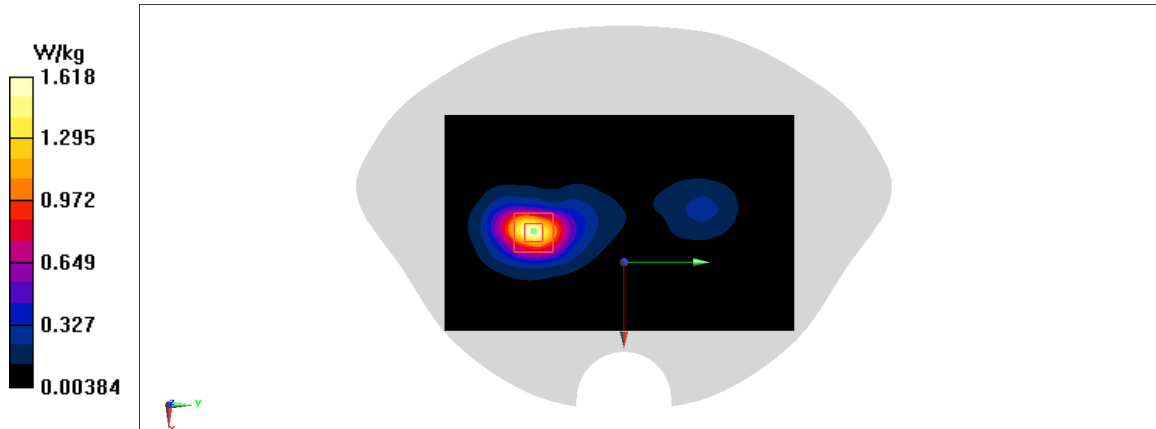
**Fig A.6**

**WCDMA1900-BII\_CH9400 Rear**

Date: 6/10/2020

Electronics: DAE4 Sn777

Medium: head 1900 MHz

Medium parameters used:  $f = 1880$ ;  $\sigma = 1.371$  mho/m;  $\epsilon_r = 39.57$ ;  $\rho = 1000$  kg/m<sup>3</sup>

Ambient Temperature: 22.5°C, Liquid Temperature: 22.3°C

Communication System: WCDMA1900-BII 1880 Duty Cycle: 1: 1

Probe: EX3DV4 – SN3617 ConvF(8.14,8.14,8.14)

**Area Scan (71x121x1):** Interpolated grid: dx=1.000 mm, dy=1.000 mm

Maximum value of SAR (interpolated) = 1.22 W/kg

**Zoom Scan (7x7x7)/Cube 0:** Measurement grid: dx=5mm, dy=5mm, dz=5mm

Reference Value = 14.71 V/m; Power Drift = -0.04 dB

Peak SAR (extrapolated) = 1.49 W/kg

**SAR(1 g) = 0.375 W/kg; SAR(10 g) = 0.21 W/kg**

Maximum value of SAR (measured) = 1.22 W/kg

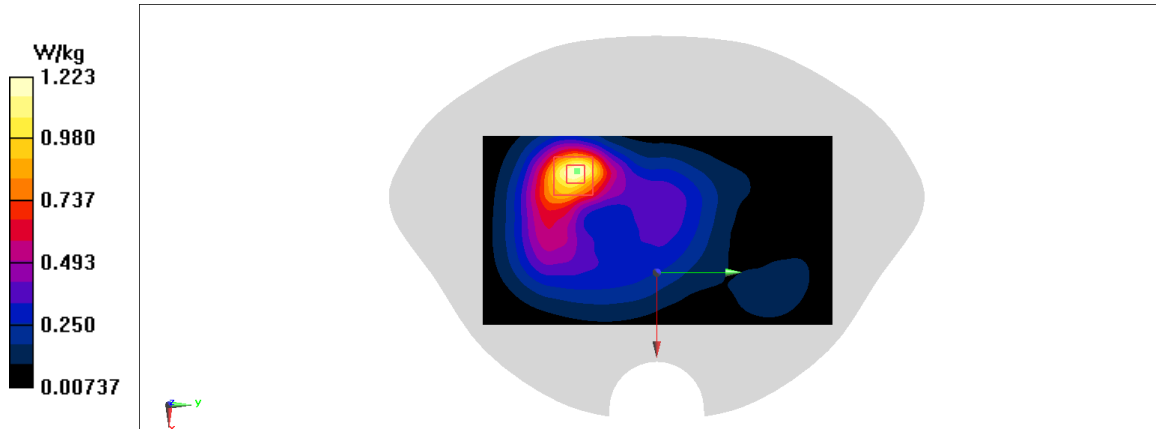
**Fig A.7**

**WCDMA1700-BIV\_CH1513 Right Cheek**

Date: 6/8/2020

Electronics: DAE4 Sn777

Medium: head 1750 MHz

Medium parameters used:  $f = 1752.6$ ;  $\sigma = 1.383$  mho/m;  $\epsilon_r = 40.68$ ;  $\rho = 1000$  kg/m<sup>3</sup>

Ambient Temperature: 22.5°C, Liquid Temperature: 22.3°C

Communication System: WCDMA1700-BIV 1752.6 Duty Cycle: 1: 1

Probe: EX3DV4 – SN3617 ConvF(8.41,8.41,8.41)

**Area Scan (71x121x1):** Interpolated grid: dx=1.000 mm, dy=1.000 mm

Maximum value of SAR (interpolated) = 0.951 W/kg

**Zoom Scan (7x7x7)/Cube 0:** Measurement grid: dx=5mm, dy=5mm, dz=5mm

Reference Value = 10.04 V/m; Power Drift = -0.04 dB

Peak SAR (extrapolated) = 1.71 W/kg

**SAR(1 g) = 0.902 W/kg; SAR(10 g) = 0.489 W/kg**

Maximum value of SAR (measured) = 0.942 W/kg

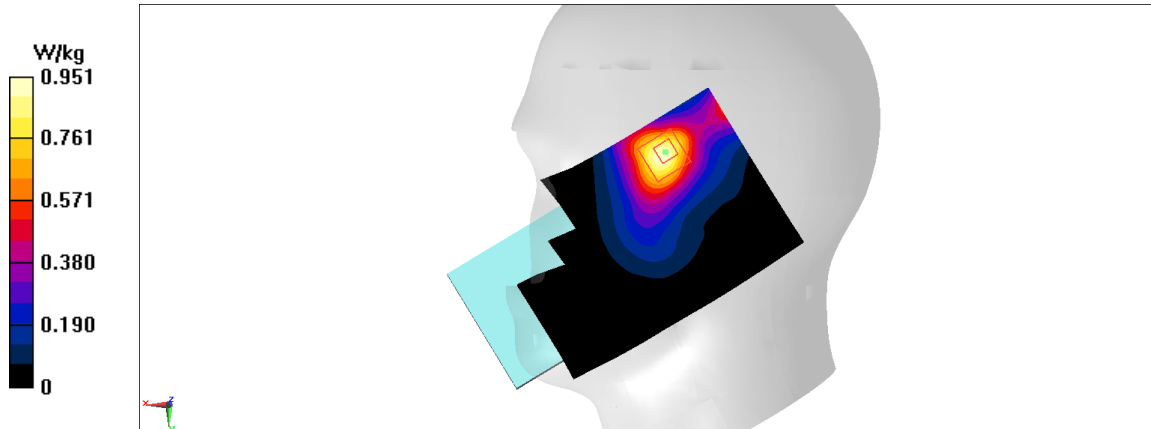
**Fig A.8**

**WCDMA1700-BIV\_CH1513 Left**

Date: 6/8/2020

Electronics: DAE4 Sn777

Medium: head 1750 MHz

Medium parameters used:  $f = 1752.6$ ;  $\sigma = 1.383$  mho/m;  $\epsilon_r = 40.68$ ;  $\rho = 1000$  kg/m<sup>3</sup>

Ambient Temperature: 22.5°C, Liquid Temperature: 22.3°C

Communication System: WCDMA1700-BIV 1752.6 Duty Cycle: 1: 1

Probe: EX3DV4 – SN3617 ConvF(8.41,8.41,8.41)

**Area Scan (71x121x1):** Interpolated grid: dx=1.000 mm, dy=1.000 mm

Maximum value of SAR (interpolated) = 1.19 W/kg

**Zoom Scan (7x7x7)/Cube 0:** Measurement grid: dx=5mm, dy=5mm, dz=5mm

Reference Value = 11.28 V/m; Power Drift = 0.02 dB

Peak SAR (extrapolated) = 1.36 W/kg

**SAR(1 g) = 0.756 W/kg; SAR(10 g) = 0.385 W/kg**

Maximum value of SAR (measured) = 0.863 W/kg

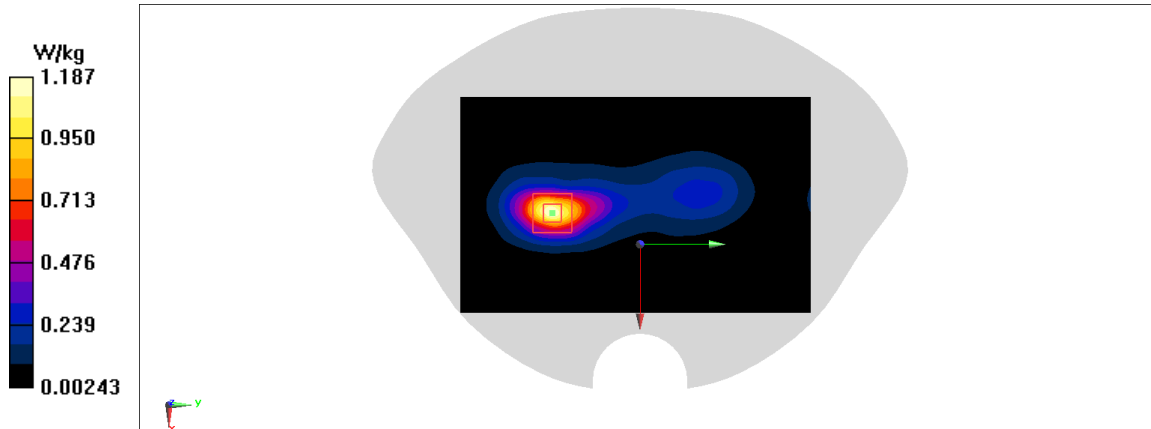
**Fig A.9**



**WCDMA1700-BIV\_CH1312 Rear**

Date: 6/8/2020

Electronics: DAE4 Sn777

Medium: head 1750 MHz

Medium parameters used:  $f = 1712.4$ ;  $\sigma = 1.344$  mho/m;  $\epsilon_r = 40.73$ ;  $\rho = 1000$  kg/m<sup>3</sup>

Ambient Temperature: 22.5°C, Liquid Temperature: 22.3°C

Communication System: WCDMA1700-BIV 1712.4 Duty Cycle: 1: 1

Probe: EX3DV4 – SN3617 ConvF(8.41,8.41,8.41)

**Area Scan (71x121x1):** Interpolated grid: dx=1.000 mm, dy=1.000 mm

Maximum value of SAR (interpolated) = SAR W/kg

**Zoom Scan (7x7x7)/Cube 0:** Measurement grid: dx=5mm, dy=5mm, dz=5mm

Reference Value = (5x5x7)/Cube V/m; Power Drift = 0.07 dB

Peak SAR (extrapolated) = V/m; W/kg

**SAR(1 g) = 0.806 W/kg; SAR(10 g) = 0.463 W/kg**

Maximum value of SAR (measured) = g W/kg

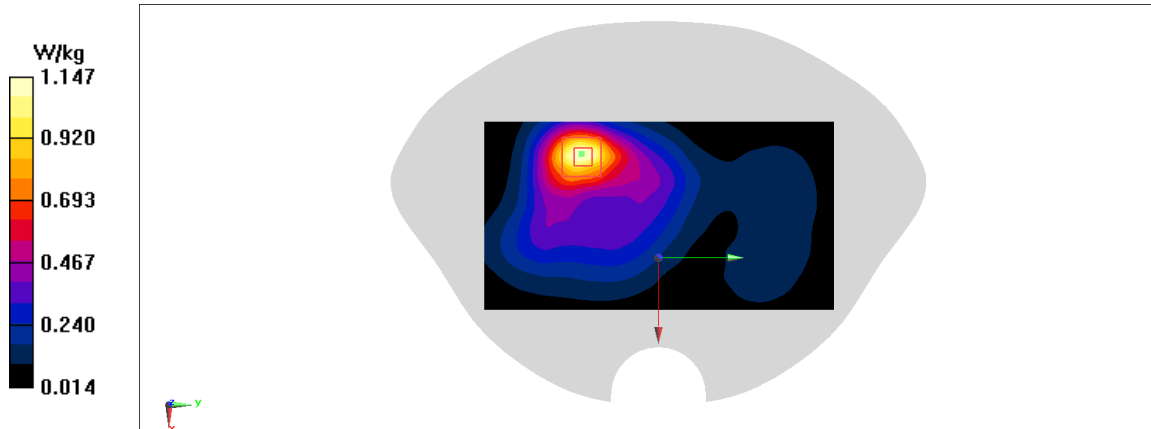
**Fig A.10**

**WCDMA850-BV\_CH4132 Left Cheek**

Date: 6/6/2020

Electronics: DAE4 Sn777

Medium: head 835 MHz

Medium parameters used:  $f = 826.4$ ;  $\sigma = 0.892$  mho/m;  $\epsilon_r = 41.61$ ;  $\rho = 1000$  kg/m<sup>3</sup>

Ambient Temperature: 22.5°C, Liquid Temperature: 22.3°C

Communication System: WCDMA850-BV 826.4 Duty Cycle: 1: 1

Probe: EX3DV4 – SN3617 ConvF(9.66,9.66,9.66)

**Area Scan (71x121x1):** Interpolated grid: dx=1.000 mm, dy=1.000 mm

Maximum value of SAR (interpolated) = 0.729 W/kg

**Zoom Scan (7x7x7)/Cube 0:** Measurement grid: dx=5mm, dy=5mm, dz=5mm

Reference Value = 6.416 V/m; Power Drift = 0.13 dB

Peak SAR (extrapolated) = 1.26 W/kg

**SAR(1 g) = 0.622 W/kg; SAR(10 g) = 0.344 W/kg**

Maximum value of SAR (measured) = 0.659 W/kg

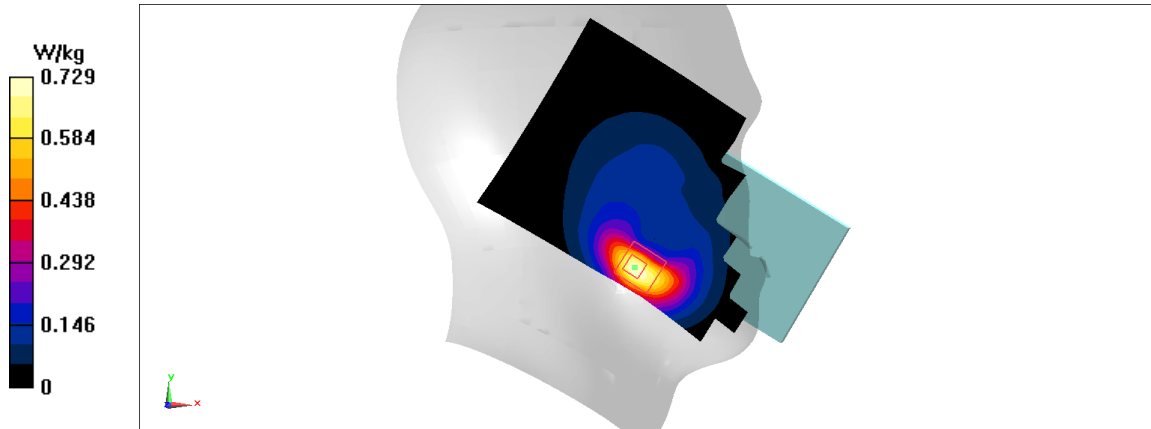

**Fig A.11**

**WCDMA850-BV\_CH4182 Left**

Date: 6/6/2020

Electronics: DAE4 Sn777

Medium: head 835 MHz

Medium parameters used:  $f = 836.4$ ;  $\sigma = 0.902$  mho/m;  $\epsilon_r = 41.6$ ;  $\rho = 1000$  kg/m<sup>3</sup>

Ambient Temperature: 22.5°C, Liquid Temperature: 22.3°C

Communication System: WCDMA850-BV 836.4 Duty Cycle: 1: 1

Probe: EX3DV4 – SN3617 ConvF(9.66,9.66,9.66)

**Area Scan (71x121x1):** Interpolated grid: dx=1.000 mm, dy=1.000 mm

Maximum value of SAR (interpolated) = 1.41 W/kg

**Zoom Scan (7x7x7)/Cube 0:** Measurement grid: dx=5mm, dy=5mm, dz=5mm

Reference Value = 33.59 V/m; Power Drift = -0.1 dB

Peak SAR (extrapolated) = 1.55 W/kg

**SAR(1 g) = 0.894 W/kg; SAR(10 g) = 0.51 W/kg**

Maximum value of SAR (measured) = 0.978 W/kg

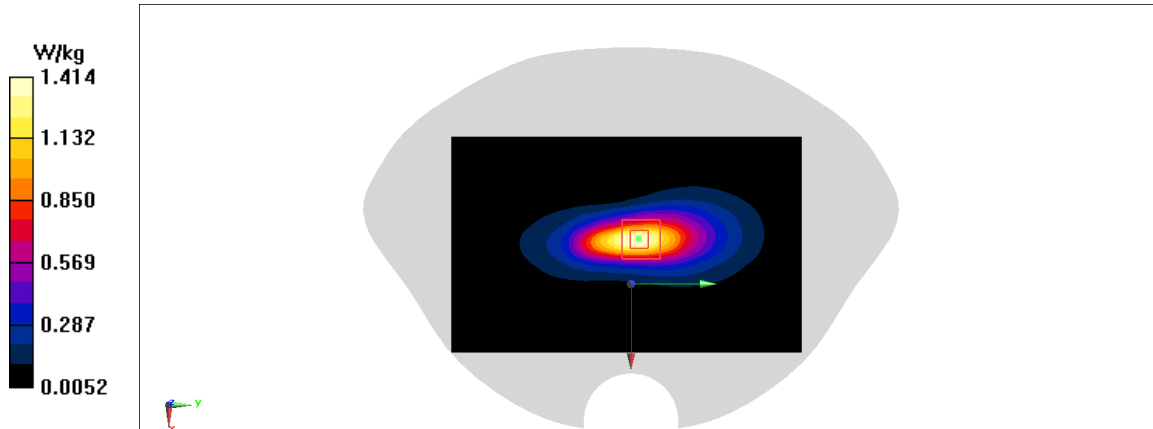
**Fig A.12**

**CDMA800-BC0\_CH1013 Left Cheek**

Date: 6/7/2020

Electronics: DAE4 Sn777

Medium: head 835 MHz

Medium parameters used:  $f = 824.7$ ;  $\sigma = 0.874$  mho/m;  $\epsilon_r = 41.56$ ;  $\rho = 1000$  kg/m<sup>3</sup>

Ambient Temperature: 22.5°C, Liquid Temperature: 22.3°C

Communication System: CDMA800-BC0 824.7 Duty Cycle: 1: 1

Probe: EX3DV4 – SN3617 ConvF(9.66,9.66,9.66)

**Area Scan (71x121x1):** Interpolated grid: dx=1.000 mm, dy=1.000 mm

Maximum value of SAR (interpolated) = 0.589 W/kg

**Zoom Scan (7x7x7)/Cube 0:** Measurement grid: dx=5mm, dy=5mm, dz=5mm

Reference Value = 7.005 V/m; Power Drift = -0.04 dB

Peak SAR (extrapolated) = 1.04 W/kg

**SAR(1 g) = 0.505 W/kg; SAR(10 g) = 0.279 W/kg**

Maximum value of SAR (measured) = 0.527 W/kg

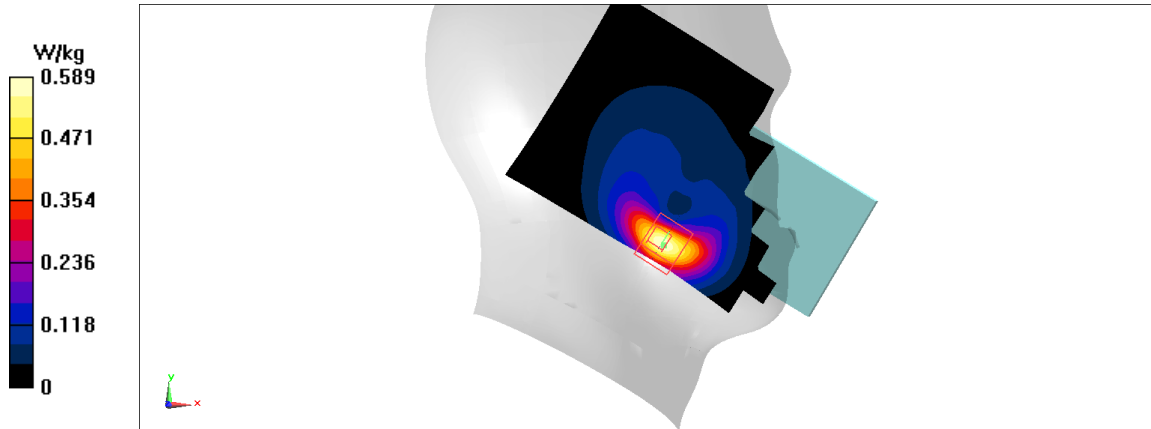

Fig A.13

**CDMA800-BC0\_CH1013 Left**

Date: 6/7/2020

Electronics: DAE4 Sn777

Medium: head 835 MHz

Medium parameters used:  $f = 824.7$ ;  $\sigma = 0.874$  mho/m;  $\epsilon_r = 41.56$ ;  $\rho = 1000$  kg/m<sup>3</sup>

Ambient Temperature: 22.5°C, Liquid Temperature: 22.3°C

Communication System: CDMA800-BC0 824.7 Duty Cycle: 1: 1

Probe: EX3DV4 – SN3617 ConvF(9.66,9.66,9.66)

**Area Scan (71x121x1):** Interpolated grid: dx=1.000 mm, dy=1.000 mm

Maximum value of SAR (interpolated) = 0.92 W/kg

**Zoom Scan (7x7x7)/Cube 0:** Measurement grid: dx=5mm, dy=5mm, dz=5mm

Reference Value = 28.39 V/m; Power Drift = 0.03 dB

Peak SAR (extrapolated) = 1.31 W/kg

**SAR(1 g) = 0.646 W/kg; SAR(10 g) = 0.34 W/kg**

Maximum value of SAR (measured) = 0.647 W/kg

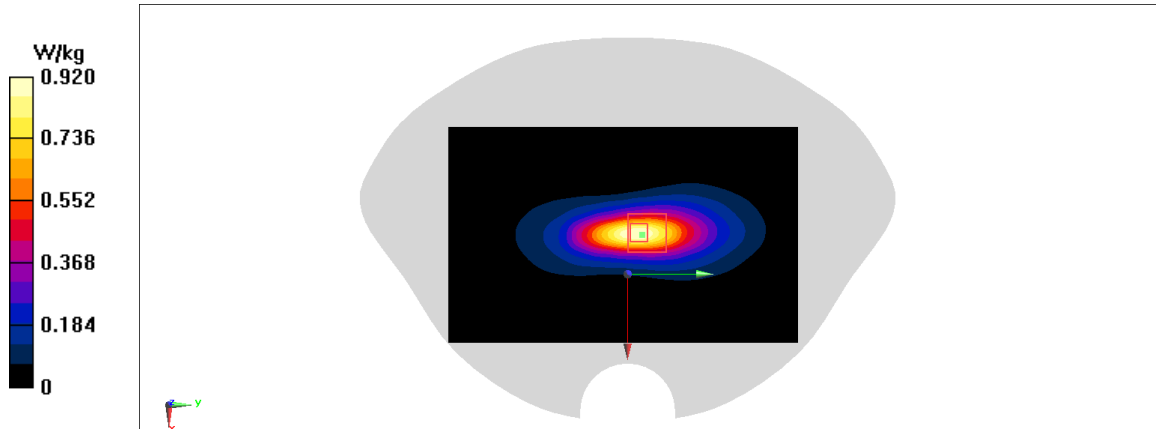
**Fig A.14**

**CDMA1900-BC1\_CH600 Left Cheek**

Date: 6/11/2020

Electronics: DAE4 Sn777

Medium: head 1900 MHz

Medium parameters used:  $f = 1880$ ;  $\sigma = 1.382$  mho/m;  $\epsilon_r = 40.11$ ;  $\rho = 1000$  kg/m<sup>3</sup>

Ambient Temperature: 22.5°C, Liquid Temperature: 22.3°C

Communication System: CDMA1900-BC1 1880 Duty Cycle: 1: 1

Probe: EX3DV4 – SN3617 ConvF(8.14,8.14,8.14)

**Area Scan (71x121x1):** Interpolated grid: dx=1.000 mm, dy=1.000 mm

Maximum value of SAR (interpolated) = 0.814 W/kg

**Zoom Scan (7x7x7)/Cube 0:** Measurement grid: dx=5mm, dy=5mm, dz=5mm

Reference Value = 6.444 V/m; Power Drift = 0.07 dB

Peak SAR (extrapolated) = 1.74 W/kg

**SAR(1 g) = 0.846 W/kg; SAR(10 g) = 0.464 W/kg**

Maximum value of SAR (measured) = 0.899 W/kg

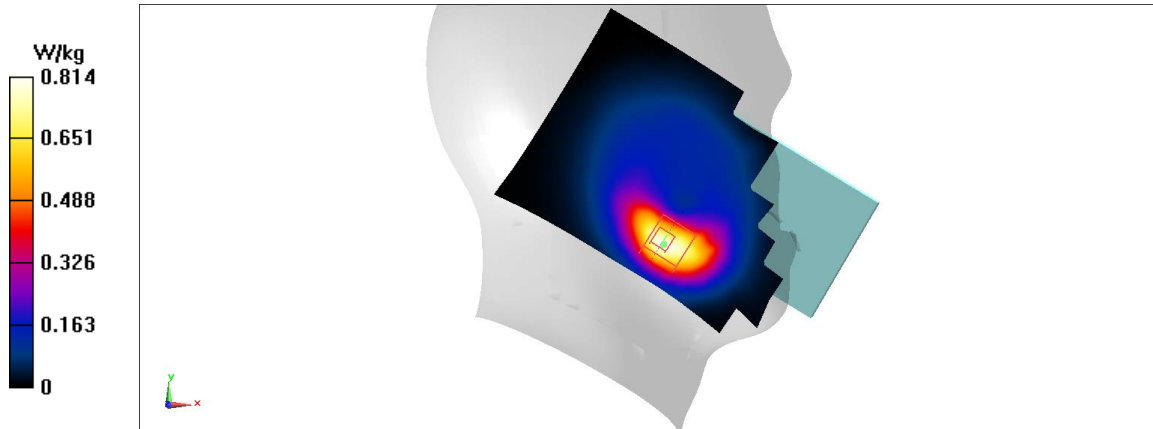

Fig A.15

**CDMA1900-BC1\_CH25 Left**

Date: 6/11/2020

Electronics: DAE4 Sn777

Medium: head 1900 MHz

Medium parameters used:  $f = 1851.25$ ;  $\sigma = 1.354$  mho/m;  $\epsilon_r = 40.15$ ;  $\rho = 1000$  kg/m<sup>3</sup>

Ambient Temperature: 22.5°C, Liquid Temperature: 22.3°C

Communication System: CDMA1900-BC1 1851.25 Duty Cycle: 1: 1

Probe: EX3DV4 – SN3617 ConvF(8.14,8.14,8.14)

**Area Scan (71x121x1):** Interpolated grid: dx=1.000 mm, dy=1.000 mm

Maximum value of SAR (interpolated) = 1.34 W/kg

**Zoom Scan (7x7x7)/Cube 0:** Measurement grid: dx=5mm, dy=5mm, dz=5mm

Reference Value = 12.78 V/m; Power Drift = -0.1 dB

Peak SAR (extrapolated) = 1.61 W/kg

**SAR(1 g) = 0.881 W/kg; SAR(10 g) = 0.45 W/kg**

Maximum value of SAR (measured) = 1 W/kg

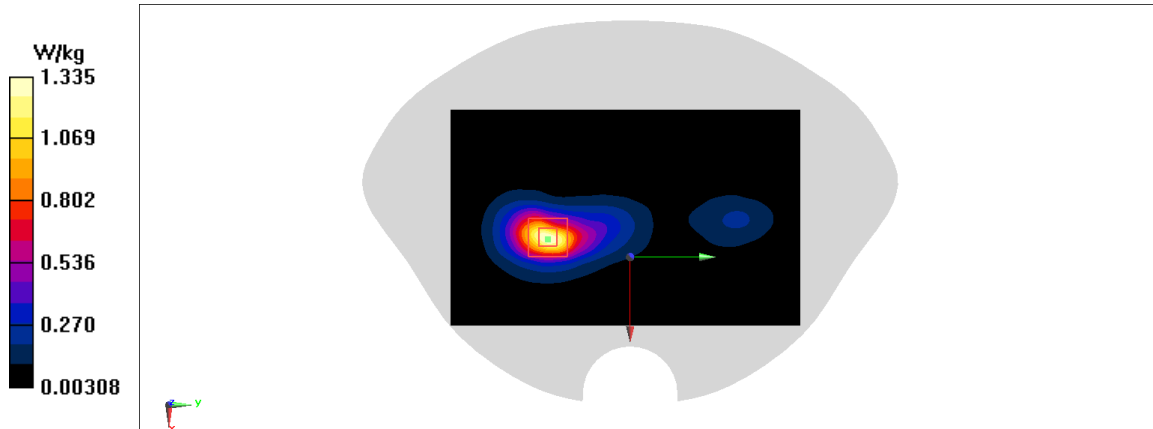

**Fig A.16**

**CDMA1900-BC1\_CH25 Rear**

Date: 6/11/2020

Electronics: DAE4 Sn777

Medium: head 1900 MHz

Medium parameters used:  $f = 1851.25$ ;  $\sigma = 1.354$  mho/m;  $\epsilon_r = 40.15$ ;  $\rho = 1000$  kg/m<sup>3</sup>

Ambient Temperature: 22.5°C, Liquid Temperature: 22.3°C

Communication System: CDMA1900-BC1 1851.25 Duty Cycle: 1: 1

Probe: EX3DV4 – SN3617 ConvF(8.14,8.14,8.14)

**Area Scan (71x121x1):** Interpolated grid: dx=1.000 mm, dy=1.000 mm

Maximum value of SAR (interpolated) = 1.06 W/kg

**Zoom Scan (7x7x7)/Cube 0:** Measurement grid: dx=5mm, dy=5mm, dz=5mm

Reference Value = 15.71 V/m; Power Drift = -0.06 dB

Peak SAR (extrapolated) = 1.23 W/kg

**SAR(1 g) = 0.733 W/kg; SAR(10 g) = 0.414 W/kg**

Maximum value of SAR (measured) = 0.804 W/kg

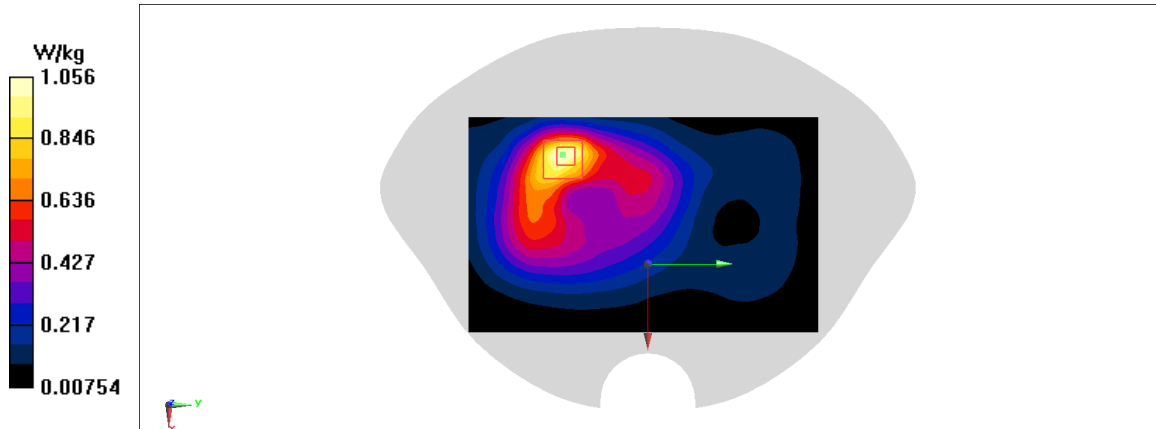

Fig A.17



**CDMA800-BC10\_CH476 Left Cheek**

Date: 6/7/2020

Electronics: DAE4 Sn777

Medium: head 835 MHz

Medium parameters used:  $f = 817.9$ ;  $\sigma = 0.868$  mho/m;  $\epsilon_r = 41.57$ ;  $\rho = 1000$  kg/m<sup>3</sup>

Ambient Temperature: 22.5°C, Liquid Temperature: 22.3°C

Communication System: CDMA800-BC10 817.9 Duty Cycle: 1: 1

Probe: EX3DV4 – SN3617 ConvF(9.66,9.66,9.66)

**Area Scan (71x121x1):** Interpolated grid: dx=1.000 mm, dy=1.000 mm

Maximum value of SAR (interpolated) = 0.513 W/kg

**Zoom Scan (7x7x7)/Cube 0:** Measurement grid: dx=5mm, dy=5mm, dz=5mm

Reference Value = 6.873 V/m; Power Drift = -0.09 dB

Peak SAR (extrapolated) = 1.1 W/kg

**SAR(1 g) = 0.534 W/kg; SAR(10 g) = 0.292 W/kg**

Maximum value of SAR (measured) = 0.544 W/kg

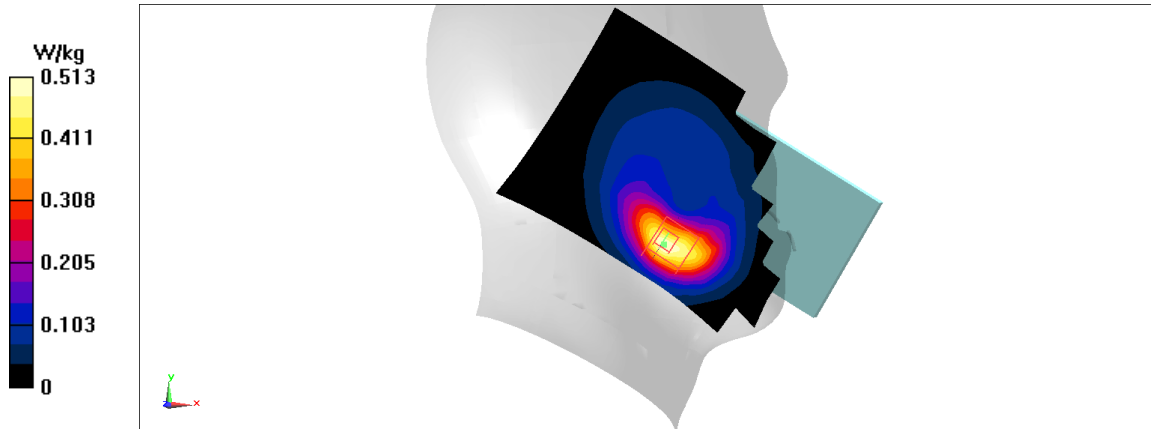

Fig A.18

**CDMA800-BC10\_CH476 Left**

Date: 6/7/2020

Electronics: DAE4 Sn777

Medium: head 835 MHz

Medium parameters used:  $f = 817.9$ ;  $\sigma = 0.868$  mho/m;  $\epsilon_r = 41.57$ ;  $\rho = 1000$  kg/m<sup>3</sup>

Ambient Temperature: 22.5°C, Liquid Temperature: 22.3°C

Communication System: CDMA800-BC10 817.9 Duty Cycle: 1: 1

Probe: EX3DV4 – SN3617 ConvF(9.66,9.66,9.66)

**Area Scan (71x121x1):** Interpolated grid: dx=1.000 mm, dy=1.000 mm

Maximum value of SAR (interpolated) = 1.09 W/kg

**Zoom Scan (7x7x7)/Cube 0:** Measurement grid: dx=5mm, dy=5mm, dz=5mm

Reference Value = 32.55 V/m; Power Drift = -0.06 dB

Peak SAR (extrapolated) = 1.4 W/kg

**SAR(1 g) = 0.696 W/kg; SAR(10 g) = 0.363 W/kg**

Maximum value of SAR (measured) = 0.754 W/kg

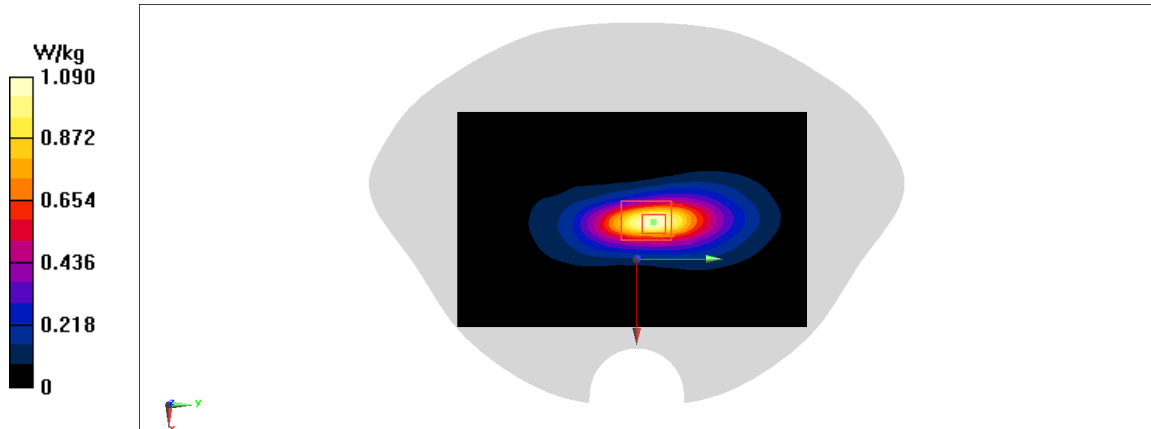

Fig A.19

**LTE2500-FDD7\_CH21100 Right Cheek**

Date: 6/14/2020

Electronics: DAE4 Sn777

Medium: head 2600 MHz

Medium parameters used:  $f = 2535$  MHz;  $\sigma = 1.904$  mho/m;  $\epsilon_r = 39.65$ ;  $\rho = 1000$  kg/m<sup>3</sup>

Ambient Temperature: 22.5°C, Liquid Temperature: 22.3°C

Communication System: LTE2500-FDD7 2535 MHz Duty Cycle: 1: 1

Probe: EX3DV4 – SN3617 ConvF(7.52,7.52,7.52)

**Area Scan (71x121x1):** Interpolated grid: dx=1.000 mm, dy=1.000 mm

Maximum value of SAR (interpolated) = 0.679 W/kg

**Zoom Scan (7x7x7)/Cube 0:** Measurement grid: dx=5mm, dy=5mm, dz=5mm

Reference Value = 6.993 V/m; Power Drift = -0.01 dB

Peak SAR (extrapolated) = 1.1 W/kg

**SAR(1 g) = 0.47 W/kg; SAR(10 g) = 0.221 W/kg**

Maximum value of SAR (measured) = 0.546 W/kg

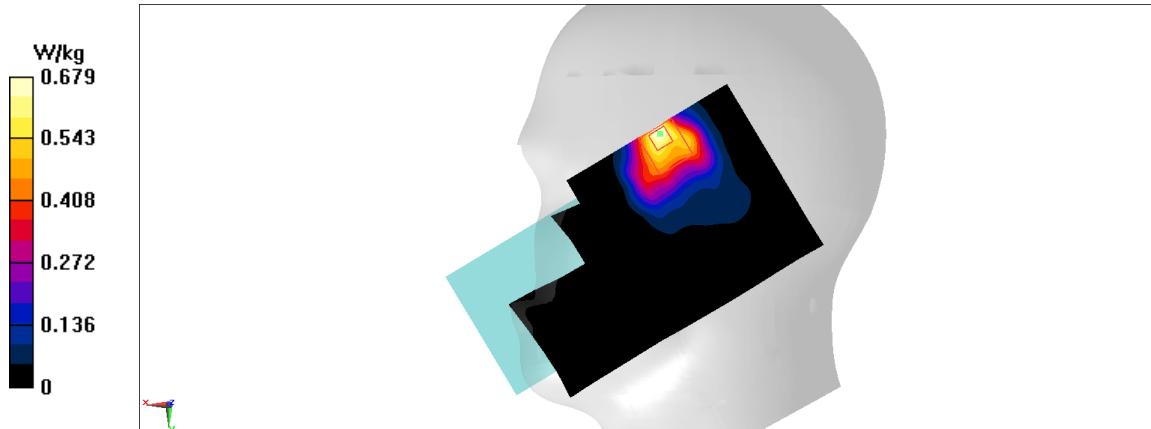

Fig A.20

**LTE2500-FDD7\_CH21350 Rear**

Date: 6/14/2020

Electronics: DAE4 Sn777

Medium: head 2600 MHz

Medium parameters used:  $f = 2560$  MHz;  $\sigma = 1.928$  mho/m;  $\epsilon_r = 39.62$ ;  $\rho = 1000$  kg/m<sup>3</sup>

Ambient Temperature: 22.5°C, Liquid Temperature: 22.3°C

Communication System: LTE2500-FDD7 2560 MHz Duty Cycle: 1: 1

Probe: EX3DV4 – SN3617 ConvF(7.65,7.65,7.65)

**Area Scan (71x121x1):** Interpolated grid: dx=1.000 mm, dy=1.000 mm

Maximum value of SAR (interpolated) = 1.5 W/kg

**Zoom Scan (7x7x7)/Cube 0:** Measurement grid: dx=5mm, dy=5mm, dz=5mm

Reference Value = 4.145 V/m; Power Drift = 0.05 dB

Peak SAR (extrapolated) = 2.15 W/kg

**SAR(1 g) = 0.966 W/kg; SAR(10 g) = 0.412 W/kg**

Maximum value of SAR (measured) = 1.14 W/kg

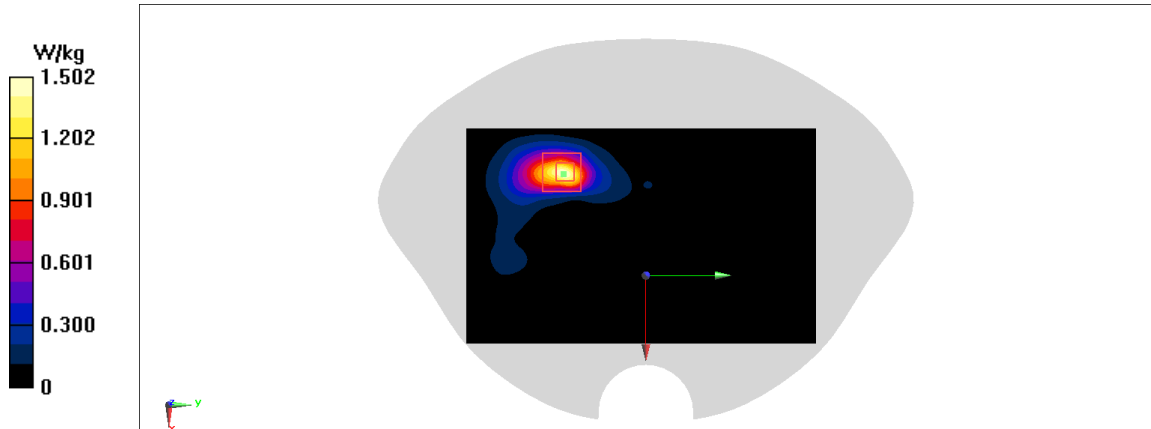

Fig A.21

**LTE2500-FDD7\_CH21100 Rear**

Date: 6/14/2020

Electronics: DAE4 Sn777

Medium: head 2600 MHz

Medium parameters used:  $f = 2535$  MHz;  $\sigma = 1.904$  mho/m;  $\epsilon_r = 39.65$ ;  $\rho = 1000$  kg/m<sup>3</sup>

Ambient Temperature: 22.5°C, Liquid Temperature: 22.3°C

Communication System: LTE2500-FDD7 2535 MHz Duty Cycle: 1: 1

Probe: EX3DV4 – SN3617 ConvF(7.65,7.65,7.65)

**Area Scan (71x121x1):** Interpolated grid: dx=1.000 mm, dy=1.000 mm

Maximum value of SAR (interpolated) = 0.654 W/kg

**Zoom Scan (7x7x7)/Cube 0:** Measurement grid: dx=5mm, dy=5mm, dz=5mm

Reference Value = 3.962 V/m; Power Drift = 0.12 dB

Peak SAR (extrapolated) = 0.781 W/kg

**SAR(1 g) = 0.4 W/kg; SAR(10 g) = 0.194 W/kg**

Maximum value of SAR (measured) = 0.448 W/kg

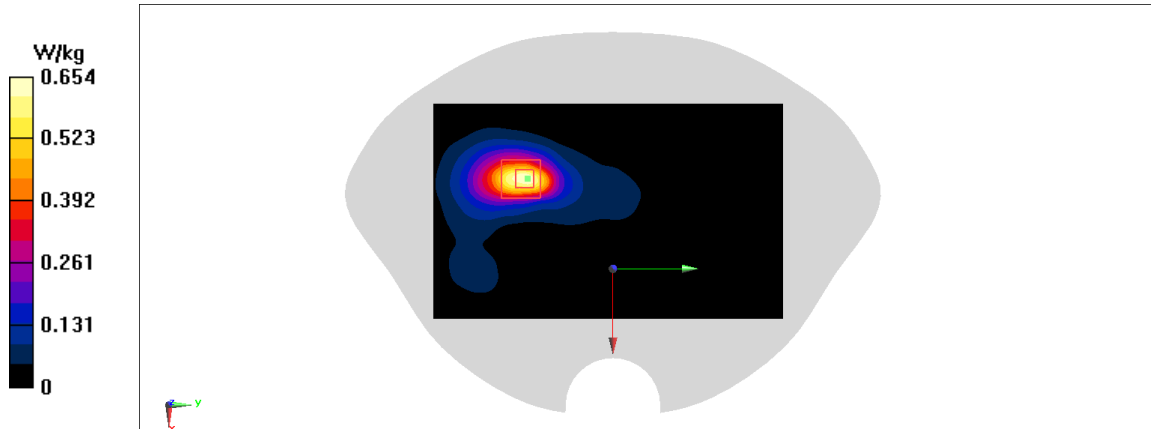

Fig A.22

**LTE700-FDD12\_CH23095 Left Cheek**

Date: 6/4/2020

Electronics: DAE4 Sn777

Medium: head 750 MHz

Medium parameters used:  $f = 707.5$  MHz;  $\sigma = 0.858$  mho/m;  $\epsilon_r = 41.75$ ;  $\rho = 1000$  kg/m<sup>3</sup>

Ambient Temperature: 22.5°C, Liquid Temperature: 22.3°C

Communication System: LTE700-FDD12 707.5 MHz Duty Cycle: 1: 1

Probe: EX3DV4 – SN3617 ConvF(10.07,10.07,10.07)

**Area Scan (71x121x1):** Interpolated grid: dx=1.000 mm, dy=1.000 mm

Maximum value of SAR (interpolated) = 1.19 W/kg

**Zoom Scan (7x7x7)/Cube 0:** Measurement grid: dx=5mm, dy=5mm, dz=5mm

Reference Value = 13.61 V/m; Power Drift = -0.07 dB

Peak SAR (extrapolated) = 1.39 W/kg

**SAR(1 g) = 0.723 W/kg; SAR(10 g) = 0.402 W/kg**

Maximum value of SAR (measured) = 0.81 W/kg

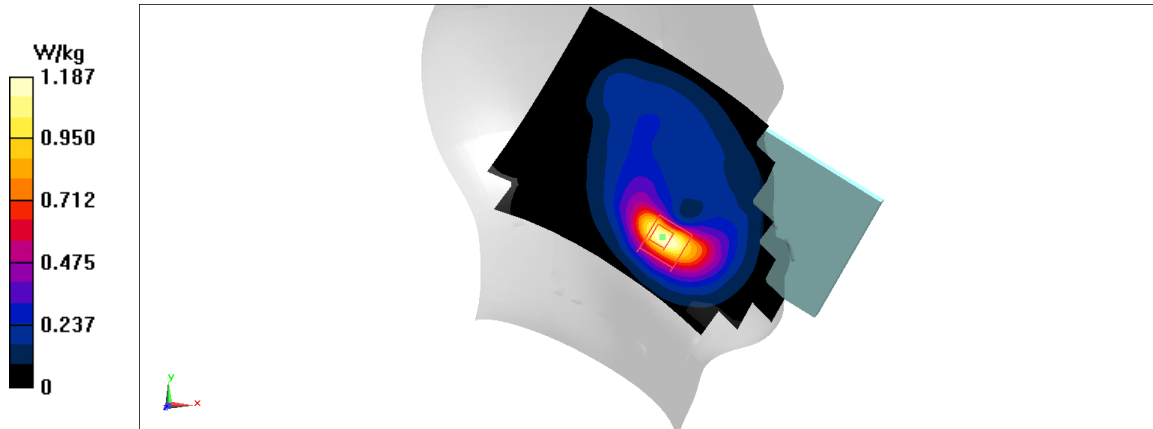

Fig A.23

**LTE700-FDD12\_CH23095 Left**

Date: 6/4/2020

Electronics: DAE4 Sn777

Medium: head 750 MHz

Medium parameters used:  $f = 707.5$  MHz;  $\sigma = 0.858$  mho/m;  $\epsilon_r = 41.75$ ;  $\rho = 1000$  kg/m<sup>3</sup>

Ambient Temperature: 22.5°C, Liquid Temperature: 22.3°C

Communication System: LTE700-FDD12 707.5 MHz Duty Cycle: 1: 1

Probe: EX3DV4 – SN3617 ConvF(10.07,10.07,10.07)

**Area Scan (71x121x1):** Interpolated grid: dx=1.000 mm, dy=1.000 mm

Maximum value of SAR (interpolated) = 0.97 W/kg

**Zoom Scan (7x7x7)/Cube 0:** Measurement grid: dx=5mm, dy=5mm, dz=5mm

Reference Value = 27.84 V/m; Power Drift = 0.05 dB

Peak SAR (extrapolated) = 1.18 W/kg

**SAR(1 g) = 0.639 W/kg; SAR(10 g) = 0.373 W/kg**

Maximum value of SAR (measured) = 0.951 W/kg

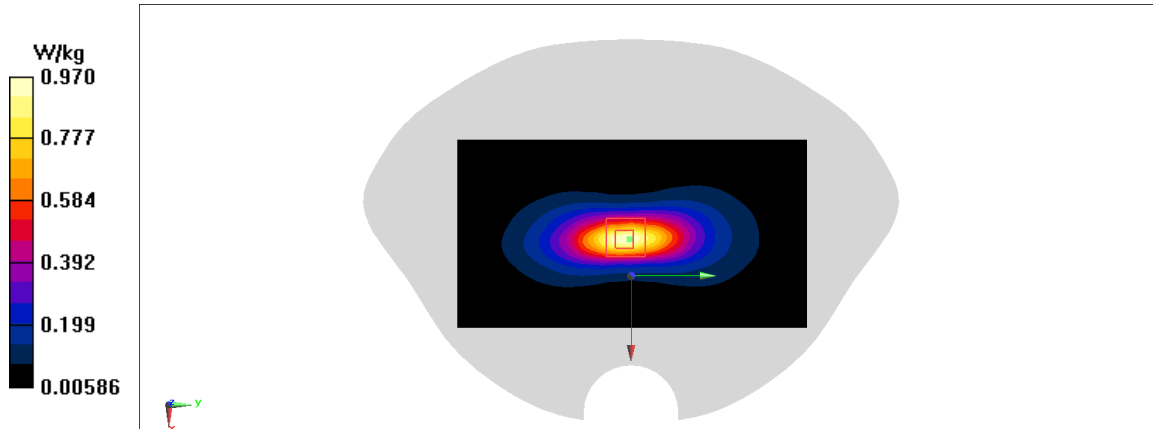

**Fig A.24**

**LTE750-FDD13\_CH23230 Left Cheek**

Date: 6/4/2020

Electronics: DAE4 Sn777

Medium: head 750 MHz

Medium parameters used:  $f = 782 \text{ MHz}$ ;  $\sigma = 0.928 \text{ mho/m}$ ;  $\epsilon_r = 41.66$ ;  $\rho = 1000 \text{ kg/m}^3$ Ambient Temperature:  $22.5^\circ\text{C}$ , Liquid Temperature:  $22.3^\circ\text{C}$ 

Communication System: LTE750-FDD13 782 MHz Duty Cycle: 1: 1

Probe: EX3DV4 – SN3617 ConvF(10.07,10.07,10.07)

**Area Scan (71x121x1):** Interpolated grid:  $dx=1.000 \text{ mm}$ ,  $dy=1.000 \text{ mm}$ Maximum value of SAR (interpolated) =  $0.378 \text{ W/kg}$ **Zoom Scan (7x7x7)/Cube 0:** Measurement grid:  $dx=5\text{mm}$ ,  $dy=5\text{mm}$ ,  $dz=5\text{mm}$ Reference Value =  $5.842 \text{ V/m}$ ; Power Drift =  $0 \text{ dB}$ Peak SAR (extrapolated) =  $0.45 \text{ W/kg}$ **SAR(1 g) =  $0.232 \text{ W/kg}$ ; SAR(10 g) =  $0.125 \text{ W/kg}$** Maximum value of SAR (measured) =  $0.26 \text{ W/kg}$ 

Fig A.25



**LTE750-FDD13\_CH23230 Left**

Date: 6/4/2020

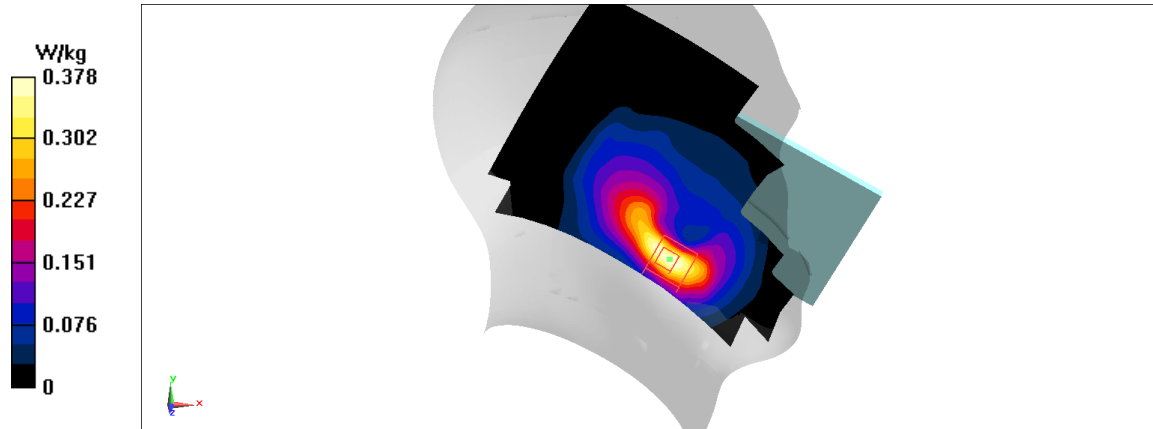
Electronics: DAE4 Sn777

Medium: head 750 MHz

Medium parameters used:  $f = 782 \text{ MHz}$ ;  $\sigma = 0.928 \text{ mho/m}$ ;  $\epsilon_r = 41.66$ ;  $\rho = 1000 \text{ kg/m}^3$

Ambient Temperature:  $22.5^\circ\text{C}$ , Liquid Temperature:  $22.3^\circ\text{C}$

Communication System: LTE750-FDD13 782 MHz Duty Cycle: 1: 1

Probe: EX3DV4 – SN3617 ConvF(10.07,10.07,10.07)

**Area Scan (71x121x1):** Interpolated grid:  $dx=1.000 \text{ mm}$ ,  $dy=1.000 \text{ mm}$

Maximum value of SAR (interpolated) =  $0.518 \text{ W/kg}$

**Zoom Scan (7x7x7)/Cube 0:** Measurement grid:  $dx=5\text{mm}$ ,  $dy=5\text{mm}$ ,  $dz=5\text{mm}$

Reference Value =  $19.51 \text{ V/m}$ ; Power Drift =  $-0.1 \text{ dB}$

Peak SAR (extrapolated) =  $0.63 \text{ W/kg}$

**SAR(1 g) =  $0.343 \text{ W/kg}$ ; SAR(10 g) =  $0.196 \text{ W/kg}$**

Maximum value of SAR (measured) =  $0.508 \text{ W/kg}$

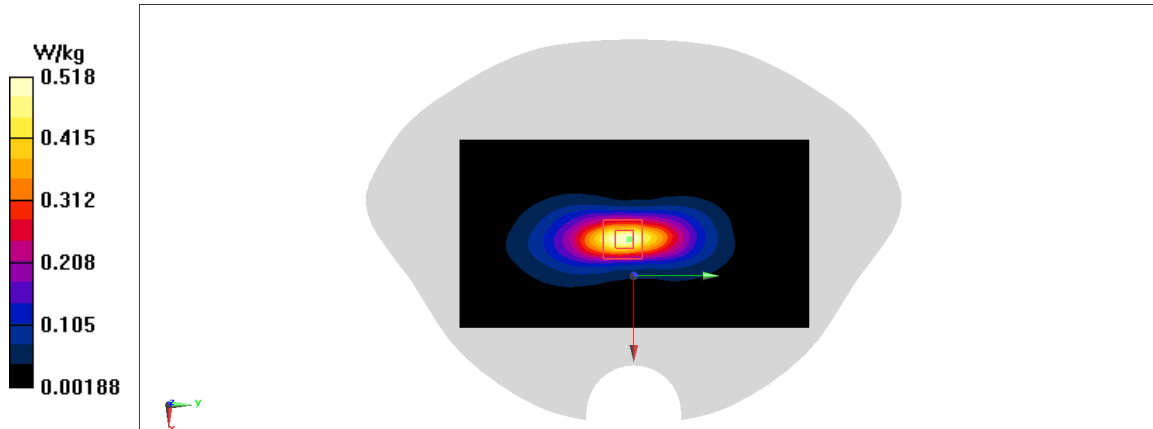

**Fig A.26**

**LTE1900-FDD25\_CH26140 Right Cheek**

Date: 6/11/2020

Electronics: DAE4 Sn777

Medium: head 1900 MHz

Medium parameters used:  $f = 1860$  MHz;  $\sigma = 1.363$  mho/m;  $\epsilon_r = 40.14$ ;  $\rho = 1000$  kg/m<sup>3</sup>

Ambient Temperature: 22.5°C, Liquid Temperature: 22.3°C

Communication System: LTE1900-FDD25 1860 MHz Duty Cycle: 1: 1

Probe: EX3DV4 – SN3617 ConvF(8.14,8.14,8.14)

**Area Scan (71x121x1):** Interpolated grid: dx=1.000 mm, dy=1.000 mm

Maximum value of SAR (interpolated) = 0.879 W/kg

**Zoom Scan (7x7x7)/Cube 0:** Measurement grid: dx=5mm, dy=5mm, dz=5mm

Reference Value = 7.518 V/m; Power Drift = 0.06 dB

Peak SAR (extrapolated) = 1.73 W/kg

**SAR(1 g) = 0.849 W/kg; SAR(10 g) = 0.42 W/kg**

Maximum value of SAR (measured) = 0.938 W/kg

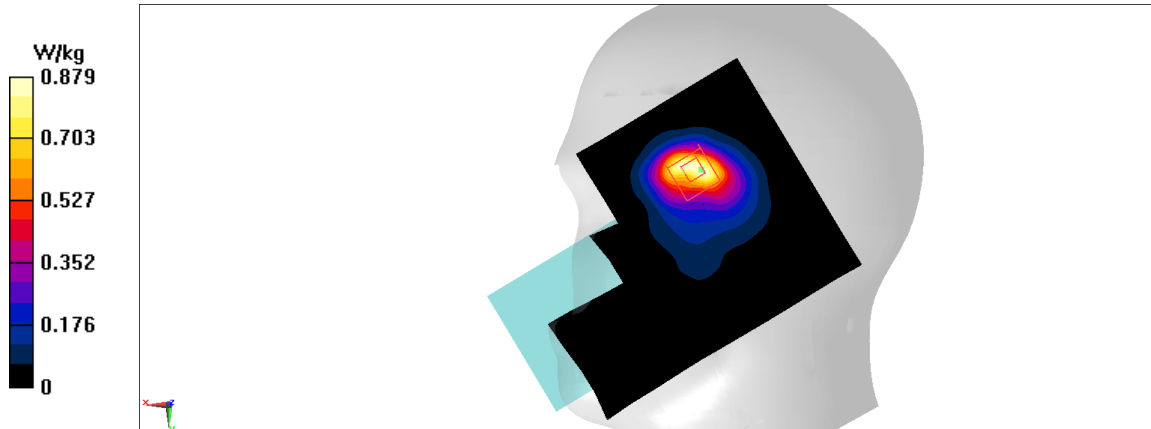

Fig A.27

**LTE1900-FDD25\_CH26140 Left**

Date: 6/11/2020

Electronics: DAE4 Sn777

Medium: head 1900 MHz

Medium parameters used:  $f = 1860$  MHz;  $\sigma = 1.363$  mho/m;  $\epsilon_r = 40.14$ ;  $\rho = 1000$  kg/m<sup>3</sup>

Ambient Temperature: 22.5°C, Liquid Temperature: 22.3°C

Communication System: LTE1900-FDD25 1860 MHz Duty Cycle: 1: 1

Probe: EX3DV4 – SN3617 ConvF(8.14,8.14,8.14)

**Area Scan (71x121x1):** Interpolated grid: dx=1.000 mm, dy=1.000 mm

Maximum value of SAR (interpolated) = W/kg

**Zoom Scan (7x7x7)/Cube 0:** Measurement grid: dx=5mm, dy=5mm, dz=5mm

Reference Value = V/m; Power Drift = -0.08 dB

Peak SAR (extrapolated) = W/kg

**SAR(1 g) = 1.02 W/kg; SAR(10 g) = 0.518 W/kg**

Maximum value of SAR (measured) = 1.14 W/kg

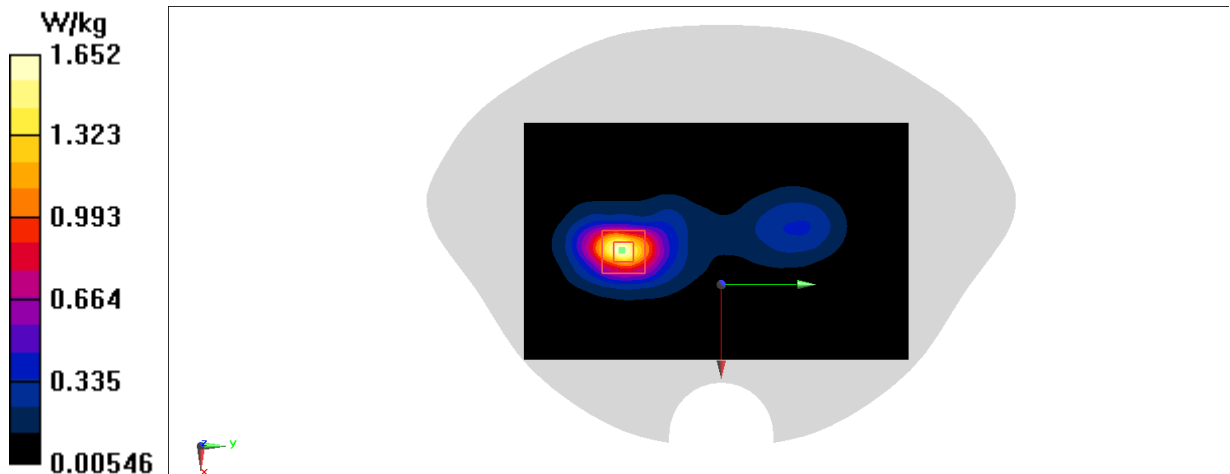

**Fig A28**

**LTE1900-FDD25\_CH26140 Rear**

Date: 6/11/2020

Electronics: DAE4 Sn777

Medium: head 1900 MHz

Medium parameters used:  $f = 1860$  MHz;  $\sigma = 1.363$  mho/m;  $\epsilon_r = 40.14$ ;  $\rho = 1000$  kg/m<sup>3</sup>

Ambient Temperature: 22.5°C, Liquid Temperature: 22.3°C

Communication System: LTE1900-FDD25 1860 MHz Duty Cycle: 1: 1

Probe: EX3DV4 – SN3617 ConvF(8.14,8.14,8.14)

**Area Scan (71x121x1):** Interpolated grid: dx=1.000 mm, dy=1.000 mm

Maximum value of SAR (interpolated) = 1.29 W/kg

**Zoom Scan (7x7x7)/Cube 0:** Measurement grid: dx=5mm, dy=5mm, dz=5mm

Reference Value = 10.73 V/m; Power Drift = 0.12 dB

Peak SAR (extrapolated) = 1.54 W/kg

**SAR(1 g) = 0.281 W/kg; SAR(10 g) = 0.158 W/kg**

Maximum value of SAR (measured) = 1.28 W/kg

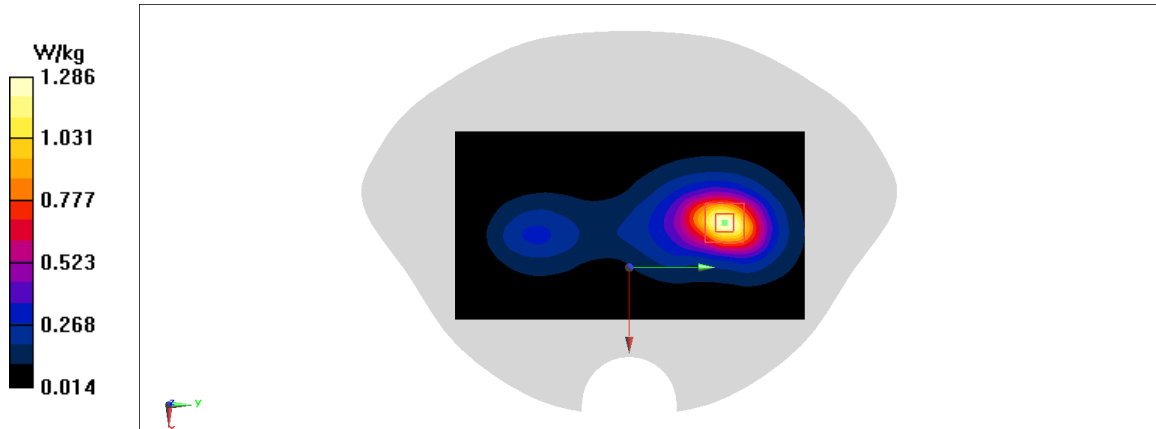

**Fig A.29**

**LTE850-FDD26\_CH26775 Left Cheek**

Date: 6/7/2020

Electronics: DAE4 Sn777

Medium: head 835 MHz

 Medium parameters used:  $f = 822.5$  MHz;  $\sigma = 0.872$  mho/m;  $\epsilon_r = 41.57$ ;  $\rho = 1000$  kg/m<sup>3</sup>

Ambient Temperature: 22.5°C, Liquid Temperature: 22.3°C

Communication System: LTE850-FDD26 822.5 MHz Duty Cycle: 1: 1

Probe: EX3DV4 – SN3617 ConvF(9.66,9.66,9.66)

**Area Scan (71x121x1):** Interpolated grid: dx=1.000 mm, dy=1.000 mm

Maximum value of SAR (interpolated) = 0.672 W/kg

**Zoom Scan (7x7x7)/Cube 0:** Measurement grid: dx=5mm, dy=5mm, dz=5mm

Reference Value = 7.451 V/m; Power Drift = 0.13 dB

Peak SAR (extrapolated) = 0.962 W/kg

**SAR(1 g) = 0.497 W/kg; SAR(10 g) = 0.275 W/kg**

Maximum value of SAR (measured) = 0.492 W/kg

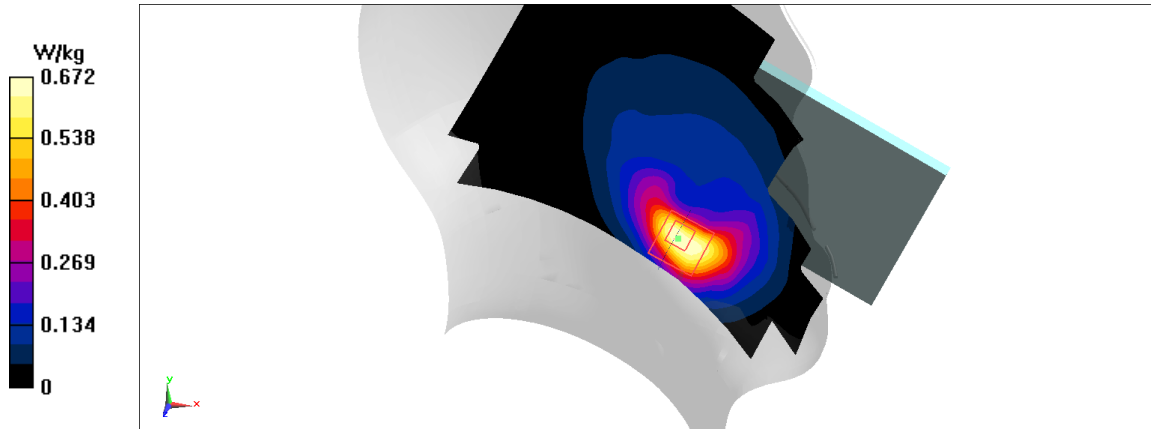
**Fig A.30**

**LTE850-FDD26\_CH26865 Left**

Date: 6/7/2020

Electronics: DAE4 Sn777

Medium: head 835 MHz

Medium parameters used:  $f = 831.5$  MHz;  $\sigma = 0.881$  mho/m;  $\epsilon_r = 41.55$ ;  $\rho = 1000$  kg/m<sup>3</sup>

Ambient Temperature: 22.5°C, Liquid Temperature: 22.3°C

Communication System: LTE850-FDD26 831.5 MHz Duty Cycle: 1: 1

Probe: EX3DV4 – SN3617 ConvF(9.66,9.66,9.66)

**Area Scan (71x121x1):** Interpolated grid: dx=1.000 mm, dy=1.000 mm

Maximum value of SAR (interpolated) = 1.43 W/kg

**Zoom Scan (7x7x7)/Cube 0:** Measurement grid: dx=5mm, dy=5mm, dz=5mm

Reference Value = 32.85 V/m; Power Drift = 0.1 dB

Peak SAR (extrapolated) = 1.78 W/kg

**SAR(1 g) = 0.941 W/kg; SAR(10 g) = 0.534 W/kg**

Maximum value of SAR (measured) = 1.44 W/kg

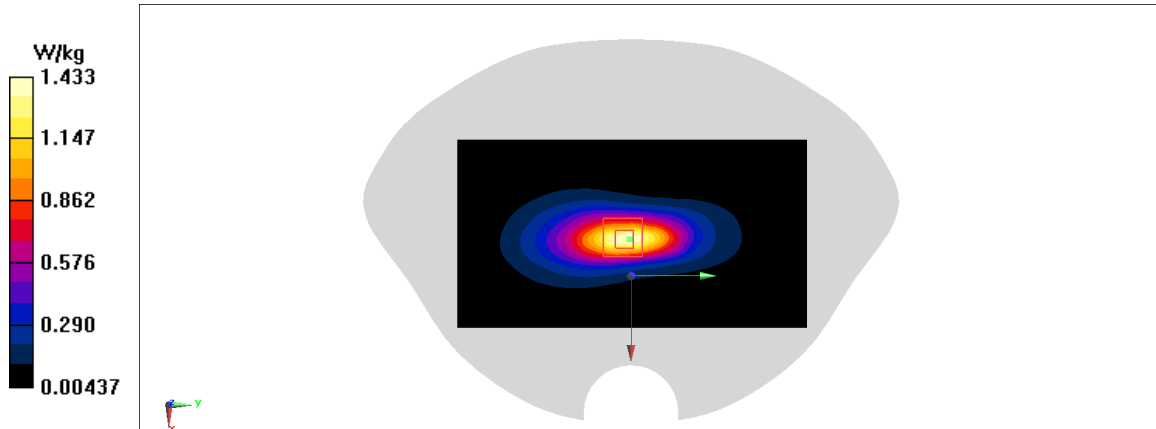

**Fig A.31**

**LTE2600-TDD41\_CH40620 Right Cheek**

Date: 6/15/2020

Electronics: DAE4 Sn777

Medium: head 2600 MHz

Medium parameters used:  $f = 2593$ ;  $\sigma = 1.974$  mho/m;  $\epsilon_r = 39.6$ ;  $\rho = 1000$  kg/m<sup>3</sup>

Ambient Temperature: 22.5°C, Liquid Temperature: 22.3°C

Communication System: LTE2600-TDD41 2593 Duty Cycle: 1: 2.309

Probe: EX3DV4 – SN3617 ConvF(7.52,7.52,7.52)

**Area Scan (71x121x1):** Interpolated grid: dx=1.000 mm, dy=1.000 mm

Maximum value of SAR (interpolated) = 0.289 W/kg

**Zoom Scan (7x7x7)/Cube 0:** Measurement grid: dx=5mm, dy=5mm, dz=5mm

Reference Value = 3.778 V/m; Power Drift = 0.09 dB

Peak SAR (extrapolated) = 0.35 W/kg

**SAR(1 g) = 0.15 W/kg; SAR(10 g) = 0.071 W/kg**

Maximum value of SAR (measured) = 0.171 W/kg

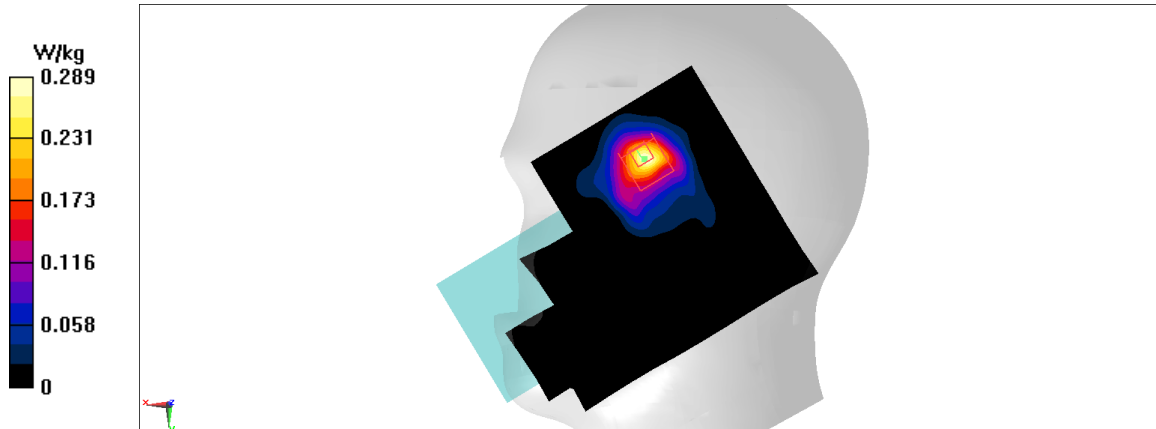

Fig A.32

**LTE2600-TDD41\_CH40620 Rear**

Date: 6/15/2020

Electronics: DAE4 Sn777

Medium: head 2600 MHz

Medium parameters used:  $f = 2593$ ;  $\sigma = 1.974$  mho/m;  $\epsilon_r = 39.6$ ;  $\rho = 1000$  kg/m<sup>3</sup>

Ambient Temperature: 22.5°C, Liquid Temperature: 22.3°C

Communication System: LTE2600-TDD41 2593 Duty Cycle: 1: 2.309

Probe: EX3DV4 – SN3617 ConvF(7.52,7.52,7.52)

**Area Scan (71x121x1):** Interpolated grid: dx=1.000 mm, dy=1.000 mm

Maximum value of SAR (interpolated) = 0.435 W/kg

**Zoom Scan (7x7x7)/Cube 0:** Measurement grid: dx=5mm, dy=5mm, dz=5mm

Reference Value = 1.656 V/m; Power Drift = -0.13 dB

Peak SAR (extrapolated) = 0.654 W/kg

**SAR(1 g) = 0.299 W/kg; SAR(10 g) = 0.127 W/kg**

Maximum value of SAR (measured) = 0.35 W/kg

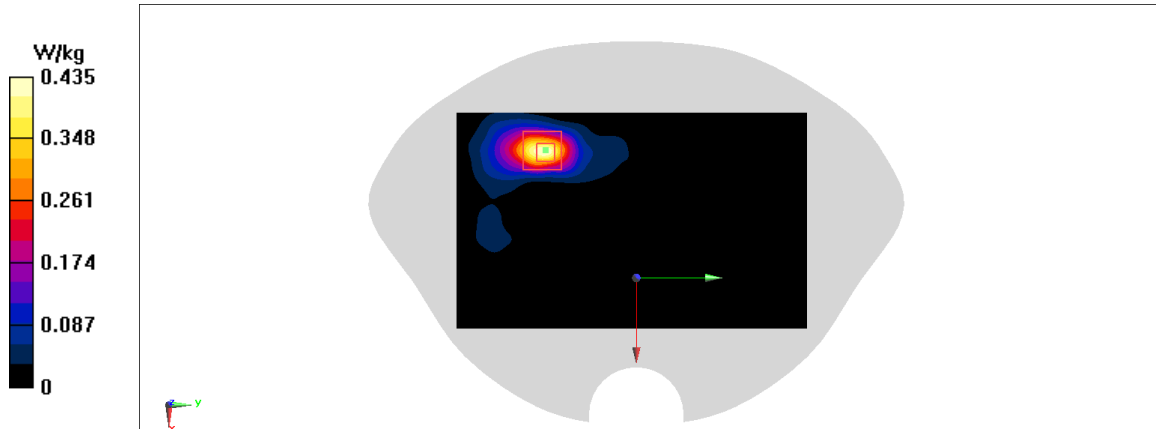

**Fig A.33**



**LTE2600-TDD41\_CH41055 Rear**

Date: 6/15/2020

Electronics: DAE4 Sn777

Medium: head 2600 MHz

Medium parameters used:  $f = 2636.5$ ;  $\sigma = 2$  mho/m;  $\epsilon_r = 39.57$ ;  $\rho = 1000$  kg/m<sup>3</sup>

Ambient Temperature: 22.5°C, Liquid Temperature: 22.3°C

Communication System: LTE2600-TDD41 2636.5 Duty Cycle: 1: 2.309

Probe: EX3DV4 – SN3617 ConvF(7.52,7.52,7.52)

**Area Scan (71x121x1):** Interpolated grid: dx=1.000 mm, dy=1.000 mm

Maximum value of SAR (interpolated) = W/kg

**Zoom Scan (7x7x7)/Cube 0:** Measurement grid: dx=5mm, dy=5mm, dz=5mm

Reference Value = V/m; Power Drift = 0.01 dB

Peak SAR (extrapolated) = W/kg

**SAR(1 g) = 0.447 W/kg; SAR(10 g) = 0.212 W/kg**

Maximum value of SAR (measured) = W/kg

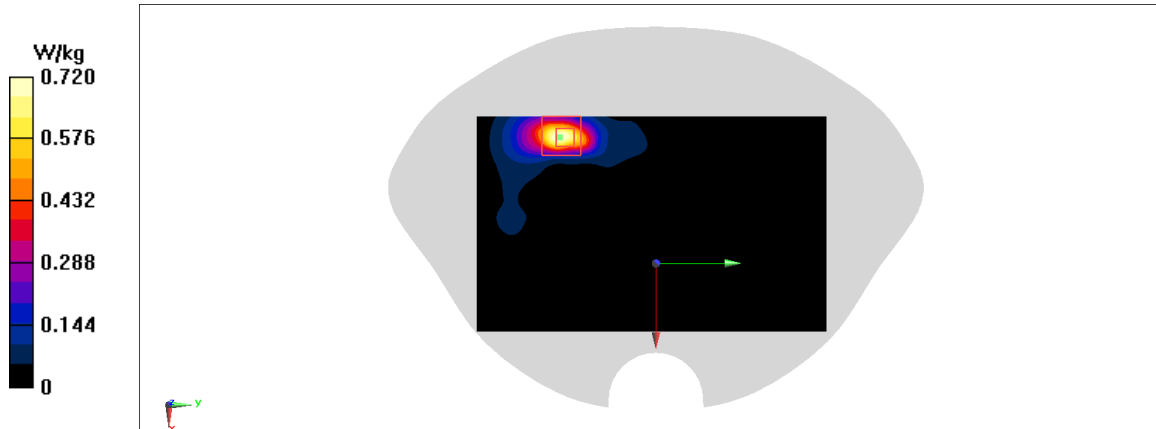
**Fig A.34**

**LTE2600-TDD41\_CH40620 Right Cheek**

Date: 6/15/2020

Electronics: DAE4 Sn777

Medium: head 2600 MHz

Medium parameters used:  $f = 2593$ ;  $\sigma = 1.974$  mho/m;  $\epsilon_r = 39.6$ ;  $\rho = 1000$  kg/m<sup>3</sup>

Ambient Temperature: 22.5°C, Liquid Temperature: 22.3°C

Communication System: LTE2600-TDD41 2593 Duty Cycle: 1: 1.58

Probe: EX3DV4 – SN3617 ConvF(7.52,7.52,7.52)

**Area Scan (71x121x1):** Interpolated grid: dx=1.000 mm, dy=1.000 mm

Maximum value of SAR (interpolated) = 0.358 W/kg

**Zoom Scan (7x7x7)/Cube 0:** Measurement grid: dx=5mm, dy=5mm, dz=5mm

Reference Value = 4.451 V/m; Power Drift = -0.03 dB

Peak SAR (extrapolated) = 0.436 W/kg

**SAR(1 g) = 0.19 W/kg; SAR(10 g) = 0.092 W/kg**

Maximum value of SAR (measured) = 0.219 W/kg

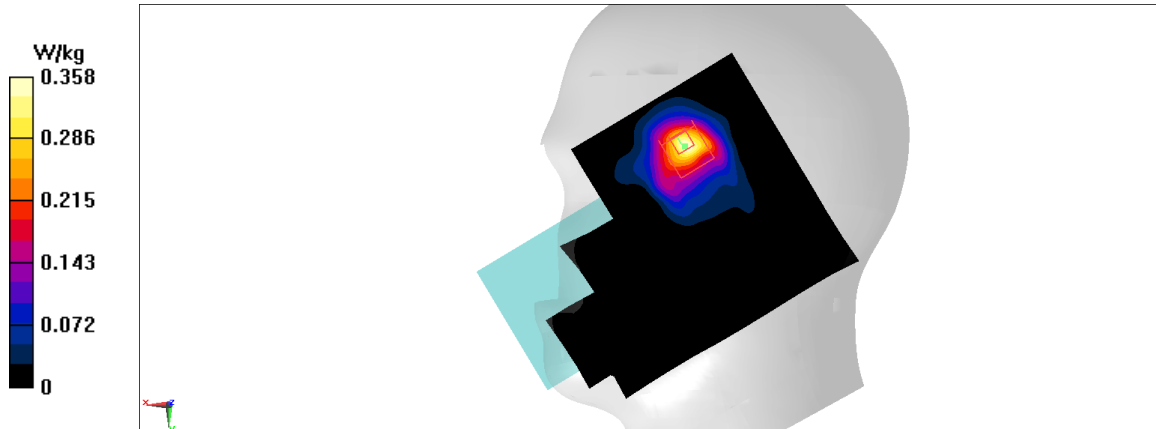

Fig A.35

**LTE2600-TDD41\_CH40620 Rear**

Date: 6/15/2020

Electronics: DAE4 Sn777

Medium: head 2600 MHz

Medium parameters used:  $f = 2593$ ;  $\sigma = 1.974$  mho/m;  $\epsilon_r = 39.6$ ;  $\rho = 1000$  kg/m<sup>3</sup>

Ambient Temperature: 22.5°C, Liquid Temperature: 22.3°C

Communication System: LTE2600-TDD41 2593 Duty Cycle: 1: 1.58

Probe: EX3DV4 – SN3617 ConvF(7.52,7.52,7.52)

**Area Scan (71x121x1):** Interpolated grid: dx=1.000 mm, dy=1.000 mm

Maximum value of SAR (interpolated) = W/kg

**Zoom Scan (7x7x7)/Cube 0:** Measurement grid: dx=5mm, dy=5mm, dz=5mm

Reference Value = V/m; Power Drift = -0.07 dB

Peak SAR (extrapolated) = W/kg

**SAR(1 g) = 0.45 W/kg; SAR(10 g) = 0.192 W/kg**

Maximum value of SAR (measured) = W/kg

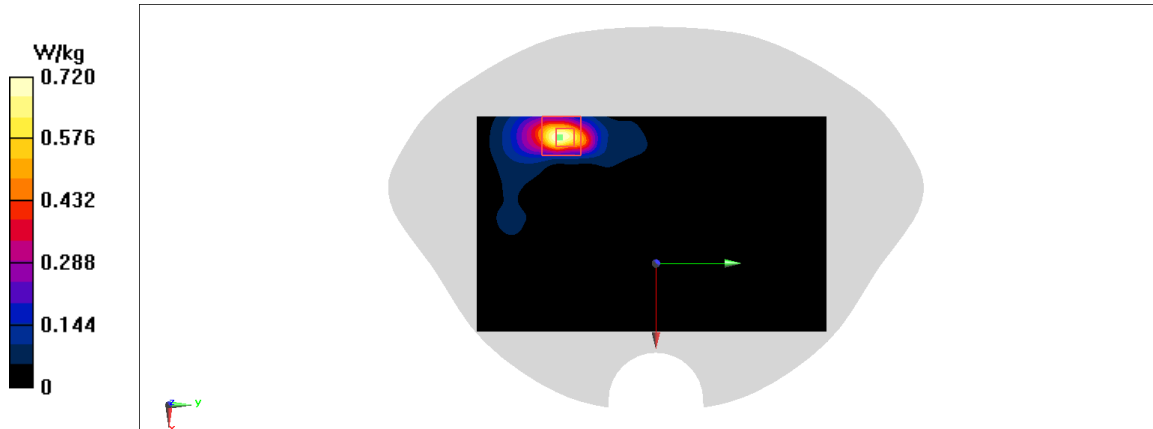

**Fig A.36**

**LTE2600-TDD41\_CH40620 Rear**

Date: 6/15/2020

Electronics: DAE4 Sn777

Medium: head 2600 MHz

Medium parameters used:  $f = 2593$ ;  $\sigma = 1.974$  mho/m;  $\epsilon_r = 39.6$ ;  $\rho = 1000$  kg/m<sup>3</sup>

Ambient Temperature: 22.5°C, Liquid Temperature: 22.3°C

Communication System: LTE2600-TDD41 2593 Duty Cycle: 1: 1.58

Probe: EX3DV4 – SN3617 ConvF(7.52,7.52,7.52)

**Area Scan (71x121x1):** Interpolated grid: dx=1.000 mm, dy=1.000 mm

Maximum value of SAR (interpolated) = 0.369 W/kg

**Zoom Scan (7x7x7)/Cube 0:** Measurement grid: dx=5mm, dy=5mm, dz=5mm

Reference Value = 2.23 V/m; Power Drift = 0.02 dB

Peak SAR (extrapolated) = 0.47 W/kg

**SAR(1 g) = 0.24 W/kg; SAR(10 g) = 0.113 W/kg**

Maximum value of SAR (measured) = 0.27 W/kg

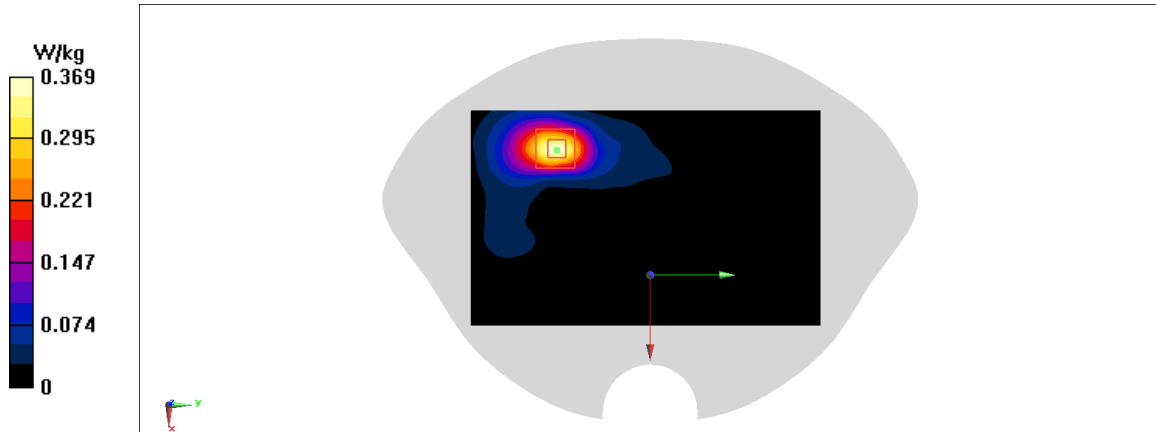

**Fig A.37**

**LTE1700-FDD66\_CH132572 Right Cheek**

Date: 6/8/2020

Electronics: DAE4 Sn777

Medium: head 1750 MHz

 Medium parameters used:  $f = 782 \text{ MHz}$ ;  $\sigma = 0.46 \text{ mho/m}$ ;  $\epsilon_r = 41.84$ ;  $\rho = 1000 \text{ kg/m}^3$ 

 Ambient Temperature:  $22.5^\circ\text{C}$ , Liquid Temperature:  $22.3^\circ\text{C}$ 

Communication System: LTE1700-FDD66 782 MHz Duty Cycle: 1: 1

Probe: EX3DV4 – SN3617 ConvF(8.41,8.41,8.41)

**Area Scan (71x121x1):** Interpolated grid:  $dx=1.000 \text{ mm}$ ,  $dy=1.000 \text{ mm}$ 

 Maximum value of SAR (interpolated) =  $1.53 \text{ W/kg}$ 
**Zoom Scan (7x7x7)/Cube 0:** Measurement grid:  $dx=5\text{mm}$ ,  $dy=5\text{mm}$ ,  $dz=5\text{mm}$ 

 Reference Value =  $12.83 \text{ V/m}$ ; Power Drift =  $0.04 \text{ dB}$ 

 Peak SAR (extrapolated) =  $1.94 \text{ W/kg}$ 
**SAR(1 g) =  $0.896 \text{ W/kg}$ ; SAR(10 g) =  $0.489 \text{ W/kg}$** 

 Maximum value of SAR (measured) =  $1.02 \text{ W/kg}$ 

Fig A.38

**LTE1700-FDD66\_CH132072 Rear**

Date: 6/8/2020

Electronics: DAE4 Sn777

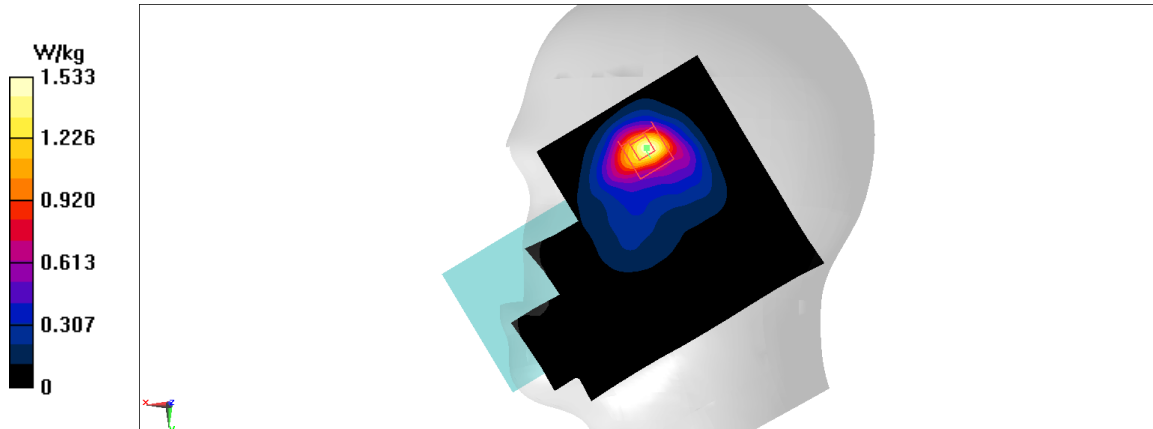
Medium: head 1750 MHz

Medium parameters used:  $f = 782 \text{ MHz}$ ;  $\sigma = 0.46 \text{ mho/m}$ ;  $\epsilon_r = 41.84$ ;  $\rho = 1000 \text{ kg/m}^3$ 

Ambient Temperature: 22.5°C, Liquid Temperature: 22.3°C

Communication System: LTE1700-FDD66 782 MHz Duty Cycle: 1: 1

Probe: EX3DV4 – SN3617 ConvF(8.41,8.41,8.41)

**Area Scan (71x121x1):** Interpolated grid:  $dx=1.000 \text{ mm}$ ,  $dy=1.000 \text{ mm}$ 

Maximum value of SAR (interpolated) = 0.549 W/kg

**Zoom Scan (7x7x7)/Cube 0:** Measurement grid:  $dx=5\text{mm}$ ,  $dy=5\text{mm}$ ,  $dz=5\text{mm}$ 

Reference Value = 10.49 V/m; Power Drift = -0.14 dB

Peak SAR (extrapolated) = 0.649 W/kg

**SAR(1 g) = 0.388 W/kg; SAR(10 g) = 0.218 W/kg**

Maximum value of SAR (measured) = 0.424 W/kg

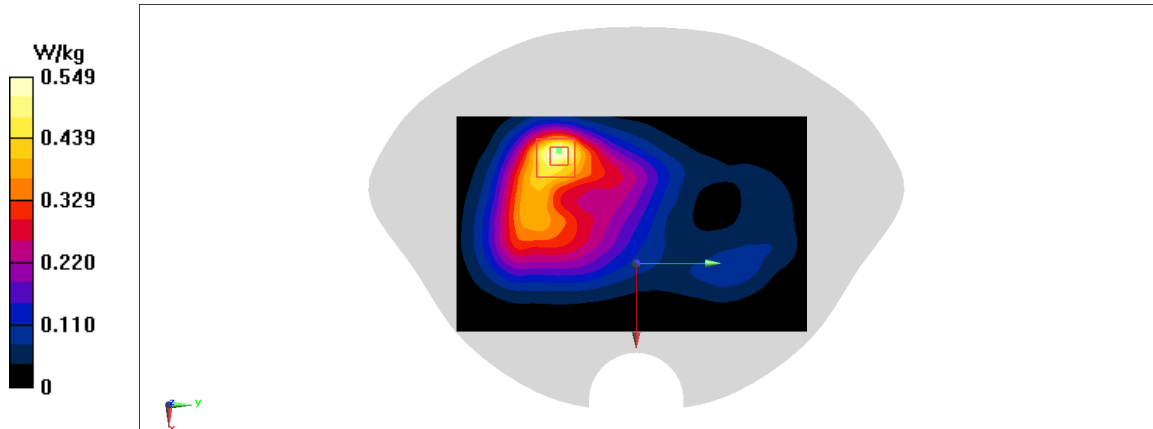

Fig A.39

**LTE1700-FDD66\_CH132072 Rear**

Date: 6/8/2020

Electronics: DAE4 Sn777

Medium: head 1750 MHz

Medium parameters used:  $f = 782 \text{ MHz}$ ;  $\sigma = 0.46 \text{ mho/m}$ ;  $\epsilon_r = 41.84$ ;  $\rho = 1000 \text{ kg/m}^3$

Ambient Temperature:  $22.5^\circ\text{C}$ , Liquid Temperature:  $22.3^\circ\text{C}$

Communication System: LTE1700-FDD66 782 MHz Duty Cycle: 1: 1

Probe: EX3DV4 – SN3617 ConvF(8.41,8.41,8.41)

**Area Scan (71x121x1):** Interpolated grid:  $dx=1.000 \text{ mm}$ ,  $dy=1.000 \text{ mm}$

Maximum value of SAR (interpolated) =  $0.898 \text{ W/kg}$

**Zoom Scan (7x7x7)/Cube 0:** Measurement grid:  $dx=5\text{mm}$ ,  $dy=5\text{mm}$ ,  $dz=5\text{mm}$

Reference Value =  $6.733 \text{ V/m}$ ; Power Drift =  $-0.18 \text{ dB}$

Peak SAR (extrapolated) =  $0.986 \text{ W/kg}$

**SAR(1 g) =  $0.614 \text{ W/kg}$ ; SAR(10 g) =  $0.359 \text{ W/kg}$**

Maximum value of SAR (measured) =  $0.676 \text{ W/kg}$

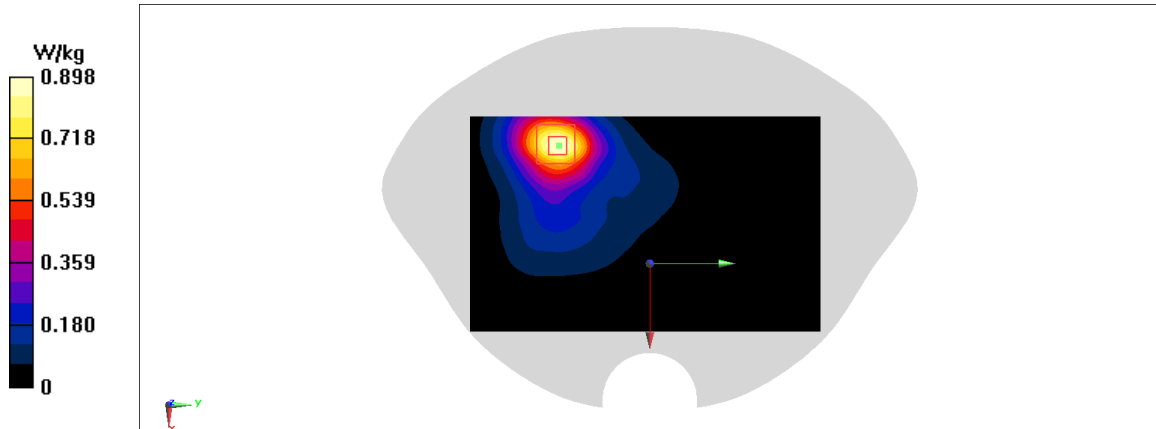

**Fig A.40**

**LTE700-FDD71\_CH133222 Left Cheek**

Date: 6/5/2020

Electronics: DAE4 Sn777

Medium: head 750 MHz

Medium parameters used:  $f = 673$ ;  $\sigma = 0.892$  mho/m;  $\epsilon_r = 42.38$ ;  $\rho = 1000$  kg/m<sup>3</sup>

Ambient Temperature: 22.5°C, Liquid Temperature: 22.3°C

Communication System: LTE700-FDD71 2593 Duty Cycle: 1: 1

Probe: EX3DV4 – SN3617 ConvF(10.07,10.07,10.07)

**Area Scan (71x121x1):** Interpolated grid: dx=1.000 mm, dy=1.000 mm

Maximum value of SAR (interpolated) = 0.741 W/kg

**Zoom Scan (7x7x7)/Cube 0:** Measurement grid: dx=5mm, dy=5mm, dz=5mm

Reference Value = 7.891 V/m; Power Drift = 0.05 dB

Peak SAR (extrapolated) = 1.16 W/kg

**SAR(1 g) = 0.582 W/kg; SAR(10 g) = 0.326 W/kg**

Maximum value of SAR (measured) = 0.597 W/kg

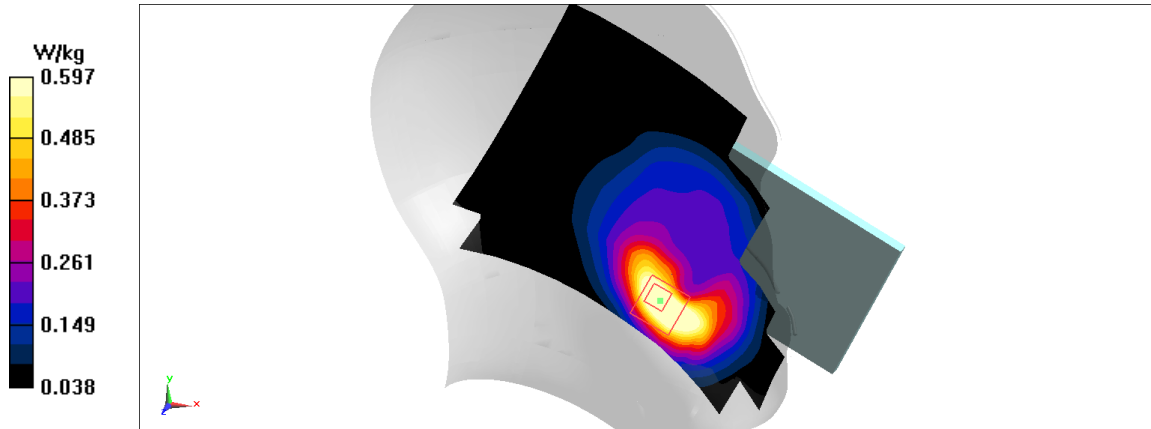

Fig A.41



**LTE700-FDD71\_CH133222 Left**

Date: 6/5/2020

Electronics: DAE4 Sn777

Medium: head 750 MHz

Medium parameters used:  $f = 673$ ;  $\sigma = 0.892$  mho/m;  $\epsilon_r = 42.38$ ;  $\rho = 1000$  kg/m<sup>3</sup>

Ambient Temperature: 22.5°C, Liquid Temperature: 22.3°C

Communication System: LTE700-FDD71 2593 Duty Cycle: 1: 1

Probe: EX3DV4 – SN3617 ConvF(10.07,10.07,10.07)

**Area Scan (71x121x1):** Interpolated grid: dx=1.000 mm, dy=1.000 mm

Maximum value of SAR (interpolated) = 1.27 W/kg

**Zoom Scan (7x7x7)/Cube 0:** Measurement grid: dx=5mm, dy=5mm, dz=5mm

Reference Value = 37.29 V/m; Power Drift = -0.11 dB

Peak SAR (extrapolated) = 1.34 W/kg

**SAR(1 g) = 0.851 W/kg; SAR(10 g) = 0.521 W/kg**

Maximum value of SAR (measured) = 0.937 W/kg

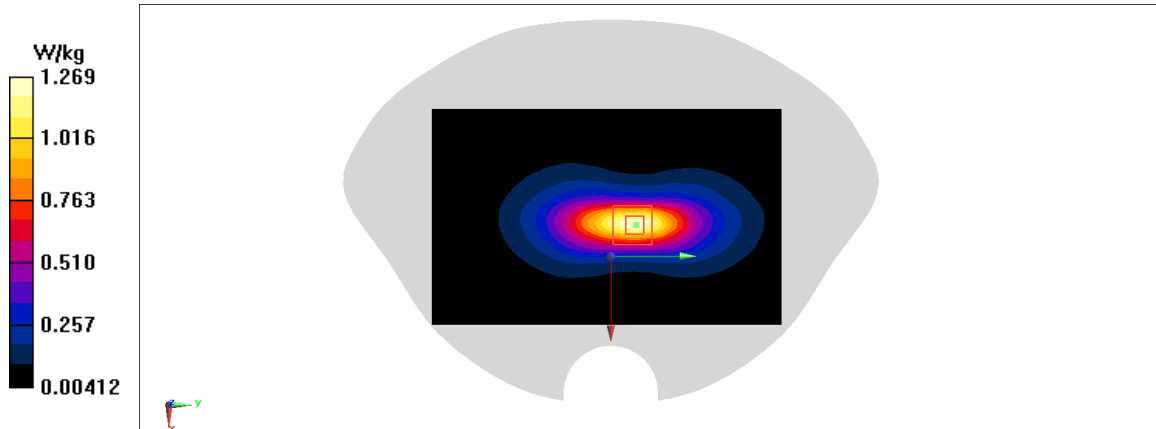
**Fig A.42**

**WLAN2450\_CH11 Left Cheek**

Date: 6/13/2020

Electronics: DAE4 Sn777

Medium: head 2450 MHz

Medium parameters used:  $f = 2462$ ;  $\sigma = 1.795$  mho/m;  $\epsilon_r = 39.04$ ;  $\rho = 1000$  kg/m<sup>3</sup>

Ambient Temperature: 22.5°C, Liquid Temperature: 22.3°C

Communication System: WLAN2450 2462 Duty Cycle: 1: 1

Probe: EX3DV4 – SN3617 ConvF(7.65,7.65,7.65)

**Area Scan (71x121x1):** Interpolated grid: dx=1.000 mm, dy=1.000 mm

Maximum value of SAR (interpolated) = 1.44 W/kg

**Zoom Scan (7x7x7)/Cube 0:** Measurement grid: dx=5mm, dy=5mm, dz=5mm

Reference Value = 10.87 V/m; Power Drift = 0.04 dB

Peak SAR (extrapolated) = 1.55 W/kg

**SAR(1 g) = 0.683 W/kg; SAR(10 g) = 0.335 W/kg**

Maximum value of SAR (measured) = 0.745 W/kg

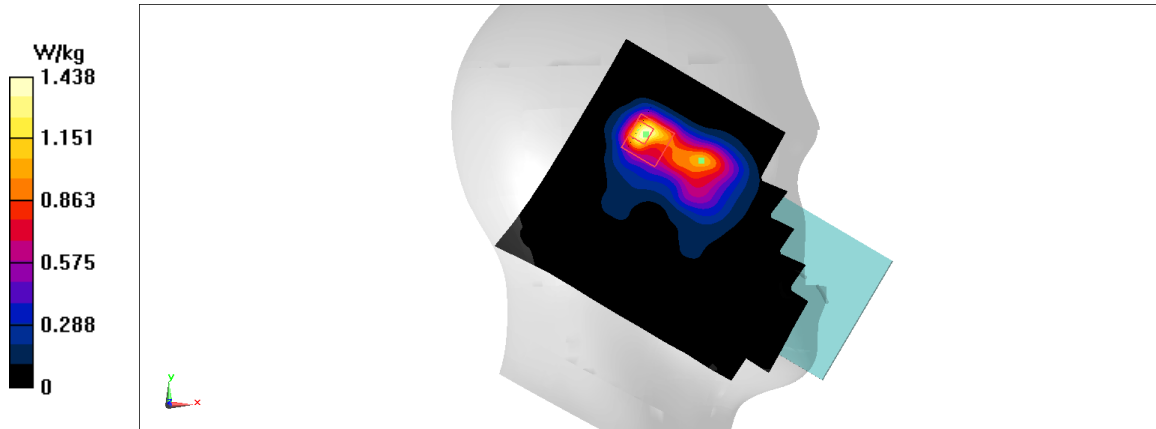

Fig A.43

**WLAN2450\_CH11 Rear**

Date: 6/13/2020

Electronics: DAE4 Sn777

Medium: head 2450 MHz

Medium parameters used:  $f = 2462$ ;  $\sigma = 1.795$  mho/m;  $\epsilon_r = 39.04$ ;  $\rho = 1000$  kg/m<sup>3</sup>

Ambient Temperature: 22.5°C, Liquid Temperature: 22.3°C

Communication System: WLAN2450 2462 Duty Cycle: 1: 1

Probe: EX3DV4 – SN3617 ConvF(7.65,7.65,7.65)

**Area Scan (71x121x1):** Interpolated grid: dx=1.000 mm, dy=1.000 mm

Maximum value of SAR (interpolated) = 0.227 W/kg

**Zoom Scan (7x7x7)/Cube 0:** Measurement grid: dx=5mm, dy=5mm, dz=5mm

Reference Value = 11.35 V/m; Power Drift = -0.11 dB

Peak SAR (extrapolated) = 0.265 W/kg

**SAR(1 g) = 0.124 W/kg; SAR(10 g) = 0.062 W/kg**

Maximum value of SAR (measured) = 0.144 W/kg

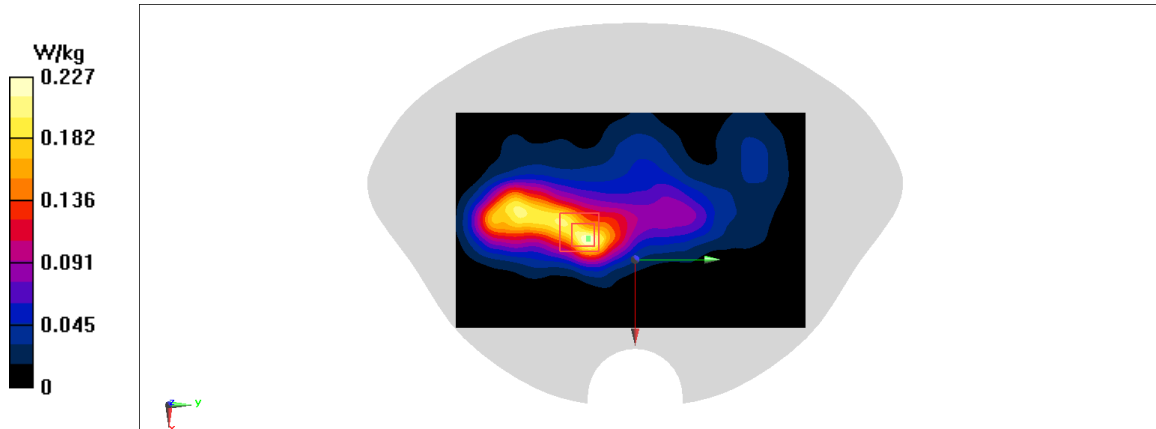
**Fig A.44**

**WLAN 5G\_CH153 Left Cheek**

Date: 6/19/2020

Electronics: DAE4 Sn777

Medium: head 5750 MHz

Medium parameters used:  $f = 5765$ ;  $\sigma = 4.677$  mho/m;  $\epsilon_r = 35.57$ ;  $\rho = 1000$  kg/m<sup>3</sup>

Ambient Temperature: 22.5°C, Liquid Temperature: 22.3°C

Communication System: WLAN 5G 5765 Duty Cycle: 1:1

Probe: EX3DV4 – SN3617 ConvF(5.10,5.10,5.10)

**Area Scan (71x121x1):** Interpolated grid: dx=1.000 mm, dy=1.000 mm

Maximum value of SAR (interpolated) = 0.449 W/kg

**Zoom Scan (7x7x7)/Cube 0:** Measurement grid: dx=5mm, dy=5mm, dz=5mm

Reference Value = 4.693 V/m; Power Drift = 0.12 dB

Peak SAR (extrapolated) = 0.74 W/kg

**SAR(1 g) = 0.182 W/kg; SAR(10 g) = 0.065 W/kg**

Maximum value of SAR (measured) = 0.181 W/kg

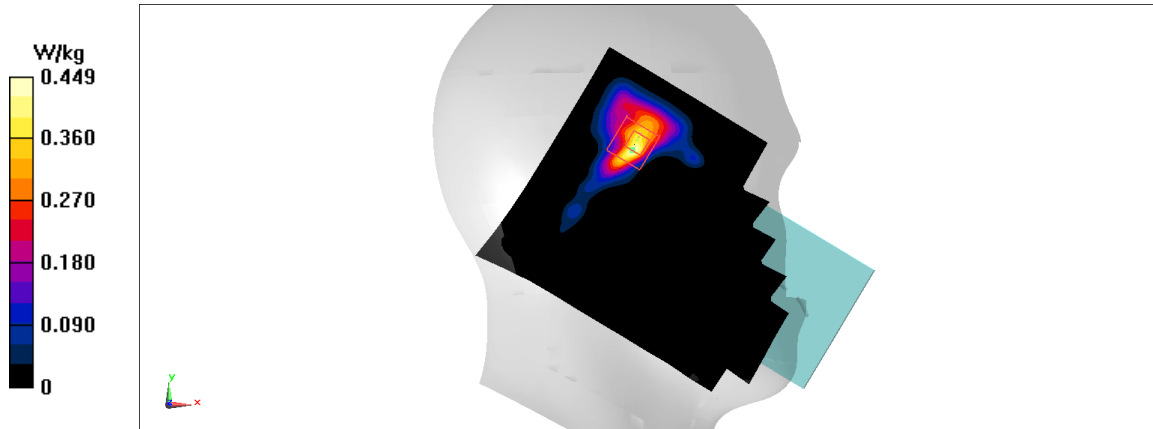

Fig A.45

**WLAN 5G\_CH52 Rear**

Date: 6/17/2020

Electronics: DAE4 Sn777

Medium: head 5250 MHz

Medium parameters used:  $f = 5260$ ;  $\sigma = 5.344$  mho/m;  $\epsilon_r = 35.33$ ;  $\rho = 1000$  kg/m<sup>3</sup>

Ambient Temperature: 22.5°C, Liquid Temperature: 22.3°C

Communication System: WLAN 5G 5260 Duty Cycle: 1:1

Probe: EX3DV4 – SN3617 ConvF(5.39,5.39,5.39)

**Area Scan (71x121x1):** Interpolated grid: dx=1.000 mm, dy=1.000 mm

Maximum value of SAR (interpolated) = 0.925 W/kg

**Zoom Scan (7x7x7)/Cube 0:** Measurement grid: dx=5mm, dy=5mm, dz=5mm

Reference Value = 4.251 V/m; Power Drift = 0.1 dB

Peak SAR (extrapolated) = 2.12 W/kg

**SAR(1 g) = 0.511 W/kg; SAR(10 g) = 0.162 W/kg**

Maximum value of SAR (measured) = 0.529 W/kg

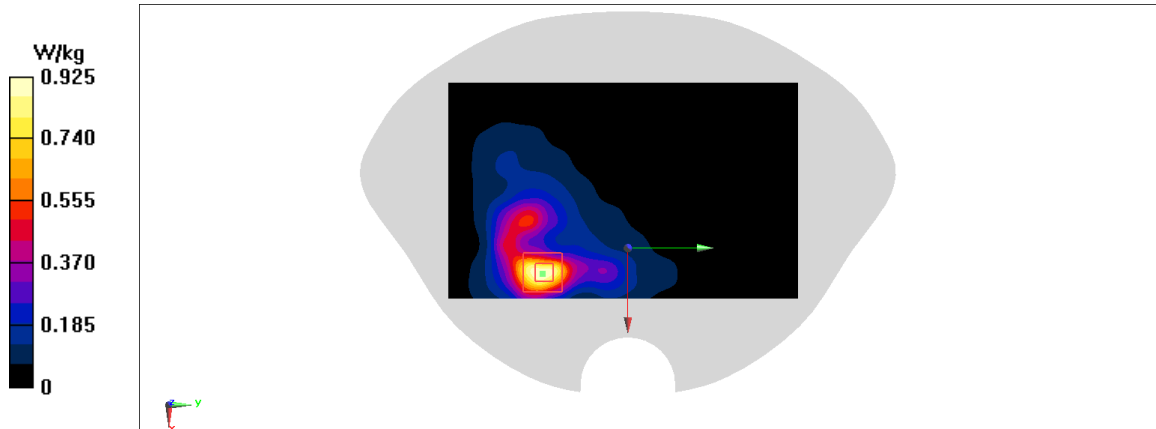

Fig A.46

**n2\_CH372000 Right Cheek**

Date: 6/12/2020

Electronics: DAE4 Sn777

Medium: head 1900 MHz

Medium parameters used:  $f = 1860$  MHz;  $\sigma = 1.374$  mho/m;  $\epsilon_r = 39.47$ ;  $\rho = 1000$  kg/m<sup>3</sup>

Ambient Temperature: 22.5°C, Liquid Temperature: 22.3°C

Communication System: n2 37190 MHz Duty Cycle: 1:1

Probe: EX3DV4 – SN3617 ConvF(8.14,8.14,8.14)

**Area Scan (71x121x1):** Interpolated grid: dx=1.000 mm, dy=1.000 mm

Maximum value of SAR (interpolated) = 1.21 W/kg

**Zoom Scan (7x7x7)/Cube 0:** Measurement grid: dx=5mm, dy=5mm, dz=5mm

Reference Value = 12.33 V/m; Power Drift = 0.05 dB

Peak SAR (extrapolated) = 1.56 W/kg

**SAR(1 g) = 0.749 W/kg; SAR(10 g) = 0.356 W/kg**

Maximum value of SAR (measured) = 0.785 W/kg

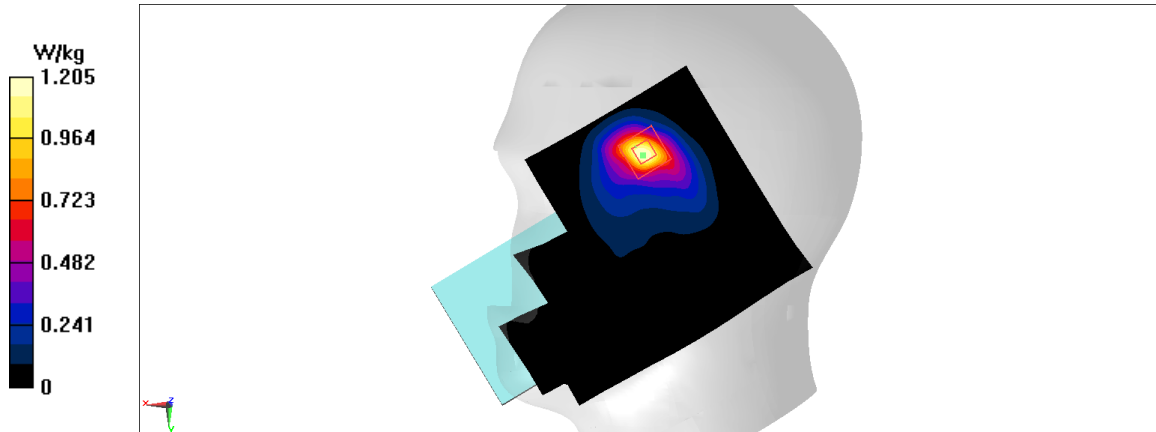

Fig A.47

**n2\_CH372000 Left**

Date: 6/12/2020

Electronics: DAE4 Sn777

Medium: head 1900 MHz

Medium parameters used:  $f = 1860$  MHz;  $\sigma = 1.374$  mho/m;  $\epsilon_r = 39.47$ ;  $\rho = 1000$  kg/m<sup>3</sup>

Ambient Temperature: 22.5°C, Liquid Temperature: 22.3°C

Communication System: n2 37190 MHz Duty Cycle: 1:1

Probe: EX3DV4 – SN3617 ConvF(8.14,8.14,8.14)

**Area Scan (71x121x1):** Interpolated grid: dx=1.000 mm, dy=1.000 mm

Maximum value of SAR (interpolated) = 1.12 W/kg

**Zoom Scan (7x7x7)/Cube 0:** Measurement grid: dx=5mm, dy=5mm, dz=5mm

Reference Value = 11.58 V/m; Power Drift = 0.13 dB

Peak SAR (extrapolated) = 1.28 W/kg

**SAR(1 g) = 0.698 W/kg; SAR(10 g) = 0.355 W/kg**

Maximum value of SAR (measured) = 0.793 W/kg

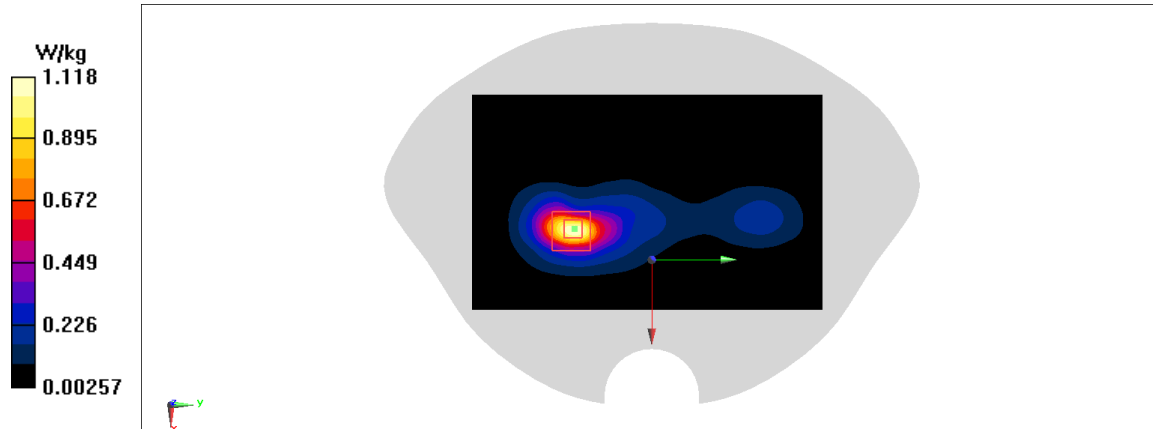

Fig A.48

**n2 \_CH372000 Rear**

Date: 6/12/2020

Electronics: DAE4 Sn777

Medium: head 1900 MHz

Medium parameters used:  $f = 1880$  MHz;  $\sigma = 1.4$  mho/m;  $\epsilon_r = 39.37$ ;  $\rho = 1000$  kg/m<sup>3</sup>

Ambient Temperature: 22.5°C, Liquid Temperature: 22.3°C

Communication System: n2 37190 MHz Duty Cycle: 1:1

Probe: EX3DV4 – SN3617 ConvF(8.14,8.14,8.14)

**Area Scan (71x121x1):** Interpolated grid: dx=1.000 mm, dy=1.000 mm

Maximum value of SAR (interpolated) = 0.553 W/kg

**Zoom Scan (7x7x7)/Cube 0:** Measurement grid: dx=5mm, dy=5mm, dz=5mm

Reference Value = 10.9 V/m; Power Drift = -0.03 dB

Peak SAR (extrapolated) = 0.608 W/kg

**SAR(1 g) = 0.367 W/kg; SAR(10 g) = 0.211 W/kg**

Maximum value of SAR (measured) = 0.401 W/kg

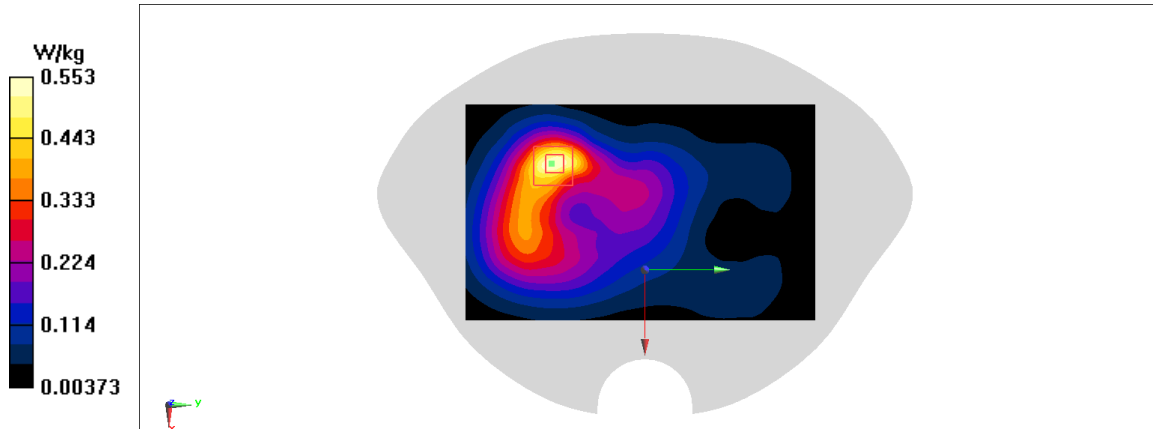

**Fig A.49**



**n25 \_CH376500 Right Cheek**

Date: 6/12/2020

Electronics: DAE4 Sn777

Medium: head 1900 MHz

Medium parameters used:  $f = 1882.5$  MHz;  $\sigma = 1.407$  mho/m;  $\epsilon_r = 39.38$ ;  $\rho = 1000$  kg/m<sup>3</sup>

Ambient Temperature: 22.5°C, Liquid Temperature: 22.3°C

Communication System: n25 36896 MHz Duty Cycle: 1:1

Probe: EX3DV4 – SN3617 ConvF(8.14,8.14,8.14)

**Area Scan (71x121x1):** Interpolated grid: dx=1.000 mm, dy=1.000 mm

Maximum value of SAR (interpolated) = 0.152 W/kg

**Zoom Scan (7x7x7)/Cube 0:** Measurement grid: dx=5mm, dy=5mm, dz=5mm

Reference Value = 3.773 V/m; Power Drift = -0.01 dB

Peak SAR (extrapolated) = 0.152 W/kg

**SAR(1 g) = 0.062 W/kg; SAR(10 g) = 0.04 W/kg**

Maximum value of SAR (measured) = 0.111 W/kg

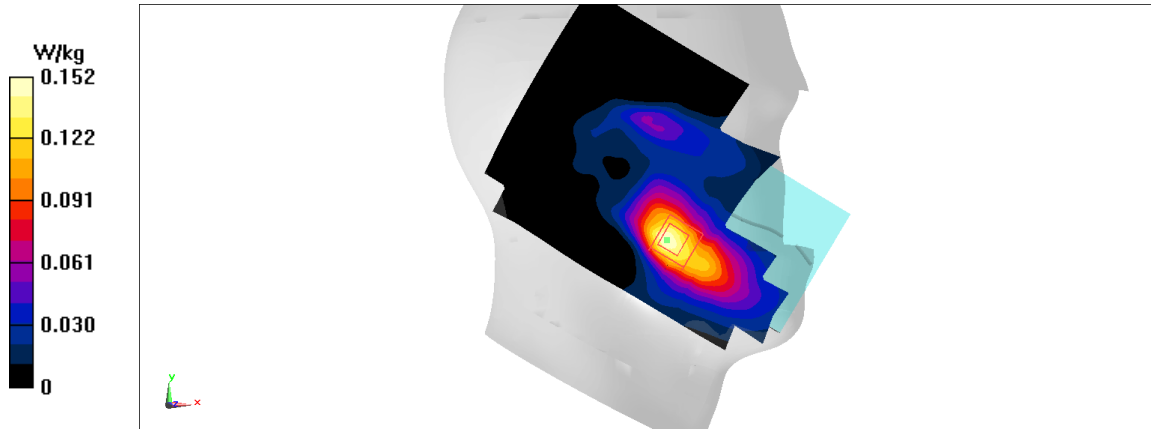

Fig A.50

**n25\_CH382500 Rear**

Date: 6/12/2020

Electronics: DAE4 Sn777

Medium: head 1900 MHz

Medium parameters used:  $f = 1912.5$  MHz;  $\sigma = 1.425$  mho/m;  $\epsilon_r = 39.32$ ;  $\rho = 1000$  kg/m<sup>3</sup>

Ambient Temperature: 22.5°C, Liquid Temperature: 22.3°C

Communication System: n25 37496 MHz Duty Cycle: 1:1

Probe: EX3DV4 – SN3617 ConvF(8.14,8.14,8.14)

**Area Scan (71x121x1):** Interpolated grid: dx=1.000 mm, dy=1.000 mm

Maximum value of SAR (interpolated) = 1.03 W/kg

**Zoom Scan (7x7x7)/Cube 0:** Measurement grid: dx=5mm, dy=5mm, dz=5mm

Reference Value = 7.27 V/m; Power Drift = 0.03 dB

Peak SAR (extrapolated) = 1.13 W/kg

**SAR(1 g) = 0.663 W/kg; SAR(10 g) = 0.366 W/kg**

Maximum value of SAR (measured) = 0.739 W/kg

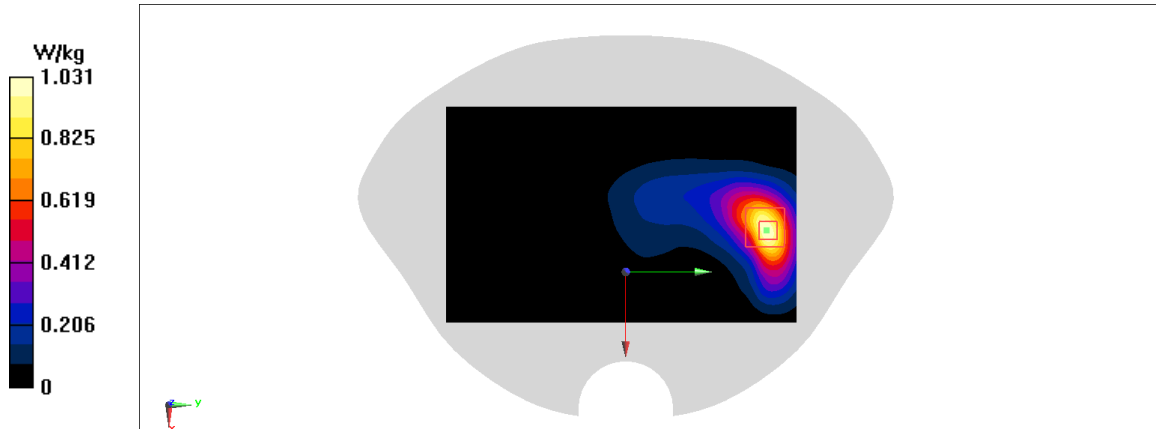

Fig A.51

**n41\_CH513900 Left Cheek**

Date: 6/16/2020

Electronics: DAE4 Sn777

Medium: head 2600 MHz

Medium parameters used:  $f = 2569.5$ ;  $\sigma = 1.926$  mho/m;  $\epsilon_r = 38.59$ ;  $\rho = 1000$  kg/m<sup>3</sup>

Ambient Temperature: 22.5°C, Liquid Temperature: 22.3°C

Communication System: n41 2569.5 Duty Cycle: 1:1

Probe: EX3DV4 – SN3617 ConvF(7.52,7.52,7.52)

**Area Scan (71x121x1):** Interpolated grid: dx=1.000 mm, dy=1.000 mm

Maximum value of SAR (interpolated) = 0.199 W/kg

**Zoom Scan (7x7x7)/Cube 0:** Measurement grid: dx=5mm, dy=5mm, dz=5mm

Reference Value = 1.851 V/m; Power Drift = 0.03 dB

Peak SAR (extrapolated) = 0.248 W/kg

**SAR(1 g) = 0.132 W/kg; SAR(10 g) = 0.07 W/kg**

Maximum value of SAR (measured) = 0.142 W/kg

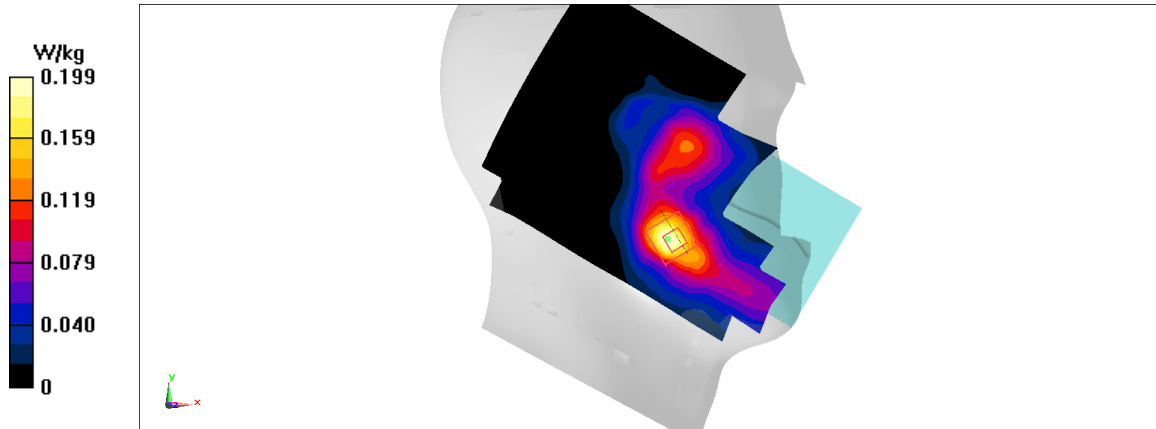

Fig A.52

**n41\_CH509202 Rear**

Date: 6/16/2020

Electronics: DAE4 Sn777

Medium: head 2600 MHz

Medium parameters used:  $f = 2546.01$ ;  $\sigma = 1.913$  mho/m;  $\epsilon_r = 38.75$ ;  $\rho = 1000$  kg/m<sup>3</sup>

Ambient Temperature: 22.5°C, Liquid Temperature: 22.3°C

Communication System: n41 2546.01 Duty Cycle: 1:1

Probe: EX3DV4 – SN3617 ConvF(7.52,7.52,7.52)

**Area Scan (71x121x1):** Interpolated grid: dx=1.000 mm, dy=1.000 mm

Maximum value of SAR (interpolated) = 1.19 W/kg

**Zoom Scan (7x7x7)/Cube 0:** Measurement grid: dx=5mm, dy=5mm, dz=5mm

Reference Value = 5.48 V/m; Power Drift = 0.13 dB

Peak SAR (extrapolated) = 1.55 W/kg

**SAR(1 g) = 0.748 W/kg; SAR(10 g) = 0.384 W/kg**

Maximum value of SAR (measured) = 1.24 W/kg

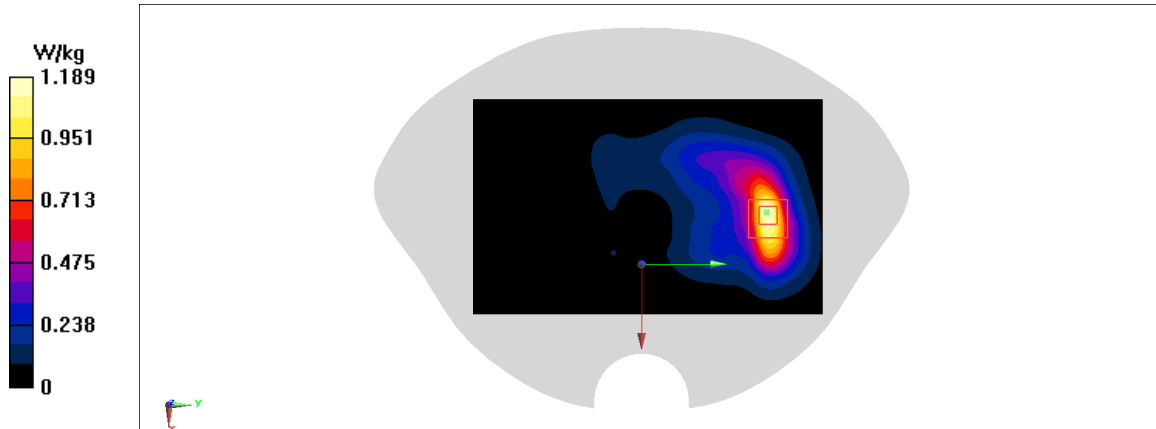
**Fig A.53**

**n66\_CH344000 Right Cheek**

Date: 6/9/2020

Electronics: DAE4 Sn777

Medium: head 1750 MHz

Medium parameters used:  $f = 1770$ ;  $\sigma = 1.402$  mho/m;  $\epsilon_r = 39.79$  ;  $\rho = 1000$  kg/m<sup>3</sup>

Ambient Temperature: 22.5°C, Liquid Temperature: 22.3°C

Communication System: LTE1700-FDD66 2593 Duty Cycle: 1: 1

Probe: EX3DV4 – SN3617 ConvF(8.41,8.41,8.41)

**Area Scan (71x121x1):** Interpolated grid: dx=1.000 mm, dy=1.000 mm

Maximum value of SAR (interpolated) = 1 W/kg

**Zoom Scan (7x7x7)/Cube 0:** Measurement grid: dx=5mm, dy=5mm, dz=5mm

Reference Value = 10.86 V/m; Power Drift = 0.08 dB

Peak SAR (extrapolated) = 1.2 W/kg

**SAR(1 g) = 0.615 W/kg; SAR(10 g) = 0.309 W/kg**

Maximum value of SAR (measured) = 0.685 W/kg

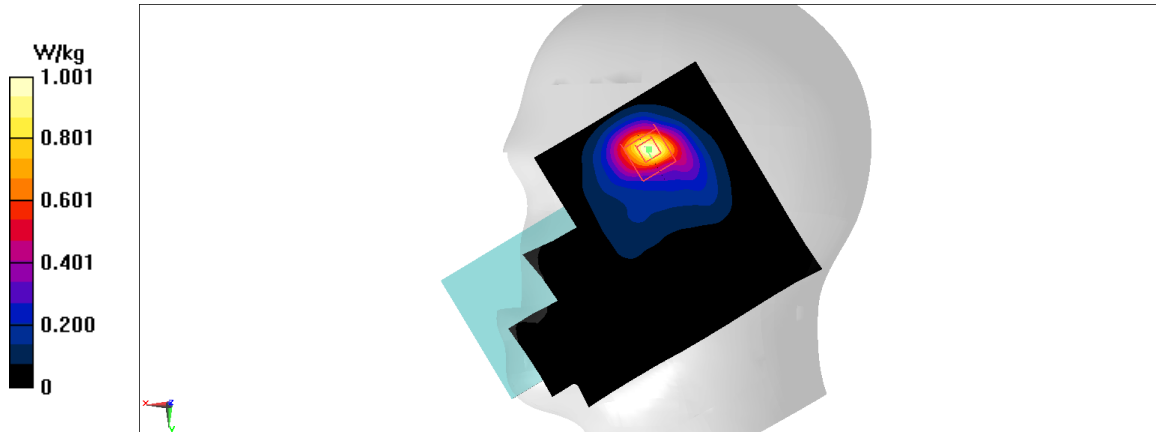

Fig A.54

**n66\_CH344000 Left**

Date: 6/9/2020

Electronics: DAE4 Sn777

Medium: head 1750 MHz

Medium parameters used:  $f = 1720$ ;  $\sigma = 1.367$  mho/m;  $\epsilon_r = 39.92$ ;  $\rho = 1000$  kg/m<sup>3</sup>

Ambient Temperature: 22.5°C, Liquid Temperature: 22.3°C

Communication System: LTE1700-FDD66 2593 Duty Cycle: 1: 1

Probe: EX3DV4 – SN3617 ConvF(8.41,8.41,8.41)

**Area Scan (71x121x1):** Interpolated grid: dx=1.000 mm, dy=1.000 mm

Maximum value of SAR (interpolated) = 0.829 W/kg

**Zoom Scan (7x7x7)/Cube 0:** Measurement grid: dx=5mm, dy=5mm, dz=5mm

Reference Value = 6.576 V/m; Power Drift = -0.08 dB

Peak SAR (extrapolated) = 0.9 W/kg

**SAR(1 g) = 0.509 W/kg; SAR(10 g) = 0.264 W/kg**

Maximum value of SAR (measured) = 0.581 W/kg

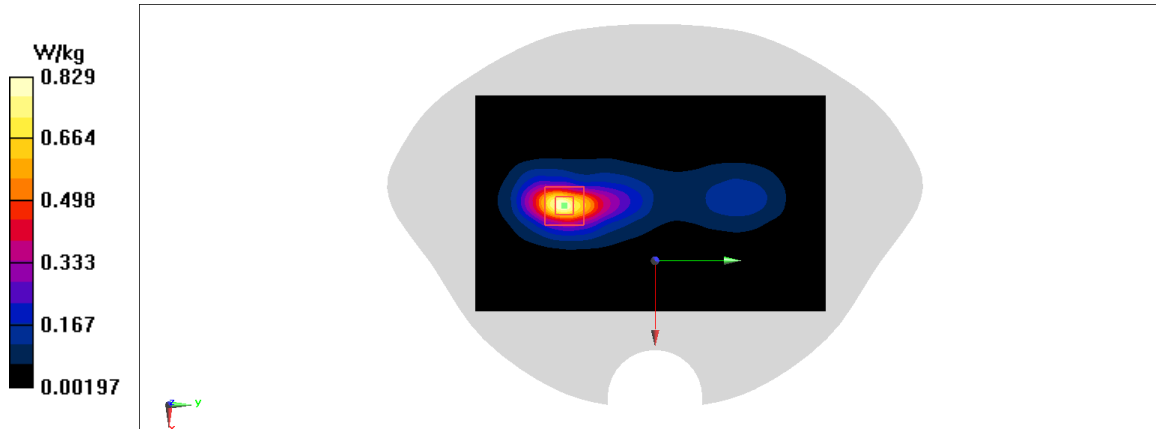

**Fig A.55**

**n66\_CH349000 Rear**

Date: 6/9/2020

Electronics: DAE4 Sn777

Medium: head 1750 MHz

Medium parameters used:  $f = 1720$ ;  $\sigma = 1.367$  mho/m;  $\epsilon_r = 39.92$ ;  $\rho = 1000$  kg/m<sup>3</sup>

Ambient Temperature: 22.5°C, Liquid Temperature: 22.3°C

Communication System: LTE1700-FDD66 2593 Duty Cycle: 1: 1

Probe: EX3DV4 – SN3617 ConvF(8.41,8.41,8.41)

**Area Scan (71x121x1):** Interpolated grid: dx=1.000 mm, dy=1.000 mm

Maximum value of SAR (interpolated) = 0.415 W/kg

**Zoom Scan (7x7x7)/Cube 0:** Measurement grid: dx=5mm, dy=5mm, dz=5mm

Reference Value = 8.444 V/m; Power Drift = 0 dB

Peak SAR (extrapolated) = 0.462 W/kg

**SAR(1 g) = 0.293 W/kg; SAR(10 g) = 0.176 W/kg**

Maximum value of SAR (measured) = 0.317 W/kg

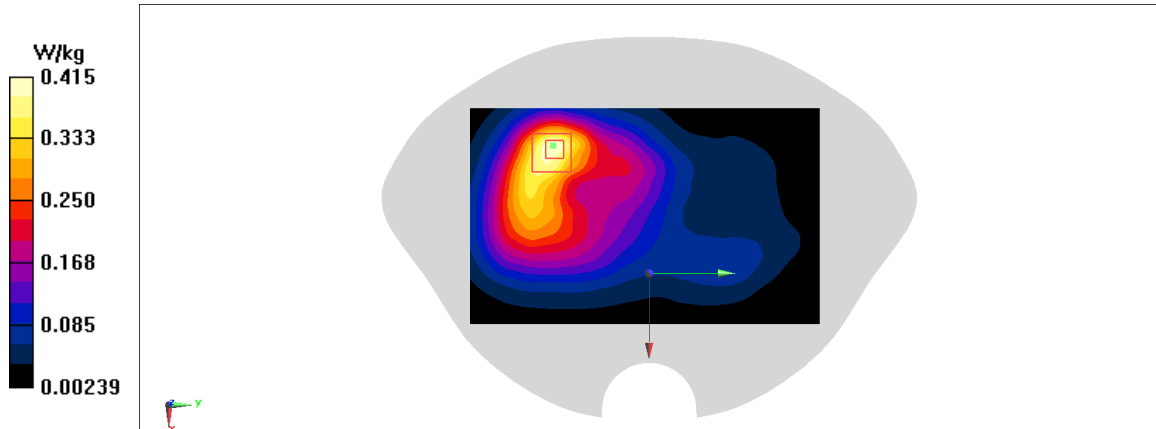

**Fig A.56**

**n71\_CHI34600 Left Cheek**

Date: 6/5/2020

Electronics: DAE4 Sn777

Medium: head 750 MHz

Medium parameters used:  $f = 673$ ;  $\sigma = 0.892$  mho/m;  $\epsilon_r = 42.38$ ;  $\rho = 1000$  kg/m<sup>3</sup>

Ambient Temperature: 22.5°C, Liquid Temperature: 22.3°C

Communication System: 5G700-n71 2593 Duty Cycle: 1: 1

Probe: EX3DV4 – SN3617 ConvF(10.07,10.07,10.07)

**Area Scan (71x121x1):** Interpolated grid: dx=1.000 mm, dy=1.000 mm

Maximum value of SAR (interpolated) = 0.687 W/kg

**Zoom Scan (7x7x7)/Cube 0:** Measurement grid: dx=5mm, dy=5mm, dz=5mm

Reference Value = 8.982 V/m; Power Drift = 0.05 dB

Peak SAR (extrapolated) = 0.972 W/kg

**SAR(1 g) = 0.495 W/kg; SAR(10 g) = 0.272 W/kg**

Maximum value of SAR (measured) = 0.495 W/kg

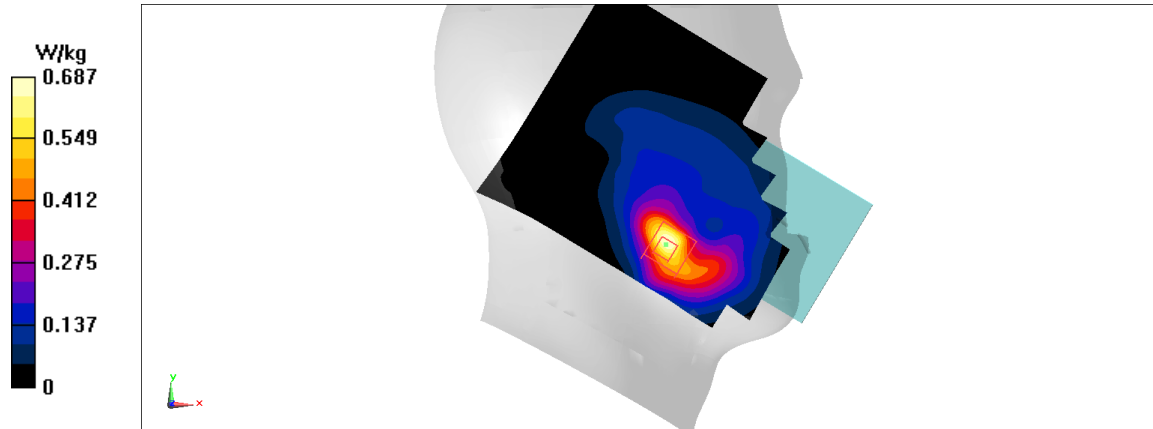

Fig A.57



**n71\_CH134600 Left**

Date: 6/5/2020

Electronics: DAE4 Sn777

Medium: head 750 MHz

Medium parameters used:  $f = 673$ ;  $\sigma = 0.892$  mho/m;  $\epsilon_r = 42.38$ ;  $\rho = 1000$  kg/m<sup>3</sup>

Ambient Temperature: 22.5°C, Liquid Temperature: 22.3°C

Communication System: 5G700-n71 2593 Duty Cycle: 1: 1

Probe: EX3DV4 – SN3617 ConvF(10.07,10.07,10.07)

**Area Scan (71x121x1):** Interpolated grid: dx=1.000 mm, dy=1.000 mm

Maximum value of SAR (interpolated) = 0.749 W/kg

**Zoom Scan (7x7x7)/Cube 0:** Measurement grid: dx=5mm, dy=5mm, dz=5mm

Reference Value = 14 V/m; Power Drift = 0.04 dB

Peak SAR (extrapolated) = 0.816 W/kg

**SAR(1 g) = 0.455 W/kg; SAR(10 g) = 0.253 W/kg**

Maximum value of SAR (measured) = 0.51 W/kg

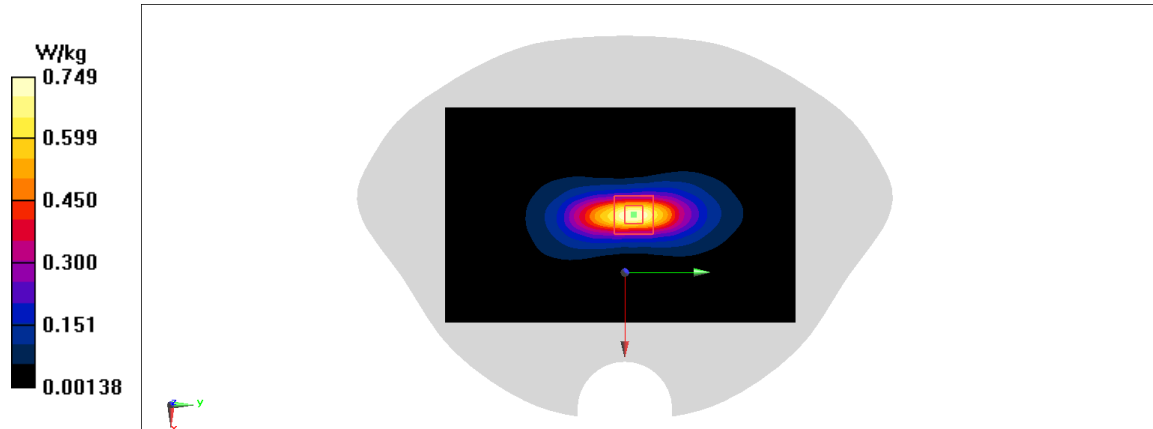

Fig A.58

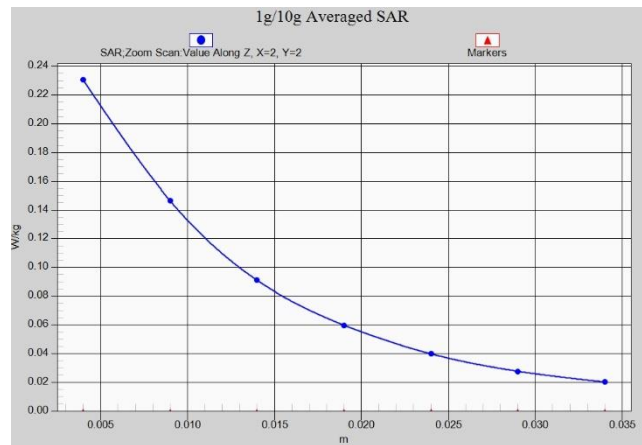

Fig. 1-1 Z-Scan at power reference point (850 MHz)

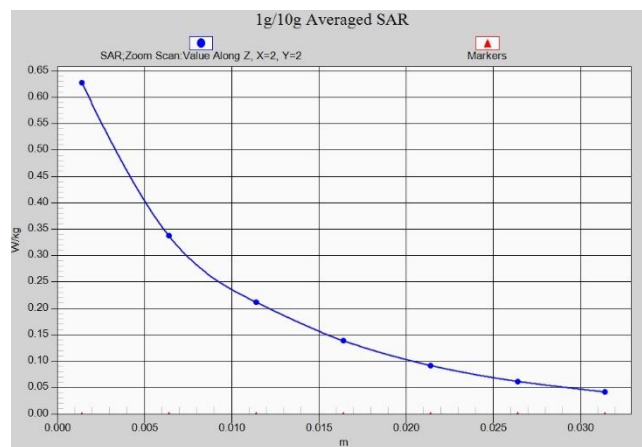

Fig. 1-2 Z-Scan at power reference point (850 MHz)

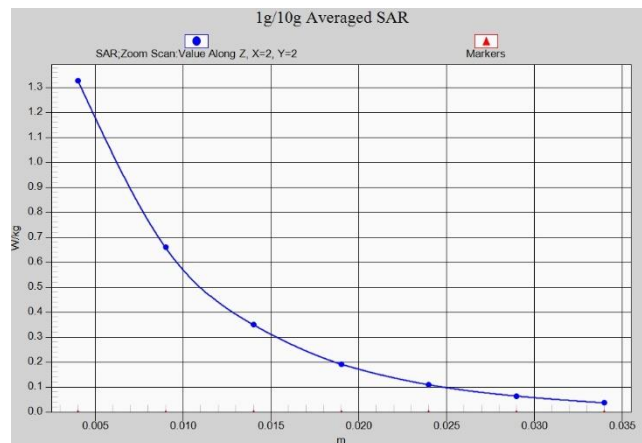

Fig. 1-3 Z-Scan at power reference point (1900 MHz)

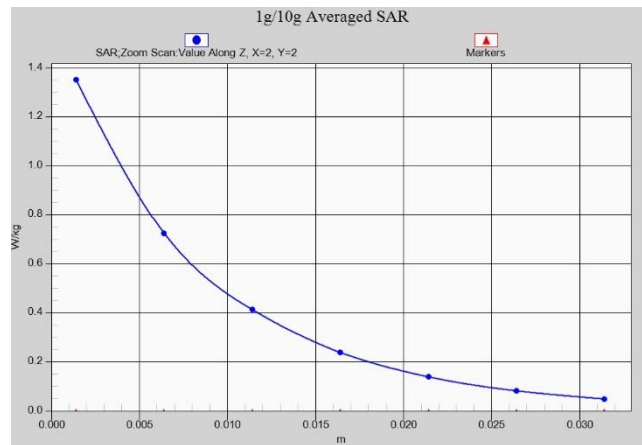

Fig. 1-4 Z-Scan at power reference point (1900 MHz)

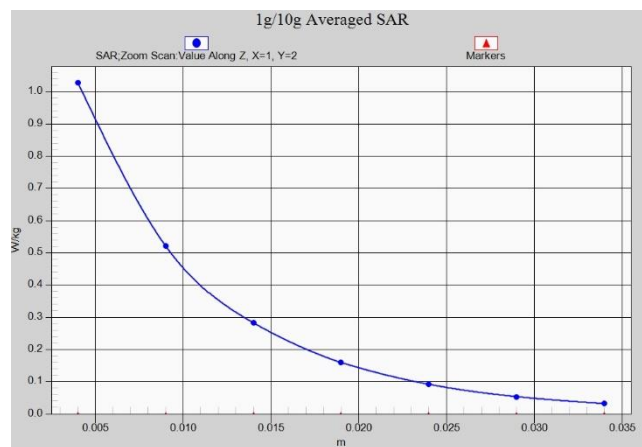

Fig. 1-5 Z-Scan at power reference point (WCDMA1900)

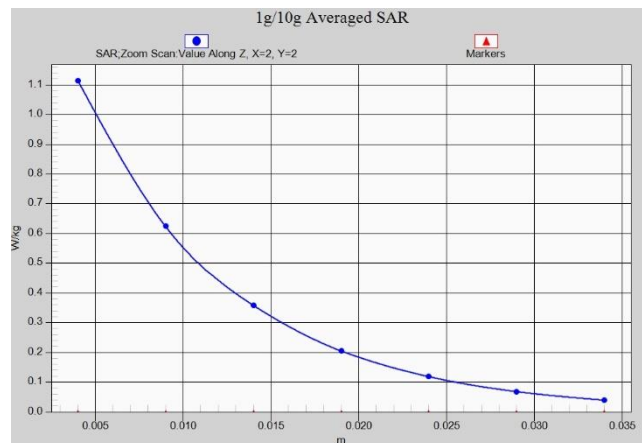
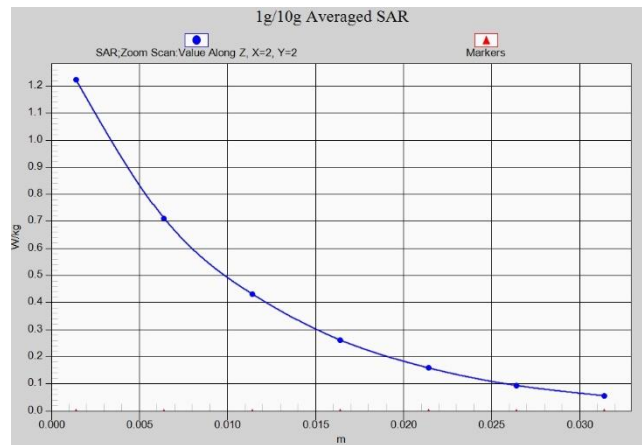
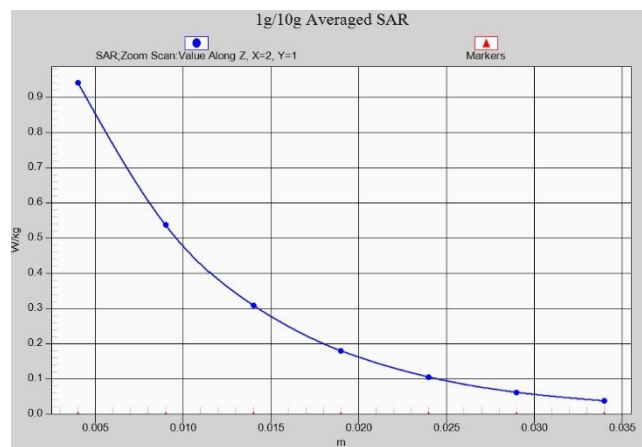

Fig. 1-6 Z-Scan at power reference point (WCDMA1900)



**Fig. 1-7 Z-Scan at power reference point (WCDMA1900)**



**Fig. 1-8 Z-Scan at power reference point (WCDMA1700)**

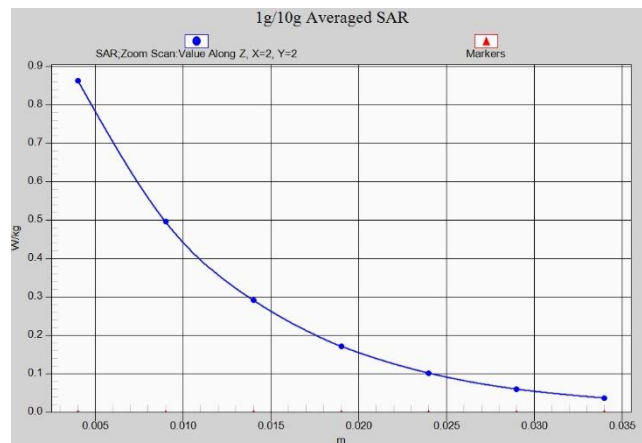

**Fig. 1-9 Z-Scan at power reference point (WCDMA1700)**

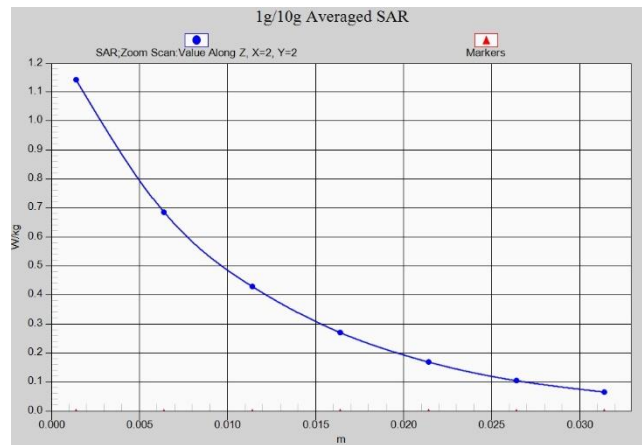

**Fig. 1-10 Z-Scan at power reference point (WCDMA1700)**

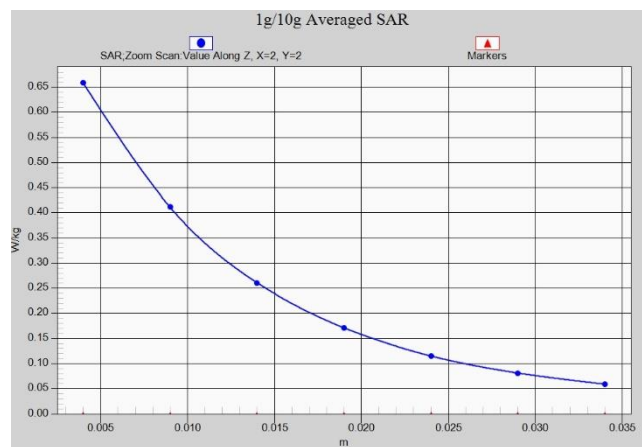

**Fig. 1-11 Z-Scan at power reference point (WCDMA850)**

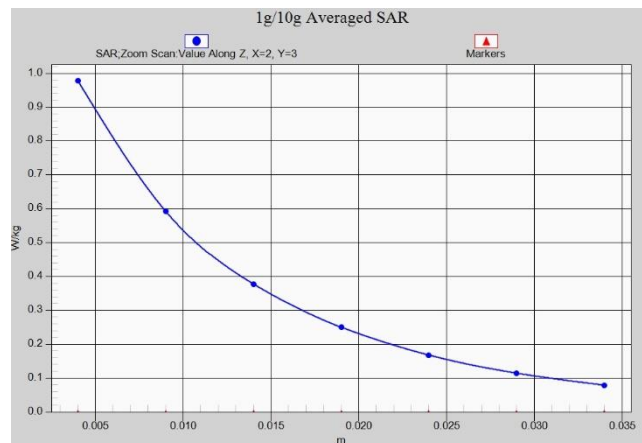

**Fig. 1-12 Z-Scan at power reference point (WCDMA850)**

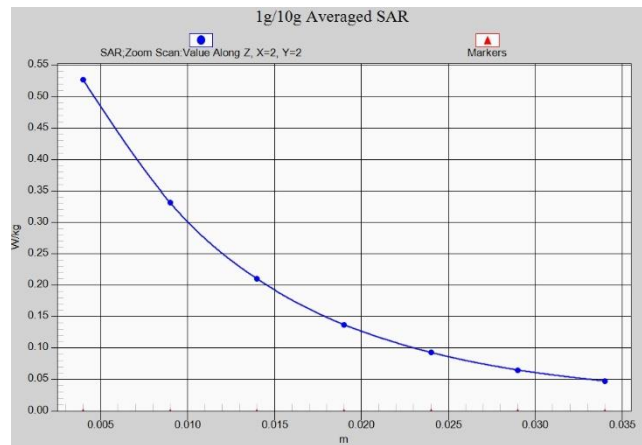

Fig. 1-13 Z-Scan at power reference point (CDMA BC0)

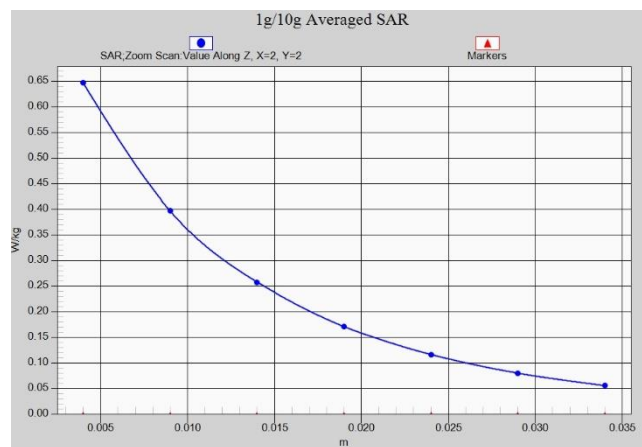

Fig. 1-14 Z-Scan at power reference point (CDMA BC0)

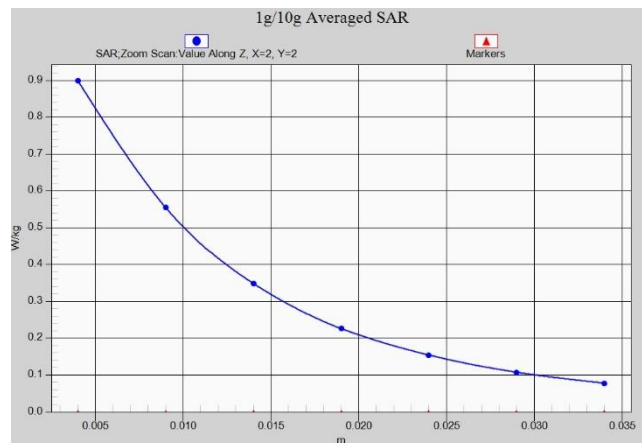

Fig. 1-15 Z-Scan at power reference point (CDMA BC1)

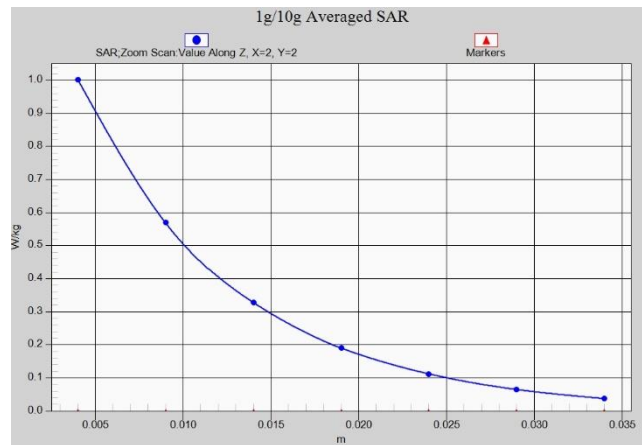

Fig. 1-16 Z-Scan at power reference point (CDMA BC1)

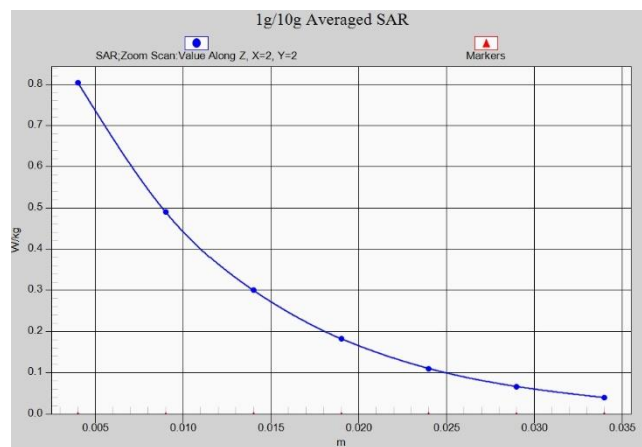

Fig. 1-17 Z-Scan at power reference point (CDMA BC1)

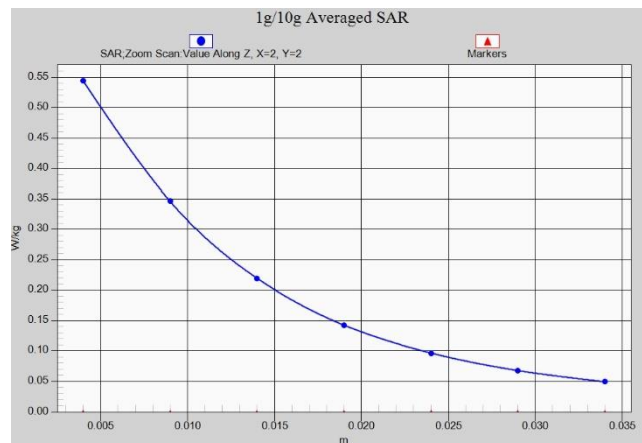

Fig. 1-18 Z-Scan at power reference point (CDMA BC10)