

Fig. 54 Conducted Spurious Emission (802.11n-HT40, Ch151, 25 GHz-40 GHz)

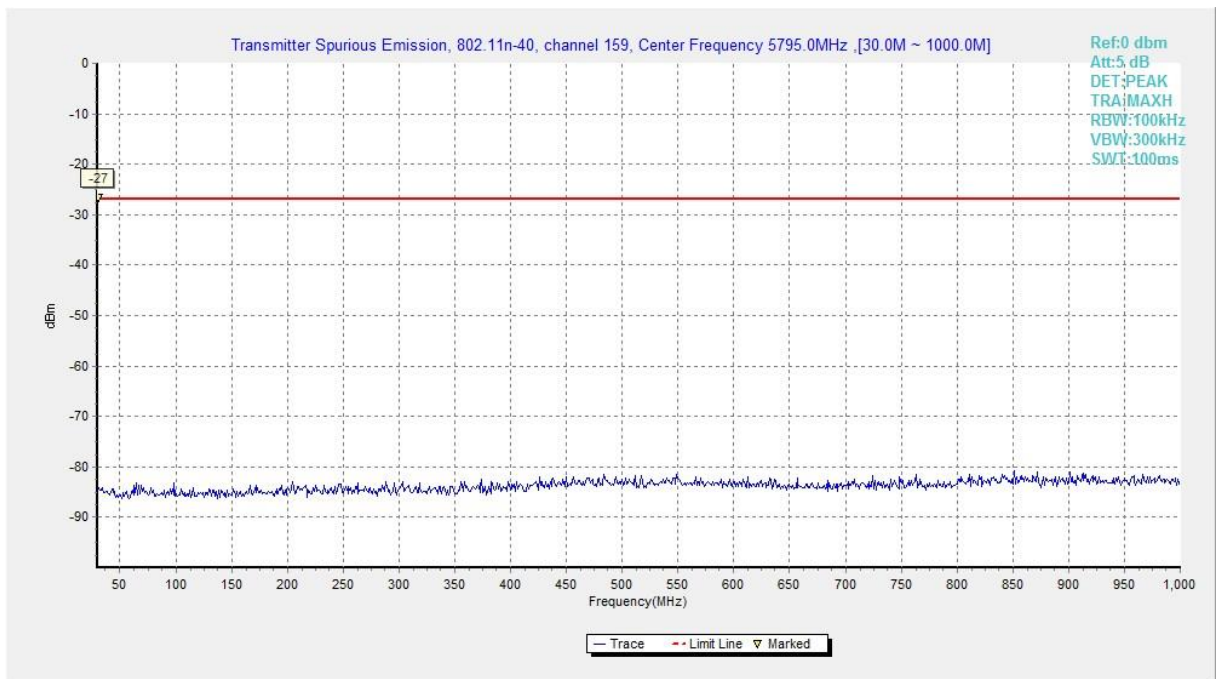

Fig. 55 Conducted Spurious Emission (802.11n-HT40, Ch159, 30 MHz-1 GHz)

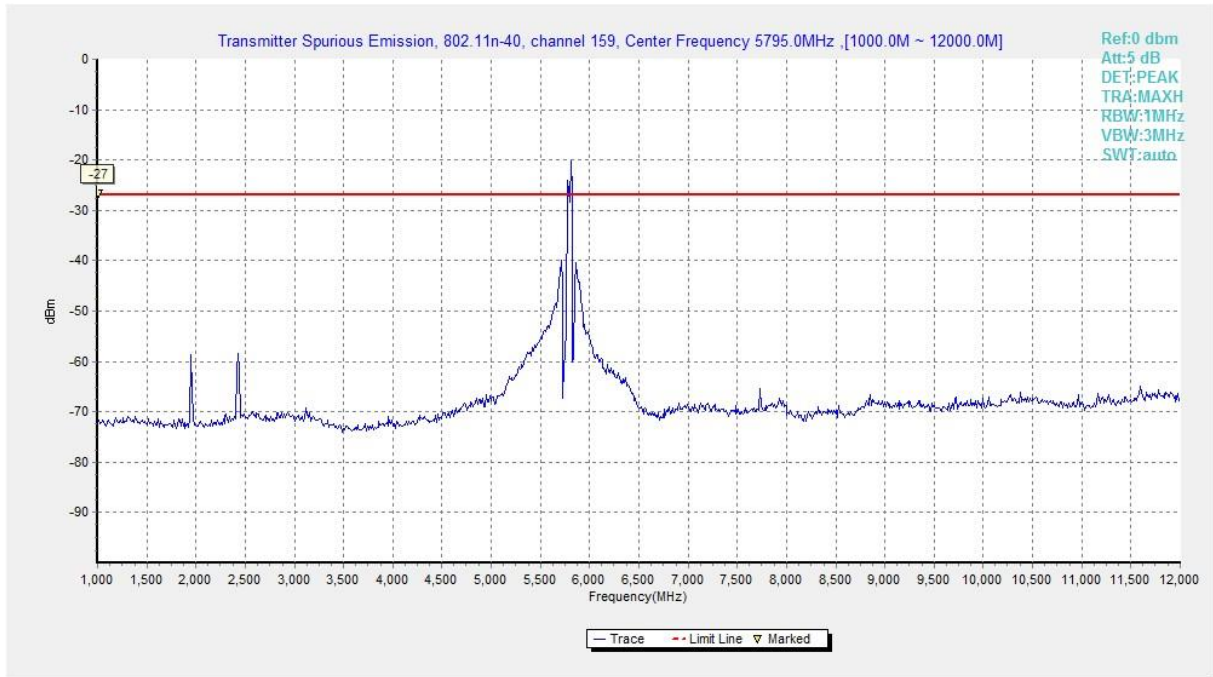

Fig. 56 Conducted Spurious Emission (802.11n-HT40, Ch159, 1 GHz -12 GHz)

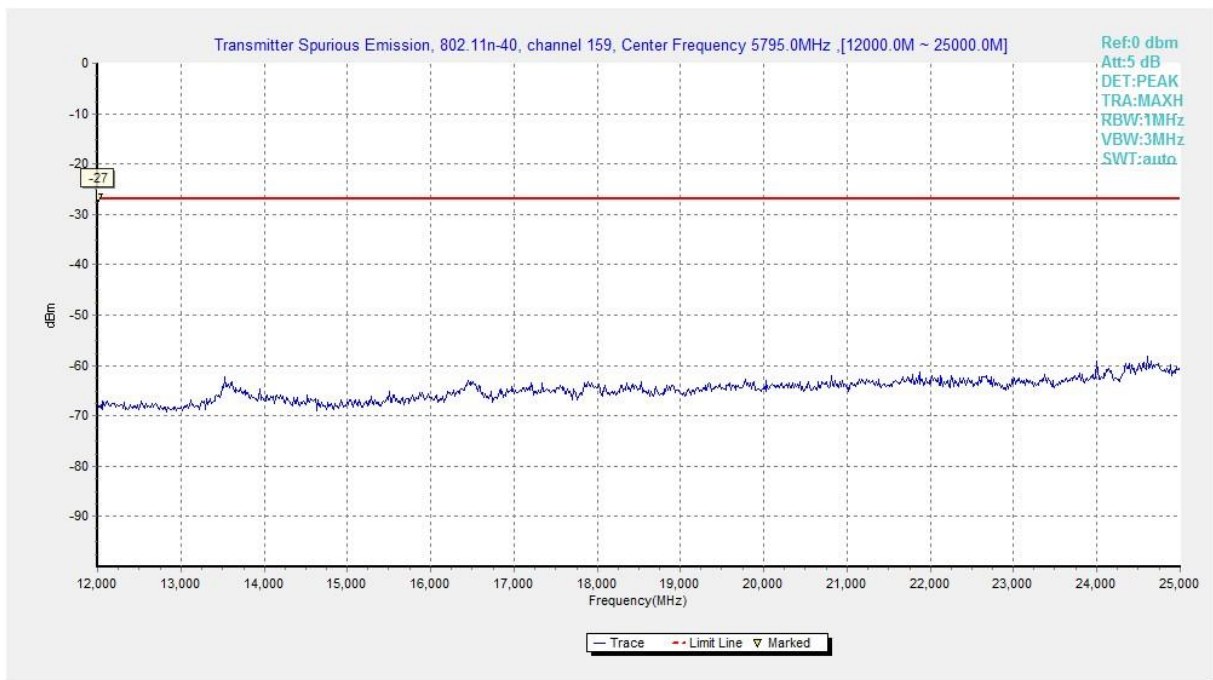

Fig. 57 Conducted Spurious Emission (802.11n-HT40, Ch159, 12 GHz-25 GHz)

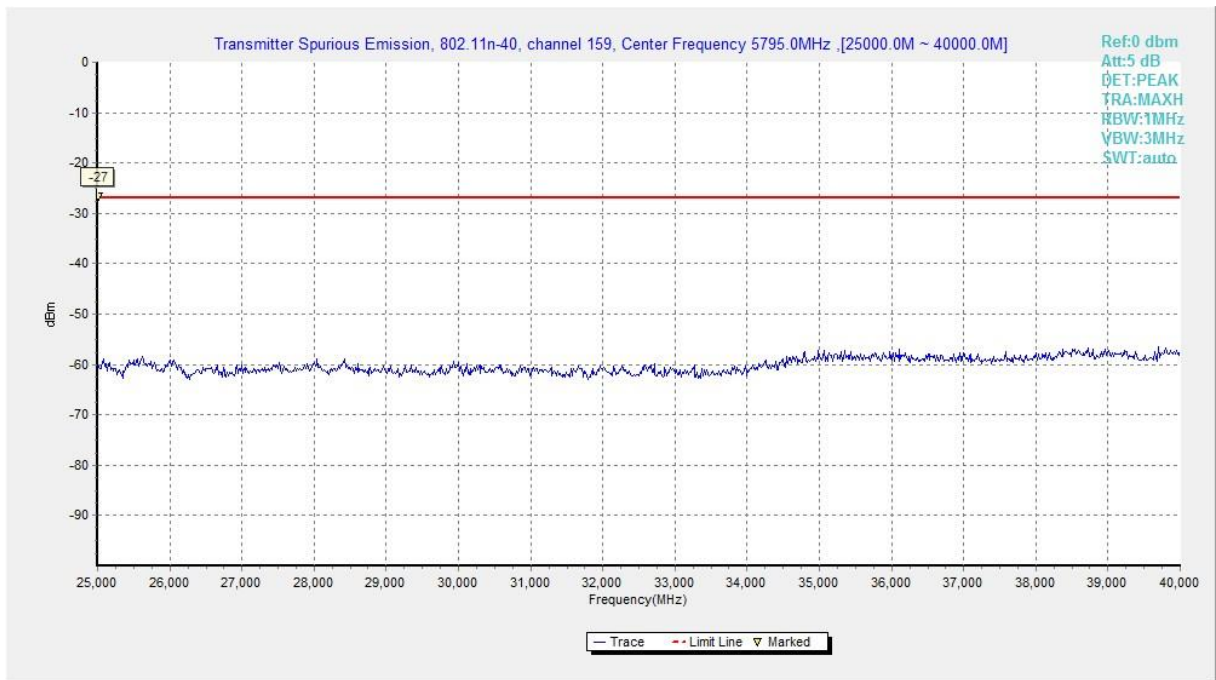

Fig. 58 Conducted Spurious Emission (802.11n-HT40, Ch159, 25 GHz-40 GHz)

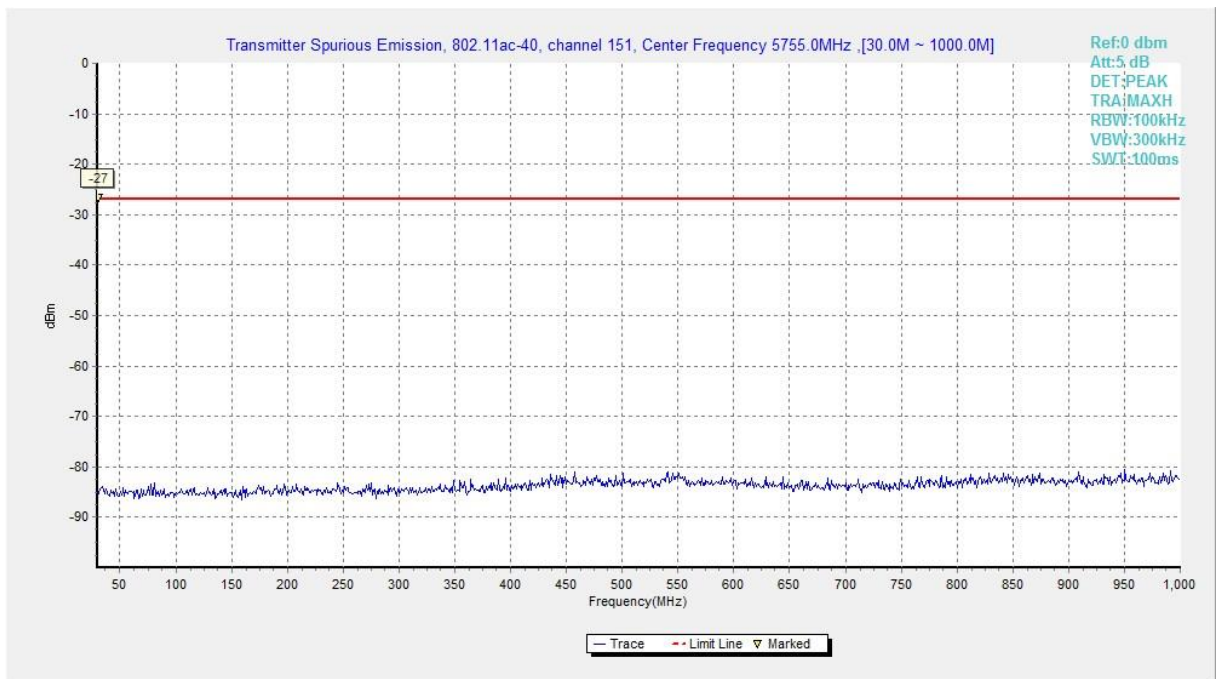

Fig. 59 Conducted Spurious Emission (802.11ac-HT40, Ch151, 30 MHz-1 GHz)

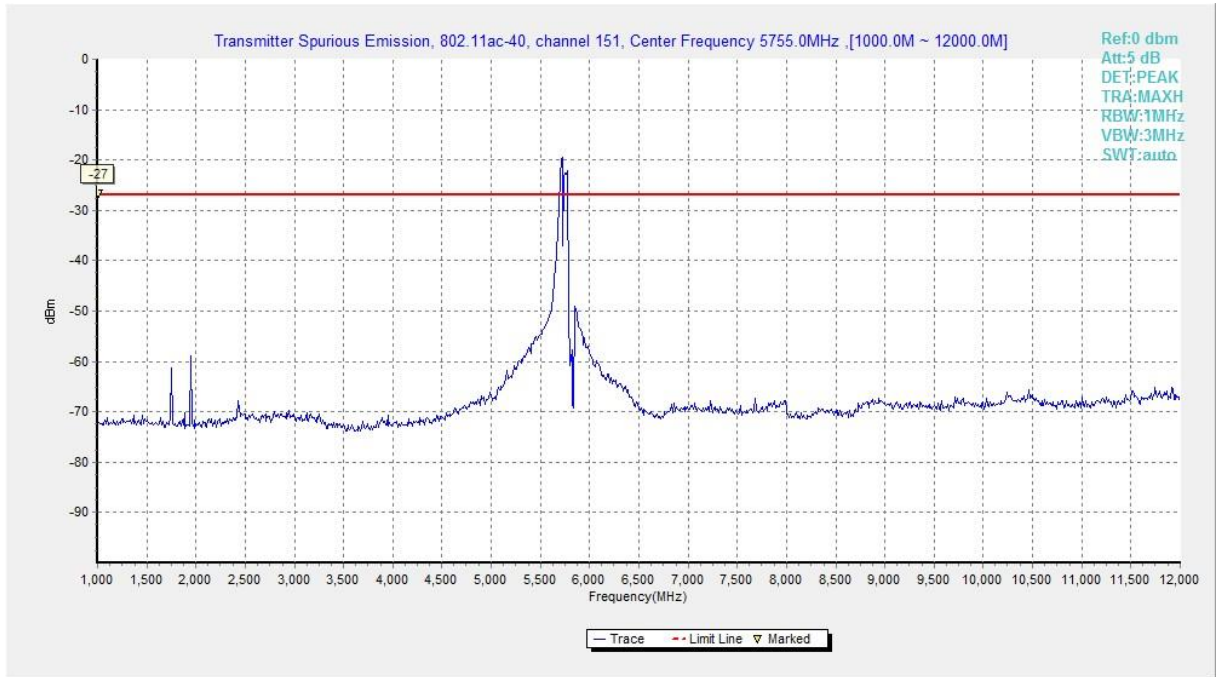

Fig. 60 Conducted Spurious Emission (802.11ac-HT40, Ch151, 1 GHz -12 GHz)

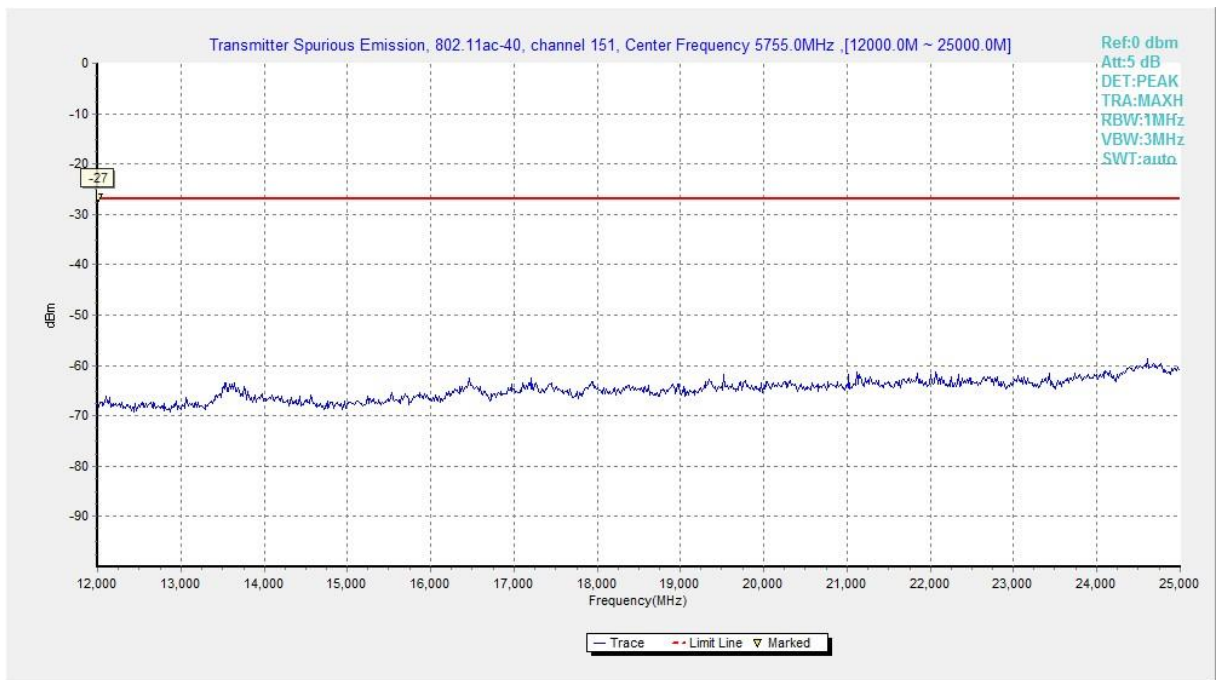

Fig. 61 Conducted Spurious Emission (802.11ac-HT40, Ch151, 12 GHz-25 GHz)

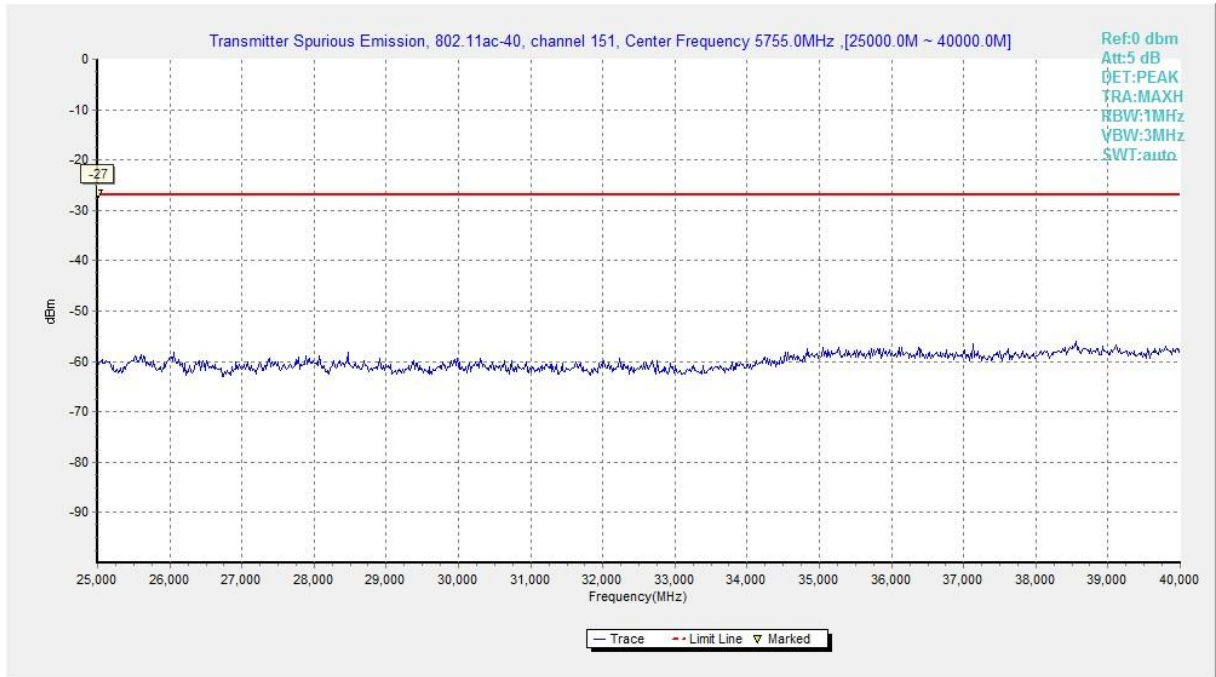

Fig. 62 Conducted Spurious Emission (802.11ac-HT40, Ch151, 25 GHz-40 GHz)

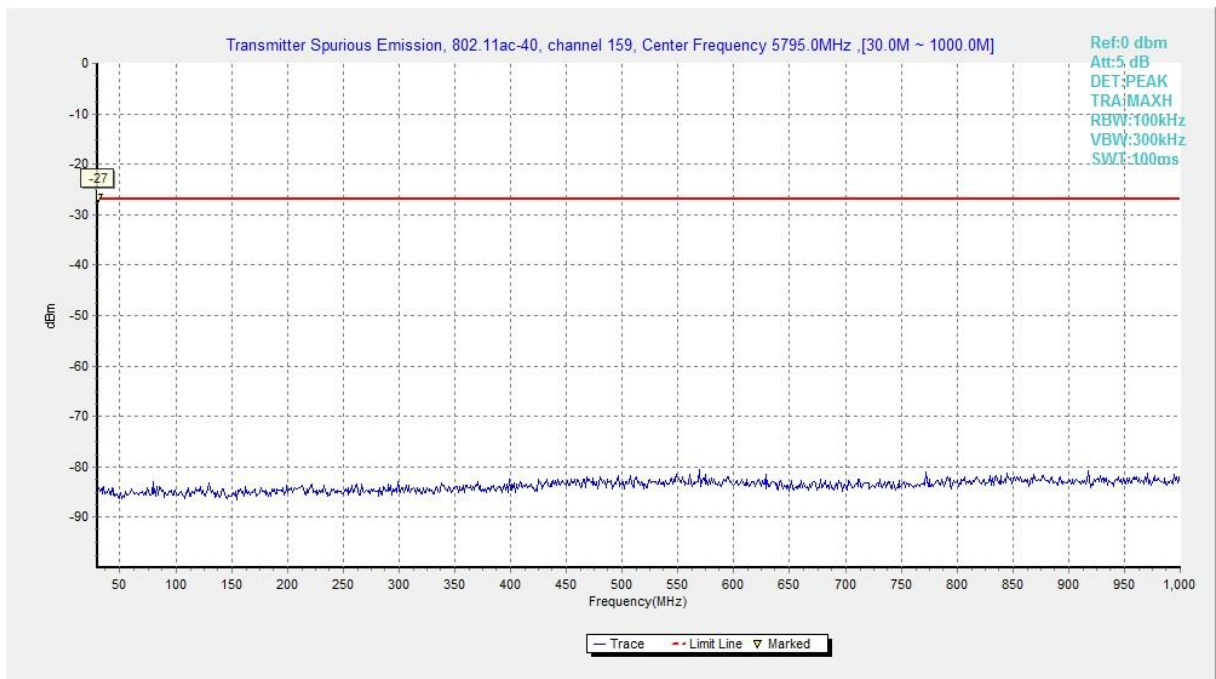

Fig. 63 Conducted Spurious Emission (802.11ac-HT40, Ch159, 30 MHz-1 GHz)

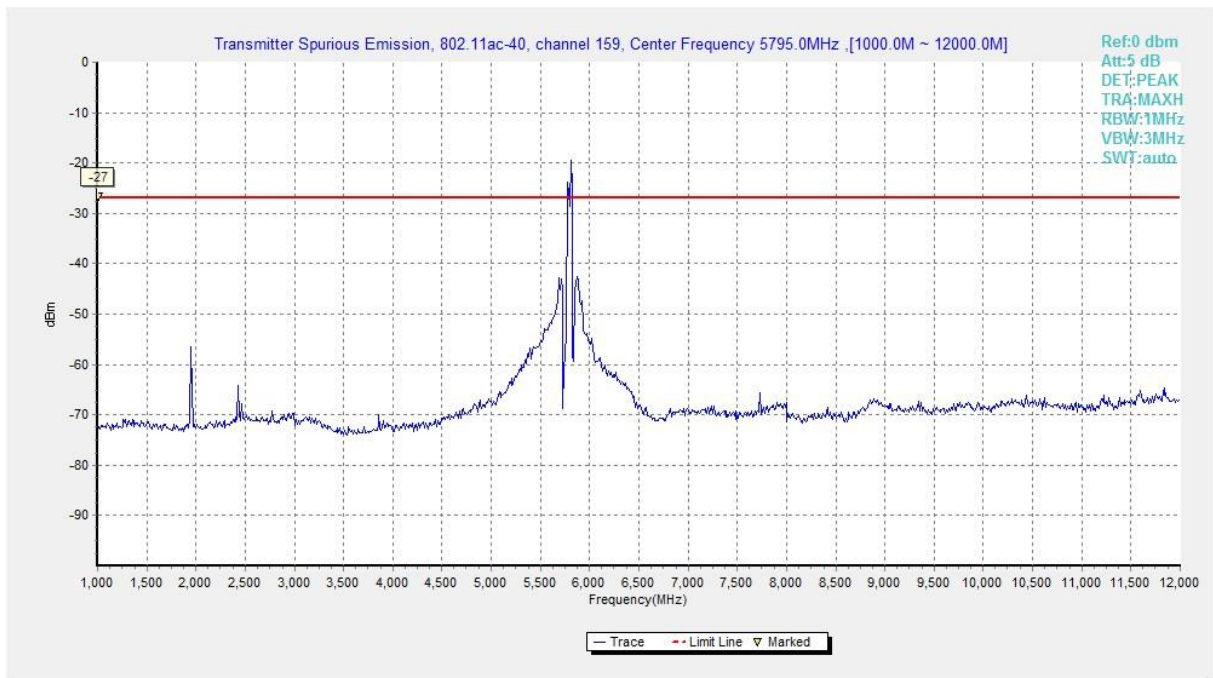

Fig. 64 Conducted Spurious Emission (802.11ac-HT40, Ch159, 1 GHz -12 GHz)

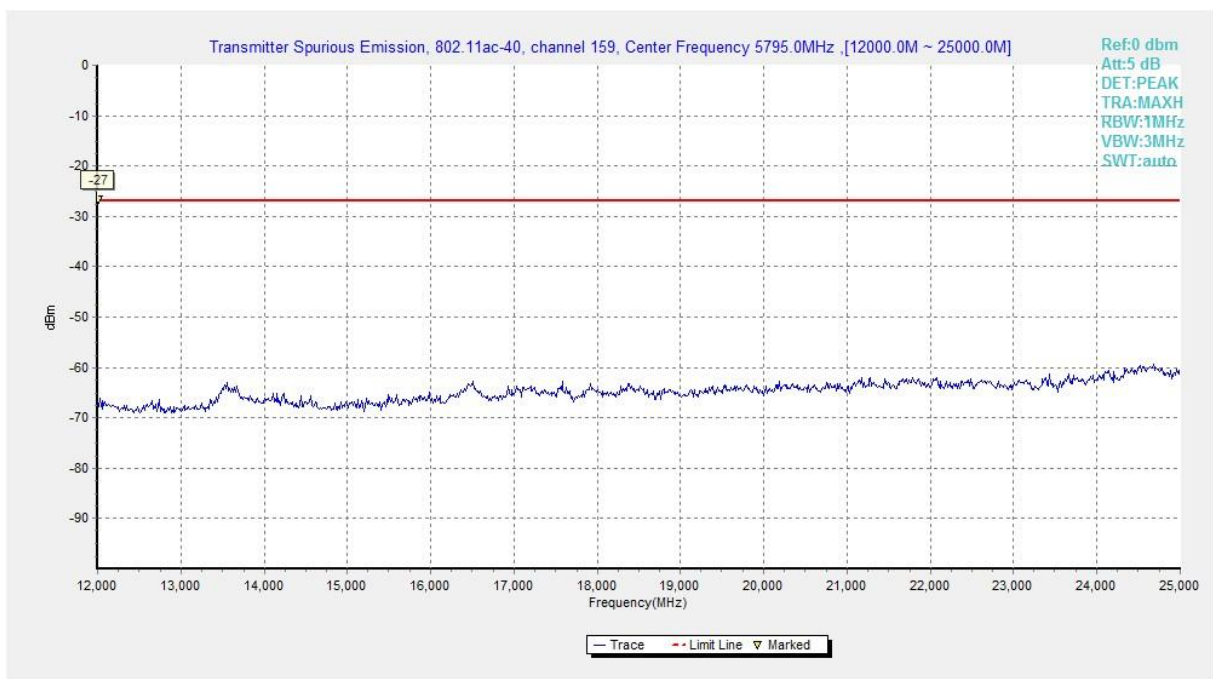

Fig. 65 Conducted Spurious Emission (802.11ac-HT40, Ch159, 12 GHz-25 GHz)

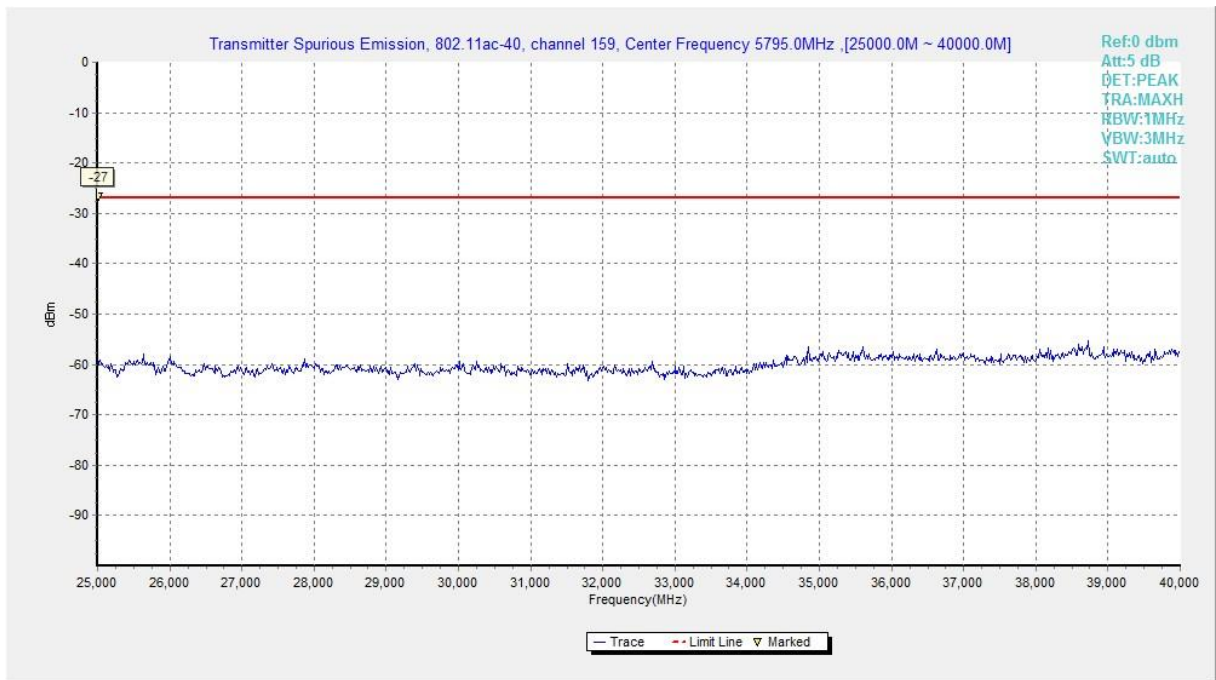

Fig. 66 Conducted Spurious Emission (802.11ac-HT40, Ch159, 25 GHz-40 GHz)

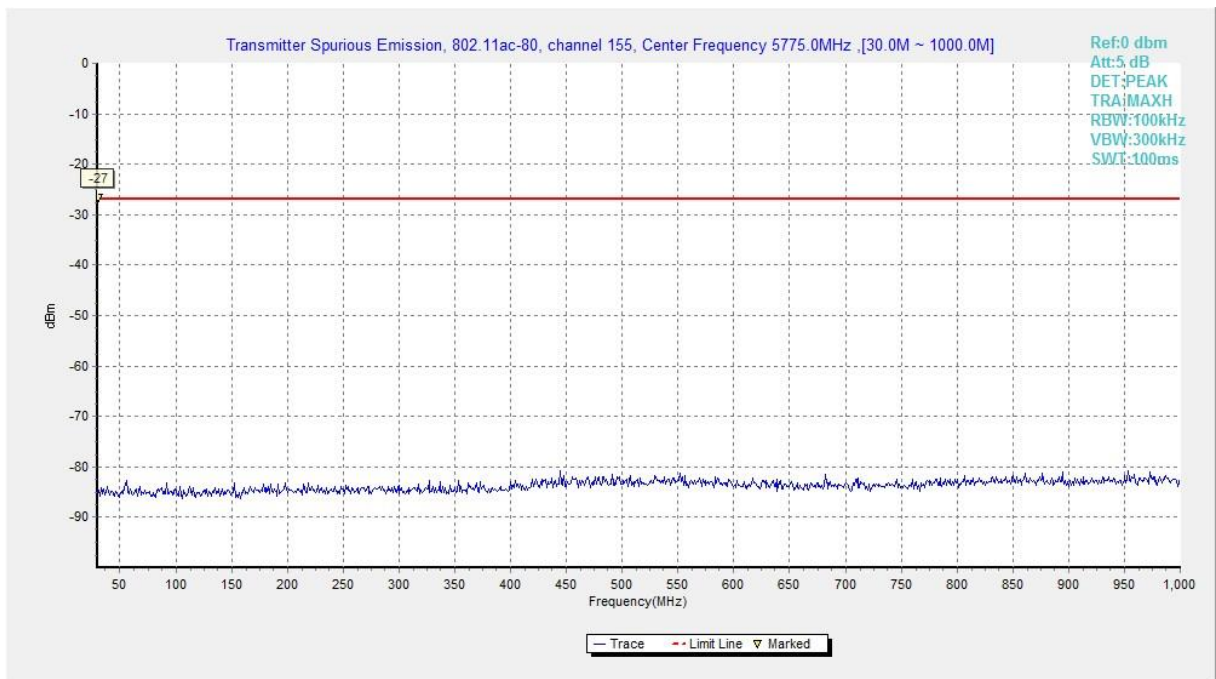

Fig. 67 Conducted Spurious Emission (802.11ac-HT80, Ch155, 30 MHz-1 GHz)

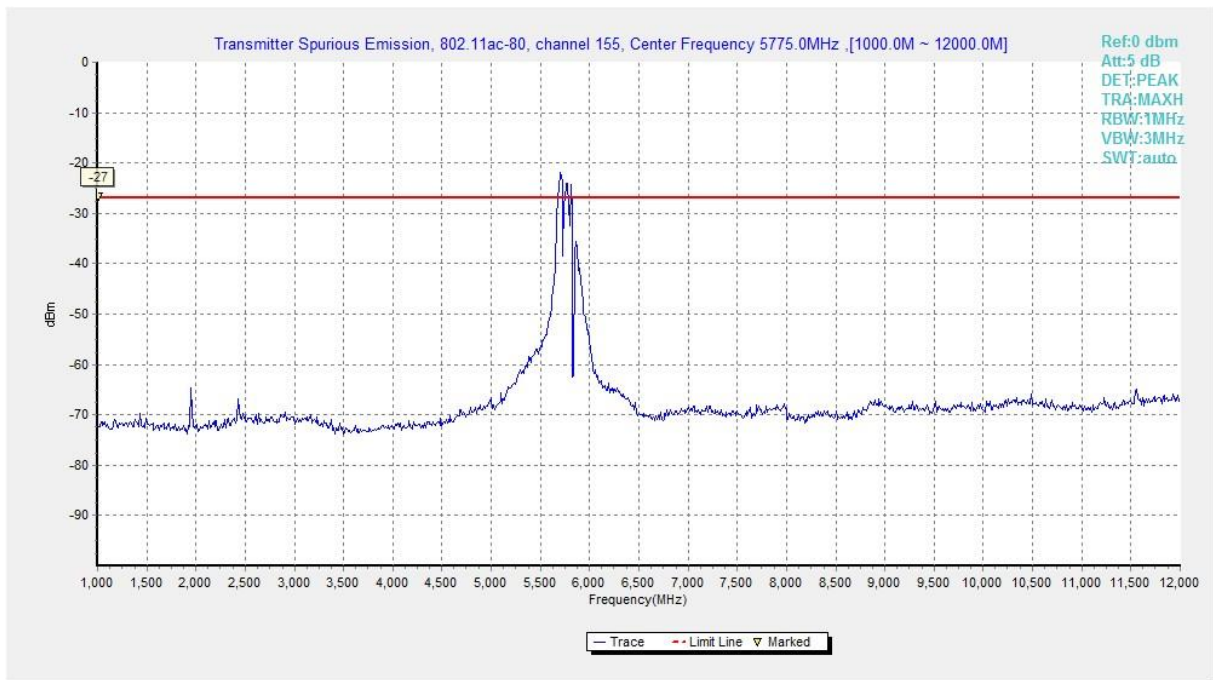

Fig. 68 Conducted Spurious Emission (802.11ac-HT80, Ch155, 1 GHz -12 GHz)

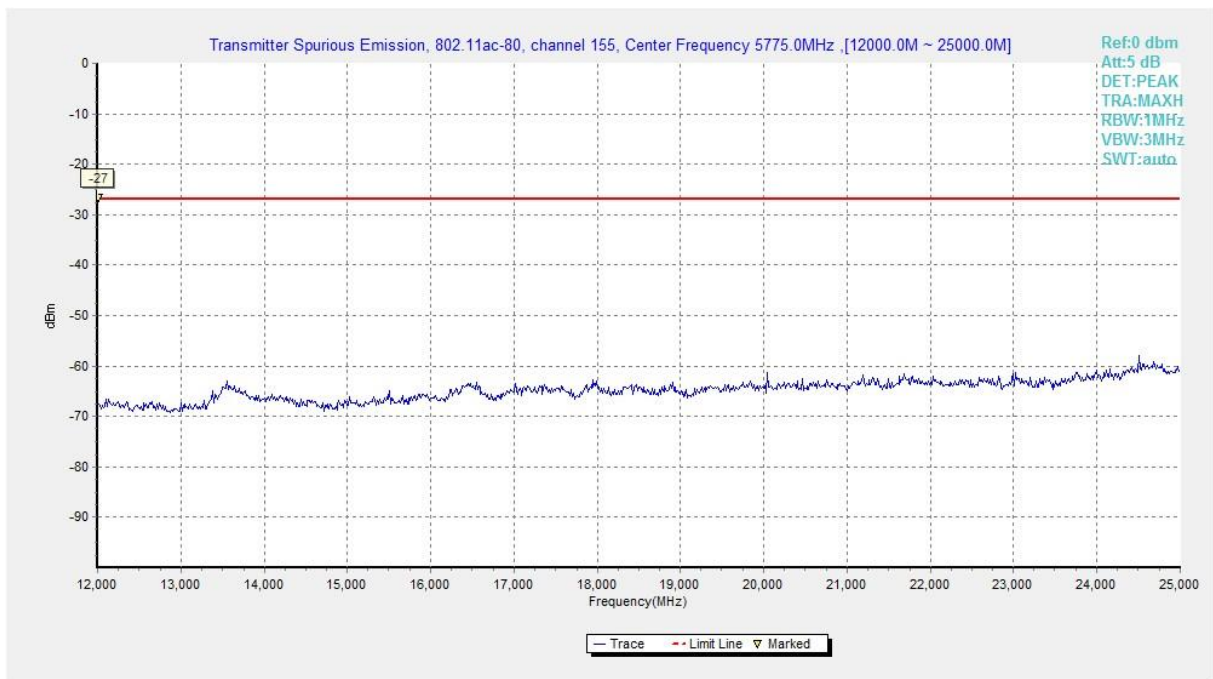

Fig. 69 Conducted Spurious Emission (802.11ac-HT80, Ch155, 12 GHz-25 GHz)

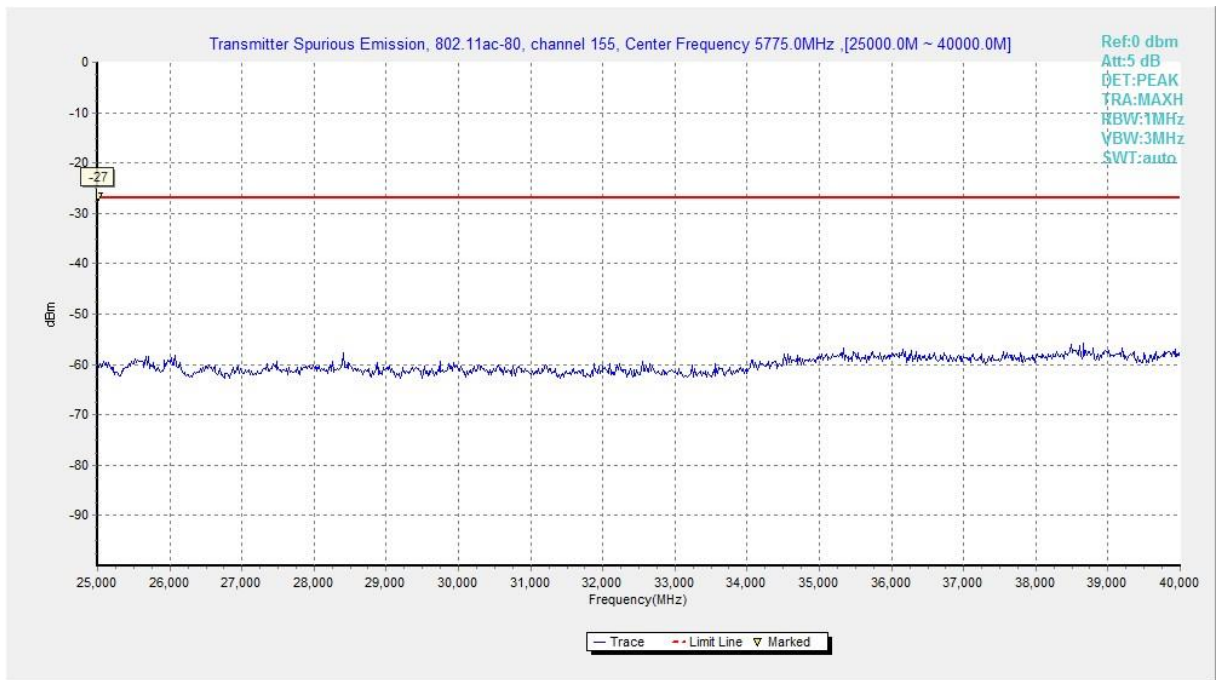

Fig. 70 Conducted Spurious Emission (802.11ac-HT80, Ch155, 25 GHz-40 GHz)

A.5.2 Transmitter Spurious Emission - Radiated

Measurement Limit:

Standard	Frequency (MHz)	Limit (dBm/MHz)
FCC 47 CFR Part 15.407	5725MHz~5850MHz	< -27

The measurement is made according to ANSI C63.10 .

In addition, radiated emissions which fall in the restricted bands, as defined in § 15.205(a), must also comply with the radiated emission limits specified in § 15.209(a) (see § 15.205(c)).

Limit in restricted band:

Frequency (MHz)	Field strength(μ V/m)	Measurement distance (m)
0.009 - 0.490	2400/F(kHz)	300
0.490 - 1.705	24000/F(kHz)	30
1.705 – 30.0	30	30

Frequency of emission (MHz)	Field strength(uV/m)	Field strength(dBuV/m)
30-88	100	40
88-216	150	43.5
216-960	200	46
Above 960	500	54

Set up:

Tabletop devices shall be placed on a nonconducting platform with nominal top surface dimensions 1 m by 1.5 m. For emissions testing at or below 1 GHz, the table height shall be 80 cm above the reference ground plane. For emission measurements above 1 GHz, the table height shall be 1.5 m

The EUT and transmitting antenna shall be centered on the turntable.

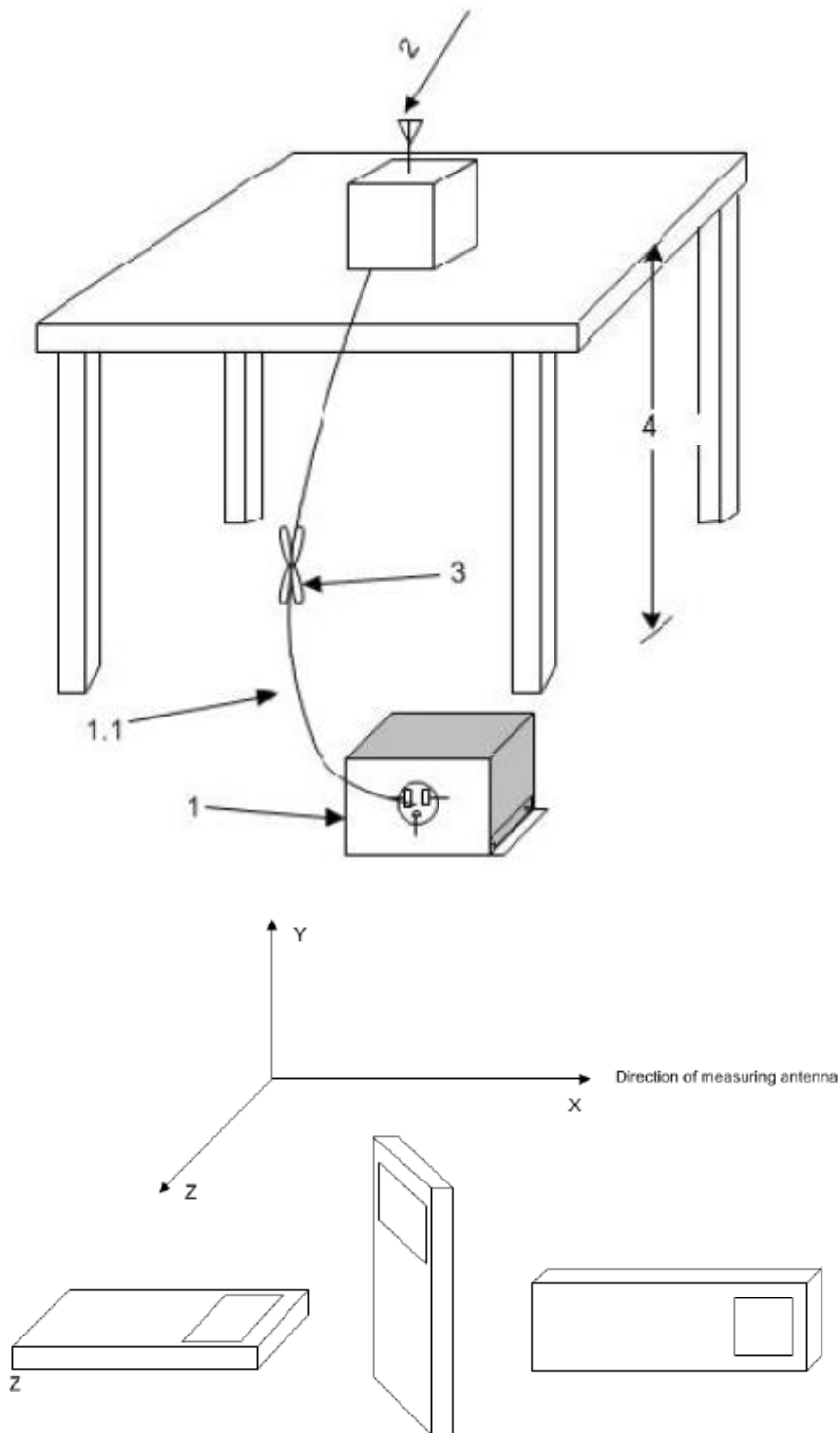

Test Condition

The EUT shall be tested 1 near top, 1 near middle, and 1 near bottom. Set the unlicensed wireless device to operate in continuous transmit mode. For unlicensed wireless devices unable to be configured for 100% duty cycle even in test mode, configure the system for the maximum duty cycle supported.

When required for unlicensed wireless devices, measurements of the variation of the input power or the radiated signal level of the fundamental frequency component of the emission, as appropriate, shall be performed with the supply voltage varied between 85% and 115% of the

nominal rated supply voltage.

Exploratory radiated emissions measurements

Exploratory radiated measurements shall be performed at the measurement distance or at a closer distance than that specified for compliance to determine the emission characteristics of the EUT and, if applicable, the EUT configuration that produces the maximum level of emissions. The frequencies of maximum emission may be determined by manually positioning the antenna close to the EUT, and then moving the antenna over all sides of the EUT while observing a spectral display. It is advantageous to have prior knowledge of the frequencies of emissions, although this may be determined from such a near-field scan. The near-field scan shall only be used to determine the frequency but not the amplitude of the emissions. Where exploratory measurements are not adequate to determine the worst-case operating modes and are used only to identify the frequencies of the highest emissions, additional preliminary tests can be required.

For emissions from the EUT, the maximum level shall be determined by rotating the EUT and its antenna through 0° to 360°. For each mode of operation required to be tested, the frequency spectrum (based on findings from exploratory measurements) shall be monitored.

Broadband antennas and a spectrum analyzer or a radio-noise meter with a panoramic display are often useful in this type of test. If either antenna height or EUT azimuth are not fully measured during exploratory testing, then complete testing can be required at the OATS or semi-anechoic chamber when the final full spectrum testing is performed.

Final radiated emissions measurements

The final measurements are using the orientation and equipment arrangement of the EUT based on the measurement results found during the preliminary (exploratory) measurements, the EUT arrangement, appropriate modulation, and modes of operation that produce the emissions that have the highest amplitude relative to the limit shall be selected for the final measurement.

For each mode of operation required to be tested, the frequency spectrum (based on findings from exploratory measurements) shall be monitored. The highest signal levels relative to the limit shall be determined by rotating the EUT from 0° to 360° and with varying the measurement antenna height between 1 m and 4 m in vertical and horizontal polarizations.

For each mode selected, record the frequency and amplitude of the highest fundamental emission (if applicable), as well as the frequency and amplitude of the six highest spurious emissions relative to the limit. Emissions more than 20 dB below the limit do not need to be reported.

This maximization process was repeated with the EUT positioned in each of its three orthogonal orientations.

The receiver references:

Frequency of emission (MHz)	RBW/VBW	Sweep Time(s)
30-1000	100KHz/300KHz	5
1000-4000	1MHz/3MHz	15
4000-18000	1MHz/3MHz	40
18000-40000	1MHz/3MHz	20

P_{Mea} is the field strength recorded from the instrument.

The measurement results are obtained as described below:

Result= P_{Mea} + Cable Loss + Antenna Factor

Where:

P_{Mea} field strength recorded from the instrument

EUT ID: EUT1

Average Results:

802.11a

Ch149

Frequency (MHz)	Measurement Result (dB μ V/m)	Cable loss (dB)	Antenna Factor (dB/m)	Receiver Reading (dB μ V)	Limit (dB μ V/m)	Margin (dB)	Antenna Pol. (H/V)	Antenna Height (cm)	Turntable angle (deg)
5650.000	34.1	-33.1	34.7	32.39	48.2	14.1	H	155	18
5650.400	34.0	-33.0	34.7	32.33	48.5	14.5	H	155	56
11490.000	36.6	-30.8	38.2	29.20	48.3	11.7	H	155	139
17235.000	37.8	-26.6	41.5	22.94	48.3	10.5	H	155	108
13341.560	38.8	-30.6	39.0	30.45	48.3	9.5	H	155	78
17938.840	38.1	-26.0	41.3	22.81	48.3	10.2	H	155	36

Ch157

Frequency (MHz)	Measurement Result (dB μ V/m)	Cable loss (dB)	Antenna Factor (dB/m)	Receiver Reading (dB μ V)	Limit (dB μ V/m)	Margin (dB)	Antenna Pol. (H/V)	Antenna Height (cm)	Turntable angle (deg)
5714.400	35.5	-33.4	34.8	34.08	48.3	12.8	H	155	268
5848.400	35.1	-33.4	35.0	33.53	48.3	13.2	H	155	138
11570.000	36.8	-30.8	38.3	29.36	48.3	11.5	H	155	104
17355.000	37.8	-26.6	41.3	23.11	48.3	10.5	H	155	40
13375.680	38.8	-30.5	39.0	30.38	48.3	9.5	H	155	28
17886.670	38.1	-26.2	41.3	23.08	48.3	10.2	H	155	8

Ch165

Frequency (MHz)	Measurement Result (dB μ V/m)	Cable loss (dB)	Antenna Factor (dB/m)	Receiver Reading (dB μ V)	Limit (dB μ V/m)	Margin (dB)	Antenna Pol. (H/V)	Antenna Height (cm)	Turntable angle (deg)
5924.400	34.3	-32.5	35.1	31.66	48.6	14.4	H	155	16
5924.800	34.3	-32.5	35.1	31.70	48.3	14.1	H	155	48
11650.000	36.5	-30.6	38.4	28.73	48.3	11.8	H	155	80
17475.000	37.9	-26.3	41.2	22.98	48.3	10.4	H	155	8
13346.850	38.8	-30.6	39.0	30.47	48.3	9.5	H	155	102
17928.650	38.1	-26.1	41.3	22.85	48.3	10.2	H	155	118

802.11n-HT20
Ch149

Frequency (MHz)	Measurement Result (dBμV/m)	Cable loss (dB)	Antenna Factor (dB/m)	Receiver Reading (dBμV)	Limit (dBμV/m)	Margin (dB)	Antenna Pol. (H/V)	Antenna Height (cm)	Turntable angle (deg)
5650.000	34.2	-33.1	34.7	32.52	48.2	14.0	H	155	28
5650.400	34.3	-33.0	34.7	32.59	48.5	14.2	H	155	46
11490.000	36.5	-30.8	38.2	29.11	48.3	11.8	H	155	8
17235.000	37.8	-26.6	41.5	22.96	48.3	10.5	H	155	6
13350.400	38.7	-30.6	39.0	30.32	48.3	9.6	H	155	24
17958.500	38.2	-25.9	41.3	22.85	48.3	10.1	H	155	185

Ch157

Frequency (MHz)	Measurement Result (dBμV/m)	Cable loss (dB)	Antenna Factor (dB/m)	Receiver Reading (dBμV)	Limit (dBμV/m)	Margin (dB)	Antenna Pol. (H/V)	Antenna Height (cm)	Turntable angle (deg)
5709.600	35.3	-33.3	34.8	33.78	48.3	13.0	H	155	28
5845.600	35.6	-33.4	35.0	34.01	48.3	12.7	H	155	248
11570.000	36.8	-30.8	38.3	29.33	48.3	11.5	H	155	38
17355.000	37.8	-26.6	41.3	23.07	48.3	10.5	H	155	98
13390.500	38.8	-30.5	39.0	30.31	48.3	9.5	H	155	183
17894.560	38.2	-26.2	41.3	23.15	48.3	10.1	H	155	356

Ch165

Frequency (MHz)	Measurement Result (dBμV/m)	Cable loss (dB)	Antenna Factor (dB/m)	Receiver Reading (dBμV)	Limit (dBμV/m)	Margin (dB)	Antenna Pol. (H/V)	Antenna Height (cm)	Turntable angle (deg)
5924.400	34.3	-32.5	35.1	31.68	48.6	14.4	H	155	20
5924.800	34.4	-32.5	35.1	31.80	48.3	13.9	H	155	18
11650.000	36.4	-30.6	38.4	28.62	48.3	11.9	H	155	90
17475.000	37.9	-26.3	41.2	22.93	48.3	10.4	H	155	114
13350.750	38.8	-30.6	39.0	30.46	48.3	9.5	H	155	36
17930.490	38.1	-26.1	41.3	22.89	48.3	10.2	H	155	2

802.11n-HT40

Ch151

Frequency (MHz)	Measurement Result (dBμV/m)	Cable loss (dB)	Antenna Factor (dB/m)	Receiver Reading (dBμV)	Limit (dBμV/m)	Margin (dB)	Antenna Pol. (H/V)	Antenna Height (cm)	Turntable angle (deg)
5650.000	36.6	-33.1	34.7	34.91	48.2	11.6	H	155	28
5656.000	37.4	-32.9	34.7	35.65	52.6	15.2	H	155	49
11510.000	36.7	-30.8	38.2	29.31	48.3	11.6	H	155	246
17265.000	37.9	-26.8	41.4	23.25	48.3	10.4	H	155	182
14986.650	37.5	-28.5	39.8	26.17	48.3	10.8	H	155	94
16947.350	38.3	-27.1	41.7	23.71	48.3	10.0	H	155	42

Ch159

Frequency (MHz)	Measurement Result (dBμV/m)	Cable loss (dB)	Antenna Factor (dB/m)	Receiver Reading (dBμV)	Limit (dBμV/m)	Margin (dB)	Antenna Pol. (H/V)	Antenna Height (cm)	Turntable angle (deg)
5919.200	34.2	-32.5	35.1	31.62	52.5	18.2	H	155	98
5924.800	34.5	-32.5	35.1	31.86	48.3	13.9	H	155	135
11590.000	36.7	-30.8	38.3	29.20	48.3	11.6	H	155	4
17385.000	37.7	-26.5	41.3	22.96	48.3	10.6	H	155	74
13393.230	38.7	-30.5	39.0	30.22	48.3	9.6	H	155	48
17888.950	38.2	-26.2	41.3	23.16	48.3	10.1	H	155	246

802.11ac-HT20

Ch149

Frequency (MHz)	Measurement Result (dBμV/m)	Cable loss (dB)	Antenna Factor (dB/m)	Receiver Reading (dBμV)	Limit (dBμV/m)	Margin (dB)	Antenna Pol. (H/V)	Antenna Height (cm)	Turntable angle (deg)
5650.000	34.3	-33.1	34.7	32.64	48.2	13.9	H	155	48
5651.200	34.4	-33.0	34.7	32.70	49.1	14.7	H	155	6
11490.000	36.5	-30.8	38.2	29.16	48.3	11.8	H	155	312
17235.000	37.7	-26.6	41.5	22.80	48.3	10.6	H	155	48
13342.900	38.7	-30.6	39.0	30.36	48.3	9.6	H	155	68
17909.740	38.3	-26.1	41.3	23.14	48.3	10.0	H	155	80

Ch157

Frequency (MHz)	Measurement Result (dB μ V/m)	Cable loss (dB)	Antenna Factor (dB/m)	Receiver Reading (dB μ V)	Limit (dB μ V/m)	Margin (dB)	Antenna Pol. (H/V)	Antenna Height (cm)	Turntable angle (deg)
5708.800	35.7	-33.3	34.8	34.14	48.3	12.7	H	155	28
5845.600	35.6	-33.4	35.0	34.10	48.3	12.7	H	155	49
11570.000	36.8	-30.8	38.3	29.33	48.3	11.5	H	155	226
17355.000	37.8	-26.6	41.3	23.07	48.3	10.5	H	155	248
13376.850	38.8	-30.5	39.0	30.36	48.3	9.5	H	155	268
17880.490	38.2	-26.3	41.3	23.21	48.3	10.1	H	155	298

Ch165

Frequency (MHz)	Measurement Result (dB μ V/m)	Cable loss (dB)	Antenna Factor (dB/m)	Receiver Reading (dB μ V)	Limit (dB μ V/m)	Margin (dB)	Antenna Pol. (H/V)	Antenna Height (cm)	Turntable angle (deg)
5924.400	34.4	-32.5	35.1	31.76	48.6	14.3	H	155	28
5924.800	34.5	-32.5	35.1	31.88	48.3	13.9	H	155	48
11650.000	36.4	-30.6	38.4	28.62	48.3	11.9	H	155	8
17475.000	37.9	-26.3	41.2	22.93	48.3	10.4	H	155	16
13350.750	38.8	-30.6	39.0	30.46	48.3	9.5	H	155	228
17930.490	38.1	-26.1	41.3	22.89	48.3	10.2	H	155	92

802.11ac-HT40

Ch151

Frequency (MHz)	Measurement Result (dB μ V/m)	Cable loss (dB)	Antenna Factor (dB/m)	Receiver Reading (dB μ V)	Limit (dB μ V/m)	Margin (dB)	Antenna Pol. (H/V)	Antenna Height (cm)	Turntable angle (deg)
5650.000	36.5	-33.1	34.7	34.85	48.2	11.7	H	155	92
5656.800	37.5	-32.9	34.7	35.71	53.2	15.7	H	155	68
11510.000	36.7	-30.8	38.2	29.31	48.3	11.6	H	155	118
17265.000	37.9	-26.8	41.4	23.20	48.3	10.4	H	155	354
13393.250	38.7	-30.5	39.0	30.22	48.3	9.6	H	155	18
17012.260	38.2	-26.6	41.7	23.11	48.3	10.1	H	155	38

Ch159

Frequency (MHz)	Measurement Result (dBμV/m)	Cable loss (dB)	Antenna Factor (dB/m)	Receiver Reading (dBμV)	Limit (dBμV/m)	Margin (dB)	Antenna Pol. (H/V)	Antenna Height (cm)	Turntable angle (deg)
5923.600	34.3	-32.5	35.1	31.69	49.2	14.9	H	155	24
5924.800	34.4	-32.5	35.1	31.82	48.3	13.9	H	155	336
11590.000	36.6	-30.8	38.3	29.08	48.3	11.7	H	155	248
17385.000	37.8	-26.5	41.3	22.99	48.3	10.5	H	155	268
13353.600	38.6	-30.6	39.0	30.23	48.3	9.7	H	155	290
17862.580	37.9	-26.3	41.3	22.96	48.3	10.4	H	155	300

802.11ac-HT80

Ch155

Frequency (MHz)	Measurement Result (dBμV/m)	Cable loss (dB)	Antenna Factor (dB/m)	Receiver Reading (dBμV)	Limit (dBμV/m)	Margin (dB)	Antenna Pol. (H/V)	Antenna Height (cm)	Turntable angle (deg)
5923.600	34.3	-32.5	35.1	31.69	49.2	14.9	H	155	24
5924.800	34.4	-32.5	35.1	31.82	48.3	13.9	H	155	336
11590.000	36.6	-30.8	38.3	29.08	48.3	11.7	H	155	248
17385.000	37.8	-26.5	41.3	22.99	48.3	10.5	H	155	268
13353.600	38.6	-30.6	39.0	30.23	48.3	9.7	H	155	290
17862.580	37.9	-26.3	41.3	22.96	48.3	10.4	H	155	300

Ch155

Frequency (MHz)	Measurement Result (dBμV/m)	Cable loss (dB)	Antenna Factor (dB/m)	Receiver Reading (dBμV)	Limit (dBμV/m)	Margin (dB)	Antenna Pol. (H/V)	Antenna Height (cm)	Turntable angle (deg)
5920.400	34.5	-32.5	35.1	31.91	51.6	17.1	H	155	25
5924.800	34.6	-32.5	35.1	32.01	48.3	13.7	H	155	49
11550.000	36.6	-30.8	38.3	29.14	48.3	11.7	H	155	4
17325.000	37.9	-26.7	41.4	23.21	48.3	10.4	H	155	6
14991.560	37.4	-28.4	39.8	26.02	48.3	10.9	H	155	25
17915.302	38.2	-26.1	41.3	23.05	48.3	10.1	H	155	186

Peak Results:
802.11a

Ch149

Frequency (MHz)	Measurement Result (dBμV/m)	Cable loss (dB)	Antenna Factor (dB/m)	Receiver Reading (dBμV)	Limit (dBμV/m)	Margin (dB)	Antenna Pol. (H/V)	Antenna Height (cm)	Turntable angle (deg)
5650.299	51.9	-33.0	34.7	68.42	68.4	16.5	H	155	264
5650.552	52.1	-33.0	34.7	68.61	68.6	16.5	H	155	132
11490.000	50.2	-30.8	38.2	42.84	68.3	18.1	H	155	110
17235.000	54.3	-26.6	41.5	39.40	68.3	14.0	H	155	44
17548.450	55.9	-26.4	41.2	41.06	68.3	12.4	H	155	22
17900.450	54.6	-26.2	41.3	39.50	68.3	13.7	V	155	0

Ch157

Frequency (MHz)	Measurement Result (dBμV/m)	Cable loss (dB)	Antenna Factor (dB/m)	Receiver Reading (dBμV)	Limit (dBμV/m)	Margin (dB)	Antenna Pol. (H/V)	Antenna Height (cm)	Turntable angle (deg)
5680.800	49.5	-32.8	34.8	47.55	68.3	18.8	H	155	22
5851.400	51.3	-33.3	35.0	49.67	68.3	17.0	H	155	44
11570.000	51.5	-30.8	38.3	43.98	68.3	16.8	V	155	88
17355.000	54.0	-26.6	41.3	39.31	68.3	14.3	V	155	0
16942.950	55.4	-27.1	41.7	40.86	68.3	12.9	H	155	110
17658.450	55.1	-26.5	41.2	40.33	68.3	13.2	H	155	132

Ch165

Frequency (MHz)	Measurement Result (dBμV/m)	Cable loss (dB)	Antenna Factor (dB/m)	Receiver Reading (dBμV)	Limit (dBμV/m)	Margin (dB)	Antenna Pol. (H/V)	Antenna Height (cm)	Turntable angle (deg)
5923.793	49.7	-32.5	35.1	47.08	69.1	19.4	H	155	22
5924.529	49.8	-32.5	35.1	47.17	68.5	18.8	H	155	44
11650.000	50.5	-30.6	38.4	42.77	68.3	17.8	V	155	0
17475.000	53.9	-26.3	41.2	38.92	68.3	14.4	H	155	0
16092.560	54.9	-27.6	40.8	41.63	68.3	13.4	V	155	22
16820.870	55.4	-26.8	41.6	40.64	68.3	12.9	H	155	176

802.11n-HT20
Ch149

Frequency (MHz)	Measurement Result (dBμV/m)	Cable loss (dB)	Antenna Factor (dB/m)	Receiver Reading (dBμV)	Limit (dBμV/m)	Margin (dB)	Antenna Pol. (H/V)	Antenna Height (cm)	Turntable angle (deg)
5650.081	48.6	-33.1	34.7	46.99	68.3	19.6	H	155	22
5650.874	49.1	-33.0	34.7	47.43	68.8	19.7	H	155	242
11490.000	50.7	-30.8	38.2	43.29	68.3	17.6	V	155	44
17235.000	54.4	-26.6	41.5	39.54	68.3	13.9	H	155	88
17308.100	55.1	-26.8	41.4	40.49	68.3	13.2	V	155	176
16942.950	55.4	-27.1	41.7	40.86	68.3	12.9	H	155	0

Ch157

Frequency (MHz)	Measurement Result (dBμV/m)	Cable loss (dB)	Antenna Factor (dB/m)	Receiver Reading (dBμV)	Limit (dBμV/m)	Margin (dB)	Antenna Pol. (H/V)	Antenna Height (cm)	Turntable angle (deg)
5683.600	50.2	-32.8	34.8	48.22	68.3	18.1	H	155	22
5847.600	50.5	-33.4	35.0	48.92	68.3	17.8	H	155	22
11570.000	51.4	-30.8	38.3	43.90	68.3	16.9	H	155	88
17355.000	54.0	-26.6	41.3	39.32	68.3	14.3	V	155	110
15589.800	54.5	-27.5	40.2	41.85	68.3	13.8	V	155	44
17548.680	55.9	-26.4	41.2	41.04	68.3	12.4	H	155	0

Ch165

Frequency (MHz)	Measurement Result (dBμV/m)	Cable loss (dB)	Antenna Factor (dB/m)	Receiver Reading (dBμV)	Limit (dBμV/m)	Margin (dB)	Antenna Pol. (H/V)	Antenna Height (cm)	Turntable angle (deg)
5923.500	49.3	-32.5	35.1	46.70	69.3	20.0	H	155	44
5924.500	48.6	-32.5	35.1	45.97	68.6	20.0	H	155	0
11650.000	50.7	-30.6	38.4	42.95	68.3	17.6	V	155	308
17475.000	53.8	-26.3	41.2	38.85	68.3	14.5	H	155	44
16121.750	54.7	-27.7	40.8	41.50	68.3	13.6	V	155	66
16807.630	57.0	-26.8	41.5	42.31	68.3	11.3	H	155	88

802.11n-HT40

Ch151

Frequency (MHz)	Measurement Result (dBμV/m)	Cable loss (dB)	Antenna Factor (dB/m)	Receiver Reading (dBμV)	Limit (dBμV/m)	Margin (dB)	Antenna Pol. (H/V)	Antenna Height (cm)	Turntable angle (deg)
5650.702	53.1	-33.0	34.7	51.44	68.7	15.6	H	155	88
5653.427	53.9	-33.0	34.7	52.16	70.7	16.8	H	155	132
11510.000	51.2	-30.8	38.2	43.83	68.3	17.1	H	155	0
17265.000	54.5	-26.8	41.4	39.78	68.3	13.8	V	155	66
17123.850	56.2	-26.0	41.6	40.61	68.3	12.1	V	155	44
17847.168	55.2	-26.4	41.3	40.32	68.3	13.1	H	155	242

Ch159

Frequency (MHz)	Measurement Result (dBμV/m)	Cable loss (dB)	Antenna Factor (dB/m)	Receiver Reading (dBμV)	Limit (dBμV/m)	Margin (dB)	Antenna Pol. (H/V)	Antenna Height (cm)	Turntable angle (deg)
5919.112	49.5	-32.5	35.1	46.85	72.6	23.1	H	155	88
5924.080	49.1	-32.5	35.1	46.52	68.9	19.8	H	155	66
11590.000	50.6	-30.8	38.3	43.15	68.3	17.7	H	155	110
17385.000	55.2	-26.5	41.3	40.37	68.3	13.1	V	155	0
17278.450	55.5	-26.8	41.4	40.95	68.3	12.8	H	155	22
16901.150	56.5	-27.0	41.6	41.86	68.3	11.8	H	155	44

802.11ac-HT20

Ch149

Frequency (MHz)	Measurement Result (dBμV/m)	Cable loss (dB)	Antenna Factor (dB/m)	Receiver Reading (dBμV)	Limit (dBμV/m)	Margin (dB)	Antenna Pol. (H/V)	Antenna Height (cm)	Turntable angle (deg)
5650.506	51.9	-33.0	34.7	50.21	68.6	16.7	H	155	22
5651.254	52.0	-33.0	34.7	50.26	69.1	17.2	H	155	44
11490.000	50.2	-30.8	38.2	42.83	68.3	18.1	V	155	220
17235.000	54.7	-26.6	41.5	39.88	68.3	13.6	V	155	242
16935.750	56.1	-27.1	41.6	41.52	68.3	12.2	H	155	264
17935.160	55.2	-26.0	41.3	39.92	68.3	13.1	H	155	286

Ch157

Frequency (MHz)	Measurement Result (dBμV/m)	Cable loss (dB)	Antenna Factor (dB/m)	Receiver Reading (dBμV)	Limit (dBμV/m)	Margin (dB)	Antenna Pol. (H/V)	Antenna Height (cm)	Turntable angle (deg)
5699.400	50.2	-33.1	34.8	48.53	68.3	18.1	H	155	22
5848.200	50.2	-33.4	35.0	48.62	68.3	18.1	H	155	44
11570.000	50.2	-30.8	38.3	42.69	68.3	18.1	V	155	0
17355.000	54.6	-26.6	41.3	39.87	68.3	13.7	H	155	22
17428.060	54.9	-26.4	41.3	39.96	68.3	13.4	H	155	242
17181.680	55.6	-26.3	41.5	40.43	68.3	12.7	H	155	88

Ch165

Frequency (MHz)	Measurement Result (dBμV/m)	Cable loss (dB)	Antenna Factor (dB/m)	Receiver Reading (dBμV)	Limit (dBμV/m)	Margin (dB)	Antenna Pol. (H/V)	Antenna Height (cm)	Turntable angle (deg)
5923.500	49.3	-32.5	35.1	46.70	69.3	20.0	H	155	22
5924.586	49.3	-32.5	35.1	46.71	68.5	19.2	H	155	44
11650.000	50.7	-30.6	38.4	42.95	68.3	17.6	V	155	242
17475.000	54.1	-26.3	41.2	39.17	68.3	14.2	H	155	176
16996.250	55.0	-26.7	41.7	40.05	68.3	13.3	V	155	88
17605.160	54.4	-26.5	41.2	39.65	68.3	13.9	V	155	22

802.11ac-HT40

Ch151

Frequency (MHz)	Measurement Result (dBμV/m)	Cable loss (dB)	Antenna Factor (dB/m)	Receiver Reading (dBμV)	Limit (dBμV/m)	Margin (dB)	Antenna Pol. (H/V)	Antenna Height (cm)	Turntable angle (deg)
5650.805	52.5	-33.0	34.7	50.87	68.8	16.2	H	155	22
5653.895	54.0	-33.0	34.7	52.26	71.1	17.1	H	155	330
11510.000	50.6	-30.8	38.2	43.21	68.3	17.7	H	155	242
17265.000	54.0	-26.8	41.4	39.30	68.3	14.3	V	155	264
13361.850	54.4	-30.6	39.0	46.04	68.3	13.9	V	155	286
17920.250	54.9	-26.1	41.3	39.68	68.3	13.4	V	155	308

Ch159

Frequency (MHz)	Measurement Result (dBμV/m)	Cable loss (dB)	Antenna Factor (dB/m)	Receiver Reading (dBμV)	Limit (dBμV/m)	Margin (dB)	Antenna Pol. (H/V)	Antenna Height (cm)	Turntable angle (deg)
5922.976	48.2	-32.5	35.1	45.62	69.7	21.5	H	155	132
5924.500	48.6	-32.5	35.1	45.97	68.6	20.0	H	155	154
11590.000	50.4	-30.8	38.3	42.88	68.3	17.9	V	155	88
17385.000	53.4	-26.5	41.3	38.61	68.3	14.9	H	155	110
14885.960	53.9	-29.0	39.7	43.24	68.3	14.4	V	155	110
17819.056	55.2	-26.5	41.3	40.41	68.3	13.1	V	155	88

802.11ac-HT80

Ch155

Frequency (MHz)	Measurement Result (dBμV/m)	Cable loss (dB)	Antenna Factor (dB/m)	Receiver Reading (dBμV)	Limit (dBμV/m)	Margin (dB)	Antenna Pol. (H/V)	Antenna Height (cm)	Turntable angle (deg)
5651.587	53.7	-33.0	34.7	52.01	69.4	15.7	H	155	22
5654.565	55.7	-33.0	34.7	53.97	71.6	15.8	V	155	44
11550.000	51.4	-30.8	38.3	43.96	68.3	16.9	H	155	0
17325.000	54.0	-26.7	41.4	39.33	68.3	14.3	H	155	0
17320.650	55.2	-26.7	41.4	40.53	68.3	13.1	H	155	22
17877.960	54.3	-26.3	41.3	39.31	68.3	14.0	H	155	176

Ch155

Frequency (MHz)	Measurement Result (dBμV/m)	Cable loss (dB)	Antenna Factor (dB/m)	Receiver Reading (dBμV)	Limit (dBμV/m)	Margin (dB)	Antenna Pol. (H/V)	Antenna Height (cm)	Turntable angle (deg)
5924.941	49.4	-32.5	35.1	46.83	68.2	18.8	V	155	88
5924.724	48.9	-32.5	35.1	46.28	68.4	19.5	H	155	110
11550.000	51.4	-30.8	38.3	43.96	68.3	16.9	V	155	132
17325.000	54.0	-26.7	41.4	39.33	68.3	14.3	H	155	154
17320.650	55.2	-26.7	41.4	40.53	68.3	13.1	V	155	176
17877.960	54.3	-26.3	41.3	39.31	68.3	14.0	V	155	198

Sample:

5924.941MHz

 Result (49.4 dBμV/m) = P_{Mea} (46.83 dBμV/m) + Cable Loss(-32.5 dB) + Antenna Factor(35.1 dB/m)

Conclusion: PASS

A.6. Band Edges Compliance

A6.1 Band Edges - conducted

Measurement Limit:

Standard	Limit (dBm/MHz)
FCC 47 CFR Part 15.407(b)(4)	All emissions shall be limited to a level of -27 dBm/MHz at 75 MHz or more above or below the band edge increasing linearly to 10 dBm/MHz at 25 MHz above or below the band edge, and from 25 MHz above or below the band edge increasing linearly to a level of 15.6 dBm/MHz at 5 MHz above or below the band edge, and from 5 MHz above or below the band edge increasing linearly to a level of 27 dBm/MHz at the band edge.

The measurement is made according to KDB 789033 D02

Measurement Uncertainty:

Measurement Uncertainty	0.75dB
-------------------------	--------

Measurement Result:

Mode	Channel	Test Results	Conclusion
802.11a	5745 MHz	Fig.71	P
	5825 MHz	Fig.72	P
802.11n HT20	5745 MHz	Fig.73	P
	5825 MHz	Fig.74	P
802.11ac HT20	5745 MHz	Fig.75	P
	5825 MHz	Fig.76	P
802.11n HT40	5755 MHz	Fig.77	P
	5795 MHz	Fig.78	P
802.11ac HT40	5755 MHz	Fig.79	P
	5795 MHz	Fig.80	P
802.11ac HT80	5775 MHz	Fig.81	P
	5775 MHz	Fig.82	P

Conclusion: PASS

Test graphs as below:

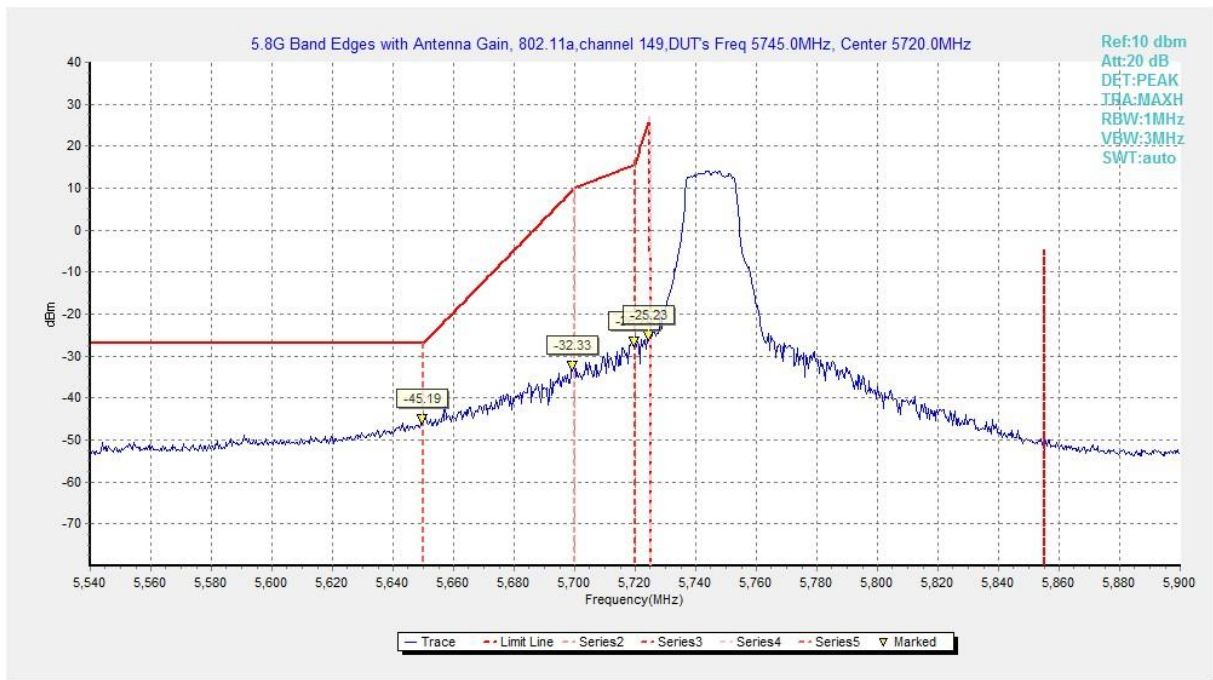

Fig. 71 Band Edges (802.11a, 5745MHz)

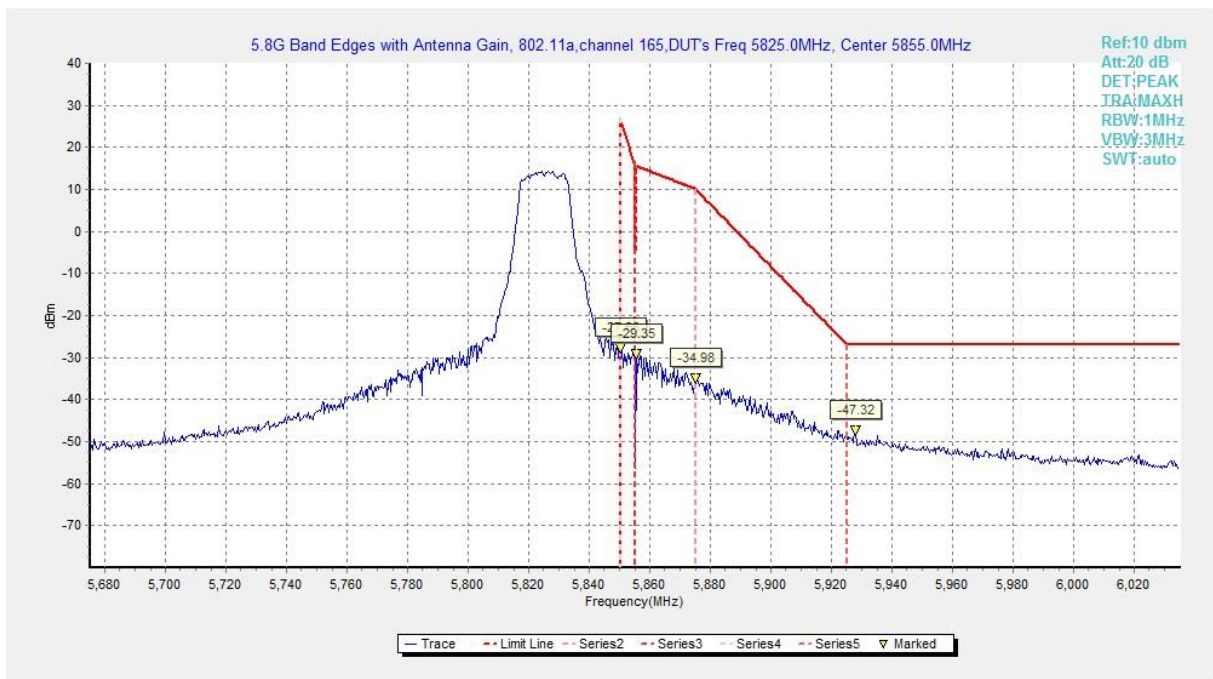

Fig. 72 Band Edges (802.11a, 5825MHz)

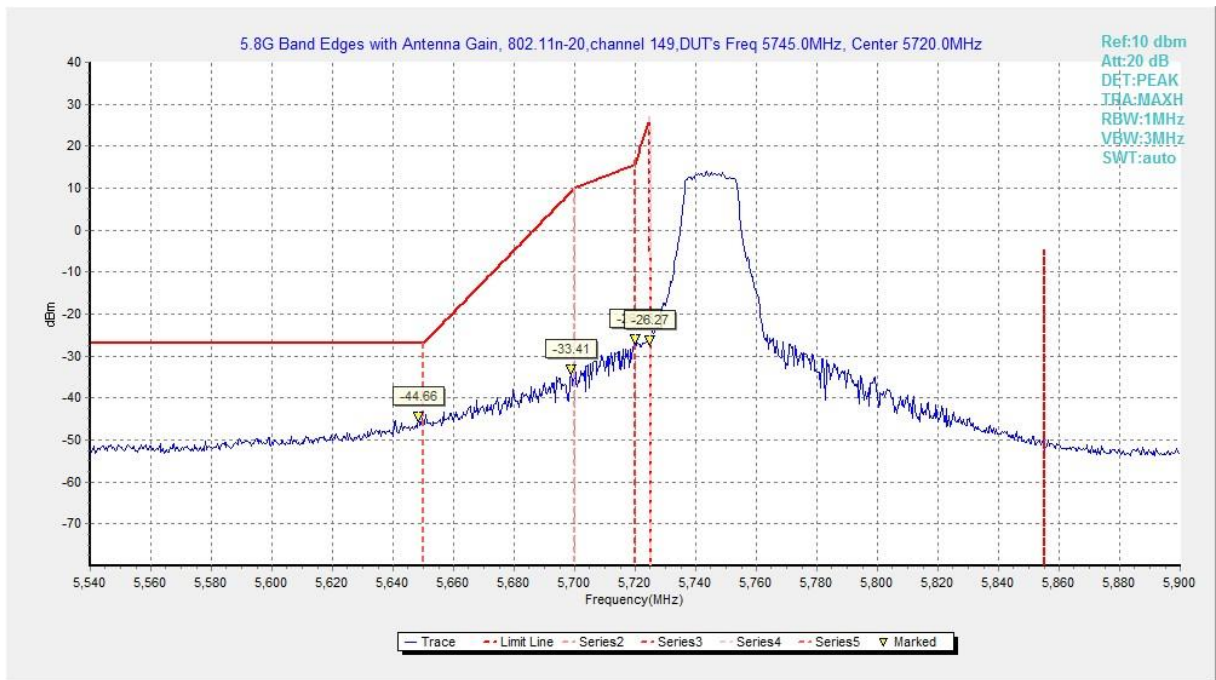

Fig. 73 Band Edges (802.11n-HT20, 5745MHz)

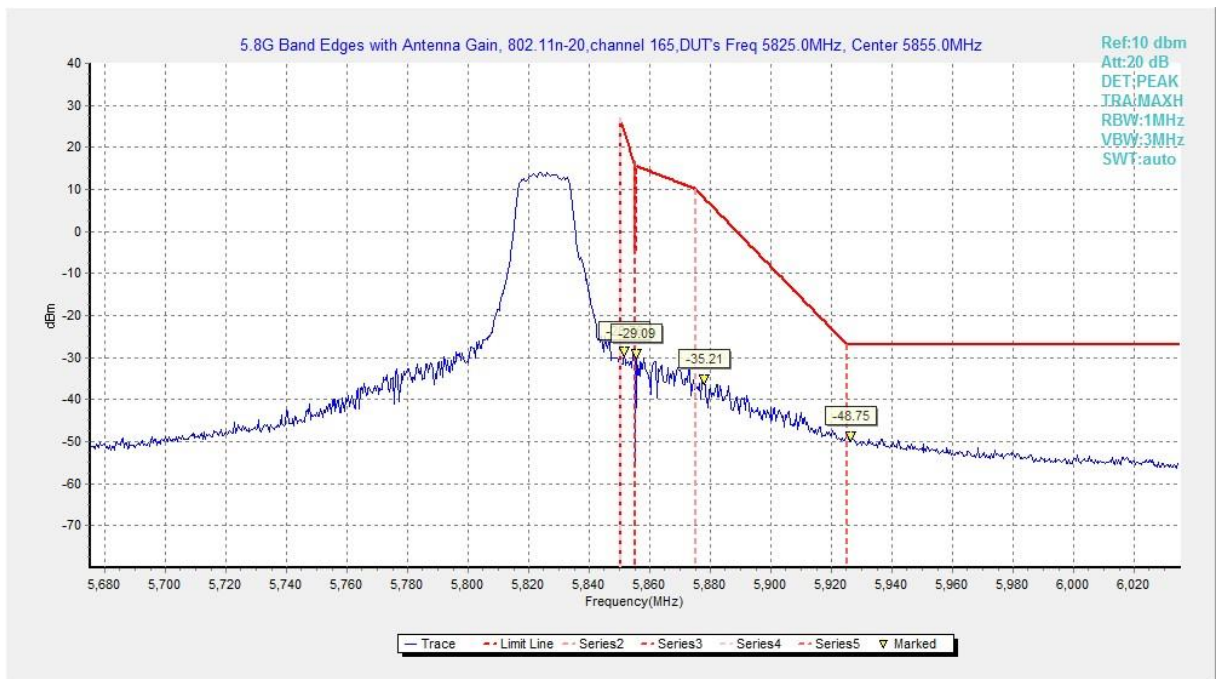

Fig. 74 Band Edges (802.11n-HT20, 5825MHz)

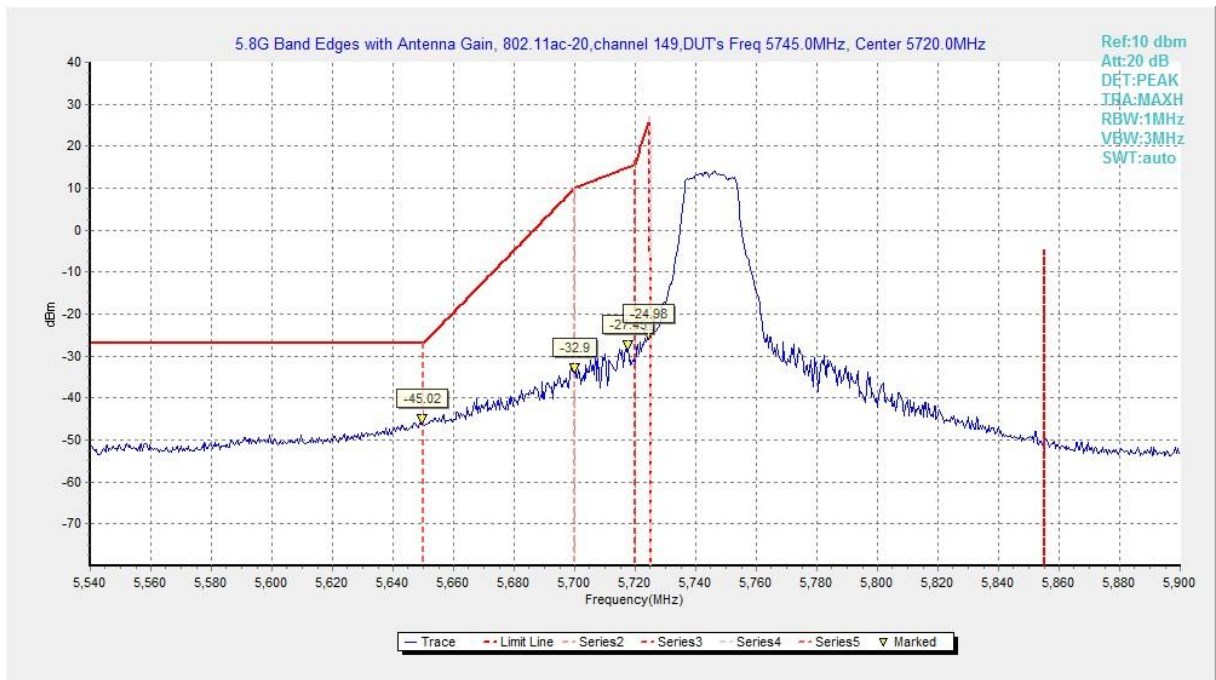

Fig. 75 Band Edges (802.11ac-HT20, 5745MHz)

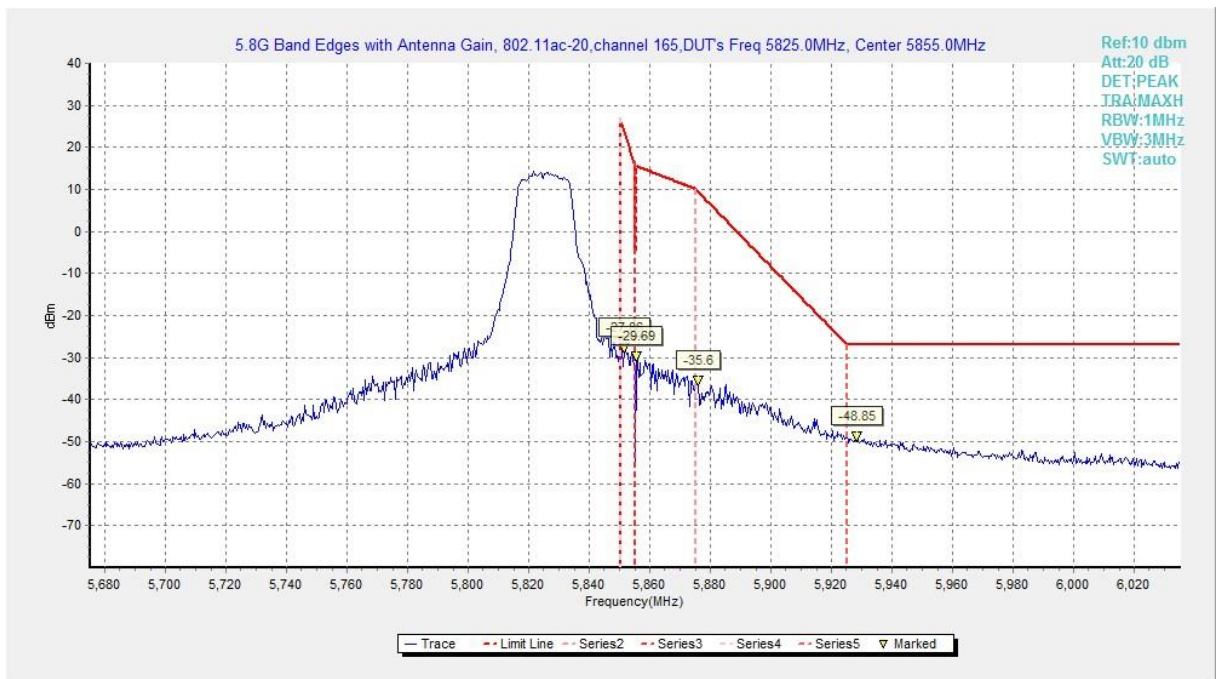

Fig. 76 Band Edges (802.11ac-HT20, 5825MHz)

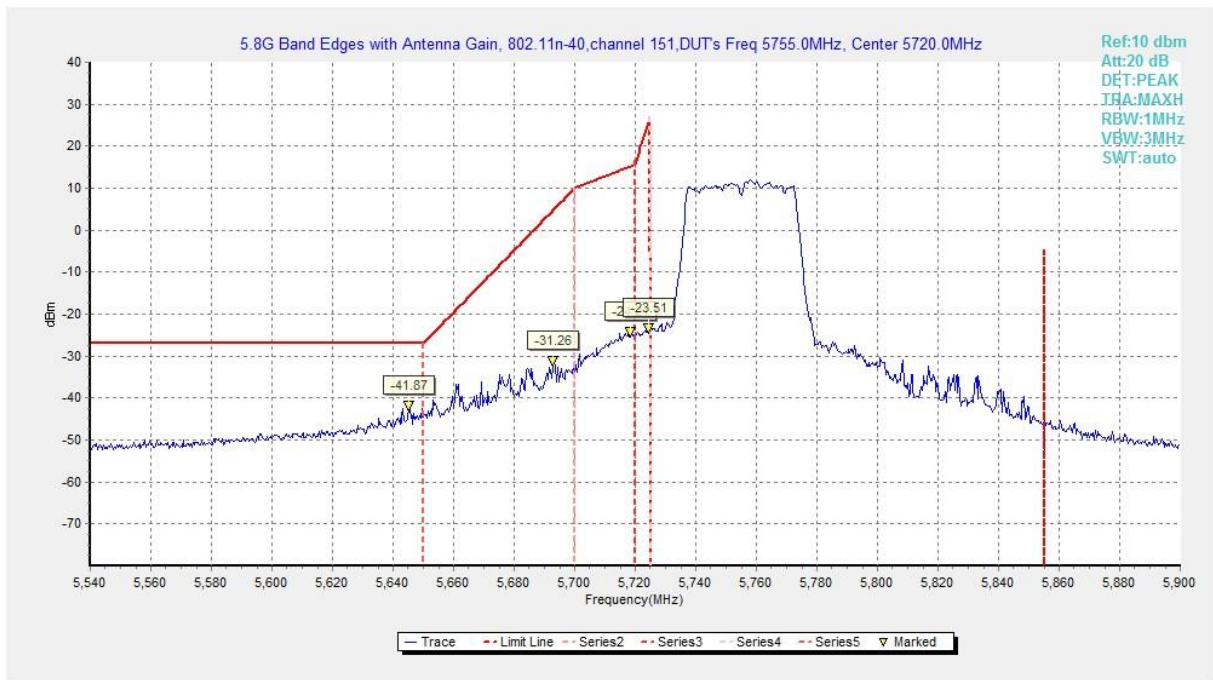

Fig. 77 Band Edges (802.11n-HT40, 5755MHz)

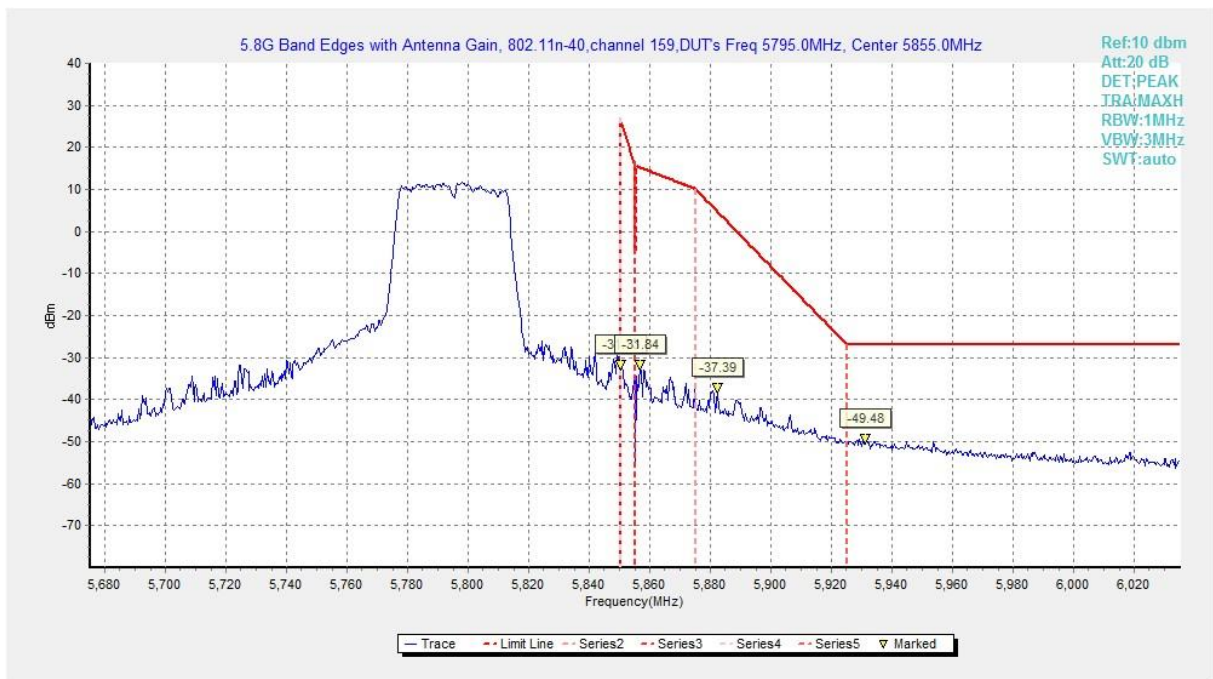

Fig. 78 Band Edges (802.11n-HT40, 5795MHz)

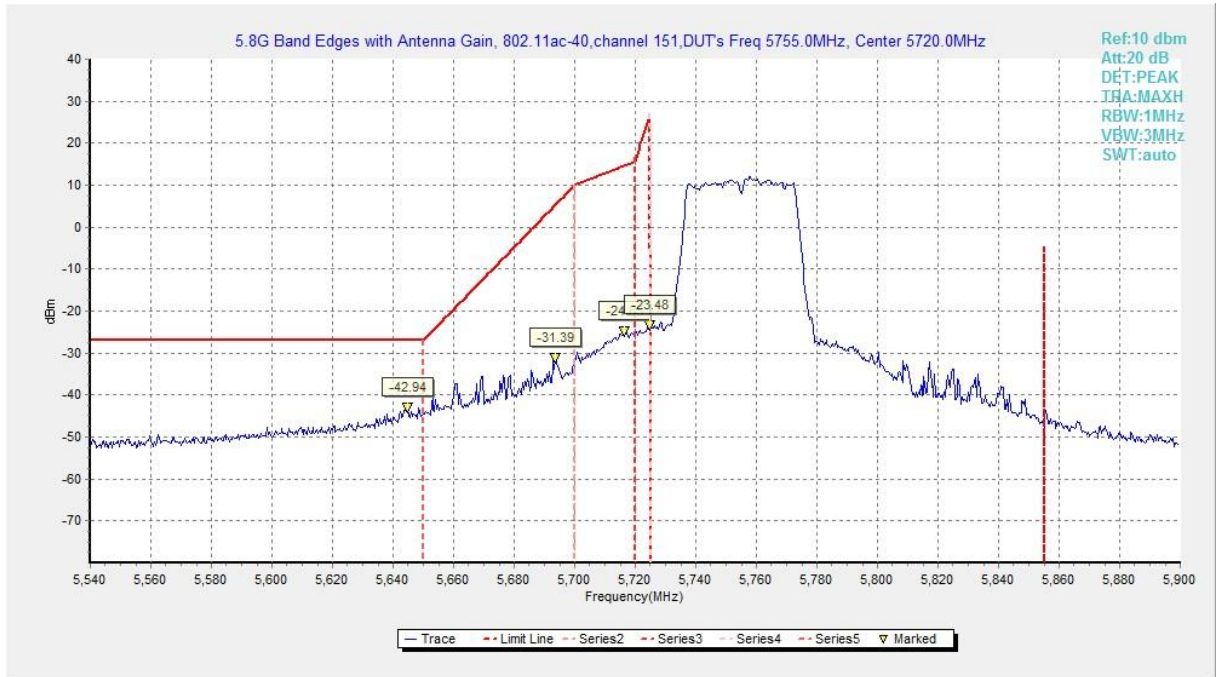

Fig. 79 Band Edges (802.11ac-HT40, 5755MHz)

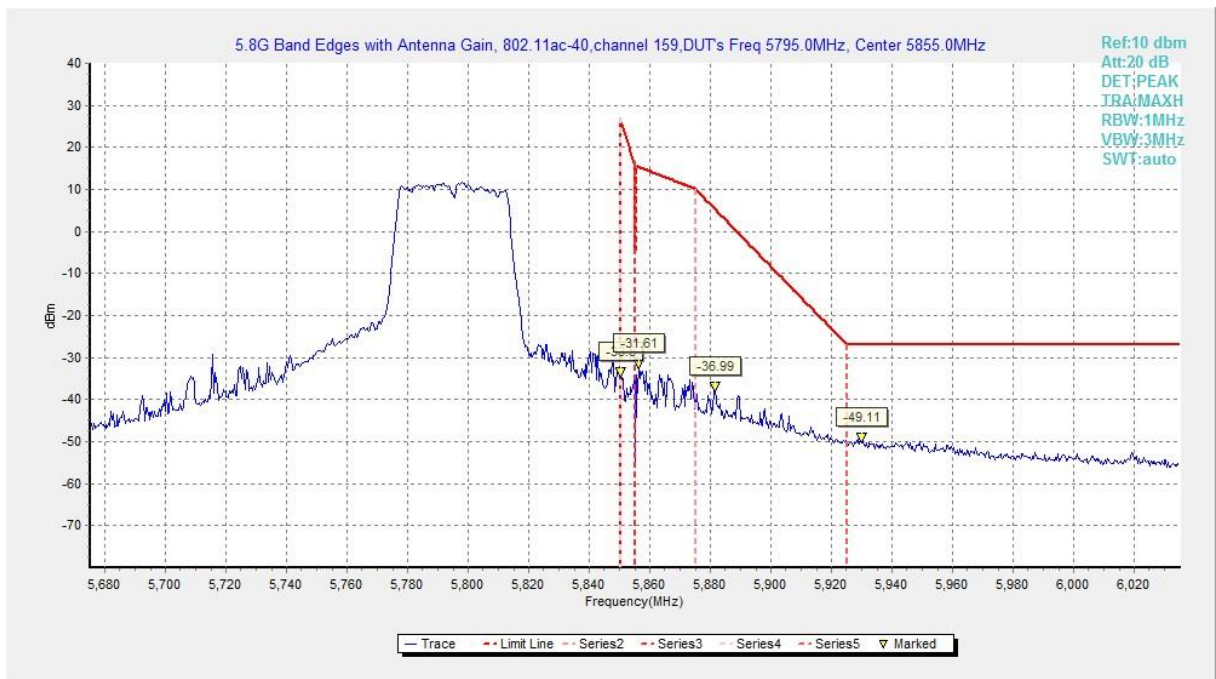

Fig. 80 Band Edges (802.11ac-HT40, 5795MHz)

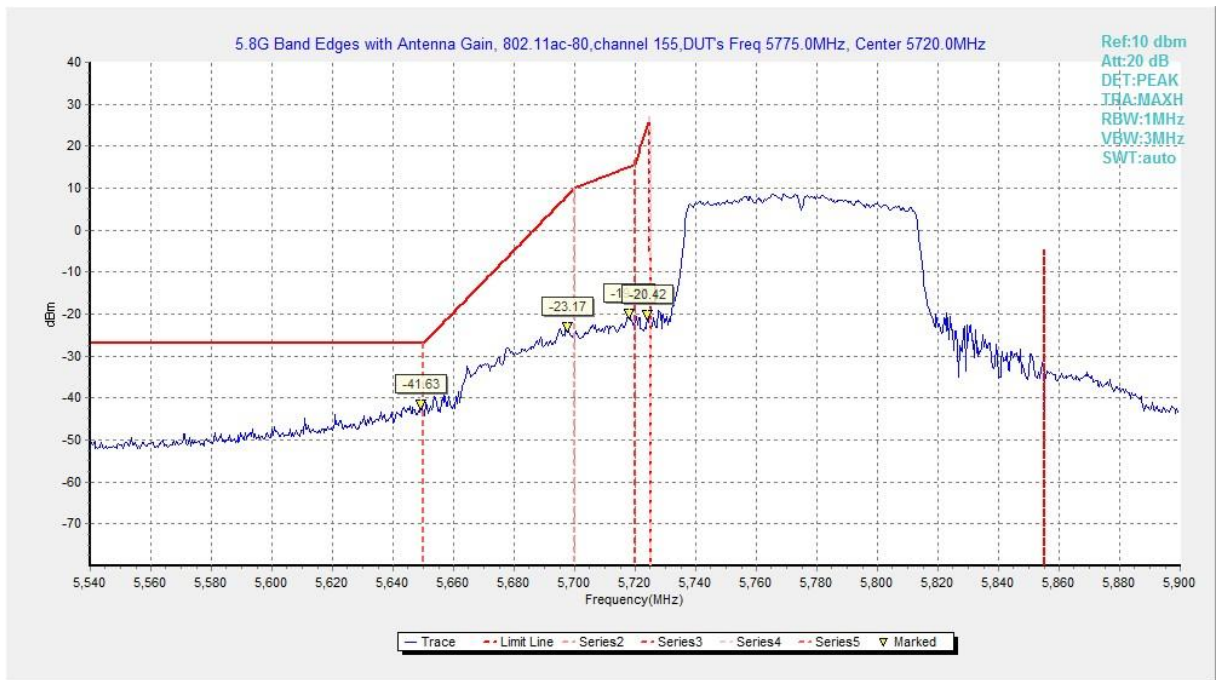

Fig. 81 Band Edges (802.11ac-HT80, 5775MHz)

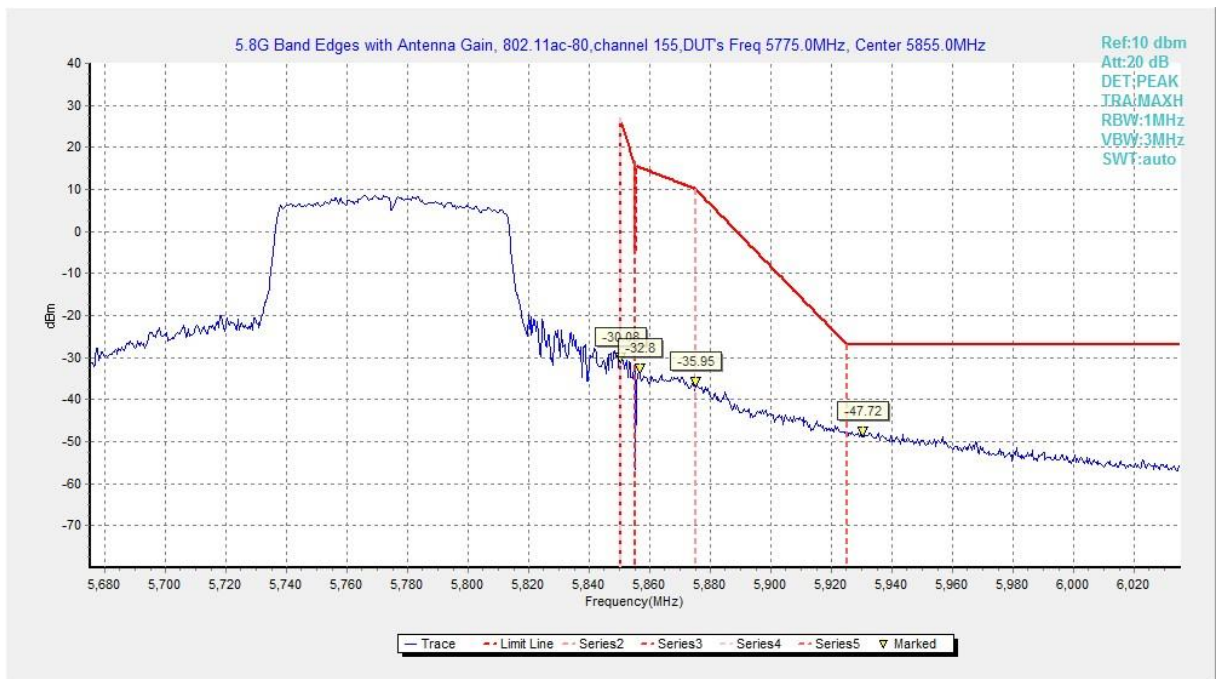

Fig. 82 Band Edges (802.11ac-HT80, 5775MHz)

A6.2 Band Edges - Radiated

Measurement Limit:

Standard	Limit (dBm/MHz)	
FCC 47 CFR Part 15.407	at the band edge	27
	at 5 MHz above or below the band edge	15.6
	at 25 MHz above or below the band edge	10
	at 75 MHz or more above or below the band edge	-27
	Note: increasing linearly from point to point.	

The measurement is made according to KDB 789033 D02

In addition, radiated emissions which fall in the restricted bands, as defined in § 15.205(a), must also comply with the radiated emission limits specified in § 15.209(a) (see § 15.205(c)).

Set up:

Figure 4 shows the typical arrangement of an unlicensed wireless device on a tabletop on a test site. Tabletop devices shall be placed on a nonconducting platform with nominal top surface dimensions 1 m by 1.5 m and the table height shall be 1.5 m.

The EUT and transmitting antenna shall be centered on the turntable.

Test Condition

The EUT shall be tested 1 near top, 1 near middle, and 1 near bottom. Set the unlicensed wireless device to operate in continuous transmit mode. For unlicensed wireless devices unable to be configured for 100% duty cycle even in test mode, configure the system for the maximum duty cycle supported.

When required for unlicensed wireless devices, measurements of the variation of the input power or the radiated signal level of the fundamental frequency component of the emission, as appropriate, shall be performed with the supply voltage varied between 85% and 115% of the nominal rated supply voltage.

Exploratory radiated emissions measurements

Exploratory radiated measurements shall be performed at the measurement distance or at a closer distance than that specified for compliance to determine the emission characteristics of the EUT and, if applicable, the EUT configuration that produces the maximum level of emissions. The frequencies of maximum emission may be determined by manually positioning the antenna close to the EUT, and then moving the antenna over all sides of the EUT while observing a spectral display. It is advantageous to have prior knowledge of the frequencies of emissions, although this may be determined from such a near-field scan. The near-field scan shall only be used to determine the frequency but not the amplitude of the emissions. Where exploratory measurements are not adequate to determine the worst-case operating modes and are used only to identify the frequencies of the highest emissions, additional preliminary tests can be required.

For emissions from the EUT, the maximum level shall be determined by rotating the EUT and its antenna through 0° to 360°. For each mode of operation required to be tested, the frequency spectrum (based on findings from exploratory measurements) shall be monitored.

Broadband antennas and a spectrum analyzer or a radio-noise meter with a panoramic display are

often useful in this type of test. If either antenna height or EUT azimuth are not fully measured during exploratory testing, then complete testing can be required at the OATS or semi-anechoic chamber when the final full spectrum testing is performed.

Final radiated emissions measurements

The final measurements are using the orientation and equipment arrangement of the EUT based on the measurement results found during the preliminary (exploratory) measurements, the EUT arrangement, appropriate modulation, and modes of operation that produce the emissions that have the highest amplitude relative to the limit shall be selected for the final measurement. For emissions from the EUT, the maximum level shall be determined by rotating the EUT and its antenna through 0° to 360°. Final measurements for the EUT require a measurement antenna height scan of 1 m to 4 m and the antenna rotated to repeat the measurements for both the horizontal and vertical antenna polarizations. For each mode of operation required to be tested, the frequency spectrum (based on findings from exploratory measurements) shall be monitored. For each mode selected, record the frequency and amplitude of the highest fundamental emission (if applicable), as well as the frequency and amplitude of the six highest spurious emissions relative to the limit. Emissions more than 20 dB below the limit do not need to be reported. This maximization process was repeated with the EUT positioned in each of its three orthogonal orientations.

The receiver references:

Frequency of emission (MHz)	RBW/VBW	Sweep Time(s)
30-1000	100KHz/300KHz	5
1000-4000	1MHz/3MHz	15
4000-18000	1MHz/3MHz	40
18000-40000	1MHz/3MHz	20

EUT ID: EUT1

Measurement Result:

Mode	Channel	Test Results	Conclusion
802.11a	5745 MHz	Fig.83	P
	5825 MHz	Fig.84	P
802.11n HT20	5745 MHz	Fig.85	P
802.11ac HT20	5745 MHz	Fig.86	P
	5825 MHz	Fig.87	P
	5825 MHz	Fig.88	P
802.11n HT40	5755 MHz	Fig.89	P
	5795 MHz	Fig.90	P
802.11ac	5755 MHz	Fig.91	P

HT40	5795 MHz	Fig.92	P
802.11ac HT80	5775 MHz	Fig.93	P
	5775 MHz	Fig.94	P

Conclusion: PASS
Test graphs as below:

RE - Power-5.650GHz-5.765GHz

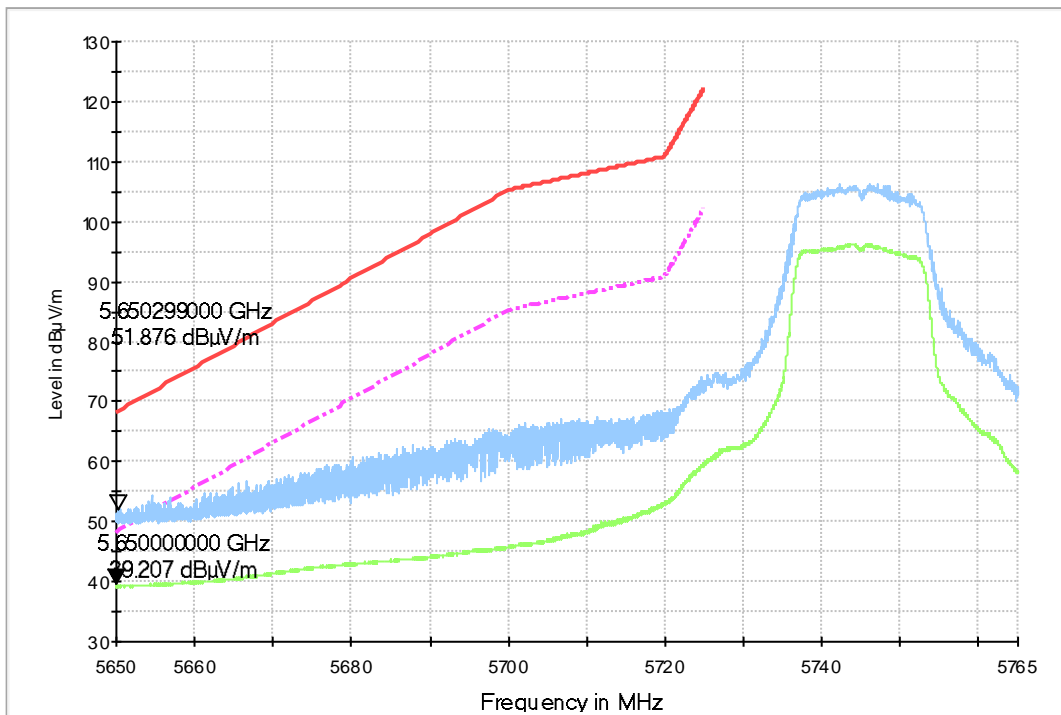

Fig. 83 Band Edges (802.11a, 5745MHz)

RE - Power-5.810GHz-5.925GHz

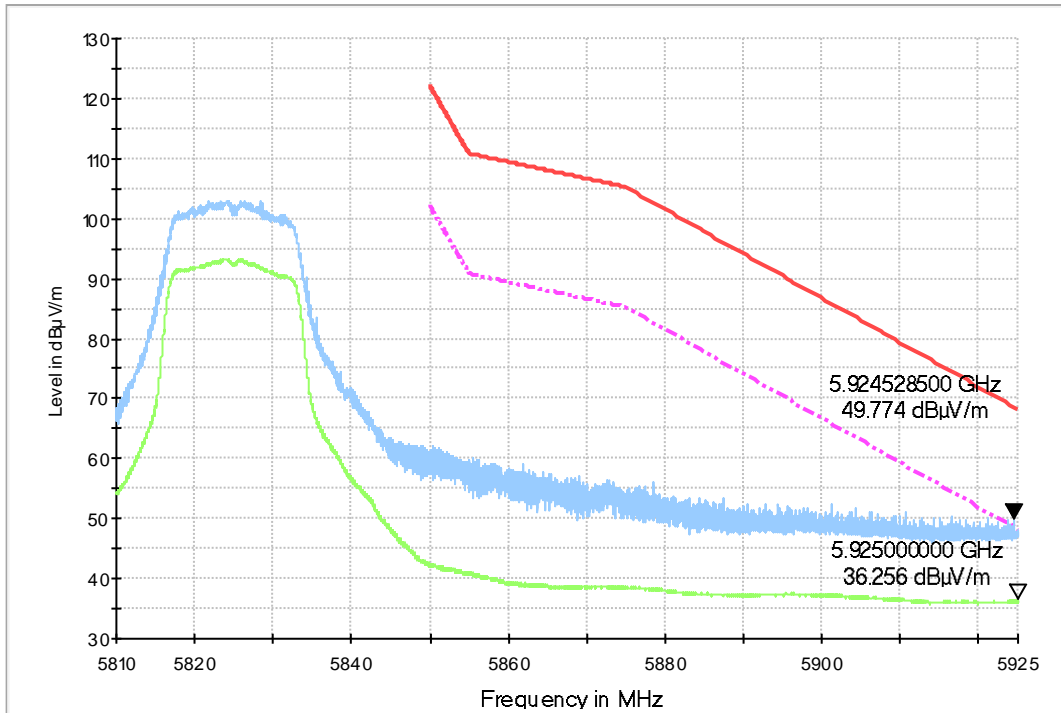

Fig. 84 Band Edges (802.11a, 5825MHz)

RE - Power-5.650GHz-5.765GHz

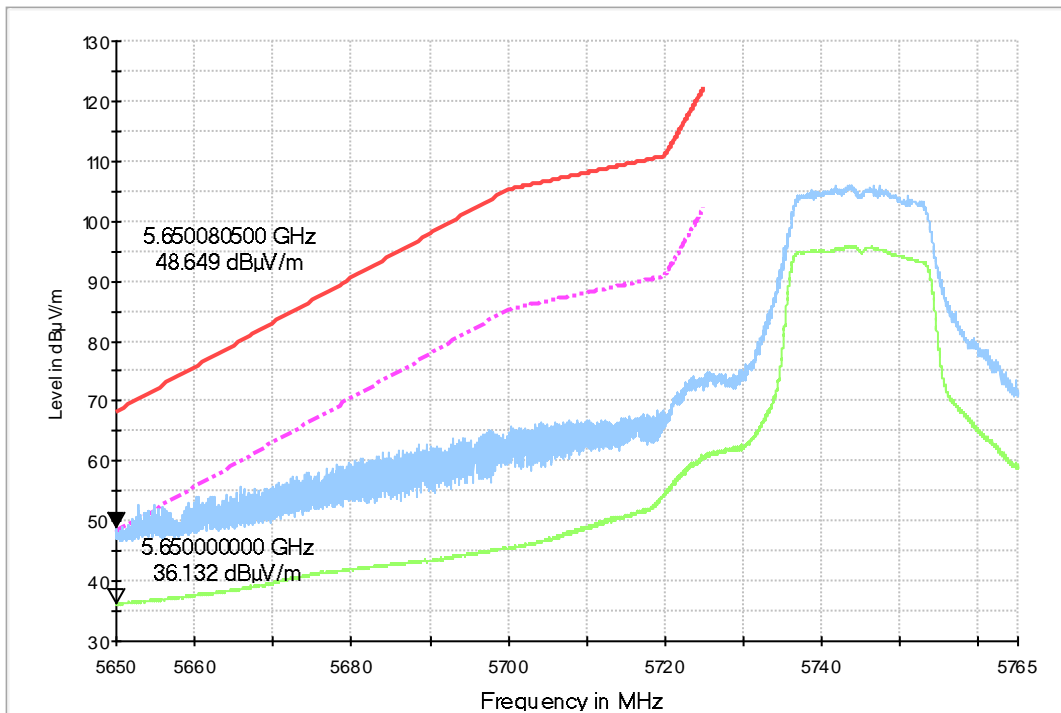

Fig. 85 Band Edges (802.11n-HT20, 5745MHz)

RE - Power-5.810GHz-5.925GHz

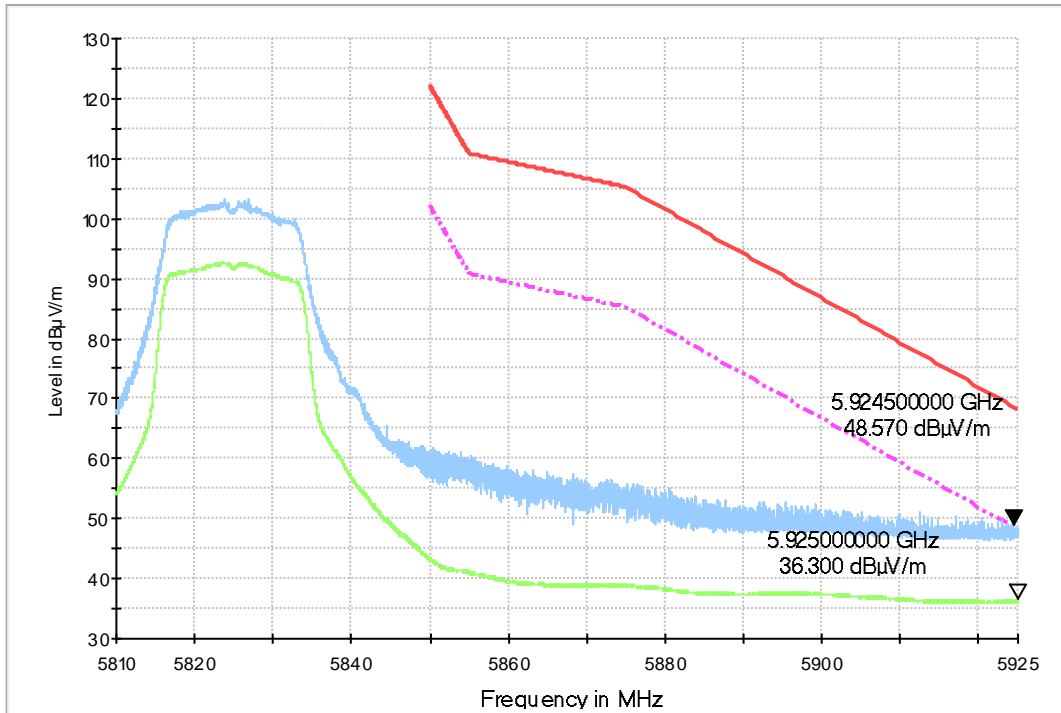

Fig. 86 Band Edges (802.11n-HT20, 5825MHz)

RE - Power-5.650GHz-5.765GHz

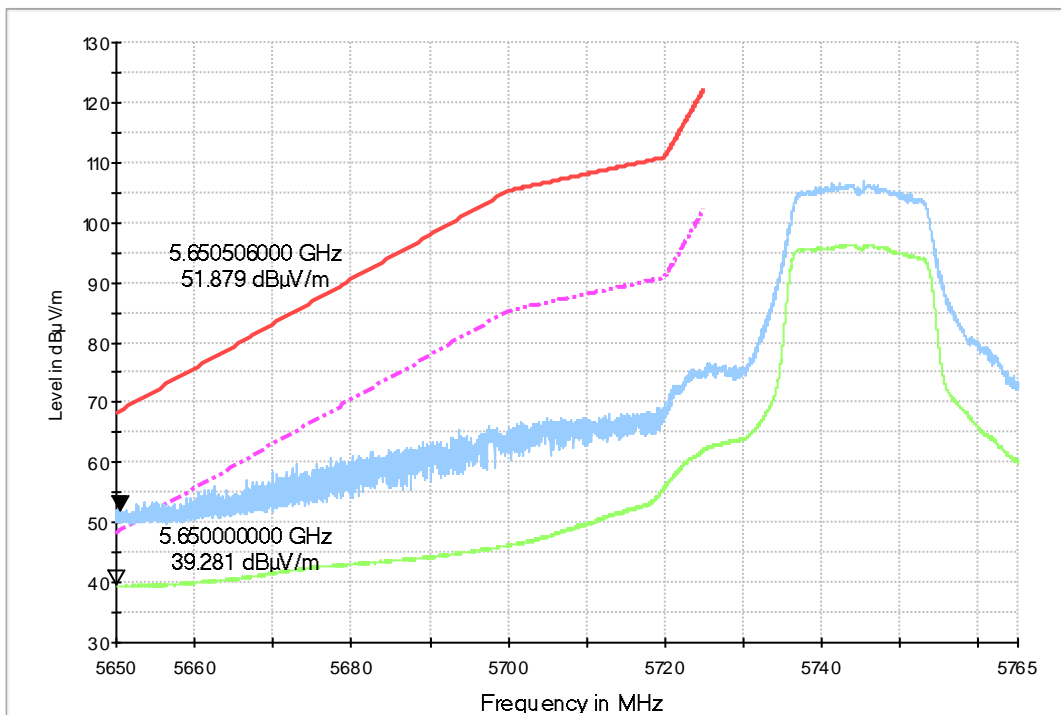

Fig. 87 Band Edges (802.11ac-HT20, 5745MHz)

RE - Power-5.810GHz-5.925GHz

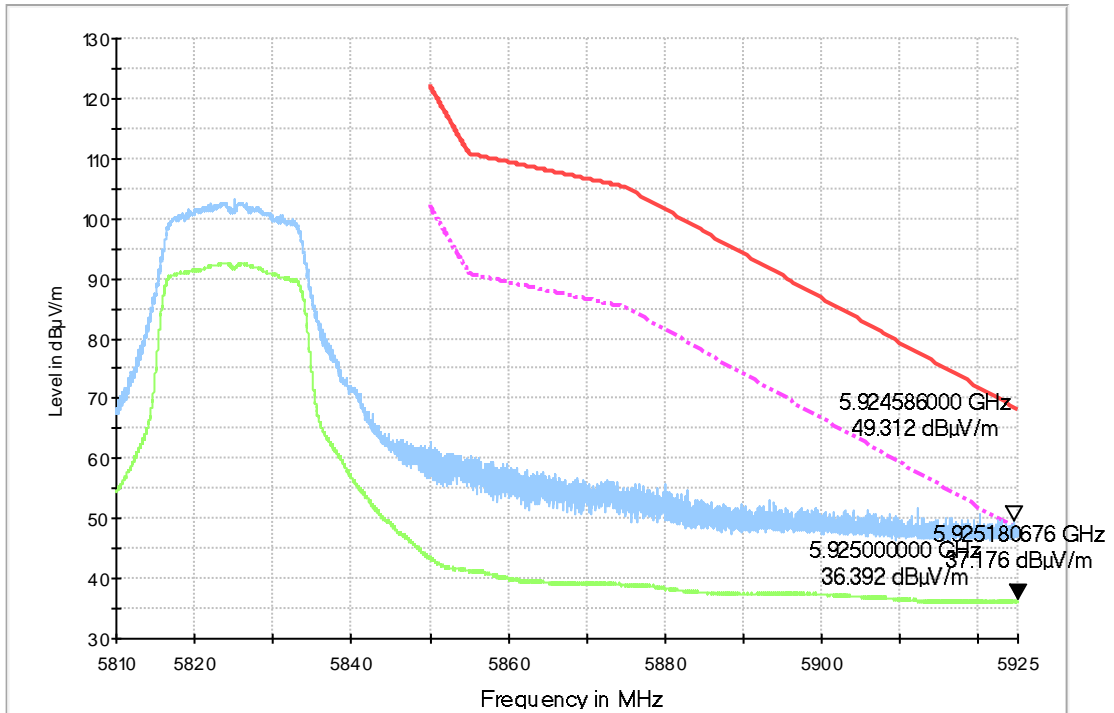

Fig. 88 Band Edges (802.11ac-HT20, 5825MHz)

RE - Power-5.650GHz-5.765GHz

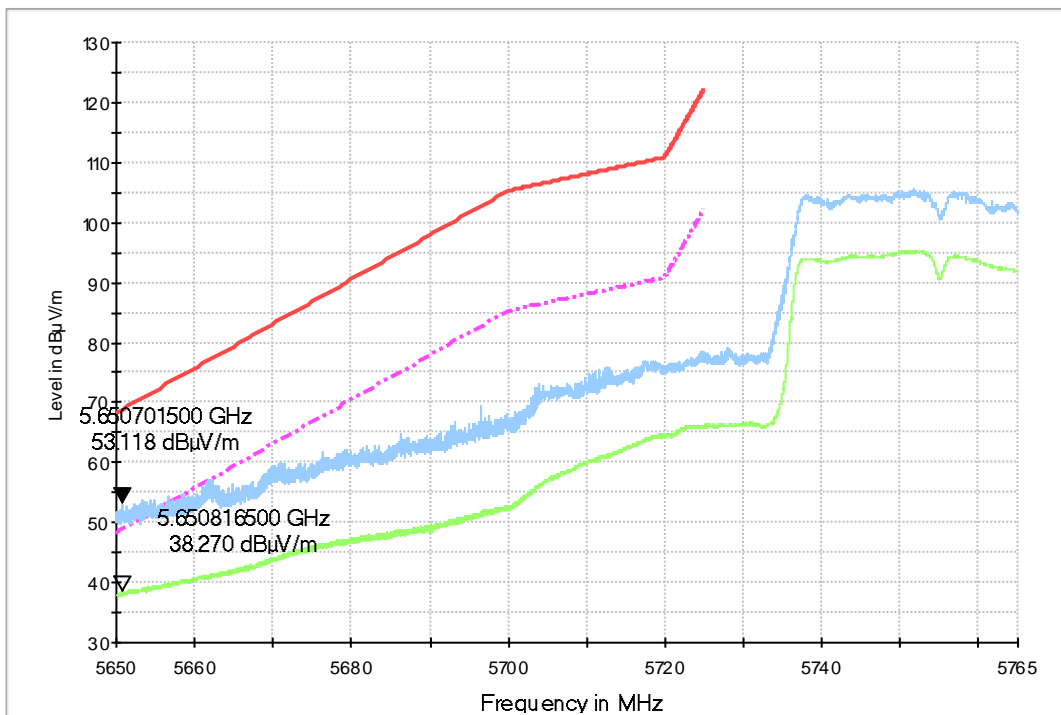

Fig. 89 Band Edges (802.11n-HT40, 5755MHz)

RE - Power-5.810GHz-5.925GHz

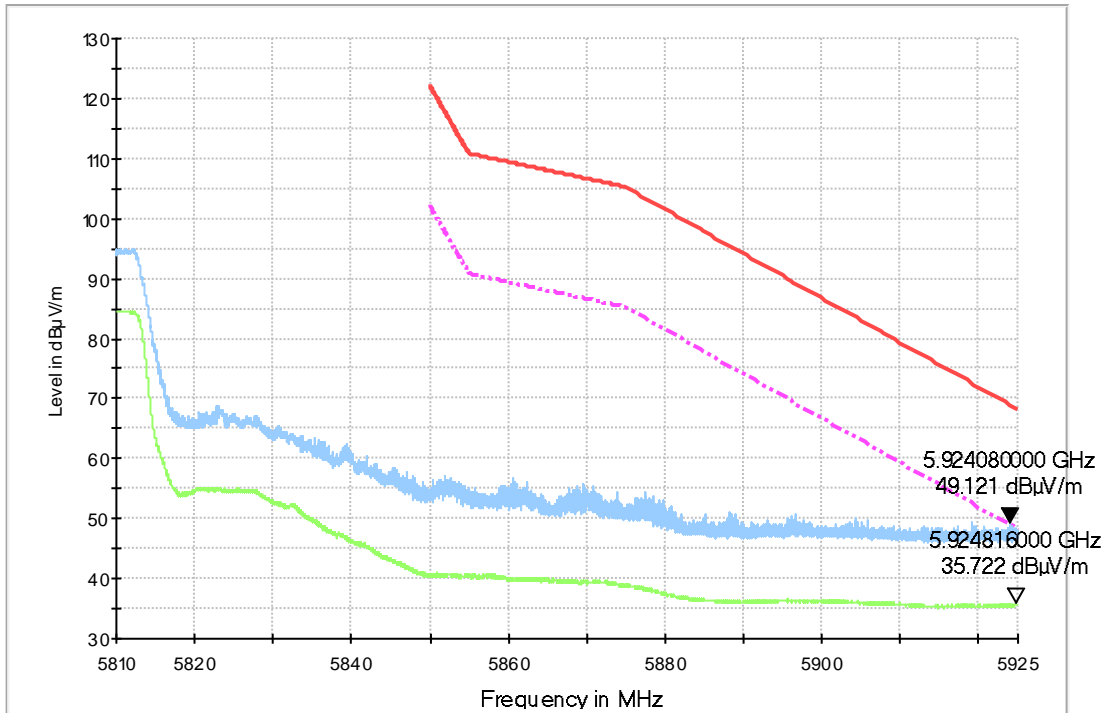

Fig. 90 Band Edges (802.11n-HT40, 5795MHz)

RE - Power-5.650GHz-5.765GHz

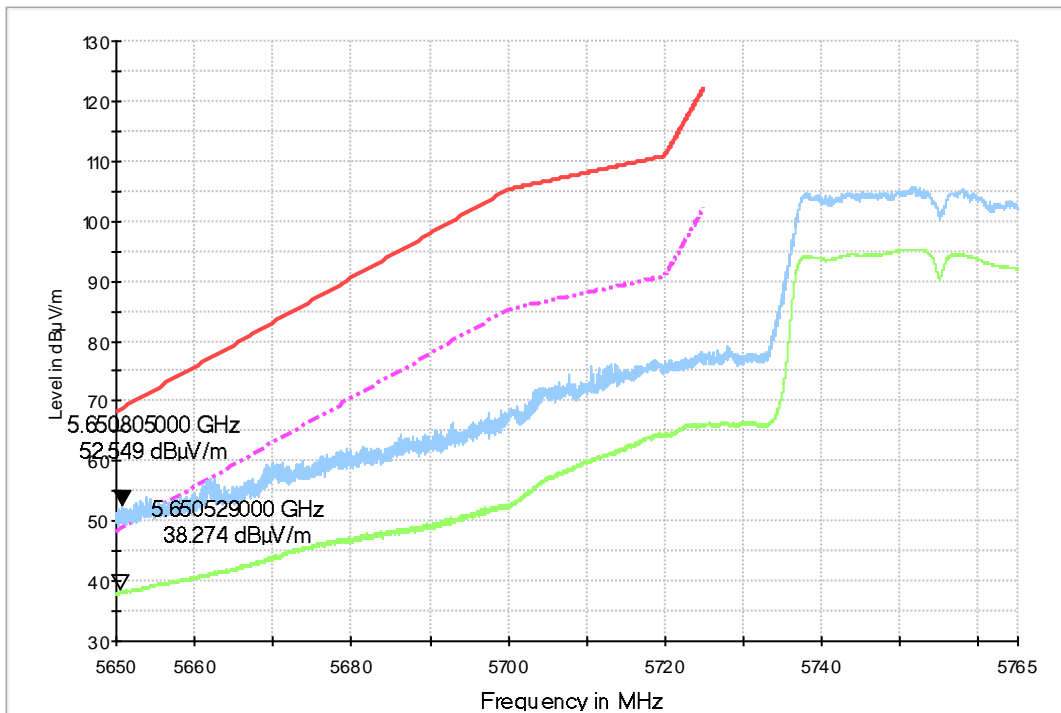

Fig. 91 Band Edges (802.11ac-HT40, 5755MHz)

RE - Power-5.810GHz-5.925GHz

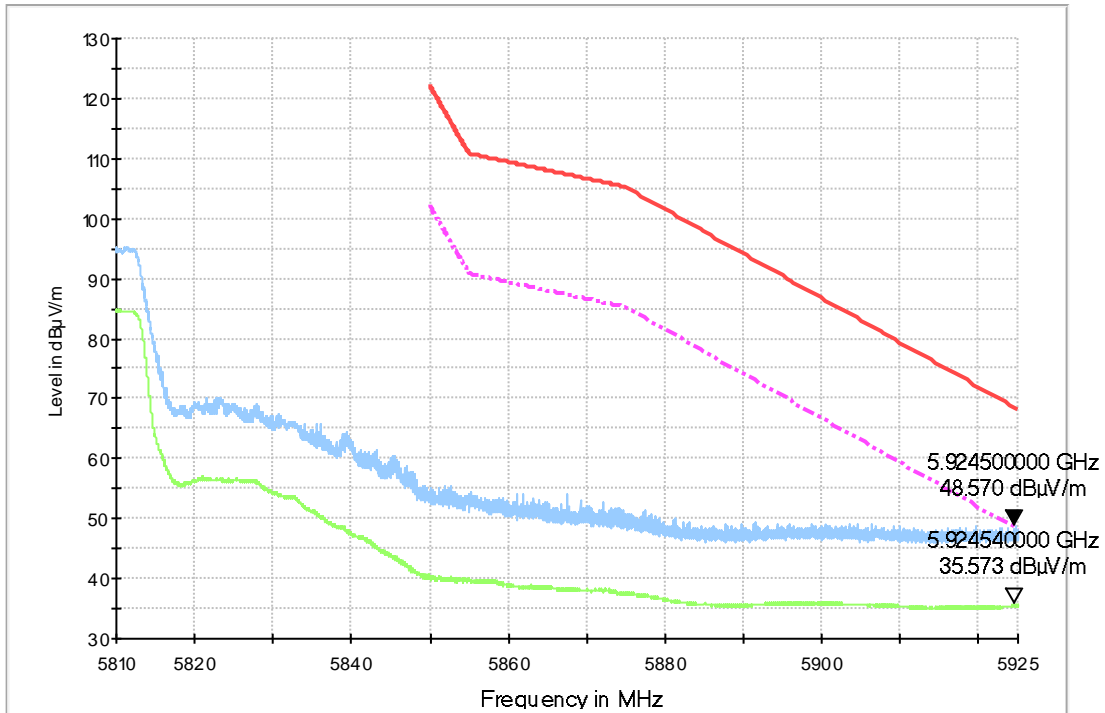

Fig. 92 Band Edges (802.11ac-HT40, 5795MHz)

RE - Power-5.650GHz-5.765GHz

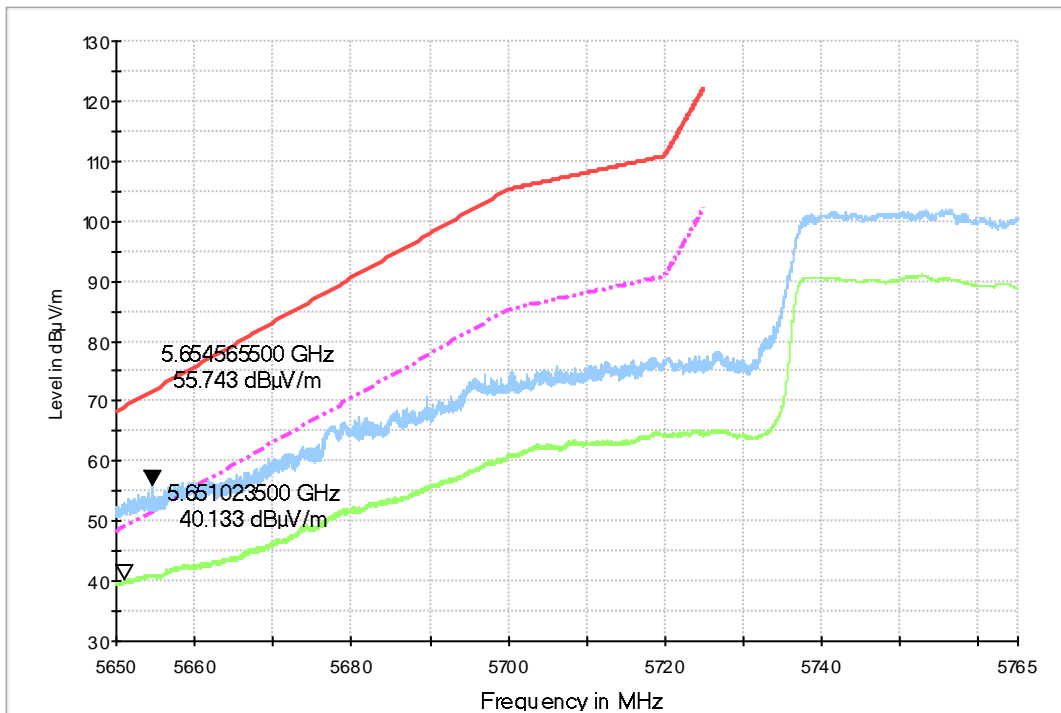

Fig. 93 Band Edges (802.11ac-HT80, 5775MHz)

RE - Power-5.810GHz-5.925GHz

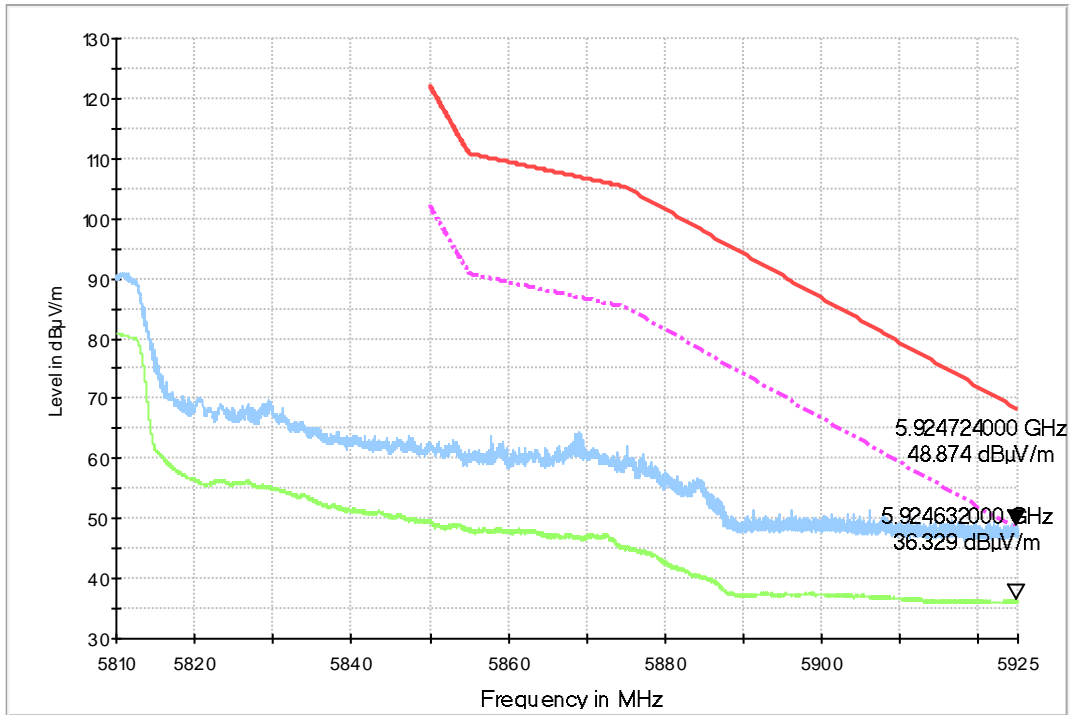

Fig. 94 Band Edges (802.11ac-HT80, 5775MHz)

A.7. AC Powerline Conducted Emission

Method of Measurement: See ANSI C63.10-2013-clause 6.2

Setup:

A stand-alone EUT shall be placed in the center along the back edge of the tabletop. For multiunit tabletop systems, the EUT shall be centered laterally (left to right facing the tabletop) on the tabletop and its rear shall be flush with the rear of the table.

Accessories that are part of an EUT system tested on a tabletop shall be placed in a test arrangement on one or both sides of the host with a 10 cm separation between the nearest points of the cabinets. The rear of the host and accessories shall be flush with the back of the supporting tabletop unless that would not be typical of normal use. If more than two accessories are present, then an equipment test arrangement shall be chosen that maintains 10 cm spacing between cabinets unless the equipment is normally located closer together.

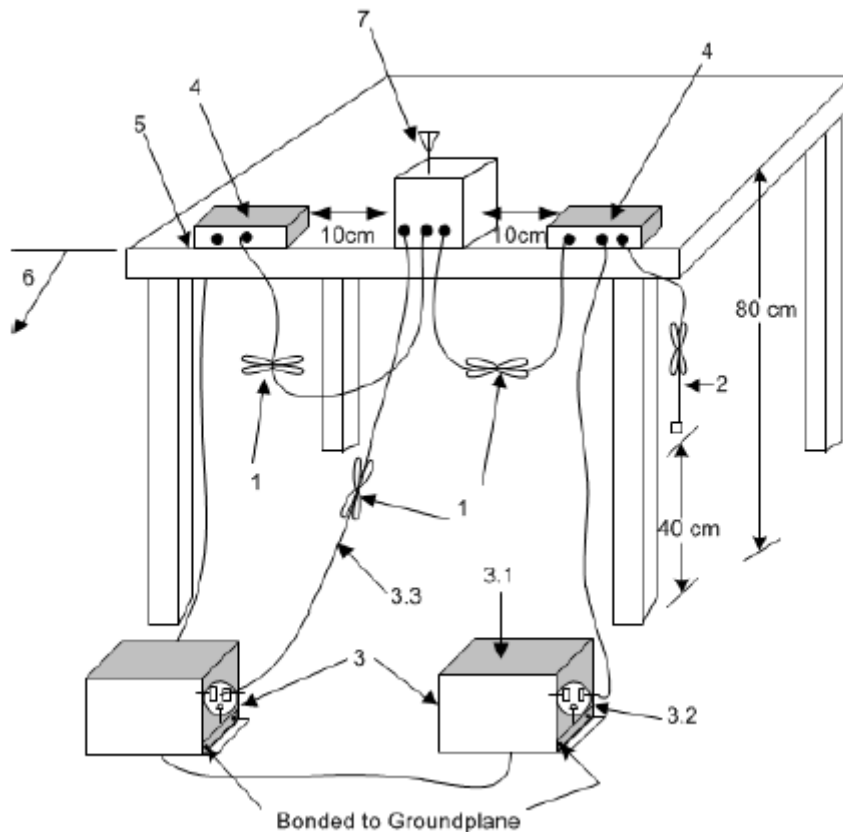

Exploratory ac power-line conducted emission measurements

Exploratory measurements shall be used to identify the frequency of the emission that has the highest amplitude relative to the limit by operating the EUT in a range of typical modes of operation, cable positions, and with a typical system equipment configuration and arrangement. For each mode of operation and for each ac power current-carrying conductor, cable manipulation shall be performed within the range of likely configurations. For this measurement or series of measurements, the frequency spectrum of interest shall be monitored looking for the emission that has the highest amplitude relative to the limit. Once that emission is found for each current-carrying conductor of each power cord associated with the EUT (but not the cords associated with non-EUT equipment in the overall system), the one configuration and

arrangement and mode of operation that produces the emission closest to the limit over all of the measured conductors shall be recorded.

Final ac power-line conducted emission measurements

Based on the exploratory tests of the EUT, the one EUT cable configuration and arrangement and mode of operation that produced the emission with the highest amplitude relative to the limit is selected for the final measurement, while applying the appropriate modulating signal to the EUT. If the EUT is relocated from an exploratory test site to a final test site, the highest emissions shall be remaximized at the final test location before final ac power-line conducted emission measurements are performed. The final test on all current-carrying conductors of all of the power cords to the equipment that comprises the EUT (but not the cords associated with other non-EUT equipment in the system) is then performed for the full frequency range for which the EUT is being tested for compliance without further variation of the EUT arrangement, cable positions, or EUT mode of operation. If the EUT is composed of equipment units that have their own separate ac power connections (e.g., floor-standing equipment with independent power cords for each shelf that are able to connect directly to the ac power network), then each current-carrying conductor of one unit is measured while the other units are connected to a second (or more) LISN(s). All units shall be measured separately. If a power strip is provided by the manufacturer, to supply all of the units making up the EUT, only the conductors in the power cord of the power strip shall be measured.

Test Condition:

Voltage (V)	Frequency (Hz)
120	60

Measurement uncertainty:

Expanded measurement uncertainty for this test item is $U = 3.2\text{dB}$, $k=2$.

Measurement Result and limit:

WLAN (Quasi-peak Limit)

Frequency range (MHz)	Quasi-peak Limit (dB μ V)	Result (dB μ V)		Conclusion
		With charger		
		802.11a	Idle	
0.15 to 0.5	66 to 56	Fig. 95	Fig. 96	P
0.5 to 5	56			
5 to 30	60			

NOTE: The limit decreases linearly with the logarithm of the frequency in the range 0.15 MHz to 0.5 MHz.

WLAN (Average Limit)

Frequency range (MHz)	Average Limit (dB μ V)	Result (dB μ V)		Conclusion
		With charger		
		802.11a	Idle	
0.15 to 0.5	56 to 46	Fig.95	Fig.96	P
0.5 to 5	46			
5 to 30	50			

NOTE: The limit decreases linearly with the logarithm of the frequency in the range 0.15 MHz to 0.5 MHz.

The measurement is made according to ANSI C63.10 .

Conclusion: PASS

Test graphs as below:

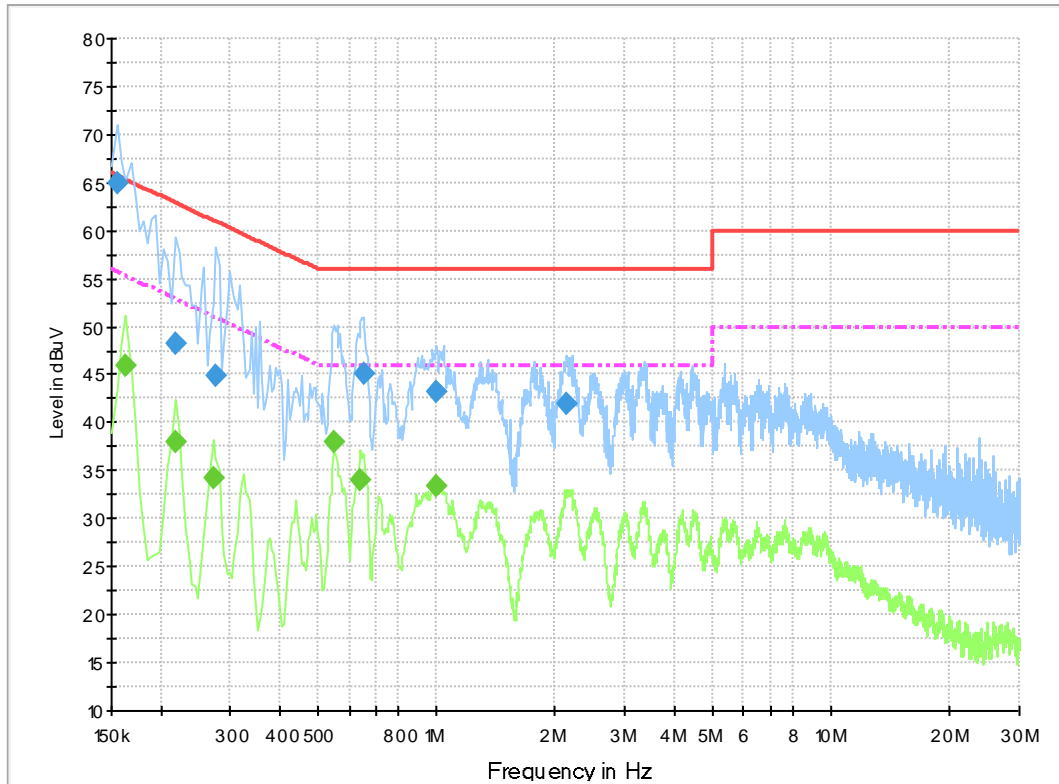

Fig. 95 AC Powerline Conducted Emission-802.11a

Final Result 1

Frequency (MHz)	QuasiPeak (dB μ V)	Line	Margin (dB)	Limit (dB μ V)
0.154500	64.9	N	0.9	65.8
0.217500	48.3	N	14.6	62.9
0.276000	44.9	L1	16.1	60.9
0.654000	45.0	L1	11.0	56.0
1.000500	43.3	L1	12.7	56.0
2.139000	41.9	L1	14.1	56.0

Final Result 2

Frequency (MHz)	Average (dB μ V)	Line	Margin (dB)	Limit (dB μ V)
0.163500	45.9	L1	9.4	55.3
0.217500	37.9	L1	15.0	52.9
0.271500	34.2	L1	16.8	51.1
0.550500	38.0	N	8.0	46.0
0.640500	34.0	L1	12.0	46.0
1.000500	33.4	L1	12.6	46.0

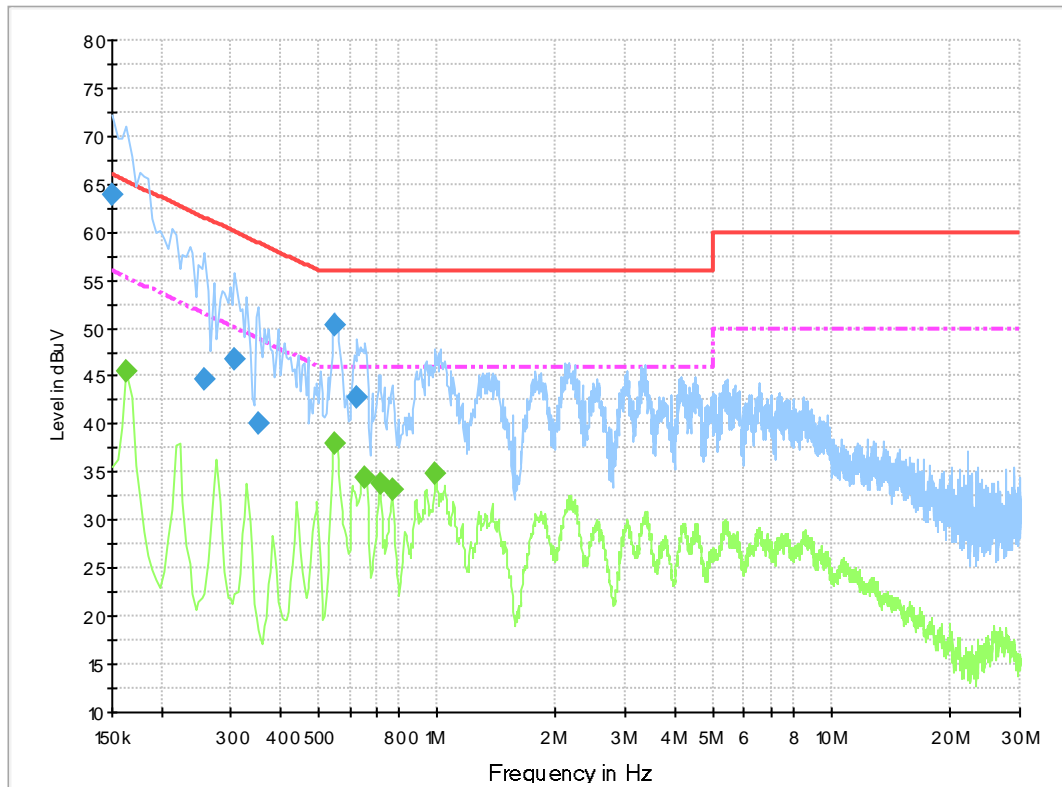

Fig. 96 AC Powerline Conducted Emission-Idle

Final Result 1

Frequency (MHz)	QuasiPeak (dBuV)	Line	Margin (dB)	Limit (dBuV)
0.150000	63.9	N	2.1	66.0
0.258000	44.8	N	16.7	61.5
0.307500	46.7	L1	13.3	60.0
0.352500	40.1	N	18.8	58.9
0.550500	50.4	L1	5.6	56.0
0.627000	42.7	L1	13.3	56.0

Final Result 2

Frequency (MHz)	Average (dBuV)	Line	Margin (dB)	Limit (dBuV)
0.163500	45.4	N	9.8	55.3
0.550500	38.0	N	8.0	46.0
0.658500	34.4	N	11.6	46.0
0.717000	33.9	L1	12.1	46.0
0.771000	33.2	L1	12.8	46.0
0.991500	34.8	L1	11.2	46.0

ANNEX B: Accreditation Certificate

<p>United States Department of Commerce National Institute of Standards and Technology</p> 	
<hr/> Certificate of Accreditation to ISO/IEC 17025:2005 <hr/>	
NVLAP LAB CODE: 600118-0	
Telecommunication Technology Labs, CAICT Beijing China	
<i>is accredited by the National Voluntary Laboratory Accreditation Program for specific services, listed on the Scope of Accreditation, for:</i>	
Electromagnetic Compatibility & Telecommunications	
<i>This laboratory is accredited in accordance with the recognized International Standard ISO/IEC 17025:2005. This accreditation demonstrates technical competence for a defined scope and the operation of a laboratory quality management system (refer to joint ISO-ILAC-IAF Communique dated January 2009).</i>	
<hr/> 2019-09-26 through 2020-09-30 <i>Effective Dates</i>	 For the National Voluntary Laboratory Accreditation Program

*** END OF REPORT BODY ***