

Fig.A.6.1.69 Transmitter Spurious Emission - Conducted (802.11n-HT20, Ch11, 7.5 GHz-10 GHz)

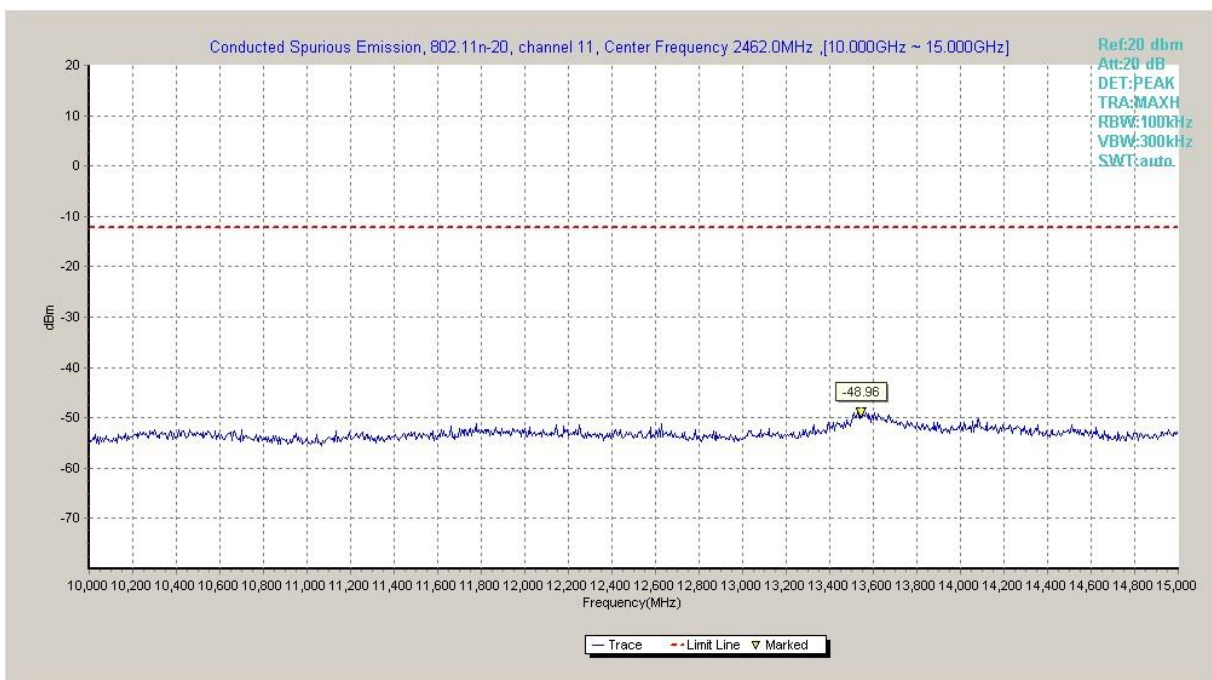

Fig.A.6.1.70 Transmitter Spurious Emission - Conducted (802.11n-HT20, Ch11, 10 GHz-15 GHz)

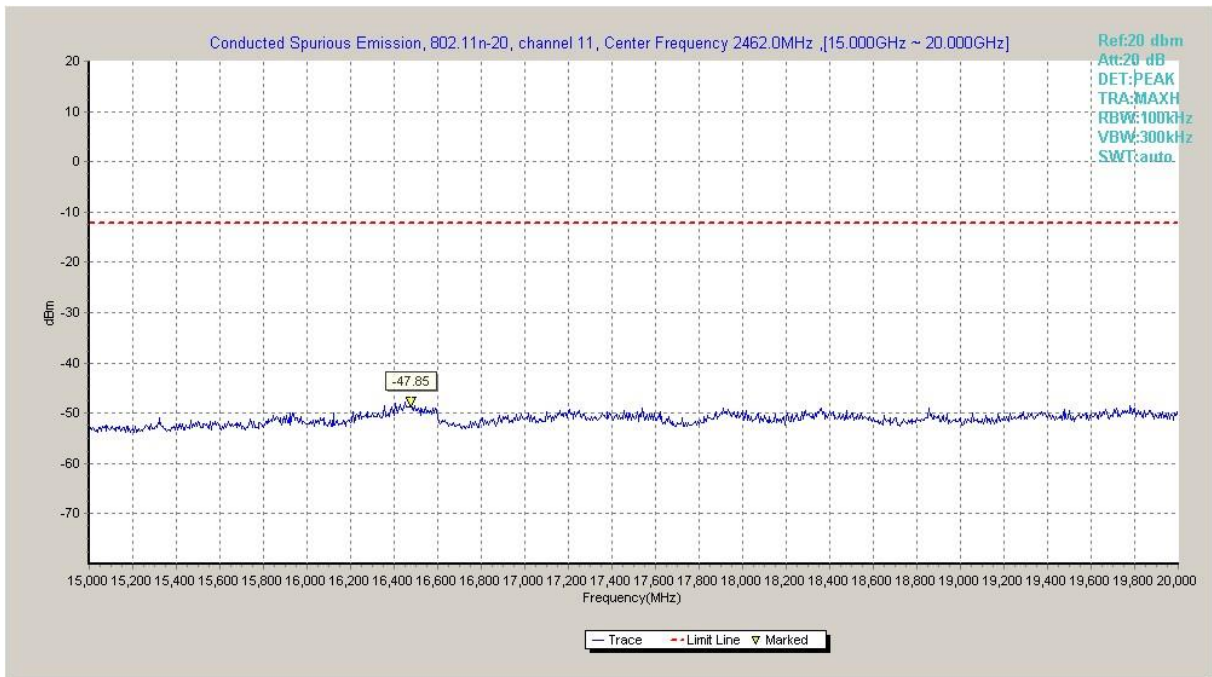

Fig.A.6.1.71 Transmitter Spurious Emission - Conducted (802.11n-HT20, Ch11, 15 GHz-20 GHz)

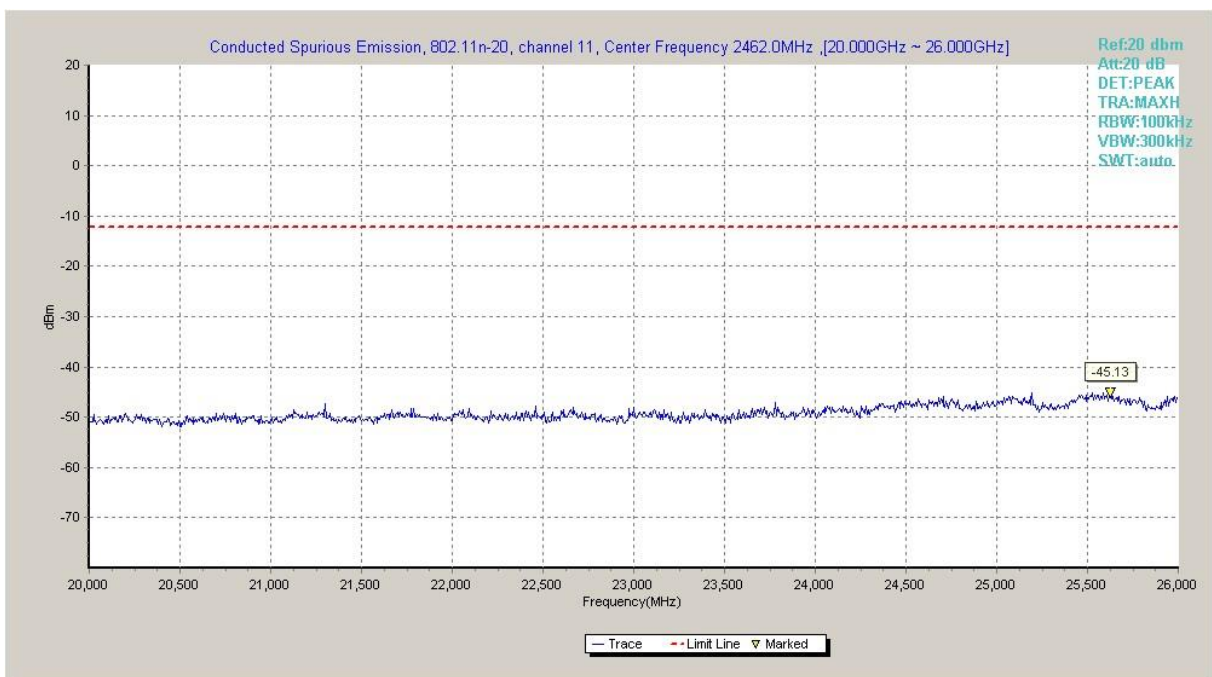

Fig.A.6.1.72 Transmitter Spurious Emission - Conducted (802.11n-HT20, Ch11, 20 GHz-26 GHz)

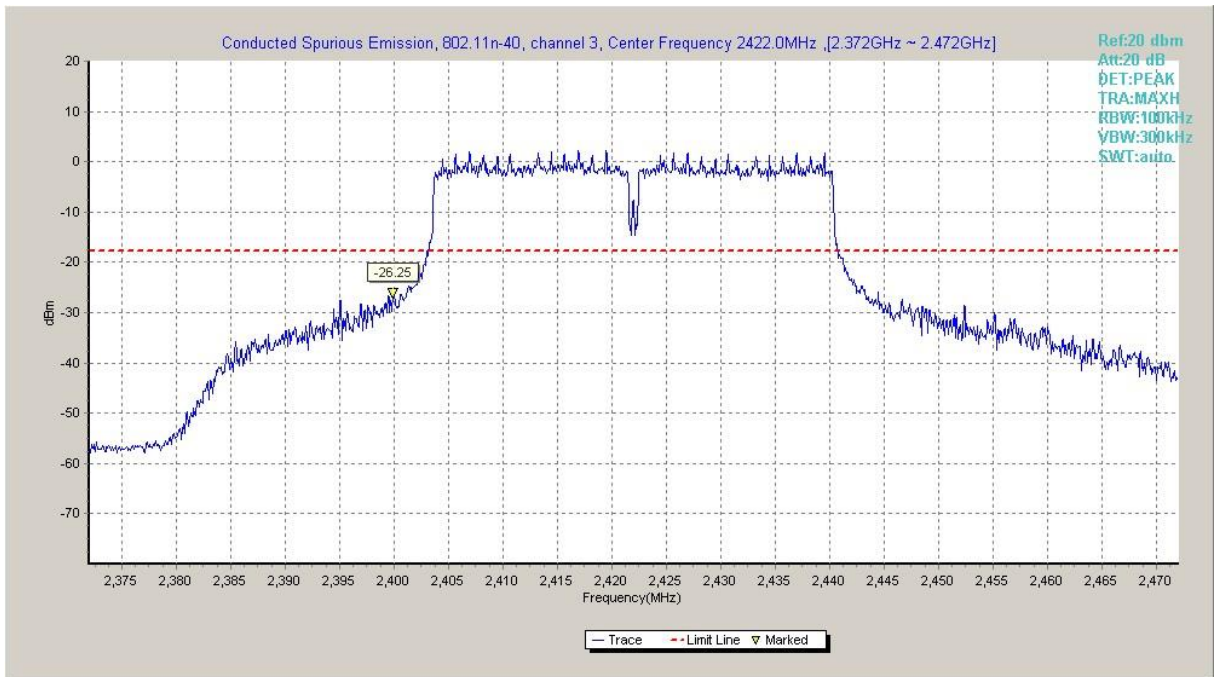

Fig.A.6.1.73 Transmitter Spurious Emission - Conducted (802.11n-HT40, Ch3, Center Frequency)

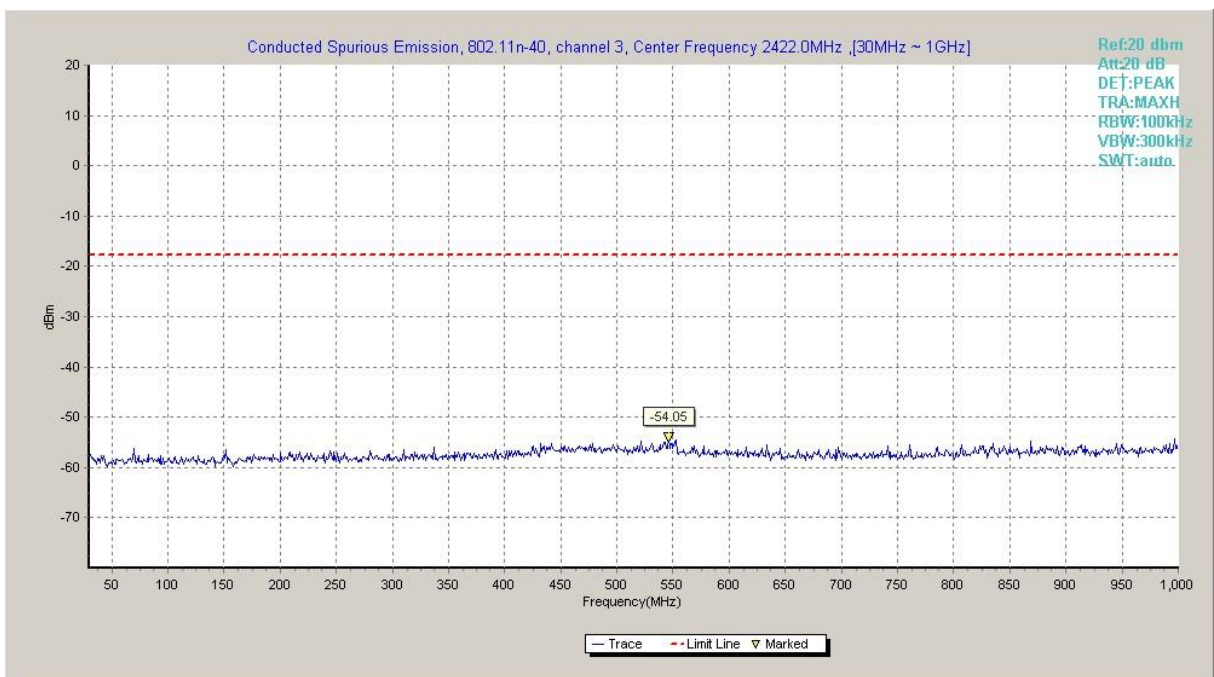

Fig.A.6.1.74 Transmitter Spurious Emission - Conducted (802.11n-HT40, Ch3, 30 MHz-1 GHz)

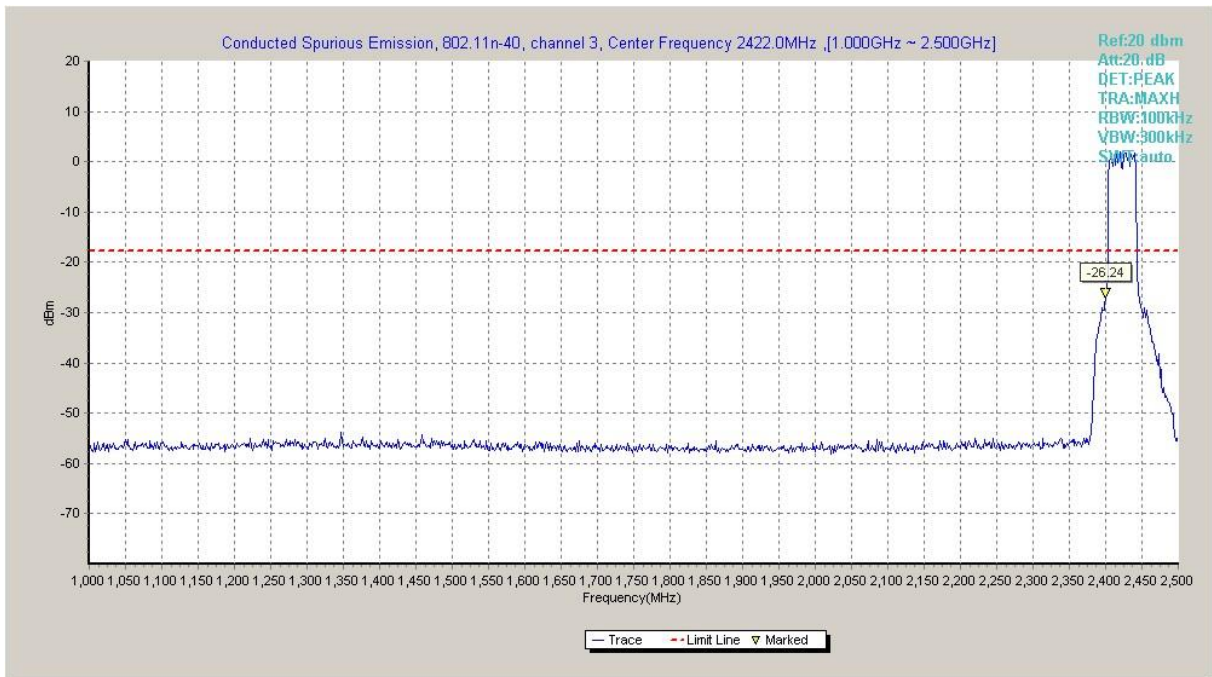

Fig.A.6.1.75 Transmitter Spurious Emission - Conducted (802.11n-HT40, Ch3, 1 GHz-2.5 GHz)

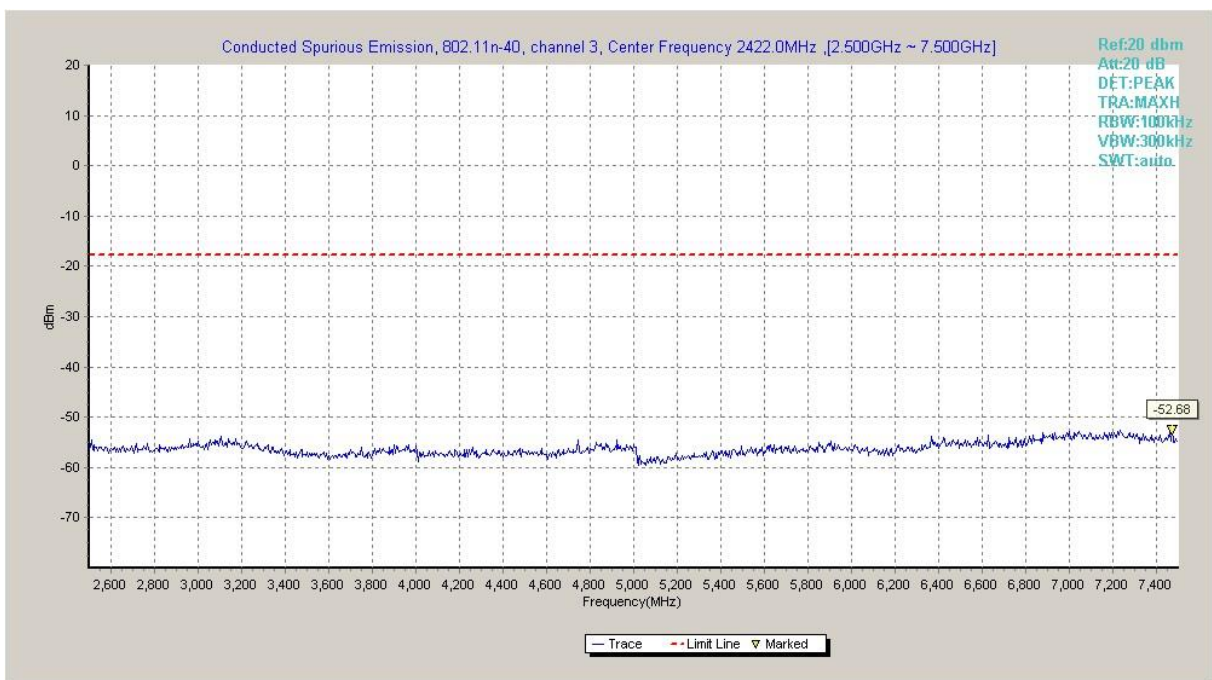

Fig.A.6.1.76 Transmitter Spurious Emission - Conducted (802.11n-HT40, Ch3, 2.5 GHz-7.5 GHz)

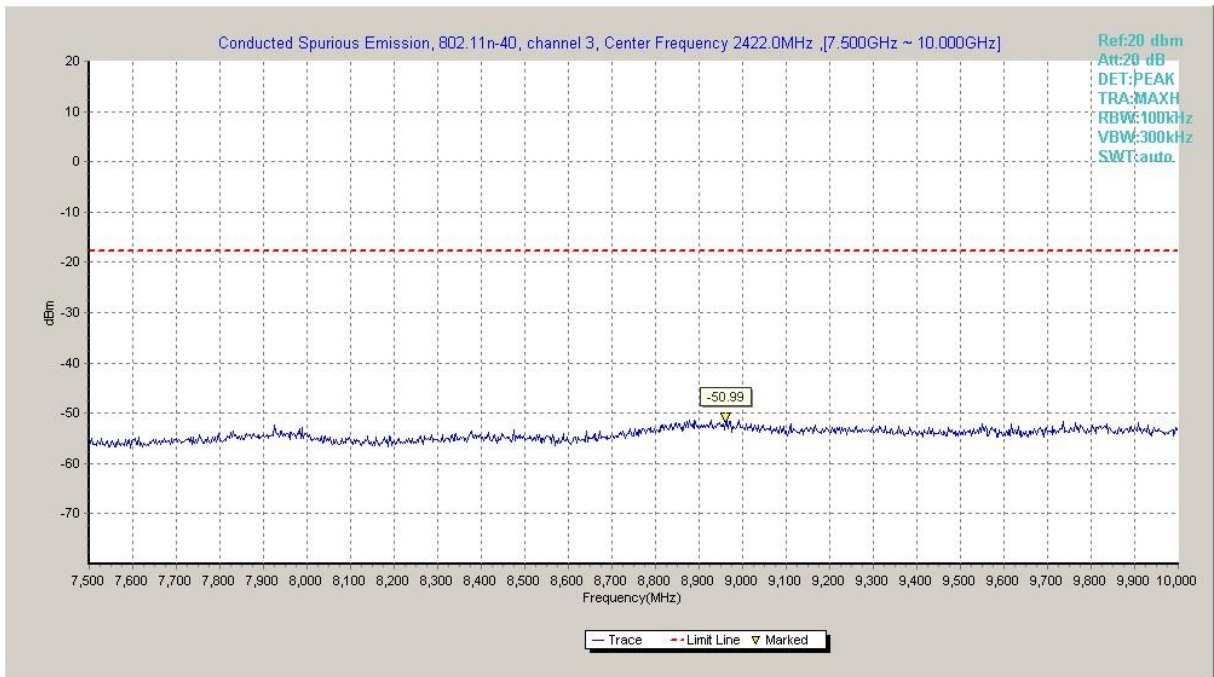

Fig.A.6.1.77 Transmitter Spurious Emission - Conducted (802.11n-HT40, Ch3, 7.5 GHz-10 GHz)

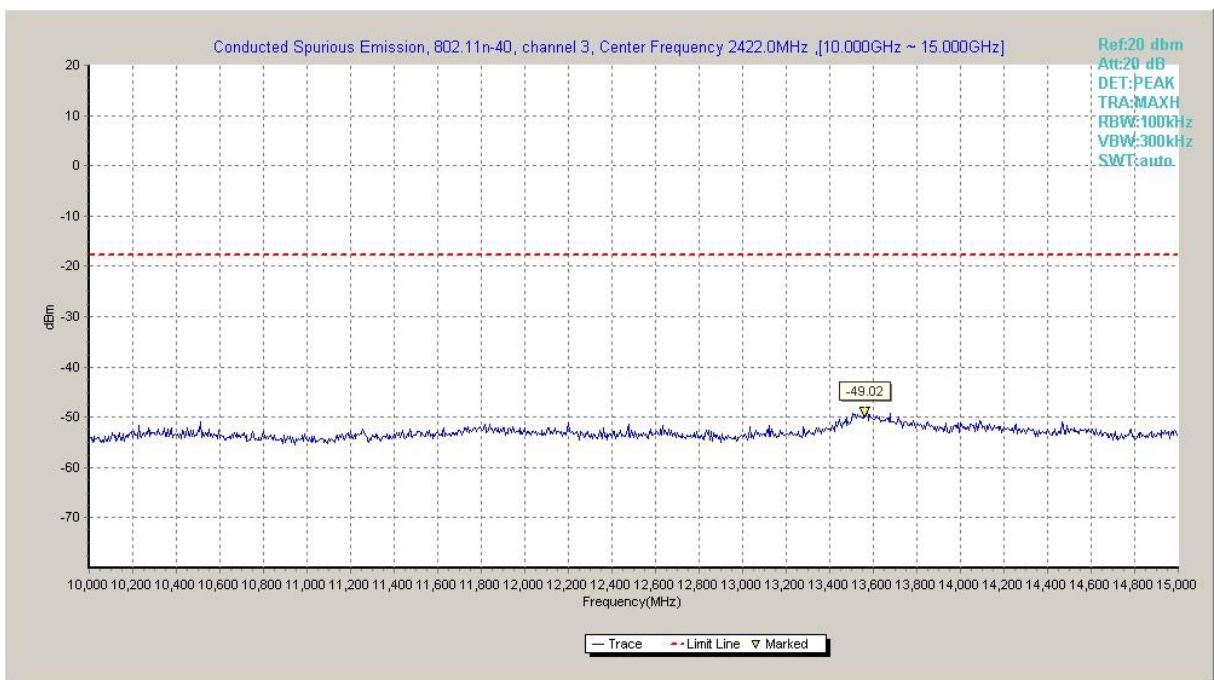

Fig.A.6.1.78 Transmitter Spurious Emission - Conducted (802.11n-HT40, Ch3, 10 GHz-15 GHz)

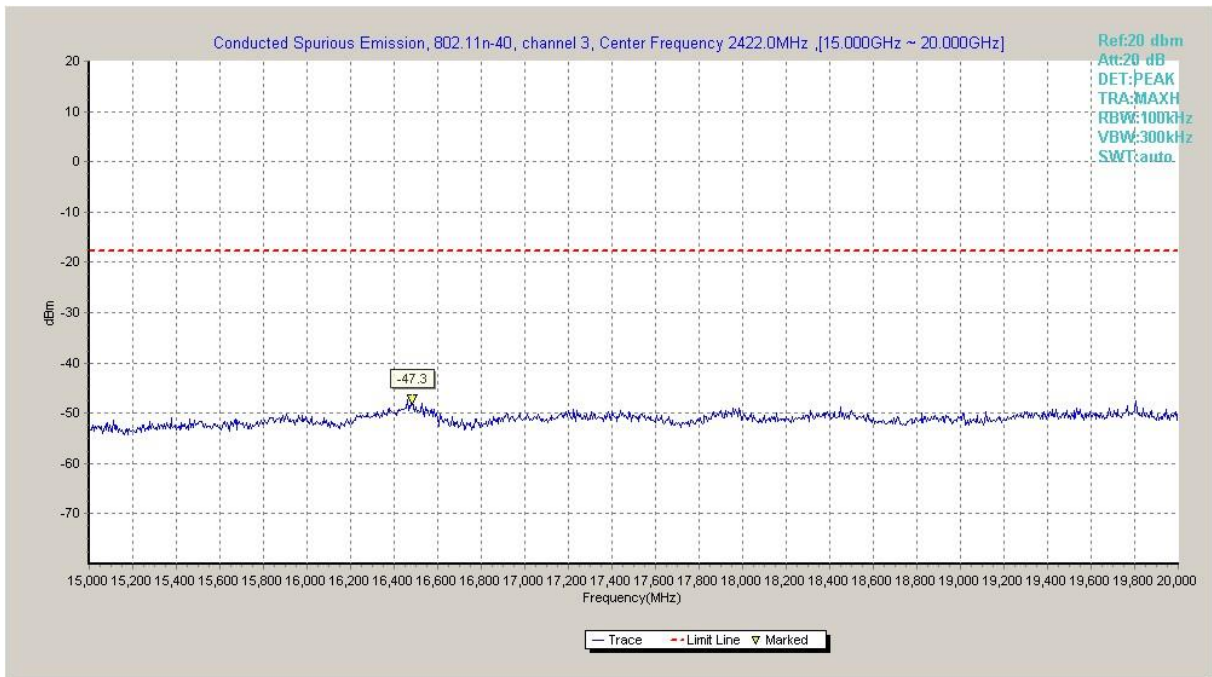

Fig.A.6.1.79 Transmitter Spurious Emission - Conducted (802.11n-HT40, Ch3, 15 GHz-20 GHz)

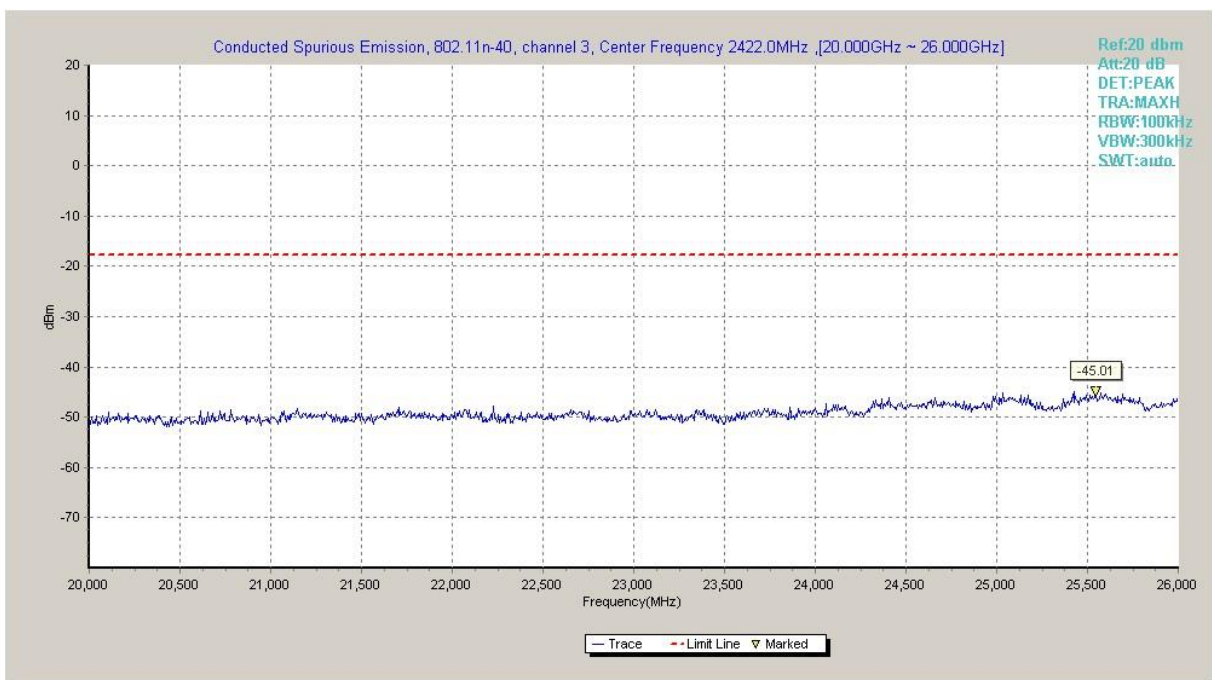

Fig.A.6.1.80 Transmitter Spurious Emission - Conducted (802.11n-HT40, Ch3, 20 GHz-26 GHz)

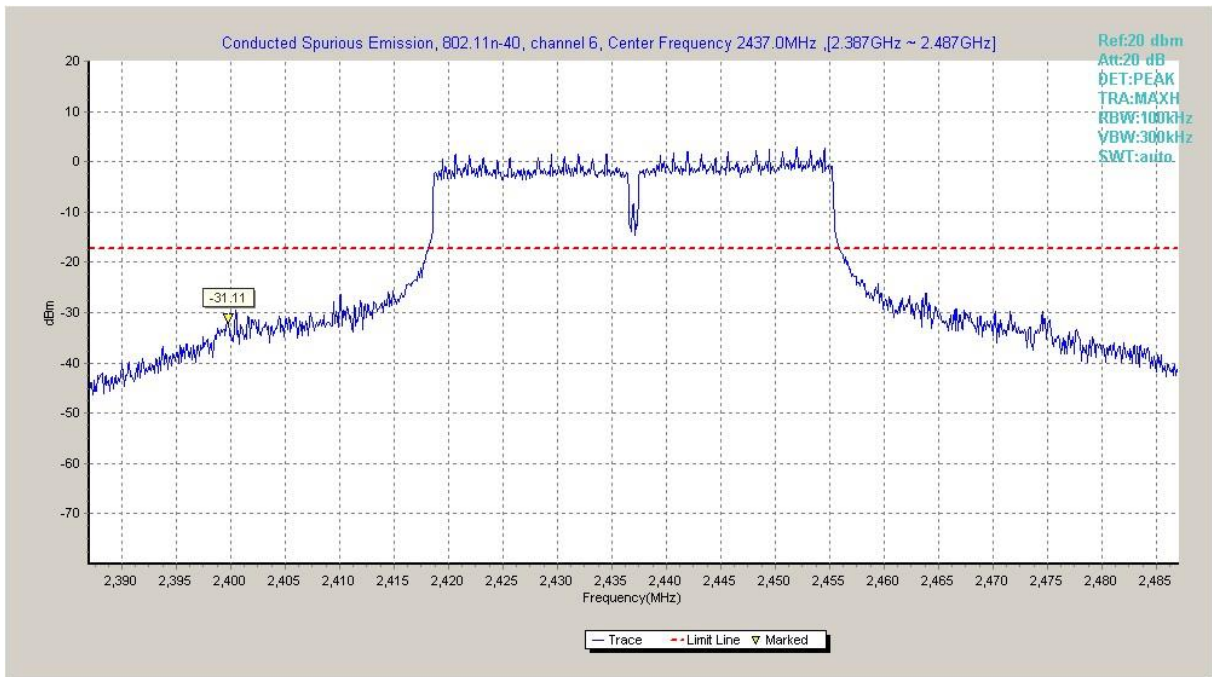

Fig.A.6.1.81 Transmitter Spurious Emission - Conducted (802.11n-HT40, Ch6, Center Frequency)

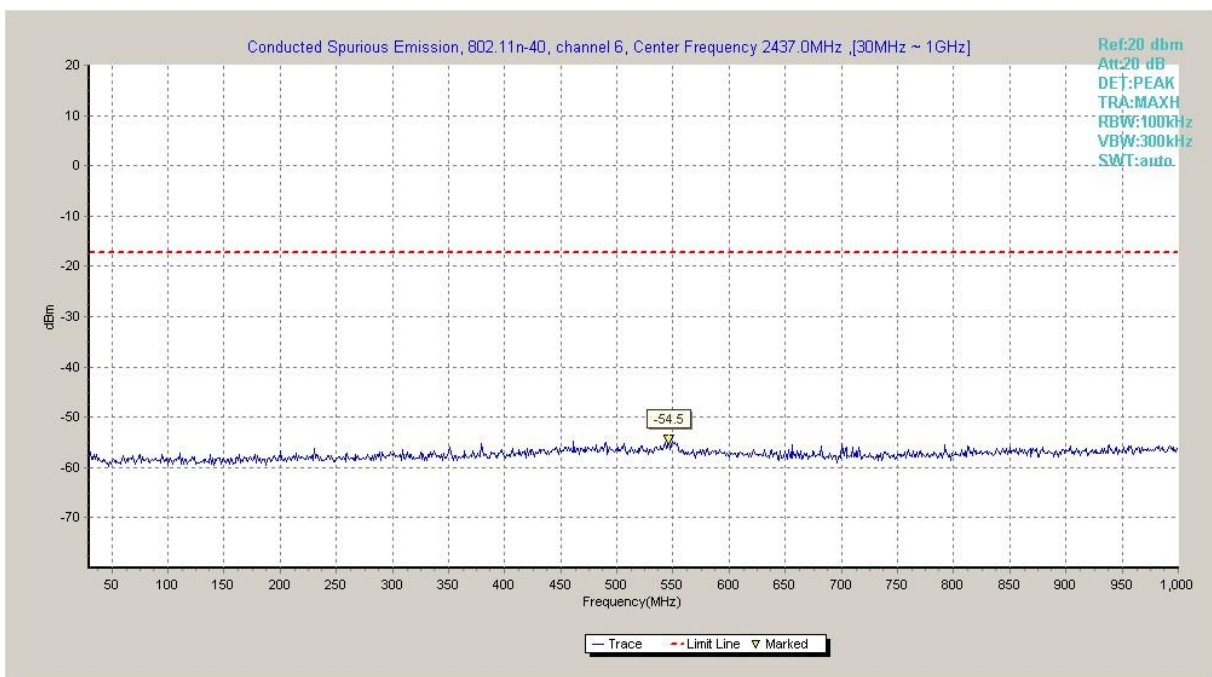

Fig.A.6.1.82 Transmitter Spurious Emission - Conducted (802.11n-HT40, Ch6, 30 MHz-1 GHz)

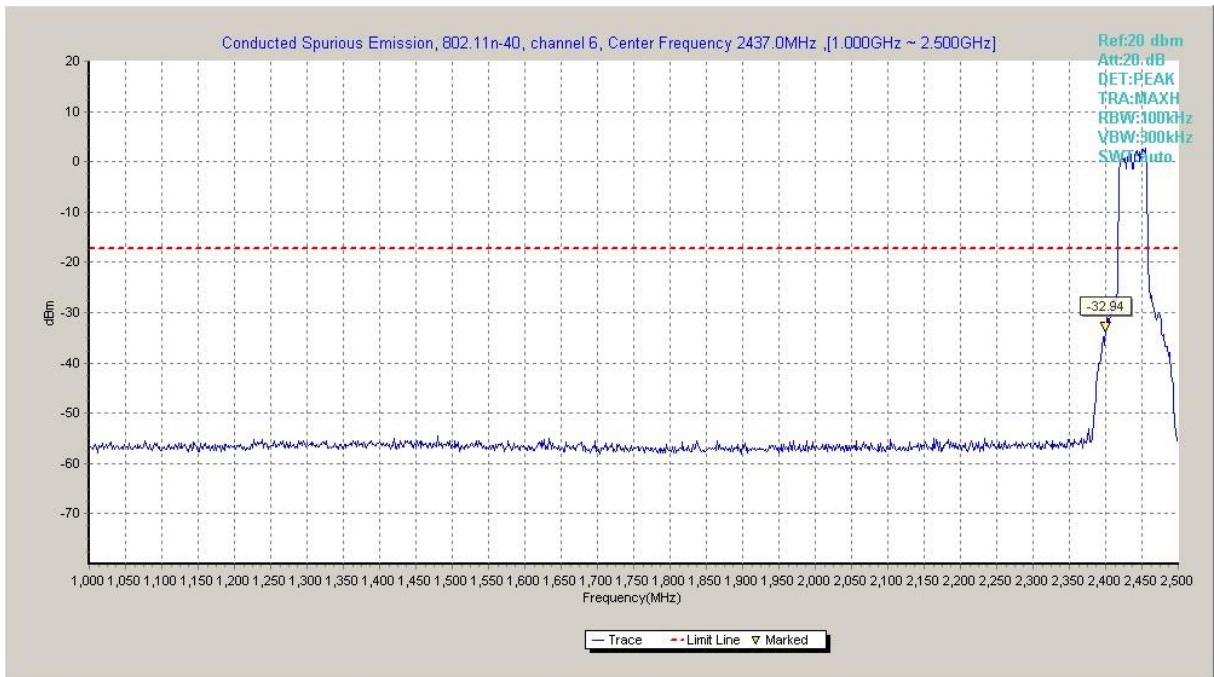

Fig.A.6.1.83 Transmitter Spurious Emission - Conducted (802.11n-HT40, Ch6, 1 GHz-2.5 GHz)

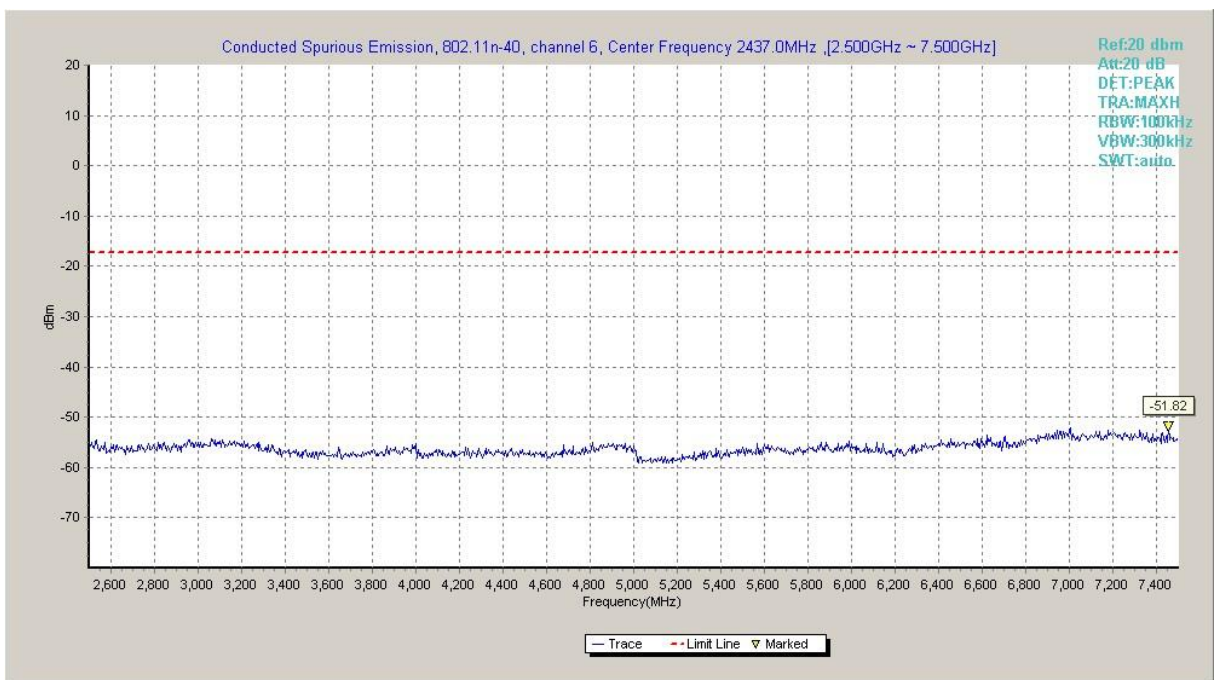

Fig.A.6.1.84 Transmitter Spurious Emission - Conducted (802.11n-HT40, Ch6, 2.5 GHz-7.5 GHz)

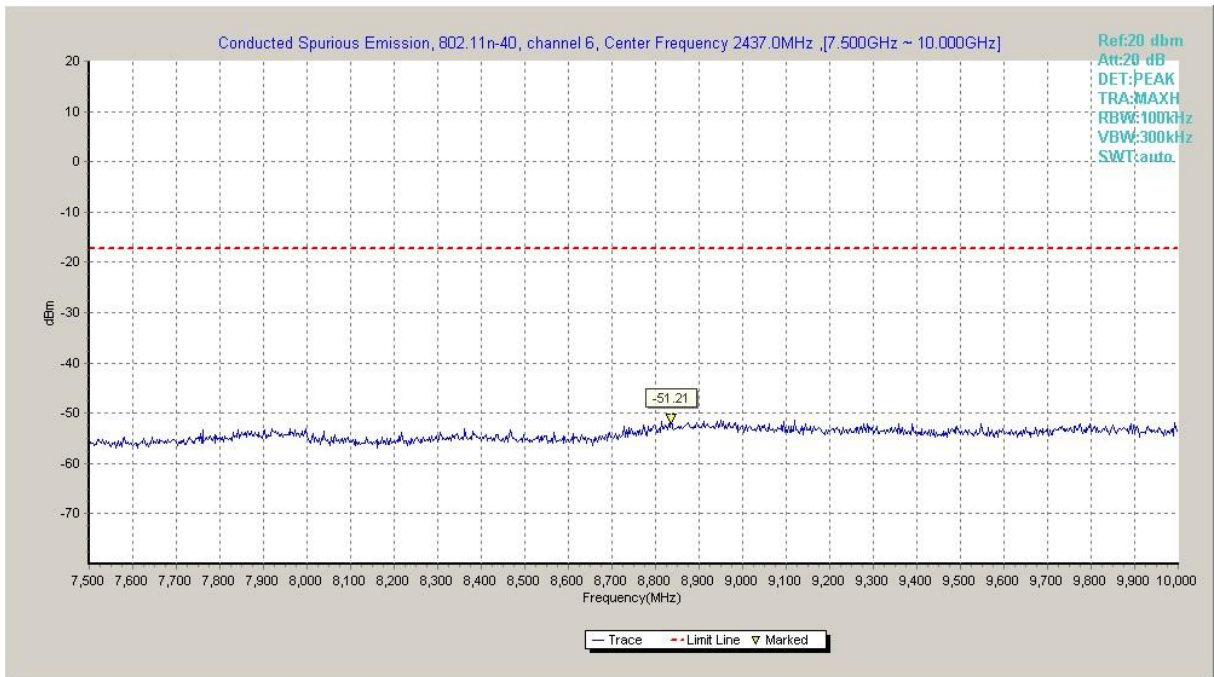

Fig.A.6.1.85 Transmitter Spurious Emission - Conducted (802.11n-HT40, Ch6, 7.5 GHz-10 GHz)

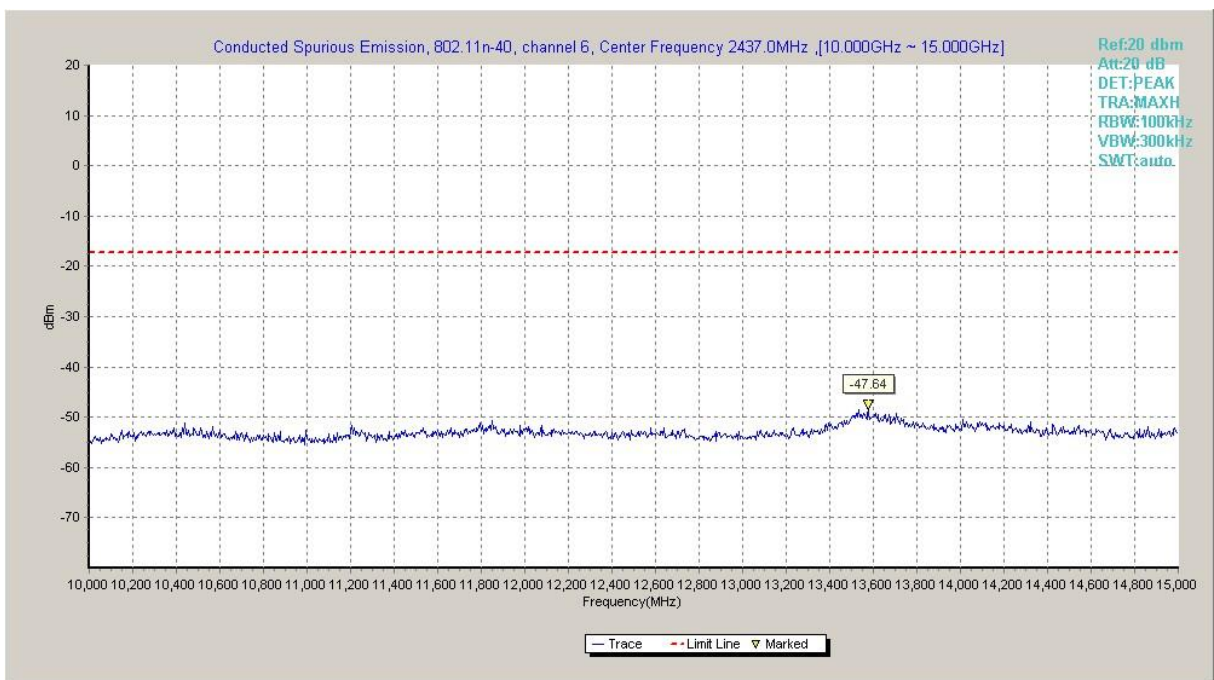

Fig.A.6.1.86 Transmitter Spurious Emission - Conducted (802.11n-HT40, Ch6, 10 GHz-15 GHz)

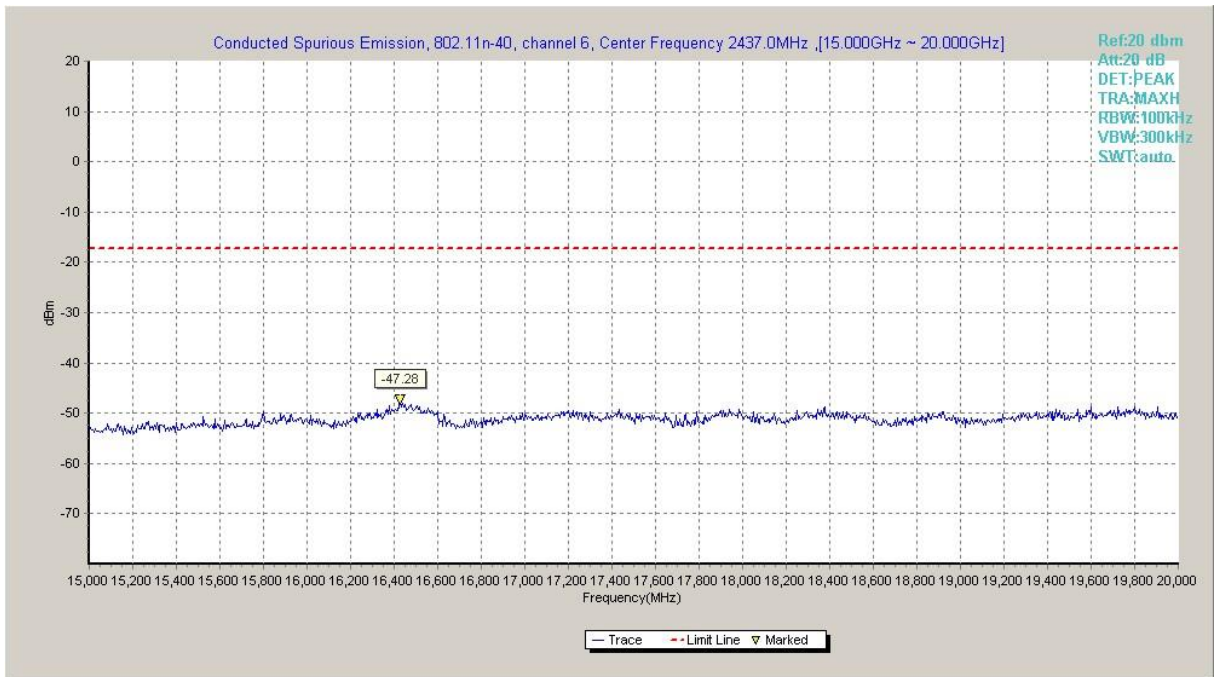

Fig.A.6.1.87 Transmitter Spurious Emission - Conducted (802.11n-HT40, Ch6, 15 GHz-20 GHz)

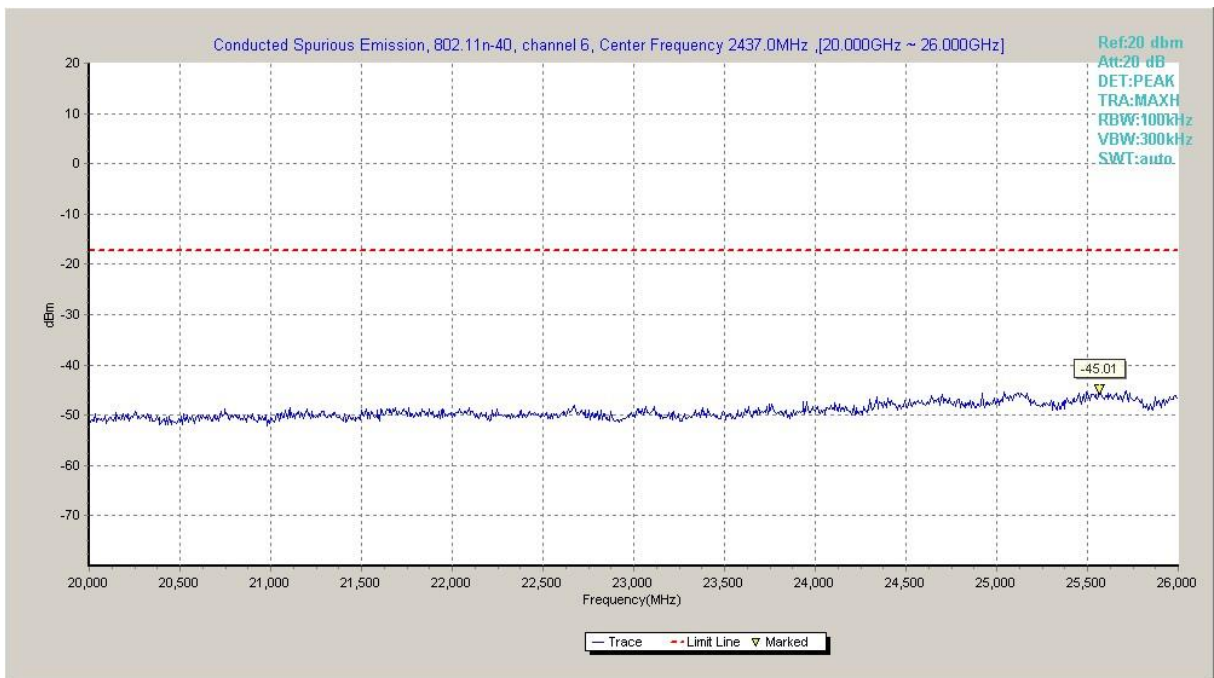

Fig.A.6.1.88 Transmitter Spurious Emission - Conducted (802.11n-HT40, Ch6, 20 GHz-26 GHz)

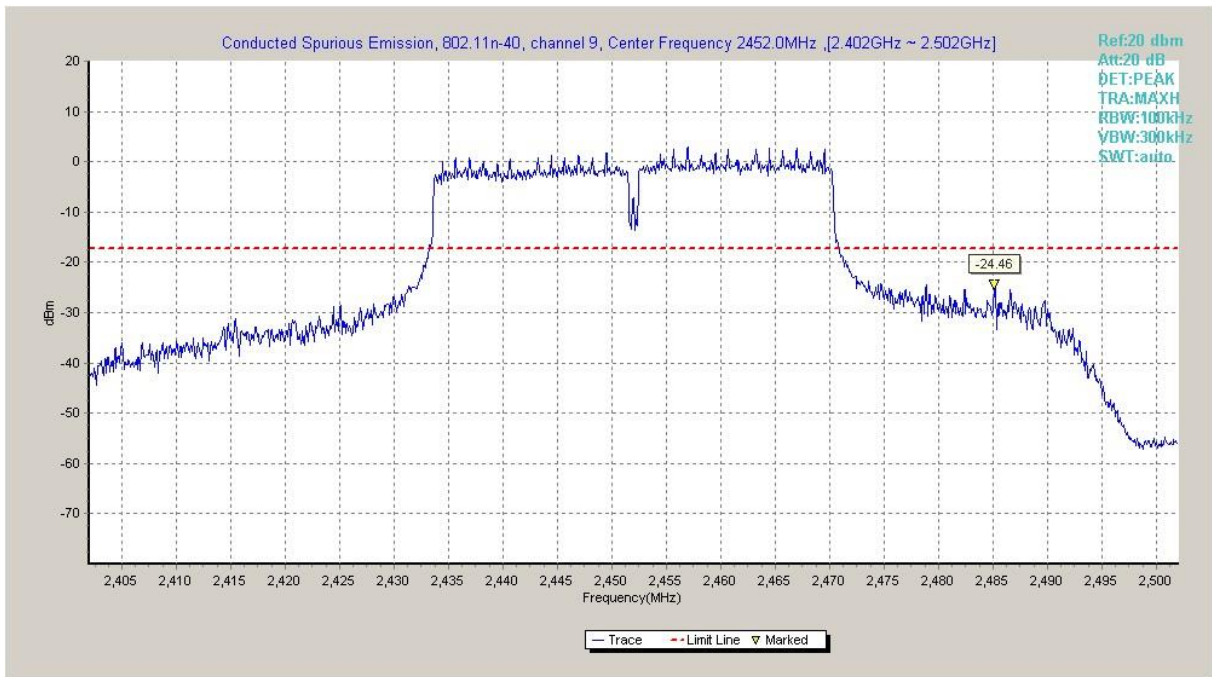

Fig.A.6.1.89 Transmitter Spurious Emission - Conducted (802.11n-HT40, Ch9, Center Frequency)

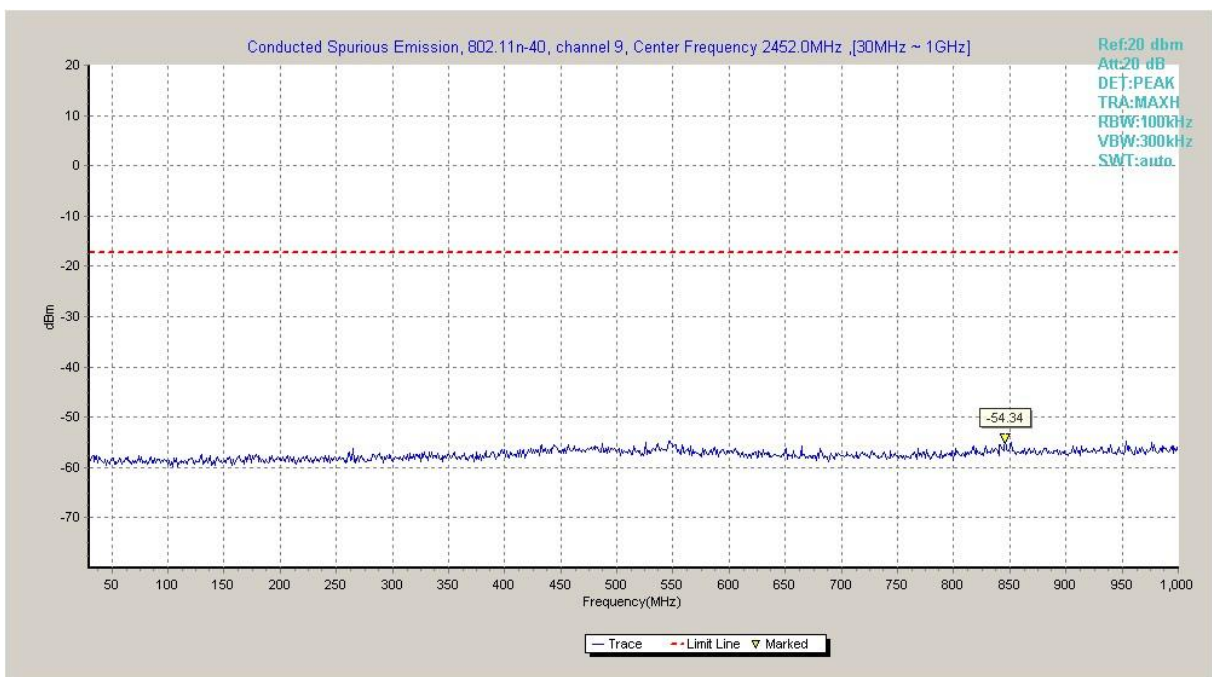

Fig.A.6.1.90 Transmitter Spurious Emission - Conducted (802.11n-HT40, Ch9, 30 MHz-1 GHz)

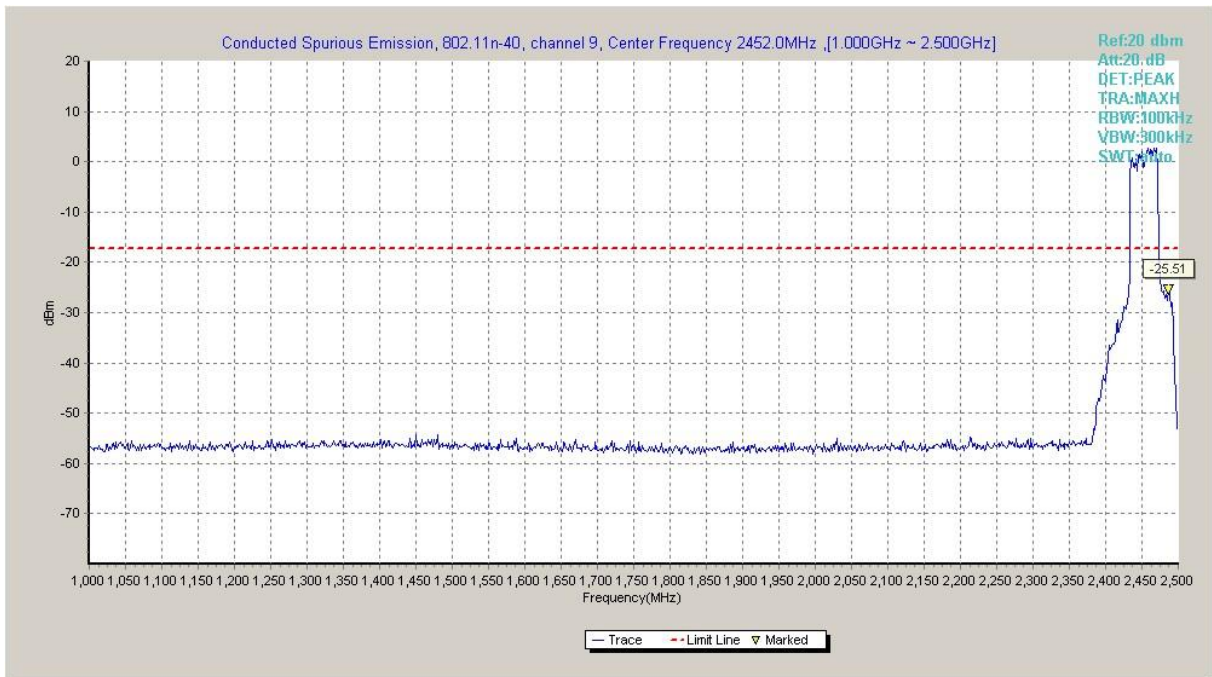

Fig.A.6.1.91 Transmitter Spurious Emission - Conducted (802.11n-HT40, Ch9, 1 GHz-2.5 GHz)

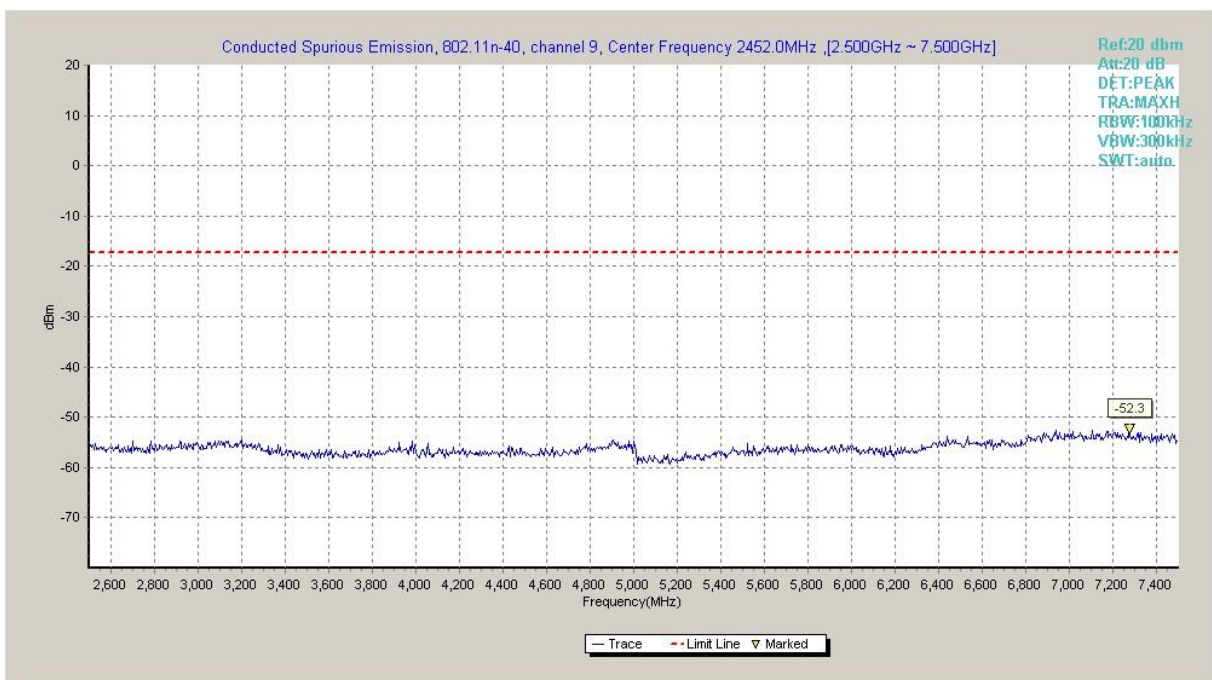

Fig.A.6.1.92 Transmitter Spurious Emission - Conducted (802.11n-HT40, Ch9, 2.5 GHz-7.5 GHz)

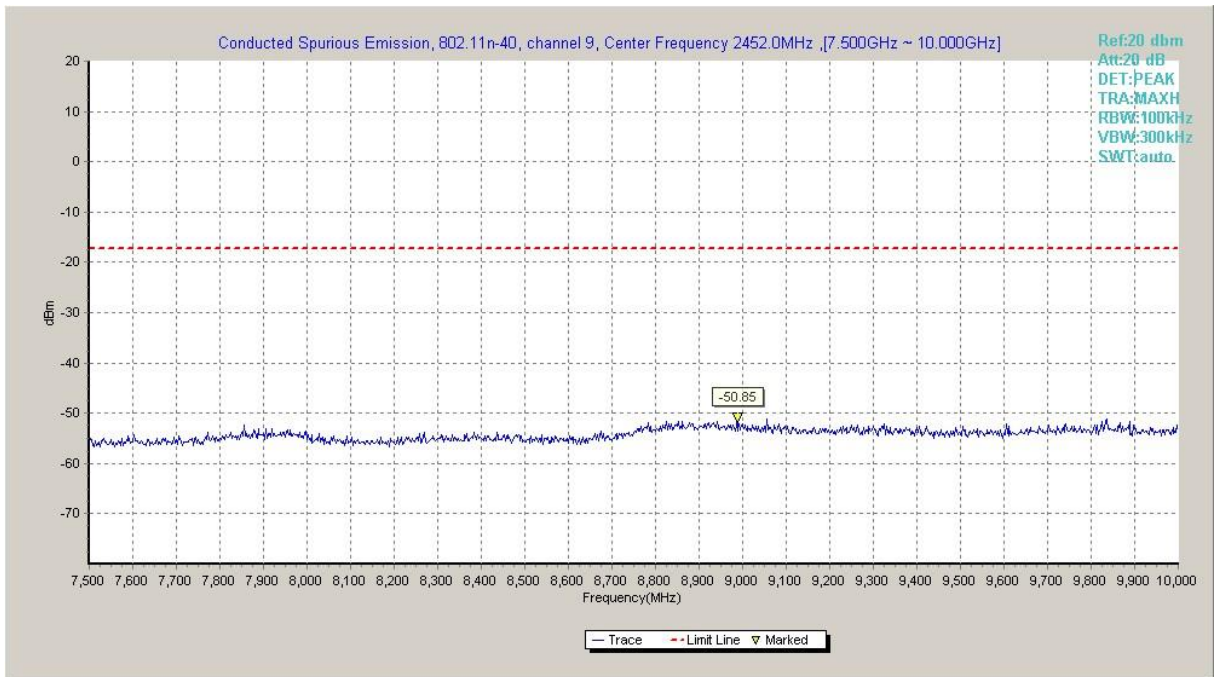

Fig.A.6.1.93 Transmitter Spurious Emission - Conducted (802.11n-HT40, Ch9, 7.5 GHz-10 GHz)

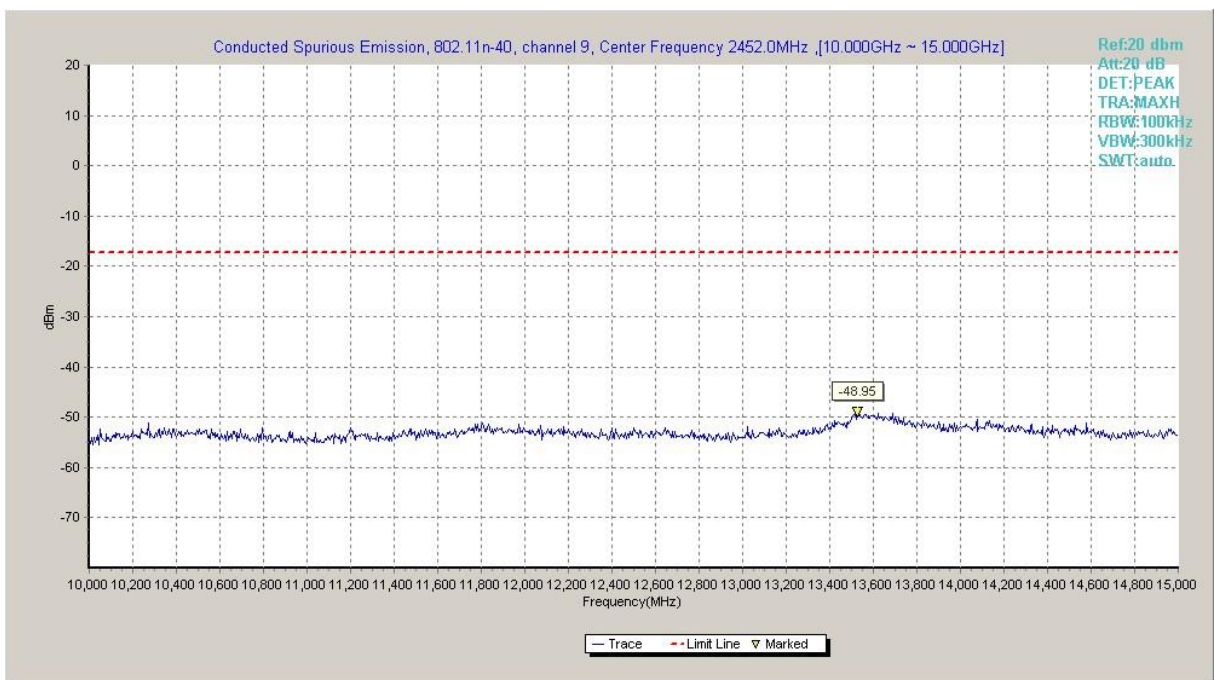

Fig.A.6.1.94 Transmitter Spurious Emission - Conducted (802.11n-HT40, Ch9, 10 GHz-15 GHz)

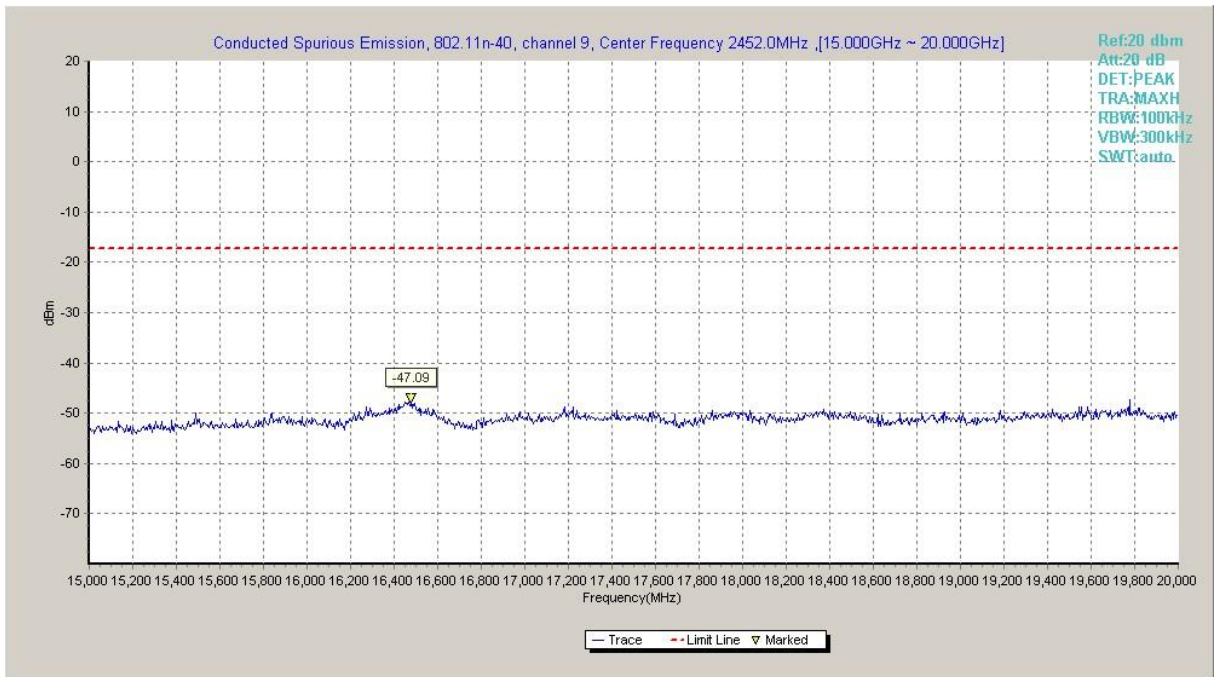

Fig.A.6.1.95 Transmitter Spurious Emission - Conducted (802.11n-HT40, Ch9, 15 GHz-20 GHz)

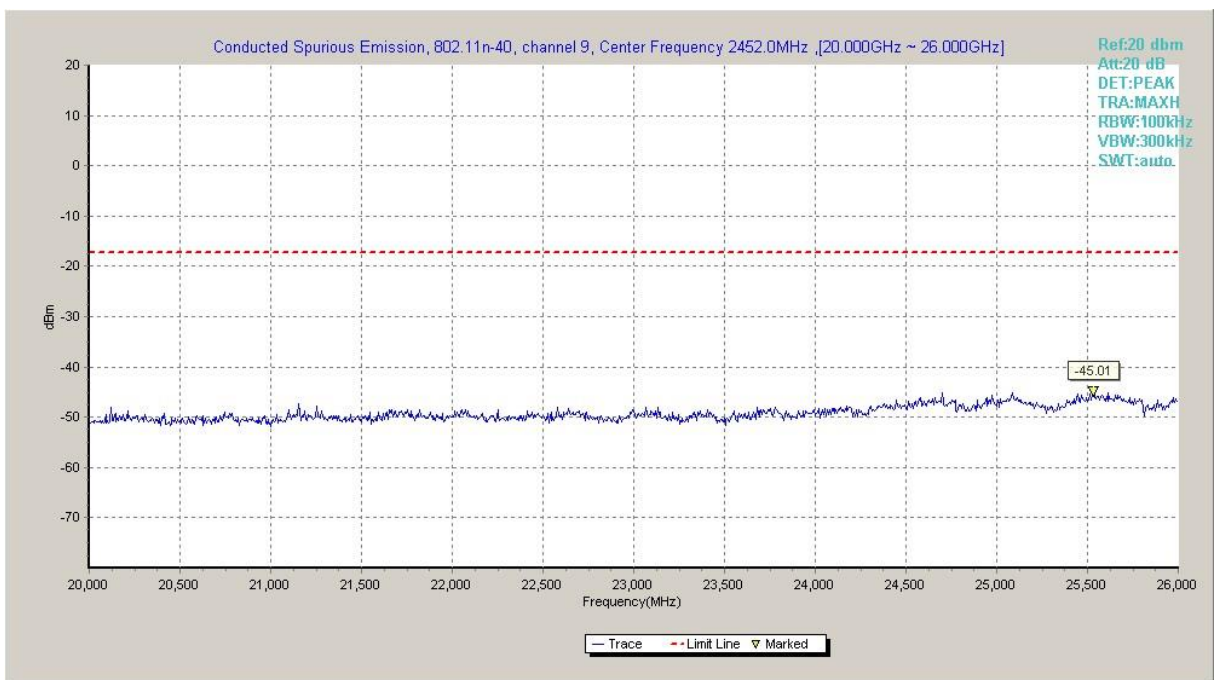

Fig.A.6.1.96 Transmitter Spurious Emission - Conducted (802.11n-HT40, Ch9, 20 GHz-26 GHz)

A.6.2 Transmitter Spurious Emission - Radiated

Method of Measurement: See ANSI C63.10-2013-clause 6.4 & 6.5 & 6.6

Measurement Limit:

Standard	Limit
FCC 47 CFR Part 15.247, 15.205, 15.209	20dB below peak output power

radiated emissions which fall in the restricted bands, as defined in § 15.205(a), must also comply with the radiated emission limits specified in § 15.209(a) (see § 15.205(c)).

Limit in restricted band:

Frequency (MHz)	Field strength(μ V/m)	Measurement distance (m)
0.009 - 0.490	2400/F(kHz)	300
0.490 - 1.705	24000/F(kHz)	30
1.705 – 30.0	30	30

Frequency of emission (MHz)	Field strength(μ V/m)	Field strength(dBuV/m)
30-88	100	40
88-216	150	43.5
216-960	200	46
Above 960	500	54

Set up:

Tabletop devices shall be placed on a nonconducting platform with nominal top surface dimensions 1 m by 1.5 m. For emissions testing at or below 1 GHz, the table height shall be 80 cm above the reference ground plane. For emission measurements above 1 GHz, the table height shall be 1.5 m

The EUT and transmitting antenna shall be centered on the turntable.

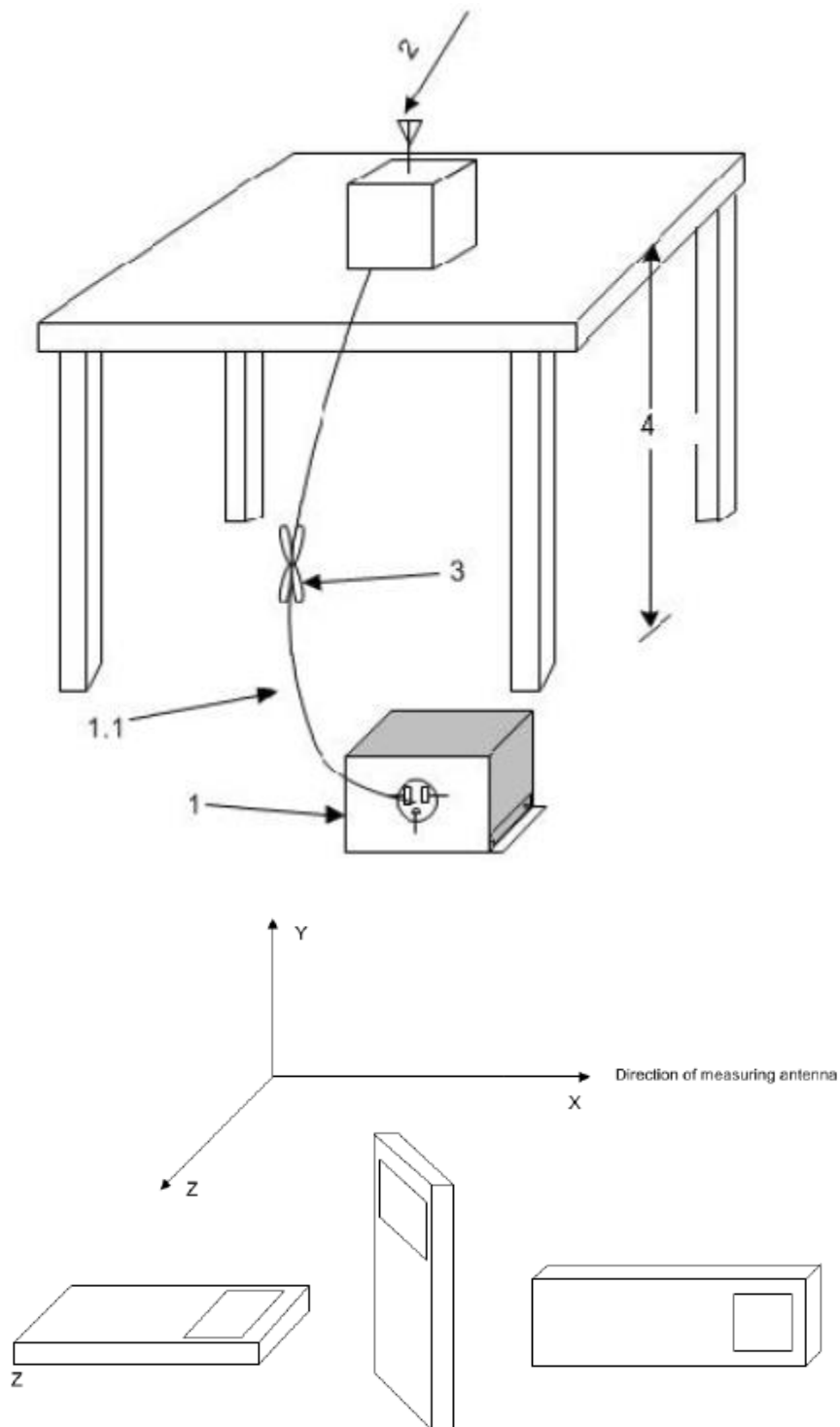

Test Condition

The EUT shall be tested 1 near top, 1 near middle, and 1 near bottom. Set the unlicensed wireless device to operate in continuous transmit mode. For unlicensed wireless devices unable to be configured for 100% duty cycle even in test mode, configure the system for the maximum duty cycle supported.

When required for unlicensed wireless devices, measurements of the variation of the input power or the radiated signal level of the fundamental frequency component of the emission, as

appropriate, shall be performed with the supply voltage varied between 85% and 115% of the nominal rated supply voltage.

Exploratory radiated emissions measurements

Exploratory radiated measurements shall be performed at the measurement distance or at a closer distance than that specified for compliance to determine the emission characteristics of the EUT and, if applicable, the EUT configuration that produces the maximum level of emissions. The frequencies of maximum emission may be determined by manually positioning the antenna close to the EUT, and then moving the antenna over all sides of the EUT while observing a spectral display. It is advantageous to have prior knowledge of the frequencies of emissions, although this may be determined from such a near-field scan. The near-field scan shall only be used to determine the frequency but not the amplitude of the emissions. Where exploratory measurements are not adequate to determine the worst-case operating modes and are used only to identify the frequencies of the highest emissions, additional preliminary tests can be required.

For emissions from the EUT, the maximum level shall be determined by rotating the EUT and its antenna through 0° to 360°. For each mode of operation required to be tested, the frequency spectrum (based on findings from exploratory measurements) shall be monitored.

Broadband antennas and a spectrum analyzer or a radio-noise meter with a panoramic display are often useful in this type of test. If either antenna height or EUT azimuth are not fully measured during exploratory testing, then complete testing can be required at the OATS or semi-anechoic chamber when the final full spectrum testing is performed.

Final radiated emissions measurements

The final measurements are using the orientation and equipment arrangement of the EUT based on the measurement results found during the preliminary (exploratory) measurements, the EUT arrangement, appropriate modulation, and modes of operation that produce the emissions that have the highest amplitude relative to the limit shall be selected for the final measurement.

For each mode of operation required to be tested, the frequency spectrum (based on findings from exploratory measurements) shall be monitored. The highest signal levels relative to the limit shall be determined by rotating the EUT from 0° to 360° and with varying the measurement antenna height between 1 m and 4 m in vertical and horizontal polarizations.

For each mode selected, record the frequency and amplitude of the highest fundamental emission (if applicable), as well as the frequency and amplitude of the six highest spurious emissions relative to the limit. Emissions more than 20 dB below the limit do not need to be reported.

This maximization process was repeated with the EUT positioned in each of its three orthogonal orientations.

The receiver references:

Frequency of emission (MHz)	RBW/VBW	Sweep Time(s)
30-1000	100KHz/300KHz	5
1000-4000	1MHz/3MHz	15
4000-18000	1MHz/3MHz	40
18000-26500	1MHz/3MHz	20

Measurement Results:
EUT ID: EUT1
Conclusion: Pass
 P_{Mea} is the field strength recorded from the instrument.

The measurement results are obtained as described below:

 Result= P_{Mea} + Cable Loss + Antenna Factor

Where:

 P_{Mea} field strength recorded from the instrument

Peak Measurement results
802.11b

Ch1

Frequency (MHz)	Measurement Result (dB μ V/m)	Cable loss (dB)	Antenna Factor (dB/m)	Receiver Reading (dB μ V)	Limit (dB μ V/m)	Margin (dB)	Antenna Pol. (H/V)	Antenna Height (cm)	Turntable angle (deg)
2374.960	60.92	2.9	32.0	26.11	74.0	13.1	H	155	176
2384.746	60.40	2.9	32.0	25.58	74.0	13.6	V	155	154
4823.500	47.05	-35.2	34.1	48.19	74.0	27.0	H	155	22
7236.000	45.88	-32.4	35.8	42.53	74.0	28.1	H	155	176
9648.000	50.76	-30.1	36.8	44.12	74.0	23.2	V	155	198
12060.000	47.57	-31.0	38.9	39.68	74.0	26.4	V	155	0

Ch6

Frequency (MHz)	Measurement Result (dB μ V/m)	Cable loss (dB)	Antenna Factor (dB/m)	Receiver Reading (dB μ V)	Limit (dB μ V/m)	Margin (dB)	Antenna Pol. (H/V)	Antenna Height (cm)	Turntable angle (deg)
2326.600	47.89	-27.7	31.9	43.69	74.0	26.1	H	155	22
2555.200	47.34	-26.8	32.1	42.07	74.0	26.7	H	155	44
4873.500	47.65	-35.5	34.1	49.06	74.0	26.4	V	155	0
7312.000	50.77	-31.6	35.8	46.54	74.0	23.2	V	155	0
9748.000	50.97	-31.3	36.9	45.35	74.0	23.0	V	155	22
12185.000	47.21	-29.1	39.0	37.36	74.0	26.8	H	155	176

Ch11

Frequency (MHz)	Measurement Result (dBμV/m)	Cable loss (dB)	Antenna Factor (dB/m)	Receiver Reading (dBμV)	Limit (dBμV/m)	Margin (dB)	Antenna Pol. (H/V)	Antenna Height (cm)	Turntable angle (deg)
2487.685	60.84	2.9	32.0	25.91	74.0	13.2	H	155	22
2488.865	61.02	2.9	32.0	26.09	74.0	13.0	H	155	44
4924.000	44.52	-35.2	34.1	45.59	74.0	29.5	H	155	0
7383.500	51.85	-31.2	35.8	47.25	74.0	22.1	V	155	0
9848.000	50.40	-30.5	37.0	43.93	74.0	23.6	H	155	22
12310.000	47.74	-31.6	39.0	40.31	74.0	26.3	V	155	176

802.11g

Ch1

Frequency (MHz)	Measurement Result (dBμV/m)	Cable loss (dB)	Antenna Factor (dB/m)	Receiver Reading (dBμV)	Limit (dBμV/m)	Margin (dB)	Antenna Pol. (H/V)	Antenna Height (cm)	Turntable angle (deg)
2389.534	62.80	2.9	32.0	27.97	74.0	11.2	H	155	22
2389.688	62.65	2.9	32.0	27.83	74.0	11.3	H	155	44
4823.500	44.08	-35.2	34.1	45.22	74.0	29.9	H	155	242
7236.000	47.80	-32.4	35.8	44.45	74.0	26.2	V	155	176
9647.500	52.06	-30.1	36.8	45.41	74.0	21.9	V	155	88
12060.000	47.89	-31.0	38.9	40.00	74.0	26.1	H	155	22

Ch6

Frequency (MHz)	Measurement Result (dBμV/m)	Cable loss (dB)	Antenna Factor (dB/m)	Receiver Reading (dBμV)	Limit (dBμV/m)	Margin (dB)	Antenna Pol. (H/V)	Antenna Height (cm)	Turntable angle (deg)
2309.200	47.53	-27.8	31.9	43.40	74.0	26.5	V	155	88
2571.600	47.64	-26.8	32.1	42.38	74.0	26.4	V	155	110
4874.000	42.98	-35.5	34.1	44.40	74.0	31.0	H	155	132
7317.000	50.70	-31.5	35.8	46.36	74.0	23.3	H	155	154
9748.000	50.61	-31.3	36.9	44.98	74.0	23.4	H	155	176
12185.000	47.29	-29.1	39.0	37.43	74.0	26.7	H	155	198

Ch11

Frequency (MHz)	Measurement Result (dBμV/m)	Cable loss (dB)	Antenna Factor (dB/m)	Receiver Reading (dBμV)	Limit (dBμV/m)	Margin (dB)	Antenna Pol. (H/V)	Antenna Height (cm)	Turntable angle (deg)
2483.715	64.24	2.9	32.0	29.32	74.0	9.8	V	155	176
2483.915	64.21	2.9	32.0	29.29	74.0	9.8	V	155	198
4924.000	41.95	-35.2	34.1	43.02	74.0	32.1	H	155	220
7380.500	53.17	-31.2	35.8	48.53	74.0	20.8	V	155	242
9848.000	49.88	-30.5	37.0	43.41	74.0	24.1	H	155	66
12310.000	47.07	-31.6	39.0	39.64	74.0	26.9	V	155	88

802.11n-HT20

Ch1

Frequency (MHz)	Measurement Result (dBμV/m)	Cable loss (dB)	Antenna Factor (dB/m)	Receiver Reading (dBμV)	Limit (dBμV/m)	Margin (dB)	Antenna Pol. (H/V)	Antenna Height (cm)	Turntable angle (deg)
2389.548	61.08	2.9	32.0	26.26	74.0	12.9	H	155	44
2389.702	61.30	2.9	32.0	26.47	74.0	12.7	V	155	66
4824.000	42.25	-35.2	34.1	43.39	74.0	31.8	H	155	88
7237.000	48.80	-32.4	35.8	45.45	74.0	25.2	V	155	110
9648.000	51.92	-30.1	36.8	45.27	74.0	22.1	V	155	132
12060.000	47.88	-31.0	38.9	39.99	74.0	26.1	V	155	154

Ch6

Frequency (MHz)	Measurement Result (dBμV/m)	Cable loss (dB)	Antenna Factor (dB/m)	Receiver Reading (dBμV)	Limit (dBμV/m)	Margin (dB)	Antenna Pol. (H/V)	Antenna Height (cm)	Turntable angle (deg)
2313.800	47.77	-27.8	31.9	43.62	74.0	26.2	V	155	0
2523.200	48.87	-26.8	32.0	43.63	74.0	25.1	H	155	22
4874.000	42.74	-35.5	34.1	44.15	74.0	31.3	V	155	66
7306.000	51.06	-31.7	35.8	46.98	74.0	22.9	H	155	132
9748.000	52.96	-31.3	36.9	47.34	74.0	21.0	H	155	88
12185.000	47.19	-29.1	39.0	37.34	74.0	26.8	V	155	44

Ch11

Frequency (MHz)	Measurement Result (dBμV/m)	Cable loss (dB)	Antenna Factor (dB/m)	Receiver Reading (dBμV)	Limit (dBμV/m)	Margin (dB)	Antenna Pol. (H/V)	Antenna Height (cm)	Turntable angle (deg)
2483.560	63.70	2.9	32.0	28.77	74.0	10.3	H	155	44
2483.775	63.55	2.9	32.0	28.63	74.0	10.4	V	155	66
4924.000	41.95	-35.2	34.1	43.03	74.0	32.0	V	155	88
7375.000	52.12	-31.1	35.8	47.42	74.0	21.9	V	155	264
9848.000	50.09	-30.5	37.0	43.62	74.0	23.9	V	155	286
12310.500	48.12	-31.6	39.0	40.71	74.0	25.9	H	155	308

802.11n-HT40

Ch3

Frequency (MHz)	Measurement Result (dBμV/m)	Cable loss (dB)	Antenna Factor (dB/m)	Receiver Reading (dBμV)	Limit (dBμV/m)	Margin (dB)	Antenna Pol. (H/V)	Antenna Height (cm)	Turntable angle (deg)
2388.036	64.54	2.9	32.0	29.72	74.0	9.5	V	155	0
2389.800	64.85	2.9	32.0	30.02	74.0	9.2	V	155	22
4844.000	40.77	-35.4	34.1	42.08	74.0	33.2	H	155	22
7266.000	46.55	-32.5	35.8	43.24	74.0	27.5	V	155	0
9688.000	51.79	-30.7	36.8	45.66	74.0	22.2	V	155	44
12110.000	49.19	-30.7	38.9	40.91	74.0	24.8	H	155	132

Ch6

Frequency (MHz)	Measurement Result (dBμV/m)	Cable loss (dB)	Antenna Factor (dB/m)	Receiver Reading (dBμV)	Limit (dBμV/m)	Margin (dB)	Antenna Pol. (H/V)	Antenna Height (cm)	Turntable angle (deg)
2333.200	47.30	-27.7	31.9	43.06	74.0	26.7	H	155	132
2566.200	48.34	-26.8	32.1	43.07	74.0	25.7	V	155	154
4874.000	42.20	-35.5	34.1	43.62	74.0	31.8	V	155	88
7311.000	46.94	-31.6	35.8	42.74	74.0	27.1	V	155	110
9748.000	51.01	-31.3	36.9	45.39	74.0	23.0	H	155	110
12185.000	47.85	-29.1	39.0	37.99	74.0	26.2	H	155	88

Ch9

Frequency (MHz)	Measurement Result (dBμV/m)	Cable loss (dB)	Antenna Factor (dB/m)	Receiver Reading (dBμV)	Limit (dBμV/m)	Margin (dB)	Antenna Pol. (H/V)	Antenna Height (cm)	Turntable angle (deg)
2484.285	64.06	2.9	32.0	29.14	74.0	9.9	H	155	22
2484.960	64.23	2.9	32.0	29.30	74.0	9.8	H	155	44
4904.000	41.97	-35.4	34.1	43.24	74.0	32.0	V	155	0
7356.000	48.71	-30.9	35.8	43.79	74.0	25.3	H	155	0
9808.000	50.52	-31.6	37.0	45.14	74.0	23.5	V	155	22
12260.000	48.66	-30.3	39.0	39.94	74.0	25.3	H	155	176

Average Measurement results
802.11b

Ch1

Frequency (MHz)	Measurement Result (dBμV/m)	Cable loss (dB)	Antenna Factor (dB/m)	Receiver Reading (dBμV)	Limit (dBμV/m)	Margin (dB)	Antenna Pol. (H/V)	Antenna Height (cm)	Turntable angle (deg)
2484.285	64.06	2.9	32.0	29.14	74.0	9.9	H	155	22
2484.960	64.23	2.9	32.0	29.30	74.0	9.8	H	155	44
4904.000	41.97	-35.4	34.1	43.24	74.0	32.0	V	155	0
7356.000	48.71	-30.9	35.8	43.79	74.0	25.3	H	155	0
9808.000	50.52	-31.6	37.0	45.14	74.0	23.5	V	155	22
12260.000	48.66	-30.3	39.0	39.94	74.0	25.3	H	155	176

Ch6

Frequency (MHz)	Measurement Result (dBμV/m)	Cable loss (dB)	Antenna Factor (dB/m)	Receiver Reading (dBμV)	Limit (dBμV/m)	Margin (dB)	Antenna Pol. (H/V)	Antenna Height (cm)	Turntable angle (deg)
2484.285	64.06	2.9	32.0	29.14	74.0	9.9	H	155	22
2484.960	64.23	2.9	32.0	29.30	74.0	9.8	H	155	44
4904.000	41.97	-35.4	34.1	43.24	74.0	32.0	V	155	0
7356.000	48.71	-30.9	35.8	43.79	74.0	25.3	H	155	0
9808.000	50.52	-31.6	37.0	45.14	74.0	23.5	V	155	22
12260.000	48.66	-30.3	39.0	39.94	74.0	25.3	H	155	176

Ch11

Frequency (MHz)	Measurement Result (dB μ V/m)	Cable loss (dB)	Antenna Factor (dB/m)	Receiver Reading (dB μ V)	Limit (dB μ V/m)	Margin (dB)	Antenna Pol. (H/V)	Antenna Height (cm)	Turntable angle (deg)
2486.400	46.92	2.9	32.0	11.99	54.0	7.1	H	155	25
2487.700	46.92	2.9	32.0	11.99	54.0	7.1	H	155	49
4924.000	37.07	-35.2	34.1	38.15	54.0	16.9	H	155	4
7385.000	45.23	-31.2	35.8	40.64	54.0	8.8	H	155	6
9848.000	41.14	-30.5	37.0	34.66	54.0	12.9	H	155	25
12310.000	37.53	-31.6	39.0	30.10	54.0	16.5	H	155	186

802.11g

Ch1

Frequency (MHz)	Measurement Result (dB μ V/m)	Cable loss (dB)	Antenna Factor (dB/m)	Receiver Reading (dB μ V)	Limit (dB μ V/m)	Margin (dB)	Antenna Pol. (H/V)	Antenna Height (cm)	Turntable angle (deg)
2389.800	48.00	2.9	32.0	13.18	54.0	6.0	H	155	20
2390.000	48.06	2.9	32.0	13.24	54.0	5.9	H	155	45
4821.000	31.77	-35.2	34.1	32.89	54.0	22.2	H	155	240
7239.000	37.23	-32.4	35.8	33.88	54.0	16.8	H	155	180
9648.000	42.59	-30.1	36.8	35.95	54.0	11.4	H	155	85
12060.000	37.44	-31.0	38.9	29.55	54.0	16.6	H	155	25

Ch6

Frequency (MHz)	Measurement Result (dB μ V/m)	Cable loss (dB)	Antenna Factor (dB/m)	Receiver Reading (dB μ V)	Limit (dB μ V/m)	Margin (dB)	Antenna Pol. (H/V)	Antenna Height (cm)	Turntable angle (deg)
2408.600	47.88	2.9	32.0	13.03	54.0	6.1	H	155	92
2468.400	47.45	2.9	32.0	12.54	54.0	6.6	H	155	115
4875.000	31.19	-35.5	34.1	32.61	54.0	22.8	H	155	135
7313.000	37.94	-31.6	35.8	33.69	54.0	16.1	H	155	168
9748.000	43.47	-31.3	36.9	37.84	54.0	10.5	H	155	184
12185.000	37.43	-29.1	39.0	27.58	54.0	16.6	H	155	202

Ch11

Frequency (MHz)	Measurement Result (dBμV/m)	Cable loss (dB)	Antenna Factor (dB/m)	Receiver Reading (dBμV)	Limit (dBμV/m)	Margin (dB)	Antenna Pol. (H/V)	Antenna Height (cm)	Turntable angle (deg)
2483.500	50.81	2.9	32.0	15.88	54.0	3.2	H	155	180
2484.000	50.50	2.9	32.0	15.58	54.0	3.5	H	155	204
4924.000	31.20	-35.2	34.1	32.28	54.0	22.8	H	155	222
7385.000	40.21	-31.2	35.8	35.62	54.0	13.8	H	155	245
9848.000	41.56	-30.5	37.0	35.09	54.0	12.4	H	155	72
12310.000	37.53	-31.6	39.0	30.10	54.0	16.5	H	155	94

802.11n-HT20

Ch1

Frequency (MHz)	Measurement Result (dBμV/m)	Cable loss (dB)	Antenna Factor (dB/m)	Receiver Reading (dBμV)	Limit (dBμV/m)	Margin (dB)	Antenna Pol. (H/V)	Antenna Height (cm)	Turntable angle (deg)
2389.400	47.45	2.9	32.0	12.63	54.0	6.5	H	155	48
2390.000	47.78	2.9	32.0	12.96	54.0	6.2	H	155	70
4824.000	30.81	-35.2	34.1	31.96	54.0	23.2	H	155	92
7239.000	36.09	-32.4	35.8	32.74	54.0	17.9	H	155	112
9648.000	42.82	-30.1	36.8	36.18	54.0	11.2	H	155	136
12060.000	37.38	-31.0	38.9	29.50	54.0	16.6	H	155	156

Ch6

Frequency (MHz)	Measurement Result (dBμV/m)	Cable loss (dB)	Antenna Factor (dB/m)	Receiver Reading (dBμV)	Limit (dBμV/m)	Margin (dB)	Antenna Pol. (H/V)	Antenna Height (cm)	Turntable angle (deg)
2409.000	47.71	2.9	32.0	12.86	54.0	6.3	H	155	8
2463.800	47.43	2.9	32.0	12.52	54.0	6.6	H	155	26
4874.000	30.87	-35.5	34.1	32.29	54.0	23.1	H	155	72
7314.000	37.44	-31.5	35.8	33.17	54.0	16.6	H	155	136
9748.000	43.19	-31.3	36.9	37.56	54.0	10.8	H	155	94
12185.000	37.41	-29.1	39.0	27.55	54.0	16.6	H	155	48

Ch11

Frequency (MHz)	Measurement Result (dBμV/m)	Cable loss (dB)	Antenna Factor (dB/m)	Receiver Reading (dBμV)	Limit (dBμV/m)	Margin (dB)	Antenna Pol. (H/V)	Antenna Height (cm)	Turntable angle (deg)
2483.500	50.52	2.9	32.0	15.59	54.0	3.5	H	155	46
2483.600	50.27	2.9	32.0	15.34	54.0	3.7	H	155	70
4928.000	31.07	-35.1	34.1	32.11	54.0	22.9	H	155	92
7382.000	38.76	-31.2	35.8	34.14	54.0	15.2	H	155	268
9848.000	41.58	-30.5	37.0	35.11	54.0	12.4	H	155	292
12310.000	37.51	-31.6	39.0	30.08	54.0	16.5	H	155	316

802.11n-HT40

Ch3

Frequency (MHz)	Measurement Result (dBμV/m)	Cable loss (dB)	Antenna Factor (dB/m)	Receiver Reading (dBμV)	Limit (dBμV/m)	Margin (dB)	Antenna Pol. (H/V)	Antenna Height (cm)	Turntable angle (deg)
2389.200	50.97	2.9	32.0	16.15	54.0	3.0	H	155	4
2390.000	51.27	2.9	32.0	16.44	54.0	2.7	H	155	26
4844.000	30.25	-35.4	34.1	31.56	54.0	23.7	H	155	24
7266.000	35.99	-32.5	35.8	32.69	54.0	18.0	H	155	6
9688.000	40.32	-30.7	36.8	34.19	54.0	13.7	H	155	48
12110.000	37.62	-30.7	38.9	29.34	54.0	16.4	H	155	136

Ch6

Frequency (MHz)	Measurement Result (dBμV/m)	Cable loss (dB)	Antenna Factor (dB/m)	Receiver Reading (dBμV)	Limit (dBμV/m)	Margin (dB)	Antenna Pol. (H/V)	Antenna Height (cm)	Turntable angle (deg)
2388.200	47.22	2.9	32.0	12.40	54.0	6.8	H	155	135
2490.000	47.45	2.9	32.0	12.52	54.0	6.6	H	155	164
4874.000	30.29	-35.5	34.1	31.70	54.0	23.7	H	155	102
7311.000	37.29	-31.6	35.8	33.09	54.0	16.7	H	155	112
9748.000	43.19	-31.3	36.9	37.57	54.0	10.8	H	155	115
12185.000	37.34	-29.1	39.0	27.49	54.0	16.7	H	155	92

Ch9

Frequency (MHz)	Measurement Result (dBμV/m)	Cable loss (dB)	Antenna Factor (dB/m)	Receiver Reading (dBμV)	Limit (dBμV/m)	Margin (dB)	Antenna Pol. (H/V)	Antenna Height (cm)	Turntable angle (deg)
2483.700	51.23	2.9	32.0	16.30	54.0	2.8	H	155	24
2484.000	50.89	2.9	32.0	15.96	54.0	3.1	H	155	46
4904.000	30.62	-35.4	34.1	31.89	54.0	23.4	H	155	6
7356.000	36.99	-30.9	35.8	32.07	54.0	17.0	H	155	5
9808.000	42.40	-31.6	37.0	37.02	54.0	11.6	H	155	25
12260.000	37.61	-30.3	39.0	28.90	54.0	16.4	H	155	184

Sample:

2483.700MHz

 Result (51.23 dBμV/m) = P_{Mea} (16.30 dBμV/m) + Cable Loss(2.9 dB) + Antenna Factor(32.0 dB/m)

A.7. AC Power-line Conducted Emission

Method of Measurement: See ANSI C63.10-2013-clause 6.2

Setup:

A stand-alone EUT shall be placed in the center along the back edge of the tabletop. For multiunit tabletop systems, the EUT shall be centered laterally (left to right facing the tabletop) on the tabletop and its rear shall be flush with the rear of the table.

Accessories that are part of an EUT system tested on a tabletop shall be placed in a test arrangement on one or both sides of the host with a 10 cm separation between the nearest points of the cabinets. The rear of the host and accessories shall be flush with the back of the supporting tabletop unless that would not be typical of normal use. If more than two accessories are present, then an equipment test arrangement shall be chosen that maintains 10 cm spacing between cabinets unless the equipment is normally located closer together.

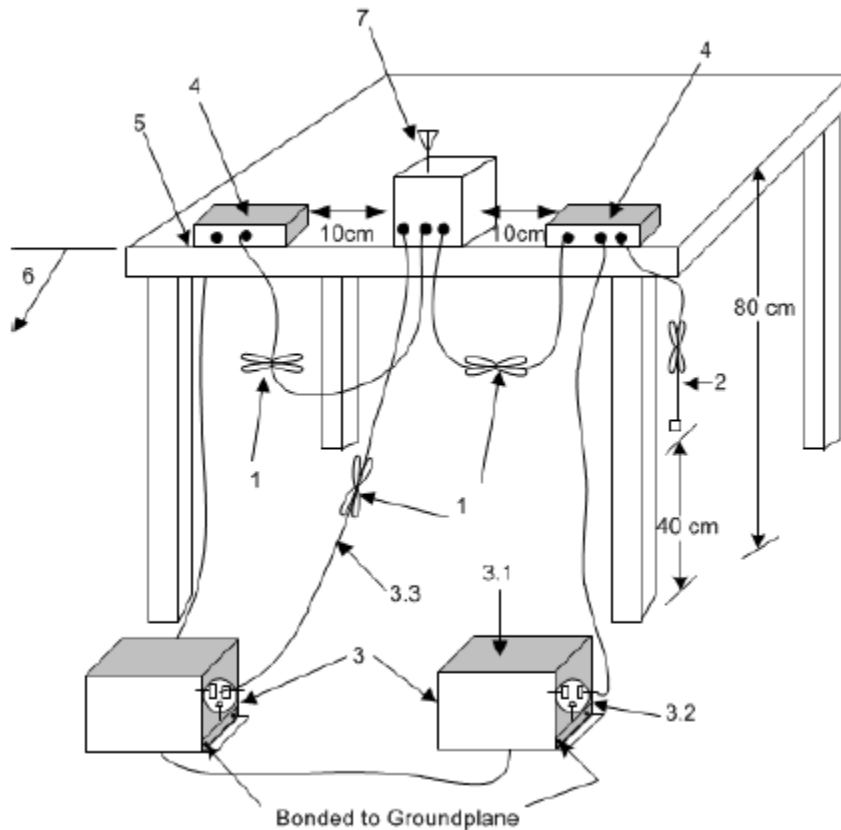

Exploratory ac power-line conducted emission measurements

Exploratory measurements shall be used to identify the frequency of the emission that has the highest amplitude relative to the limit by operating the EUT in a range of typical modes of operation, cable positions, and with a typical system equipment configuration and arrangement. For each mode of operation and for each ac power current-carrying conductor, cable manipulation shall be performed within the range of likely configurations. For this measurement or series of measurements, the frequency spectrum of interest shall be monitored looking for the emission that has the highest amplitude relative to the limit. Once that emission is found for each current-carrying conductor of each power cord associated with the EUT (but not the cords

associated with non-EUT equipment in the overall system), the one configuration and arrangement and mode of operation that produces the emission closest to the limit over all of the measured conductors shall be recorded.

Final ac power-line conducted emission measurements

Based on the exploratory tests of the EUT, the one EUT cable configuration and arrangement and mode of operation that produced the emission with the highest amplitude relative to the limit is selected for the final measurement, while applying the appropriate modulating signal to the EUT. If the EUT is relocated from an exploratory test site to a final test site, the highest emissions shall be remaximized at the final test location before final ac power-line conducted emission measurements are performed. The final test on all current-carrying conductors of all of the power cords to the equipment that comprises the EUT (but not the cords associated with other non-EUT equipment in the system) is then performed for the full frequency range for which the EUT is being tested for compliance without further variation of the EUT arrangement, cable positions, or EUT mode of operation. If the EUT is composed of equipment units that have their own separate ac power connections (e.g., floor-standing equipment with independent power cords for each shelf that are able to connect directly to the ac power network), then each current-carrying conductor of one unit is measured while the other units are connected to a second (or more) LISN(s). All units shall be measured separately. If a power strip is provided by the manufacturer, to supply all of the units making up the EUT, only the conductors in the power cord of the power strip shall be measured.

Test Condition:

Voltage (V)	Frequency (Hz)
120	60

Measurement Result and limit:

EUT ID: EUT1

Measurement Result and limit:

WLAN (Quasi-peak Limit)

Frequency range (MHz)	Quasi-peak Limit (dB μ V)	Result (dB μ V)		Conclusion
		With charger		
		802.11b	Idle	
0.15 to 0.5	66 to 56	Fig.A.7.1	Fig.A.7.2	P
0.5 to 5	56			
5 to 30	60			

NOTE: The limit decreases linearly with the logarithm of the frequency in the range 0.15 MHz to 0.5 MHz.

WLAN (Average Limit)

Frequency range (MHz)	Average Limit (dB μ V)	Result (dB μ V)		Conclusion
		With charger		
		802.11b	Idle	
0.15 to 0.5	56 to 46	Fig.A.7.1	Fig.A.7.2	P
0.5 to 5	46			
5 to 30	50			

NOTE: The limit decreases linearly with the logarithm of the frequency in the range 0.15 MHz to 0.5 MHz.

Conclusion: Pass

Test graphs as below:

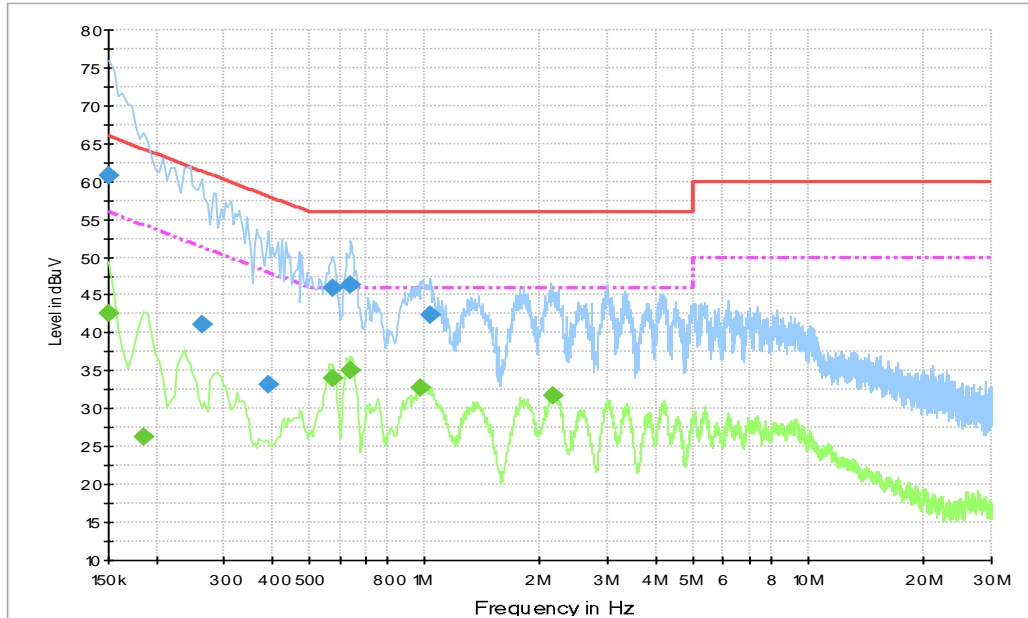

Fig.A.7.1 AC Powerline Conducted Emission-802.11b

Note: The graphic result above is the maximum of the measurements for both phase line and neutral line.

Final Result 1

Frequency (MHz)	QuasiPeak (dBμV)	Line	Margin (dB)	Limit (dBμV)
0.150000	60.7	L1	5.3	66.0
0.262500	41.2	L1	20.1	61.4
0.393000	33.1	L1	24.9	58.0
0.573000	45.9	L1	10.1	56.0
0.640500	46.3	L1	9.7	56.0
1.036500	42.3	L1	13.7	56.0

Final Result 2

Frequency (MHz)	Average (dBμV)	Line	Margin (dB)	Limit (dBμV)
0.150000	42.6	L1	13.4	56.0
0.186000	26.3	L1	27.9	54.2
0.577500	34.0	N	12.0	46.0
0.640500	35.1	L1	10.9	46.0
0.978000	32.7	L1	13.3	46.0
2.148000	31.7	L1	14.3	46.0

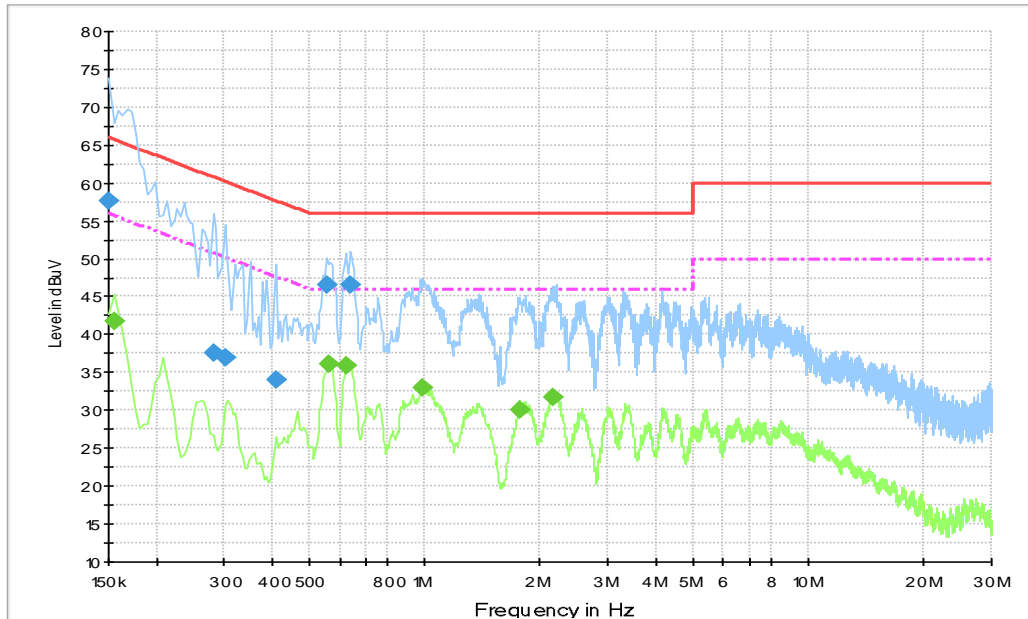

Fig.A.7.2 AC Powerline Conducted Emission-Idle

Note: The graphic result above is the maximum of the measurements for both phase line and neutral line.

Final Result 1

Frequency (MHz)	QuasiPeak (dBµV)	Line	Margin (dB)	Limit (dBµV)
0.150000	57.7	L1	8.3	66.0
0.280500	37.7	L1	23.1	60.8
0.303000	36.9	L1	23.2	60.2
0.411000	34.0	N	23.7	57.6
0.555000	46.5	L1	9.5	56.0
0.640500	46.7	L1	9.3	56.0

Final Result 2

Frequency (MHz)	Average (dBµV)	Line	Margin (dB)	Limit (dBµV)
0.154500	41.8	L1	13.9	55.8
0.564000	36.0	N	10.0	46.0
0.627000	35.9	L1	10.1	46.0
0.987000	33.1	L1	12.9	46.0
1.770000	30.0	L1	16.0	46.0
2.161500	31.8	L1	14.2	46.0

ANNEX B: Accreditation Certificate

<p>United States Department of Commerce National Institute of Standards and Technology</p> 	
<hr/> <p>Certificate of Accreditation to ISO/IEC 17025:2005</p> <hr/>	
<p>NVLAP LAB CODE: 600118-0</p>	
<p>Telecommunication Technology Labs, CAICT Beijing China</p>	
<p><i>is accredited by the National Voluntary Laboratory Accreditation Program for specific services, listed on the Scope of Accreditation, for:</i></p>	
<p>Electromagnetic Compatibility & Telecommunications</p>	
<p><i>This laboratory is accredited in accordance with the recognized International Standard ISO/IEC 17025:2005. This accreditation demonstrates technical competence for a defined scope and the operation of a laboratory quality management system (refer to joint ISO-ILAC-IAF Communique dated January 2009).</i></p>	
<hr/> <p>2019-09-26 through 2020-09-30 <i>Effective Dates</i></p>	 <hr/> <p><i>[Signature]</i> For the National Voluntary Laboratory Accreditation Program</p>

END OF REPORT