



SAR TEST REPORT

No. I19Z61261-SEM05

For

TCL Communication Ltd.

HSUPA/HSDPA/UMTS Bi-Bands/GSM Quad-Bands/LTE 7

Bands/CDMA Tri-bands mobile phone

Model Name: 4053S

With

Hardware Version: 05

Software Version: 1A38

FCC ID: 2ACCJN033

Issued Date: 2019-9-18



Note:

The test results in this test report relate only to the devices specified in this report. This report shall not be reproduced except in full without the written approval of CTTL.

The report must not be used by the client to claim product certification, approval, or endorsement by NVLAP, NIST, or any agency of the U.S. Government.

Test Laboratory:

CTTL, Telecommunication Technology Labs, CAICT

No. 51, Huayuan North Road, Haidian District, Beijing, P. R. China 100191.

Tel:+86(0)10-62304633-2512, Fax:+86(0)10-62304633-2504

Email: ctl_terminals@caict.ac.cn, website: www.caict.ac.cn



REPORT HISTORY

Report Number	Revision	Issue Date	Description
I19Z61261-SEM05	Rev.0	2019-9-18	Initial creation of test report
I19Z61261-SEM05	Rev.1	2019-10-11	NII instead of DTS on page 6 of test report. Update typo on the table 2.3 Update section 14 page 56 for GSM1900. Update the maximum tune-up power for 5G on table 14.4-9. Update the duty cycle on plot of GSM850 and GSM1900 page 89 and 91. Update the WCDMA1900 head test plot for to Left. Supplementary information for duty cycle information on page 115~118. Remove System Verification Results for WiFi 2.4GHz on 2019/8/6. Update the Company Address on page 8.
I19Z61261-SEM05	Rev.2	2019-10-14	Update the medium parameter on page 115.
I19Z61261-SEM05	Rev.3	2019-10-15	Remove the output power of WIFI 2.4G 11n-40M.

TABLE OF CONTENT

1	TEST LABORATORY	5
1.1	TESTING LOCATION	5
1.2	TESTING ENVIRONMENT.....	5
1.3	PROJECT DATA.....	5
1.4	SIGNATURE.....	5
2	STATEMENT OF COMPLIANCE	6
3	CLIENT INFORMATION	8
3.1	APPLICANT INFORMATION	8
3.2	MANUFACTURER INFORMATION	8
4	EQUIPMENT UNDER TEST (EUT) AND ANCILLARY EQUIPMENT (AE)	9
4.1	ABOUT EUT	9
4.2	INTERNAL IDENTIFICATION OF EUT USED DURING THE TEST	9
4.3	INTERNAL IDENTIFICATION OF AE USED DURING THE TEST.....	9
5	TEST METHODOLOGY	10
5.1	APPLICABLE LIMIT REGULATIONS	10
5.2	APPLICABLE MEASUREMENT STANDARDS.....	10
6	SPECIFIC ABSORPTION RATE (SAR)	11
6.1	INTRODUCTION	11
6.2	SAR DEFINITION	11
7	TISSUE SIMULATING LIQUIDS	12
7.1	TARGETS FOR TISSUE SIMULATING LIQUID	12
7.2	DIELECTRIC PERFORMANCE	12
8	SYSTEM VERIFICATION	20
8.1	SYSTEM SETUP	20
8.2	SYSTEM VERIFICATION.....	21
9	MEASUREMENT PROCEDURES	22
9.1	TESTS TO BE PERFORMED.....	22
9.2	GENERAL MEASUREMENT PROCEDURE	24
9.3	WCDMA MEASUREMENT PROCEDURES FOR SAR.....	25
9.4	SAR MEASUREMENT FOR LTE	26
9.5	BLUETOOTH & WI-FI MEASUREMENT PROCEDURES FOR SAR.....	26
9.6	POWER DRIFT	27
10	AREA SCAN BASED 1-G SAR	27
10.1	REQUIREMENT OF KDB	27
10.2	FAST SAR ALGORITHMS.....	27
11	CONDUCTED OUTPUT POWER	28

11.1	GSM MEASUREMENT RESULT	28
11.2	WCDMA MEASUREMENT RESULT.....	30
11.3	LTE MEASUREMENT RESULT	31
11.4	WI-FI AND BT MEASUREMENT RESULT	51
12	SIMULTANEOUS TX SAR CONSIDERATIONS	53
12.1	INTRODUCTION	53
12.2	TRANSMIT ANTENNA SEPARATION DISTANCES	53
12.3	SAR MEASUREMENT POSITIONS	54
12.4	STANDALONE SAR TEST EXCLUSION CONSIDERATIONS.....	54
13	EVALUATION OF SIMULTANEOUS.....	55
14	SAR TEST RESULT	56
14.1	SAR RESULTS	57
14.2	SAR RESULTS FOR STANDARD PROCEDURE.....	67
14.2	14.3 WLAN EVALUATION FOR 2.4G.....	73
14.3	14.4 WLAN EVALUATION FOR 5G	76
15	SAR MEASUREMENT VARIABILITY	81
16	MEASUREMENT UNCERTAINTY	83
17	MAIN TEST INSTRUMENTS.....	88
ANNEX A	GRAPH RESULTS.....	89
ANNEX B	SYSTEM VERIFICATION RESULTS	130
ANNEX C	SAR MEASUREMENT SETUP	147
ANNEX D	POSITION OF THE WIRELESS DEVICE IN RELATION TO THE PHANTOM	153
ANNEX E	EQUIVALENT MEDIA RECIPES	156
ANNEX F	SYSTEM VALIDATION	157
ANNEX G	PROBE CALIBRATION CERTIFICATE.....	158
ANNEX H	ACCREDITATION CERTIFICATE	239

1 Test Laboratory

1.1 Testing Location

Company Name:	CTTL(Shouxiang)
Address:	No. 51 Shouxiang Science Building, Xueyuan Road, Haidian District, Beijing, P. R. China100191

1.2 Testing Environment

Temperature:	18°C~25 °C,
Relative humidity:	30%~ 70%
Ground system resistance:	< 0.5 Ω
Ambient noise & Reflection:	< 0.012 W/kg

1.3 Project Data

Project Leader:	Qi Dianyuan
Test Engineer:	Lin Xiaojun
Testing Start Date:	August 2, 2019
Testing End Date:	September 6, 2019

1.4 Signature



Lin Xiaojun

(Prepared this test report)

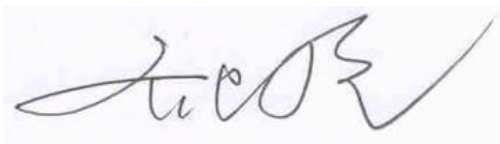

Qi Dianyuan

(Reviewed this test report)



Lu Bingsong

Deputy Director of the laboratory
(Approved this test report)

2 Statement of Compliance

The maximum results of SAR found during testing for TCL Communication Ltd. HSUPA/HSDPA/UMTS Bi-Bands/GSM Quad-Bands/LTE 7Bands/CDMA Tri-bands mobile phone 4053S is as follows:

Table 2.1: Highest Reported SAR (1g)

Exposure Configuration	Technology Band	Highest Reported SAR 1g (W/Kg)	Equipment Class
Head (Separation Distance 0mm)	GSM 850	0.51	PCE
	PCS 1900	0.20	
	UMTS FDD 5	0.57	
	UMTS FDD 2	0.45	
	BC 0	0.70	
	BC 1	0.51	
	BC 10	0.59	
	LTE Band 4	0.40	
	LTE Band 13	0.28	
	LTE Band 25	0.30	
	LTE Band 26	0.58	
	LTE Band 41 PC3	0.71	
	LTE Band 41 PC2	0.69	
	WLAN 2.4 GHz	0.87	DTS
	WLAN 5 GHz	0.51	NII
Body-worn (Separation Distance 15mm)	GSM 850	0.69	PCE
	PCS 1900	0.39	
	UMTS FDD 5	0.84	
	UMTS FDD 2	1.00	
	BC 0	0.91	
	BC 1	1.03	
	BC 10	0.94	
	LTE Band 4	1.11	
	LTE Band 13	0.52	
	LTE Band 25	0.87	
	LTE Band 26	0.80	
	LTE Band 41 PC3	0.74	
	LTE Band 41 PC2	1.04	
	WLAN 2.4 GHz	0.15	DTS
	WLAN 5 GHz	0.31	NII

The SAR values found for the Mobile Phone are below the maximum recommended levels of 1.6 W/Kg as averaged over any 1g tissue according to the ANSI C95.1-1992.

For body worn operation, this device has been tested and meets FCC RF exposure guidelines when used with any accessory that contains no metal and which provides a minimum separation distance

of 15mm between this device and the body of the user. Use of other accessories may not ensure compliance with FCC RF exposure guidelines.

The EUT battery must be fully charged and checked periodically during the test to ascertain uniform power output.

The measurement together with the test system set-up is described in annex C of this test report. A detailed description of the equipment under test can be found in chapter 4 of this test report.

The highest reported SAR value is obtained at the case of **(Table 2.1)**, and the values are: **1.11 W/kg (1g)**.

Table 2.2: The sum of reported SAR values for main antenna and WiFi

	Position	Main antenna	WiFi 2.4G	Sum
Highest reported SAR value for Head	Right hand, Touch cheek	0.70	0.87	1.57
Highest reported SAR value for Head	Left hand, Touch cheek	0.71	0.74	1.45
Highest reported SAR value for Body	Rear 15mm	1.11	0.1	1.21

	Position	Main antenna	WiFi 5G	Sum
Highest reported SAR value for Head	Right hand, Touch cheek	0.70	0.51	1.21
Highest reported SAR value for Head	Left hand, Touch cheek	0.71	0.27	0.98
Highest reported SAR value for Body	Rear 15mm	1.11	0.31	1.42

Table 2.3: The sum of reported SAR values for main antenna and BT

	Position	Main antenna	BT	Sum
Highest reported SAR value for Head	Left hand, Touch cheek	0.71	0.66	1.37
Highest reported SAR value for Body	Rear 15mm	1.11	0.22	1.33

Note: The result of Bluetooth Head and Body is lower than 0.01

According to the above tables, the highest sum of reported SAR values is **1.57 W/kg (1g)**. The detail for simultaneous transmission consideration is described in chapter 13.



3 Client Information

3.1 Applicant Information

Company Name	TCL Communication Ltd.
Company Address	5/F, Building 22E, 22 Science Park East Avenue, Hong Kong Science Park, Shatin, NT, Hong Kong
Contact Person	Gong Zhizhou
Tel	0086-755-36611722
Fax	0086-755-36612000-81722
E-Mail	zhizhou.gong@tcl.com

3.2 Manufacturer Information

Company Name	TCL Communication Ltd.
Company Address	5/F, Building 22E, 22 Science Park East Avenue, Hong Kong Science Park, Shatin, NT, Hong Kong
Contact Person	Gong Zhizhou
Tel	0086-755-36611722
Fax	0086-755-36612000-81722
E-Mail	zhizhou.gong@tcl.com

4 Equipment Under Test (EUT) and Ancillary Equipment (AE)

4.1 About EUT

Description:	HSUPA/HSDPA/ UMTS Bi-Bands/GSM Quad-Bands/LTE 7 Bands/ CDMA Tri-bands mobile phone
Model name:	4053S
Operating mode(s):	GSM 850/900/1800/1900 WCDMA850/1900 CDMA BC0/1/10 LTE B2/4/5/13/25/26/41, BT, WLAN
Tested Tx Frequency:	825 – 848.8 MHz (GSM 850)
	1850.2 – 1910 MHz (GSM 1900)
	824.7 - 848.31 MHz (CDMA BC0)
	1851.25 - 1908.75 MHz (CDMA BC1)
	817.9 - 823.1 MHz (CDMA BC10)
	826.4–846.6 MHz (WCDMA 850 Band V)
	1852.4–1907.6 MHz (WCDMA1900 Band II)
	1710-1755 (LTE Band 4)
	779.5 –784.5 MHz (LTE Band 13)
	1850.7 –1914.3 MHz (LTE Band 25)
	814.7–848.3 MHz (LTE Band 26)
	2498.5 – 2687.5 MHz (LTE Band41)
	2412 – 2462 MHz (Wi-Fi 2.4G)
5.15 – 5.25 GHz 5.725 – 5.825 GHz(Wi-Fi 5G)	
GPRS/EGPRS Multislot Class:	12
Device type:	Portable device
Antenna type:	Integrated antenna

4.2 Internal Identification of EUT used during the test

EUT			
EUTID	IMEI	HW Version	SW Version
1	015501000008813	05	1A38
2	015501000008540	05	1A38
3	015501000009308	05	1A38
4	015501000009340	05	1A38
5	015501000008961	05	1A38
6	015501000009423	05	1A38

*EUT ID: is used to identify the test sample in the lab internally.

Note: It is performed to test SAR with the EUT1&2 and conducted power with the EUT3.

4.3 Internal Identification of AE used during the test

AE ID	Description	Model	SN	Manufacturer
AE1	Battery	TLi017C1	/	/

*AE ID: is used to identify the test sample in the lab internally.



5 TEST METHODOLOGY

5.1 Applicable Limit Regulations

ANSI C95.1–1992: IEEE Standard for Safety Levels with Respect to Human Exposure to Radio Frequency Electromagnetic Fields, 3 kHz to 300 GHz.

It specifies the maximum exposure limit of **1.6 W/kg** as averaged over any 1 gram of tissue for portable devices being used within 20 cm of the user in the uncontrolled environment.

5.2 Applicable Measurement Standards

IEEE 1528–2013: Recommended Practice for Determining the Peak Spatial-Average Specific Absorption Rate (SAR) in the Human Head from Wireless Communications Devices: Measurement Techniques.

KDB447498 D01 General RF Exposure Guidance v06: Mobile and Portable Devices RF Exposure Procedures and Equipment Authorization Policies.

KDB648474 D04 Handset SAR v01r03: SAR Evaluation Considerations for Wireless Handsets.

KDB941225 D01 SAR test for 3G devices v03r01: SAR Measurement Procedures for 3G Devices

941225 D06 Hot Spot SAR v02r01: SAR EVALUATION PROCEDURES FOR PORTABLE DEVICES WITH WIRELESS ROUTER CAPABILITIES.

KDB941225 D05 SAR for LTE Devices v02r05: SAR Evaluation Considerations for LTE Devices

KDB248227 D01 802.11 Wi-Fi SAR v02r02: SAR GUIDANCE FOR IEEE 802.11 (Wi-Fi) TRANSMITTERS

KDB865664 D01 SAR measurement 100 MHz to 6 GHz v01r04: SAR Measurement Requirements for 100 MHz to 6 GHz.

KDB865664 D02 RF Exposure Reporting v01r02: RF Exposure Compliance Reporting and Documentation Considerations

6 Specific Absorption Rate (SAR)

6.1 Introduction

SAR is related to the rate at which energy is absorbed per unit mass in an object exposed to a radio field. The SAR distribution in a biological body is complicated and is usually carried out by experimental techniques or numerical modeling. The standard recommends limits for two tiers of groups, occupational/controlled and general population/uncontrolled, based on a person's awareness and ability to exercise control over his or her exposure. In general, occupational/controlled exposure limits are higher than the limits for general population/uncontrolled.

6.2 SAR Definition

The SAR definition is the time derivative (rate) of the incremental energy (dW) absorbed by (dissipated in) an incremental mass (dm) contained in a volume element (dv) of a given density (ρ). The equation description is as below:

$$SAR = \frac{d}{dt} \left(\frac{dW}{dm} \right) = \frac{d}{dt} \left(\frac{dW}{\rho dv} \right)$$

SAR is expressed in units of Watts per kilogram (W/kg)

SAR measurement can be either related to the temperature elevation in tissue by

$$SAR = c \left(\frac{\delta T}{\delta t} \right)$$

Where: C is the specific heat capacity, δT is the temperature rise and δt is the exposure duration, or related to the electrical field in the tissue by

$$SAR = \frac{\sigma |E|^2}{\rho}$$

Where: σ is the conductivity of the tissue, ρ is the mass density of tissue and E is the RMS electrical field strength.

However for evaluating SAR of low power transmitter, electrical field measurement is typically applied.

7 Tissue Simulating Liquids

7.1 Targets for tissue simulating liquid

Table 7.1: Targets for tissue simulating liquid

Frequency(MHz)	Liquid Type	Conductivity(σ)	$\pm 5\%$ Range	Permittivity(ϵ)	$\pm 5\%$ Range
750	Head	0.89	0.85~0.93	41.94	39.8~44.0
750	Body	0.96	0.91~1.01	55.5	52.7~58.3
835	Head	0.90	0.86~0.95	41.5	39.4~43.6
835	Body	0.97	0.92~1.02	55.2	52.4~58.0
1750	Head	1.37	1.30~1.44	40.08	38.1~42.1
1750	Body	1.49	1.42~1.56	53.4	50.7~56.1
1900	Head	1.40	1.33~1.47	40.0	38.0~42.0
1900	Body	1.52	1.44~1.60	53.3	50.6~56.0
2450	Head	1.80	1.71~1.89	39.2	37.2~41.2
2450	Body	1.95	1.85~2.05	52.7	50.1~55.3
2600	Head	1.96	1.86~2.06	39.01	37.1~40.9
2600	Body	2.16	2.05~2.27	52.5	49.9~55.1
5200	Head	4.66	4.43~4.89	35.99	34.19~37.79
5200	Body	5.30	5.04~5.56	49.0	46.6~51.4
5750	Head	5.27	5.01~5.53	35.3	33.5~37.1
5750	Body	6.00	5.70~6.30	48.2	45.8~50.6

7.2 Dielectric Performance

Table 7.2: Dielectric Performance of Tissue Simulating Liquid

Measurement Date yyyy/mm/dd	Frequency	Type	Permittivity ϵ	Drift (%)	Conductivity σ (S/m)	Drift (%)
2019-8-2	750 MHz	Head	41.7	-0.57	0.898	0.90
		Body	55.35	-0.27	0.951	-0.94
2019-8-3	835 MHz	Head	41.6	0.24	0.901	0.11
		Body	56.1	1.63	0.988	1.86
2019-8-4	1750 MHz	Head	40.68	1.50	1.38	0.73
		Body	53.22	-0.34	1.514	1.61
2019-8-5	1900 MHz	Head	39.55	-1.13	1.39	-0.71
		Body	53.19	-0.21	1.536	1.05
2019-9-5	2450 MHz	Head	39.22	0.05	1.813	0.72
		Body	52.62	-0.15	1.95	0.00
2019-8-7	2600 MHz	Head	39.57	1.44	1.966	0.31
		Body	51.61	-1.70	2.138	-1.02
2019-9-6	5250 MHz	Head	35.37	-1.56	4.711	0.02
		Body	49.46	1.15	5.337	-0.43
2019-9-6	5750 MHz	Head	35.02	-0.96	5.173	-0.90
		Body	47.51	-1.64	5.528	0.69

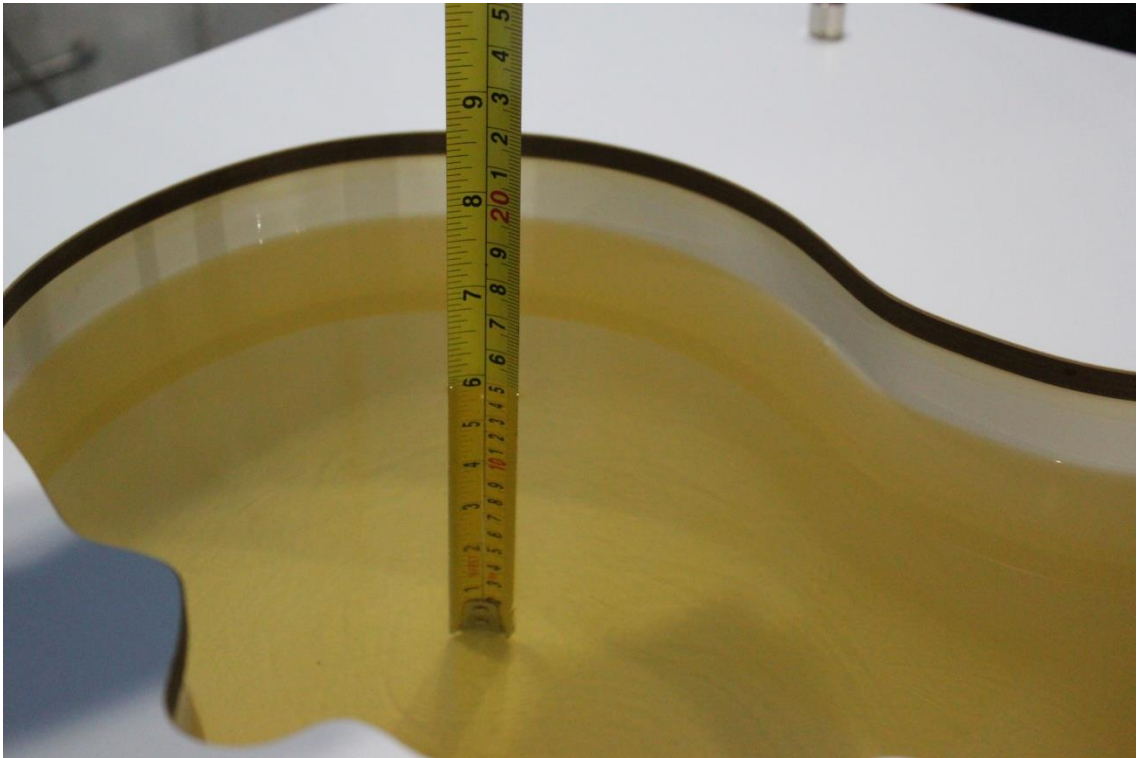

Picture 7-1 Liquid depth in the Head Phantom (750 MHz)



Picture 7-2 Liquid depth in the Flat Phantom (750 MHz)

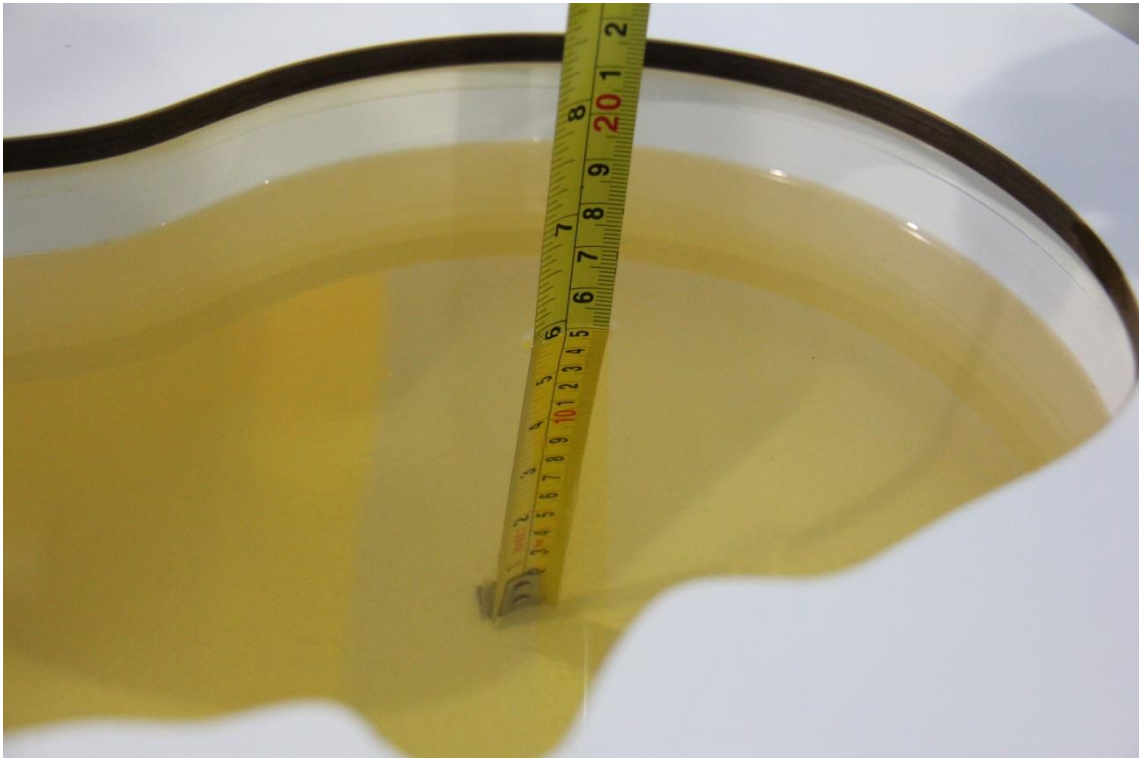

Picture 7-3 Liquid depth in the Head Phantom (835MHz)

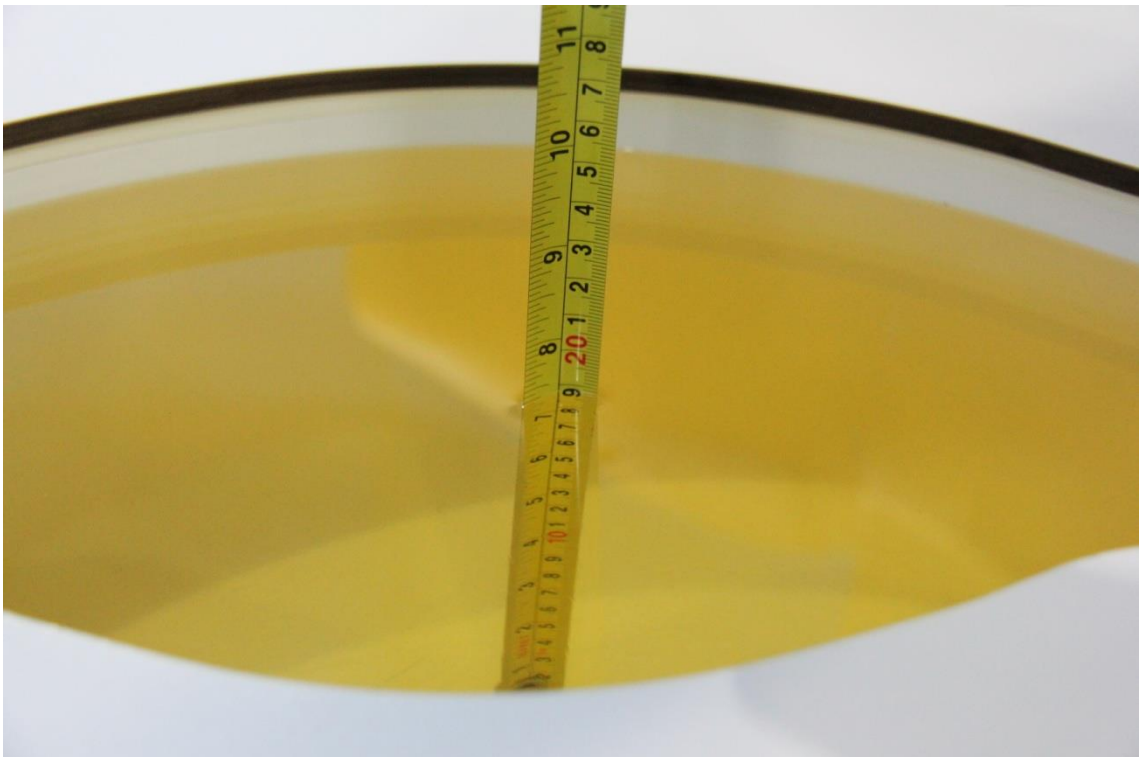

Picture 7-4 Liquid depth in the Flat Phantom (835MHz)

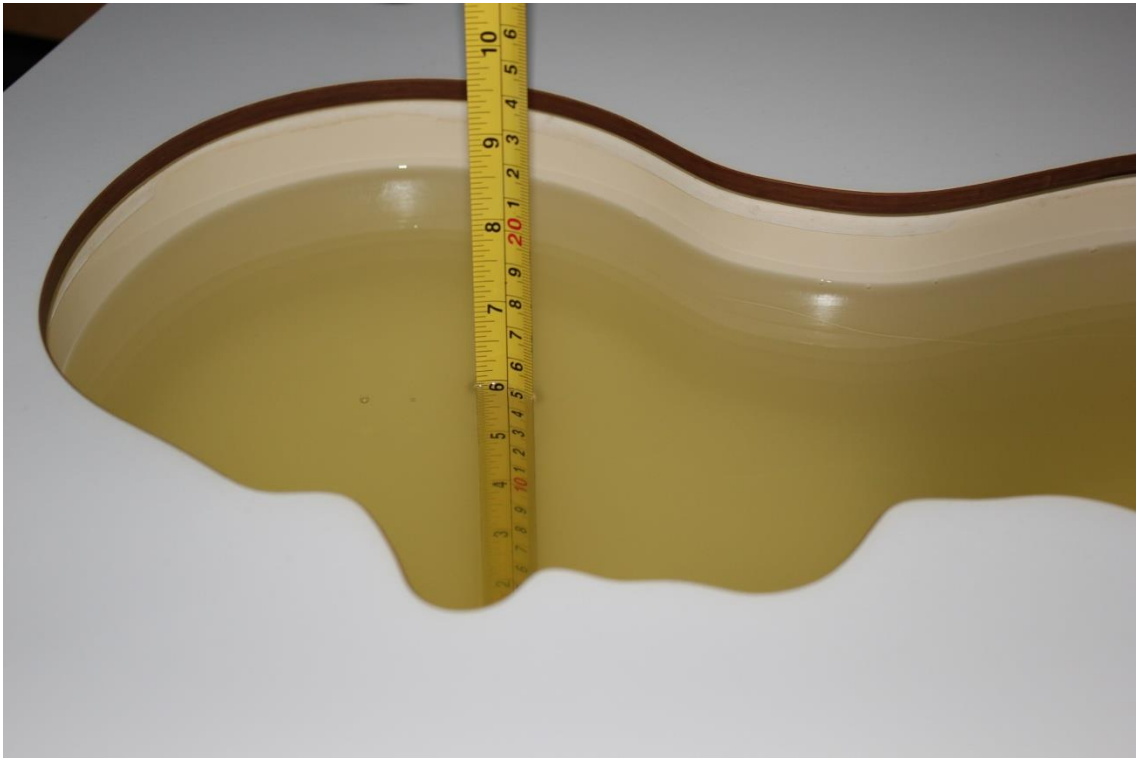

Picture 7-5 Liquid depth in the Head Phantom (1750 MHz)

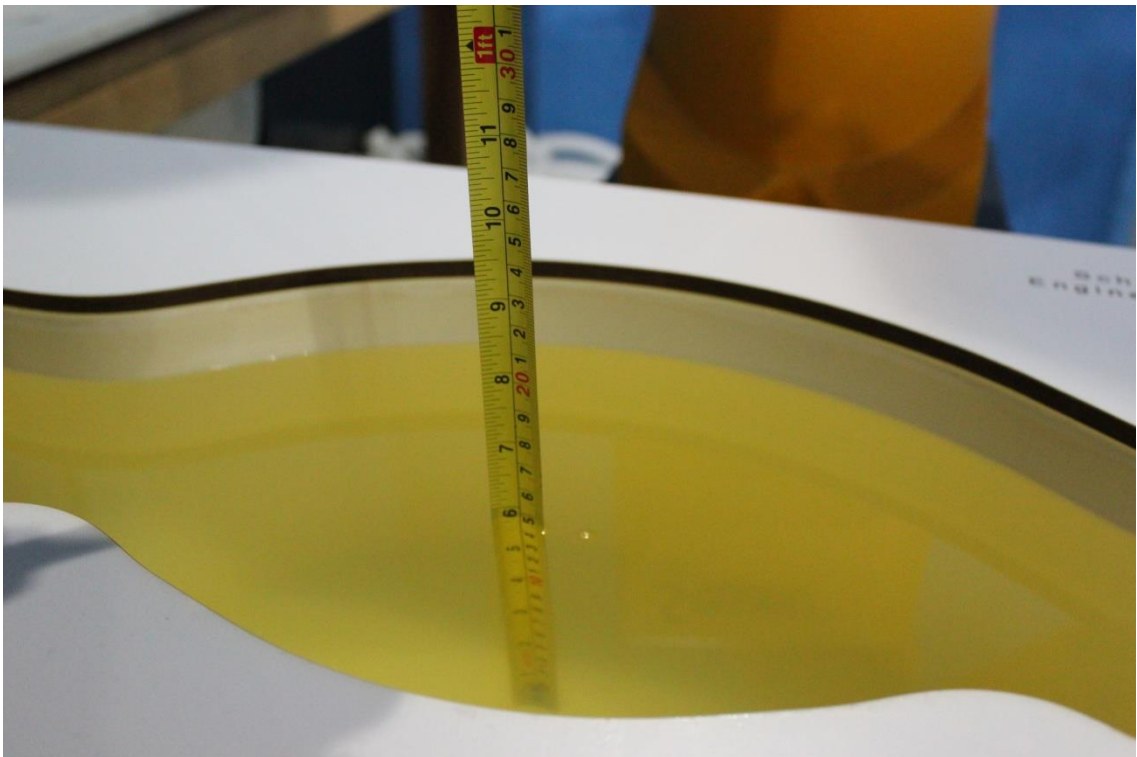

Picture 7-6 Liquid depth in the Flat Phantom (1750MHz)

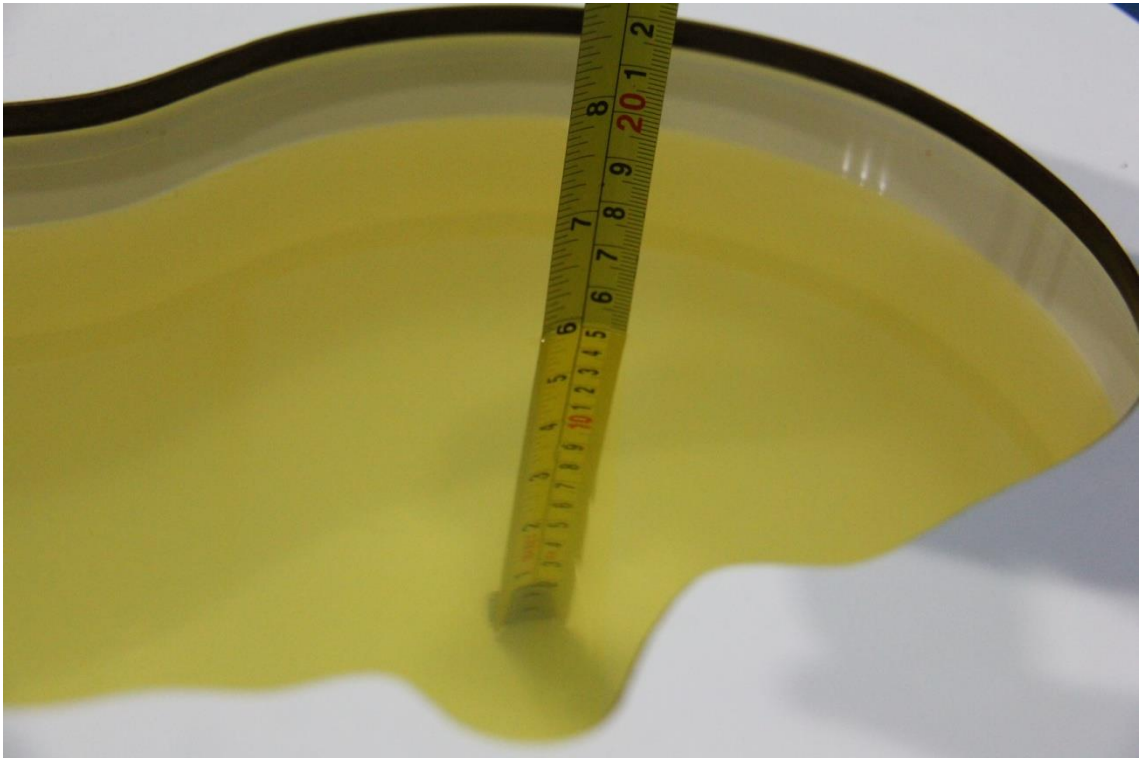

Picture 7-7 Liquid depth in the Head Phantom (1900 MHz)

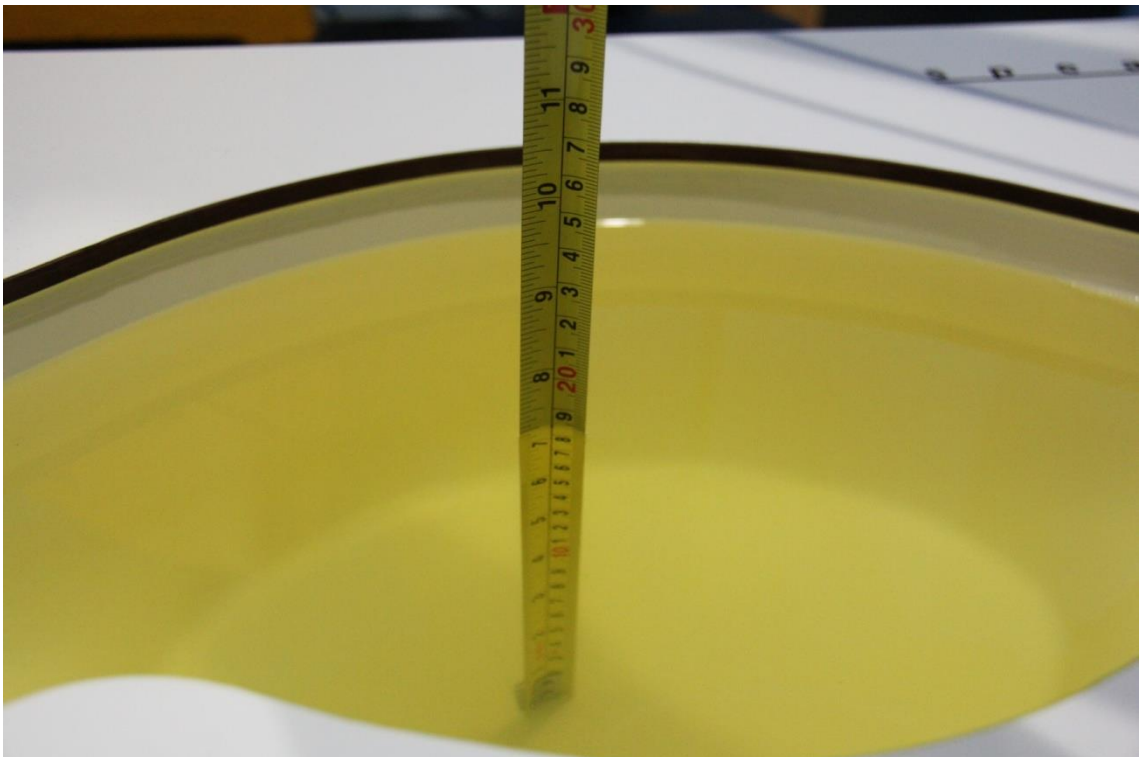

Picture 7-8 Liquid depth in the Flat Phantom (1900MHz)

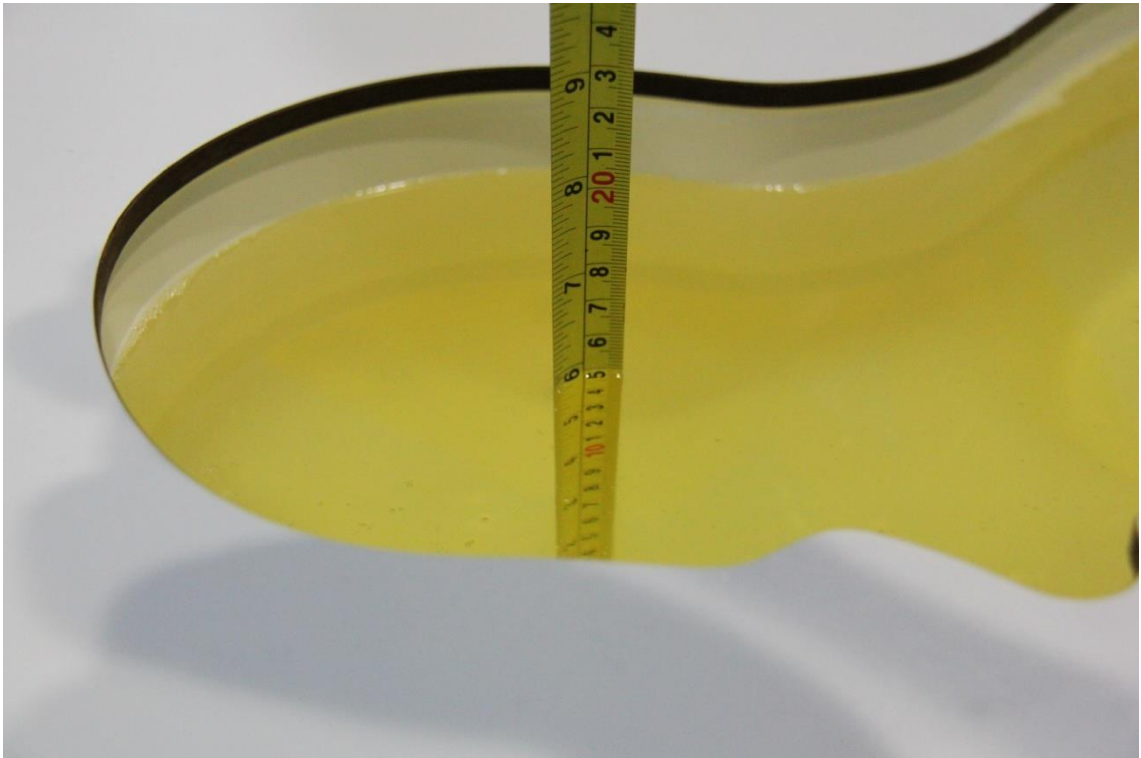

Picture 7-9 Liquid depth in the Head Phantom (2450MHz)

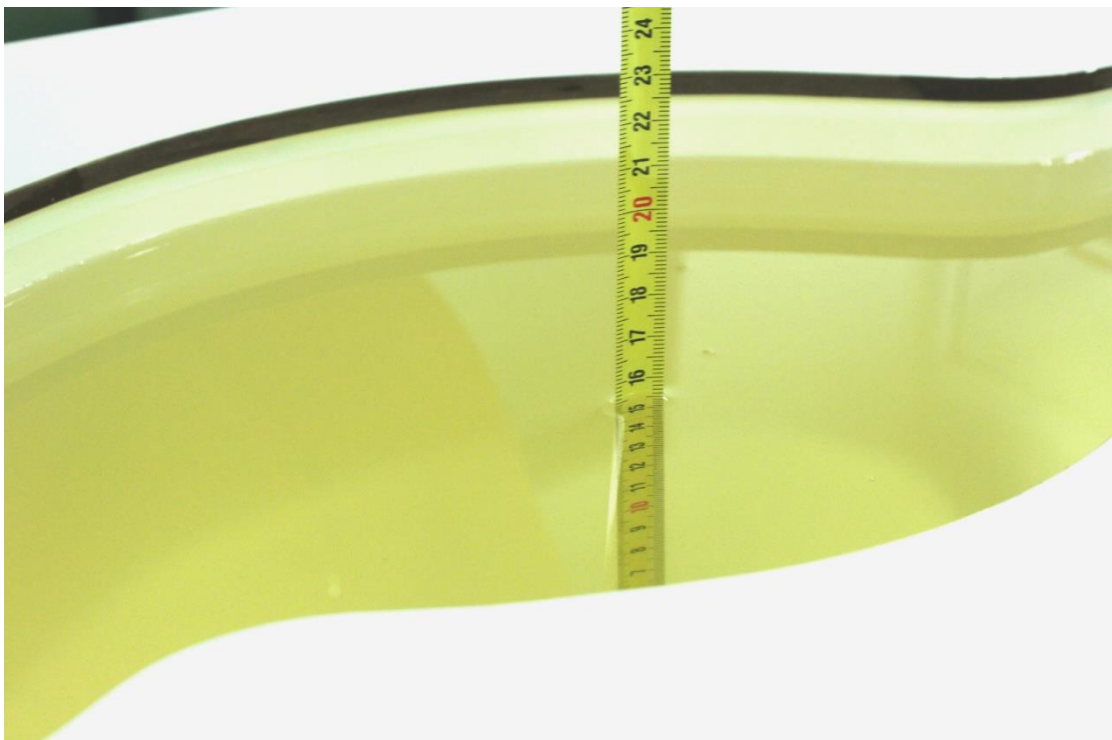

Picture 7-10 Liquid depth in the Flat Phantom (2450MHz)



Picture 7-11 Liquid depth in the Head Phantom (2600 MHz Head)

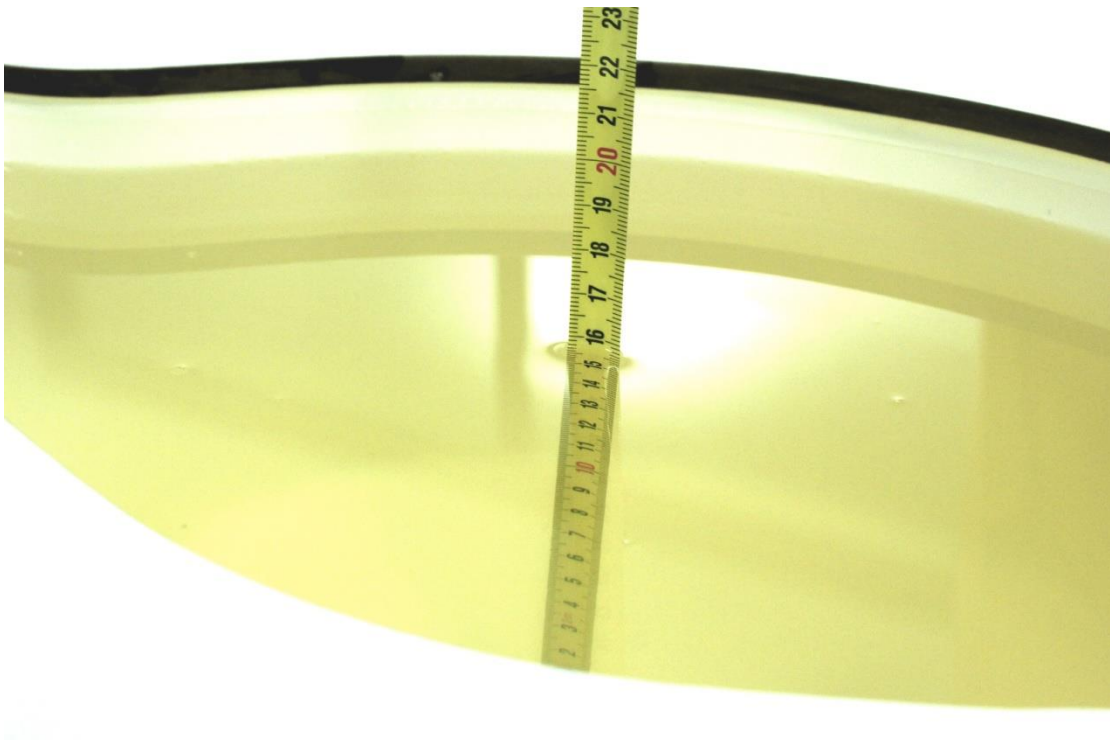

Picture 7-12 Liquid depth in the Flat Phantom (2600MHz)



Picture 7-13 Liquid depth in the Head Phantom (5GHz)

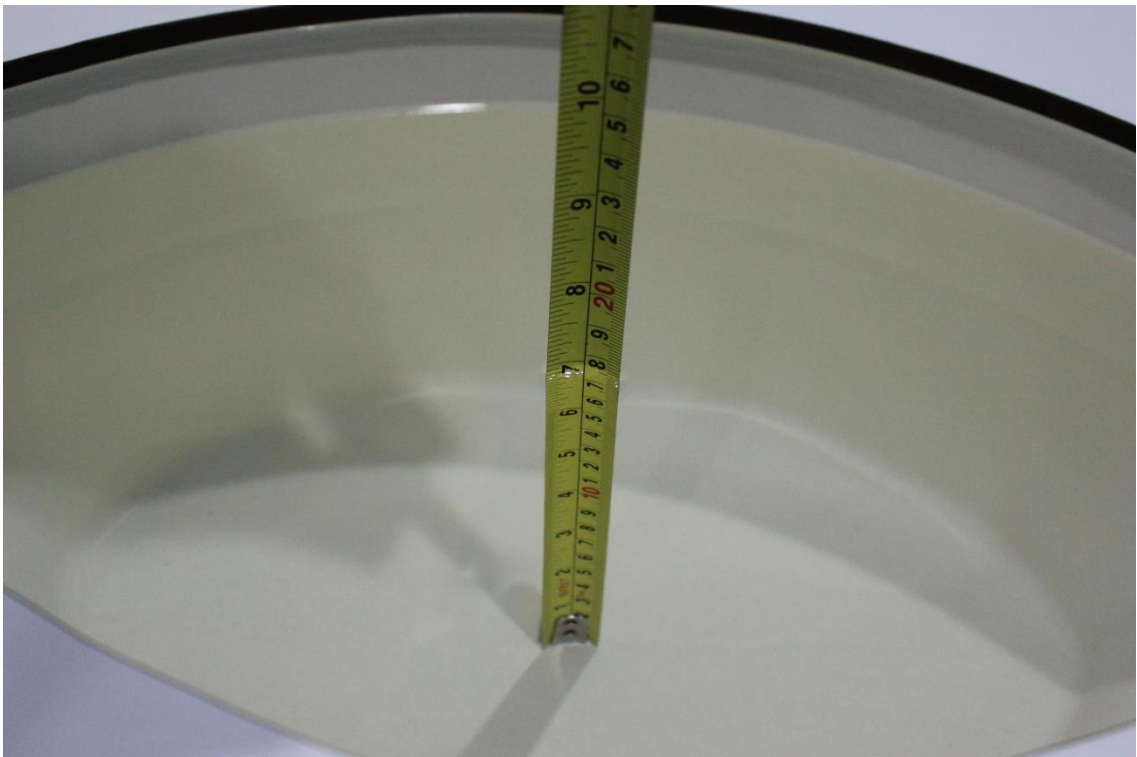

Picture 7-14 Liquid depth in the Flat Phantom (5GHz)

8 System verification

8.1 System Setup

In the simplified setup for system evaluation, the DUT is replaced by a calibrated dipole and the power source is replaced by a continuous wave that comes from a signal generator. The calibrated dipole must be placed beneath the flat phantom section of the SAM twin phantom with the correct distance holder. The distance holder should touch the phantom surface with a light pressure at the reference marking and be oriented parallel to the long side of the phantom. The equipment setup is shown below:

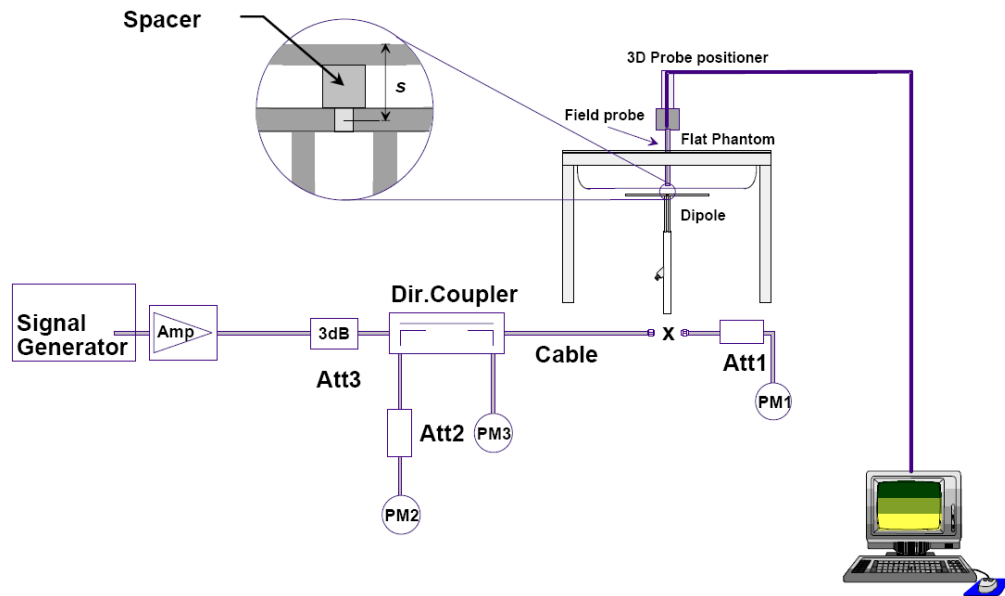

Picture 8.1 System Setup for System Evaluation

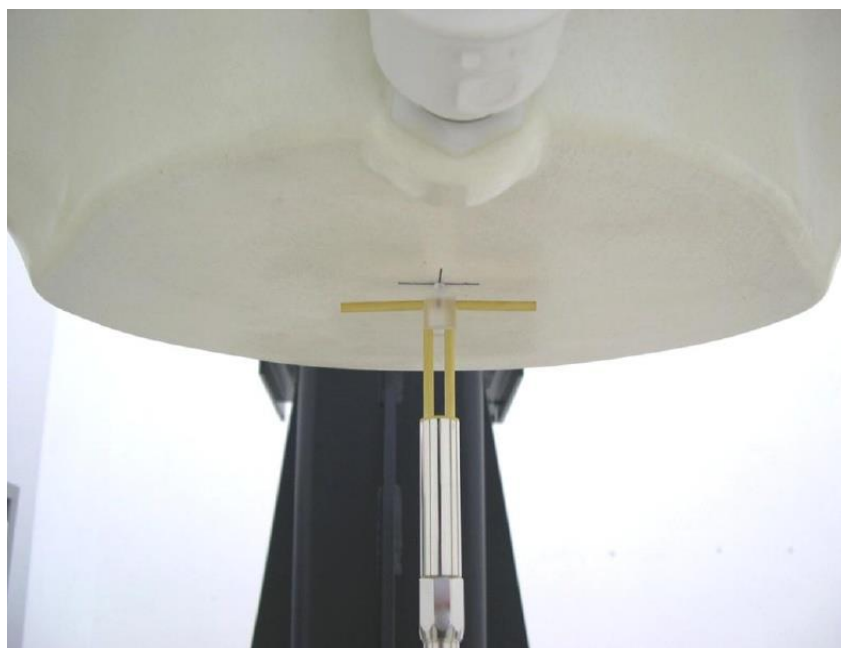

Picture 8.2 Photo of Dipole Setup

8.2 System Verification

SAR system verification is required to confirm measurement accuracy, according to the tissue dielectric media, probe calibration points and other system operating parameters required for measuring the SAR of a test device. The system verification must be performed for each frequency band and within the valid range of each probe calibration point required for testing the device.

The system verification results are required that the area scan estimated 1-g SAR is within 3% of the zoom scan 1-g SAR. The details are presented in annex B.

Table 8.1: System Verification of Head

Measurement Date (yyyy-mm-dd)	Frequency	Target value (W/kg)		Measured value (W/kg)		Deviation	
		10 g Average	1 g Average	10 g Average	1 g Average	10 g Average	1 g Average
2019-8-2	750 MHz	5.57	8.57	5.52	8.56	-0.90%	-0.12%
2019-8-3	835 MHz	6.29	9.70	6.28	9.8	-0.16%	1.03%
2019-8-4	1750 MHz	19.3	36.6	19.4	36.04	0.52%	-1.53%
2019-8-5	1900 MHz	20.8	39.7	20.6	40.28	-0.96%	1.46%
2019-9-5	2450 MHz	24.2	51.6	23.96	50.88	-0.99%	-1.40%
2019-8-7	2600 MHz	25.1	55.8	25.24	56.68	0.56%	1.58%
2019-9-6	5600 MHz	24.1	84.5	24.5	84.8	1.74%	0.36%
2019-9-6	5750 MHz	23.0	80.4	23.1	79.4	0.35%	-1.19%

Table 8.2: System Verification of Body

Measurement Date (yyyy-mm-dd)	Frequency	Target value (W/kg)		Measured value (W/kg)		Deviation	
		10 g Average	1 g Average	10 g Average	1 g Average	10 g Average	1 g Average
2019-8-2	750 MHz	5.63	8.55	5.6	8.72	-0.53%	1.99%
2019-8-3	835 MHz	6.32	9.68	6.4	9.52	1.27%	-1.65%
2019-8-4	1750 MHz	19.5	36.8	19.76	36.48	1.33%	-0.87%
2019-8-5	1900 MHz	20.9	39.7	20.64	39.32	-1.24%	-0.96%
2019-9-5	2450 MHz	24.5	52.3	24.64	52.24	0.57%	-0.11%
2019-8-7	2600 MHz	24.8	55	25.2	54.16	1.61%	-1.53%
2019-9-6	5600 MHz	22.0	78.2	21.6	77.2	-1.64%	-1.33%
2019-9-6	5750 MHz	21.5	77.4	21.7	78.5	1.02%	1.45%

9 Measurement Procedures

9.1 Tests to be performed

In order to determine the highest value of the peak spatial-average SAR of a handset, all device positions, configurations and operational modes shall be tested for each frequency band according to steps 1 to 3 below. A flowchart of the test process is shown in picture 9.1.

Step 1: The tests described in 9.2 shall be performed at the channel that is closest to the center of the transmit frequency band (f_c) for:

- a) all device positions (cheek and tilt, for both left and right sides of the SAM phantom, as described in annex D),
- b) all configurations for each device position in a), e.g., antenna extended and retracted, and
- c) all operational modes, e.g., analogue and digital, for each device position in a) and configuration in b) in each frequency band.

If more than three frequencies need to be tested according to 11.1 (i.e., $N_c > 3$), then all frequencies, configurations and modes shall be tested for all of the above test conditions.

Step 2: For the condition providing highest peak spatial-average SAR determined in Step 1, perform all tests described in 9.2 at all other test frequencies, i.e., lowest and highest frequencies. In addition, for all other conditions (device position, configuration and operational mode) where the peak spatial-average SAR value determined in Step 1 is within 3 dB of the applicable SAR limit, it is recommended that all other test frequencies shall be tested as well.

Step 3: Examine all data to determine the highest value of the peak spatial-average SAR found in Steps 1 to 2.

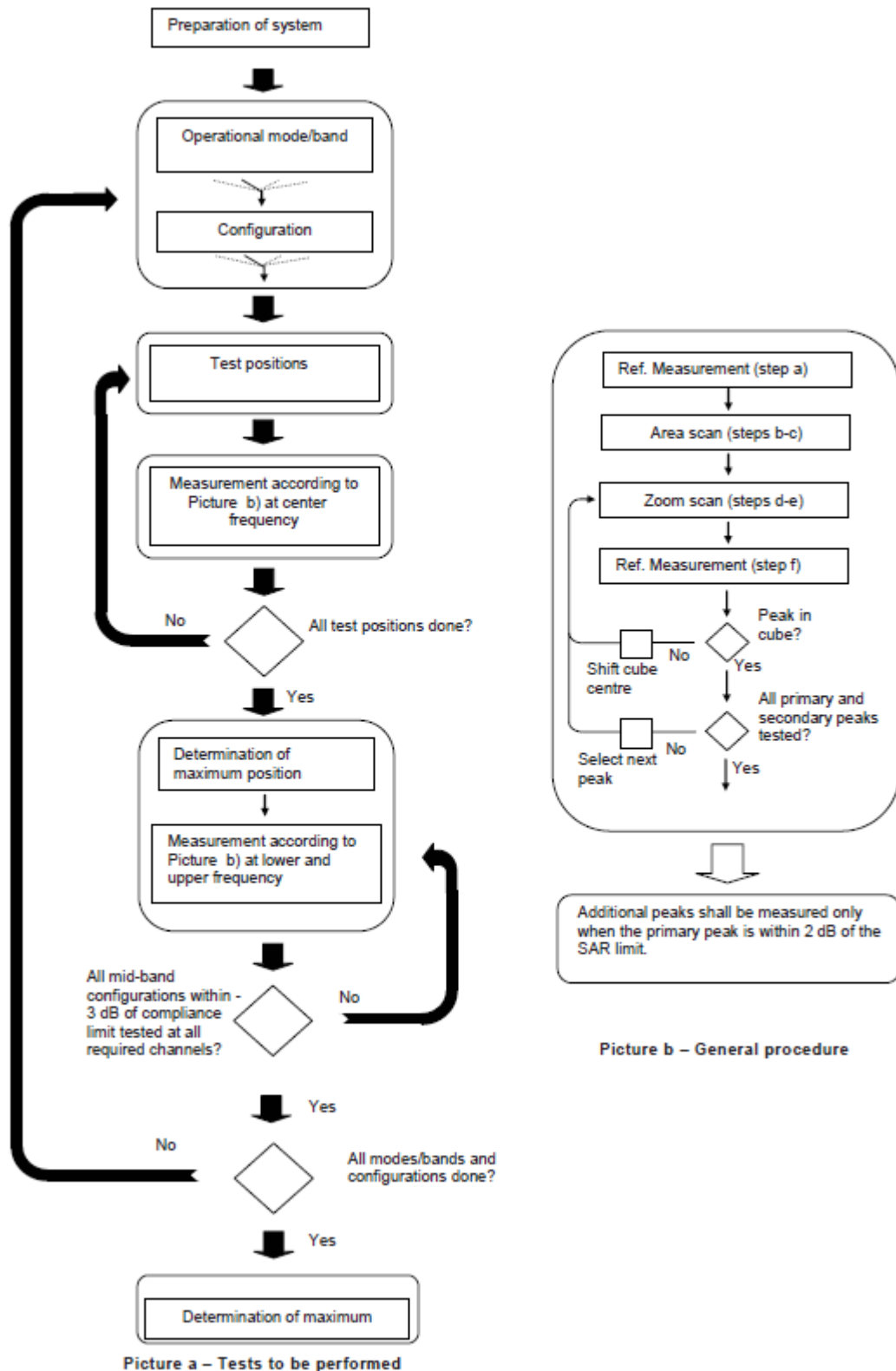

Picture 9.1 Block diagram of the tests to be performed

9.2 General Measurement Procedure

The area and zoom scan resolutions specified in the table below must be applied to the SAR measurements and fully documented in SAR reports to qualify for TCB approval. Probe boundary effect error compensation is required for measurements with the probe tip closer than half a probe tip diameter to the phantom surface. Both the probe tip diameter and sensor offset distance must satisfy measurement protocols; to ensure probe boundary effect errors are minimized and the higher fields closest to the phantom surface can be correctly measured and extrapolated to the phantom surface for computing 1-g SAR. Tolerances of the post-processing algorithms must be verified by the test laboratory for the scan resolutions used in the SAR measurements, according to the reference distribution functions specified in IEEE Std 1528-2013. The results should be documented as part of the system validation records and may be requested to support test results when all the measurement parameters in the following table are not satisfied.

		≤ 3 GHz	> 3 GHz	
Maximum distance from closest measurement point (geometric center of probe sensors) to phantom surface		5 ± 1 mm	$\frac{1}{2} \cdot \delta \cdot \ln(2) \pm 0.5$ mm	
Maximum probe angle from probe axis to phantom surface normal at the measurement location		$30^\circ \pm 1^\circ$	$20^\circ \pm 1^\circ$	
Maximum area scan spatial resolution: Δx_{Area} , Δy_{Area}		≤ 2 GHz: ≤ 15 mm 2 – 3 GHz: ≤ 12 mm	3 – 4 GHz: ≤ 12 mm 4 – 6 GHz: ≤ 10 mm	
		When the x or y dimension of the test device, in the measurement plane orientation, is smaller than the above, the measurement resolution must be \leq the corresponding x or y dimension of the test device with at least one measurement point on the test device.		
Maximum zoom scan spatial resolution: Δx_{Zoom} , Δy_{Zoom}		≤ 2 GHz: ≤ 8 mm 2 – 3 GHz: ≤ 5 mm*	3 – 4 GHz: ≤ 5 mm* 4 – 6 GHz: ≤ 4 mm*	
Maximum zoom scan spatial resolution, normal to phantom surface	uniform grid: $\Delta z_{Zoom}(n)$	≤ 5 mm	3 – 4 GHz: ≤ 4 mm 4 – 5 GHz: ≤ 3 mm 5 – 6 GHz: ≤ 2 mm	
	graded grid	$\Delta z_{Zoom}(1)$: between 1 st two points closest to phantom surface	≤ 4 mm	3 – 4 GHz: ≤ 3 mm 4 – 5 GHz: ≤ 2.5 mm 5 – 6 GHz: ≤ 2 mm
		$\Delta z_{Zoom}(n>1)$: between subsequent points	$\leq 1.5 \cdot \Delta z_{Zoom}(n-1)$	
Minimum zoom scan volume	x, y, z	≥ 30 mm	3 – 4 GHz: ≥ 28 mm 4 – 5 GHz: ≥ 25 mm 5 – 6 GHz: ≥ 22 mm	
Note: δ is the penetration depth of a plane-wave at normal incidence to the tissue medium; see draft standard IEEE P1528-2011 for details. * When zoom scan is required and the <i>reported</i> SAR from the area scan based 1-g SAR estimation procedures of KDB 447498 is ≤ 1.4 W/kg, ≤ 8 mm, ≤ 7 mm and ≤ 5 mm zoom scan resolution may be applied, respectively, for 2 GHz to 3 GHz, 3 GHz to 4 GHz and 4 GHz to 6 GHz.				

9.3 WCDMA Measurement Procedures for SAR

The following procedures are applicable to WCDMA handsets operating under 3GPP Release99, Release 5 and Release 6. The default test configuration is to measure SAR with an established radio link between the DUT and a communication test set using a 12.2kbps RMC (reference measurement channel) configured in Test Loop Mode 1. SAR is selectively confirmed for other physical channel configurations (DPCCH & DPDCH_n), HSDPA and HSPA (HSUPA/HSDPA) modes according to output power, exposure conditions and device operating capabilities. Both uplink and downlink should be configured with the same RMC or AMR, when required. SAR for Release 5 HSDPA and Release 6 HSPA are measured using the applicable FRC (fixed reference channel) and E-DCH reference channel configurations. Maximum output power is verified according to applicable versions of 3GPP TS 34.121 and SAR must be measured according to these maximum output conditions. When Maximum Power Reduction (MPR) is not implemented according to Cubic Metric (CM) requirements for Release 6 HSPA, the following procedures do not apply.

For Release 5 HSDPA Data Devices:

Sub-test	β_c	β_d	β_d (SF)	β_c / β_d	β_{hs}	CM/dB
1	2/15	15/15	64	2/15	4/15	0.0
2	12/15	15/15	64	12/15	24/25	1.0
3	15/15	8/15	64	15/8	30/15	1.5
4	15/15	4/15	64	15/4	30/15	1.5

For Release 6 HSPA Data Devices

Sub-test	β_c	β_d	β_d (SF)	β_c / β_d	β_{hs}	β_{ec}	β_{ed}	β_{ed} (SF)	β_{ed} (codes)	CM (dB)	MPR (dB)	AG Index	E-TFCI
1	11/15	15/15	64	11/15	22/15	209/225	1039/225	4	1	1.5	1.5	20	75
2	6/15	15/15	64	6/15	12/15	12/15	12/15	4	1	1.5	1.5	12	67
3	15/15	9/15	64	15/9	30/15	30/15	$\beta_{ed1}:47/15$ $\beta_{ed2}:47/15$	4	2	1.5	1.5	15	92
4	2/15	15/15	64	2/15	4/15	4/15	56/75	4	1	1.5	1.5	17	71
5	15/15	15/15	64	15/15	24/15	30/15	134/15	4	1	1.5	1.5	21	81

Rel.8 DC-HSDPA (Cat 24)

SAR test exclusion for Rel.8 DC-HSDPA must satisfy the SAR test exclusion requirements of Rel.5 HSDPA. SAR test exclusion for DC-HSDPA devices is determined by power measurements according to the H-Set 12, Fixed Reference Channel (FRC) configuration in Table C.8.1.12 of 3GPP TS 34.121-1. A primary and a secondary serving HS-DSCH Cell are required to perform the power measurement and for the results to qualify for SAR test exclusion.

9.4 SAR Measurement for LTE

SAR tests for LTE are performed with a base station simulator, Rohde & Schwarz CMW500. Closed loop power control was used so the UE transmits with maximum output power during SAR testing. All powers were measured with the CMW 500.

It is performed for conducted power and SAR based on the KDB941225 D05.

SAR is evaluated separately according to the following procedures for the different test positions in each exposure condition – head, body, body-worn accessories and other use conditions. The procedures in the following subsections are applied separately to test each LTE frequency band.

1) QPSK with 1 RB allocation

Start with the largest channel bandwidth and measure SAR for QPSK with 1 RB allocation, using the RB offset and required test channel combination with the highest maximum output power among RB offsets at the upper edge, middle and lower edge of each required test channel. When the reported SAR is ≤ 0.8 W/kg, testing of the remaining RB offset configurations and required test channels is not required for 1 RB allocation; otherwise, SAR is required for the remaining required test channels and only for the RB offset configuration with the highest output power for that channel. When the reported SAR of a required test channel is > 1.45 W/kg, SAR is required for all three RB offset configurations for that required test channel.

2) QPSK with 50% RB allocation

The procedures required for 1 RB allocation in 1) are applied to measure the SAR for QPSK with 50% RB allocation.

3) QPSK with 100% RB allocation

For QPSK with 100% RB allocation, SAR is not required when the highest maximum output power for 100 % RB allocation is less than the highest maximum output power in 50% and 1 RB allocations and the highest reported SAR for 1 RB and 50% RB allocation in 1) and 2) are ≤ 0.8 W/kg. Otherwise, SAR is measured for the highest output power channel; and if the reported SAR is > 1.45 W/kg, the remaining required test channels must also be tested.

9.5 Bluetooth & Wi-Fi Measurement Procedures for SAR

Normal network operating configurations are not suitable for measuring the SAR of 802.11 transmitters in general. Unpredictable fluctuations in network traffic and antenna diversity conditions can introduce undesirable variations in SAR results. The SAR for these devices should be measured using chipset based test mode software to ensure that the results are consistent and reliable.

Chipset based test mode software is hardware dependent and generally varies among manufacturers. The device operating parameters established in a test mode for SAR measurements must be identical to those programmed in production units, including output power levels, amplifier gain settings and other RF performance tuning parameters. The test frequencies should correspond to actual channel frequencies defined for domestic use. SAR for devices with switched diversity should be measured with only one antenna transmitting at a time during each SAR measurement, according to a fixed modulation and data rate. The same data pattern should be used for all measurements.

9.6 Power Drift

To control the output power stability during the SAR test, DASY4 system calculates the power drift by measuring the E-field at the same location at the beginning and at the end of the measurement for each test position. These drift values can be found in section 14 labeled as: (Power Drift [dB]). This ensures that the power drift during one measurement is within 5%.

10 Area Scan Based 1-g SAR

10.1 Requirement of KDB

According to the KDB447498 D01 v05, when the implementation is based the specific polynomial fit algorithm as presented at the 29th Bioelectromagnetics Society meeting (2007) and the estimated 1-g SAR is ≤ 1.2 W/kg, a zoom scan measurement is not required provided it is also not needed for any other purpose; for example, if the peak SAR location required for simultaneous transmission SAR test exclusion can be determined accurately by the SAR system or manually to discriminate between distinctive peaks and scattered noisy SAR distributions from area scans.

There must not be any warning or alert messages due to various measurement concerns identified by the SAR system; for example, noise in measurements, peaks too close to scan boundary, peaks are too sharp, spatial resolution and uncertainty issues etc. The SAR system verification must also demonstrate that the area scan estimated 1-g SAR is within 3% of the zoom scan 1-g SAR (See Annex B). When all the SAR results for each exposure condition in a frequency band and wireless mode are based on estimated 1-g SAR, the 1-g SAR for the highest SAR configuration must be determined by a zoom scan.

10.2 Fast SAR Algorithms

The approach is based on the area scan measurement applying a frequency dependent attenuation parameter. This attenuation parameter was empirically determined by analyzing a large number of phones. The MOTOROLA FAST SAR was developed and validated by the MOTOROLA Research Group in Ft. Lauderdale.

In the initial study, an approximation algorithm based on Linear fit was developed. The accuracy of the algorithm has been demonstrated across a broad frequency range (136-2450 MHz) and for both 1- and 10-g averaged SAR using a sample of 264 SAR measurements from 55 wireless handsets. For the sample size studied, the root-mean-squared errors of the algorithm are 1.2% and 5.8% for 1- and 10-g averaged SAR, respectively. The paper describing the algorithm in detail is expected to be published in August 2004 within the Special Issue of Transactions on MTT.

In the second step, the same research group optimized the fitting algorithm to an Polynomial fit whereby the frequency validity was extended to cover the range 30-6000MHz. Details of this study can be found in the BEMS 2007 Proceedings.

Both algorithms are implemented in DASY software.

11 Conducted Output Power

LTEB41 / WLAN shall work in low power level if audio receiver is active (Receiver ON), so we test the head SAR of LTEB41 / WLAN with low power (Receiver ON) and test the body SAR with normal power (Receiver OFF).

LTEB4 shall work in normal power level if audio receiver is active (Receiver ON), so we test the head SAR of LTEB4 with normal power (Receiver ON) and test the body SAR with low power (Receiver OFF).

11.1 GSM Measurement result

During the process of testing, the EUT was controlled via Agilent Digital Radio Communication tester (E5515C) to ensure the maximum power transmission and proper modulation. This result contains conducted output power for the EUT. In all cases, the measured peak output power should be greater and within 5% than EMI measurement.

Table 11.1-1: The conducted power measurement results for GSM, GPRS and EGPRS

GSM 850 Speech (GMSK)	Measured Power (dBm)			Tune up	calculation	Averaged Power (dBm)		
	251	190	128			251	190	128
1 Txslot	32.39	32.67	32.56	33.50	/	/	/	/
GSM 850 GPRS (GMSK)	Measured Power (dBm)				calculation	Averaged Power (dBm)		
	251	190	128			251	190	128
1 Txslot	32.36	32.22	32.35	33.50	-9.03	23.33	23.19	23.32
2 Txslots	29.89	29.85	29.75	30.50	-6.02	23.87	23.83	23.73
3Txslots	28.69	28.65	28.56	29.50	-4.26	24.43	24.39	24.30
4 Txslots	26.70	26.70	26.64	27.50	-3.01	23.69	23.69	23.63
GSM 850 EGPRS (GMSK)	Measured Power (dBm)				calculation	Averaged Power (dBm)		
	251	190	128			251	190	128
1 Txslot	32.29	32.44	32.32	33.00	-9.03	23.26	23.41	23.29
2 Txslots	29.95	29.86	29.80	30.50	-6.02	23.93	23.84	23.78
3Txslots	28.60	28.60	28.50	29.50	-4.26	24.34	24.34	24.24
4 Txslots	26.62	26.60	26.59	27.50	-3.01	23.61	23.59	23.58
GSM 850 EGPRS (8PSK)	Measured Power (dBm)				calculation	Averaged Power (dBm)		
	251	190	128			251	190	128
1 Txslot	26.30	26.34	26.36	27.50	-9.03	17.27	17.31	17.33
2 Txslots	25.49	25.48	25.42	26.50	-6.02	19.47	19.46	19.40
3Txslots	23.70	23.68	23.61	24.50	-4.26	19.44	19.42	19.35
4 Txslots	22.13	22.25	22.36	23.00	-3.01	19.12	19.24	19.35
PCS1900 Speech (GMSK)	Measured Power (dBm)			Tune up	calculation	Averaged Power (dBm)		
	810	661	512			810	661	512
1 Txslot	29.68	29.77	29.47	30.50	/	/	/	/
PCS1900 GPRS (GMSK)	Measured Power (dBm)				calculation	Averaged Power (dBm)		
	810	661	512			810	661	512
1 Txslot	29.54	29.71	29.55	30.50	-9.03	20.51	20.68	20.52

2 Txslots	26.95	26.91	26.77	27.50	-6.02	20.93	20.89	20.75
3Txslots	25.16	25.13	24.97	25.50	-4.26	20.90	20.87	20.71
4 Txslots	23.87	23.59	23.67	24.50	-3.01	20.86	20.58	20.66
PCS1900 EGPRS (GMSK)	Measured Power (dBm)				calculation	Averaged Power (dBm)		
	810	661	512			810	661	512
1 Txslot	29.53	29.47	29.59	30.50	-9.03	20.50	20.44	20.56
2 Txslots	26.94	26.93	26.73	27.50	-6.02	20.92	20.91	20.71
3Txslots	25.16	24.94	24.89	25.50	-4.26	20.90	20.68	20.63
4 Txslots	23.85	23.59	23.36	24.50	-3.01	20.84	20.58	20.35
PCS1900 EGPRS (8PSK)	Measured Power (dBm)				calculation	Averaged Power (dBm)		
	810	661	512			810	661	512
1 Txslot	25.23	25.04	25.64	26.00	-9.03	16.20	16.01	16.61
2 Txslots	24.37	24.25	24.23	25.00	-6.02	18.35	18.23	18.21
3Txslots	22.83	22.86	22.66	23.50	-4.26	18.57	18.60	18.40
4 Txslots	21.21	21.10	21.06	22.00	-3.01	18.20	18.09	18.05

NOTES:

Division Factors

To average the power, the division factor is as follows:

1TX-slot = 1 transmit time slot out of 8 time slots=> conducted power divided by (8/1) => -9.03dB

2TX-slots = 2 transmit time slots out of 8 time slots=> conducted power divided by (8/2) => -6.02dB

3TX-slots = 3 transmit time slots out of 8 time slots=> conducted power divided by (8/3) => -4.26dB

4TX-slots = 4 transmit time slots out of 8 time slots=> conducted power divided by (8/4) => -3.01dB

According to the conducted power as above, the body measurements are performed with 3Txslot for 850MHz and 2Txslot for 1900MHz GPRS&EGPRS.

11.2 WCDMA Measurement result

Table 11.2-1: The conducted Power for WCDMA

Item	band	FDDV result			
	ARFCN	4132 (826.4MHz)	4182 (836.4MHz)	4233 (846.6MHz)	Tune up
WCDMA	\	23.59	23.43	23.44	24.00
HSUPA	1	22.01	22.07	22.15	22.50
	2	21.54	21.56	21.62	22.50
	3	21.87	22.00	21.99	22.50
	4	21.91	21.94	21.96	22.50
	5	21.87	21.95	21.99	22.50
DC-HSDPA	1	22.28	22.29	22.26	23.00
	2	22.06	22.00	21.95	23.00
	3	21.59	21.52	21.50	22.50
	4	21.52	21.62	21.61	22.50
Item	band	FDDII result			
	ARFCN	9262 (1852.4MHz)	9400 (1880MHz)	9538 (1907.6MHz)	
WCDMA	\	23.16	23.27	23.19	24.00
HSUPA	1	22.49	22.21	22.29	23.00
	2	21.85	21.67	21.71	22.00
	3	22.38	22.27	22.32	23.00
	4	22.36	22.19	22.13	23.00
	5	22.42	22.24	22.29	23.00
DC-HSDPA	1	22.32	22.32	22.39	23.00
	2	22.37	22.22	22.32	23.00
	3	21.77	21.67	21.78	23.00
	4	21.9	21.71	21.80	23.00

Table 11.2-3: The conducted Power for CDMA

CDMA BC0	Conducted Power (dBm)			tuneup
	777 (848.31MHz)	384 (836.52MHz)	1013 (824.7MHz)	
SO55/RC3	23.97	24.09	24.06	25.00
SO55/RC1	23.93	24.04	24.05	25.00
SO32/RC3(FCH only)	23.69	23.98	23.93	25.00
SO32/RC3(FCH+SCH _n)	23.91	24.02	24.01	25.00
EVDO Rev.0	24.85	24.77	24.6	25.00
EVDO Rev.A	24.8	24.83	24.75	25.00
CDMA BC1	Conducted Power (dBm)			
	1175 (1908.75MHz)	600 (1880MHz)	25 (1851.25MHz)	
SO55/RC3	23.74	23.68	23.62	25.00
SO55/RC1	23.66	23.69	23.60	25.00
SO32/RC3(FCH only)	23.70	23.66	23.57	25.00
SO32/RC3(FCH+SCH _n)	23.64	23.60	23.49	25.00
EVDO Rev.0	23.89	23.99	23.83	25.00
EVDO Rev.A	24.11	24.08	24.11	25.00
CDMA BC10	Conducted Power (dBm)			
	684 (823.1MHz)	580 (820.5MHz)	476(817.9MHz)	
SO55/RC3	24.12	23.99	24.02	25.00
SO55/RC1	24.06	23.96	24.01	25.00
SO32/RC3(FCH only)	24.01	23.91	23.93	25.00
SO32/RC3(FCH+SCH _n)	24.03	23.93	23.96	25.00
EVDO Rev.0	24.06	24.1	24.18	25.00
EVDO Rev.A	24.43	24.33	24.17	25.00

11.3 LTE Measurement result

Table 11.3-1: Tune up for LTE Normal power

Band	Tune up (dBm)	
	Normal power	Low power
Band 4	24	23
Band 13	24	/
Band 25	24	/
Band 26	24	/
Band 41 PC3	24	/
Band 41 PC2	27	25

Table 11.3-2: Maximum Power Reduction (MPR) for LTE Normal power

Modulation	Channel bandwidth / Transmission bandwidth configuration [RB]						MPR (dB)
	1.4 MHz	3 MHz	5 MHz	10 MHz	15 MHz	20 MHz	
QPSK	> 5	> 4	> 8	> 12	> 16	> 18	1
16 QAM	≤ 5	≤ 4	≤ 8	≤ 12	≤ 16	≤ 18	1
16 QAM	> 5	> 4	> 8	> 12	> 16	> 18	2

Normal power

LTEBAND4

BANDWIDTH	Number of RBs	Frequency	QPSK	16QAM
Bandwidth (MHz)	RB allocation	Frequency (MHz)	Actual output power (dBm)	
	RB offset		QPSK	16QAM
1.4MHz	1RB-High (5)	1754.3 (20393)	23.11	22.35
		1732.5 (20175)	23.20	22.44
		1710.7 (19957)	23.15	22.41
	1RB-Middle (3)	1754.3 (20393)	23.15	22.06
		1732.5 (20175)	23.32	22.13
		1710.7 (19957)	23.43	22.21
	1RB-Low (0)	1754.3 (20393)	23.11	22.06
		1732.5 (20175)	23.19	22.02
		1710.7 (19957)	23.27	22.01
	3RB-High (3)	1754.3 (20393)	23.25	22.08
		1732.5 (20175)	23.05	22.21
		1710.7 (19957)	23.05	22.01
	3RB-Middle (1)	1754.3 (20393)	23.27	22.14
		1732.5 (20175)	23.23	22.18
		1710.7 (19957)	23.17	22.17
	3RB-Low (0)	1754.3 (20393)	22.93	22.06
		1732.5 (20175)	23.03	22.09
		1710.7 (19957)	23.07	22.22
	6RB (0)	1754.3 (20393)	22.02	21.04
		1732.5 (20175)	22.28	21.36
		1710.7 (19957)	22.22	21.22

3MHz	1RB-High (14)	1753.5 (20385)	23.07	22.13
		1732.5 (20175)	23.25	22.03
		1711.5 (19965)	23.38	22.08
	1RB-Middle (7)	1753.5 (20385)	23.12	22.37
		1732.5 (20175)	23.23	22.32
		1711.5 (19965)	23.42	22.51
	1RB-Low (0)	1753.5 (20385)	23.22	22.32
		1732.5 (20175)	23.30	22.27
		1711.5 (19965)	23.34	22.04
	8RB-High (7)	1753.5 (20385)	22.03	21.07
		1732.5 (20175)	22.19	21.37
		1711.5 (19965)	22.24	21.21
	8RB-Middle (4)	1753.5 (20385)	22.12	21.02
		1732.5 (20175)	22.19	21.19
		1711.5 (19965)	22.14	21.22
	8RB-Low (0)	1753.5 (20385)	22.07	21.07
		1732.5 (20175)	22.09	21.19
		1711.5 (19965)	22.17	21.24
15RB (0)	1753.5 (20385)	22.02	20.95	
	1732.5 (20175)	22.18	21.11	
	1711.5 (19965)	22.15	21.18	
5MHz	1RB-High (24)	1752.5 (20375)	23.15	22.02
		1732.5 (20175)	23.13	22.01
		1712.5 (19975)	23.03	22.06
	1RB-Middle (12)	1752.5 (20375)	23.21	22.00
		1732.5 (20175)	23.41	22.09
		1712.5 (19975)	23.06	22.07
	1RB-Low (0)	1752.5 (20375)	23.08	21.98
		1732.5 (20175)	23.45	21.95
		1712.5 (19975)	23.10	22.04
	12RB-High (13)	1752.5 (20375)	22.13	21.09
		1732.5 (20175)	22.16	21.16
		1712.5 (19975)	22.25	21.05
	12RB-Middle (6)	1752.5 (20375)	22.27	21.05
		1732.5 (20175)	22.20	21.28
		1712.5 (19975)	22.15	21.05
	12RB-Low (0)	1752.5 (20375)	22.19	21.08
		1732.5 (20175)	22.21	21.21
		1712.5 (19975)	22.23	21.09
25RB (0)	1752.5 (20375)	22.11	21.13	
	1732.5 (20175)	22.10	21.22	
	1712.5 (19975)	22.13	21.20	

10MHz	1RB-High (49)	1750 (20350)	23.14	22.24	
		1732.5 (20175)	23.28	22.26	
		1715 (20000)	23.29	22.60	
	1RB-Middle (24)	1750 (20350)	23.23	22.49	
		1732.5 (20175)	23.33	22.55	
		1715 (20000)	23.53	22.41	
	1RB-Low (0)	1750 (20350)	23.11	21.92	
		1732.5 (20175)	23.20	21.81	
		1715 (20000)	23.30	21.80	
	25RB-High (25)	1750 (20350)	22.26	21.31	
		1732.5 (20175)	22.07	21.06	
		1715 (20000)	22.28	21.27	
	25RB-Middle (12)	1750 (20350)	22.17	21.47	
		1732.5 (20175)	22.16	21.25	
		1715 (20000)	22.31	21.33	
	25RB-Low (0)	1750 (20350)	22.14	21.27	
		1732.5 (20175)	22.14	21.22	
		1715 (20000)	22.17	21.18	
	50RB (0)	1750 (20350)	22.09	21.16	
		1732.5 (20175)	22.02	21.06	
		1715 (20000)	22.27	21.16	
	15MHz	1RB-High (74)	1747.5 (20325)	23.10	22.51
			1732.5 (20175)	23.36	22.23
			1717.5 (20025)	23.24	22.07
1RB-Middle (37)		1747.5 (20325)	23.19	22.53	
		1732.5 (20175)	23.32	22.29	
		1717.5 (20025)	23.12	22.16	
1RB-Low (0)		1747.5 (20325)	23.31	22.50	
		1732.5 (20175)	23.30	22.25	
		1717.5 (20025)	23.13	22.01	
36RB-High (38)		1747.5 (20325)	22.11	21.14	
		1732.5 (20175)	22.00	21.09	
		1717.5 (20025)	22.17	21.24	
36RB-Middle (19)		1747.5 (20325)	22.18	21.13	
		1732.5 (20175)	22.10	21.09	
		1717.5 (20025)	22.19	21.30	
36RB-Low (0)		1747.5 (20325)	22.18	21.16	
		1732.5 (20175)	22.00	21.03	
		1717.5 (20025)	22.04	21.06	
75RB (0)		1747.5 (20325)	22.22	21.12	
		1732.5 (20175)	22.07	21.09	
		1717.5 (20025)	22.06	21.23	



20MHz	1RB-High (99)	1745 (20300)	23.12	22.07
		1732.5 (20175)	23.13	22.03
		1720 (20050)	23.29	22.12
	1RB-Middle (50)	1745 (20300)	23.43	22.19
		1732.5 (20175)	23.26	22.04
		1720 (20050)	23.66	22.17
	1RB-Low (0)	1745 (20300)	23.15	22.24
		1732.5 (20175)	23.16	22.01
		1720 (20050)	23.21	22.13
	50RB-High (50)	1745 (20300)	22.22	21.19
		1732.5 (20175)	22.02	21.06
		1720 (20050)	22.24	21.33
	50RB-Middle (25)	1745 (20300)	22.33	21.21
		1732.5 (20175)	22.18	21.22
		1720 (20050)	22.32	21.43
	50RB-Low (0)	1745 (20300)	22.27	21.19
		1732.5 (20175)	22.08	21.13
		1720 (20050)	22.15	21.12
	100RB (0)	1745 (20300)	22.28	21.27
		1732.5 (20175)	22.01	21.10
		1720 (20050)	22.12	21.05

LTEBAND13

Bandwidth (MHz)	RB allocation	Frequency (MHz)	Actual output power (dBm)	
	RB offset		QPSK	16QAM
5MHz	1RB-High (24)	784.5 (23255)	22.92	21.69
		782 (23230)	23.02	21.80
		779.5 (23205)	22.91	21.96
	1RB-Middle (12)	784.5 (23255)	23.08	21.50
		782 (23230)	23.30	21.23
		779.5 (23205)	23.24	21.73
	1RB-Low (0)	784.5 (23255)	23.00	21.58
		782 (23230)	23.02	21.35
		779.5 (23205)	23.08	21.70
	12RB-High (13)	784.5 (23255)	22.01	21.01
		782 (23230)	22.09	21.10
		779.5 (23205)	22.08	21.10
	12RB-Middle (6)	784.5 (23255)	22.08	21.01
		782 (23230)	22.10	21.10
		779.5 (23205)	22.01	21.04
	12RB-Low (0)	784.5 (23255)	22.01	21.07
		782 (23230)	22.01	21.08
		779.5 (23205)	22.06	21.08
	25RB (0)	784.5 (23255)	22.10	21.09
		782 (23230)	22.00	21.24
		779.5 (23205)	22.10	21.04
10MHz	1RB-High (49)	782 (23230)	23.09	22.04
	1RB-Middle (24)	782 (23230)	23.31	22.26
	1RB-Low (0)	782 (23230)	23.01	22.04
	25RB-High (25)	782 (23230)	22.05	21.09
	25RB-Middle (12)	782 (23230)	22.02	21.02
	25RB-Low (0)	782 (23230)	22.01	21.05
	50RB (0)	782 (23230)	22.07	21.08

LTEBAND25

Bandwidth (MHz)	RB allocation	Frequency (MHz)	Actual output power (dBm)		
	RB offset		QPSK	16QAM	
1.4MHz	1RB-High (5)	1914.3 (26683)	23.14	22.57	
		1882.5 (26365)	23.23	22.15	
		1850.7 (26047)	23.06	22.26	
	1RB-Middle (3)	1914.3 (26683)	23.46	22.48	
		1882.5 (26365)	23.36	22.23	
		1850.7 (26047)	23.23	22.12	
	1RB-Low (0)	1914.3 (26683)	23.15	22.41	
		1882.5 (26365)	23.26	22.06	
		1850.7 (26047)	23.00	22.27	
	3RB-High (3)	1914.3 (26683)	23.13	22.01	
		1882.5 (26365)	22.86	22.24	
		1850.7 (26047)	22.95	22.05	
	3RB-Middle (1)	1914.3 (26683)	23.21	22.10	
		1882.5 (26365)	23.07	22.31	
		1850.7 (26047)	23.12	22.16	
	3RB-Low (0)	1914.3 (26683)	23.16	22.08	
		1882.5 (26365)	23.02	22.35	
		1850.7 (26047)	23.03	22.19	
	6RB (0)	1914.3 (26683)	22.23	21.05	
		1882.5 (26365)	22.07	21.36	
		1850.7 (26047)	22.14	21.38	
	3MHz	1RB-High (14)	1913.5 (26675)	23.40	22.28
			1882.5 (26365)	23.26	22.07
			1851.5 (26055)	23.04	22.37
1RB-Middle (7)		1913.5 (26675)	23.14	22.42	
		1882.5 (26365)	23.46	22.11	
		1851.5 (26055)	23.06	22.01	
1RB-Low (0)		1913.5 (26675)	23.34	22.49	
		1882.5 (26365)	23.25	22.41	
		1851.5 (26055)	23.17	22.04	
8RB-High (7)		1913.5 (26675)	22.38	21.07	
		1882.5 (26365)	22.14	21.36	
		1851.5 (26055)	22.14	21.05	
8RB-Middle (4)		1913.5 (26675)	22.52	21.43	
		1882.5 (26365)	22.23	21.07	
		1851.5 (26055)	22.21	21.02	
8RB-Low (0)		1913.5 (26675)	22.40	21.35	
		1882.5 (26365)	22.20	21.22	
		1851.5 (26055)	22.21	21.26	
15RB (0)		1913.5 (26675)	22.37	21.27	
		1882.5 (26365)	22.14	21.10	
		1851.5 (26055)	22.11	21.23	

5MHz	1RB-High (24)	1912.5 (26665)	23.45	21.83	
		1882.5 (26365)	23.19	21.57	
		1852.5 (26065)	23.09	21.84	
	1RB-Middle (12)	1912.5 (26665)	23.50	21.97	
		1882.5 (26365)	23.30	21.64	
		1852.5 (26065)	23.05	21.79	
	1RB-Low (0)	1912.5 (26665)	23.58	21.80	
		1882.5 (26365)	23.17	21.69	
		1852.5 (26065)	23.09	21.75	
	12RB-High (13)	1912.5 (26665)	22.46	21.54	
		1882.5 (26365)	22.16	21.06	
		1852.5 (26065)	22.20	21.05	
	12RB-Middle (6)	1912.5 (26665)	22.36	21.55	
		1882.5 (26365)	22.29	21.09	
		1852.5 (26065)	22.25	21.28	
	12RB-Low (0)	1912.5 (26665)	22.32	21.52	
		1882.5 (26365)	22.24	21.27	
		1852.5 (26065)	22.23	21.32	
	25RB (0)	1912.5 (26665)	22.41	21.44	
		1882.5 (26365)	22.29	21.22	
		1852.5 (26065)	22.11	21.04	
	10MHz	1RB-High (49)	1910 (26640)	23.34	22.45
			1882.5 (26365)	23.46	22.55
			1855 (26090)	23.25	22.15
1RB-Middle (24)		1910 (26640)	23.40	22.55	
		1882.5 (26365)	23.57	22.50	
		1855 (26090)	23.47	22.17	
1RB-Low (0)		1910 (26640)	23.36	22.58	
		1882.5 (26365)	23.31	22.38	
		1855 (26090)	23.18	22.71	
25RB-High (25)		1910 (26640)	22.35	21.49	
		1882.5 (26365)	22.16	21.20	
		1855 (26090)	22.31	21.45	
25RB-Middle (12)		1910 (26640)	22.39	21.54	
		1882.5 (26365)	22.22	21.28	
		1855 (26090)	22.18	21.24	
25RB-Low (0)		1910 (26640)	22.32	21.68	
		1882.5 (26365)	22.18	21.25	
		1855 (26090)	22.21	21.28	
50RB (0)		1910 (26640)	22.45	21.33	
		1882.5 (26365)	22.26	21.11	
		1855 (26090)	22.22	21.33	

15MHz	1RB-High (74)	1907.5 (26615)	23.54	22.36	
		1882.5 (26365)	23.17	22.54	
		1857.5 (26115)	23.11	22.29	
	1RB-Middle (37)	1907.5 (26615)	23.59	22.81	
		1882.5 (26365)	23.19	22.36	
		1857.5 (26115)	23.61	22.75	
	1RB-Low (0)	1907.5 (26615)	23.38	22.68	
		1882.5 (26365)	23.09	22.33	
		1857.5 (26115)	23.54	22.24	
	36RB-High (38)	1907.5 (26615)	22.38	21.20	
		1882.5 (26365)	22.19	21.18	
		1857.5 (26115)	22.17	21.18	
	36RB-Middle (19)	1907.5 (26615)	22.46	21.47	
		1882.5 (26365)	22.35	21.24	
		1857.5 (26115)	22.32	21.20	
	36RB-Low (0)	1907.5 (26615)	22.45	21.33	
		1882.5 (26365)	22.23	21.28	
		1857.5 (26115)	22.22	21.04	
	75RB (0)	1907.5 (26615)	22.33	21.40	
		1882.5 (26365)	22.16	21.35	
		1857.5 (26115)	22.34	21.17	
	20MHz	1RB-High (99)	1905 (26590)	23.06	22.07
			1882.5 (26365)	23.51	22.01
			1860 (26140)	23.03	22.07
		1RB-Middle (50)	1905 (26590)	23.48	22.06
			1882.5 (26365)	23.51	22.31
			1860 (26140)	23.24	22.43
1RB-Low (0)		1905 (26590)	23.06	22.07	
		1882.5 (26365)	23.32	22.12	
		1860 (26140)	23.03	22.11	
50RB-High (50)		1905 (26590)	22.36	21.55	
		1882.5 (26365)	22.17	21.19	
		1860 (26140)	22.21	21.17	
50RB-Middle (25)		1905 (26590)	22.45	21.50	
		1882.5 (26365)	22.35	21.38	
		1860 (26140)	22.22	21.21	
50RB-Low (0)		1905 (26590)	22.43	21.52	
		1882.5 (26365)	22.21	21.32	
		1860 (26140)	22.22	21.08	
100RB (0)		1905 (26590)	22.35	21.43	
		1882.5 (26365)	22.20	21.30	
		1860 (26140)	22.14	21.12	

LTEBAND26

Bandwidth (MHz)	RB allocation	Frequency (MHz)	Actual output power (dBm)	
	RB offset		QPSK	16QAM
1.4MHz	1RB-High (5)	848.3 (27033)	23.16	22.19
		831.5 (26865)	23.06	22.08
		814.7 (26697)	23.05	22.04
	1RB-Middle (3)	848.3 (27033)	23.20	22.11
		831.5 (26865)	23.13	22.02
		814.7 (26697)	23.12	22.05
	1RB-Low (0)	848.3 (27033)	23.07	22.07
		831.5 (26865)	23.03	22.06
		814.7 (26697)	23.04	22.09
	3RB-High (3)	848.3 (27033)	22.89	22.26
		831.5 (26865)	22.97	22.08
		814.7 (26697)	22.95	22.02
	3RB-Middle (1)	848.3 (27033)	22.94	22.37
		831.5 (26865)	22.90	22.01
		814.7 (26697)	22.93	22.06
	3RB-Low (0)	848.3 (27033)	22.83	22.22
		831.5 (26865)	22.79	22.05
		814.7 (26697)	22.90	22.06
	6RB (0)	848.3 (27033)	22.01	21.13
		831.5 (26865)	22.10	21.24
		814.7 (26697)	22.06	21.05
3MHz	1RB-High (14)	847.5 (27025)	23.08	22.05
		831.5 (26865)	23.12	22.10
		815.5 (26705)	22.90	22.04
	1RB-Middle (7)	847.5 (27025)	23.23	22.11
		831.5 (26865)	23.18	22.06
		815.5 (26705)	23.02	22.15
	1RB-Low (0)	847.5 (27025)	23.01	22.20
		831.5 (26865)	22.97	22.02
		815.5 (26705)	23.23	21.99
	8RB-High (7)	847.5 (27025)	22.04	20.96
		831.5 (26865)	22.03	21.16
		815.5 (26705)	21.97	20.92
	8RB-Middle (4)	847.5 (27025)	22.07	20.89
		831.5 (26865)	21.95	21.21
		815.5 (26705)	21.96	21.06
	8RB-Low (0)	847.5 (27025)	22.16	20.98
		831.5 (26865)	22.00	21.11
		815.5 (26705)	22.03	21.00
	15RB (0)	847.5 (27025)	22.07	20.84
		831.5 (26865)	22.01	20.92
		815.5 (26705)	22.04	21.03

5MHz	1RB-High (24)	846.5 (27015)	22.98	21.65	
		831.5 (26865)	22.92	21.80	
		816.5 (26715)	22.89	21.83	
	1RB-Middle (12)	846.5 (27015)	23.28	21.83	
		831.5 (26865)	23.18	21.42	
		816.5 (26715)	23.25	21.55	
	1RB-Low (0)	846.5 (27015)	23.08	21.77	
		831.5 (26865)	22.95	21.41	
		816.5 (26715)	22.97	21.52	
	12RB-High (13)	846.5 (27015)	22.03	21.17	
		831.5 (26865)	22.00	21.07	
		816.5 (26715)	22.04	21.05	
	12RB-Middle (6)	846.5 (27015)	22.14	21.27	
		831.5 (26865)	22.00	20.91	
		816.5 (26715)	21.97	20.95	
	12RB-Low (0)	846.5 (27015)	22.13	21.19	
		831.5 (26865)	21.95	20.94	
		816.5 (26715)	21.97	20.86	
	25RB (0)	846.5 (27015)	22.10	21.19	
		831.5 (26865)	22.08	21.24	
		816.5 (26715)	22.06	20.98	
	10MHz	1RB-High (49)	844 (26990)	22.99	22.11
			831.5 (26865)	23.00	22.18
			820 (26750)	23.03	21.90
1RB-Middle (24)		844 (26990)	23.34	22.29	
		831.5 (26865)	22.92	22.51	
		820 (26750)	22.97	22.43	
1RB-Low (0)		844 (26990)	23.15	22.06	
		831.5 (26865)	22.97	22.01	
		820 (26750)	23.03	22.35	
25RB-High (25)		844 (26990)	22.07	21.06	
		831.5 (26865)	22.21	20.97	
		820 (26750)	22.15	21.16	
25RB-Middle (12)		844 (26990)	22.20	21.24	
		831.5 (26865)	22.05	21.03	
		820 (26750)	22.12	21.29	
25RB-Low (0)		844 (26990)	22.16	21.24	
		831.5 (26865)	21.96	21.03	
		820 (26750)	22.00	21.14	
50RB (0)		844 (26990)	22.15	21.10	
		831.5 (26865)	22.15	21.09	
		820 (26750)	22.10	21.12	



15MHz	1RB-High (74)	841.5 (26965)	23.01	22.14
		831.5 (26865)	23.06	22.51
		822.5 (26775)	23.19	22.15
	1RB-Middle (37)	841.5 (26965)	23.28	22.11
		831.5 (26865)	23.08	22.59
		822.5 (26775)	23.15	22.30
	1RB-Low (0)	841.5 (26965)	23.09	22.42
		831.5 (26865)	23.01	22.58
		822.5 (26775)	23.00	22.15
	36RB-High (38)	841.5 (26965)	22.11	21.10
		831.5 (26865)	22.16	21.20
		822.5 (26775)	22.06	21.10
	36RB-Middle (19)	841.5 (26965)	22.21	21.22
		831.5 (26865)	22.16	21.04
		822.5 (26775)	22.07	21.23
	36RB-Low (0)	841.5 (26965)	22.18	21.15
		831.5 (26865)	22.01	21.11
		822.5 (26775)	22.07	21.02
	75RB (0)	841.5 (26965)	22.18	21.11
		831.5 (26865)	22.12	21.06
		822.5 (26775)	22.06	21.03



LTEBAND41(PC3)

5MHz	1RB-High (24)	2687.5 (41565)	23.42	21.50
		2640.3(41093)	23.03	21.58
		2593 (40620)	23.01	21.14
		2545.8(40148)	23.45	21.16
		2498.5 (39675)	23.23	21.52
	1RB-Middle (12)	2687.5 (41565)	23.70	21.50
		2640.3(41093)	23.54	21.86
		2593 (40620)	23.43	21.55
		2545.8(40148)	23.55	21.54
		2498.5 (39675)	23.80	22.09
	1RB-Low (0)	2687.5 (41565)	23.66	21.07
		2640.3(41093)	23.27	21.79
		2593 (40620)	23.31	21.21
		2545.8(40148)	23.37	21.13
		2498.5 (39675)	23.40	21.84
	12RB-High (13)	2687.5 (41565)	22.67	21.59
		2640.3(41093)	22.40	21.46
		2593 (40620)	22.41	21.27
		2545.8(40148)	22.44	21.23
		2498.5 (39675)	22.38	21.72
	12RB-Middle (6)	2687.5 (41565)	22.47	21.41
		2640.3(41093)	22.57	21.47
		2593 (40620)	22.34	21.31
		2545.8(40148)	22.47	21.33
		2498.5 (39675)	22.51	21.65
	12RB-Low (0)	2687.5 (41565)	22.42	21.49
		2640.3(41093)	22.37	21.46
		2593 (40620)	22.27	21.28
2545.8(40148)		22.42	21.29	
2498.5 (39675)		22.28	21.59	
25RB (0)	2687.5 (41565)	22.37	21.50	
	2640.3(41093)	22.33	21.52	
	2593 (40620)	22.25	21.36	
	2545.8(40148)	22.62	21.44	
	2498.5 (39675)	22.33	21.47	
10MHz	1RB-High (49)	2685 (41540)	23.59	22.01
		2639(41080)	23.24	22.77
		2593 (40620)	23.05	22.03
		2547(40160)	23.50	22.03
		2501 (39700)	23.38	23.06
	1RB-Middle (24)	2685 (41540)	23.56	22.32
		2639(41080)	23.63	22.78
		2593 (40620)	23.56	22.17
		2547(40160)	23.73	22.27
		2501 (39700)	23.76	23.01
	1RB-Low (0)	2685 (41540)	23.36	22.12
		2639(41080)	23.31	22.82
		2593 (40620)	23.18	22.17
		2547(40160)	23.32	22.10
		2501 (39700)	23.35	22.90
	25RB-High (25)	2685 (41540)	22.86	21.48
		2639(41080)	22.60	21.56
		2593 (40620)	22.50	21.59
		2547(40160)	22.67	21.38
		2501 (39700)	22.45	21.67
	25RB-Middle (12)	2685 (41540)	22.76	21.48
		2639(41080)	22.77	21.60
		2593 (40620)	22.70	21.58
		2547(40160)	22.77	21.45
		2501 (39700)	22.62	21.44
	25RB-Low (0)	2685 (41540)	22.44	21.44
		2639(41080)	22.45	21.43
		2593 (40620)	22.49	21.43
2547(40160)		22.47	21.44	
2501 (39700)		22.36	21.41	
50RB (0)	2685 (41540)	22.49	21.45	
	2639(41080)	22.69	21.61	
	2593 (40620)	22.36	21.46	
	2547(40160)	22.51	21.45	
	2501 (39700)	22.38	21.52	



15MHz	1RB-High (74)	2682.5 (41515)	23.50	21.71
		2637.8(41068)	23.18	21.80
		2593 (40620)	23.01	21.79
		2548.3(40173)	23.33	21.70
		2503.5 (39725)	23.49	21.92
	1RB-Middle (37)	2682.5 (41515)	23.75	22.60
		2637.8(41068)	23.62	22.26
		2593 (40620)	23.38	22.15
		2548.3(40173)	23.81	22.25
		2503.5 (39725)	23.46	22.30
	1RB-Low (0)	2682.5 (41515)	23.54	21.19
		2637.8(41068)	23.16	21.93
		2593 (40620)	23.15	21.76
		2548.3(40173)	23.45	21.00
		2503.5 (39725)	23.23	21.76
	36RB-High (38)	2682.5 (41515)	22.75	21.52
		2637.8(41068)	22.46	21.27
		2593 (40620)	22.33	21.63
		2548.3(40173)	22.61	21.57
		2503.5 (39725)	22.44	21.44
	36RB-Middle (19)	2682.5 (41515)	22.74	21.61
		2637.8(41068)	22.39	21.40
		2593 (40620)	22.63	21.64
		2548.3(40173)	22.63	21.55
		2503.5 (39725)	22.35	21.47
	36RB-Low (0)	2682.5 (41515)	22.33	21.54
		2637.8(41068)	22.21	21.32
		2593 (40620)	22.42	21.52
2548.3(40173)		22.44	21.36	
2503.5 (39725)		22.16	21.29	
75RB (0)	2682.5 (41515)	22.37	21.57	
	2637.8(41068)	22.24	21.43	
	2593 (40620)	22.28	21.49	
	2548.3(40173)	22.40	21.62	
	2503.5 (39725)	22.25	21.31	
20MHz	1RB-High (99)	2680 (41490)	23.39	21.62
		2636.5(41055)	23.51	21.09
		2593 (40620)	23.30	21.26
		2549.5(40185)	23.04	21.04
		2506 (39750)	23.48	21.06
	1RB-Middle (50)	2680 (41490)	23.94	21.75
		2636.5(41055)	23.96	21.03
		2593 (40620)	23.53	21.77
		2549.5(40185)	23.97	21.74
		2506 (39750)	23.75	21.15
	1RB-Low (0)	2680 (41490)	23.19	21.70
		2636.5(41055)	23.55	21.15
		2593 (40620)	23.11	21.60
		2549.5(40185)	23.28	21.13
		2506 (39750)	23.27	21.17
	50RB-High (50)	2680 (41490)	22.76	21.87
		2636.5(41055)	22.64	21.60
		2593 (40620)	22.69	21.57
		2549.5(40185)	22.46	21.53
		2506 (39750)	22.43	21.39
	50RB-Middle (25)	2680 (41490)	22.62	21.72
		2636.5(41055)	22.66	21.78
		2593 (40620)	22.64	21.61
		2549.5(40185)	22.66	21.65
		2506 (39750)	22.26	21.30
	50RB-Low (0)	2680 (41490)	22.44	21.59
		2636.5(41055)	22.30	21.34
		2593 (40620)	22.42	21.38
		2549.5(40185)	22.65	21.49
		2506 (39750)	22.27	21.18
	100RB (0)	2680 (41490)	22.32	21.63
		2636.5(41055)	22.30	21.31
2593 (40620)		22.30	21.40	
2549.5(40185)		22.71	21.43	
2506 (39750)		22.49	21.44	



LTEBAND41(PC2)

Bandwidth (MHz)	RB allocation RB offset	Frequency (MHz)	Actual output power (dBm)		
			QPSK	16QAM	
5MHz	1RB-High (24)	2687.5 (41565)	26.23	24.37	
		2640.3(41093)	26.02	24.14	
		2593 (40620)	26.05	24.13	
		2545.8(40148)	26.33	24.16	
	1RB-Middle (12)	2498.5 (39675)	26.16	24.39	
		2687.5 (41565)	26.48	24.58	
		2640.3(41093)	26.47	24.23	
		2593 (40620)	26.23	23.88	
	1RB-Low (0)	2545.8(40148)	26.36	24.43	
		2498.5 (39675)	26.49	24.36	
		2687.5 (41565)	26.42	24.37	
		2640.3(41093)	26.05	24.15	
	12RB-High (13)	2593 (40620)	26.05	23.72	
		2545.8(40148)	26.05	24.15	
		2498.5 (39675)	26.11	24.19	
		2687.5 (41565)	25.10	24.38	
	12RB-Middle (6)	2640.3(41093)	24.95	24.09	
		2593 (40620)	25.02	24.27	
		2545.8(40148)	25.16	23.92	
		2498.5 (39675)	25.19	24.30	
	12RB-Low (0)	2687.5 (41565)	25.22	24.36	
		2640.3(41093)	25.03	24.28	
		2593 (40620)	25.14	24.27	
		2545.8(40148)	25.19	24.14	
	25RB (0)	2498.5 (39675)	25.29	24.39	
		2687.5 (41565)	25.14	24.42	
		2640.3(41093)	25.05	24.27	
		2593 (40620)	25.09	24.21	
	10MHz	1RB-High (49)	2545.8(40148)	25.11	24.19
			2498.5 (39675)	25.21	24.28
			2687.5 (41565)	25.22	24.22
			2640.3(41093)	24.95	24.10
		1RB-Middle (24)	2593 (40620)	25.06	24.14
			2545.8(40148)	25.21	24.01
			2498.5 (39675)	25.17	24.20
			2685 (41540)	26.29	23.74
1RB-Low (0)		2639(41080)	25.90	25.14	
		2593 (40620)	25.95	24.14	
		2547(40160)	26.22	23.76	
		2501 (39700)	25.98	24.93	
25RB-High (25)		2685 (41540)	26.30	23.80	
		2639(41080)	25.88	25.36	
		2593 (40620)	26.17	24.91	
		2547(40160)	26.25	23.77	
25RB-Middle (12)		2501 (39700)	26.06	25.48	
		2685 (41540)	26.15	23.70	
		2639(41080)	25.87	25.16	
		2593 (40620)	25.97	24.93	
25RB-Low (0)		2547(40160)	26.04	23.67	
		2501 (39700)	26.01	25.26	
		2685 (41540)	25.43	24.17	
		2639(41080)	24.95	24.10	
50RB (0)		2593 (40620)	25.07	24.24	
		2547(40160)	25.18	23.99	
		2501 (39700)	25.21	24.27	
		2685 (41540)	25.17	24.23	
50RB (0)		2639(41080)	25.11	24.17	
		2593 (40620)	25.07	24.32	
		2547(40160)	25.30	24.11	
		2501 (39700)	25.35	24.21	
50RB (0)		2685 (41540)	25.07	24.03	
		2639(41080)	25.03	24.00	
		2593 (40620)	25.07	24.26	
		2547(40160)	25.19	23.96	
50RB (0)	2501 (39700)	25.19	24.23		
	2685 (41540)	25.43	24.21		
	2639(41080)	25.05	24.12		
	2593 (40620)	25.05	23.92		
50RB (0)	2547(40160)	25.13	24.13		
	2501 (39700)	25.31	24.28		
	2685 (41540)	25.43	24.21		
	2639(41080)	25.05	24.12		



15MHz	1RB-High (74)	2682.5 (41515)	26.06	23.82
		2637.8(41068)	25.77	24.76
		2593 (40620)	25.85	24.63
		2548.3(40173)	26.06	23.55
		2503.5 (39725)	26.25	24.56
	1RB-Middle (37)	2682.5 (41515)	26.13	23.80
		2637.8(41068)	25.90	24.45
		2593 (40620)	25.85	24.88
		2548.3(40173)	26.26	23.86
		2503.5 (39725)	25.90	24.48
	1RB-Low (0)	2682.5 (41515)	26.14	23.71
		2637.8(41068)	25.80	24.15
		2593 (40620)	25.84	24.95
		2548.3(40173)	26.25	23.76
		2503.5 (39725)	25.87	24.64
	36RB-High (38)	2682.5 (41515)	25.40	24.13
		2637.8(41068)	24.94	23.96
		2593 (40620)	25.08	24.02
		2548.3(40173)	25.26	24.27
		2503.5 (39725)	25.07	23.97
	36RB-Middle (19)	2682.5 (41515)	25.13	24.28
		2637.8(41068)	25.03	23.98
		2593 (40620)	25.00	24.20
		2548.3(40173)	25.24	24.12
		2503.5 (39725)	25.11	24.04
	36RB-Low (0)	2682.5 (41515)	25.01	24.15
		2637.8(41068)	24.94	23.85
		2593 (40620)	25.03	23.99
		2548.3(40173)	25.18	24.14
		2503.5 (39725)	25.12	24.09
	75RB (0)	2682.5 (41515)	24.98	24.14
		2637.8(41068)	25.02	24.00
		2593 (40620)	24.97	24.15
		2548.3(40173)	25.13	24.18
		2503.5 (39725)	25.03	24.16
	20MHz	1RB-High (99)	2680 (41490)	25.90
2636.5(41055)			26.30	24.18
2593 (40620)			25.96	23.33
2549.5(40185)			25.97	24.43
2506 (39750)			26.23	24.16
1RB-Middle (50)		2680 (41490)	26.41	24.68
		2636.5(41055)	26.44	24.48
		2593 (40620)	26.33	23.83
		2549.5(40185)	26.49	24.91
		2506 (39750)	26.27	24.14
1RB-Low (0)		2680 (41490)	26.00	24.55
		2636.5(41055)	26.15	24.20
		2593 (40620)	26.05	23.53
		2549.5(40185)	26.19	24.90
		2506 (39750)	26.22	23.80
50RB-High (50)		2680 (41490)	25.36	24.46
		2636.5(41055)	24.95	24.04
		2593 (40620)	25.13	24.04
		2549.5(40185)	25.35	24.12
		2506 (39750)	25.12	24.34
50RB-Middle (25)		2680 (41490)	25.11	24.13
		2636.5(41055)	25.05	24.12
		2593 (40620)	25.05	24.09
		2549.5(40185)	25.25	24.20
		2506 (39750)	25.07	24.03
50RB-Low (0)		2680 (41490)	25.35	24.50
		2636.5(41055)	24.93	24.00
		2593 (40620)	25.02	24.08
		2549.5(40185)	25.19	24.10
		2506 (39750)	25.10	24.07
100RB (0)		2680 (41490)	25.42	24.42
		2636.5(41055)	25.01	24.03
		2593 (40620)	25.03	23.93
		2549.5(40185)	25.19	24.05
		2506 (39750)	25.14	24.10



**Low Power
LTEBAND4**

BANDWIDTH	Number of RBs	Frequency	QPSK	16QAM	
Bandwidth (MHz)	RB allocation	Frequency (MHz)	Actual output power (dBm)		
	RB offset		QPSK	16QAM	
1.4MHz	1RB-High (5)	1754.3 (20393)	22.23	22.32	
		1732.5 (20175)	22.35	22.14	
		1710.7 (19957)	22.29	22.51	
	1RB-Middle (3)	1754.3 (20393)	22.27	22.33	
		1732.5 (20175)	22.39	22.16	
		1710.7 (19957)	22.37	22.35	
	1RB-Low (0)	1754.3 (20393)	22.24	22.21	
		1732.5 (20175)	22.38	22.44	
		1710.7 (19957)	22.25	22.55	
	3RB-High (3)	1754.3 (20393)	22.12	22.33	
		1732.5 (20175)	22.22	22.34	
		1710.7 (19957)	22.37	22.23	
	3RB-Middle (1)	1754.3 (20393)	22.17	22.41	
		1732.5 (20175)	22.26	22.29	
		1710.7 (19957)	22.57	22.36	
	3RB-Low (0)	1754.3 (20393)	22.14	22.41	
		1732.5 (20175)	22.30	22.26	
		1710.7 (19957)	22.41	22.41	
	6RB (0)	1754.3 (20393)	22.17	21.39	
		1732.5 (20175)	22.35	21.43	
		1710.7 (19957)	22.31	21.23	
	3MHz	1RB-High (14)	1753.5 (20385)	22.13	22.30
			1732.5 (20175)	22.21	22.38
			1711.5 (19965)	22.30	22.39
1RB-Middle (7)		1753.5 (20385)	22.59	22.25	
		1732.5 (20175)	22.48	22.42	
		1711.5 (19965)	22.54	22.65	
1RB-Low (0)		1753.5 (20385)	22.40	22.36	
		1732.5 (20175)	22.42	22.45	
		1711.5 (19965)	22.53	22.70	
8RB-High (7)		1753.5 (20385)	22.11	21.31	
		1732.5 (20175)	22.33	21.33	
		1711.5 (19965)	22.30	21.28	
8RB-Middle (4)		1753.5 (20385)	22.17	21.23	
		1732.5 (20175)	22.24	21.23	
		1711.5 (19965)	22.39	21.27	
8RB-Low (0)		1753.5 (20385)	22.21	21.44	
		1732.5 (20175)	22.29	21.25	
		1711.5 (19965)	22.30	21.31	
15RB (0)		1753.5 (20385)	22.20	21.21	
		1732.5 (20175)	22.18	21.17	
		1711.5 (19965)	22.37	21.35	

5MHz	1RB-High (24)	1752.5 (20375)	22.29	22.02	
		1732.5 (20175)	22.13	22.07	
		1712.5 (19975)	22.23	22.10	
	1RB-Middle (12)	1752.5 (20375)	22.71	22.24	
		1732.5 (20175)	22.37	22.54	
		1712.5 (19975)	22.25	22.13	
	1RB-Low (0)	1752.5 (20375)	22.72	22.13	
		1732.5 (20175)	22.05	22.11	
		1712.5 (19975)	22.18	22.22	
	12RB-High (13)	1752.5 (20375)	22.36	21.31	
		1732.5 (20175)	22.11	21.10	
		1712.5 (19975)	22.29	21.16	
	12RB-Middle (6)	1752.5 (20375)	22.35	21.17	
		1732.5 (20175)	22.21	21.22	
		1712.5 (19975)	22.29	21.34	
	12RB-Low (0)	1752.5 (20375)	22.36	21.39	
		1732.5 (20175)	22.24	21.26	
		1712.5 (19975)	22.36	21.43	
	25RB (0)	1752.5 (20375)	22.30	21.48	
		1732.5 (20175)	22.17	21.22	
		1712.5 (19975)	22.30	21.29	
	10MHz	1RB-High (49)	1750 (20350)	22.42	22.23
			1732.5 (20175)	22.09	22.13
			1715 (20000)	22.29	22.71
1RB-Middle (24)		1750 (20350)	22.52	22.63	
		1732.5 (20175)	22.49	22.88	
		1715 (20000)	22.47	22.88	
1RB-Low (0)		1750 (20350)	22.25	22.05	
		1732.5 (20175)	22.20	22.35	
		1715 (20000)	22.23	22.63	
25RB-High (25)		1750 (20350)	22.30	21.45	
		1732.5 (20175)	22.12	21.25	
		1715 (20000)	22.43	21.44	
25RB-Middle (12)		1750 (20350)	22.29	21.49	
		1732.5 (20175)	22.26	21.34	
		1715 (20000)	22.34	21.55	
25RB-Low (0)		1750 (20350)	22.19	21.25	
		1732.5 (20175)	22.19	21.30	
		1715 (20000)	22.22	21.28	
50RB (0)		1750 (20350)	22.22	21.26	
		1732.5 (20175)	22.26	21.27	
		1715 (20000)	22.28	21.38	

15MHz	1RB-High (74)	1747.5 (20325)	22.13	22.89	
		1732.5 (20175)	22.46	22.45	
		1717.5 (20025)	22.27	22.75	
	1RB-Middle (37)	1747.5 (20325)	22.73	22.84	
		1732.5 (20175)	22.66	22.45	
		1717.5 (20025)	22.55	22.25	
	1RB-Low (0)	1747.5 (20325)	22.66	22.95	
		1732.5 (20175)	22.42	22.45	
		1717.5 (20025)	22.39	22.47	
	36RB-High (38)	1747.5 (20325)	22.41	21.31	
		1732.5 (20175)	22.17	21.23	
		1717.5 (20025)	22.39	21.41	
	36RB-Middle (19)	1747.5 (20325)	22.37	21.36	
		1732.5 (20175)	22.26	21.35	
		1717.5 (20025)	22.45	21.59	
	36RB-Low (0)	1747.5 (20325)	22.39	21.35	
		1732.5 (20175)	22.13	21.33	
		1717.5 (20025)	22.30	21.48	
	75RB (0)	1747.5 (20325)	22.29	21.33	
		1732.5 (20175)	22.11	21.20	
		1717.5 (20025)	22.29	21.43	
	20MHz	1RB-High (99)	1745 (20300)	22.27	22.45
			1732.5 (20175)	22.30	22.37
			1720 (20050)	22.30	22.09
		1RB-Middle (50)	1745 (20300)	22.75	22.37
			1732.5 (20175)	22.52	22.34
			1720 (20050)	22.53	22.19
1RB-Low (0)		1745 (20300)	22.66	22.30	
		1732.5 (20175)	22.29	22.40	
		1720 (20050)	22.24	21.83	
50RB-High (50)		1745 (20300)	22.39	21.52	
		1732.5 (20175)	22.22	21.11	
		1720 (20050)	22.47	21.19	
50RB-Middle (25)		1745 (20300)	22.72	21.70	
		1732.5 (20175)	22.55	21.38	
		1720 (20050)	22.52	21.56	
50RB-Low (0)		1745 (20300)	22.39	21.28	
		1732.5 (20175)	22.34	21.29	
		1720 (20050)	22.33	21.45	
100RB (0)		1745 (20300)	22.68	21.45	
		1732.5 (20175)	22.29	21.27	
		1720 (20050)	22.35	21.39	



LTEBAND41(PC2)

BANDWIDTH Bandwidth (MHz)	Number of RBs		Frequency Frequency (MHz)	Actual output power (dBm)		
	RB allocation	RB offset		QPSK	16QAM	
				QPSK	16QAM	
5MHz	1RB-High (24)		2687.5 (41565)	24.46	24.29	
			2640.3(41093)	24.09	24.08	
			2593 (40620)	24.04	24.07	
			2545.8(40148)	24.30	24.11	
			2498.5 (39675)	24.53	24.20	
	1RB-Middle (12)		2687.5 (41565)	24.81	24.36	
			2640.3(41093)	24.68	24.11	
			2593 (40620)	24.52	24.05	
			2545.8(40148)	24.57	24.35	
	1RB-Low (0)		2498.5 (39675)	24.98	24.30	
			2687.5 (41565)	24.43	24.24	
			2640.3(41093)	24.19	24.15	
			2593 (40620)	24.11	24.01	
	12RB-High (13)		2545.8(40148)	24.39	24.06	
			2498.5 (39675)	24.41	24.13	
			2687.5 (41565)	24.37	24.30	
			2640.3(41093)	24.24	24.06	
	12RB-Middle (6)		2593 (40620)	24.20	24.00	
			2545.8(40148)	24.40	24.13	
			2498.5 (39675)	24.50	24.34	
			2687.5 (41565)	24.45	24.27	
	12RB-Low (0)		2640.3(41093)	24.30	24.14	
			2593 (40620)	24.30	24.31	
			2545.8(40148)	24.37	24.19	
			2498.5 (39675)	24.44	24.40	
	25RB (0)		2687.5 (41565)	24.40	24.17	
			2640.3(41093)	24.39	24.21	
			2593 (40620)	24.23	24.24	
			2545.8(40148)	24.36	24.12	
	10MHz	1RB-High (49)		2498.5 (39675)	24.43	24.32
				2687.5 (41565)	24.34	24.18
				2640.3(41093)	24.22	24.05
				2593 (40620)	24.21	24.16
				2545.8(40148)	24.30	24.05
		1RB-Middle (24)		2498.5 (39675)	24.39	24.27
				2685 (41540)	24.47	23.83
				2639(41080)	24.09	23.51
				2593 (40620)	24.08	23.54
				2547(40160)	24.24	23.58
		1RB-Low (0)		2501 (39700)	24.30	23.45
				2685 (41540)	24.50	23.85
				2639(41080)	24.44	23.58
				2593 (40620)	24.35	23.54
				2547(40160)	24.39	23.67
		25RB-High (25)		2501 (39700)	24.40	23.38
	2685 (41540)			24.37	23.58	
	2639(41080)			24.17	23.51	
	2593 (40620)			24.18	23.45	
2547(40160)	24.25			23.45		
25RB-Middle (12)		2501 (39700)	24.31	23.22		
		2685 (41540)	24.57	24.02		
		2639(41080)	24.29	24.02		
		2593 (40620)	24.24	24.10		
		2547(40160)	24.38	24.09		
25RB-Low (0)		2501 (39700)	24.58	24.20		
		2685 (41540)	24.65	24.18		
		2639(41080)	24.31	24.17		
		2593 (40620)	24.21	24.19		
		2547(40160)	24.45	24.07		
50RB (0)		2501 (39700)	24.59	24.31		
		2685 (41540)	24.37	24.03		
		2639(41080)	24.24	24.02		
		2593 (40620)	24.23	24.18		
		2547(40160)	24.34	24.05		
		2501 (39700)	24.50	24.25		
		2685 (41540)	24.40	24.14		
		2639(41080)	24.34	24.12		
		2593 (40620)	24.18	23.94		
		2547(40160)	24.41	24.12		
			2501 (39700)	24.57	24.38	



15MHz	1RB-High (74)	2682.5 (41515)	24.32	23.83	
		2637.8(41068)	24.19	23.98	
		2593 (40620)	24.08	23.90	
		2548.3(40173)	24.18	23.66	
		2503.5 (39725)	24.18	23.91	
	1RB-Middle (37)	2682.5 (41515)	24.37	23.73	
		2637.8(41068)	24.11	23.91	
		2593 (40620)	24.12	23.96	
		2548.3(40173)	24.32	23.93	
	1RB-Low (0)	2503.5 (39725)	24.14	23.93	
		2682.5 (41515)	24.47	23.79	
		2637.8(41068)	24.12	24.08	
		2593 (40620)	24.11	24.75	
	36RB-High (38)	2548.3(40173)	24.21	23.64	
		2503.5 (39725)	24.08	24.14	
		2682.5 (41515)	24.48	23.91	
		2637.8(41068)	24.41	23.93	
	36RB-Middle (19)	2593 (40620)	24.23	23.90	
		2548.3(40173)	24.30	23.92	
		2503.5 (39725)	24.26	23.95	
		2682.5 (41515)	24.45	24.25	
	36RB-Low (0)	2637.8(41068)	24.59	24.07	
		2593 (40620)	24.20	24.15	
		2548.3(40173)	24.38	24.28	
		2503.5 (39725)	24.27	23.97	
	75RB (0)	2682.5 (41515)	24.38	24.17	
		2637.8(41068)	24.31	23.88	
		2593 (40620)	24.22	23.98	
		2548.3(40173)	24.19	24.20	
	20MHz	1RB-High (99)	2503.5 (39725)	24.27	23.89
			2682.5 (41515)	24.35	24.10
			2637.8(41068)	24.34	24.12
			2593 (40620)	24.16	23.99
			2548.3(40173)	24.23	24.14
		1RB-Middle (50)	2680 (41490)	24.30	24.05
			2636.5(41055)	24.42	23.45
2593 (40620)			24.19	24.25	
2549.5(40185)			24.48	24.05	
2506 (39750)			24.39	23.67	
1RB-Low (0)		2680 (41490)	24.66	24.33	
		2636.5(41055)	24.62	23.76	
		2593 (40620)	24.35	24.98	
		2549.5(40185)	24.89	24.62	
		2506 (39750)	24.51	23.82	
50RB-High (50)		2680 (41490)	24.68	24.21	
	2636.5(41055)	24.26	23.40		
	2593 (40620)	24.01	24.50		
	2549.5(40185)	24.50	24.01		
	2506 (39750)	24.38	23.53		
50RB-Middle (25)	2680 (41490)	24.48	24.06		
	2636.5(41055)	24.34	23.88		
	2593 (40620)	24.59	24.03		
	2549.5(40185)	24.34	23.91		
	2506 (39750)	24.43	24.22		
50RB-Low (0)	2680 (41490)	24.42	24.19		
	2636.5(41055)	24.33	24.05		
	2593 (40620)	24.64	24.19		
	2549.5(40185)	24.46	24.10		
	2506 (39750)	24.30	24.03		
100RB (0)	2680 (41490)	24.38	24.28		
	2636.5(41055)	24.22	24.03		
	2593 (40620)	24.32	24.04		
	2549.5(40185)	24.33	24.10		
	2506 (39750)	24.47	24.15		
		2680 (41490)	24.38	24.08	
		2636.5(41055)	24.41	23.95	
		2593 (40620)	24.25	23.94	
		2549.5(40185)	24.36	24.09	
		2506 (39750)	24.39	23.98	

11.4 Wi-Fi and BT Measurement result

The output power of BT antenna is as following:

The maximum output power of BT is 11.53dBm and the tune up is 12dBm.

The average conducted power for Wi-Fi is as following:

Table 11.4-1 WLAN 2.4G Low Power

802.11b	Channel\data rate	1Mbps	2Mbps	5.5Mbps	11Mbps
WLAN2450	11(2462MHz)	17.08	17.04	17.28	17.13
	6(2437(MHz)	16.91	/	17.04	/
	1(2412MHz)	16.80		17.37	
TUNEUP		18.00	18.00	18.00	18.00

802.11g	Channel\data rate	6Mbps	9Mbps	12Mbps	18Mbps	24Mbps	36Mbps	48Mbps	54Mbps
WLAN2450	11(2462MHz)	15.15	15.14	15.12	15.11	15.06	15.06	15.04	15.03
	6(2437(MHz)	14.54	/	/	/	/	/	/	/
	1(2412MHz)	14.41	/	/	/	/	/	/	/
TUNEUP		15.50	15.50	15.50	15.50	15.50	15.50	15.50	15.50
802.11n-20MHz	Channel\data rate	MCS0	MCS1	MCS2	MCS3	MCS4	MCS5	MCS6	MCS7
WLAN2450	11(2462MHz)	14.80	14.79	14.77	14.75	14.70	14.69	14.66	14.70
	6(2437(MHz)	14.63	/	/	/	/	/	/	/
	1(2412MHz)	14.66	/	/	/	/	/	/	/
TUNEUP		15.50	15.50	15.50	15.50	15.50	15.50	15.50	15.50

Table 11.4-2 WLAN 2.4G Normal Power

802.11b	Channel\data	1Mbps	2Mbps	5.5Mbps	11Mbps
WLAN2450	11(2462MHz)	18.16	/	18.49	/
	6(2437(MHz)	18.55	/	18.82	/
	1(2412MHz)	18.57	18.78	19.08	18.92
TUNEUP		19.50	19.50	19.50	19.50

802.11g	Channel\data rate	6Mbps	9Mbps	12Mbps	18Mbps	24Mbps	36Mbps	48Mbps	54Mbps
WLAN2450	11(2462MHz)	15.15	15.14	15.12	15.11	15.06	15.06	15.04	15.03
	6(2437(MHz)	14.54	/	/	/	/	/	/	/
	1(2412MHz)	14.41	/	/	/	/	/	/	/
TUNEUP		15.50	15.50	15.50	15.50	15.50	15.50	15.50	15.50
802.11n-20MHz	Channel\data rate	MCS0	MCS1	MCS2	MCS3	MCS4	MCS5	MCS6	MCS7
WLAN2450	11(2462MHz)	14.80	14.79	14.77	14.75	14.70	14.69	14.66	14.70
	6(2437(MHz)	14.63	/	/	/	/	/	/	/
	1(2412MHz)	14.66	/	/	/	/	/	/	/
TUNEUP		15.50	15.50	15.50	15.50	15.50	15.50	15.50	15.50



Table 11.4-3 WLAN 5G Low Power

802.11a(dBm)								
Channel\data rate	6Mbps	9Mbps	12Mbps	18Mbps	24Mbps	36Mbps	48Mbps	54Mbps
36(5180 MHz)	11.79	10.95	10.94	10.92	10.87	10.86	10.83	10.82
40(5200 MHz)	11.50	/	/	/	/	/	/	/
44(5220 MHz)	11.36	/	/	/	/	/	/	/
48(5240 MHz)	11.44	/	/	/	/	/	/	/
tuneup	13.00	12.00	12.00	12.00	12.00	12.00	12.00	12.00
149(5745 MHz)	12.01	/	/	/	/	/	/	/
153(5765 MHz)	12.02	/	/	/	/	/	/	/
157(5785 MHz)	12.13	/	/	/	/	/	/	/
161(5805 MHz)	12.99	/	/	/	/	/	/	/
165(5825 MHz)	13.44	12.88	12.87	12.87	12.82	12.81	12.79	12.78
tuneup	14.00	14.00	14.00	14.00	14.00	14.00	14.00	14.00
802.11n(dBm)-20MHz								
Channel\data rate	MCS0	MCS1	MCS2	MCS3	MCS4	MCS5	MCS6	MCS7
36(5180 MHz)	11.17	11.11	11.11	11.05	11.01	11.00	10.99	10.01
40(5200 MHz)	11.09	/	/	/	/	/	/	/
44(5220 MHz)	10.99	/	/	/	/	/	/	/
48(5240 MHz)	10.86	/	/	/	/	/	/	/
tuneup	12.00	12.00	12.00	12.00	12.00	12.00	12.00	12.00
149(5745 MHz)	11.36	/	/	/	/	/	/	/
153(5765 MHz)	11.48	/	/	/	/	/	/	/
157(5785 MHz)	11.70	/	/	/	/	/	/	/
161(5805 MHz)	12.49	/	/	/	/	/	/	/
165(5825 MHz)	12.94	12.91	12.90	12.85	12.85	12.82	12.80	12.74
tuneup	14.00	14.00	14.00	14.00	14.00	14.00	14.00	14.00
802.11n(dBm)-40MHz								
Channel\data rate	MCS0	MCS1	MCS2	MCS3	MCS4	MCS5	MCS6	MCS7
38(5190 MHz)	11.14	11.11	11.11	11.03	10.94	10.92	10.91	9.91
46(5230 MHz)	10.97	/	/	/	/	/	/	/
tuneup	12.50	12.50	12.50	12.50	12.50	12.50	12.50	11.50
151(5755 MHz)	11.33	/	/	/	/	/	/	/
159(5795 MHz)	11.86	11.84	11.82	11.74	11.72	11.69	11.68	10.69
tuneup	12.50	12.50	12.50	12.50	12.50	12.50	12.50	12.50

Table 11.4-4 WLAN 5G Normal Power

802.11a(dBm)								
Channel\data rate	6Mbps	9Mbps	12Mbps	18Mbps	24Mbps	36Mbps	48Mbps	54Mbps
36(5180 MHz)	15.70							
40(5200 MHz)	15.89	14.78	13.75	13.72	13.68	13.67	13.62	13.13
44(5220 MHz)	15.83							
48(5240 MHz)	15.67							
tuneup	17.00	16.00	15.00	15.00	15.00	15.00	15.00	15.00
149(5745 MHz)	16.26							
153(5765 MHz)	16.17							
157(5785 MHz)	16.27							
161(5805 MHz)	16.34							
165(5825 MHz)	16.94	16.16	15.34	15.34	15.30	15.30	15.26	14.80
tuneup	17.50	17.50	16.50	16.50	16.50	16.50	16.50	16.50
802.11n (dBm) -20MHz								
Channel\data rate	MCS0	MCS1	MCS2	MCS3	MCS4	MCS5	MCS6	MCS7
36(5180 MHz)	15.00	13.96	13.91	13.88	13.87	13.84	11.94	10.95
40(5200 MHz)	14.98							
44(5220 MHz)	14.88							
48(5240 MHz)	14.75							
tuneup	16.50	15.50	15.50	15.50	15.50	15.50	13.50	12.50
149(5745 MHz)	15.08							
153(5765 MHz)	15.11							
157(5785 MHz)	15.24							
161(5805 MHz)	15.36							
165(5825 MHz)	16.04	15.08	15.18	15.12	15.12	15.11	13.20	12.26
tuneup	16.50	16.50	16.50	16.50	16.50	16.50	14.50	13.50
802.11n(dBm)-40MHz								
Channel\data rate	MCS0	MCS1	MCS2	MCS3	MCS4	MCS5	MCS6	MCS7
38(5190 MHz)	13.85	12.91	12.91	12.83	12.79	12.77	11.78	10.77
46(5230 MHz)	13.77							
151(5755 MHz)	13.90							
159(5795 MHz)	14.18							
tuneup	16.00	14.00	14.00	14.00	14.00	14.00	13.00	12.00

12 Simultaneous TX SAR Considerations

12.1 Introduction

The following procedures adopted from “FCC SAR Considerations for Cell Phones with Multiple Transmitters” are applicable to handsets with built-in unlicensed transmitters such as 802.11 a/b/g and Bluetooth devices which may simultaneously transmit with the licensed transmitter.

For this device, the BT and Wi-Fi can transmit simultaneous with other transmitters.

12.2 Transmit Antenna Separation Distances

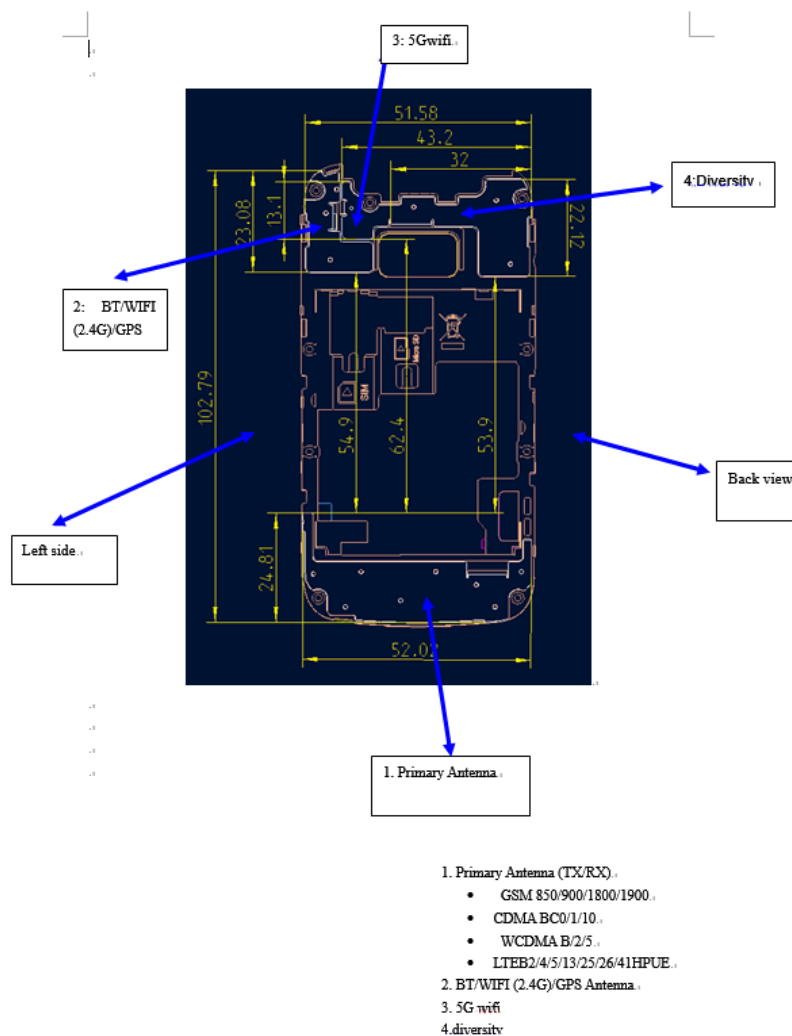

Picture 12.1 Antenna Locations

12.3 SAR Measurement Positions

According to the KDB941225 D06 Hot Spot SAR v01, the edges with less than 2.5 cm distance to the antennas need to be tested for SAR.

SAR measurement positions							
Mode	Front	Rear	Left edge	Right edge	Rear unfold	Bottom edge	Top
Main antenna	Yes	Yes	No	No	Yes	No	No
WLAN	Yes	Yes	No	No	Yes	No	No

12.4 Standalone SAR Test Exclusion Considerations

Standalone 1-g head or body SAR evaluation by measurement or numerical simulation is not required when the corresponding SAR Exclusion Threshold condition, listed below, is satisfied. The 1-g SAR test exclusion threshold for 100 MHz to 6 GHz at test separation distances ≤ 50 mm are determined by:

$[(\text{max. power of channel, including tune-up tolerance, mW}) / (\text{min. test separation distance, mm})] \cdot [\sqrt{f(\text{GHz})}] \leq 3.0$ for 1-g SAR, where

- $f(\text{GHz})$ is the RF channel transmit frequency in GHz
- Power and distance are rounded to the nearest mW and mm before calculation
- The result is rounded to one decimal place for comparison

Table 12.1: Standalone SAR test exclusion considerations

Band/Mode	F(GHz)	Position	SAR test exclusion threshold (mW)	RF output power		SAR test exclusion
				dBm	mW	
Bluetooth	2.441	Head	9.6	12	15.8	No
		Body	19.2	12	15.8	YES
2.4GHz WLAN 802.11 b	2.45	Head	9.58	16.5	44.7	No
		Body	19.17	18.5	70.8	No

Note: The result of Bluetooth Head and Body is lower than 0.01

13 Evaluation of Simultaneous

Table 13.1: The sum of reported SAR values for main antenna and WiFi

	Position	Main antenna	WiFi 2.4G	Sum
Highest reported SAR value for Head	Right hand, Touch cheek	0.70	0.87	1.57
Highest reported SAR value for Head	Left hand, Touch cheek	0.71	0.74	1.45
Highest reported SAR value for Body	Rear 15mm	1.11	0.1	1.21

	Position	Main antenna	WiFi 5G	Sum
Highest reported SAR value for Head	Right hand, Touch cheek	0.70	0.51	1.21
Highest reported SAR value for Head	Left hand, Touch cheek	0.71	0.27	0.98
Highest reported SAR value for Body	Rear 15mm	1.11	0.31	1.42

Table 13.2: The sum of reported SAR values for main antenna and BT

	Position	Main antenna	WiFi 2.4G	Sum
Highest reported SAR value for Head	Left hand, Touch cheek	0.71	0.66	1.37
Highest reported SAR value for Body	Rear 15mm	1.11	0.22	1.33

Note: The result of Bluetooth Head and Body is lower than 0.01

Table 13.3: Estimated SAR for Bluetooth

Mode/Band	F (GHz)	Position	Distance (mm)	Upper limit of power *		Estimated _{1g} (W/kg)
				dBm	mW	
Bluetooth	2.441	Head	5	12	15.85	0.66
Bluetooth	2.441	Body	15	12	15.85	0.22

* - Maximum possible output power declared by manufacturer

When standalone SAR test exclusion applies to an antenna that transmits simultaneously with other antennas, the standalone SAR must be estimated according to following to determine simultaneous transmission SAR test exclusion:

(max. power of channel, including tune-up tolerance, mW)/(min. test separation distance, mm) · [√f(GHz)/x] W/kg for test separation distances ≤ 50 mm;

where x = 7.5 for 1-g SAR.

When the minimum test separation distance is < 5 mm, a distance of 5 mm is applied to determine SAR test exclusion

Conclusion:

According to the above tables, the sum of reported SAR values is < 1.6W/kg. So the simultaneous transmission SAR with volume scans is not required.

14 SAR Test Result

It is determined by user manual for the distance between the EUT and the phantom bottom.

The distance is 10 mm and just applied to the condition of body worn accessory.

It is performed for all SAR measurements with area scan based 1-g SAR estimation (Fast SAR). A zoom scan measurement is added when the estimated 1-g SAR is the highest measured SAR in each exposure configuration, wireless mode and frequency band combination or more than 1.2W/kg.

The calculated SAR is obtained by the following formula:

$$\text{Reported SAR} = \text{Measured SAR} \times 10^{(P_{\text{Target}} - P_{\text{Measured}})/10}$$

Where P_{Target} is the power of manufacturing upper limit;

P_{Measured} is the measured power in chapter 11.

Mode	Duty Cycle
Speech for GSM850/1900	1:8.3
GPRS&EGPRS for GSM850	1:2.67
GPRS&EGPRS for GSM1900	1:4
WCDMA&FDD-LTE	1:1
TDD-LTE	1:1.58

14.1 SAR results

Table 14.1-1: SAR Values (GSM 850 MHz Band - Head)

Frequency		Side	Test Position	Figure No./Note	Conducted Power (dBm)	Max. tune-up Power (dBm)	Measured SAR(10g) (W/kg)	Reported SAR(10g) (W/kg)	Measured SAR(1g) (W/kg)	Reported SAR(1g) (W/kg)	Power Drift (dB)
Ch.	MHz										
Ambient Temperature: 22.3°C Liquid Temperature: 22.3°C											
190	836.6	Left	Cheek	/	32.67	33.50	0.195	0.24	0.288	0.35	0.09
190	836.6	Left	Tilt	/	32.67	33.50	0.115	0.14	0.153	0.19	-0.11
251	848.8	Right	Cheek	/	32.39	33.50	0.204	0.26	0.310	0.40	0.02
190	836.6	Right	Cheek	Fig.1	32.67	33.50	0.273	0.33	0.423	0.51	0.19
128	824.2	Right	Cheek	/	32.56	33.50	0.235	0.29	0.358	0.44	0.07
190	836.6	Right	Tilt	/	32.67	33.50	0.195	0.24	0.256	0.31	0.09

Table 14.1-2: SAR Values (GSM 850 MHz Band - Body)

Frequency		Mode (number of timeslots)	Test Position	Figure No./Note	Conducted Power (dBm)	Max. tune-up Power (dBm)	Measured SAR(10g) (W/kg)	Reported SAR(10g) (W/kg)	Measured SAR(1g) (W/kg)	Reported SAR(1g) (W/kg)	Power Drift (dB)
Ch.	MHz										
Ambient Temperature: 22.5°C Liquid Temperature: 22.3°C											
190	836.6	GPRS (3)	Front	/	28.65	29.50	0.114	0.14	0.146	0.18	0.08
251	848.8	GPRS (3)	Rear	Fig.2	28.69	29.50	0.422	0.51	0.569	0.69	-0.08
190	836.6	GPRS (3)	Rear	/	28.65	29.50	0.366	0.45	0.476	0.58	0.01
128	824.2	GPRS (3)	Rear	/	28.56	29.50	0.389	0.48	0.500	0.62	0.03
190	836.6	GPRS (3)	Rear unfold	/	28.60	29.50	0.193	0.24	0.253	0.31	-0.07
251	848.8	EGPRS (3)	Right	/	28.60	29.50	0.415	0.51	0.550	0.68	0.12

Note: The distance between the EUT and the phantom bottom is 15mm.

Table 14.1-3: SAR Values (GSM 1900 MHz Band - Head)

Frequency		Side	Test Position	Figure No./Note	Conducted Power (dBm)	Max. tune-up Power (dBm)	Measured SAR(10g) (W/kg)	Reported SAR(10g) (W/kg)	Measured SAR(1g) (W/kg)	Reported SAR(1g) (W/kg)	Power Drift (dB)
Ch.	MHz										
Ambient Temperature: 22.5°C Liquid Temperature: 22.3°C											
810	1909.8	Left	Cheek	/	29.68	30.50	0.087	0.11	0.122	0.15	-0.10
661	1880	Left	Cheek	/	29.77	30.50	0.076	0.09	0.116	0.14	0.11
512	1850.2	Left	Cheek	Fig.3	29.47	30.50	0.109	0.14	0.157	0.20	0.01
661	1880	Left	Tilt	/	29.77	30.50	0.025	0.03	0.030	0.04	0.09
661	1880	Right	Cheek	/	29.77	30.50	0.072	0.09	0.100	0.12	0.01
661	1880	Right	Tilt	/	29.77	30.50	0.017	0.02	0.022	0.03	-0.01

Table 14.1-4: SAR Values (GSM 1900 MHz Band - Body)

Frequency		Mode (number of timeslots)	Test Position	Figure No./ Note	Conducted Power (dBm)	Max. tune-up Power (dBm)	Measured SAR(10g) (W/kg)	Reported SAR(10g) (W/kg)	Measured SAR(1g) (W/kg)	Reported SAR(1g) (W/kg)	Power Drift (dB)
Ch.	MHz										
Ambient Temperature: 22.5 °C Liquid Temperature: 22.3 °C											
661	1880	GPRS(2)	Front	/	26.91	27.50	0.055	0.06	0.089	0.10	0.07
810	1909.8	GPRS(2)	Rear	/	26.95	27.50	0.205	0.23	0.317	0.36	0.12
661	1880	GPRS(2)	Rear	Fig.4	26.91	27.50	0.209	0.24	0.337	0.39	-0.09
512	1850.2	GPRS(2)	Rear	/	26.77	27.50	0.201	0.24	0.302	0.36	-0.01
661	1880	GPRS(2)	Rear unfold	/	26.91	27.50	0.179	0.21	0.278	0.32	0.06
661	1880	EGPRS(2)	Rear	/	26.93	27.50	0.203	0.23	0.331	0.38	-0.06

Note: The distance between the EUT and the phantom bottom is 15mm.

Table 14.1-5: SAR Values (WCDMA 1900 MHz Band - Head)

Frequency		Side	Test Position	Figure No./ Note	Conducted Power (dBm)	Max. tune-up Power (dBm)	Measured SAR(10g) (W/kg)	Reported SAR(10g) (W/kg)	Measured SAR(1g) (W/kg)	Reported SAR(1g) (W/kg)	Power Drift (dB)
Ch.	MHz										
Ambient Temperature: 22.5 °C Liquid Temperature: 22.3 °C											
9538	1907.6	Left	Cheek	/	23.16	24.00	0.202	0.25	0.313	0.38	-0.02
9400	1880	Left	Cheek	/	23.27	24.00	0.225	0.27	0.342	0.40	0.06
9262	1852.4	Left	Cheek	Fig.5	23.19	24.00	0.242	0.29	0.371	0.45	-0.02
9400	1880	Left	Tilt	/	23.27	24.00	0.064	0.08	0.080	0.09	0.04
9400	1880	Right	Cheek	/	23.27	24.00	0.183	0.22	0.269	0.32	0.09
9400	1880	Right	Tilt	/	23.27	24.00	0.054	0.06	0.066	0.08	-0.04

Table 14.1-6: SAR Values (WCDMA 1900 MHz Band - Body)

Frequency		Test Position	Figure No./ Note	Conducted Power (dBm)	Max. tune-up Power (dBm)	Measured SAR(10g) (W/kg)	Reported SAR(10g) (W/kg)	Measured SAR(1g) (W/kg)	Reported SAR(1g) (W/kg)	Power Drift (dB)
Ch.	MHz									
Ambient Temperature: 22.5 °C Liquid Temperature: 22.3 °C										
9400	1880	Front	/	23.27	24.00	0.140	0.17	0.223	0.26	0.15
9538	1907.6	Rear	Fig.6	23.16	24.00	0.511	0.62	0.822	1.00	-0.04
9400	1880	Rear	/	23.27	24.00	0.483	0.57	0.777	0.92	0.11
9262	1852.4	Rear	/	23.19	24.00	0.504	0.61	0.811	0.98	0.03
9400	1880	Rear unfold	/	23.27	24.00	0.390	0.46	0.600	0.71	-0.06

Note: The distance between the EUT and the phantom bottom is 15mm.

Table 14.1-7: SAR Values (WCDMA 850 MHz Band - Head)

Frequency		Side	Test Position	Figure No./Note	Conducted Power (dBm)	Max. tune-up Power (dBm)	Ambient Temperature: 22.5 °C		Liquid Temperature: 22.3°C		Power Drift (dB)
Ch.	MHz						Measured SAR(10g) (W/kg)	Reported SAR(10g)(W/kg)	Measured SAR(1g) (W/kg)	Reported SAR(1g) (W/kg)	
4183	836.6	Left	Cheek	/	23.43	24.00	0.242	0.28	0.369	0.42	0.11
4183	836.6	Left	Tilt	/	23.43	24.00	0.151	0.17	0.207	0.24	0.11
4233	846.6	Right	Cheek	Fig.7	23.59	24.00	0.337	0.37	0.521	0.57	-0.03
4183	836.6	Right	Cheek	/	23.43	24.00	0.325	0.37	0.495	0.56	-0.04
4132	826.4	Right	Cheek	/	23.44	24.00	0.319	0.36	0.496	0.56	0.09
4183	836.6	Right	Tilt	/	23.43	24.00	0.171	0.19	0.235	0.27	0.04

Table 14.1-8: SAR Values (WCDMA 850 MHz Band - Body)

Frequency		Test Position	Figure No./Note	Conducted Power (dBm)	Max. tune-up Power (dBm)	Ambient Temperature: 22.5 °C		Liquid Temperature: 22.3°C		Power Drift (dB)
Ch.	MHz					Measured SAR(10g) (W/kg)	Reported SAR(10g) (W/kg)	Measured SAR(1g) (W/kg)	Reported SAR(1g) (W/kg)	
4183	836.6	Front	/	23.43	24.00	0.170	0.19	0.216	0.25	-0.10
4233	846.6	Rear	/	23.59	24.00	0.524	0.58	0.728	0.80	0.12
4183	836.6	Rear	/	23.43	24.00	0.539	0.61	0.731	0.83	-0.03
4132	826.4	Rear	Fig.8	23.44	24.00	0.549	0.62	0.737	0.84	-0.02
4183	836.6	Rear unfold	/	23.43	24.00	0.257	0.29	0.350	0.40	0.06

Note: The distance between the EUT and the phantom bottom is 15mm.

Table 14.1-9: SAR Values (CDMA BC0 Band - Head)

Frequency		Side	Test Position	Figure No./Note	Conducted Power (dBm)	Max. tune-up Power (dBm)	Ambient Temperature: 22.5 °C		Liquid Temperature: 22.3°C		Power Drift (dB)
Ch.	MHz						Measured SAR(10g) (W/kg)	Reported SAR(10g) (W/kg)	Measured SAR(1g) (W/kg)	Reported SAR(1g) (W/kg)	
384	836.52	Left	Cheek	/	24.09	25.00	0.272	0.34	0.398	0.49	-0.03
384	836.52	Left	Tilt	/	24.09	25.00	0.169	0.21	0.217	0.27	-0.06
777	848.31	Right	Cheek	/	23.97	25.00	0.330	0.42	0.515	0.65	-0.09
384	836.52	Right	Cheek	Fig.11	24.09	25.00	0.363	0.45	0.565	0.70	-0.08
1013	824.7	Right	Cheek	/	24.06	25.00	0.280	0.35	0.441	0.55	0.08
384	836.52	Right	Tilt	/	24.09	25.00	0.183	0.23	0.235	0.29	-0.05

Table 14.1-10: SAR Values (CDMA BC0 Band - Body)

Ambient Temperature: 22.5 °C					Liquid Temperature: 22.3°C					
Frequency		Test Position	Figure No./ Note	Conducted Power (dBm)	Max. tune-up Power (dBm)	Measured SAR(10g) (W/kg)	Reported SAR(10g) (W/kg)	Measured SAR(1g) (W/kg)	Reported SAR(1g) (W/kg)	Power Drift (dB)
Ch.	MHz									
384	836.52	Front	/	24.02	25.00	0.174	0.22	0.225	0.28	0.08
777	848.31	Rear	/	23.91	25.00	0.513	0.66	0.702	0.90	-0.11
384	836.52	Rear	Fig.10	24.02	25.00	0.529	0.66	0.724	0.91	0.03
1013	824.7	Rear	/	24.01	25.00	0.491	0.62	0.664	0.83	0.12
384	836.52	Rear unfold	/	24.02	25.00	0.241	0.30	0.332	0.42	0.03

Note: The distance between the EUT and the phantom bottom is 15mm

Table 14.1-11: SAR Values (CDMA BC1 Band - Head)

Ambient Temperature: 22.5 °C					Liquid Temperature: 22.3°C						
Frequency		Side	Test Position	Figure No./ Note	Conducted Power (dBm)	Max. tune-up Power (dBm)	Measured SAR(10g) (W/kg)	Reported SAR(10g) (W/kg)	Measured SAR(1g) (W/kg)	Reported SAR(1g) (W/kg)	Power Drift (dB)
Ch.	MHz										
1175	1908.75	Left	Cheek	/	23.74	25.00	0.170	0.23	0.317	0.42	0.09
600	1880	Left	Cheek	Fig.11	23.68	25.00	0.242	0.33	0.377	0.51	-0.04
25	1851.25	Left	Cheek	/	23.62	25.00	0.201	0.28	0.356	0.49	0.10
600	1880	Left	Tilt	/	23.68	25.00	0.046	0.06	0.063	0.09	0.03
600	1880	Right	Cheek	/	23.68	25.00	0.139	0.19	0.222	0.30	0.09
600	1880	Right	Tilt	/	23.68	25.00	0.042	0.06	0.057	0.08	-0.11

Table 14.1-12: SAR Values (CDMA BC1 Band - Body)

Ambient Temperature: 22.5 °C					Liquid Temperature: 22.3°C					
Frequency		Test Position	Figure No./ Note	Conducted Power (dBm)	Max. tune-up Power (dBm)	Measured SAR(10g) (W/kg)	Reported SAR(10g) (W/kg)	Measured SAR(1g) (W/kg)	Reported SAR(1g) (W/kg)	Power Drift (dB)
Ch.	MHz									
600	1880	Front	/	23.60	25.00	0.125	0.17	0.211	0.29	-0.03
1175	1908.75	Rear	/	23.64	25.00	0.436	0.60	0.730	1.00	-0.08
600	1880	Rear	Fig.12	23.60	25.00	0.448	0.62	0.747	1.03	-0.07
25	1851.25	Rear	/	23.49	25.00	0.425	0.60	0.722	1.02	0.06
600	1880	Rear unfold	/	23.60	25.00	0.374	0.52	0.607	0.84	-0.08

Note: The distance between the EUT and the phantom bottom is 15mm.

Table 14.1-13: SAR Values (CDMA BC10 Band - Head)

Ambient Temperature: 22.5 °C						Liquid Temperature: 22.3°C					
Frequency		Side	Test Position	Figure No./ Note	Conducted Power (dBm)	Max. tune-up Power (dBm)	Measured SAR(10g) (W/kg)	Reported SAR(10g)(W/kg)	Measured SAR(1g) (W/kg)	Reported SAR(1g) (W/kg)	Power Drift (dB)
Ch.	MHz										
580	820.5	Left	Cheek	/	23.99	25.00	0.220	0.28	0.333	0.42	0.01
580	820.5	Left	Tilt	/	23.99	25.00	0.128	0.16	0.167	0.21	-0.08
684	823.1	Right	Cheek	/	24.12	25.00	0.260	0.32	0.419	0.51	0.09
580	820.5	Right	Cheek	Fig.13	23.99	25.00	0.299	0.38	0.465	0.59	-0.06
476	817.9	Right	Cheek	/	24.02	25.00	0.263	0.33	0.429	0.54	-0.12
580	820.5	Right	Tilt	/	23.99	25.00	0.140	0.18	0.184	0.23	-0.01

Table 14.1-14: SAR Values (CDMA BC10 Band - Body)

Ambient Temperature: 22.5 °C						Liquid Temperature: 22.3°C					
Frequency		Test Position	Figure No./ Note	Conducted Power (dBm)	Max. tune-up Power (dBm)	Measured SAR(10g) (W/kg)	Reported SAR(10g) (W/kg)	Measured SAR(1g) (W/kg)	Reported SAR(1g) (W/kg)	Power Drift (dB)	
Ch.	MHz										
580	820.5	Front	/	23.93	25.00	0.166	0.21	0.215	0.28	0.05	
684	823.1	Rear	/	24.03	25.00	0.505	0.63	0.679	0.85	0.11	
580	820.5	Rear	Fig.14	23.93	25.00	0.534	0.68	0.737	0.94	-0.15	
476	817.9	Rear	/	23.96	25.00	0.527	0.67	0.729	0.93	-0.05	
580	820.5	Rear unfold	/	23.93	25.00	0.238	0.30	0.330	0.42	-0.06	

Note: The distance between the EUT and the phantom bottom is 15mm

Table 14.1-15: SAR Values (LTE Band4 - Head)

Ambient Temperature: 22.5 °C						Liquid Temperature: 22.3°C						
Frequency		Mode	Side	Test Position	Figure No./ Note	Conducted Power (dBm)	Max. tune-up Power (dBm)	Measured SAR(10g) (W/kg)	Reported SAR(10g)(W/kg)	Measured SAR(1g) (W/kg)	Reported SAR(1g) (W/kg)	Power Drift (dB)
Ch.	MHz											
20050	1720	1RB-Low	Left	Cheek	/	23.66	24.00	0.136	0.15	0.307	0.33	-0.06
20050	1720	1RB-Low	Left	Tilt	/	23.66	24.00	0.057	0.06	0.083	0.09	-0.06
20050	1720	1RB-Low	Right	Cheek	/	23.66	24.00	0.199	0.22	0.332	0.36	0.06
20050	1720	1RB-Low	Right	Tilt	/	23.66	24.00	0.046	0.05	0.070	0.08	-0.06
20300	1745	50RB-Mid	Left	Cheek	/	22.33	23.00	0.157	0.18	0.307	0.36	0.04
20300	1745	50RB-Mid	Left	Tilt	/	22.33	23.00	0.045	0.05	0.069	0.08	0.07
20300	1745	50RB-Mid	Right	Cheek	Fig.15	22.33	23.00	0.209	0.24	0.341	0.40	0.17
20300	1745	50RB-Mid	Right	Tilt	/	22.33	23.00	0.041	0.05	0.062	0.07	-0.01

Note1: The LTE mode is QPSK_20MHz.

Table 14.1-16: SAR Values (LTE Band4 - Body)

Frequency		Mode	Test Position	Figure No./ Note	Conduct ed Power (dBm)	Max. tune-up Power (dBm)	Measured SAR(10g) (W/kg)	Reported SAR(10g) (W/kg)	Measured SAR(1g) (W/kg)	Reported SAR(1g) (W/kg)	Power Drift (dB)
Ch.	MHz										
Ambient Temperature: 22.5 °C						Liquid Temperature: 22.3°C					
20050	1720	1RB-Mid	Front	/	22.33	23.00	0.132	0.15	0.200	0.22	0.10
20300	1745	1RB-Mid	Rear	Fig.16	22.75	23.00	0.643	0.68	1.050	1.11	0.01
20175	1732.5	1RB-Mid	Rear	/	22.32	23.00	0.609	0.68	0.989	1.10	0.03
20050	1720	1RB-Mid	Rear	/	22.33	23.00	0.554	0.62	0.909	1.01	-0.09
20300	1745	1RB-Mid	Rear unfold	/	22.33	23.00	0.547	0.61	0.862	0.96	0.01
20175	1732.5	1RB-Mid	Rear unfold	/	22.42	23.00	0.478	0.55	0.746	0.85	0.02
20050	1720	1RB-Mid	Rear unfold	/	22.33	23.00	0.535	0.60	0.837	0.93	-0.12
20300	1745	50RB-Mid	Front	/	22.72	23.00	0.147	0.16	0.224	0.24	0.01
20300	1745	50RB-Mid	Rear	/	22.72	23.00	0.630	0.67	1.020	1.09	-0.01
20175	1732.5	50RB-Mid	Rear	/	22.35	23.00	0.596	0.66	0.974	1.08	-0.09
20050	1720	50RB-High	Rear	/	22.32	23.00	0.594	0.66	0.965	1.08	0.03
20300	1745	50RB-Mid	Rear unfold	/	22.72	23.00	0.540	0.58	0.858	0.92	0.03
20175	1732.5	50RB-Mid	Rear unfold	/	22.35	23.00	0.474	0.53	0.741	0.82	-0.10
20050	1720	50RB-High	Rear unfold	/	22.32	23.00	0.462	0.52	0.714	0.80	-0.02
20300	1745	100RB	Rear	/	22.68	23.00	0.629	0.68	0.995	1.07	-0.04
20300	1745	100RB	Rear unfold	/	22.68	23.00	0.547	0.59	0.862	0.93	0.05

Note1: The distance between the EUT and the phantom bottom is 15mm.

Note2: The LTE mode is QPSK_20MHz.

Table 14.1-17: SAR Values (LTE Band13 - Head)

Frequency		Mode	Side	Test Position	Figure No./ Note	Conducte d Power (dBm)	Max. tune-up Power (dBm)	Measure d SAR(10g) (W/kg)	Reported SAR(10g) (W/kg)	Measure d SAR(1g) (W/kg)	Reporte d SAR(1g) (W/kg)	Power Drift (dB)
Ch.	MHz											
Ambient Temperature: 22.5 °C						Liquid Temperature: 22.3°C						
23230	782	1RB-Mid	Left	Cheek	/	23.31	24.00	0.098	0.12	0.169	0.20	-0.04
23230	782	1RB-Mid	Left	Tilt	/	23.31	24.00	0.060	0.07	0.074	0.09	0.03
23230	782	1RB-Mid	Right	Cheek	Fig.17	23.31	24.00	0.160	0.19	0.239	0.28	0.09
23230	782	1RB-Mid	Right	Tilt	/	23.31	24.00	0.072	0.08	0.089	0.10	-0.08
23230	782	50RB-High	Left	Cheek	/	22.05	23.00	0.076	0.09	0.132	0.16	-0.01
23230	782	50RB-High	Left	Tilt	/	22.05	23.00	0.049	0.06	0.060	0.07	0.02
23230	782	50RB-High	Right	Cheek	/	22.05	23.00	0.122	0.15	0.182	0.23	-0.07
23230	782	50RB-High	Right	Tilt	/	22.05	23.00	0.054	0.07	0.067	0.08	0.09

Note1: The LTE mode is QPSK_20MHz.

Table 14.1-18: SAR Values (LTE Band13 - Body)

Frequency		Mode	Test Position	Figure No./ Note	Conducted Power (dBm)	Max. tune-up Power (dBm)	Measured SAR(10g) (W/kg)	Reported SAR(10g) (W/kg)	Measured SAR(1g) (W/kg)	Reported SAR(1g) (W/kg)	Power Drift (dB)
Ch.	MHz										
Ambient Temperature: 22.5 °C						Liquid Temperature: 22.3 °C					
23230	782	1RB-High	Front	/	23.31	24.00	0.088	0.10	0.115	0.13	-0.11
23230	782	1RB-High	Rear	Fig.18	23.31	24.00	0.323	0.38	0.447	0.52	-0.06
23230	782	1RB-High	Rear unfold	/	23.31	24.00	0.242	0.28	0.331	0.39	0.07
23230	782	25RB-High	Front	/	22.05	23.00	0.069	0.09	0.090	0.11	0.07
23230	782	25RB-High	Rear	/	22.05	23.00	0.240	0.30	0.332	0.41	0.10
23230	782	25RB-High	Rear unfold	/	22.05	23.00	0.184	0.23	0.253	0.31	-0.05

Note1: The LTE mode is QPSK_20MHz.

Note2: The distance between the EUT and the phantom bottom is 15mm.

Table 14.1-19: SAR Values (LTE Band25 - Head)

Frequency		Mode	Side	Test Position	Figure No./ Note	Conducted Power (dBm)	Max. tune-up Power (dBm)	Measured SAR(10g) (W/kg)	Reported SAR(10g) (W/kg)	Measured SAR(1g) (W/kg)	Reported SAR(1g) (W/kg)	Power Drift (dB)
Ch.	MHz											
Ambient Temperature: 22.5 °C						Liquid Temperature: 22.3 °C						
26365	1882.5	1RB-High	Left	Cheek	Fig.19	23.51	24.00	0.175	0.20	0.269	0.30	-0.08
26365	1882.5	1RB-High	Left	Tilt	/	23.51	24.00	0.031	0.03	0.051	0.06	0.02
26365	1882.5	1RB-High	Right	Cheek	/	23.51	24.00	0.118	0.13	0.205	0.23	-0.09
26365	1882.5	1RB-High	Right	Tilt	/	23.51	24.00	0.029	0.03	0.044	0.05	0.10
26590	1905	50RB-Mid	Left	Cheek	/	22.45	23.00	0.123	0.14	0.192	0.22	0.10
26590	1905	50RB-Mid	Left	Tilt	/	22.45	23.00	0.020	0.02	0.035	0.04	0.03
26590	1905	50RB-Mid	Right	Cheek	/	22.45	23.00	0.070	0.08	0.126	0.14	-0.05
26590	1905	50RB-Mid	Right	Tilt	/	22.45	23.00	0.020	0.02	0.032	0.04	0.10

Note1: The LTE mode is QPSK_20MHz.

Table 14.1-20: SAR Values (LTE Band26 - Body)

Frequency		Mode	Test Position	Figure No./ Note	Conducted Power (dBm)	Max. tune-up Power (dBm)	Measured SAR(10g) (W/kg)	Reported SAR(10g) (W/kg)	Measured SAR(1g) (W/kg)	Reported SAR(1g) (W/kg)	Power Drift (dB)
Ch.	MHz										
Ambient Temperature: 22.5 °C						Liquid Temperature: 22.3 °C					
26365	1882.5	1RB-High	Front	/	23.51	24.00	0.140	0.16	0.226	0.25	0.03
26590	1905	1RB-Mid	Rear	/	23.48	24.00	0.470	0.53	0.747	0.84	-0.07
26365	1882.5	1RB-High	Rear	Fig.20	23.51	24.00	0.486	0.54	0.778	0.87	0.02
26140	1860	1RB-Mid	Rear	/	23.24	24.00	0.449	0.53	0.721	0.86	0.02

26365	1882.5	1RB-High	Rear	/	23.51	24.00	0.400	0.45	0.616	0.69	-0.07
26590	1905	50RB-Mid	Front	/	22.45	23.00	0.095	0.11	0.153	0.17	0.01
26590	1905	50RB-Mid	Rear	/	22.45	23.00	0.358	0.41	0.572	0.65	0.08
26590	1905	50RB-Mid	Rear unfold	/	22.45	23.00	0.219	0.25	0.354	0.40	0.11
26590	1905	100RB	Rear	/	22.45	23.00	0.359	0.41	0.571	0.65	0.05

Note1: The distance between the EUT and the phantom bottom is 15mm.

Note2: The LTE mode is QPSK_20MHz.

Table 14.1-21: SAR Values (LTE Band26 - Head)

Ambient Temperature: 22.5 °C						Liquid Temperature: 22.3 °C						
Frequency		Mode	Side	Test Position	Figure No./ Note	Conducte d Power (dBm)	Max. tune-up Power (dBm)	Measure d SAR(10g) (W/kg)	Reported SAR(10g) (W/kg)	Measure d SAR(1g) (W/kg)	Reporte d SAR(1g) (W/kg)	Power Drift (dB)
Ch.	MHz											
26965	841.5	1RB-Mid	Left	Cheek	/	23.28	24.00	0.214	0.25	0.313	0.37	-0.11
26965	841.5	1RB-Mid	Left	Tilt	/	23.28	24.00	0.128	0.15	0.165	0.19	0.03
26965	841.5	1RB-Mid	Right	Cheek	Fig.21	23.28	24.00	0.314	0.37	0.490	0.58	0.15
26965	841.5	1RB-Mid	Right	Tilt	/	23.28	24.00	0.152	0.18	0.196	0.23	0.05
26965	841.5	36RB-Mid	Left	Cheek	/	22.21	23.00	0.164	0.20	0.240	0.29	-0.09
26965	841.5	36RB-Mid	Left	Tilt	/	22.21	23.00	0.102	0.12	0.132	0.16	0.12
26965	841.5	36RB-Mid	Right	Cheek	/	22.21	23.00	0.237	0.28	0.369	0.44	0.01
26965	841.5	36RB-Mid	Right	Tilt	/	22.21	23.00	0.116	0.14	0.150	0.18	-0.07

Note1: The LTE mode is QPSK_15MHz.

Table 14.1-22: SAR Values (LTE Band26 - Body)

Ambient Temperature: 22.5 °C						Liquid Temperature: 22.3 °C					
Frequency		Mode	Test Position	Figure No./ Note	Conduct ed Power (dBm)	Max. tune-up Power (dBm)	Measured SAR(10g) (W/kg)	Reported SAR(10g) (W/kg)	Measured SAR(1g) (W/kg)	Reported SAR(1g) (W/kg)	Power Drift (dB)
Ch.	MHz										
26965	841.5	1RB-Mid	Front	/	23.28	24.00	0.148	0.17	0.186	0.22	-0.01
26965	841.5	1RB-Mid	Rear	Fig.22	23.28	24.00	0.503	0.59	0.678	0.80	-0.06
26865	831.5	1RB-Mid	Rear	/	23.28	24.00	0.489	0.58	0.639	0.75	0.02
26775	822.3	1RB-High	Rear	/	23.28	24.00	0.472	0.56	0.618	0.73	-0.07
26965	841.5	1RB-High	Rear unfold	/	23.28	24.00	0.192	0.23	0.255	0.30	-0.01
26965	841.5	36RB-Mid	Front	/	22.21	23.00	0.120	0.14	0.151	0.18	-0.01
26965	841.5	36RB-Mid	Rear	/	22.21	23.00	0.366	0.44	0.492	0.59	0.07
26965	841.5	36RB-Mid	Rear unfold	/	22.21	23.00	0.157	0.19	0.209	0.25	0.08
26965	841.5	75RB	Rear	/	22.18	23.00	0.384	0.46	0.513	0.62	-0.01

Note1: The distance between the EUT and the phantom bottom is 15mm.

Note2: The LTE mode is QPSK_15MHz.

Table 14.1-23: SAR Values (LTE Band41 PC3- Head)

Ambient Temperature: 22.5 °C						Liquid Temperature: 22.3 °C						
Frequency		Mode	Side	Test Position	Figure No./ Note	Conducted Power (dBm)	Max. tune-up Power (dBm)	Measured SAR(10g) (W/kg)	Reported SAR(10g) (W/kg)	Measured SAR(1g) (W/kg)	Reported SAR(1g) (W/kg)	Power Drift (dB)
Ch.	MHz											
40185	2549.5	1RB-Mid	Left	Cheek	Fig.23	23.97	24.00	0.341	0.34	0.702	0.71	0.02
40185	2549.5	1RB-Mid	Left	Tilt	/	23.97	24.00	0.088	0.09	0.144	0.14	0.10
40185	2549.5	1RB-Mid	Right	Cheek	/	23.97	24.00	0.108	0.11	0.203	0.20	-0.12
40185	2549.5	1RB-Mid	Right	Tilt	/	23.97	24.00	0.038	0.04	0.061	0.06	-0.07
41490	2680	50RB-High	Left	Cheek	/	22.76	23.00	0.200	0.21	0.428	0.45	0.07
41490	2680	50RB-High	Left	Tilt	/	22.76	23.00	0.055	0.06	0.104	0.11	0.12
41490	2680	50RB-High	Right	Cheek	/	22.76	23.00	0.059	0.06	0.116	0.12	-0.12
41490	2680	50RB-High	Right	Tilt	/	22.76	23.00	0.026	0.03	0.045	0.05	-0.01

Note1: The LTE mode is QPSK_20MHz.

Table 14.1-24: SAR Values (LTE Band41 PC3- Body)

Ambient Temperature: 22.5 °C						Liquid Temperature: 22.3 °C					
Frequency		Mode	Test Position	Figure No./ Note	Conducted Power (dBm)	Max. tune-up Power (dBm)	Measured SAR(10g) (W/kg)	Reported SAR(10g) (W/kg)	Measured SAR(1g) (W/kg)	Reported SAR(1g) (W/kg)	Power Drift (dB)
Ch.	MHz										
40185	2549.5	1RB-Mid	Front	/	23.97	24.00	0.056	0.06	0.099	0.10	0.01
40185	2549.5	1RB-Mid	Rear	/	23.97	24.00	0.235	0.24	0.455	0.46	-0.01
40185	2549.5	1RB-Mid	Rear unfold	/	23.97	24.00	0.260	0.26	0.487	0.49	-0.04
41490	2680	50RB-High	Front	/	22.76	23.00	0.050	0.05	0.088	0.09	0.05
41490	2680	50RB-High	Rear	Fig.24	22.76	23.00	0.347	0.37	0.704	0.74	0.02
41490	2636.5	50RB-Mid	Rear	/	22.66	23.00	0.297	0.32	0.586	0.63	-0.05
40620	2593	50RB-High	Rear	/	22.69	23.00	0.228	0.25	0.444	0.48	0.12
40185	2549.5	50RB-Mid	Rear	/	22.66	23.00	0.184	0.20	0.351	0.38	0.07
39750	2506	50RB-High	Rear	/	22.43	23.00	0.166	0.19	0.319	0.36	0.05
41490	2680	50RB-High	Rear unfold	/	22.76	23.00	0.193	0.20	0.377	0.40	0.12
40185	2549.5	100RB	Rear	/	22.71	23.00	0.187	0.20	0.356	0.38	-0.08

Note1: The LTE mode is QPSK_20MHz.

Note2: The distance between the EUT and the phantom bottom is 15mm.

Table 14.1-25: SAR Values (LTE Band41 PC2- Head)

Ambient Temperature: 22.5 °C						Liquid Temperature: 22.3 °C						
Frequency		Mode	Side	Test Position	Figure No./ Note	Conducted Power (dBm)	Max. tune-up Power (dBm)	Measured SAR(10g) (W/kg)	Reported SAR(10g) (W/kg)	Measured SAR(1g) (W/kg)	Reported SAR(1g) (W/kg)	Power Drift (dB)
Ch.	MHz											
40185	2549.5	1RB-Mid	Left	Cheek	Fig.25	24.89	25.00	0.333	0.34	0.672	0.69	0.02
40185	2549.5	1RB-Mid	Left	Tilt	/	24.89	25.00	0.069	0.07	0.120	0.12	-0.08
40185	2549.5	1RB-Mid	Right	Cheek	/	24.89	25.00	0.073	0.07	0.147	0.15	0.12
40185	2549.5	1RB-Mid	Right	Tilt	/	24.89	25.00	0.029	0.03	0.055	0.06	-0.04
40620	2593	50RB-Mid	Left	Cheek	/	24.64	25.00	0.226	0.25	0.468	0.51	0.02
40620	2593	50RB-Mid	Left	Tilt	/	24.64	25.00	0.056	0.06	0.101	0.11	0.11
40620	2593	50RB-Mid	Right	Cheek	/	24.64	25.00	0.073	0.08	0.151	0.16	-0.04
40620	2593	50RB-Mid	Right	Tilt	/	24.64	25.00	0.028	0.03	0.050	0.05	-0.07

Note: The LTE mode is QPSK_20MHz.

Table 14.1-26: SAR Values (LTE Band41 PC2- Body)

Ambient Temperature: 22.5 °C						Liquid Temperature: 22.3 °C					
Frequency		Mode	Test Position	Figure No./ Note	Conducted Power (dBm)	Max. tune-up Power (dBm)	Measured SAR(10g) (W/kg)	Reported SAR(10g) (W/kg)	Measured SAR(1g) (W/kg)	Reported SAR(1g) (W/kg)	Power Drift (dB)
Ch.	MHz										
40185	2549.5	1RB-Mid	Front	/	26.49	27.00	0.074	0.08	0.131	0.15	-0.09
40185	2549.5	1RB-Mid	Rear	/	26.49	27.00	0.298	0.34	0.577	0.65	-0.08
40185	2549.5	1RB-Mid	Rear unfold	/	26.49	27.00	0.347	0.39	0.651	0.73	-0.02
41490	2680	50RB-High	Front	/	25.36	26.00	0.052	0.06	0.089	0.10	0.03
41490	2680	50RB-High	Rear	Fig.26	25.36	26.00	0.439	0.51	0.896	1.04	0.01
41055	2636.5	50RB-Mid	Rear	/	25.36	26.00	0.350	0.41	0.694	0.80	0.01
40620	2593	50RB-High	Rear	/	25.13	26.00	0.273	0.33	0.532	0.65	-0.10
40185	2549.5	50RB-High	Rear	/	25.35	26.00	0.220	0.25	0.420	0.49	-0.10
39750	2506	50RB-High	Rear	/	25.12	26.00	0.196	0.24	0.374	0.46	-0.08
41490	2680	50RB-High	Rear unfold	/	25.36	26.00	0.238	0.28	0.471	0.55	0.08
41490	2680	100RB	Rear	/	25.42	26.00	0.440	0.50	0.888	1.01	0.10

Note1: The LTE mode is QPSK_20MHz.

Note2: The distance between the EUT and the phantom bottom is 15mm.

14.2 SAR results for Standard procedure

Table 14.2-1: SAR Values (GSM 850 MHz Band - Head)

Ambient Temperature: 22.5 °C						Liquid Temperature: 22.3°C					
Frequency		Side	Test Position	Figure No./Note	Conducted Power (dBm)	Max. tune-up Power (dBm)	Measured SAR(10g) (W/kg)	Reported SAR(10g) (W/kg)	Measured SAR(1g) (W/kg)	Reported SAR(1g) (W/kg)	Power Drift (dB)
Ch.	MHz										
190	836.6	Right	Cheek	Fig.1	32.67	33.50	0.273	0.33	0.423	0.51	0.19

Table 14.2-2: SAR Values (GSM 850 MHz Band - Body)

Ambient Temperature: 22.5 °C						Liquid Temperature: 22.3°C					
Frequency		Mode (number of timeslots)	Test Position	Figure No./ Note	Conducted Power (dBm)	Max. tune-up Power (dBm)	Measured SAR(10g) (W/kg)	Reported SAR(10g) (W/kg)	Measured SAR(1g) (W/kg)	Reported SAR(1g) (W/kg)	Power Drift (dB)
Ch.	MHz										
251	848.8	GPRS (3)	Rear	Fig.2	28.69	29.50	0.422	0.51	0.569	0.69	-0.08

Note: The distance between the EUT and the phantom bottom is 15mm.

Table 14.2-3: SAR Values (GSM 1900 MHz Band - Head)

Ambient Temperature: 22.5 °C						Liquid Temperature: 22.3°C					
Frequency		Side	Test Position	Figure No./ Note	Conducted Power (dBm)	Max. tune-up Power (dBm)	Measured SAR(10g) (W/kg)	Reported SAR(10g) (W/kg)	Measured SAR(1g) (W/kg)	Reported SAR(1g) (W/kg)	Power Drift (dB)
Ch.	MHz										
512	1850.2	Left	Cheek	Fig.3	29.47	30.50	0.109	0.14	0.157	0.20	0.01

Table 14.2-4: SAR Values (GSM 1900 MHz Band - Body)

Ambient Temperature: 22.5 °C						Liquid Temperature: 22.3°C					
Frequency		Mode (number of timeslots)	Test Position	Figure No./ Note	Conducted Power (dBm)	Max. tune-up Power (dBm)	Measured SAR(10g) (W/kg)	Reported SAR(10g) (W/kg)	Measured SAR(1g) (W/kg)	Reported SAR(1g) (W/kg)	Power Drift (dB)
Ch.	MHz										
661	1880	GPRS(2)	Rear	Fig.4	26.91	27.50	0.209	0.24	0.337	0.39	-0.09

Note: The distance between the EUT and the phantom bottom is 15mm.

Table 14.2-5: SAR Values (WCDMA 1900 MHz Band - Head)

Ambient Temperature: 22.5 °C						Liquid Temperature: 22.3°C					
Frequency		Side	Test Position	Figure No./ Note	Conducted Power (dBm)	Max. tune-up Power (dBm)	Measured SAR(10g) (W/kg)	Reported SAR(10g) (W/kg)	Measured SAR(1g) (W/kg)	Reported SAR(1g) (W/kg)	Power Drift (dB)
Ch.	MHz										
9262	1852.4	Left	Cheek	Fig.5	23.19	24.00	0.242	0.29	0.371	0.45	-0.02

Table 14.2-6: SAR Values (WCDMA 1900 MHz Band - Body)

Frequency		Test Position	Figure No./ Note	Conducted Power (dBm)	Max. tune-up Power (dBm)	Measured SAR(10g) (W/kg)	Reported SAR(10g) (W/kg)	Measured SAR(1g) (W/kg)	Reported SAR(1g) (W/kg)	Power Drift (dB)
Ch.	MHz									
9538	1907.6	Rear	Fig.6	23.16	24.00	0.511	0.62	0.822	1.00	-0.04

Note: The distance between the EUT and the phantom bottom is 15mm.

Table 14.2-7: SAR Values (WCDMA 850 MHz Band - Head)

Frequency		Side	Test Position	Figure No./Note	Conducted Power (dBm)	Max. tune-up Power (dBm)	Measured SAR(10g) (W/kg)	Reported SAR(10g) (W/kg)	Measured SAR(1g) (W/kg)	Reported SAR(1g) (W/kg)	Power Drift (dB)
Ch.	MHz										
4233	846.6	Right	Cheek	Fig.7	23.59	24.00	0.337	0.37	0.521	0.57	-0.03

Table 14.2-8: SAR Values (WCDMA 850 MHz Band - Body)

Frequency		Test Position	Figure No./ Note	Conducted Power (dBm)	Max. tune-up Power (dBm)	Measured SAR(10g) (W/kg)	Reported SAR(10g) (W/kg)	Measured SAR(1g) (W/kg)	Reported SAR(1g) (W/kg)	Power Drift (dB)
Ch.	MHz									
4132	826.4	Rear	Fig.8	23.44	24.00	0.549	0.62	0.737	0.84	-0.02

Note: The distance between the EUT and the phantom bottom is 15mm.

Table 14.2-9: SAR Values (CDMA BC0 Band - Head)

Frequency		Side	Test Position	Figure No./ Note	Conducted Power (dBm)	Max. tune-up Power (dBm)	Measured SAR(10g) (W/kg)	Reported SAR(10g) (W/kg)	Measured SAR(1g) (W/kg)	Reported SAR(1g) (W/kg)	Power Drift (dB)
Ch.	MHz										
384	836.52	Right	Cheek	Fig.11	24.09	25.00	0.363	0.45	0.565	0.70	-0.08

Table 14.2-10: SAR Values (CDMA BC0 Band - Body)

Frequency		Test Position	Figure No./ Note	Conducted Power (dBm)	Max. tune-up Power (dBm)	Measured SAR(10g) (W/kg)	Reported SAR(10g) (W/kg)	Measured SAR(1g) (W/kg)	Reported SAR(1g) (W/kg)	Power Drift (dB)
Ch.	MHz									
384	836.52	Rear	Fig.10	24.02	25.00	0.529	0.66	0.724	0.91	0.03

Note: The distance between the EUT and the phantom bottom is 15mm

Table 14.2-11: SAR Values (CDMA BC1 Band - Head)

Ambient Temperature: 22.5 °C Liquid Temperature: 22.3°C											
Frequency		Side	Test Position	Figure No./ Note	Conducted Power (dBm)	Max. tune-up Power (dBm)	Measured SAR(10g) (W/kg)	Reported SAR(10g) (W/kg)	Measured SAR(1g) (W/kg)	Reported SAR(1g) (W/kg)	Power Drift (dB)
Ch.	MHz										
600	1880	Left	Cheek	Fig.11	23.68	25.00	0.242	0.33	0.377	0.51	-0.04

Table 14.2-12: SAR Values (CDMA BC1 Band - Body)

Ambient Temperature: 22.5 °C Liquid Temperature: 22.3°C										
Frequency		Test Position	Figure No./ Note	Conducted Power (dBm)	Max. tune-up Power (dBm)	Measured SAR(10g) (W/kg)	Reported SAR(10g) (W/kg)	Measured SAR(1g) (W/kg)	Reported SAR(1g) (W/kg)	Power Drift (dB)
Ch.	MHz									
600	1880	Rear	Fig.12	23.60	25.00	0.448	0.62	0.747	1.03	-0.07

Note: The distance between the EUT and the phantom bottom is 15mm.

Table 14.2-13: SAR Values (CDMA BC10 Band - Head)

Ambient Temperature: 22.5 °C Liquid Temperature: 22.3°C											
Frequency		Side	Test Position	Figure No./ Note	Conducted Power (dBm)	Max. tune-up Power (dBm)	Measured SAR(10g) (W/kg)	Reported SAR(10g) (W/kg)	Measured SAR(1g) (W/kg)	Reported SAR(1g) (W/kg)	Power Drift (dB)
Ch.	MHz										
580	820.5	Right	Cheek	Fig.13	23.99	25.00	0.299	0.38	0.465	0.59	-0.06

Table 14.2-14: SAR Values (CDMA BC10 Band - Body)

Ambient Temperature: 22.5 °C Liquid Temperature: 22.3°C										
Frequency		Test Position	Figure No./ Note	Conducted Power (dBm)	Max. tune-up Power (dBm)	Measured SAR(10g) (W/kg)	Reported SAR(10g) (W/kg)	Measured SAR(1g) (W/kg)	Reported SAR(1g) (W/kg)	Power Drift (dB)
Ch.	MHz									
580	820.5	Rear	Fig.14	23.93	25.00	0.534	0.68	0.737	0.94	-0.15

Note: The distance between the EUT and the phantom bottom is 15mm

Table 14.2-15: SAR Values (LTE Band4 - Head)

Ambient Temperature: 22.5 °C Liquid Temperature: 22.3°C												
Frequency		Mode	Side	Test Position	Figure No./ Note	Conducted Power (dBm)	Max. tune-up Power (dBm)	Measured SAR(10g) (W/kg)	Reported SAR(10g) (W/kg)	Measured SAR(1g) (W/kg)	Reported SAR(1g) (W/kg)	Power Drift (dB)
Ch.	MHz											
20300	1745	50RB-Mid	Right	Cheek	Fig.15	22.33	23.00	0.209	0.24	0.341	0.40	0.17

Note1: The LTE mode is QPSK_20MHz.

Table 14.2-16: SAR Values (LTE Band4 - Body)

Ambient Temperature: 22.5 °C						Liquid Temperature: 22.3°C					
Frequency		Mode	Test Position	Figure No./ Note	Conducted Power (dBm)	Max. tune-up Power (dBm)	Measured SAR(10g) (W/kg)	Reported SAR(10g) (W/kg)	Measured SAR(1g) (W/kg)	Reported SAR(1g) (W/kg)	Power Drift (dB)
Ch.	MHz										
20300	1745	1RB-Mid	Rear	Fig.16	22.75	23.00	0.643	0.68	1.050	1.11	0.01

Note1: The distance between the EUT and the phantom bottom is 15mm.

Note2: The LTE mode is QPSK_20MHz.

Table 14.2-17: SAR Values (LTE Band13 - Head)

Ambient Temperature: 22.5 °C						Liquid Temperature: 22.3°C						
Frequency		Mode	Side	Test Position	Figure No./ Note	Conducted Power (dBm)	Max. tune-up Power (dBm)	Measured SAR(10g) (W/kg)	Reported SAR(10g) (W/kg)	Measured SAR(1g) (W/kg)	Reported SAR(1g) (W/kg)	Power Drift (dB)
Ch.	MHz											
23230	782	1RB-Mid	Right	Cheek	Fig.17	23.31	24.00	0.160	0.19	0.239	0.28	0.09

Note1: The LTE mode is QPSK_20MHz.

Table 14.2-18: SAR Values (LTE Band13 - Body)

Ambient Temperature: 22.5 °C						Liquid Temperature: 22.3°C					
Frequency		Mode	Test Position	Figure No./ Note	Conducted Power (dBm)	Max. tune-up Power (dBm)	Measured SAR(10g) (W/kg)	Reported SAR(10g) (W/kg)	Measured SAR(1g) (W/kg)	Reported SAR(1g) (W/kg)	Power Drift (dB)
Ch.	MHz										
23230	782	1RB-High	Rear	Fig.18	23.31	24.00	0.323	0.38	0.447	0.52	-0.06

Note1: The LTE mode is QPSK_20MHz.

Note2: The distance between the EUT and the phantom bottom is 15mm.

Table 14.2-19: SAR Values (LTE Band25 - Head)

Ambient Temperature: 22.5 °C						Liquid Temperature: 22.3°C						
Frequency		Mode	Side	Test Position	Figure No./ Note	Conducted Power (dBm)	Max. tune-up Power (dBm)	Measured SAR(10g) (W/kg)	Reported SAR(10g) (W/kg)	Measured SAR(1g) (W/kg)	Reported SAR(1g) (W/kg)	Power Drift (dB)
Ch.	MHz											
26365	1882.5	1RB-High	Left	Cheek	Fig.19	23.51	24.00	0.175	0.20	0.269	0.30	-0.08

Note1: The LTE mode is QPSK_20MHz.

Table 14.2-20: SAR Values (LTE Band26 - Body)

Ambient Temperature: 22.5 °C						Liquid Temperature: 22.3°C					
Frequency		Mode	Test Position	Figure No./ Note	Conduct ed Power (dBm)	Max. tune-up Power (dBm)	Measured SAR(10g) (W/kg)	Reported SAR(10g) (W/kg)	Measured SAR(1g) (W/kg)	Reported SAR(1g) (W/kg)	Power Drift (dB)
Ch.	MHz										
26365	1882.5	1RB-High	Rear	Fig.20	23.51	24.00	0.486	0.54	0.778	0.87	0.02

Note1: The distance between the EUT and the phantom bottom is 15mm.

Note2: The LTE mode is QPSK_20MHz.

Table 14.2-21: SAR Values (LTE Band26 - Head)

Ambient Temperature: 22.5 °C						Liquid Temperature: 22.3°C						
Frequency		Mode	Side	Test Position	Figure No./ Note	Conducte d Power (dBm)	Max. tune-up Power (dBm)	Measure d SAR(10g) (W/kg)	Reported SAR(10g) (W/kg)	Measure d SAR(1g) (W/kg)	Reported SAR(1g) (W/kg)	Power Drift (dB)
Ch.	MHz											
26965	841.5	1RB-Mid	Right	Cheek	Fig.21	23.28	24.00	0.314	0.37	0.490	0.58	0.15

Note1: The LTE mode is QPSK_15MHz.

Table 14.2-22: SAR Values (LTE Band26 - Body)

Ambient Temperature: 22.5 °C						Liquid Temperature: 22.3°C					
Frequency		Mode	Test Position	Figure No./ Note	Conduct ed Power (dBm)	Max. tune-up Power (dBm)	Measured SAR(10g) (W/kg)	Reported SAR(10g) (W/kg)	Measured SAR(1g) (W/kg)	Reported SAR(1g) (W/kg)	Power Drift (dB)
Ch.	MHz										
26965	841.5	1RB-Mid	Rear	Fig.22	23.28	24.00	0.503	0.59	0.678	0.80	-0.06

Note1: The distance between the EUT and the phantom bottom is 15mm.

Note2: The LTE mode is QPSK_15MHz.

Table 14.2-23: SAR Values (LTE Band41 PC3- Head)

Ambient Temperature: 22.5 °C						Liquid Temperature: 22.3°C						
Frequency		Mode	Side	Test Position	Figure No./ Note	Conducte d Power (dBm)	Max. tune-up Power (dBm)	Measure d SAR(10g) (W/kg)	Reported SAR(10g) (W/kg)	Measure d SAR(1g) (W/kg)	Reporte d SAR(1g) (W/kg)	Power Drift (dB)
Ch.	MHz											
40185	2549.5	1RB-Mid	Left	Cheek	Fig.23	23.97	24.00	0.341	0.34	0.702	0.71	-0.09

Note1: The LTE mode is QPSK_20MHz.

Table 14.2-24: SAR Values (LTE Band41 PC3- Body)

Ambient Temperature: 22.5 °C						Liquid Temperature: 22.3°C					
Frequency		Mode	Test Position	Figure No./ Note	Conducted Power (dBm)	Max. tune-up Power (dBm)	Measured SAR(10g) (W/kg)	Reported SAR(10g) (W/kg)	Measured SAR(1g) (W/kg)	Reported SAR(1g) (W/kg)	Power Drift (dB)
Ch.	MHz										
41490	2680	50RB-High	Rear	Fig.24	22.76	23.00	0.347	0.37	0.704	0.74	0.02

Note1: The LTE mode is QPSK_20MHz.

Note2: The distance between the EUT and the phantom bottom is 15mm.

Table 14.2-25: SAR Values (LTE Band41 PC2- Head)

Ambient Temperature: 22.5°C						Liquid Temperature: 22.3°C						
Frequency		Mode	Side	Test Position	Figure No./ Note	Conducted Power (dBm)	Max. tune-up Power (dBm)	Measured SAR(10g) (W/kg)	Reported SAR(10g) (W/kg)	Measured SAR(1g) (W/kg)	Reported SAR(1g) (W/kg)	Power Drift (dB)
Ch.	MHz											
40185	2549.5	1RB-Mid	Left	Cheek	Fig.25	24.89	25.00	0.333	0.34	0.672	0.69	0.02

Note: The LTE mode is QPSK_20MHz.

Table 14.2-2: SAR Values (LTE Band41 PC2- Body)

Ambient Temperature: 22.5 °C						Liquid Temperature: 22.3°C					
Frequency		Mode	Test Position	Figure No./ Note	Conducted Power (dBm)	Max. tune-up Power (dBm)	Measured SAR(10g) (W/kg)	Reported SAR(10g) (W/kg)	Measured SAR(1g) (W/kg)	Reported SAR(1g) (W/kg)	Power Drift (dB)
Ch.	MHz										
41490	2680	50RB-High	Rear	Fig.26	25.36	26.00	0.439	0.51	0.896	1.04	0.01

Note1: The LTE mode is QPSK_20MHz.

Note2: The distance between the EUT and the phantom bottom is 15mm.

14.2 14.3 WLAN Evaluation for 2.4G

According to the KDB248227 D01, SAR is measured for 2.4GHz 802.11b DSSS using the initial test position procedure.

Head Evaluation

Table 14.3-1: SAR Values (WLAN - Head)– 802.11b (Fast SAR)

Frequency		Side	Test Position	Figure No./ Note	Conducte d Power (dBm)	Max. tune-up Power (dBm)	Measured SAR(10g) (W/kg)	Reported SAR(10g) (W/kg)	Measured SAR(1g) (W/kg)	Reported SAR(1g)(W/kg)	Power Drift (dB)
MHz	Ch.										
2412	1	Left	Cheek	/	17.37	18	0.326	0.38	0.643	0.74	-0.11
2412	1	Left	Tilt	/	17.37	18	0.044	0.05	0.078	0.09	-0.09
2412	1	Right	Cheek	/	17.37	18	0.397	0.46	0.740	0.86	-0.07
2412	1	Right	Tilt	/	17.37	18	0.043	0.05	0.071	0.08	0.07

As shown above table, the initial test position for head is “Right Touch”. So the head SAR of WLAN is presented as below:

Table 14.3-2: SAR Values (WLAN - Head)– 802.11b (Full SAR)

Frequency		Side	Test Position	Figure No./ Note	Conducte d Power (dBm)	Max. tune-up Power (dBm)	Measured SAR(10g) (W/kg)	Reported SAR(10g) (W/kg)	Measured SAR(1g) (W/kg)	Reported SAR(1g)(W/kg)	Power Drift (dB)
MHz	Ch.										
2412	1	Right	Cheek	Fig.27	17.37	18	0.403	0.47	0.752	0.87	0.08
2462	11	Right	Cheek	/	17.28	18	0.357	0.42	0.659	0.78	-0.1

Note1: When the reported SAR of the initial test position is > 0.4 W/kg, SAR is repeated for the 802.11 transmission mode configuration tested in the initial test position using subsequent highest estimated 1-g SAR conditions determined by area scans, on the highest maximum output power channel, until the reported SAR is \leq 0.8 W/kg.

Note2: For all positions/configurations tested using the initial test position and subsequent test positions, when the reported SAR is > 0.8 W/kg, SAR is measured for these test positions/configurations on the subsequent next highest measured output power channel until the reported SAR is \leq 1.2 W/kg or all required channels are tested.

According to the KDB248227 D01, The reported SAR must be scaled to 100% transmission duty factor to determine compliance at the maximum tune-up tolerance limit. The scaled reported SAR is presented as below.

Table 14.3-3: SAR Values (WLAN - Head) – 802.11b (Scaled Reported SAR)

Frequency		Side	Test Position	Actual duty factor	maximum duty factor	Reported SAR (1g)(W/kg)	Scaled reported SAR (1g)(W/kg)
MHz	Ch.						
2412	1	Right	Cheek	100%	100%	0.87	0.87

SAR is not required for OFDM because the 802.11b adjusted SAR \leq 1.2 W/kg.



Body Evaluation

Table 14.3-4: SAR Values (WLAN - Body)– 802.11b (Fast SAR)

Frequency		Test Position	Figure No./ Note	Conducted Power (dBm)	Max. tune-up Power (dBm)	Measured SAR(10g) (W/kg)	Reported SAR(10g) (W/kg)	Measured SAR(1g) (W/kg)	Reported SAR(1g)(W/kg)	Power Drift (dB)
MHz	Ch.									
		Ambient Temperature: 22.5 °C				Liquid Temperature: 22.3°C				
2412	1	Front	/	19.08	19.5	0.056	0.06	0.031	0.03	0.07
2412	1	Rear	/	19.08	19.5	0.061	0.07	0.089	0.10	0.11
2412	1	Rear unfold	/	19.08	19.5	0.075	0.08	0.136	0.15	-0.09

As shown above table, the initial test position for body is “Rear unfold”. So the body SAR of WLAN is presented as below:

Table 14.3-5: SAR Values (WLAN - Body)– 802.11b (Full SAR)

Frequency		Test Position	Figure No./ Note	Conducted Power (dBm)	Max. tune-up Power (dBm)	Measured SAR(10g) (W/kg)	Reported SAR(10g) (W/kg)	Measured SAR(1g) (W/kg)	Reported SAR(1g)(W/kg)	Power Drift (dB)
MHz	Ch.									
		Ambient Temperature: 22.5 °C				Liquid Temperature: 22.3°C				
2412	1	Rear unfold	Fig.28	19.08	19.5	0.081	0.09	0.14	0.15	0.07

Note1: When the reported SAR of the initial test position is > 0.4 W/kg, SAR is repeated for the 802.11 transmission mode configuration tested in the initial test position using subsequent highest estimated 1-g SAR conditions determined by area scans, on the highest maximum output power channel, until the reported SAR is ≤ 0.8 W/kg.

Note2: For all positions/configurations tested using the initial test position and subsequent test positions, when the reported SAR is > 0.8 W/kg, SAR is measured for these test positions/configurations on the subsequent next highest measured output power channel until the reported SAR is ≤ 1.2 W/kg or all required channels are tested.

According to the KDB248227 D01, The reported SAR must be scaled to 100% transmission duty factor to determine compliance at the maximum tune-up tolerance limit. The scaled reported SAR is presented as below.

Table 14.3-6: SAR Values (WLAN - Body) – 802.11b (Scaled Reported SAR)

Frequency		Test Position	Actual duty factor	maximum duty factor	Reported SAR (1g)(W/kg)	Scaled reported SAR (1g)(W/kg)
MHz	Ch.					
		Ambient Temperature: 22.5 °C				Liquid Temperature: 22.3°C
2412	1	Rear unfold	100%	100%	0.15	0.15

SAR is not required for OFDM because the 802.11b adjusted SAR ≤ 1.2 W/kg.

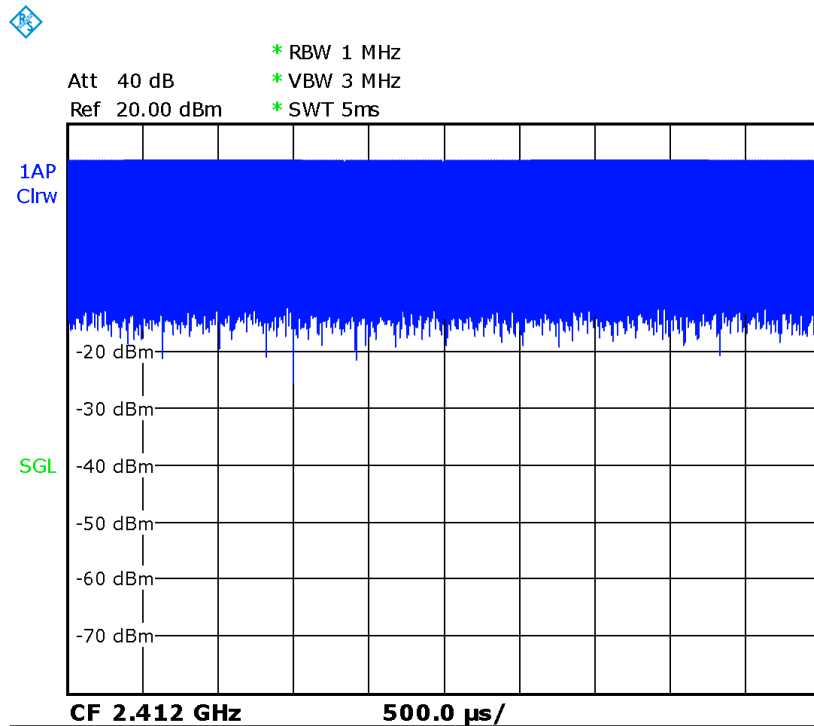

Picture 14.1 Duty factor plot CH1

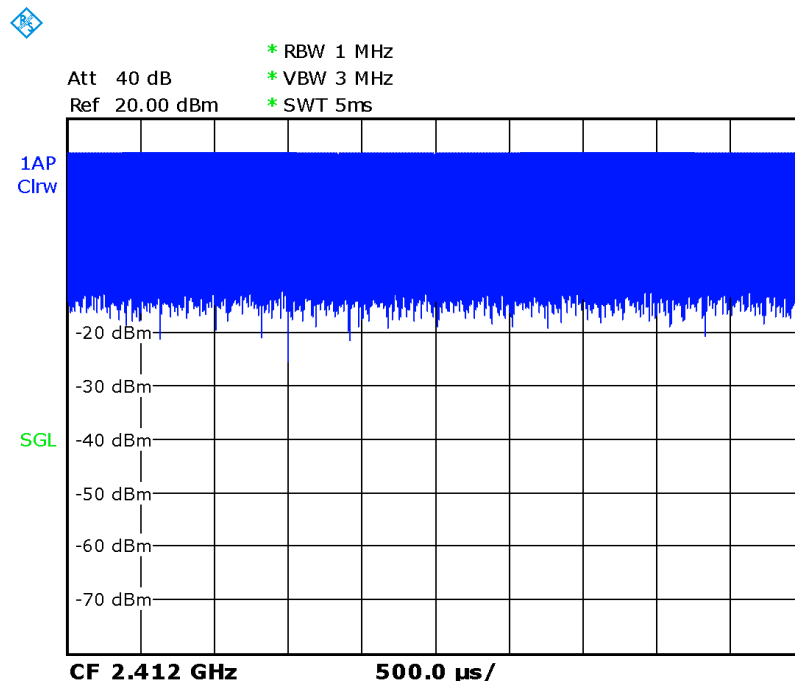

Picture 14.2 Duty factor plot CH1

14.3 14.4 WLAN Evaluation For 5G

Table 14.4-1: OFDM mode specified maximum output power of WLAN antenna

802.11 mode	a	g	n		ac			
Ch. BW(MHz)	20	20	20	40	20	40	80	160
U-NII-1	X		X	X				
U-NII-2A								
U-NII-2C								
U-NII-3	X		X	X				
§ 15.247 (5.8 GHz)								

X: maximum(conducted) output power(mW), including tolerance, specified for production units

Table 14.4-2: Maximum output power specified of WLAN antenna - Head

802.11 mode	a	g	n		ac			
Ch. BW(MHz)	20	20	20	40	20	40	80	160
U-NII-1	20		16	13				
U-NII-2A								
U-NII-2C								
U-NII-3	25		25	18				
§ 15.247 (5.8 GHz)								

- The maximum output power specified for production units is the same for all channels, modulations and data rates in each channel bandwidth configuration of the 802.11a/g/n/ac modes.
- The blue highlighted cells represent highest output configurations in each standalone or aggregated frequency band, with tune-up tolerance included.

Table 14.4-3: Maximum output power specified of WLAN antenna - Body

802.11 mode	a	g	n		ac			
Ch. BW(MHz)	20	20	20	40	20	40	80	160
U-NII-1	50		32	40				
U-NII-2A								
U-NII-2C								
U-NII-3	56		45	40				
§ 15.247 (5.8 GHz)								

- The maximum output power specified for production units is the same for all channels, modulations and data rates in each channel bandwidth configuration of the 802.11a/g/n/ac modes.
- The blue highlighted cells represent highest output configurations in each standalone or aggregated frequency band, with tune-up tolerance included.

Table 14.4-4: Maximum output power measured of WLAN antenna, for the applicable OFDM configurations according to the default power measurement procedures for selection initial test configurations - Head

802.11 mode	a	n		ac		
BW(MHz)	20	20	40	20	40	80
U-NII-1	36 /40/44/48 15 /14/14/14	36/40/44/48 Lower power	38/46 Lower power	/	/	/
U-NII-3	149/153/157/161/ 165 16 /16/16/20/22	149/153/157/16 1/165 Lower power	151/159 Lower power	/	/	/

- The **bold numbers** is the maximum output measured power (mW).
- Channels with measured maximum power within 0.25dB are considered to have the same measured output. Channels selected for initial test configuration are **highlighted in yellow**.

Table 14.4-5: Maximum output power measured of WLAN antenna, for the applicable OFDM configurations according to the default power measurement procedures for selection initial test configurations - Body

802.11 mode	a	n		ac		
BW(MHz)	20	20	40	20	40	80
U-NII-1	36/ 40 /44/48 37 / 39 /38/37	36/40/44/48 Lower power	38/46 Lower power	/	/	/
U-NII-3	149/153/157/161/ 165 42 /41/42/43/49	149/153/157/16 1/165 Lower power	151/159 Lower power	/	/	/

- The **bold numbers** is the maximum output measured power (mW).
- Channels with measured maximum power within 0.25dB are considered to have the same measured output. Channels selected for initial test configuration are **highlighted in yellow**.

Table 14.4-6: Reported SAR of initial test configuration for Head

802.11 mode	a	n		ac		
BW(MHz)	20	20	40	20	40	80
U-NII-2A	36 /40/44/48 0.30	52/56/60/64	54/62	/	/	/
U-NII-3	149/153/157/161/ 165 0.51	149/153/157/161/165	151/159	/	/	/

Highest measured output power channel tested initially are in **yellow highlight**.

Table 14.4-7: Reported SAR of initial test configuration for Body – 15mm

802.11 mode	a	n		ac		
BW(MHz)	20	20	40	20	40	80
U-NII-2A	36/40/44/48 0.15	52/56/60/64	54/62	/	/	/
U-NII-3	149/153/157/161/165 0.31	149/153/157/161/165	151/159	/	/	/

Highest measured output power channel tested initially are in yellow highlight.

Table 14.4-9: SAR Values (WLAN 5G - Head)

Frequency		Side	Test Position	Figure No.	Conducted Power (dBm)	Max. tune-up Power (dBm)	Measured SAR(10g) (W/kg)	Reported SAR(10g) (W/kg)	Measured SAR(1g) (W/kg)	Reported SAR(1g) (W/kg)	Power Drift (dB)
Ch.	MHz										
36	5180	Left	Cheek	/	11.79	13	0.072	0.10	0.207	0.27	0.11
36	5180	Left	Tilt	/	11.79	13	0.027	0.04	0.039	0.05	-0.09
36	5180	Right	Cheek	/	11.79	13	0.068	0.09	0.203	0.27	0.12
36	5180	Right	Tilt	/	11.79	13	0.018	0.02	0.048	0.06	-0.10
165	5825	Left	Cheek	/	13.44	14	0.066	0.08	0.204	0.23	-0.04
165	5825	Left	Tilt	/	13.44	14	0.034	0.04	0.067	0.08	0.01
165	5825	Right	Cheek	Fig.29	13.44	14	0.128	0.15	0.447	0.51	0.08
165	5825	Right	Tilt	/	13.44	14	0.075	0.09	0.118	0.13	-0.05

Table 14.4-10: SAR Values (WLAN 5G - Body)

Frequency		Test Position	Figure No.	Conducted Power (dBm)	Max. tune-up Power (dBm)	Measured SAR(10g) (W/kg)	Reported SAR(10g) (W/kg)	Measured SAR(1g) (W/kg)	Reported SAR(1g) (W/kg)	Power Drift (dB)
Ch.	MHz									
40	5200	Front	/	15.89	17	0.037	0.05	0.054	0.07	0.10
40	5200	Rear	/	15.89	17	0.035	0.05	0.101	0.13	-0.02
40	5200	Rear unfold	/	15.89	17	0.044	0.06	0.099	0.13	0.08
165	5825	Front	/	16.94	17.5	0.049	0.06	0.065	0.07	0.06
165	5825	Rear	Fig.30	16.94	17.5	0.103	0.12	0.277	0.31	0.10
165	5825	Rear unfold	/	16.94	17.5	0.067	0.08	0.182	0.21	0.05

Note1: The distance between the EUT and the phantom bottom is 15mm.

According to the KDB248227 D01, The reported SAR must be scaled to 100% transmission duty factor to determine compliance at the maximum tune-up tolerance limit. The scaled reported SAR is presented as below.

Table 14.4-12: SAR Values (WLAN 5G - Head) (Scaled Reported SAR)

Frequency		Side	Test Position	Actual duty factor	maximum duty factor	Reported SAR (1g) (W/kg)	Scaled reported SAR (1g) (W/kg)
Ch.	MHz						
165	5825	Right	Touch	100%	100%	0.51	0.51

Table 14.4-13 SAR Values (WLAN 5G - Body) (Scaled Reported SAR)

Frequency		Test Position	D (mm)	Actual duty factor	maximum duty factor	Reported SAR (1g) (W/kg)	Scaled reported SAR (1g) (W/kg)
Ch.	MHz						
165	5825	Rear	15	100%	100%	0.31	0.31

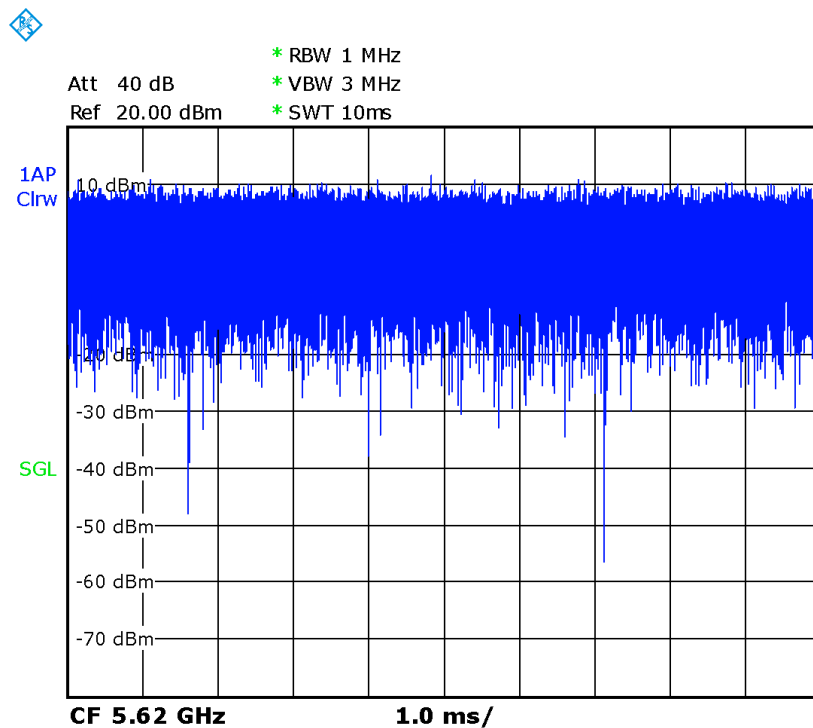

Picture 14.4 The plot of duty factor for Head

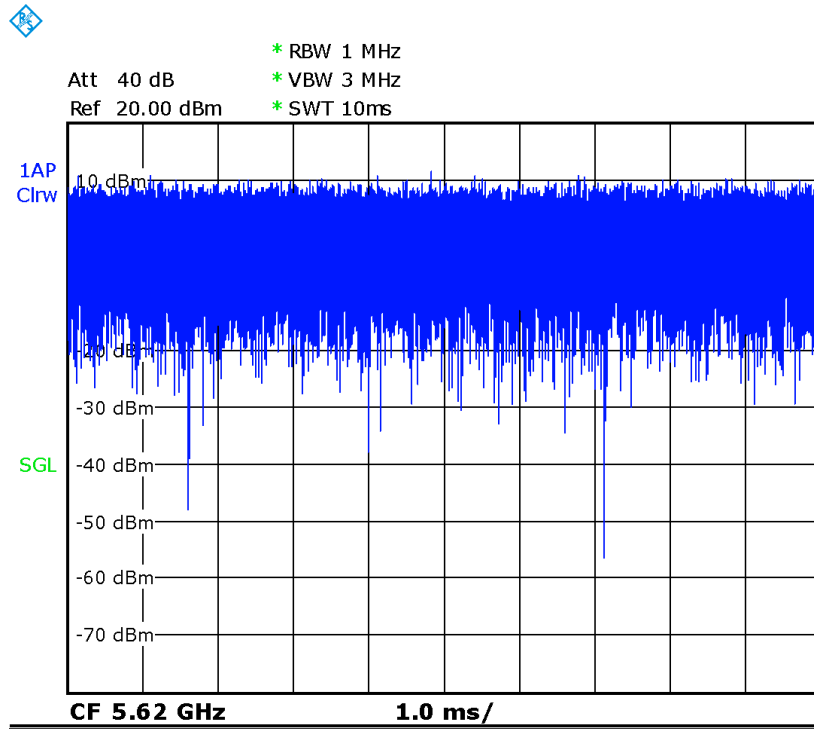

Picture 14.5 The plot of duty factor for Body

15 SAR Measurement Variability

SAR measurement variability must be assessed for each frequency band, which is determined by the SAR probe calibration point and tissue-equivalent medium used for the device measurements. When both head and body tissue-equivalent media are required for SAR measurements in a frequency band, the variability measurement procedures should be applied to the tissue medium with the highest measured SAR, using the highest measured SAR configuration for that tissue-equivalent medium.

The following procedures are applied to determine if repeated measurements are required.

- 1) Repeated measurement is not required when the original highest measured SAR is < 0.80 W/kg; steps 2) through 4) do not apply.
- 2) When the original highest measured SAR is ≥ 0.80 W/kg, repeat that measurement once.
- 3) Perform a second repeated measurement only if the ratio of largest to smallest SAR for the original and first repeated measurements is > 1.20 or when the original or repeated measurement is ≥ 1.45 W/kg (~ 10% from the 1-g SAR limit).
- 4) Perform a third repeated measurement only if the original, first or second repeated measurement is ≥ 1.5 W/kg and the ratio of largest to smallest SAR for the original, first and second repeated measurements is > 1.20 .

Table 14.1: SAR Measurement Variability for Body WCDMA1900 (1g)

Frequency		Test Position	Spacing (mm)	Original SAR (W/kg)	First Repeated SAR (W/kg)	The Ratio	Second Repeated SAR (W/kg)
Ch.	MHz						
9538	1907.6	Rear	15	0.830	0.822	1.01	/
9262	1852.4	Rear	15	0.858	0.846	1.01	/

Table 14.2: SAR Measurement Variability for Head LTEB4 (1g)

Frequency		Test Position	Original SAR (W/kg)	First Repeated SAR (W/kg)	The Ratio	Second Repeated SAR (W/kg)
Ch.	MHz					
20300	1745	Rear	1.050	0.993	1.06	/
20175	1732.5	Rear	0.989	0.970	1.02	/
20050	1720	Rear	0.909	0.889	1.02	/
20300	1745	Rear unfold	0.862	0.853	1.01	/
20050	1720	Rear	0.837	0.822	1.02	/
20300	1745	Rear	1.020	0.990	1.03	/
20175	1732.5	Rear	0.974	0.960	1.01	/
20050	1720	Rear	0.965	0.948	1.02	/
20300	1745	Rear unfold	0.858	0.837	1.03	/
20300	1745	Rear	0.995	0.975	1.02	/
20300	1745	Rear unfold	0.862	0.846	1.02	/

Table 14.3: SAR Measurement Variability for Body LTEB41 (1g)

Frequency		Test Position	Original SAR (W/kg)	First Repeated SAR (W/kg)	The Ratio	Second Repeated SAR (W/kg)
Ch.	MHz					
25.36	26.00	Rear	0.896	0.871	1.03	/
41490	2680	Rear	0.888	0.860	1.03	/

16 Measurement Uncertainty

16.1 Measurement Uncertainty for Normal SAR Tests (300MHz~3GHz)

No.	Error Description	Type	Uncertainty value	Probably Distribution	Div.	(Ci) 1g	(Ci) 10g	Std. Unc. (1g)	Std. Unc. (10g)	Degree of freedom
Measurement system										
1	Probe calibration	B	6.0	N	1	1	1	6.0	6.0	∞
2	Isotropy	B	4.7	R	$\sqrt{3}$	0.7	0.7	1.9	1.9	∞
3	Boundary effect	B	1.0	R	$\sqrt{3}$	1	1	0.6	0.6	∞
4	Linearity	B	4.7	R	$\sqrt{3}$	1	1	2.7	2.7	∞
5	Detection limit	B	1.0	N	1	1	1	0.6	0.6	∞
6	Readout electronics	B	0.3	R	$\sqrt{3}$	1	1	0.3	0.3	∞
7	Response time	B	0.8	R	$\sqrt{3}$	1	1	0.5	0.5	∞
8	Integration time	B	2.6	R	$\sqrt{3}$	1	1	1.5	1.5	∞
9	RF ambient conditions-noise	B	0	R	$\sqrt{3}$	1	1	0	0	∞
10	RFambient conditions-reflection	B	0	R	$\sqrt{3}$	1	1	0	0	∞
11	Probe positioned mech. restrictions	B	0.4	R	$\sqrt{3}$	1	1	0.2	0.2	∞
12	Probe positioning with respect to phantom shell	B	2.9	R	$\sqrt{3}$	1	1	1.7	1.7	∞
13	Post-processing	B	1.0	R	$\sqrt{3}$	1	1	0.6	0.6	∞
Test sample related										
14	Test sample positioning	A	3.3	N	1	1	1	3.3	3.3	71
15	Device holder uncertainty	A	3.4	N	1	1	1	3.4	3.4	5
16	Drift of output power	B	5.0	R	$\sqrt{3}$	1	1	2.9	2.9	∞
Phantom and set-up										
17	Phantom uncertainty	B	4.0	R	$\sqrt{3}$	1	1	2.3	2.3	∞
18	Liquid conductivity (target)	B	5.0	R	$\sqrt{3}$	0.64	0.43	1.8	1.2	∞
19	Liquid conductivity (meas.)	A	2.06	N	1	0.64	0.43	1.32	0.89	43
20	Liquid permittivity (target)	B	5.0	R	$\sqrt{3}$	0.6	0.49	1.7	1.4	∞
21	Liquid permittivity (meas.)	A	1.6	N	1	0.6	0.49	1.0	0.8	521

Combined standard uncertainty	$u_c = \sqrt{\sum_{i=1}^{21} c_i^2 u_i^2}$							9.55	9.43	257
Expanded uncertainty (confidence interval of 95 %)	$u_e = 2u_c$							19.1	18.9	

16.2 Measurement Uncertainty for Normal SAR Tests (3~6GHz)

No.	Error Description	Type	Uncertainty value	Probably Distribution	Div.	(Ci) 1g	(Ci) 10g	Std. Unc. (1g)	Std. Unc. (10g)	Degree of freedom
Measurement system										
1	Probe calibration	B	6.55	N	1	1	1	6.55	6.55	∞
2	Isotropy	B	4.7	R	$\sqrt{3}$	0.7	0.7	1.9	1.9	∞
3	Boundary effect	B	2.0	R	$\sqrt{3}$	1	1	1.2	1.2	∞
4	Linearity	B	4.7	R	$\sqrt{3}$	1	1	2.7	2.7	∞
5	Detection limit	B	1.0	R	$\sqrt{3}$	1	1	0.6	0.6	∞
6	Readout electronics	B	0.3	R	$\sqrt{3}$	1	1	0.3	0.3	∞
7	Response time	B	0.8	R	$\sqrt{3}$	1	1	0.5	0.5	∞
8	Integration time	B	2.6	R	$\sqrt{3}$	1	1	1.5	1.5	∞
9	RF ambient conditions-noise	B	0	R	$\sqrt{3}$	1	1	0	0	∞
10	RF ambient conditions-reflection	B	0	R	$\sqrt{3}$	1	1	0	0	∞
11	Probe positioned mech. restrictions	B	0.8	R	$\sqrt{3}$	1	1	0.5	0.5	∞
12	Probe positioning with respect to phantom shell	B	6.7	R	$\sqrt{3}$	1	1	3.9	3.9	∞
13	Post-processing	B	4.0	R	$\sqrt{3}$	1	1	2.3	2.3	∞
Test sample related										
14	Test sample positioning	A	3.3	N	1	1	1	3.3	3.3	71
15	Device holder uncertainty	A	3.4	N	1	1	1	3.4	3.4	5
16	Drift of output power	B	5.0	R	$\sqrt{3}$	1	1	2.9	2.9	∞
Phantom and set-up										
17	Phantom uncertainty	B	4.0	R	$\sqrt{3}$	1	1	2.3	2.3	∞
18	Liquid conductivity (target)	B	5.0	R	$\sqrt{3}$	0.64	0.43	1.8	1.2	∞
19	Liquid conductivity (meas.)	A	2.06	N	1	0.64	0.43	1.32	0.89	43
20	Liquid permittivity	B	5.0	R	$\sqrt{3}$	0.6	0.49	1.7	1.4	∞

	(target)									
21	Liquid permittivity (meas.)	A	1.6	N	1	0.6	0.49	1.0	0.8	521
Combined standard uncertainty		$u_c = \sqrt{\sum_{i=1}^{21} c_i^2 u_i^2}$						10.7	10.6	257
Expanded uncertainty (confidence interval of 95 %)		$u_e = 2u_c$						21.4	21.1	

16.3 Measurement Uncertainty for Fast SAR Tests (300MHz~3GHz)

No.	Error Description	Type	Uncertainty value	Probably Distribution	Div.	(Ci) 1g	(Ci) 10g	Std. Unc. (1g)	Std. Unc. (10g)	Degree of freedom
Measurement system										
1	Probe calibration	B	6.0	N	1	1	1	6.0	6.0	∞
2	Isotropy	B	4.7	R	$\sqrt{3}$	0.7	0.7	1.9	1.9	∞
3	Boundary effect	B	1.0	R	$\sqrt{3}$	1	1	0.6	0.6	∞
4	Linearity	B	4.7	R	$\sqrt{3}$	1	1	2.7	2.7	∞
5	Detection limit	B	1.0	R	$\sqrt{3}$	1	1	0.6	0.6	∞
6	Readout electronics	B	0.3	R	$\sqrt{3}$	1	1	0.3	0.3	∞
7	Response time	B	0.8	R	$\sqrt{3}$	1	1	0.5	0.5	∞
8	Integration time	B	2.6	R	$\sqrt{3}$	1	1	1.5	1.5	∞
9	RF ambient conditions-noise	B	0	R	$\sqrt{3}$	1	1	0	0	∞
10	RF ambient conditions-reflection	B	0	R	$\sqrt{3}$	1	1	0	0	∞
11	Probe positioned mech. Restrictions	B	0.4	R	$\sqrt{3}$	1	1	0.2	0.2	∞
12	Probe positioning with respect to phantom shell	B	2.9	R	$\sqrt{3}$	1	1	1.7	1.7	∞
13	Post-processing	B	1.0	R	$\sqrt{3}$	1	1	0.6	0.6	∞
14	Fast SAR z-Approximation	B	7.0	R	$\sqrt{3}$	1	1	4.0	4.0	∞
Test sample related										
15	Test sample positioning	A	3.3	N	1	1	1	3.3	3.3	71
16	Device holder uncertainty	A	3.4	N	1	1	1	3.4	3.4	5
17	Drift of output power	B	5.0	R	$\sqrt{3}$	1	1	2.9	2.9	∞
Phantom and set-up										
18	Phantom uncertainty	B	4.0	R	$\sqrt{3}$	1	1	2.3	2.3	∞

19	Liquid conductivity (target)	B	5.0	R	$\sqrt{3}$	0.64	0.43	1.8	1.2	∞
20	Liquid conductivity (meas.)	A	2.06	N	1	0.64	0.43	1.32	0.89	43
21	Liquid permittivity (target)	B	5.0	R	$\sqrt{3}$	0.6	0.49	1.7	1.4	∞
22	Liquid permittivity (meas.)	A	1.6	N	1	0.6	0.49	1.0	0.8	521
Combined standard uncertainty		$u_c = \sqrt{\sum_{i=1}^{22} c_i^2 u_i^2}$						10.4	10.3	257
Expanded uncertainty (confidence interval of 95 %)		$u_e = 2u_c$						20.8	20.6	

16.4 Measurement Uncertainty for Fast SAR Tests (3~6GHz)

No.	Error Description	Type	Uncertainty value	Probably Distribution	Div.	(Ci) 1g	(Ci) 10g	Std. Unc. (1g)	Std. Unc. (10g)	Degree of freedom
Measurement system										
1	Probe calibration	B	6.55	N	1	1	1	6.55	6.55	∞
2	Isotropy	B	4.7	R	$\sqrt{3}$	0.7	0.7	1.9	1.9	∞
3	Boundary effect	B	2.0	R	$\sqrt{3}$	1	1	1.2	1.2	∞
4	Linearity	B	4.7	R	$\sqrt{3}$	1	1	2.7	2.7	∞
5	Detection limit	B	1.0	R	$\sqrt{3}$	1	1	0.6	0.6	∞
6	Readout electronics	B	0.3	R	$\sqrt{3}$	1	1	0.3	0.3	∞
7	Response time	B	0.8	R	$\sqrt{3}$	1	1	0.5	0.5	∞
8	Integration time	B	2.6	R	$\sqrt{3}$	1	1	1.5	1.5	∞
9	RF ambient conditions-noise	B	0	R	$\sqrt{3}$	1	1	0	0	∞
10	RF ambient conditions-reflection	B	0	R	$\sqrt{3}$	1	1	0	0	∞
11	Probe positioned mech. Restrictions	B	0.8	R	$\sqrt{3}$	1	1	0.5	0.5	∞
12	Probe positioning with respect to phantom shell	B	6.7	R	$\sqrt{3}$	1	1	3.9	3.9	∞
13	Post-processing	B	1.0	R	$\sqrt{3}$	1	1	0.6	0.6	∞
14	Fast SAR z-Approximation	B	14.0	R	$\sqrt{3}$	1	1	8.1	8.1	∞
Test sample related										
15	Test sample positioning	A	3.3	N	1	1	1	3.3	3.3	71

16	Device holder uncertainty	A	3.4	N	1	1	1	3.4	3.4	5
17	Drift of output power	B	5.0	R	$\sqrt{3}$	1	1	2.9	2.9	∞
Phantom and set-up										
18	Phantom uncertainty	B	4.0	R	$\sqrt{3}$	1	1	2.3	2.3	∞
19	Liquid conductivity (target)	B	5.0	R	$\sqrt{3}$	0.64	0.43	1.8	1.2	∞
20	Liquid conductivity (meas.)	A	2.06	N	1	0.64	0.43	1.32	0.89	43
21	Liquid permittivity (target)	B	5.0	R	$\sqrt{3}$	0.6	0.49	1.7	1.4	∞
22	Liquid permittivity (meas.)	A	1.6	N	1	0.6	0.49	1.0	0.8	521
Combined standard uncertainty		$u_c = \sqrt{\sum_{i=1}^{22} c_i^2 u_i^2}$						13.5	13.4	257
Expanded uncertainty (confidence interval of 95 %)		$u_e = 2u_c$						27.0	26.8	

17 MAIN TEST INSTRUMENTS

Table 17.1: List of Main Instruments

No.	Name	Type	Serial Number	Calibration Date	Valid Period
01	Network analyzer	N5239A	MY46110673	January 24, 2019	One year
02	Power meter	NRVD	102083	October 24, 2018	One year
03	Power sensor	NRV-Z5	100542		
04	Signal Generator	E4438C	MY49070393	January 4, 2019	One Year
05	Amplifier	60S1G4	0331848	No Calibration Requested	
06	Directional Coupler	778D	MY48220584	No Calibration Requested	
07	Directional Coupler	772D	MY46151265	No Calibration Requested	
08	BTS	E5515C	MY50263375	January 17, 2019	One year
09	BTS	CMW500	159890	January 3, 2019	One year
10	E-field Probe	SPEAG EX3DV4	3617	January 31, 2019	One year
11	DAE	SPEAG DAE4	771	January 11, 2019	One year
12	Dipole Validation Kit	SPEAG D750V3	1017	July 18, 2019	One year
13	Dipole Validation Kit	SPEAG D835V2	4d069	July 19, 2019	One year
14	Dipole Validation Kit	SPEAG D1750V2	1003	July 16, 2019	One year
15	Dipole Validation Kit	SPEAG D1900V2	5d101	July 17, 2019	One year
16	Dipole Validation Kit	SPEAG D2450V2	853	July 17, 2019	One year
17	Dipole Validation Kit	SPEAG D2600V2	1012	July 17, 2019	One year
18	Dipole Validation Kit	SPEAG D5GHzV2	1060	July 22, 2019	One year

END OF REPORT BODY

ANNEX A Graph Results

GSM850_CH190 Right Cheek

Date: 8/3/2019

Electronics: DAE4 Sn771

Medium: head 835 MHz

Medium parameters used: $f = 836.6$; $\sigma = 0.886$ mho/m; $\epsilon_r = 41.45$; $\rho = 1000$ kg/m³

Ambient Temperature: 22.5°C, Liquid Temperature: 22.3°C

Communication System: GSM850 836.6 Duty Cycle: 1:8.3

Probe: EX3DV4 – SN3617 ConvF(9.75,9.75,9.75)

Area Scan (71x121x1): Interpolated grid: dx=1.000 mm, dy=1.000 mm

Maximum value of SAR (interpolated) = 0.607 W/kg

Zoom Scan (7x7x7)/Cube 0: Measurement grid: dx=5mm, dy=5mm, dz=5mm

Reference Value = 4.762 V/m; Power Drift = 0.19 dB

Peak SAR (extrapolated) = 0.715 W/kg

SAR(1 g) = 0.423 W/kg; SAR(10 g) = 0.273 W/kg

Maximum value of SAR (measured) = 0.61 W/kg

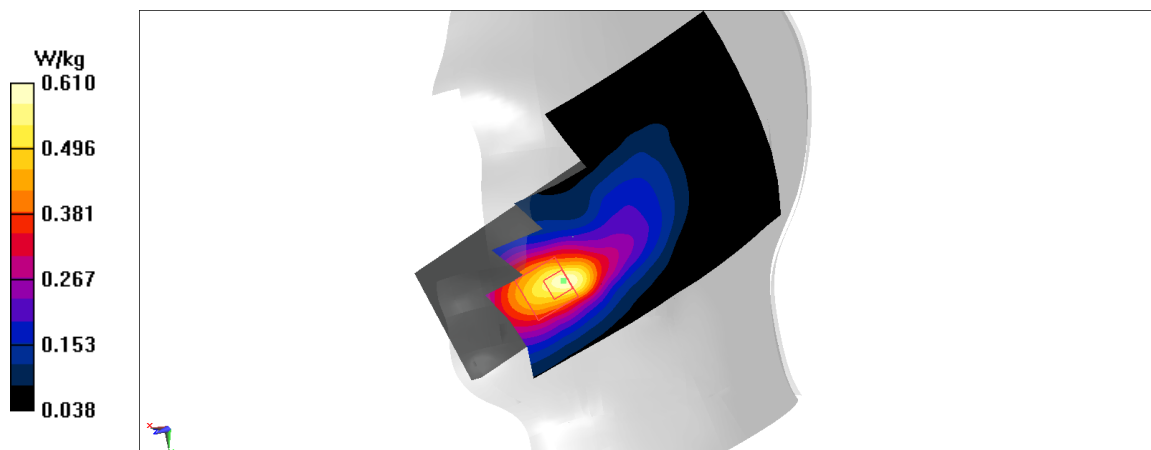

Fig A.1

GSM850_CH251 Rear

Date: 8/3/2019

Electronics: DAE4 Sn771

Medium: body 835 MHz

Medium parameters used: $f = 848.8$; $\sigma = 0.987$ mho/m; $\epsilon_r = 54.73$; $\rho = 1000$ kg/m³

Ambient Temperature: 22.5°C, Liquid Temperature: 22.3°C

Communication System: GSM850 848.8 Duty Cycle: 1:2.67

Probe: EX3DV4 – SN3617 ConvF(9.61,9.61,9.61)

Area Scan (71x121x1): Interpolated grid: dx=1.000 mm, dy=1.000 mm

Maximum value of SAR (interpolated) = 0.692 W/kg

Zoom Scan (7x7x7)/Cube 0: Measurement grid: dx=5mm, dy=5mm, dz=5mm

Reference Value = 22.14 V/m; Power Drift = -0.08 dB

Peak SAR (extrapolated) = 0.741 W/kg

SAR(1 g) = 0.569 W/kg; SAR(10 g) = 0.422 W/kg

Maximum value of SAR (measured) = 0.665 W/kg

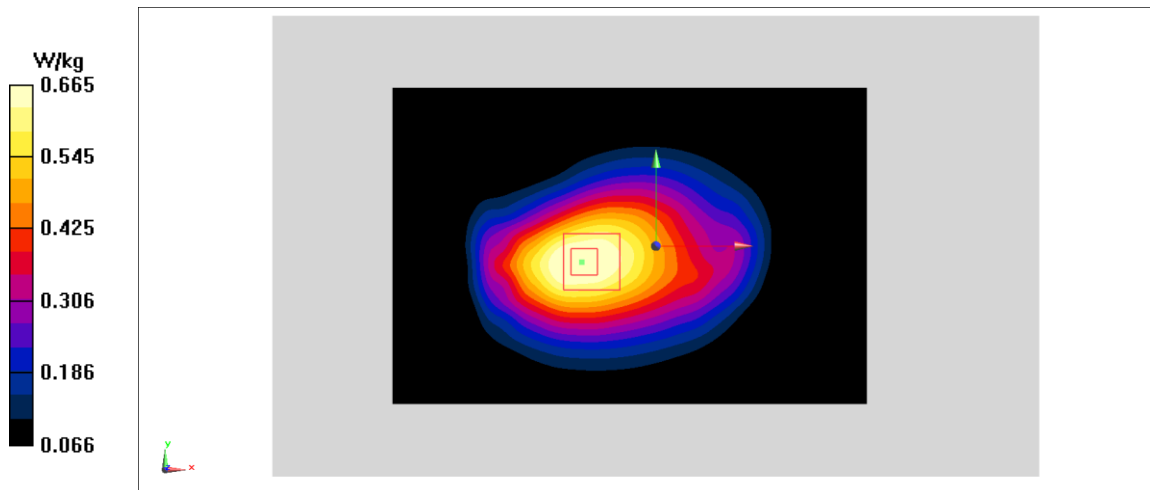

Fig A.2

PCS1900_CH512 Left Cheek

Date: 8/5/2019

Electronics: DAE4 Sn771

Medium: head 1900 MHz

Medium parameters used: $f = 1850.2$; $\sigma = 1.334$ mho/m; $\epsilon_r = 39.39$; $\rho = 1000$ kg/m³

Ambient Temperature: 22.5°C, Liquid Temperature: 22.3°C

Communication System: PCS1900 1850.2 Duty Cycle: 1:8.3

Probe: EX3DV4 – SN3617 ConvF(8.14,8.14,8.14)

Area Scan (71x121x1): Interpolated grid: dx=1.000 mm, dy=1.000 mm

Maximum value of SAR (interpolated) = 0.214 W/kg

Zoom Scan (7x7x7)/Cube 0: Measurement grid: dx=5mm, dy=5mm, dz=5mm

Reference Value = 2.438 V/m; Power Drift = 0.01 dB

Peak SAR (extrapolated) = 0.241 W/kg

SAR(1 g) = 0.157 W/kg; SAR(10 g) = 0.109 W/kg

Maximum value of SAR (measured) = 0.207 W/kg

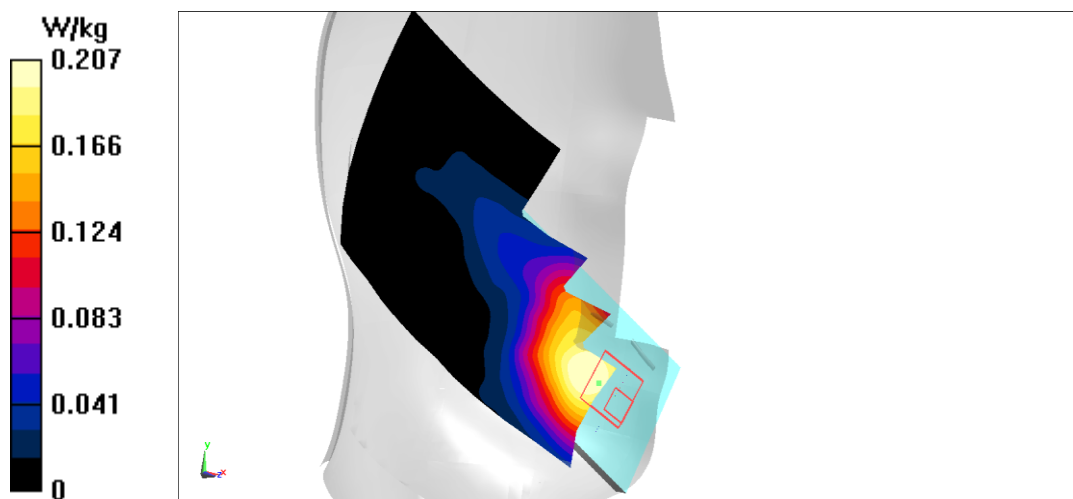

Fig A.2

PCS1900_CH661 Rear

Date: 8/5/2019

Electronics: DAE4 Sn771

Medium: body 1900 MHz

Medium parameters used: $f = 1880$; $\sigma = 1.506$ mho/m; $\epsilon_r = 53.23$; $\rho = 1000$ kg/m³

Ambient Temperature: 22.5°C, Liquid Temperature: 22.3°C

Communication System: PCS1900 1880 Duty Cycle: 1:4

Probe: EX3DV4 – SN3617 ConvF(7.78,7.78,7.78)

Area Scan (71x121x1): Interpolated grid: dx=1.000 mm, dy=1.000 mm

Maximum value of SAR (interpolated) = 0.438 W/kg

Zoom Scan (7x7x7)/Cube 0: Measurement grid: dx=5mm, dy=5mm, dz=5mm

Reference Value = 12.39 V/m; Power Drift = -0.09 dB

Peak SAR (extrapolated) = 0.527 W/kg

SAR(1 g) = 0.337 W/kg; SAR(10 g) = 0.209 W/kg

Maximum value of SAR (measured) = 0.435 W/kg

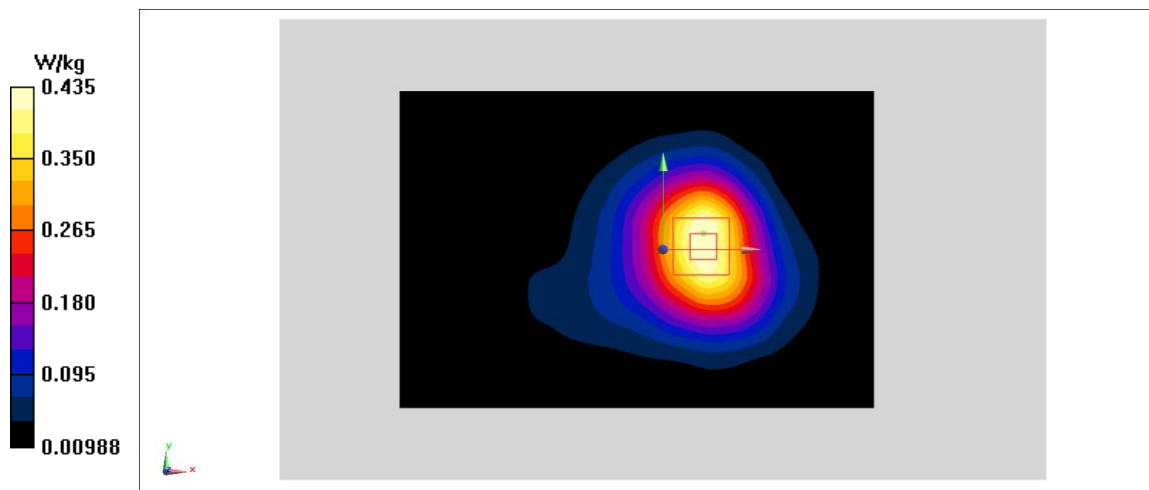

Fig A.4

WCDMA1900-BII_CH9262 Left Cheek

Date: 8/5/2019

Electronics: DAE4 Sn771

Medium: head 1900 MHz

Medium parameters used: $f = 1852.4$; $\sigma = 1.336$ mho/m; $\epsilon_r = 39.39$; $\rho = 1000$ kg/m³

Ambient Temperature: 22.5°C, Liquid Temperature: 22.3°C

Communication System: WCDMA1900-BII 1852.4 Duty Cycle: 1:1

Probe: EX3DV4 – SN3617 ConvF(8.14,8.14,8.14)

Area Scan (71x121x1): Interpolated grid: dx=1.000 mm, dy=1.000 mm

Maximum value of SAR (interpolated) = 0.519 W/kg

Zoom Scan (7x7x7)/Cube 0: Measurement grid: dx=5mm, dy=5mm, dz=5mm

Reference Value = 4.112 V/m; Power Drift = -0.02 dB

Peak SAR (extrapolated) = 0.557 W/kg

SAR(1 g) = 0.371 W/kg; SAR(10 g) = 0.242 W/kg

Maximum value of SAR (measured) = 0.479 W/kg

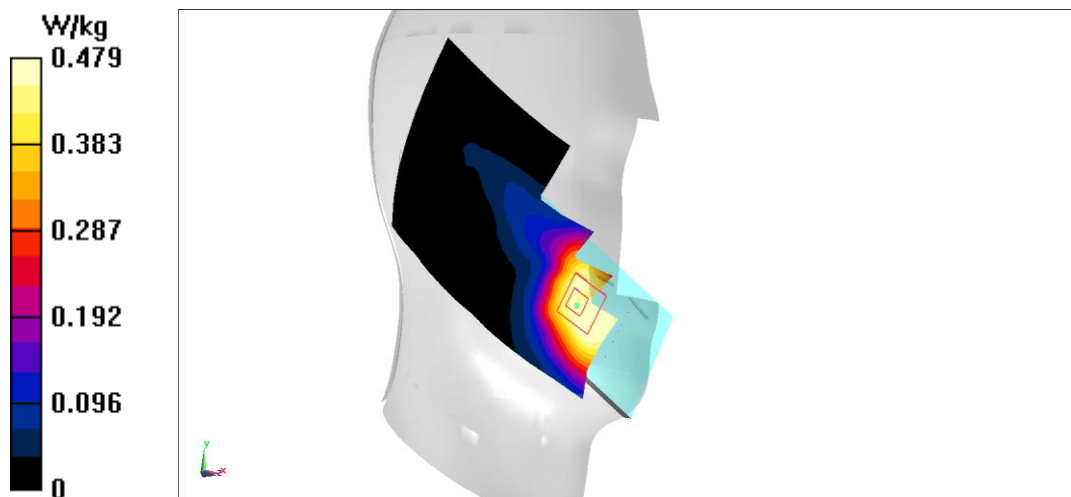

Fig A.5

WCDMA1900-BII_CH9538 Rear

Date: 8/5/2019

Electronics: DAE4 Sn771

Medium: body 1900 MHz

Medium parameters used: $f = 1907.6$; $\sigma = 1.533$ mho/m; $\epsilon_r = 53.2$; $\rho = 1000$ kg/m³

Ambient Temperature: 22.5°C, Liquid Temperature: 22.3°C

Communication System: WCDMA1900-BII 1907.6 Duty Cycle: 1:1

Probe: EX3DV4 – SN3617 ConvF(7.78,7.78,7.78)

Area Scan (71x121x1): Interpolated grid: dx=1.000 mm, dy=1.000 mm

Maximum value of SAR (interpolated) = 1.06 W/kg

Zoom Scan (7x7x7)/Cube 0: Measurement grid: dx=5mm, dy=5mm, dz=5mm

Reference Value = 19.99 V/m; Power Drift = -0.04 dB

Peak SAR (extrapolated) = 1.27 W/kg

SAR(1 g) = 0.822 W/kg; SAR(10 g) = 0.511 W/kg

Maximum value of SAR (measured) = 1.04 W/kg

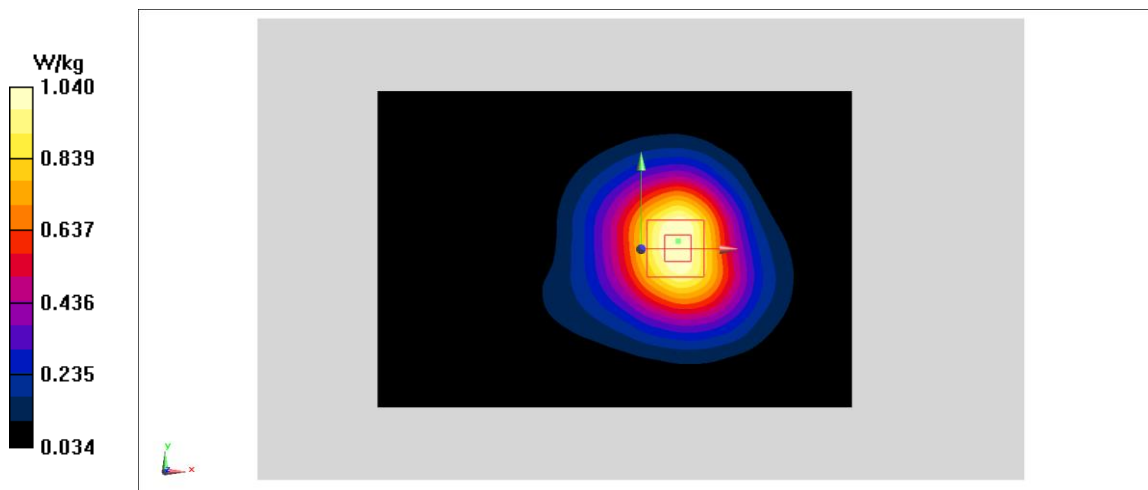

Fig A.6

WCDMA850-BV_CH4233 Right Cheek

Date: 8/3/2019

Electronics: DAE4 Sn771

Medium: head 835 MHz

Medium parameters used: $f = 846.6$; $\sigma = 0.895$ mho/m; $\epsilon_r = 41.44$; $\rho = 1000$ kg/m³

Ambient Temperature: 22.5°C, Liquid Temperature: 22.3°C

Communication System: WCDMA850-BV 846.6 Duty Cycle: 1:1

Probe: EX3DV4 – SN3617 ConvF(9.75,9.75,9.75)

Area Scan (71x121x1): Interpolated grid: dx=1.000 mm, dy=1.000 mm

Maximum value of SAR (interpolated) = 0.729 W/kg

Zoom Scan (7x7x7)/Cube 0: Measurement grid: dx=5mm, dy=5mm, dz=5mm

Reference Value = 5.216 V/m; Power Drift = -0.03 dB

Peak SAR (extrapolated) = 0.819 W/kg

SAR(1 g) = 0.521 W/kg; SAR(10 g) = 0.337 W/kg

Maximum value of SAR (measured) = 0.7 W/kg

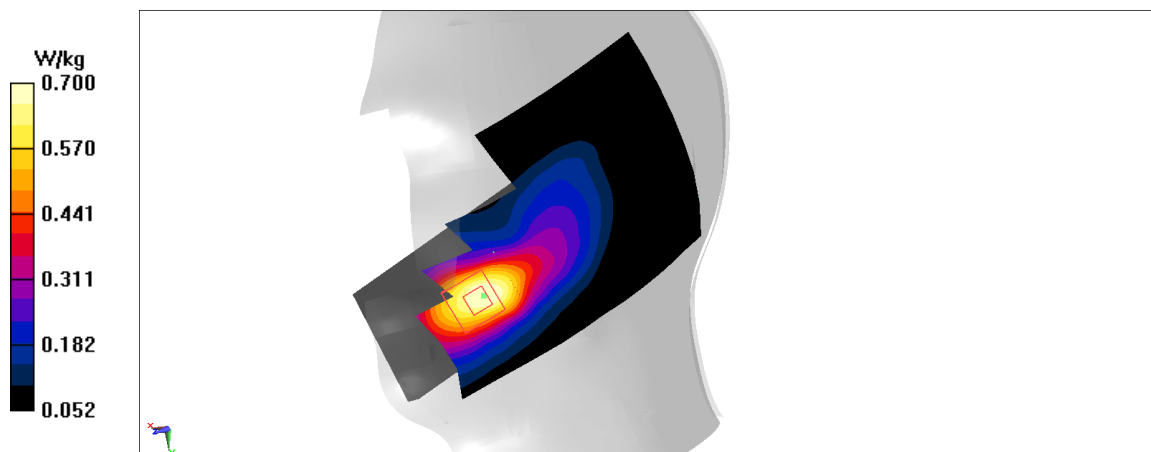

Fig A.7

WCDMA850-BV_CH4132 Rear

Date: 8/3/2019

Electronics: DAE4 Sn771

Medium: body 835 MHz

Medium parameters used: $f = 826.4$; $\sigma = 0.965$ mho/m; $\epsilon_r = 54.76$; $\rho = 1000$ kg/m³

Ambient Temperature: 22.5°C, Liquid Temperature: 22.3°C

Communication System: WCDMA850-BV 826.4 Duty Cycle: 1:1

Probe: EX3DV4 – SN3617 ConvF(9.61,9.61,9.61)

Area Scan (71x121x1): Interpolated grid: dx=1.000 mm, dy=1.000 mm

Maximum value of SAR (interpolated) = 0.853 W/kg

Zoom Scan (7x7x7)/Cube 0: Measurement grid: dx=5mm, dy=5mm, dz=5mm

Reference Value = 27.92 V/m; Power Drift = -0.02 dB

Peak SAR (extrapolated) = 0.951 W/kg

SAR(1 g) = 0.737 W/kg; SAR(10 g) = 0.549 W/kg

Maximum value of SAR (measured) = 0.855 W/kg

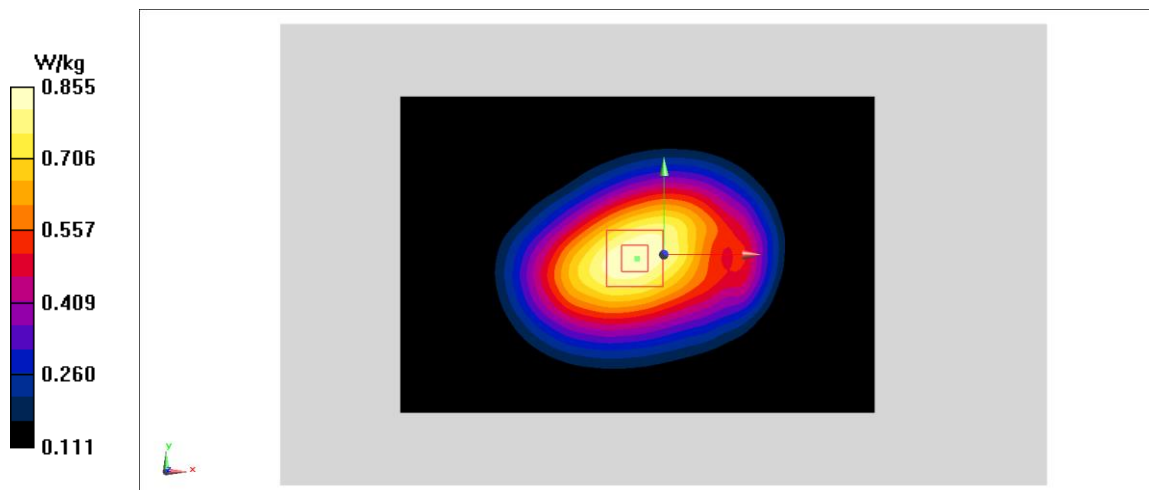

Fig A.8

CDMA800-BC0_CH384 Right Cheek

Date: 8/3/2019

Electronics: DAE4 Sn771

Medium: head 835 MHz

Medium parameters used: $f = 836.52$; $\sigma = 0.886$ mho/m; $\epsilon_r = 41.45$; $\rho = 1000$ kg/m³

Ambient Temperature: 22.5°C, Liquid Temperature: 22.3°C

Communication System: CDMA800-BC0 836.52 Duty Cycle: 1:1

Probe: EX3DV4 – SN3617 ConvF(9.75,9.75,9.75)

Area Scan (71x121x1): Interpolated grid: dx=1.000 mm, dy=1.000 mm

Maximum value of SAR (interpolated) = 0.813 W/kg

Zoom Scan (7x7x7)/Cube 0: Measurement grid: dx=5mm, dy=5mm, dz=5mm

Reference Value = 5.92 V/m; Power Drift = -0.08 dB

Peak SAR (extrapolated) = 0.941 W/kg

SAR(1 g) = 0.565 W/kg; SAR(10 g) = 0.363 W/kg

Maximum value of SAR (measured) = 0.791 W/kg

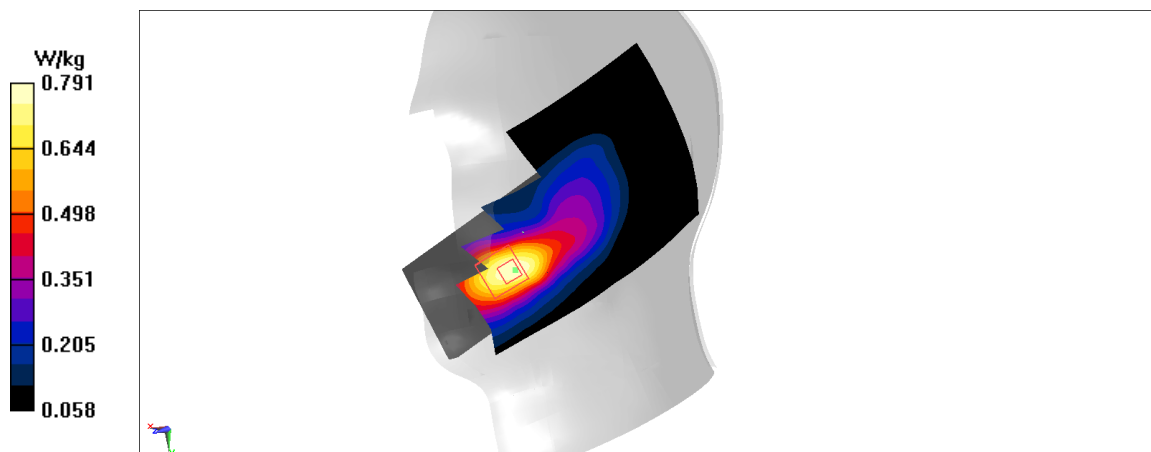

Fig A.9

CDMA800-BC0_CH384 Rear

Date: 8/3/2019

Electronics: DAE4 Sn771

Medium: body 835 MHz

Medium parameters used: $f = 836.52$; $\sigma = 0.976$ mho/m; $\epsilon_r = 54.75$; $\rho = 1000$ kg/m³

Ambient Temperature: 22.5°C, Liquid Temperature: 22.3°C

Communication System: CDMA800-BC0 836.52 Duty Cycle: 1:1

Probe: EX3DV4 – SN3617 ConvF(9.61,9.61,9.61)

Area Scan (71x121x1): Interpolated grid: dx=1.000 mm, dy=1.000 mm

Maximum value of SAR (interpolated) = 0.892 W/kg

Zoom Scan (7x7x7)/Cube 0: Measurement grid: dx=5mm, dy=5mm, dz=5mm

Reference Value = 30.12 V/m; Power Drift = 0.03 dB

Peak SAR (extrapolated) = 0.985 W/kg

SAR(1 g) = 0.724 W/kg; SAR(10 g) = 0.529 W/kg

Maximum value of SAR (measured) = 0.89 W/kg

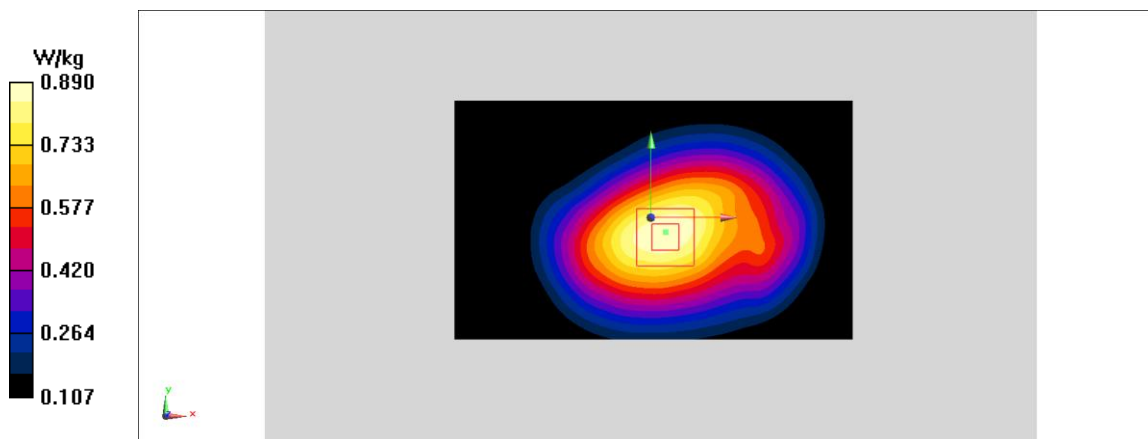

Fig A.10

CDMA1900-BC1_CH600 Left Cheek

Date: 8/5/2019

Electronics: DAE4 Sn771

Medium: head 1900 MHz

Medium parameters used: $f = 1880$; $\sigma = 1.363$ mho/m; $\epsilon_r = 39.35$; $\rho = 1000$ kg/m³

Ambient Temperature: 22.5°C, Liquid Temperature: 22.3°C

Communication System: CDMA1900-BC1 1880 Duty Cycle: 1:1

Probe: EX3DV4 – SN3617 ConvF(8.14,8.14,8.14)

Area Scan (71x121x1): Interpolated grid: dx=1.000 mm, dy=1.000 mm

Maximum value of SAR (interpolated) = 0.498 W/kg

Zoom Scan (7x7x7)/Cube 0: Measurement grid: dx=5mm, dy=5mm, dz=5mm

Reference Value = 3.813 V/m; Power Drift = -0.04 dB

Peak SAR (extrapolated) = 0.571 W/kg

SAR(1 g) = 0.377 W/kg; SAR(10 g) = 0.242 W/kg

Maximum value of SAR (measured) = 0.495 W/kg

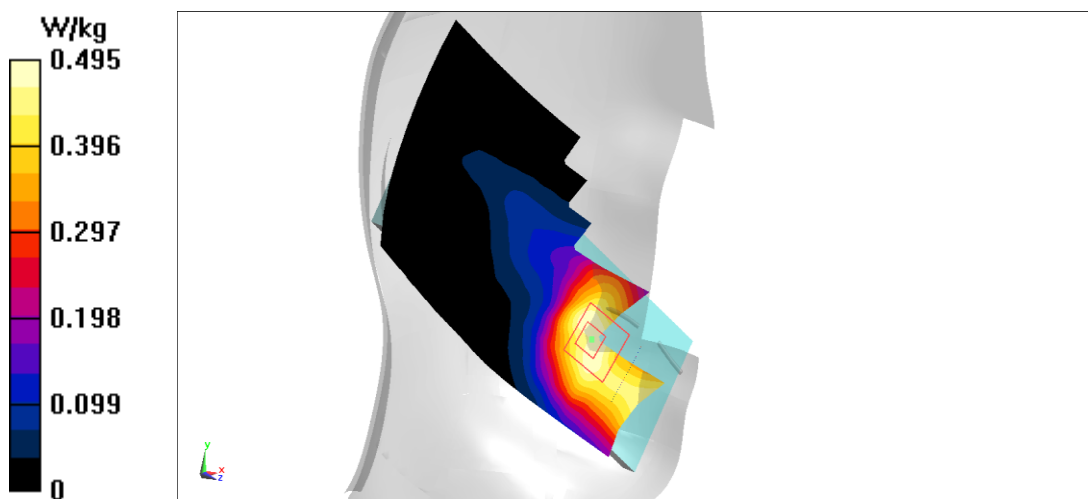

Fig A.11

CDMA1900-BC1_CH600 Rear

Date: 8/5/2019

Electronics: DAE4 Sn771

Medium: body 1900 MHz

Medium parameters used: $f = 1880$; $\sigma = 1.506$ mho/m; $\epsilon_r = 53.23$; $\rho = 1000$ kg/m³

Ambient Temperature: 22.5°C, Liquid Temperature: 22.3°C

Communication System: CDMA1900-BC1 1880 Duty Cycle: 1:1

Probe: EX3DV4 – SN3617 ConvF(7.78,7.78,7.78)

Area Scan (71x121x1): Interpolated grid: dx=1.000 mm, dy=1.000 mm

Maximum value of SAR (interpolated) = 1.02 W/kg

Zoom Scan (7x7x7)/Cube 0: Measurement grid: dx=5mm, dy=5mm, dz=5mm

Reference Value = 14.16 V/m; Power Drift = -0.07 dB

Peak SAR (extrapolated) = 1.22 W/kg

SAR(1 g) = 0.747 W/kg; SAR(10 g) = 0.448 W/kg

Maximum value of SAR (measured) = 1.04 W/kg

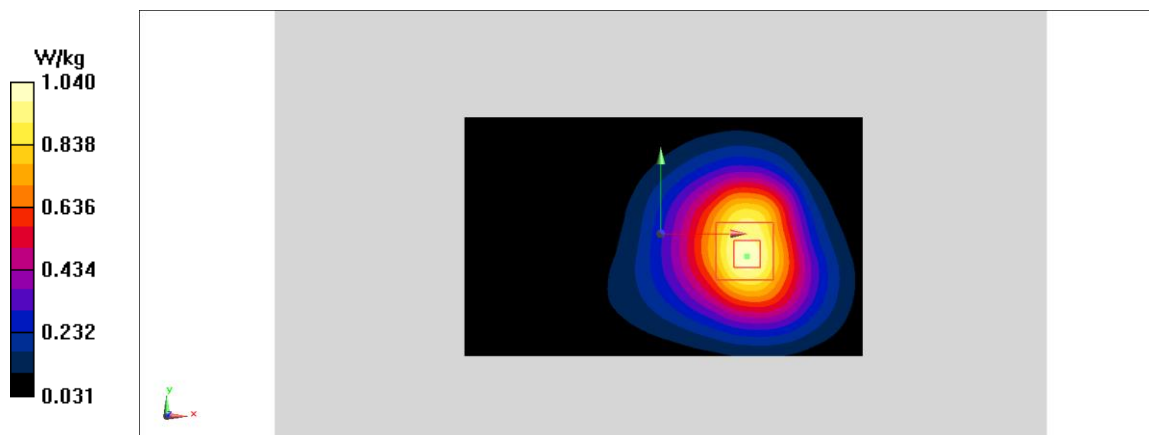

Fig A.12

CDMA800-BC10_CH580 Right Cheek

Date: 8/3/2019

Electronics: DAE4 Sn771

Medium: head 835 MHz

Medium parameters used: $f = 820.5$; $\sigma = 0.87$ mho/m; $\epsilon_r = 41.47$; $\rho = 1000$ kg/m³

Ambient Temperature: 22.5°C, Liquid Temperature: 22.3°C

Communication System: CDMA800-BC10 820.5 Duty Cycle: 1:1

Probe: EX3DV4 – SN3617 ConvF(9.75,9.75,9.75)

Area Scan (71x121x1): Interpolated grid: dx=1.000 mm, dy=1.000 mm

Maximum value of SAR (interpolated) = 0.651 W/kg

Zoom Scan (7x7x7)/Cube 0: Measurement grid: dx=5mm, dy=5mm, dz=5mm

Reference Value = 4.786 V/m; Power Drift = -0.06 dB

Peak SAR (extrapolated) = 0.779 W/kg

SAR(1 g) = 0.465 W/kg; SAR(10 g) = 0.299 W/kg

Maximum value of SAR (measured) = 0.652 W/kg

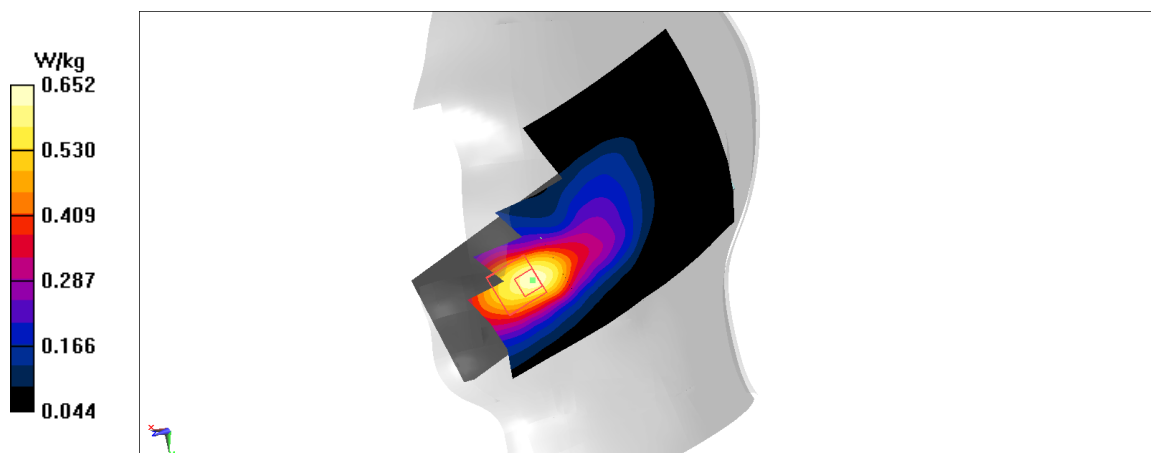

Fig A.13

CDMA800-BC10_CH580 Rear

Date: 8/3/2019

Electronics: DAE4 Sn771

Medium: body 835 MHz

Medium parameters used: $f = 820.5$; $\sigma = 0.96$ mho/m; $\epsilon_r = 54.77$; $\rho = 1000$ kg/m³

Ambient Temperature: 22.5°C, Liquid Temperature: 22.3°C

Communication System: CDMA800-BC10 820.5 Duty Cycle: 1:1

Probe: EX3DV4 – SN3617 ConvF(9.61,9.61,9.61)

Area Scan (71x121x1): Interpolated grid: dx=1.000 mm, dy=1.000 mm

Maximum value of SAR (interpolated) = 0.957 W/kg

Zoom Scan (7x7x7)/Cube 0: Measurement grid: dx=5mm, dy=5mm, dz=5mm

Reference Value = 30.4 V/m; Power Drift = -0.15 dB

Peak SAR (extrapolated) = 1.05 W/kg

SAR(1 g) = 0.737 W/kg; SAR(10 g) = 0.534 W/kg

Maximum value of SAR (measured) = 0.926 W/kg

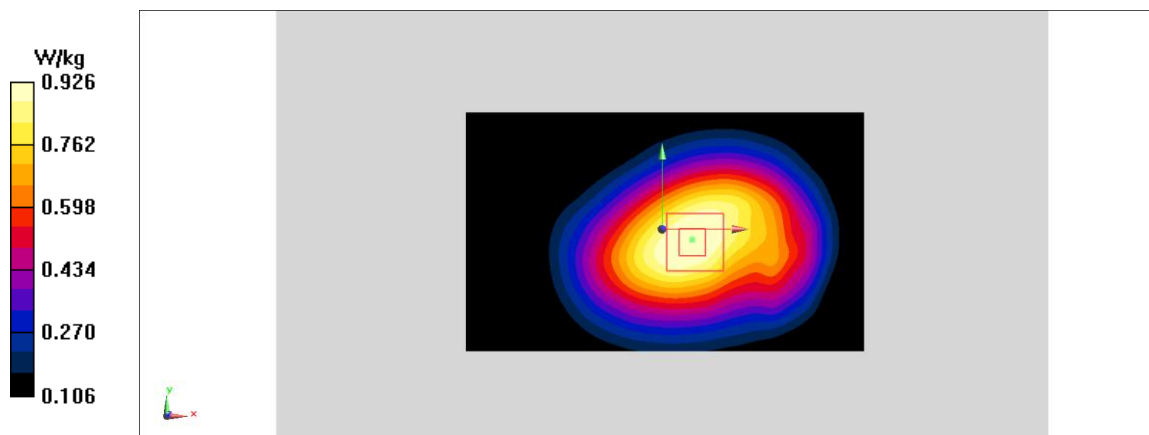

Fig A.14

LTE1700-FDD4_CH20300 Right Cheek

Date: 8/4/2019

Electronics: DAE4 Sn771

Medium: head 1750 MHz

Medium parameters used: $f = 1745$ MHz; $\sigma = 1.369$ mho/m; $\epsilon_r = 39.45$; $\rho = 1000$ kg/m³

Ambient Temperature: 22.5°C, Liquid Temperature: 22.3°C

Communication System: LTE1700-FDD4 1745 MHz Duty Cycle: 1:1

Probe: EX3DV4 – SN3617 ConvF(8.38,8.38,8.38)

Area Scan (71x121x1): Interpolated grid: dx=1.000 mm, dy=1.000 mm

Maximum value of SAR (interpolated) = 0.483 W/kg

Zoom Scan (7x7x7)/Cube 0: Measurement grid: dx=5mm, dy=5mm, dz=5mm

Reference Value = 2.929 V/m; Power Drift = 0.17 dB

Peak SAR (extrapolated) = 0.535 W/kg

SAR(1 g) = 0.341 W/kg; SAR(10 g) = 0.209 W/kg

Maximum value of SAR (measured) = 0.455 W/kg

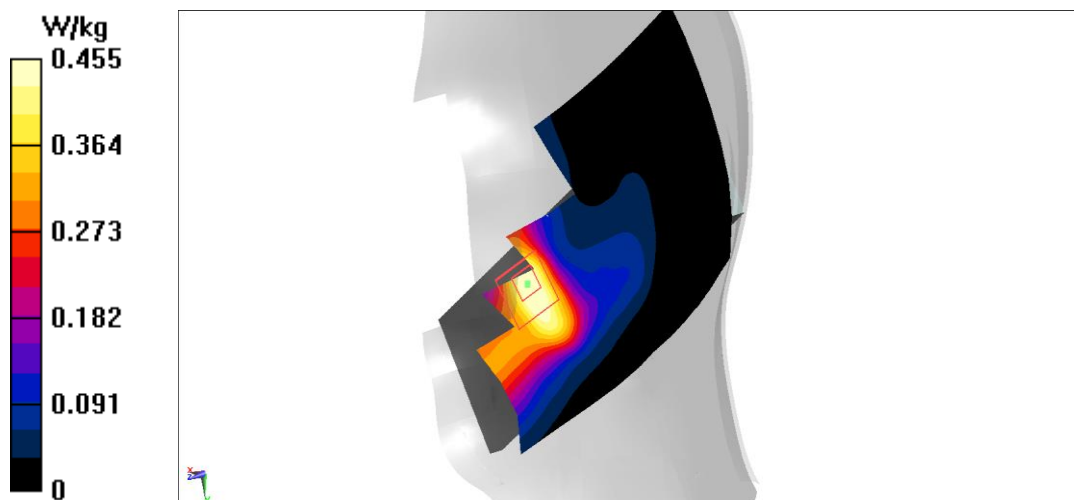

Fig A.15

LTE1700-FDD4_CH20300 Rear

Date: 8/4/2019

Electronics: DAE4 Sn771

Medium: body 1750 MHz

Medium parameters used: $f = 1745$ MHz; $\sigma = 1.461$ mho/m; $\epsilon_r = 54.05$; $\rho = 1000$ kg/m³

Ambient Temperature: 22.5°C, Liquid Temperature: 22.3°C

Communication System: LTE1700-FDD4 1745 MHz Duty Cycle: 1:1

Probe: EX3DV4 – SN3617 ConvF(8.03,8.03,8.03)

Area Scan (71x121x1): Interpolated grid: dx=1.000 mm, dy=1.000 mm

Maximum value of SAR (interpolated) = 1.46 W/kg

Zoom Scan (7x7x7)/Cube 0: Measurement grid: dx=5mm, dy=5mm, dz=5mm

Reference Value = 12.67 V/m; Power Drift = 0.01 dB

Peak SAR (extrapolated) = 1.7 W/kg

SAR(1 g) = 1.05 W/kg; SAR(10 g) = 0.643 W/kg

Maximum value of SAR (measured) = 1.46 W/kg

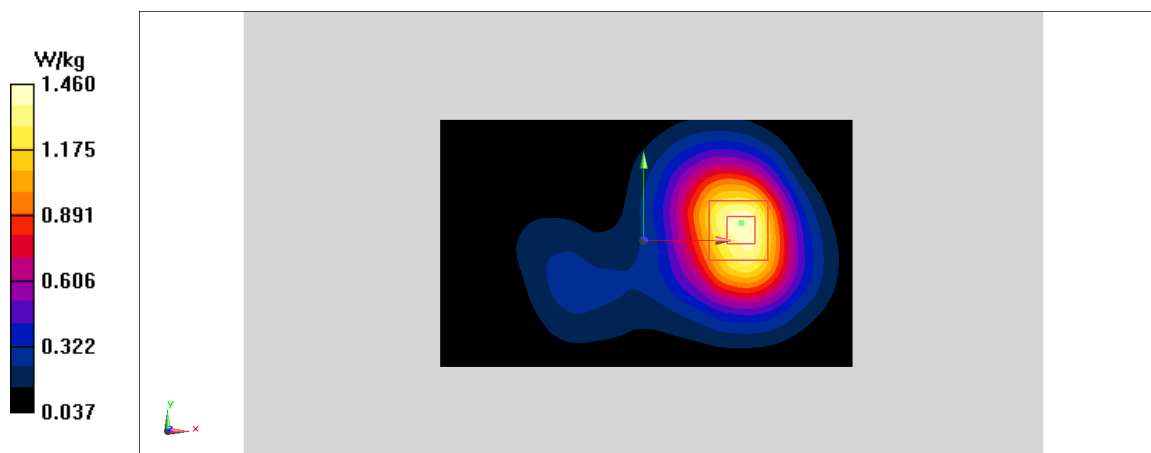

Fig A.16

LTE750-FDD13_CH23230 Right Cheek

Date: 8/2/2019

Electronics: DAE4 Sn771

Medium: head 750 MHz

Medium parameters used: $f = 782$ MHz; $\sigma = 0.927$ mho/m; $\epsilon_r = 42.03$; $\rho = 1000$ kg/m³

Ambient Temperature: 22.5°C, Liquid Temperature: 22.3°C

Communication System: LTE750-FDD13 782 MHz Duty Cycle: 1:1

Probe: EX3DV4 – SN3617 ConvF(10.03,10.03,10.03)

Area Scan (71x121x1): Interpolated grid: dx=1.000 mm, dy=1.000 mm

Maximum value of SAR (interpolated) = 0.321 W/kg

Zoom Scan (7x7x7)/Cube 0: Measurement grid: dx=5mm, dy=5mm, dz=5mm

Reference Value = 2.996 V/m; Power Drift = 0.09 dB

Peak SAR (extrapolated) = 0.393 W/kg

SAR(1 g) = 0.239 W/kg; SAR(10 g) = 0.16 W/kg

Maximum value of SAR (measured) = 0.321 W/kg

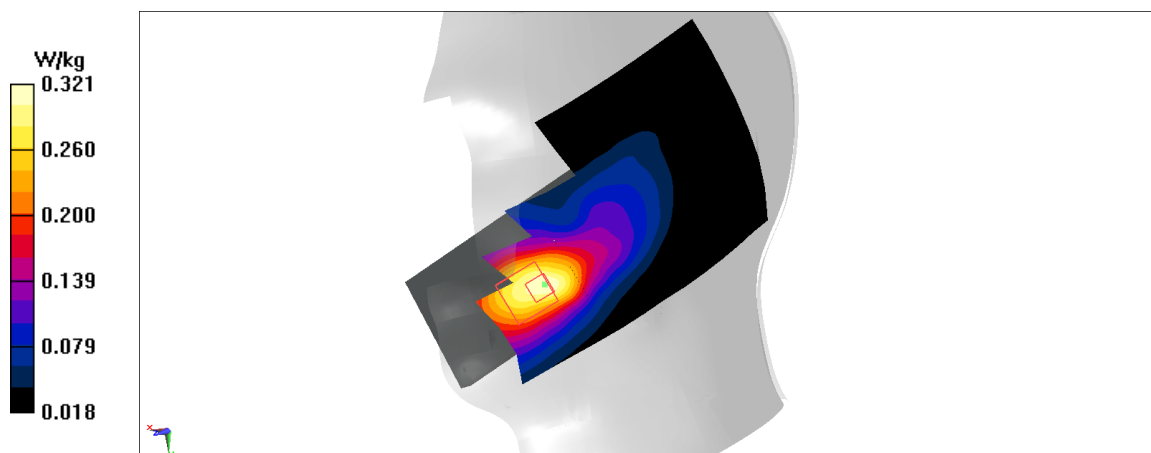

Fig A.17

LTE750-FDD13_CH23230 Rear

Date: 8/2/2019

Electronics: DAE4 Sn771

Medium: body 750 MHz

Medium parameters used: $f = 782$ MHz; $\sigma = 0.991$ mho/m; $\epsilon_r = 54.99$; $\rho = 1000$ kg/m³

Ambient Temperature: 22.5°C, Liquid Temperature: 22.3°C

Communication System: LTE750-FDD13 782 MHz Duty Cycle: 1:1

Probe: EX3DV4 – SN3617 ConvF(9.85,9.85,9.85)

Area Scan (71x121x1): Interpolated grid: $dx=1.000$ mm, $dy=1.000$ mm

Maximum value of SAR (interpolated) = 0.529 W/kg

Zoom Scan (7x7x7)/Cube 0: Measurement grid: $dx=5$ mm, $dy=5$ mm, $dz=5$ mm

Reference Value = 21.46 V/m; Power Drift = -0.06 dB

Peak SAR (extrapolated) = 0.617 W/kg

SAR(1 g) = 0.447 W/kg; SAR(10 g) = 0.323 W/kg

Maximum value of SAR (measured) = 0.529 W/kg

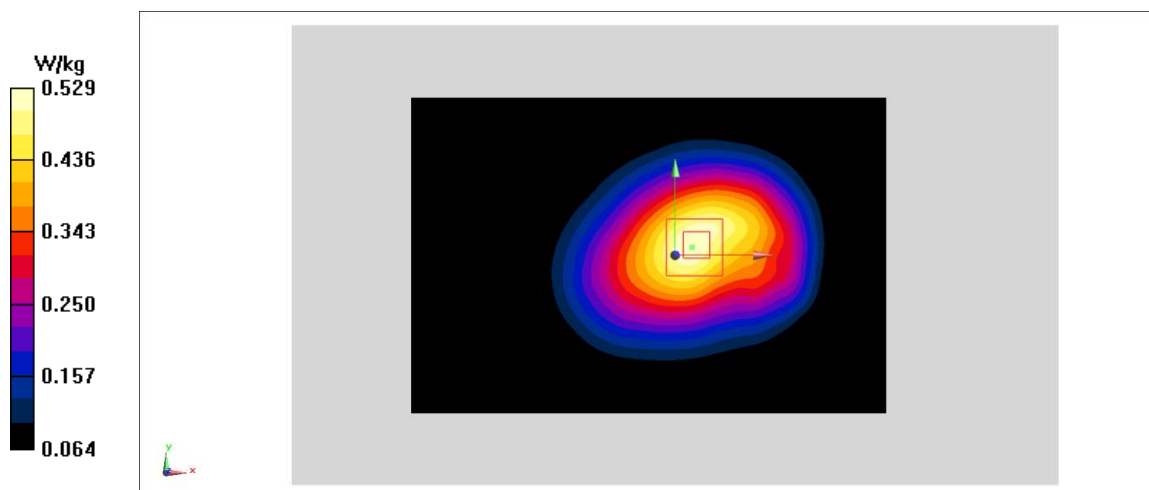

Fig A.18

LTE1900-FDD25_CH26365 Left Cheek

Date: 8/5/2019

Electronics: DAE4 Sn771

Medium: head 1900 MHz

Medium parameters used: $f = 1882.5$ MHz; $\sigma = 1.365$ mho/m; $\epsilon_r = 39.35$; $\rho = 1000$ kg/m³

Ambient Temperature: 22.5°C, Liquid Temperature: 22.3°C

Communication System: LTE1900-FDD25 1882.5 MHz Duty Cycle: 1:1

Probe: EX3DV4 – SN3617 ConvF(8.14,8.14,8.14)

Area Scan (71x121x1): Interpolated grid: $dx=1.000$ mm, $dy=1.000$ mm

Maximum value of SAR (interpolated) = 0.387 W/kg

Zoom Scan (7x7x7)/Cube 0: Measurement grid: $dx=5$ mm, $dy=5$ mm, $dz=5$ mm

Reference Value = 3.176 V/m; Power Drift = 0.15 dB

Peak SAR (extrapolated) = 0.417 W/kg

SAR(1 g) = 0.269 W/kg; SAR(10 g) = 0.175 W/kg

Maximum value of SAR (measured) = 0.355 W/kg

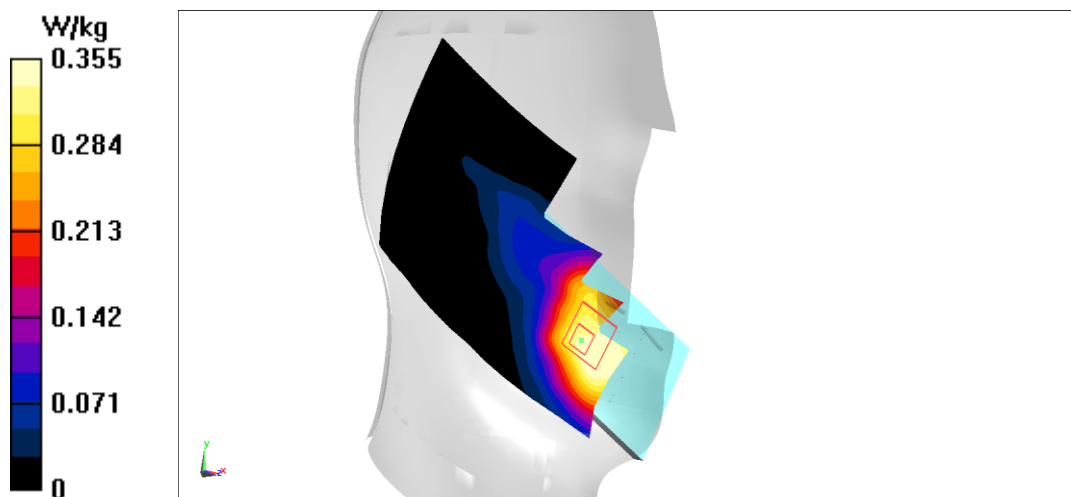

Fig A.19

LTE1900-FDD25_CH26365 Rear

Date: 8/5/2019

Electronics: DAE4 Sn771

Medium: body 1900 MHz

Medium parameters used: $f = 1882.5$ MHz; $\sigma = 1.508$ mho/m; $\epsilon_r = 53.23$; $\rho = 1000$ kg/m³

Ambient Temperature: 22.5°C, Liquid Temperature: 22.3°C

Communication System: LTE1900-FDD25 1882.5 MHz Duty Cycle: 1:1

Probe: EX3DV4 – SN3617 ConvF(7.78,7.78,7.78)

Area Scan (71x121x1): Interpolated grid: dx=1.000 mm, dy=1.000 mm

Maximum value of SAR (interpolated) = 0.985 W/kg

Zoom Scan (7x7x7)/Cube 0: Measurement grid: dx=5mm, dy=5mm, dz=5mm

Reference Value = 16.03 V/m; Power Drift = -0.06 dB

Peak SAR (extrapolated) = 1.21 W/kg

SAR(1 g) = 0.778 W/kg; SAR(10 g) = 0.486 W/kg

Maximum value of SAR (measured) = 0.992 W/kg

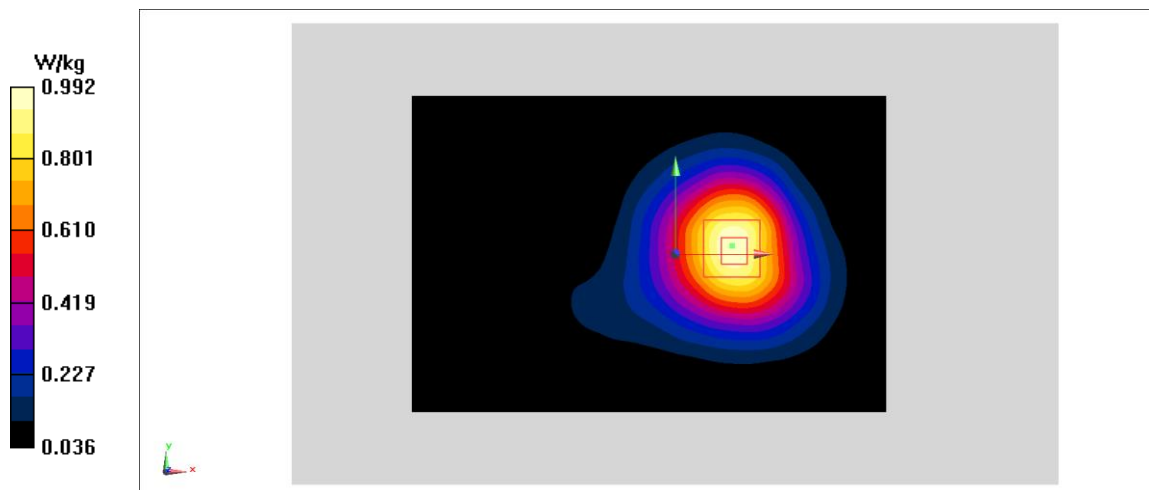

Fig A.20

LTE850-FDD26_CH26965 Right Cheek

Date: 8/3/2019

Electronics: DAE4 Sn771

Medium: head 835 MHz

Medium parameters used: $f = 841.5$ MHz; $\sigma = 0.891$ mho/m; $\epsilon_r = 41.44$; $\rho = 1000$ kg/m³

Ambient Temperature: 22.5°C, Liquid Temperature: 22.3°C

Communication System: LTE850-FDD26 841.5 MHz Duty Cycle: 1:1

Probe: EX3DV4 – SN3617 ConvF(9.75,9.75,9.75)

Area Scan (71x121x1): Interpolated grid: dx=1.000 mm, dy=1.000 mm

Maximum value of SAR (interpolated) = 0.627 W/kg

Zoom Scan (7x7x7)/Cube 0: Measurement grid: dx=5mm, dy=5mm, dz=5mm

Reference Value = 5.171 V/m; Power Drift = -0.09 dB

Peak SAR (extrapolated) = 0.788 W/kg

SAR(1 g) = 0.49 W/kg; SAR(10 g) = 0.314 W/kg

Maximum value of SAR (measured) = 0.673 W/kg

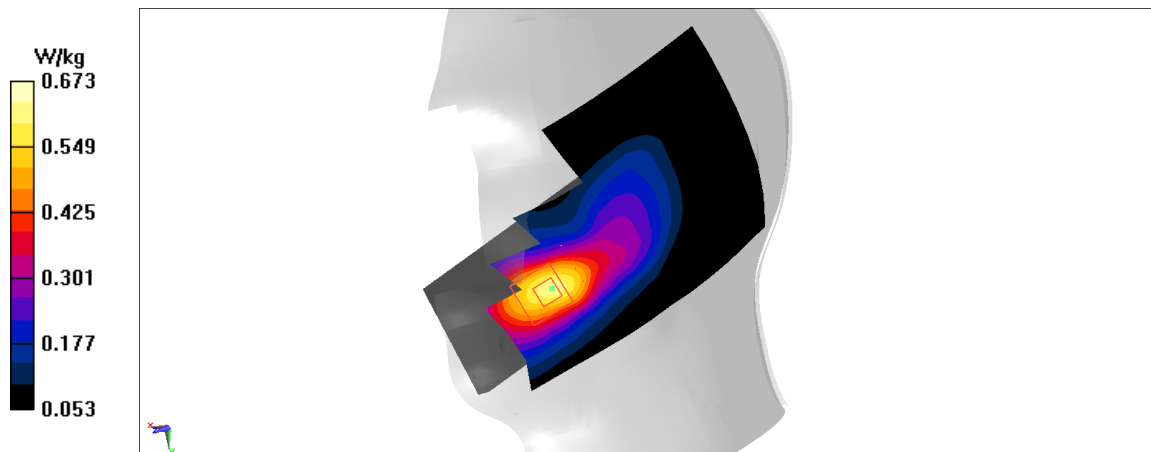

Fig A.21

LTE850-FDD26_CH26965 Rear

Date: 8/3/2019

Electronics: DAE4 Sn771

Medium: body 835 MHz

Medium parameters used: $f = 841.5$ MHz; $\sigma = 0.981$ mho/m; $\epsilon_r = 54.74$; $\rho = 1000$ kg/m³

Ambient Temperature: 22.5°C, Liquid Temperature: 22.3°C

Communication System: LTE850-FDD26 841.5 MHz Duty Cycle: 1:1

Probe: EX3DV4 – SN3617 ConvF(9.61,9.61,9.61)

Area Scan (71x121x1): Interpolated grid: dx=1.000 mm, dy=1.000 mm

Maximum value of SAR (interpolated) = 0.782 W/kg

Zoom Scan (7x7x7)/Cube 0: Measurement grid: dx=5mm, dy=5mm, dz=5mm

Reference Value = 26.57 V/m; Power Drift = 0.02 dB

Peak SAR (extrapolated) = 0.873 W/kg

SAR(1 g) = 0.678 W/kg; SAR(10 g) = 0.503 W/kg

Maximum value of SAR (measured) = 0.787 W/kg

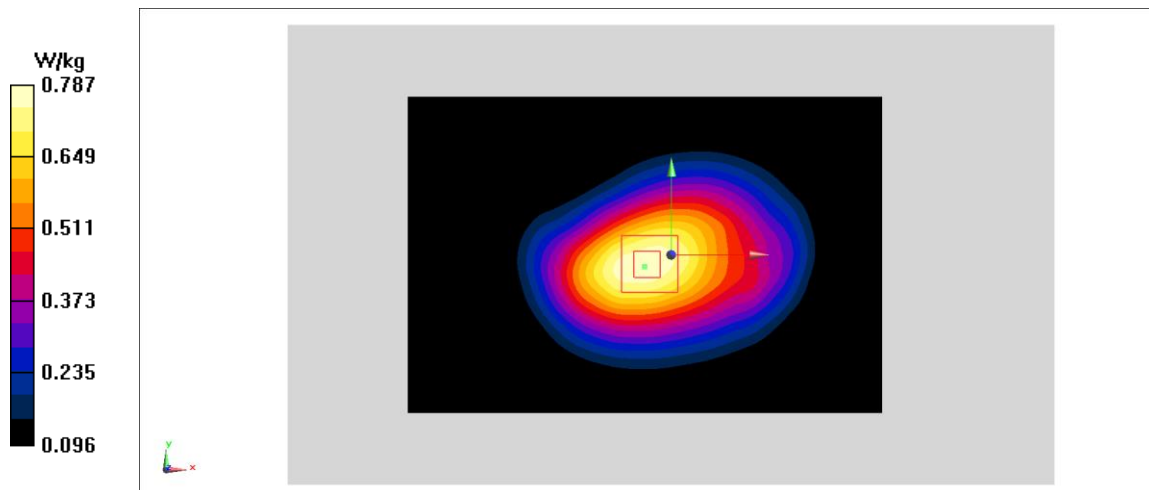

Fig A.22

LTE2500-TDD41_CH40185 Left Check

Date: 8/3/2019

Electronics: DAE4 Sn771

Medium: body 835 MHz

Medium parameters used: $f = 2549.5$ MHz; $\sigma = 1.878$ mho/m; $\epsilon_r = 39.12$; $\rho = 1000$ kg/m³

Ambient Temperature: 22.5°C, Liquid Temperature: 22.3°C

Communication System: LTE2500-TDD41 2549.5 MHz Duty Cycle: 1:1.58

Probe: EX3DV4 – SN3617 ConvF(7.19,7.19,7.19)

Area Scan (71x121x1): Interpolated grid: dx=1.000 mm, dy=1.000 mm

Maximum value of SAR (interpolated) = 0.998 W/kg

Zoom Scan (7x7x7)/Cube 0: Measurement grid: dx=5mm, dy=5mm, dz=5mm

Reference Value = 2.906 V/m; Power Drift = 0.02 dB

Peak SAR (extrapolated) = 1.36 W/kg

SAR(1 g) = 0.702 W/kg; SAR(10 g) = 0.341 W/kg

Maximum value of SAR (measured) = 1.1 W/kg

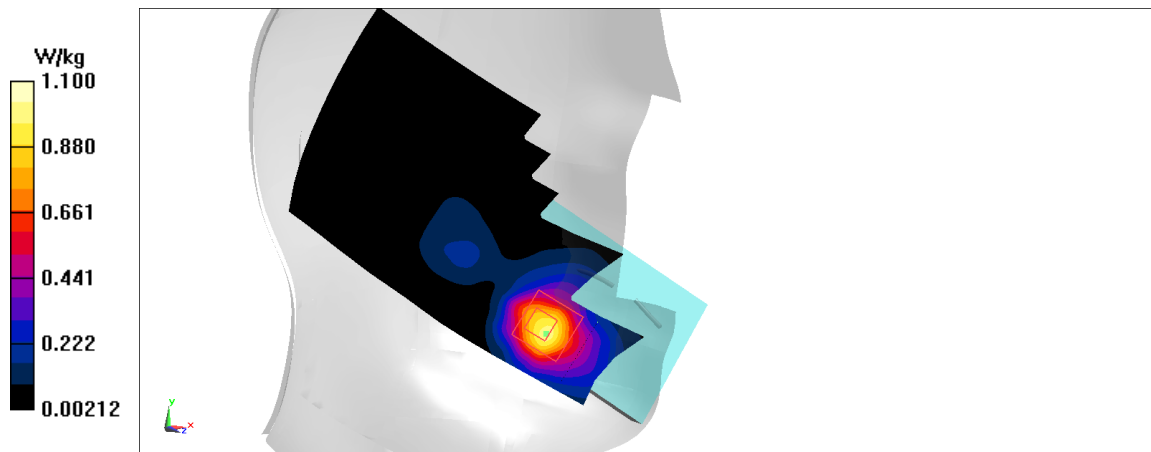

Fig A.23

LTE2500-TDD41_CH41490 Rear

Date: 8/3/2019

Electronics: DAE4 Sn771

Medium: body 835 MHz

Medium parameters used: $f = 2680$ MHz; $\sigma = 2.255$ mho/m; $\epsilon_r = 52.53$; $\rho = 1000$ kg/m³

Ambient Temperature: 22.5°C, Liquid Temperature: 22.3°C

Communication System: LTE2500-TDD41 2680 MHz Duty Cycle: 1:1.58

Probe: EX3DV4 – SN3617 ConvF(7.49,7.49,7.49)

Area Scan (71x121x1): Interpolated grid: dx=1.000 mm, dy=1.000 mm

Maximum value of SAR (interpolated) = 1.03 W/kg

Zoom Scan (7x7x7)/Cube 0: Measurement grid: dx=5mm, dy=5mm, dz=5mm

Reference Value = 5.948 V/m; Power Drift = 0.01 dB

Peak SAR (extrapolated) = 1.35 W/kg

SAR(1 g) = 0.704 W/kg; SAR(10 g) = 0.347 W/kg

Maximum value of SAR (measured) = 1.03 W/kg

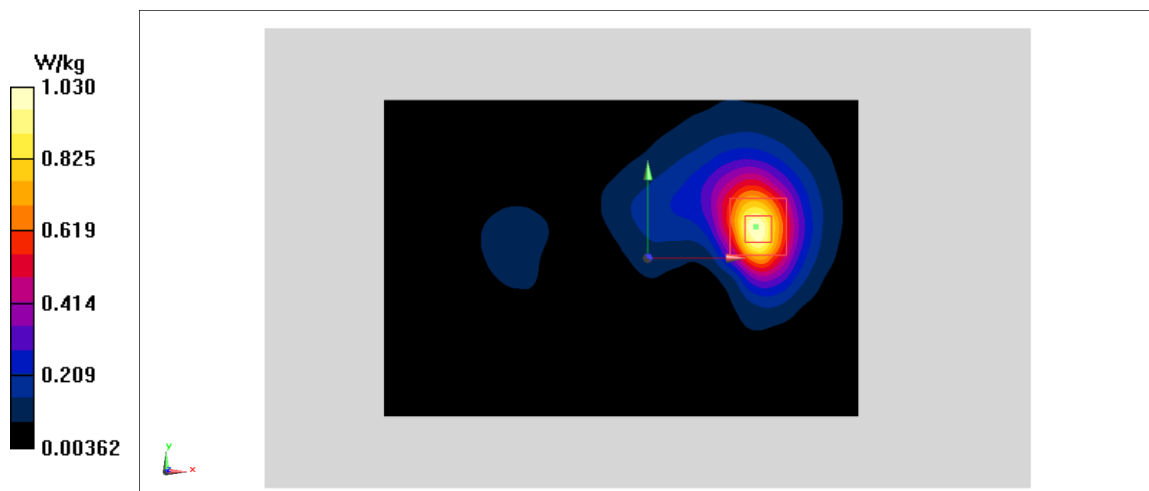

Fig A.24

LTE2500-TDD41_CH40185 Left Check

Date: 8/3/2019

Electronics: DAE4 Sn771

Medium: body 835 MHz

Medium parameters used: $f = 2549.5$ MHz; $\sigma = 1.878$ mho/m; $\epsilon_r = 39.12$; $\rho = 1000$ kg/m³

Ambient Temperature: 22.5°C, Liquid Temperature: 22.3°C

Communication System: LTE2500-TDD41 2549.5 MHz Duty Cycle: 1:1.58

Probe: EX3DV4 – SN3617 ConvF(7.19,7.19,7.19)

Area Scan (71x121x1): Interpolated grid: dx=1.000 mm, dy=1.000 mm

Maximum value of SAR (interpolated) = 0.963 W/kg

Zoom Scan (7x7x7)/Cube 0: Measurement grid: dx=5mm, dy=5mm, dz=5mm

Reference Value = 2.237 V/m; Power Drift = 0.05 dB

Peak SAR (extrapolated) = 1.35 W/kg

SAR(1 g) = 0.672 W/kg; SAR(10 g) = 0.333 W/kg

Maximum value of SAR (measured) = 1.1 W/kg

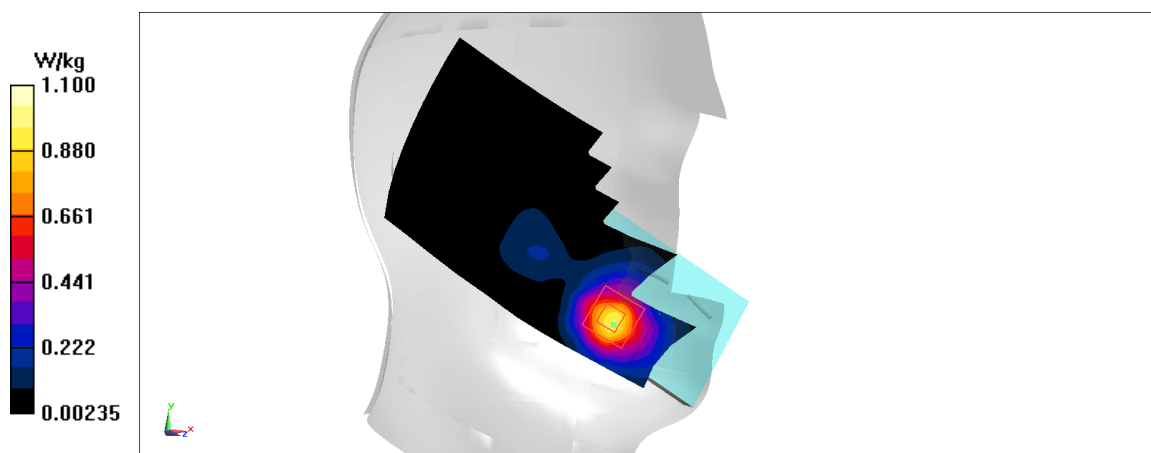

Fig A.25

LTE2500-TDD41_CH41490 Rear

Date: 8/3/2019

Electronics: DAE4 Sn771

Medium: body 835 MHz

Medium parameters used: $f = 2680$ MHz; $\sigma = 2.255$ mho/m; $\epsilon_r = 52.53$; $\rho = 1000$ kg/m³

Ambient Temperature: 22.5°C, Liquid Temperature: 22.3°C

Communication System: LTE2500-TDD41 2680 MHz Duty Cycle: 1:1.58

Probe: EX3DV4 – SN3617 ConvF(7.49,7.49,7.49)

Area Scan (71x121x1): Interpolated grid: dx=1.000 mm, dy=1.000 mm

Maximum value of SAR (interpolated) = 1.32 W/kg

Zoom Scan (7x7x7)/Cube 0: Measurement grid: dx=5mm, dy=5mm, dz=5mm

Reference Value = 6.634 V/m; Power Drift = -0.08 dB

Peak SAR (extrapolated) = 1.74 W/kg

SAR(1 g) = 0.896 W/kg; SAR(10 g) = 0.439 W/kg

Maximum value of SAR (measured) = 1.32 W/kg

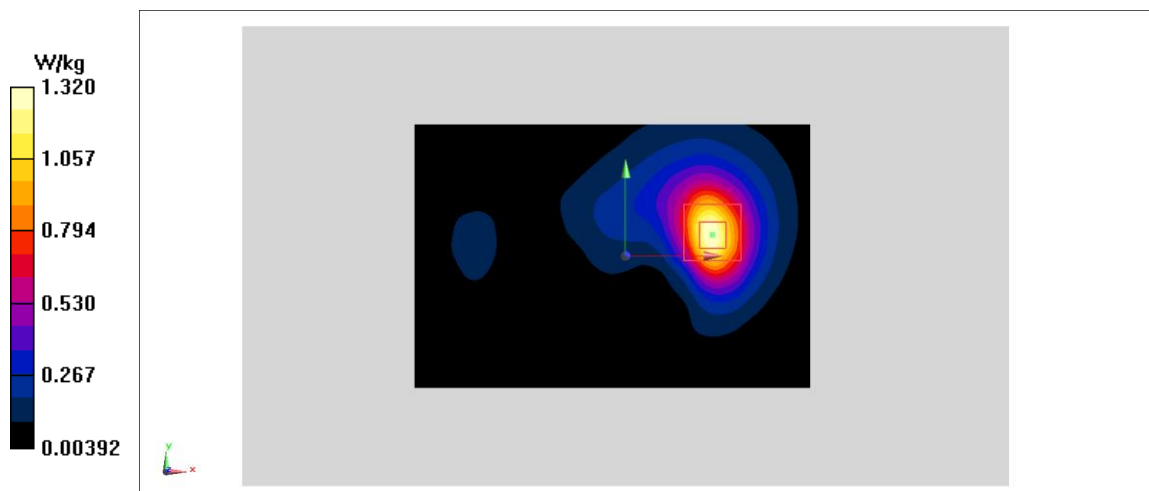

Fig A.26

WLAN2450_CH1 Right Check

Date: 9/5/2019

Electronics: DAE4 Sn771

Medium: body 2450 MHz

Medium parameters used: $f = 2412$; $\sigma = 1.914$ mho/m; $\epsilon_r = 38.95$; $\rho = 1000$ kg/m³

Ambient Temperature: 22.5°C, Liquid Temperature: 22.3°C

Communication System: WLAN2450 2412 Duty Cycle: 1:1

Probe: EX3DV4 – SN3617 ConvF(7.79,7.79,7.79)

Area Scan (71x121x1): Interpolated grid: dx=1.000 mm, dy=1.000 mm

Maximum value of SAR (interpolated) = 1.24 W/kg

Zoom Scan (7x7x7)/Cube 0: Measurement grid: dx=5mm, dy=5mm, dz=5mm

Reference Value = 4.206 V/m; Power Drift = 0.08 dB

Peak SAR (extrapolated) = 1.36 W/kg

SAR(1 g) = 0.752 W/kg; SAR(10 g) = 0.403 W/kg

Maximum value of SAR (measured) = 1.13 W/kg

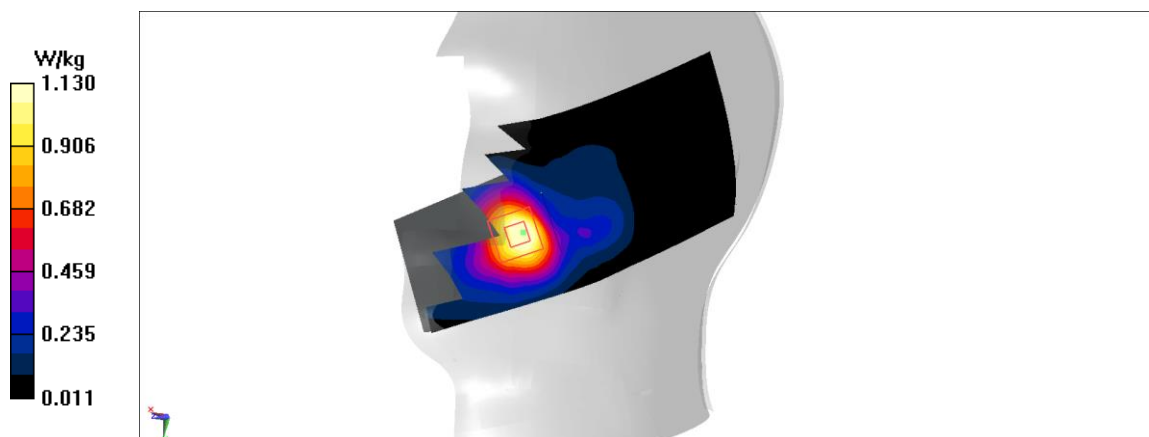

Fig A.27

WLAN2450_CH1 Rear unfold

Date: 9/5/2019

Electronics: DAE4 Sn771

Medium: body 2450 MHz

Medium parameters used: $f = 2412$; $\sigma = 1.914$ mho/m; $\epsilon_r = 52.67$; $\rho = 1000$ kg/m³

Ambient Temperature: 22.5°C, Liquid Temperature: 22.3°C

Communication System: WLAN2450 2412 Duty Cycle: 1:1

Probe: EX3DV4 – SN3617 ConvF(7.79,7.79,7.79)

Area Scan (71x121x1): Interpolated grid: dx=1.000 mm, dy=1.000 mm

Maximum value of SAR (interpolated) = 0.188 W/kg

Zoom Scan (7x7x7)/Cube 0: Measurement grid: dx=5mm, dy=5mm, dz=5mm

Reference Value = 6.006 V/m; Power Drift = 0.07 dB

Peak SAR (extrapolated) = 0.237 W/kg

SAR(1 g) = 0.14 W/kg; SAR(10 g) = 0.081 W/kg

Maximum value of SAR (measured) = 0.189 W/kg

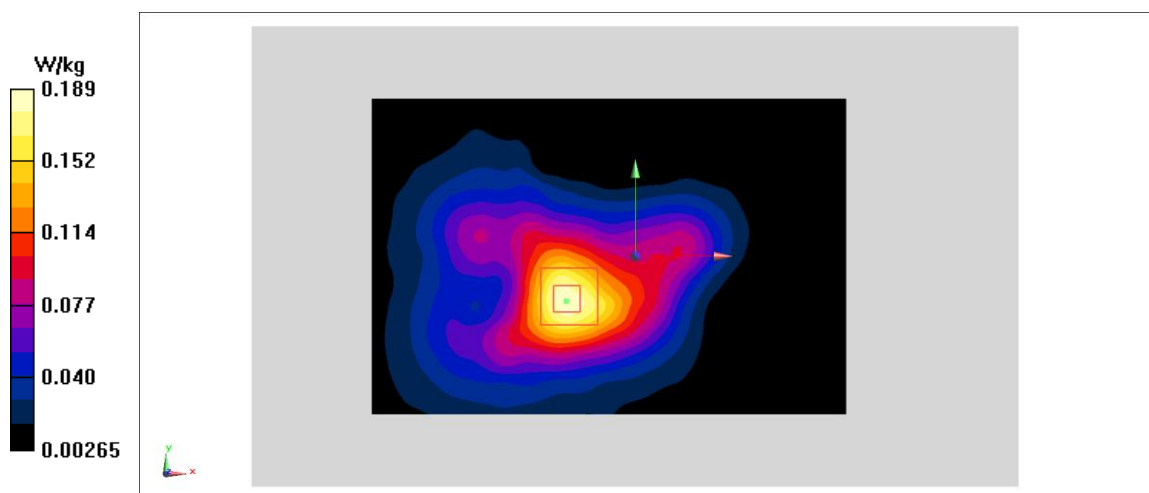

Fig A.28

UNII-1_CH165 Right Check

Date: 9/6/2019

Electronics: DAE4 Sn771

Medium: body 5250 MHz

Medium parameters used: $f = 5825$; $\sigma = 5.883$ mho/m; $\epsilon_r = 48.77$; $\rho = 1000$ kg/m³

Ambient Temperature: 22.5°C, Liquid Temperature: 22.3°C

Communication System: UNII-1 5825 Duty Cycle: 1:1

Probe: EX3DV4 – SN3617 ConvF(4.76,4.76,4.76)

Area Scan (71x121x1): Interpolated grid: dx=1.000 mm, dy=1.000 mm

Maximum value of SAR (interpolated) = 2.02 W/kg

Zoom Scan (7x7x7)/Cube 0: Measurement grid: dx=5mm, dy=5mm, dz=5mm

Reference Value = 0.848 V/m; Power Drift = 0.02 dB

Peak SAR (extrapolated) = 2.09 W/kg

SAR(1 g) = 0.447 W/kg; SAR(10 g) = 0.128 W/kg

Maximum value of SAR (measured) = 1.17 W/kg

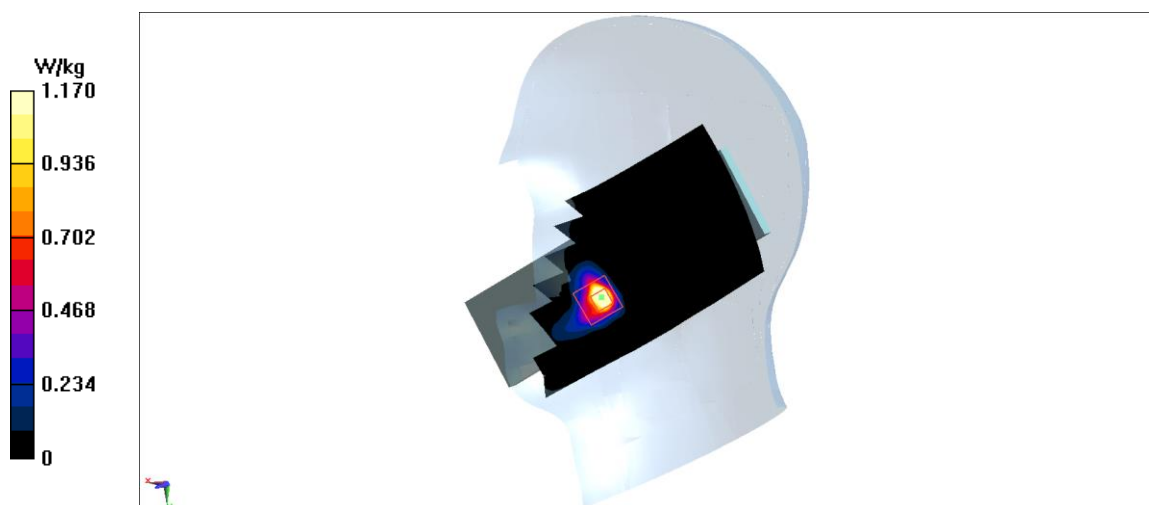

Fig A.29

UNII-3_CH165 Rear

Date: 9/6/2019

Electronics: DAE4 Sn771

Medium: body 5750 MHz

Medium parameters used: $f = 5825$; $\sigma = 5.599$ mho/m; $\epsilon_r = 47.42$; $\rho = 1000$ kg/m³

Ambient Temperature: 22.5°C, Liquid Temperature: 22.3°C

Communication System: UNII-3 5825 Duty Cycle: 1:1

Probe: EX3DV4 – SN3617 ConvF(4.36,4.36,4.36)

Area Scan (71x121x1): Interpolated grid: dx=1.000 mm, dy=1.000 mm

Maximum value of SAR (interpolated) = 0.669 W/kg

Zoom Scan (7x7x7)/Cube 0: Measurement grid: dx=5mm, dy=5mm, dz=5mm

Reference Value = 2.139 V/m; Power Drift = -0.1 dB

Peak SAR (extrapolated) = 1.13 W/kg

SAR(1 g) = 0.277 W/kg; SAR(10 g) = 0.103 W/kg

Maximum value of SAR (measured) = 0.639 W/kg

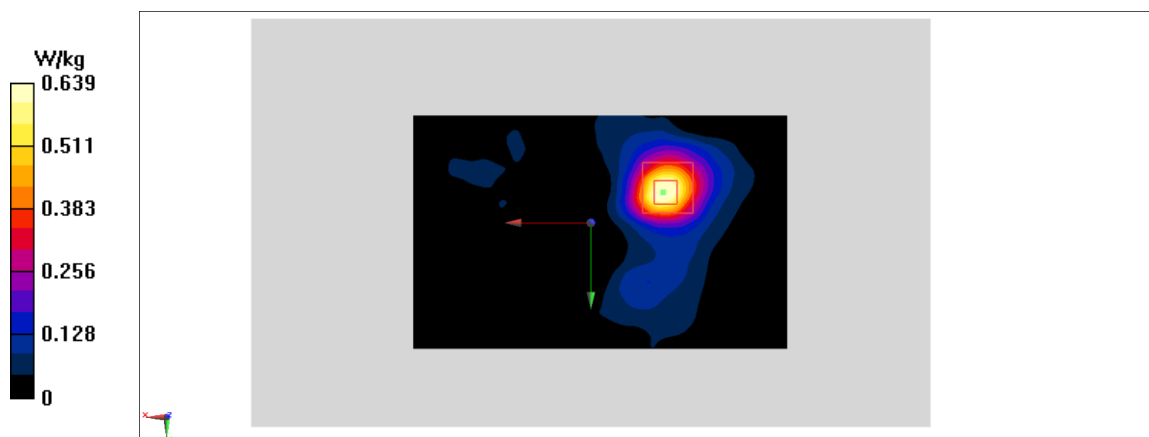

Fig A.30

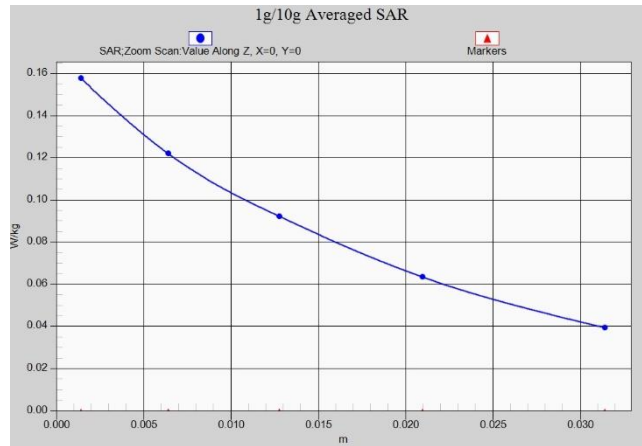

Fig.A.1- 1 Z-Scan at power reference point (GSM850)

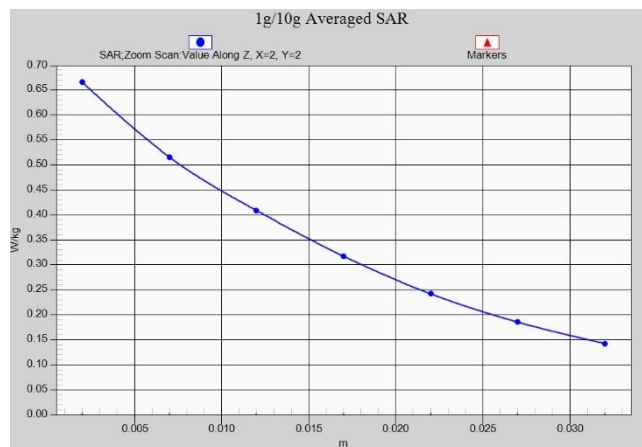

Fig.A.1- 2 Z-Scan at power reference point (GSM850)

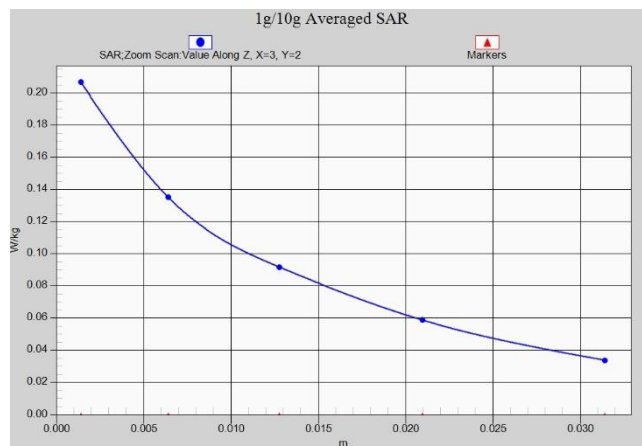

Fig.A.1- 3 Z-Scan at power reference point (PCS1900)

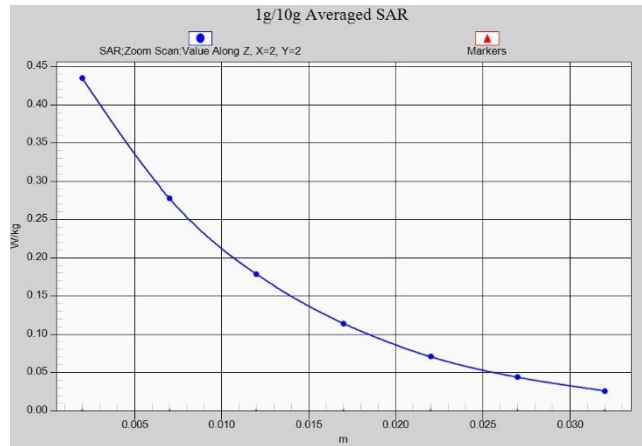

Fig.A.1- 4 Z-Scan at power reference point (PCS1900)

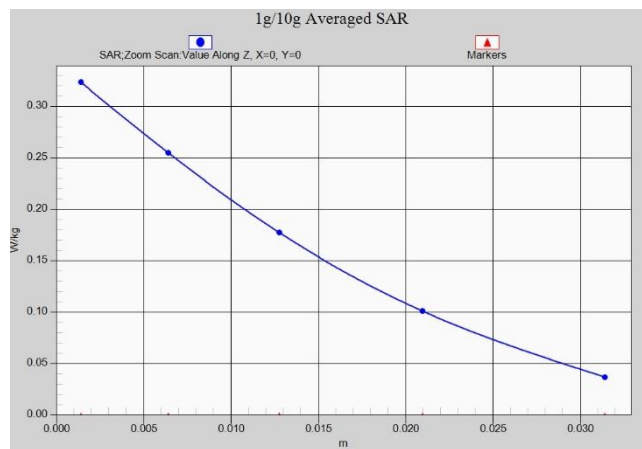

Fig.A.1- 5 Z-Scan at power reference point (W1900)

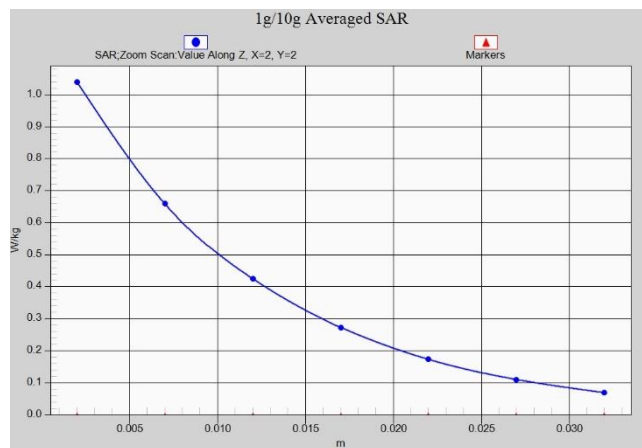

Fig.A.1- 6 Z-Scan at power reference point (W1900)

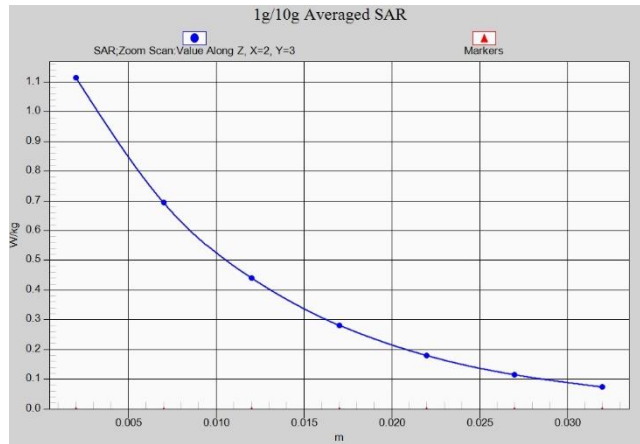

Fig.A.1- 7 Z-Scan at power reference point (W850)

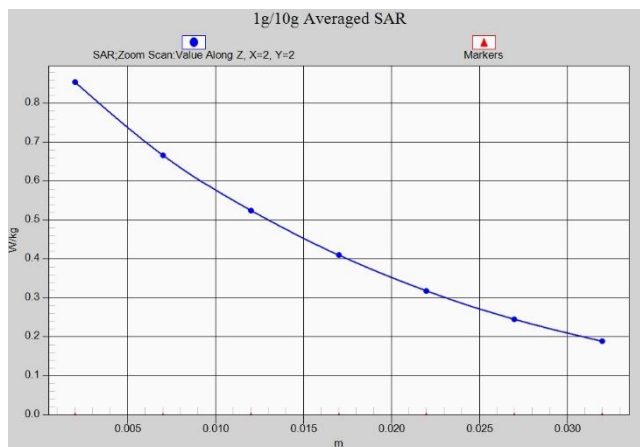

Fig.A.1- 8 Z-Scan at power reference point (W850)



Fig.A.1- 9 Z-Scan at power reference point (CDMABC0)

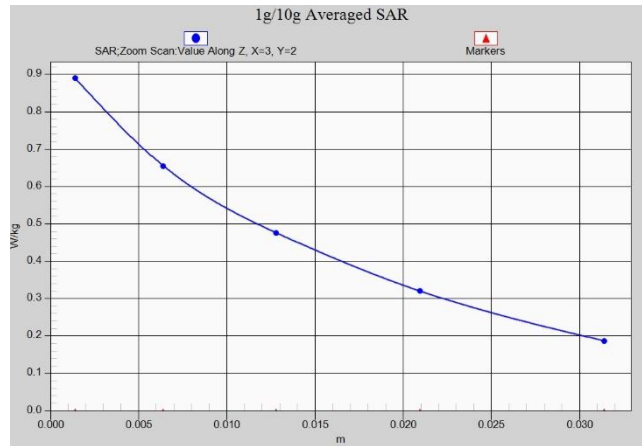

Fig.A.1- 10 Z-Scan at power reference point (CDMABC0)

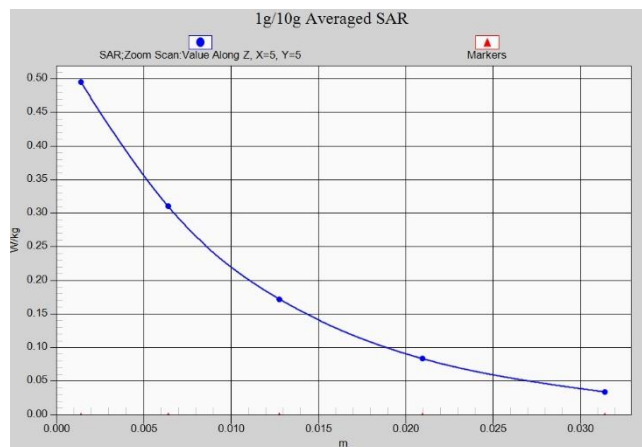

Fig.A.1- 11 Z-Scan at power reference point (CDMABC1)

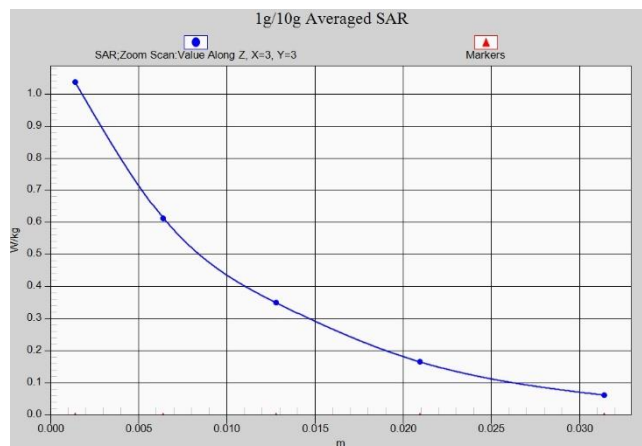

Fig.A.1- 12 Z-Scan at power reference point (CDMABC1)

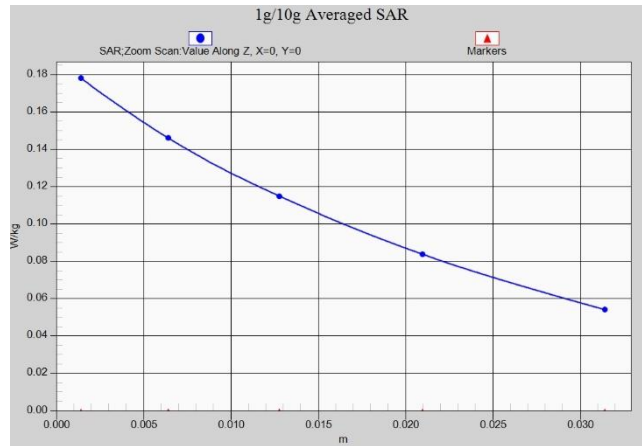

Fig.A.1- 13 Z-Scan at power reference point (CDMABC10)

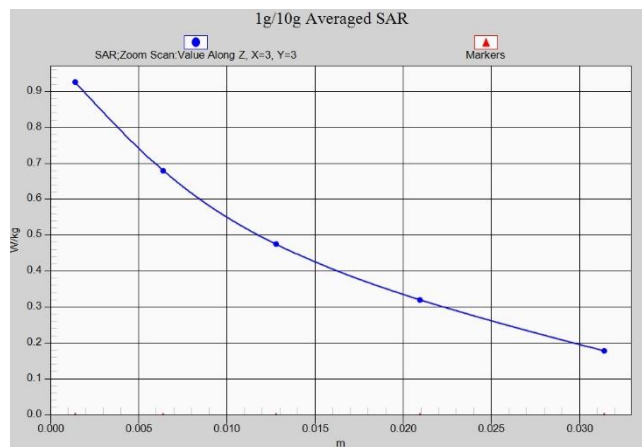

Fig.A.1- 14 Z-Scan at power reference point (CDMABC10)



Fig.A.1- 15 Z-Scan at power reference point (LTE band4)

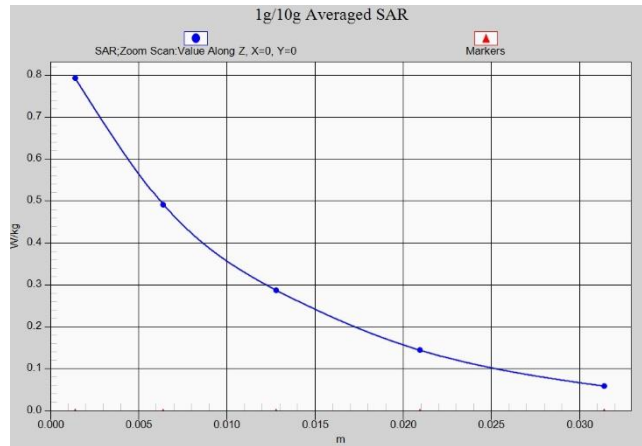

Fig.A.1- 16 Z-Scan at power reference point (LTE band4)

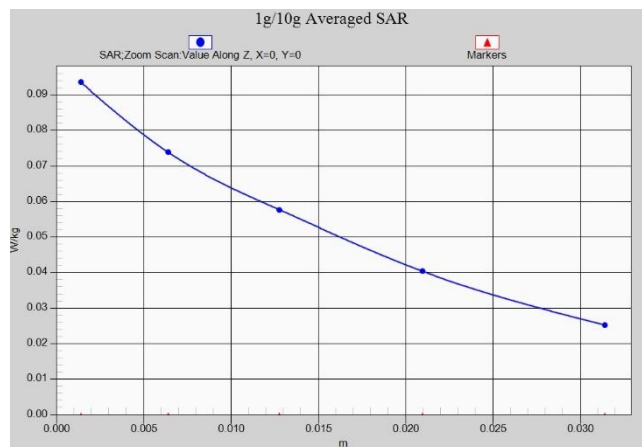

Fig.A.1- 17 Z-Scan at power reference point (LTE band13)

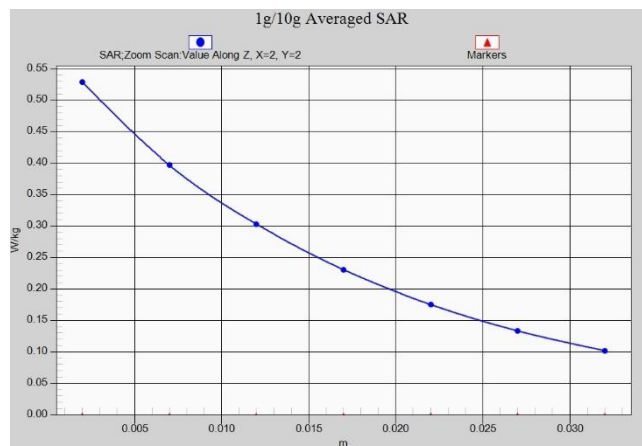

Fig.A.1- 18 Z-Scan at power reference point (LTE band13)

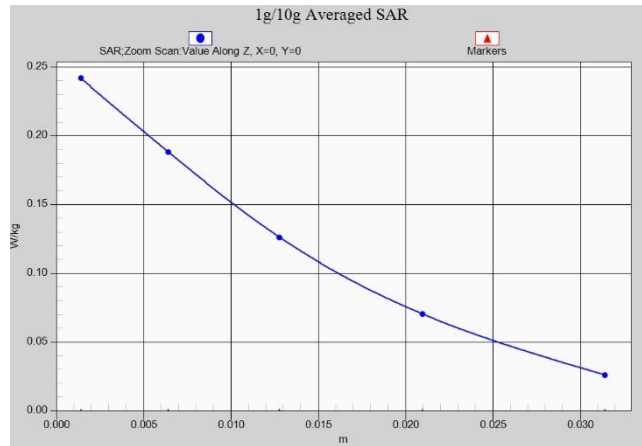

Fig.A.1- 19 Z-Scan at power reference point (LTE band25)

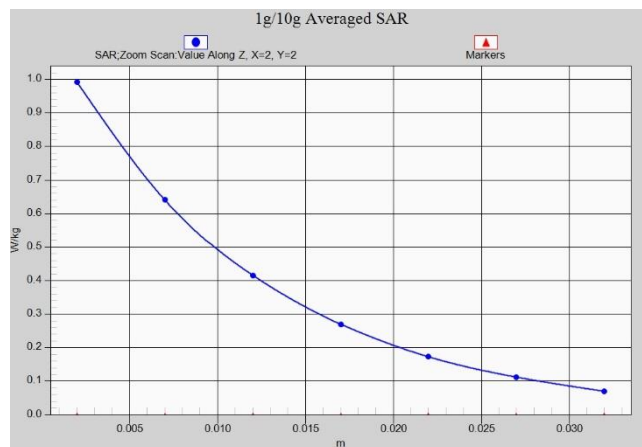

Fig.A.1- 20 Z-Scan at power reference point (LTE band25)



Fig.A.1- 21 Z-Scan at power reference point (LTE band26)

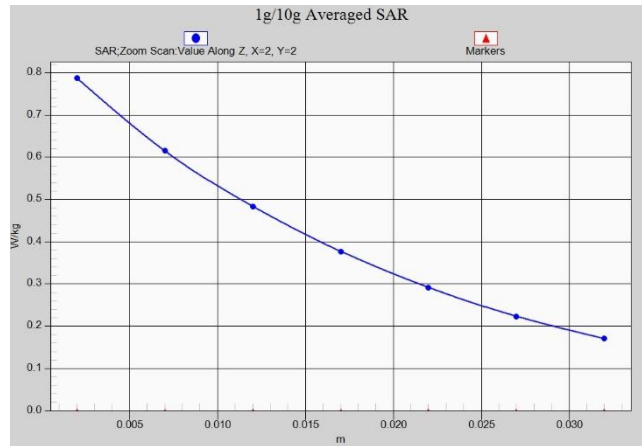

Fig.A.1- 22 Z-Scan at power reference point (LTE band26)

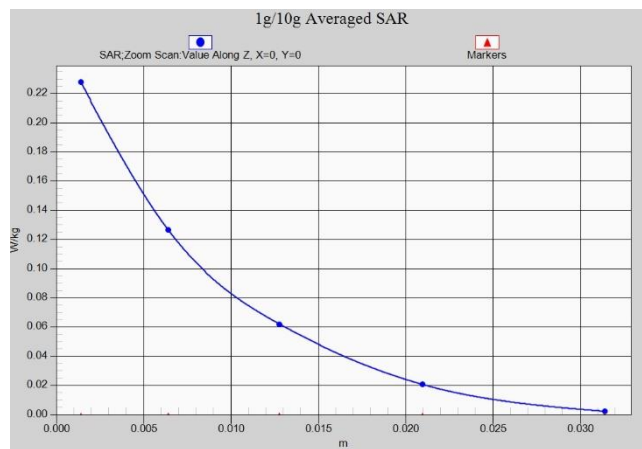

Fig.A.1- 23 Z-Scan at power reference point (LTE band41PC2)

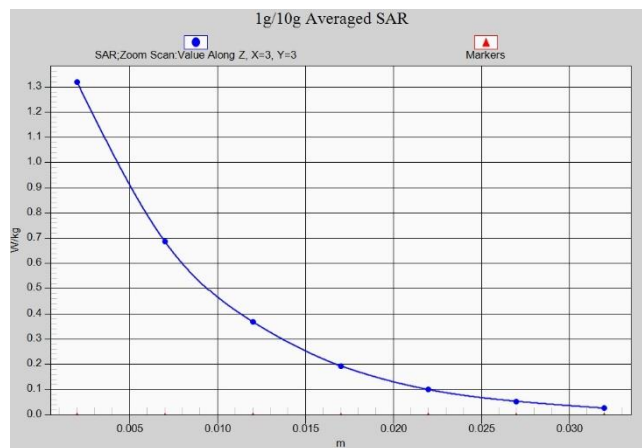

Fig.A.1-24 Z-Scan at power reference point (LTE band41PC2)

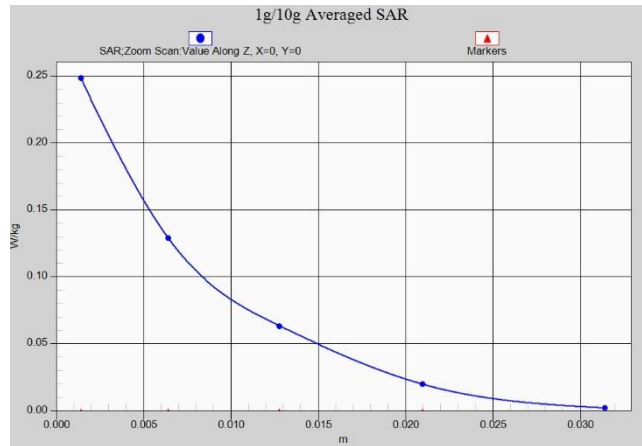

Fig.A.1- 25 Z-Scan at power reference point (LTE band41PC3)

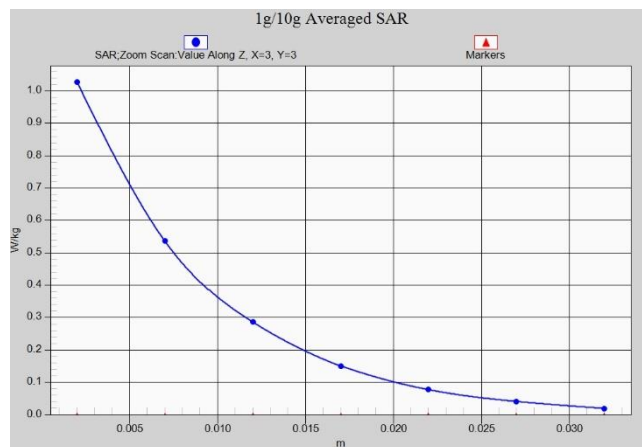

Fig.A.1-26 Z-Scan at power reference point (LTE band41PC3)

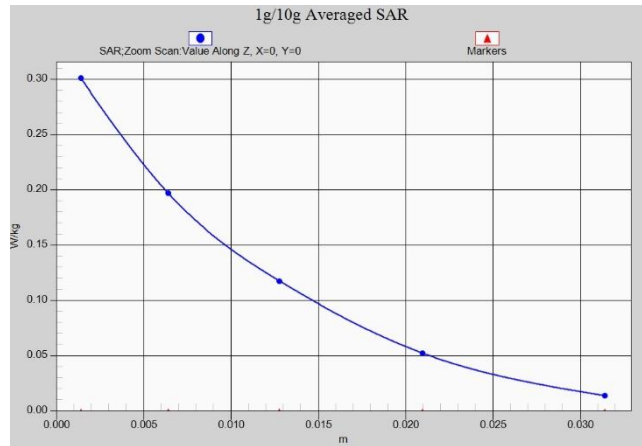

Fig.A.1-27 Z-Scan at power reference point (WLAN2.4G)

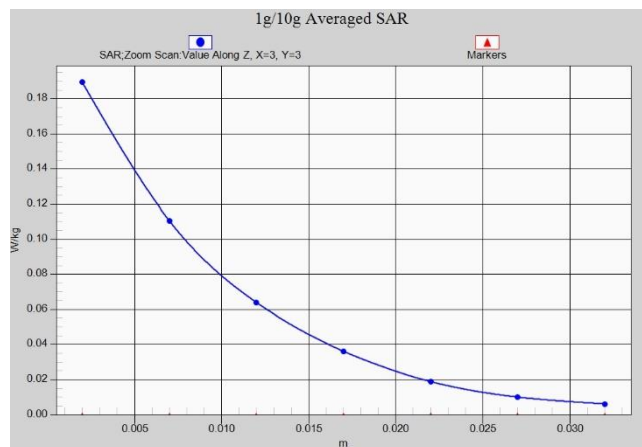

Fig.A.1-28 Z-Scan at power reference point (WLAN2.4G)



Fig.A.1-29 Z-Scan at power reference point (WLAN5G)

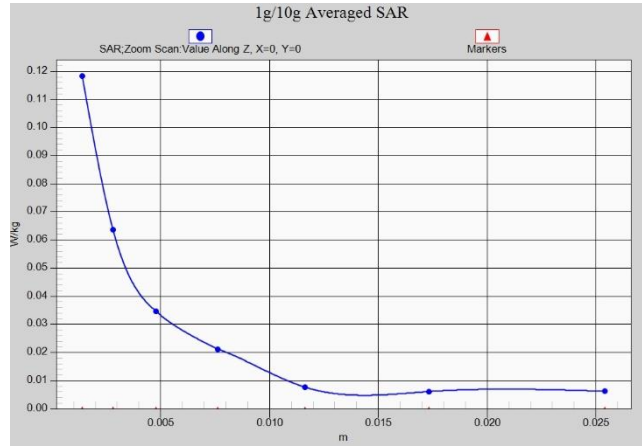

Fig.A.1-30 Z-Scan at power reference point (WLAN5G)

ANNEX B System Verification Results

750 MHz

Date: 8/2/2019

Electronics: DAE4 Sn771

Medium: Head 750 MHz

Medium parameters used: $f = 750$ MHz; $\sigma = 0.898$ mho/m; $\epsilon_r = 41.7$; $\rho = 1000$ kg/m³

Ambient Temperature: 22.5°C Liquid Temperature: 22.3°C

Communication System: CW Frequency: 750 MHz Duty Cycle: 1:1

Probe: EX3DV4 – SN3617 ConvF(10.03,10.03,10.03)

System Validation /Area Scan (81x191x1): Interpolated grid: dx=1.000 mm, dy=1.000 mm

Reference Value = 60.78 V/m; Power Drift = 0.03

Fast SAR: SAR(1 g) = 2.11 W/kg; SAR(10 g) = 1.42 W/kg

Maximum value of SAR (interpolated) = 2.78 W/kg

System Validation /Zoom Scan (7x7x7)/Cube 0: Measurement grid: dx=5mm, dy=5mm, dz=5mm

Reference Value =60.78 V/m; Power Drift = 0.03 dB

Peak SAR (extrapolated) = 3.16 W/kg

SAR(1 g) = 2.14 W/kg; SAR(10 g) = 1.38 W/kg

Maximum value of SAR (measured) = 2.83 W/kg

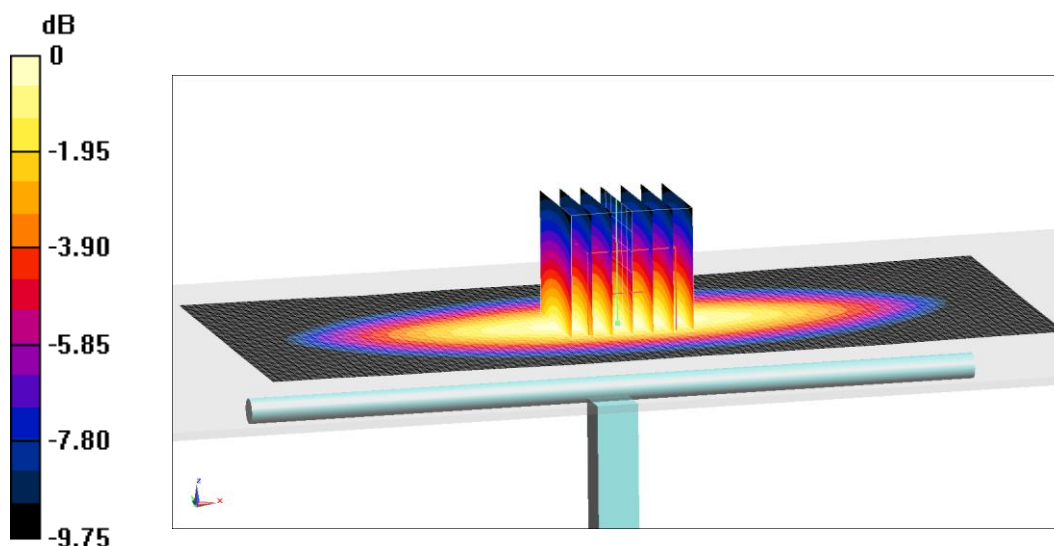

0 dB = 2.83 W/kg = 4.52 dB W/kg

Fig.B.1 validation 750 MHz 250mW

750 MHz

Date: 8/2/2019

Electronics: DAE4 Sn771

Medium: Body 750 MHz

Medium parameters used: $f = 750$ MHz; $\sigma = 0.951$ mho/m; $\epsilon_r = 55.35$; $\rho = 1000$ kg/m³

Ambient Temperature: 22.5°C Liquid Temperature: 22.3°C

Communication System: CW Frequency: 750 MHz Duty Cycle: 1:1

Probe: EX3DV4 – SN3617 ConvF(9.85,9.85,9.85)

System Validation /Area Scan (81x191x1): Interpolated grid: dx=1.000 mm, dy=1.000 mm

Reference Value = 58.82 V/m; Power Drift = -0.03

Fast SAR: SAR(1 g) = 2.13 W/kg; SAR(10 g) = 1.41 W/kg

Maximum value of SAR (interpolated) = 3.07 W/kg

System Validation /Zoom Scan (7x7x7)/Cube 0: Measurement grid: dx=5mm, dy=5mm, dz=5mm

Reference Value = 58.82 V/m; Power Drift = -0.03 dB

Peak SAR (extrapolated) = 3.17 W/kg

SAR(1 g) = 2.18 W/kg; SAR(10 g) = 1.4 W/kg

Maximum value of SAR (measured) = 2.82 W/kg

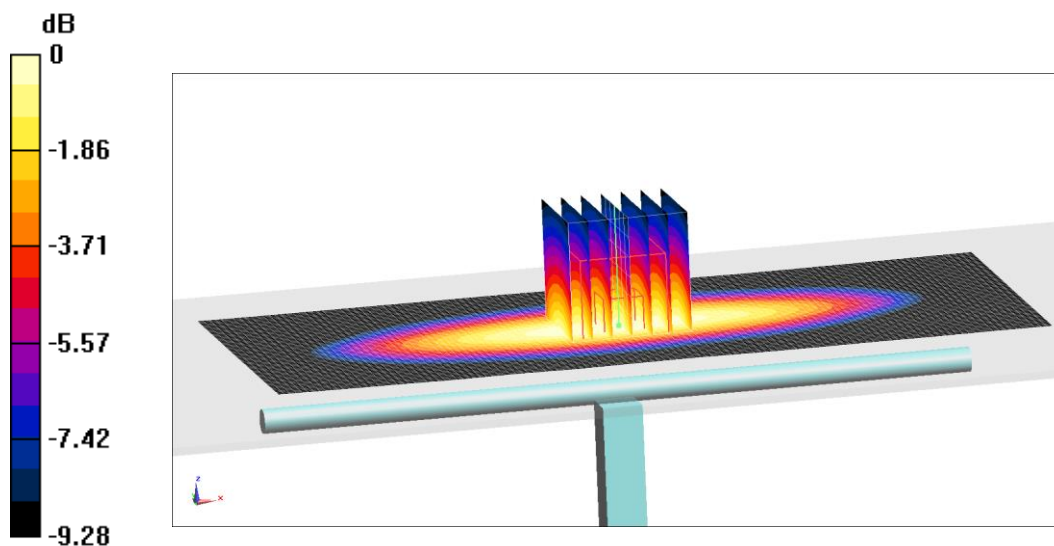

0 dB = 2.82 W/kg = 4.5 dB W/kg

Fig.B.2 validation 750 MHz 250mW