



**TEST REPORT**  
**No. I18Z60880-IOT09**  
**for**  
**TCL Communication Ltd.**

**GSM Quad-band/HSPA-UMTS Six-band/LTE 18-bands mobile phone**  
**BBE100-5**

**FCC ID: 2ACCJN029**

**with**

**Hardware Version: 04**

**Software Version: V6R13-6**

**Issued Date: 2018-06-20**



**Note:**

The test results in this test report relate only to the devices specified in this report. This report shall not be reproduced except in full without the written approval of CTTL.

The report must not be used by the client to claim product certification, approval, or endorsement by NVLAP, NIST, or any agency of the U.S. Government.

**Test Laboratory:**

CTTL, Telecommunication Technology Labs, CAICT

No. 52, Huayuan North Road, Haidian District, Beijing, P. R. China 100191.

Tel: +86(0)10-62304633-2512, Fax: +86(0)10-62304633-2504

Email: [ctl\\_terminals@caict.ac.cn](mailto:ctl_terminals@caict.ac.cn), website: [www.caict.ac.cn](http://www.caict.ac.cn)

## **CONTENTS**

<b>1. TEST LABORATORY</b> .....	<b>3</b>
1.1. TESTING LOCATION .....	3
1.2. TESTING ENVIRONMENT.....	3
1.3. PROJECT DATA.....	3
1.4. SIGNATURE .....	3
<b>2. CLIENT INFORMATION</b> .....	<b>4</b>
2.1. APPLICANT INFORMATION.....	4
2.2. MANUFACTURER INFORMATION .....	4
<b>3. EQUIPMENT UNDER TEST (EUT) AND ANCILLARY EQUIPMENT (AE)</b> .....	<b>5</b>
3.1. ABOUT EUT .....	5
3.2. INTERNAL IDENTIFICATION OF EUT USED DURING THE TEST .....	5
3.3. INTERNAL IDENTIFICATION OF AE USED DURING THE TEST.....	5
3.4. GENERAL DESCRIPTION.....	6
3.5. EUT SET-UPS .....	6
<b>4. REFERENCE DOCUMENTS</b> .....	<b>7</b>
4.1. DOCUMENTS SUPPLIED BY THE APPLICANT .....	7
4.2. REGULATIONS AND STANDARDS .....	7
<b>5. LABORATORY ENVIRONMENT</b> .....	<b>8</b>
<b>6. SUMMARY OF TEST RESULTS</b> .....	<b>9</b>
6.1. SUMMARY OF TEST RESULTS .....	9
6.2. TERMS USED IN THE SUMMARY OF TEST RESULTS .....	10
6.3. STATEMENTS .....	10
<b>7. TEST EQUIPMENT UTILIZED</b> .....	<b>11</b>
<b>ANNEX A: MEASUREMENT RESULTS</b> .....	<b>12</b>
A.1. ELECTRIC FIELD STRENGTH OF FUNDAMENTAL AND OUTSIDE THE ALLOCATED BANDS .....	12
A.2. ELECTRIC FIELD RADIATED EMISSIONS (< 30MHz) .....	14
A.3. ELECTRIC FIELD RADIATED EMISSIONS ( $\geq$ 30MHz) .....	16
A.4. FREQUENCY TOLERANCE .....	18
A.5. 20dB BANDWIDTH.....	19
A.6. CONDUCTED EMISSION .....	21
<b>ANNEX B: ACCREDITATION CERTIFICATE</b> .....	<b>23</b>

## 1. Test Laboratory

### 1.1. Testing Location

CTTL (Huayuan North Road)

Address: No. 52, Huayuan North Road, Haidian District, Beijing,  
P. R. China 100191

CTTL(Shouxiang)

Address: No. 51 Shouxiang Science Building, Xueyuan Road,  
Haidian District, Beijing, P. R. China 100191

### 1.2. Testing Environment

Normal Temperature: 15-35°C  
Extreme Temperature: -10/+55°C  
Relative Humidity: 20-75%

### 1.3. Project data

Testing Start Date: 2018-05-03  
Testing End Date: 2018-06-06

### 1.4. Signature

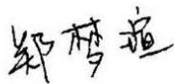

---

Zheng Mengxuan  
(Prepared this test report)



---

Zhu Liang  
(Reviewed this test report)

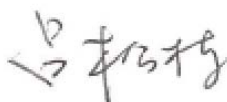

---

Lv Songdong  
(Approved this test report)



## **2. Client Information**

### **2.1. Applicant Information**

Company Name: TCL Communication Ltd.  
Address: 7/F, Block F4, TCL Communication Technology Building, TCL International E City, Zhong Shan Yuan Road, Nanshan District, Shenzhen, Guangdong, P.R. China 518052  
Country: China  
Contact: Gong Zhizhou  
Tel: 0086-755-36611722  
Email: zhizhou.gong@tcl.com

### **2.2. Manufacturer Information**

Company Name: TCL Communication Ltd.  
Address: 7/F, Block F4, TCL Communication Technology Building, TCL International E City, Zhong Shan Yuan Road, Nanshan District, Shenzhen, Guangdong, P.R. China 518052  
Country: China  
Contact: Gong Zhizhou  
Tel: 0086-755-36611722  
Email: zhizhou.gong@tcl.com

### 3. Equipment Under Test (EUT) and Ancillary Equipment (AE)

#### 3.1. About EUT

Description:	GSM Quad-band/HSPA-UMTS Six-band/LTE 18-bands mobile phone
FCC ID	2ACCJN029
With NFC Function:	Yes
Frequency:	13.56 MHz
Antenna:	Internal
Operation Voltage:	3.6VDC to 4.4VDC (nominal: 3.85VDC)
Operation Temperature:	-10°C to +55°C

Note1: Photographs of EUT are shown in ANNEX B of this test report. For component list, please refer to documents of the manufacturer.

#### 3.2. Internal Identification of EUT Used during the Test

##### Mobile phone identification

EUT ID*	IMEI	HW Version	SW Version
EUT8	015138000009390	04	V6R13-6
EUT42	015138000009556	04	V6R13-6

\*EUT ID: is used to identify the test sample in the lab internally.

#### 3.3. Internal Identification of AE Used during the Test

AE ID*	Description	SN	Reversion
AE1	Battery	/	/
AE2	Charger	/	/
AE3	USB Cable	/	/
AE4	USB Cable	/	/
AE5	Charger	/	/
AE10	PICCC Card	/	/

##### AE1

Model	TLp029C1
Manufacturer	BYD
Capacitance	2900mAh
Nominal voltage	3.85V

##### AE2

Model	CBA0064AGBC1
Manufacturer	BYD
Length of cable	/

AE3

Model CDA0000119CF  
 Manufacturer LUXSHARE  
 Length of cable /

AE4

Model CDA0000119C1  
 Manufacturer Juwei  
 Length of cable /

AE5

Model CBA0064AHBC1  
 Manufacturer BYD  
 Length of cable /

AE10

Type /  
 Manufacturer /  
 Type of card PICC

\*AE ID: is used to identify the test sample in the lab internally.

### 3.4. General Description

This is a product supporting GSM Quad-band/HSPA-UMTS Six-band/LTE 18-bands mobile phone BBE100-5 manufactured by TCL Communication Ltd. It's a variant model based on BBE100-2 for conformance test. According to the declaration of changes, the results are inherited from the initial model. The report number of initial model is I18Z60272-IOT11.

Manuals and specifications of the EUT were provided to fulfil the test.

Samples undergoing test were selected by the client.

Manufacturer's declaration: NFC work does not depend on other access methods, such as WLAN, GPRS, etc.

### 3.5. EUT Set-ups

EUT Set-up No.	Combination of EUT and AE	Remarks
Set. NFC01	EUT8 + AE2 + AE3 + AE10	--
Set. NFC02	EUT42	--
Set. NFC03	EUT8 + AE10	--

The Transmit State of NFC: the NFC function is on. The EUT will transmit the NFC data and command continuously during the test.

The Transmit State of without modulation: The EUT will transmit the CW signal at the operating frequency.



#### **4. Reference Documents**

##### **4.1. Documents Supplied by the Applicant**

EUT feature information is supplied by the applicant or manufacturer, which is the basis of testing.

##### **4.2. Regulations and Standards**

The following documents listed in this section are referred for testing.

<b>Reference</b>	<b>Title</b>	<b>Version</b>
CFR 47 Part 2	Part 2 — Frequency Allocations and Radio Treaty Matters; General Rules and Regulations.	2016
CFR 47 Part 15	Part 15 — Radio Frequency Devices. Subpart C — Intentional Radiators. § 15.35 Measurement detector functions and bandwidths. § 15.207 Conducted limits. § 15.209 Radiated emission limits, general requirements. § 15.215 Additional provisions to the general radiated emission limitations. § 15.225 Operation within the band 13.110–14.010 MHz.	2016
ANSI C63.10	American National Standard of Procedures for Compliance Testing of Unlicensed Wireless Devices	2013

## 5. LABORATORY ENVIRONMENT

**Semi-anechoic chamber SAC-1** (23 meters×17meters×10meters) did not exceed following limits along the EMC testing:

Temperature	Min. = 15 °C, Max. = 35 °C
Relative humidity	Min. = 15 %, Max. = 75 %
Shielding effectiveness	0.014MHz - 1MHz, >60dB; 1MHz - 1000MHz, >90dB.
Electrical insulation	> 2 MΩ
Ground system resistance	< 4Ω
Normalised site attenuation (NSA)	< ± 4 dB, 3m/10m distance, from 30 to 1000 MHz
Site voltage standing-wave ratio ( $S_{VSWR}$ )	Between 0 and 6 dB, from 1GHz to 18GHz
Uniformity of field strength	Between 0 and 6 dB, from 80 to 3000 MHz

**Fully-Anechoic Chamber FAC-3** (8.6m×6.1m×3.85m) did not exceed following limits along the testing:

Temperature	Min. = 15 °C, Max. = 25 °C
Relative humidity	Min. = 30 %, Max. = 60 %
Shielding effectiveness	> 110 dB
Electrical insulation	> 2 MΩ
Ground system resistance	< 1 Ω
Site voltage standing-wave ratio ( $S_{VSWR}$ )	Between 0 and 6 dB, from 1 to 18GHz
Uniformity of field strength	Between 0 and 6 dB, from 80 to 4000 MHz

**Conducted Chamber** did not exceed following limits along the testing:

Temperature	Min. = 15 °C, Max. = 25 °C
Relative humidity	Min. = 30 %, Max. = 60 %
Shielding effectiveness	> 110 dB
Electrical insulation	> 2 MΩ
Ground system resistance	< 0.5 Ω

**Control Room** did not exceed following limits along the testing:

Temperature	Min. = 15 °C, Max. = 25 °C
Relative humidity	Min. =30 %, Max. = 60 %
Shielding effectiveness	> 110 dB
Electrical insulation	> 2 MΩ
Ground system resistance	< 0.5 Ω



## 6. SUMMARY OF TEST RESULTS

### 6.1. Summary of Test Results

No	Test Cases	Clause in Regulation	Section in This Report	Verdict
1	Electric Field Strength of Fundamental Emissions	CFR 47 § 15.225(a)	A.1	P (Set. NFC03)
2	Electric Field Strength of Outside the Allocated Bands	CFR 47 § 15.225(b) CFR 47 § 15.225(c)		P (Set. NFC03)
3	Electric Field Radiated Emissions	CFR 47 § 15.209	A.2	P (Set. NFC01)
		CFR 47 § 15.225(d)	A.3	P (Set. NFC01)
4	Frequency Tolerance	CFR 47 § 15.225(e)	A.4	P (Set. NFC02)
5	20dB Bandwidth	CFR 47 § 15.215(c)	A.5	P (Set. NFC02, 03)
6	Conducted Emissions	CFR 47 § 15.207	A.6	P (Set. NFC01)
The measurement is carried out according to ANSI C63.10. See <b>ANNEX A</b> for details.				

#### Test Conditions:

For this report, all the test cases listed above were tested under normal Temperature, Voltage, humidity, and Air Pressure. The specific conditions are as following:

Temperature	T min	-20 °C
	T nom	25 °C
	T max	55 °C
Voltage	V min	3.6 V
	V nom	3.8 V
	V max	4.2 V
Humidity	H nom	44%
Air Pressure	A nom	1010 mbar

## 6.2. Terms Used in the Summary of Test Results

### Terms Used in Condition Column:

T nom	Normal Temperature
T min	Low Temperature
T max	High Temperature
V nom	Normal Voltage
V min	Low Voltage
V max	High voltage
H nom	Norm Humidity
A nom	Norm Air Pressure

### Terms Used in Verdict Column:

P	Pass, The EUT complies with the essential requirements in the standard.
NP	Not Perform, The test was not performed by CTTL
NA	Not Applicable, The test was not applicable
F	Fail, The EUT does not comply with the essential requirements in the standard

### Abbreviations:

AC	Alternating Current
AFH	Adaptive Frequency Hopping
BW	Band Width
E.I.R.P.	equivalent is tropical radiated power
ISM	Industrial, Scientific and Medical
RF	Radio Frequency
Tx	Transmitter

## 6.3. Statements

The test cases listed in Section 6.1 of this report for the EUT specified in Section 3 were performed by CTTL according to the reference documents in Section 4.

The EUT meets all applicable requirements of the regulations and standards in Section 4.2.

This report only deals with the NFC function among the features described in section 3.



## 7. Test Equipment Utilized

NO.	NAME	TYPE	SERIES NUMBER	PRODUCER	CAL. DUE DATE	CAL. INTERVAL
1.	Spectrum Analyzer	RSA3408A	B010277	Tektronix	2018-09-04	1 Year
2.	Climatic chamber	SH242	93008658	Key sight	2018-11-27	1 Year
3.	H-field Antenna	HFH2-Z2	829324/0007	R&S	2019-01-13	1 Year
4.	EMI Antenna	VULB9163	514	Schwarz beck	2021-01-03	3 years
5.	Test Receiver	ESCI 7	100948	R&S	2018-07-25	1 Year
6.	Universal Radio Communication Tester	ESU26	100376	R&S	2018-12-30	1 year
7.	LISN	ENY216	101200	R&S	2019-04-15	1 year

## **ANNEX A: MEASUREMENT RESULTS**

### **A.1. Electric Field Strength of Fundamental and Outside the Allocated bands**

#### **A.1.1. Reference**

See Clause 6.4 of ANSI C63.10-2013 specifically.

See Clause 4 and Clause 5 of ANSI C63.10-2013 generally.

#### **A.1.2. Measurement Methods**

The transmitter carrier output levels (E-Field) from the EUT are measured in a semi-anechoic chamber. The EUT is placed on a non-conductive stand of 80cm high, and at a measurement distance of 3m from the receiving antenna. The center of the receiving loop antenna is 1.0 meter above the ground. The E-field is measured with a shielded loop antenna connected to a measurement receiver. Detected E-field was maximized by rotating the EUT through 360° and adjusting the receiving antenna polarizations. The maximization processes were repeated with the EUT positioned respectively in its three orthogonal axes. The measurements were performed with the peak detector and if required, the quasi-peak detector.

The measurement bandwidth is:

Frequency of Emission (MHz)	RBW/VBW
12.56-14.56	10/30 kHz

The E-field measured at 3m is calculated as:

$$\text{E-field (dB}\mu\text{V/m)} = \text{Rx (dB}\mu\text{V)} + \text{Cable Loss (dB)} + \text{AF@3m (dB/m)}$$

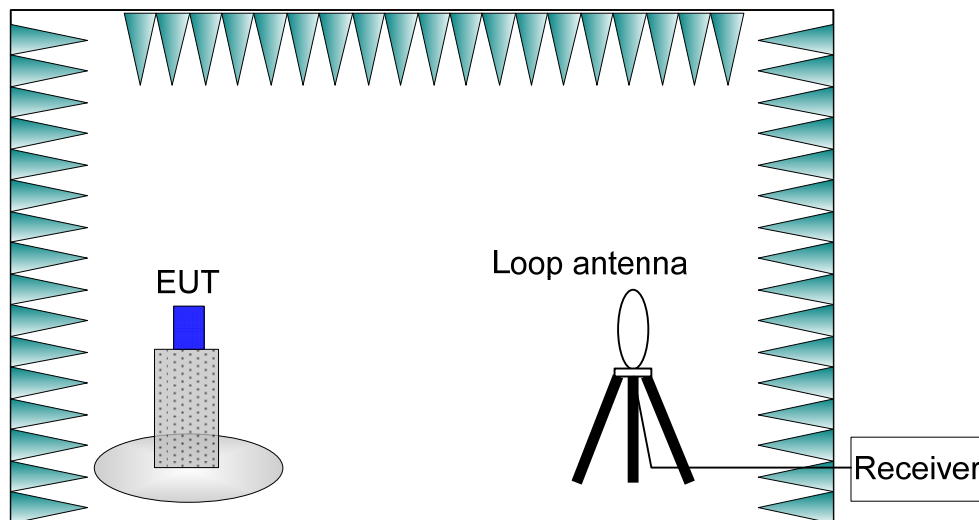

#### **A.1.3. EUT Operating Mode and Test Conditions**

The measurement of EUT is carried out under the transmit state of NFC (See 3.5).

The EUT is powered by a travel adapter.

During the measurements, the ambient temperature of the electromagnetic anechoic chamber is in the range of 15 ~ 25 °C.

#### A.1.4. Limits

Frequency Range (MHz)	E-field Strength Limit @ 30 m ( $\mu\text{V/m}$ )	E-field Strength Limit @ 3 m ( $\text{dB}\mu\text{V/m}$ )
13.560 $\pm$ 0.007	+15,848	124
13.410 to 13.553 13.567 to 13.710	+334	90
13.110 to 13.410 13.710 to 14.010	+106	81

Note: Where the limits have been defined at one distance, and a signal level measured at another, the limits have been extrapolated using the following formula:

$$\text{Extrapolation(dB)} = 40\log_{10}(\text{Measurement Distance}/\text{Specification Distance})$$

#### A.1.5. Measurement Results

Measurement results of normal conditions see Figure A-1 for different set-ups of EUT. The result displayed take into account applicable antenna factors and cable losses.

**Conclusions:** Set. NFC03, **PASS**.

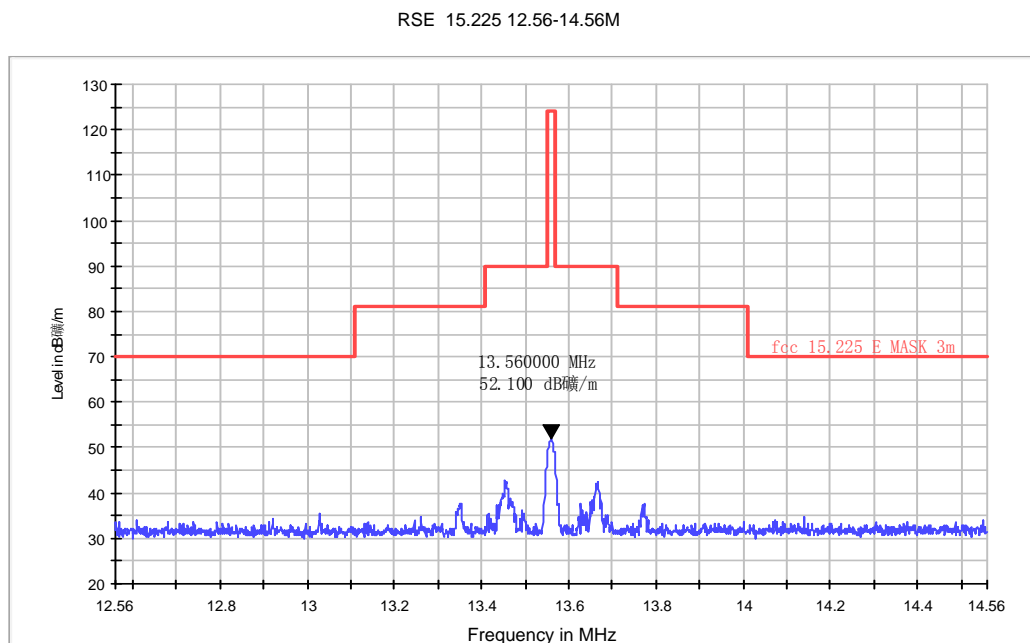

**Figure A-1: Set. NFC03**

#### A.1.6. Measurement Uncertainty

Measurement uncertainty:  $U = 4.0 \text{ dB}$ ,  $k=2$ .

## **A.2. Electric Field Radiated Emissions (< 30MHz)**

### **A.2.1. Reference**

See Clause 6.4 of ANSI C63.10-2013 specifically.

See Clause 4 and Clause 5 of ANSI C63.10-2013 generally.

### **A.2.2. Measurement Methods**

The transmitter carrier output levels (E-Field) from the EUT are measured in a semi-anechoic chamber. The EUT is placed on a non-conductive stand of 80cm high, and at a measurement distance of 3m from the receiving antenna. The center of the receiving loop antenna is 1.0 meter above the ground. The E-field is measured with a shielded loop antenna connected to a measurement receiver. Detected E-field was maximized by rotating the EUT through 360° and adjusting the receiving antenna polarizations. The maximization processes were repeated with the EUT positioned respectively in its three orthogonal axes. The measurements were performed with the peak detector and if required, the quasi-peak detector.

The measurement bandwidth is:

Frequency of Emission (MHz)	RBW/VBW
0.009-0.15	100/300 Hz
0.15-30	10/30 kHz

The E-field measured at 3m is calculated as:

$$\text{E-field (dB}\mu\text{V/m)} = \text{Rx (dB}\mu\text{V)} + \text{Cable Loss (dB)} + \text{AF@3m (dB/m)}$$

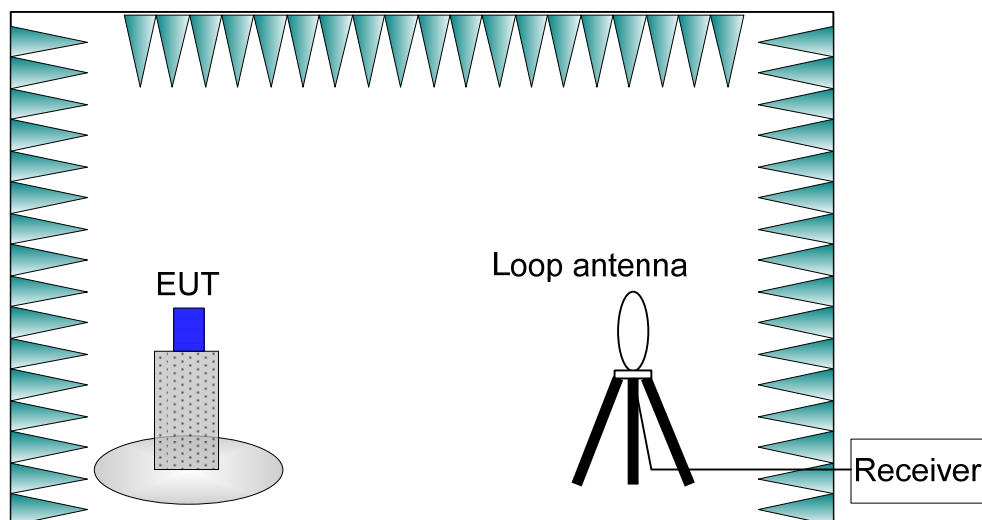

### **A.2.3. EUT Operating Mode and Test Conditions**

The measurement of EUT is carried out under the transmit state of NFC (See 3.5).

The EUT is powered by a travel adapter.

During the measurements, the ambient temperature of the electromagnetic anechoic chamber is in the range of 15 ~ 25 °C.

#### A.2.4. Limits

Frequency Range (MHz)	E-field Strength Limit @ 30m (mV/m)	E-field Strength Limit @ 3m (dB $\mu$ V/m)
0.009-0.490	2400/F(kHz)	129-94
0.490-1.705	24000/F(kHz)	74-63
1.705-30	30	70

Note: Where the limits have been defined at one distance, and a signal level measured at another, the limits have been extrapolated using the following formula:

$$\text{Extrapolation(dB)} = 40\log_{10}(\text{Measurement Distance}/\text{Specification Distance})$$

#### A.2.5. Measurement Results

Measurement results of normal conditions see Figure A-2 for different set-ups of EUT. The result displayed take into account applicable antenna factors and cable losses.

**Conclusions:** Set. NFC01, **PASS**.

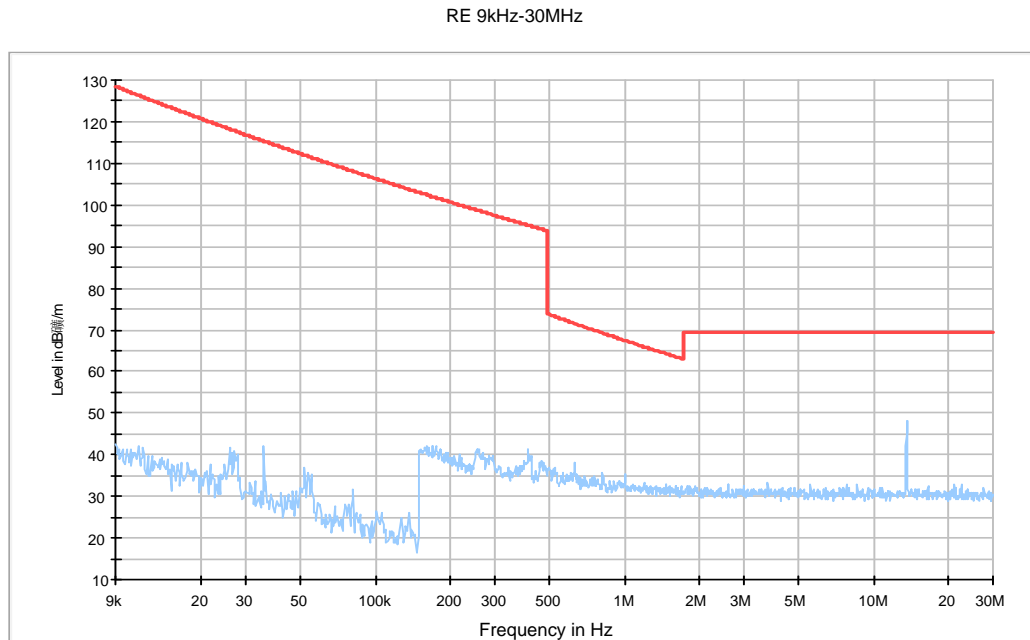

**Figure A-2: Set. NFC01**

#### A.2.6. Measurement Uncertainty

Measurement uncertainty:  $U = 4.0$  dB,  $k=2$ .

### **A.3. Electric Field Radiated Emissions ( $\geq 30\text{MHz}$ )**

#### **A.3.1. Reference**

See Clause 6.5 of ANSI C63.10-2013 specifically.

See Clause 4 and Clause 5 of ANSI C63.10-2013 generally.

#### **A.3.2. Measurement Methods**

The electric field radiated emissions from the EUT are measured in a semi-anechoic chamber. The EUT is placed on a non-conductive stand of 80cm high, and at a measurement distance of 10m from the receiving antenna. The receiving antennas connected to a measurement receiver. In order to search for maximum field strength emitted from the EUT, the receiving antenna can be moved between the height of 1.0 m to 4.0 m. Detected E-field was maximized at each frequency by rotating the EUT through 360° and adjusting the receiving antenna positions for both vertical and horizontal antenna polarizations. The maximization processes were repeated with the EUT positioned respectively in its three orthogonal axes. The measurements were performed with the peak detector and if required, the quasi-peak detector.

The measurement bandwidth is:

Frequency of Emission (MHz)	RBW/VBW
30-1000	120kHz

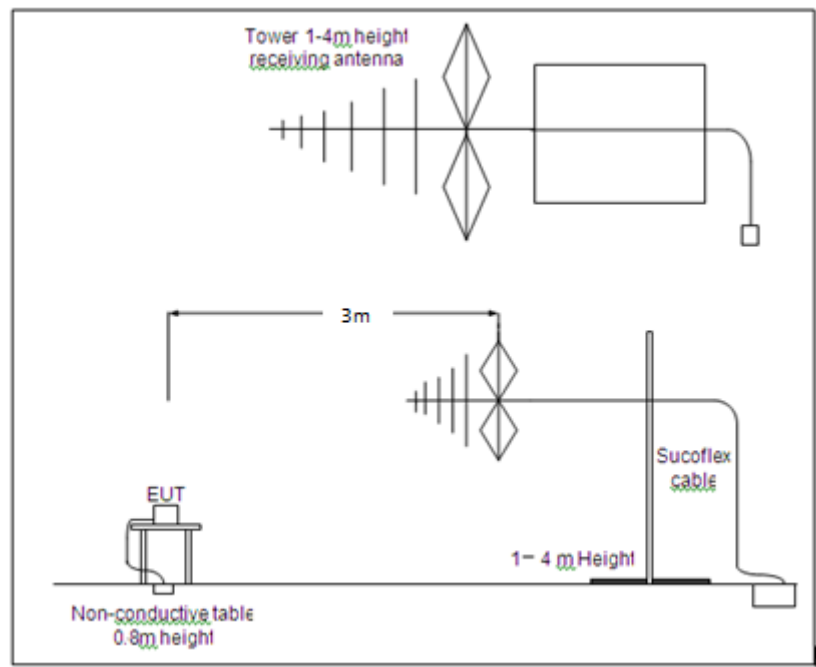

#### **A.3.3. EUT Operating Mode and Test Conditions**

The measurement of EUT is carried out under the transmit state of NFC (See 3.5).

EUT1 had been connected to a travel adapter.

During the measurements, the ambient temperature of the electromagnetic anechoic chamber is in the range of 15 ~ 25 °C.



### A.3.4. Limits

Frequency Range (MHz)	E-field Strength Limit @ 3m (mV/m)	E-field Strength Limit @ 3m (dB $\mu$ V/m)	E-field Strength Limit @ 10m (dB $\mu$ V/m)
30-88	100	40	30
88-216	150	43.5	33.5
216-960	200	46	36
960-1000	500	54	44

### A.3.5. Measurement Results

Measurement results of normal conditions see Figure A-3 for different set-ups of EUT. The result displayed take into account applicable antenna factors and cable losses.

**Conclusions:** Set. NFC01, **PASS**.

### A.3.6. Measurement Uncertainty

Measurement uncertainty:  $U = 5.4$  dB

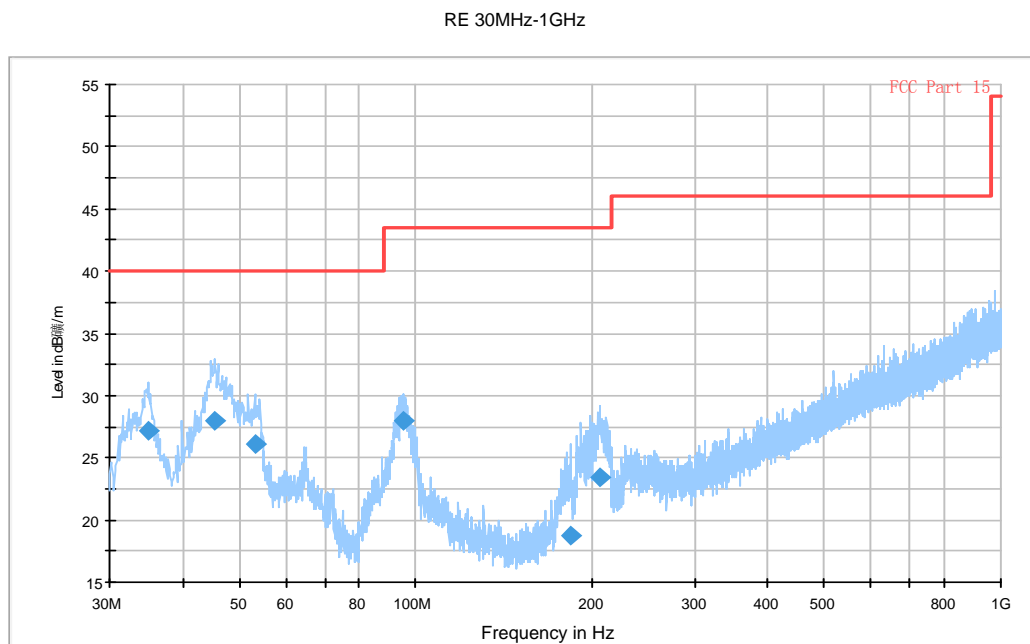

Figure A-3: Set. NFC01

## Final Result 1

Frequency (MHz)	QuasiPeak (dB $\mu$ V/m)	Height (cm)	Polarization	Azimuth (deg)	Corr. (dB)	Margin (dB)	Limit (dB $\mu$ V/m)
34.947000	27.1	100.0	H	-38.0	-0.4	12.9	40.0
45.423000	28.0	100.0	H	39.0	0.5	12.0	40.0
53.086000	26.1	100.0	H	0.0	0.4	13.9	40.0
95.184000	28.0	125.0	H	-38.0	-2.2	15.5	43.5
183.84200	18.7	100.0	H	-31.0	-2.8	24.8	43.5
206.34600	23.4	100.0	H	0.0	-1.5	20.1	43.5

## **A.4. Frequency Tolerance**

### **A.4.1. Reference**

See Clause 13.6 of ANSI C63.4-2014 specifically.

See Clause 4, Clause 5, and Clause 6 of ANSI C63.4-2014 generally.

### **A.4.2. Measurement Methods**

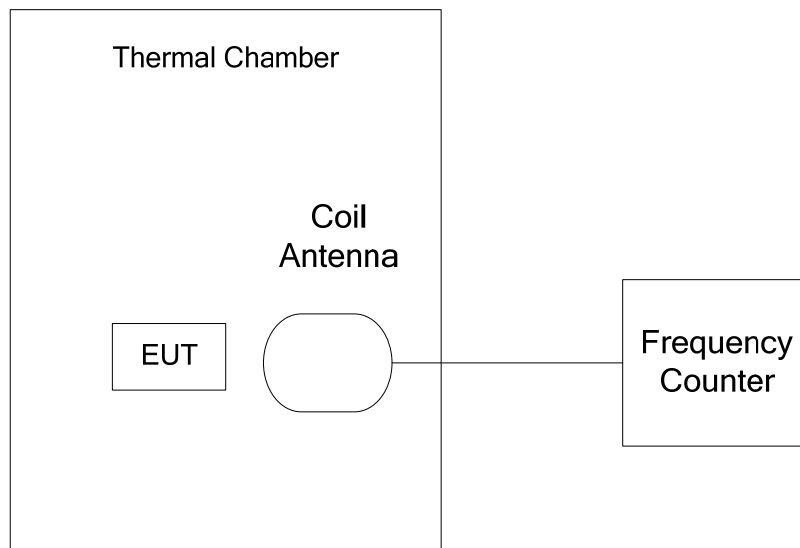

The transmitter output signal was picked up by coil antenna connected to the frequency counter. The center frequency was measured with 30Hz RBW and 1kHz span.

During the test, the EUT was placed in a thermal chamber until thermal balance and lasting appropriate time.

### **A.4.3. EUT Operating Mode and Test Conditions**

The measurement of EUT is carried out under the transmit state of without modulation (See 3.5).

EUT1 had been not connected to a travel adapter.

Operation Temperature: T min, T nom, and T max with V nom.

Operation Voltage: V min and V max with T nom.

### **A.4.4. Test Layouts**

See A.4.2.

### **A.4.5. Limits**

The frequency tolerance of the carrier signal shall be maintained within +/- 0.01% of the operating frequency.

### **A.4.6. Measurement Results**

Measurement results see Table A-1 for different test conditions.

**Conclusions:** Set. NFC02, **PASS**.

**Table A-1: Frequency Stability VS Temperature and Voltage**

Temperature	Voltage	Frequency Error (MHz)			
		Startup	2 Min Later	5 Min Later	10 Min Later
T min	V nom	13.5639250	13.5597500	13.5581875	13.5597500
T max	V nom	13.5597500	13.5589875	13.5633375	13.5599875
T nom	V nom	13.5598375	13.5597500	13.5612125	13.5597125
T nom	V min	13.5598625	13.5612125	13.5638250	13.5600625
T nom	V max	13.5583250	13.5598250	13.5601750	13.5589750

Temperature	Voltage	Frequency Error (%)			
		Startup	2 Min Later	5 Min Later	10 Min Later
T min	V nom	0.029	-0.002	-0.013	-0.002
T max	V nom	-0.002	-0.007	0.025	0.000
T nom	V nom	-0.001	-0.002	0.009	-0.002
T nom	V min	-0.001	0.009	0.028	0.000
T nom	V max	-0.012	-0.001	0.001	-0.008

**A.4.7. Measurement Uncertainty**

Measurement uncertainty:  $U = 77 \text{ Hz}$ ,  $k=2$

**A.5. 20dB Bandwidth**

**A.5.1. Reference**

See Clause 13.7 of ANSI C63.4-2014 specifically.

See Clause 4, Clause 5, and Clause 6 of ANSI C63.4-2014 generally.

**A.5.2. Measurement Methods**

The transmitter output signal was picked up by coil antenna to the spectrum analyzer.

The transmitter output signal was picked up by coil antenna connected to the spectrum analyzer.

The bandwidth of the center frequency was measured with 140Hz RBW, 420Hz VBW and 14kHz span.

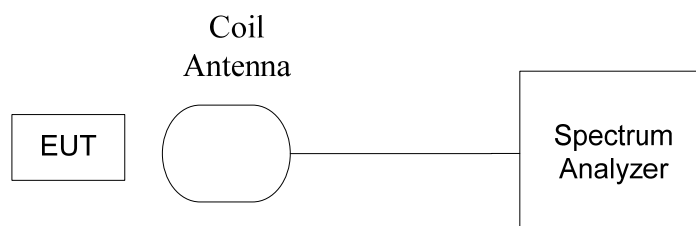

### A.5.3. EUT Operating Mode and Test Conditions

The measurement of EUT is carried out under the transmit state of NFC and without modulation (See 3.5).

EUT had been not connected to a travel adapter.

During the measurements, the ambient temperature is in the range of 15 ~ 25 °C.

### A.5.4. Test Layouts

See A.5.2.

### A.5.5. Limits

The 20dB bandwidth shall be less than 80% of the permitted frequency band. For 13.56 MHz NFC, the permitted frequency band is 14kHz, so the limit is 11.2 kHz.

### A.5.6. Measurement Results

Measurement results see Figure A-4.

**Conclusions:** Set. NFC02, **PASS**.

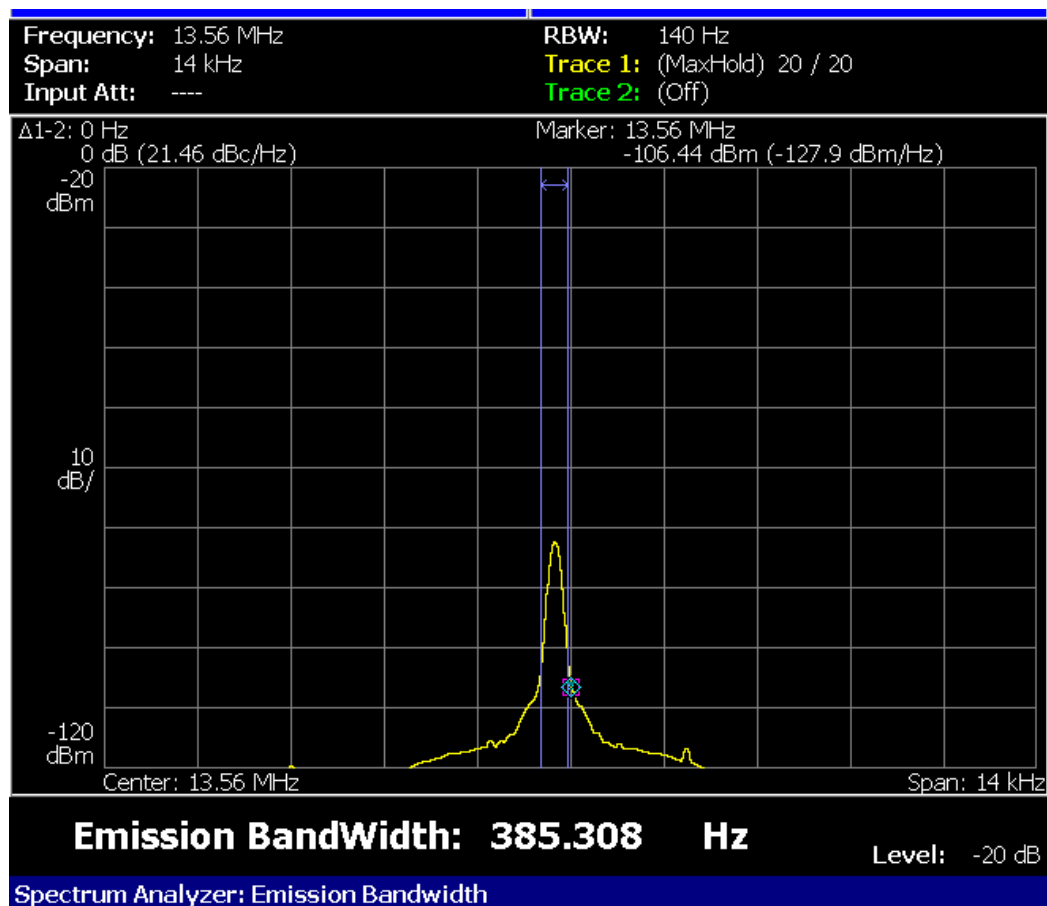

Figure A-4: Test result of EUT42 at test set. NFC02

### A.5.7. Measurement Uncertainty

Measurement uncertainty:  $U = 77$  Hz,  $k=2$

## **A.6. Conducted emission**

### **A.6.1. Reference**

See Clause 6.2 of ANSI C63.10-2013 specifically.

See Clause 4 and Clause 5 of ANSI C63.10-2013 generally.

### **A.6.2. Measurement Methods**

The conducted emissions from the AC port of the EUT are measured in a shielding room. The EUT is connected to a Line Impedance Stabilization Network (LISN). An overview sweep with peak detection was performed. The measurements were performed with a quasi-peak detector and if required, an average detector.

The conducted emission measurements were made with the following detector of the test receiver: Quasi-Peak / Average Detector.

The measurement bandwidth is:

Frequency of Emission (MHz)	RBW/VBW
0.15-30	9kHz

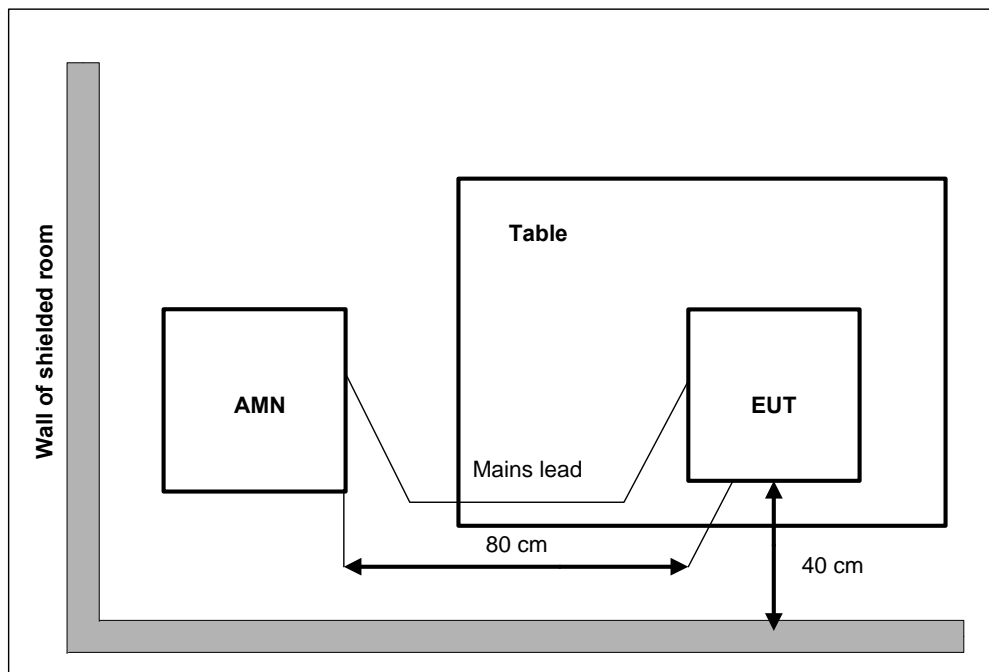

### **A.6.3. EUT Operating Mode and Test Conditions**

The measurement of EUT is carried out under the transmit state of NFC (See 3.5).

The EUT is powered by a travel adapter.

During the measurements, the ambient temperature is in the range of 15 ~ 25 °C.

### **A.6.4. Limits**

Frequency range (MHz)	Quasi-peak Limit (dB $\mu$ V)	Average Limit (dB $\mu$ V)
0.15 to 0.5	66 to 56	56 to 46
0.5 to 5	56	46
5 to 30	60	50

### A.6.5. Measurement Results

Measurement results see Figure A-5.

**Conclusions:** Set. NFC01, **PASS**.

Note: The measurement result at 13.56MHz is the fundamental emission of NFC signal.

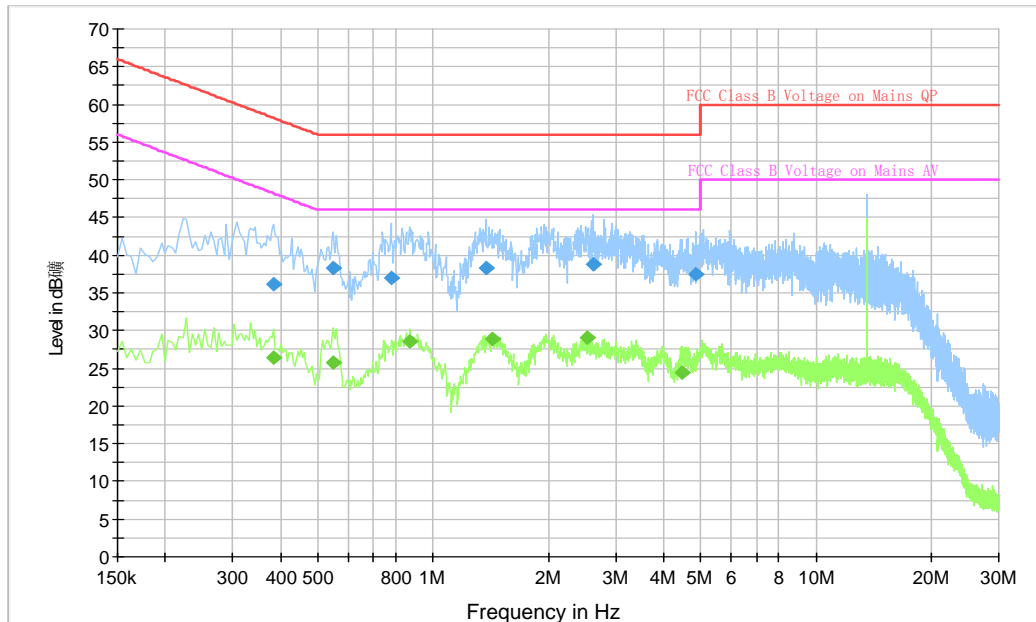

Figure A-5: Test result of EUT8 at test set. NFC01

### Final Result 1

Frequency (MHz)	QuasiPeak (dBµV)	Meas. Time (ms)	Bandwidth (kHz)	Line	Corr. (dB)	Margin (dB)	Limit (dBµV)
0.384000	36.1	2000.0	9.000	On	L1	19.8	22.1
0.550500	38.3	2000.0	9.000	On	L1	19.9	17.7
0.775500	36.9	2000.0	9.000	On	L1	19.7	19.1
1.378500	38.3	2000.0	9.000	On	L1	19.6	17.7
2.611500	38.8	2000.0	9.000	On	L1	19.7	17.2
4.870500	37.5	2000.0	9.000	On	L1	19.6	18.5

### Final Result 2

Frequency (MHz)	Average (dBµV)	Meas. Time (ms)	Bandwidth (kHz)	Line	Corr. (dB)	Margin (dB)	Limit (dBµV)
0.384000	26.5	2000.0	9.000	On	L1	19.8	21.7
0.550500	25.8	2000.0	9.000	On	L1	19.9	20.2
0.870000	28.5	2000.0	9.000	On	L1	19.7	17.5
1.423500	28.9	2000.0	9.000	On	L1	19.6	17.1
2.521500	29.1	2000.0	9.000	On	L1	19.7	16.9
4.483500	24.4	2000.0	9.000	On	L1	19.6	21.6

### A.6.6. Measurement Uncertainty

Measurement uncertainty:  $U = 3.08$  dB,  $k=2$

## ANNEX B: Accreditation Certificate

United States Department of Commerce  
National Institute of Standards and Technology



### Certificate of Accreditation to ISO/IEC 17025:2005

NVLAP LAB CODE: 600118-0

**Telecommunication Technology Labs, CAICT**

Beijing  
China

*is accredited by the National Voluntary Laboratory Accreditation Program for specific services,  
listed on the Scope of Accreditation, for:*

**Electromagnetic Compatibility & Telecommunications**

*This laboratory is accredited in accordance with the recognized International Standard ISO/IEC 17025:2005.  
This accreditation demonstrates technical competence for a defined scope and the operation of a laboratory quality  
management system (refer to joint ISO-ILAC-IAF Communique dated January 2009).*

2016-09-29 through 2017-09-30  
Effective Dates

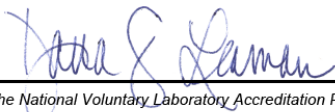

  
For the National Voluntary Laboratory Accreditation Program

\*\*\*END OF REPORT\*\*\*