



**FCC PART 15
TEST REPORT
No. I18Z60538-IOT06**

for

TCL Communication Ltd.

GSM Quad-band/HSPA-UMTS Six-band/LTE 19 band mobile phone

With

BBB100-5

FCC ID: 2ACCJN027

Hardware Version: 05

Software Version: AAW880

Issued Date: 2018-04-18



Note:

The test results in this test report relate only to the devices specified in this report. This report shall not be reproduced except in full without the written approval of CTTL.

The report must not be used by the client to claim product certification, approval, or endorsement by NVLAP, NIST, or any agency of the U.S. Government.

Test Laboratory:

CTTL, Telecommunication Technology Labs, CAICT

No. 52, Huayuan North Road, Haidian District, Beijing, P. R. China 100191.

Tel:+86(0)10-62304633-2512, Fax:+86(0)10-62304633-2504

Email: ctl_terminals@caict.ac.cn, website: www.caict.ac.cn



REPORT HISTORY

| Report Number | Revision | Description | Issue Date |
|----------------------|-----------------|--------------------|-------------------|
| I18Z60538-IOT06 | Rev.0 | 1st edition | 2018-04-18 |
| | | | |



CONTENTS

| | |
|---|-----------|
| CONTENTS | 3 |
| 1. TEST LATORATORY | 4 |
| 1.1. TESTING LOCATION | 4 |
| 1.2. TESTING ENVIRONMENT | 4 |
| 1.3. PROJECT DATA | 4 |
| 1.4. SIGNATURE | 4 |
| 2. CLIENT INFORMATION | 5 |
| 2.1. APPLICANT INFORMATION | 5 |
| 2.2. MANUFACTURER INFORMATION | 5 |
| 3. EQUIPMENT UNDER TEST (EUT) AND ANCILLARY EQUIPMENT(AE) | 6 |
| 3.1. ABOUT EUT | 6 |
| 3.2. INTERNAL IDENTIFICATION OF EUT USED DURING THE TEST | 6 |
| 3.3. GENERAL DESCRIPTION | 6 |
| 4. REFERENCE DOCUMENTS | 7 |
| 4.1. DOCUMENTS SUPPLIED BY APPLICANT | 7 |
| 4.2. REFERENCE DOCUMENTS FOR TESTING | 7 |
| 5. LABORATORY ENVIRONMENT | 7 |
| 6. SUMMARY OF TEST RESULTS | 7 |
| 6.1. SUMMARY OF TEST RESULTS | 7 |
| 6.2. STATEMENTS | 7 |
| 7. TEST EQUIPMENTS UTILIZED | 8 |
| ANNEX A: MEASUREMENT RESULTS..... | 9 |
| A.1. MEASUREMENT METHOD | 9 |
| A.2. CHANNEL MOVE TIME AND CHANNEL CLOSING TRANSMISSION TIME | 11 |
| A.3. NON-OCCUPANCY PERIOD | 13 |
| A3.1 ASSOCIATED TEST | 13 |
| ANNEX B: PHOTOGRAPHS OF THE TEST SET-UP | 15 |
| ANNEX C: ACCREDITATION CERTIFICATE | 16 |

1. TEST LATORATORY

1.1. Testing Location

Location 1:CTTL(huayuan North Road)

Address: No. 52, Huayuan North Road, Haidian District, Beijing,
P. R. China100191

Location 2:CTTL(Shouxiang)

Address: No. 51 Shouxiang Science Building, Xueyuan Road,
Haidian District, Beijing, P. R. China100191

1.2. Testing Environment

Normal Temperature: 15-35℃
Extreme Temperature: -10/+55℃
Relative Humidity: 20-75%

1.3. Project data

Testing Start Date: 2016-12-28
Testing End Date: 2017-01-19

1.4. Signature



Jiang Xue

(Prepared this test report)

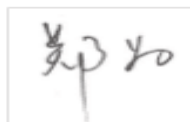

Zheng Wei

(Reviewed this test report)

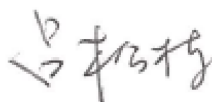

Lv Songdong

(Approved this test report)



2. CLIENT INFORMATION

2.1. Applicant Information

Company Name: TCL Communication Ltd
Address: 7/F, Block F4, TCL International E City, Zhong Shan Yuan Road,
Nanshan District, Shenzhen, Guangdong, P.R. China 518052
City: Shenzhen
Postal Code: 518052
Country: China
Telephone: 0086-755-36611722
Fax: 0086-75536612000-81722

2.2. Manufacturer Information

Company Name: TCL Communication Ltd
Address: 7/F, Block F4, TCL International E City, Zhong Shan Yuan Road,
Nanshan District, Shenzhen, Guangdong, P.R. China 518052
City: Shenzhen
Postal Code: 518052
Country: China
Telephone: 0086-755-36611722
Fax: 0086-75536612000-81722



3. EQUIPMENT UNDER TEST (EUT) AND ANCILLARY

EQUIPMENT(AE)

3.1. About EUT

| | |
|----------------------|---|
| Description | GSM Quad-band/HSPA-UMTS Six-band/LTE 19 band mobile phone |
| Model name | BBB100-5 |
| FCC ID | 2ACCJN027 |
| WLAN Frequency Range | ISM Band: -5250MHz~5350MHz -5470MHz~5725MHz |
| Type of modulation | OFDM |
| Antenna | Integral Antenna |
| Extreme vol. Limits | 3.8V DC by Battery |
| Device Type (DFS) | Client without radar detection(only support client mode) |
| TPC mechanism | Not support |

3.2. Internal Identification of EUT used during the test

| EUT ID* | S/N | HW Version | SW Version |
|----------------|------------|-------------------|-------------------|
| EUT1 | / | 05 | AAW880 |

*EUT ID: is used to identify the test sample in the lab internally.

3.3. General Description

The Equipment Under Test (EUT) is a model of GSM Quad-band/HSPA-UMTS Six-band/LTE 19 band mobile phone with integrated antenna. It consists of normal options: lithium battery, charger. Manual and specifications of the EUT were provided to fulfil the test.



4. REFERENCE DOCUMENTS

4.1. Documents supplied by applicant

EUT feature information is supplied by the applicant or manufacturer, which is the basis of testing.

4.2. Reference Documents for testing

The following documents listed in this section are referred for testing.

| | | |
|------------|---|------|
| | FCC CFR 47, Part 15, Subpart C: | |
| | 15.205 Restricted bands of operation; | |
| FCC Part15 | 15.209 Radiated emission limits, general requirements; | 2016 |
| | 15.247 Operation within the bands 902–928MHz, 2400–2483.5 MHz, and 5725–5850 MHz. | |
| FCC 06-96 | Revision of Parts 2 and 15 of the Commission’s Rules to Permit Unlicensed National Information Infrastructure (U-NII) devices in the 5 GHz band | 2006 |

5. LABORATORY ENVIRONMENT

Measurement is performed in shielding room.

6. SUMMARY OF TEST RESULTS

6.1. Summary of Test Results

| SUMMARY OF MEASUREMENT RESULTS | Sub-clause of Part15E | Verdict |
|---|-----------------------|---------|
| Channel move time and channel closing transmission time | 15.407 (h)(2)(iii) | P |
| Non-Occupancy Period | 15.407 (h)(2) (iv) | P |

Please refer to **ANNEX A** for detail.

Terms used in Verdict column

| | |
|----|---|
| P | Pass, The EUT complies with the essential requirements in the standard. |
| NM | Not measured, The test was not measured by CTTL |
| NA | Not Applicable, The test was not applicable |
| F | Fail, The EUT does not comply with the essential requirements in the standard |

6.2. Statements

CTTL has evaluated the test cases requested by the client/manufacturer as listed in section 6.1 of this report for the EUT specified in section 3 according to the standards or reference documents listed in section 4.1.

This report only deal with the UNII DFS functions among the features described in section 3, and The EUT met all requirements of the reference documents.

The end user is not available to get and modify the parameters of the detected Radar Waveforms in this product.

This model is a variant product which model name is BBB100-1; all the test results have been derived from test report of BBB100-1.



Test Conditions

| | |
|-------|--------------------|
| T nom | Normal Temperature |
| T min | Low Temperature |
| T max | High Temperature |
| V nom | Normal Voltage |
| V min | Low Voltage |
| V max | High Voltage |
| H nom | Norm Humidity |
| A nom | Norm Air Pressure |

For this report, all the test case listed above is tested under Normal Temperature and Normal Voltage, and also under norm humidity, the specific conditions as following:

| | | |
|--------------|-------|------------------|
| Temperature | T nom | 26°C |
| Voltage | V nom | 3.8V(By battery) |
| Humidity | H nom | 44% |
| Air Pressure | A nom | 1010hPa |

7. TEST EQUIPMENTS UTILIZED

Conducted test system

| No. | Equipment | Model | Serial Number | Manufacturer | Calibration Date | Calibration Due Date |
|-----|------------------------|---------|---------------|-----------------|------------------|----------------------|
| 1 | Vector Signal Analyzer | FSQ40 | 200089 | Rohde & Schwarz | 2016-06-07 | 2017-06-06 |
| 2 | Vector Signal General | SMU200A | 103752 | Rohde & Schwarz | 2016-06-07 | 2017-06-06 |
| 3 | Shielding Room | S81 | / | ETS-Lindgren | / | / |

ANNEX A: MEASUREMENT RESULTS

A.1. Measurement Method

A.1.1. Conducted Measurements

The below figure shows the DFS setup, where the EUT is a WLAN device operating in slave mode, without Radar Interference Detection function. This setup also contains a device operating in master mode. The radar test signals are injected into the master device. The EUT (slave device) is associated with the master device. WLAN traffic is generated by streaming the mpeg file from the master to the slave in full monitor video mode using the media player.

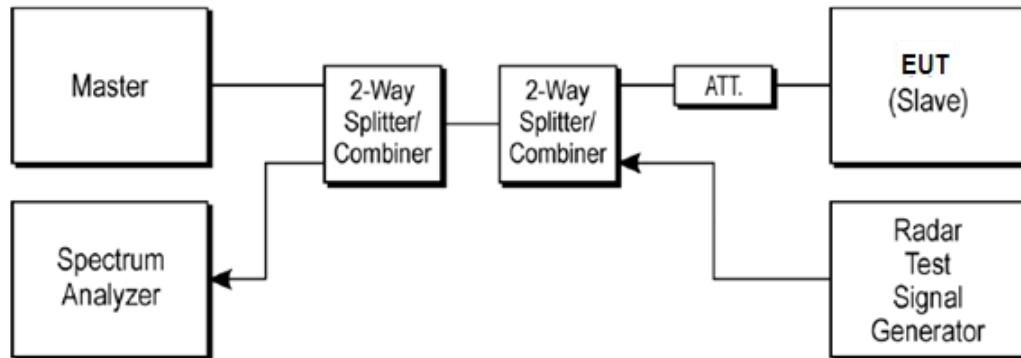

Note:

- 1) All Measurements are performed with the EUT's narrowest channel bandwidth.
- 2) The master device information is as follows
Vendor: Cisco
Model: AIR-AP1252AG-A-K9
FCC ID: LDK102061, 1DK102062
- 3) The software of radar signal generator (R&S SMU200A) is completely designed based on FCC-06-96A1/NTIA requirement.

A.1.2. Parameters of DFS test signal

1). Interference threshold values, master or client incorporation in service monitoring. For device power less than 23dBm (E.I.R.P.), the threshold level is -62 dBm at the antenna port after correction for antenna gain and procedural adjustments.

Because of conducted measurement performed, the calibration power from radar signal generator to antenna port of DFS test equipment is -62 dBm.

| Maximum Transmit Power | Value |
|------------------------|---------|
| > 200 mW | -64 dBm |
| < 200 mW | -62 dBm |

2). DFS requirement values

The required values are as the following table.

| Parameter | Value |
|-----------------------------------|---|
| Non-occupancy | > 1800 s |
| Channel Availability Check Time | 60 s |
| Channel Move Time | 10 s |
| Channel Closing Transmission Time | 200 ms + 60 ms |
| U-NII Detection Bandwidth | Minimum 80% of the 99% transmission power bandwidth |

As the EUT is IP based system, the MPEG video file from NTIA website is used to steam to EUT via the Master device.

A.1.3. Measurement Uncertainty

| Item | Measurement Uncertainty |
|-------|-------------------------|
| Time | 0.70 ms |
| Power | 0.75 dBm |

A.2. Channel move time and channel closing transmission time

Measurement Limit:

| Test Items | Limit |
|-----------------------------------|------------------|
| channel closing transmission time | < 200 ms + 60 ms |
| Channel move time | < 10 s |

Measurement Results:

HT20 Frequency Band: 5250MHz ~ 5350MHz

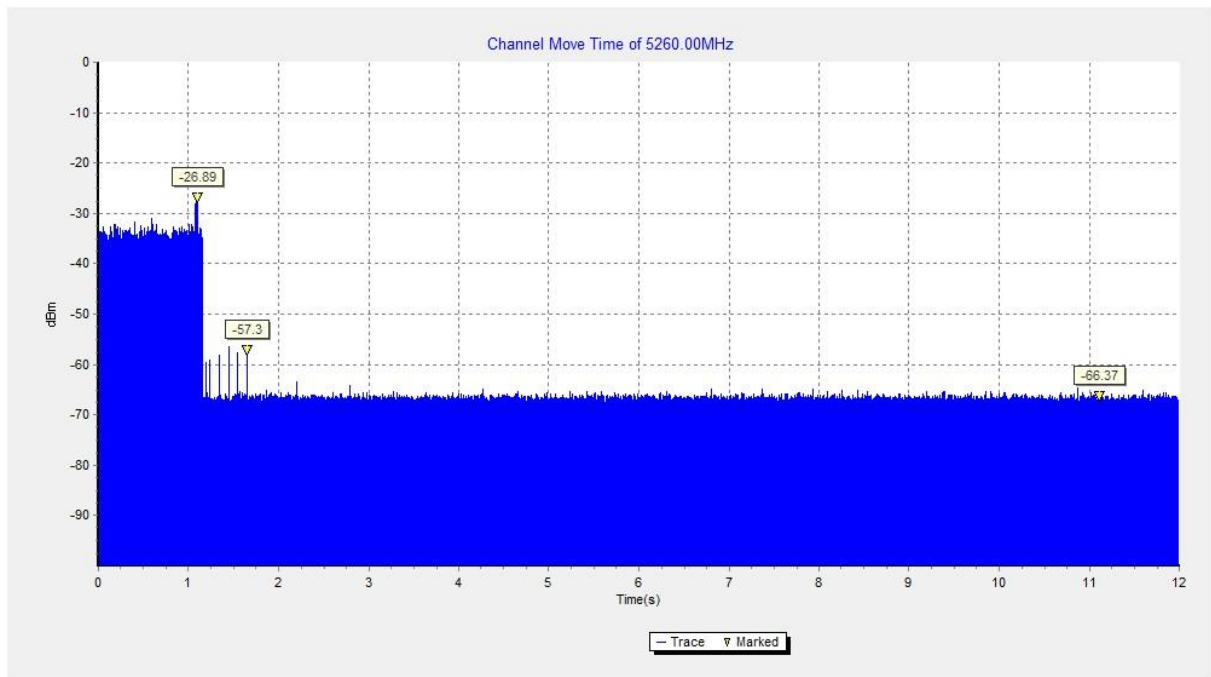

The channel move time is as the figure. It shows the time of the radar and the client pulses. The figure shows that the client stops transmission within 10 seconds, and no transmissions occur after 10 seconds later of the radar burst signal.

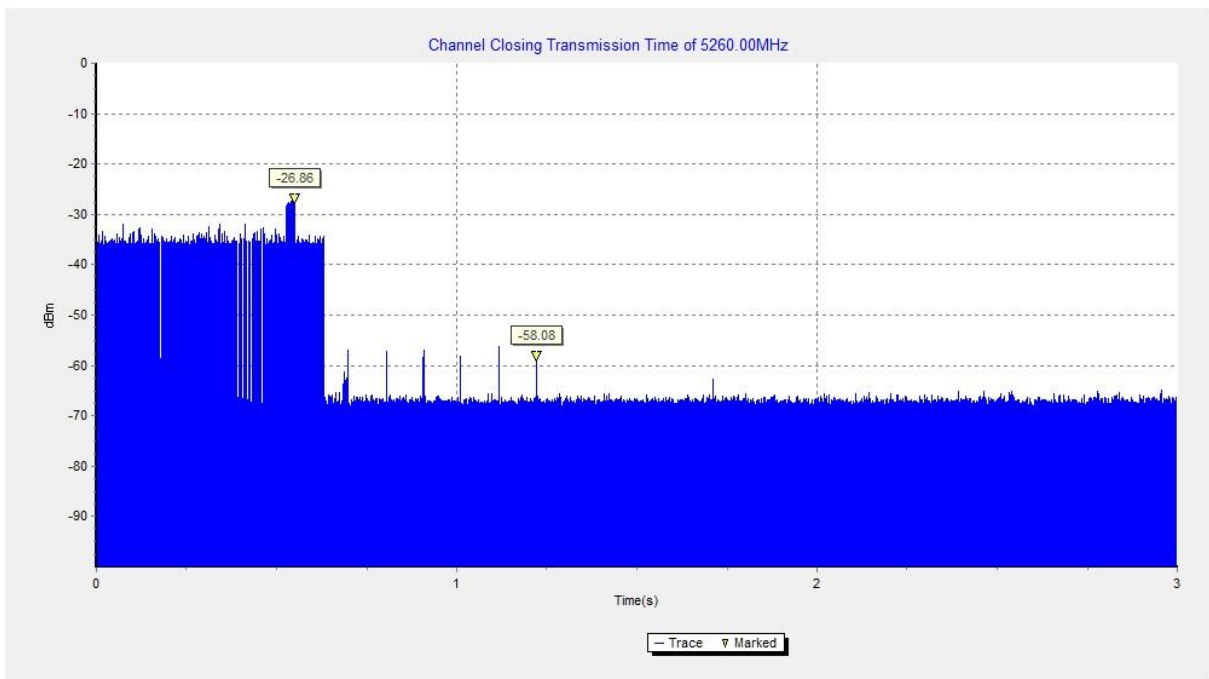

The closing transmission time is as the figure, and the result is 95.90ms.

Conclusion: PASS

HT80 Frequency Band: 5470MHz ~ 5725MHz

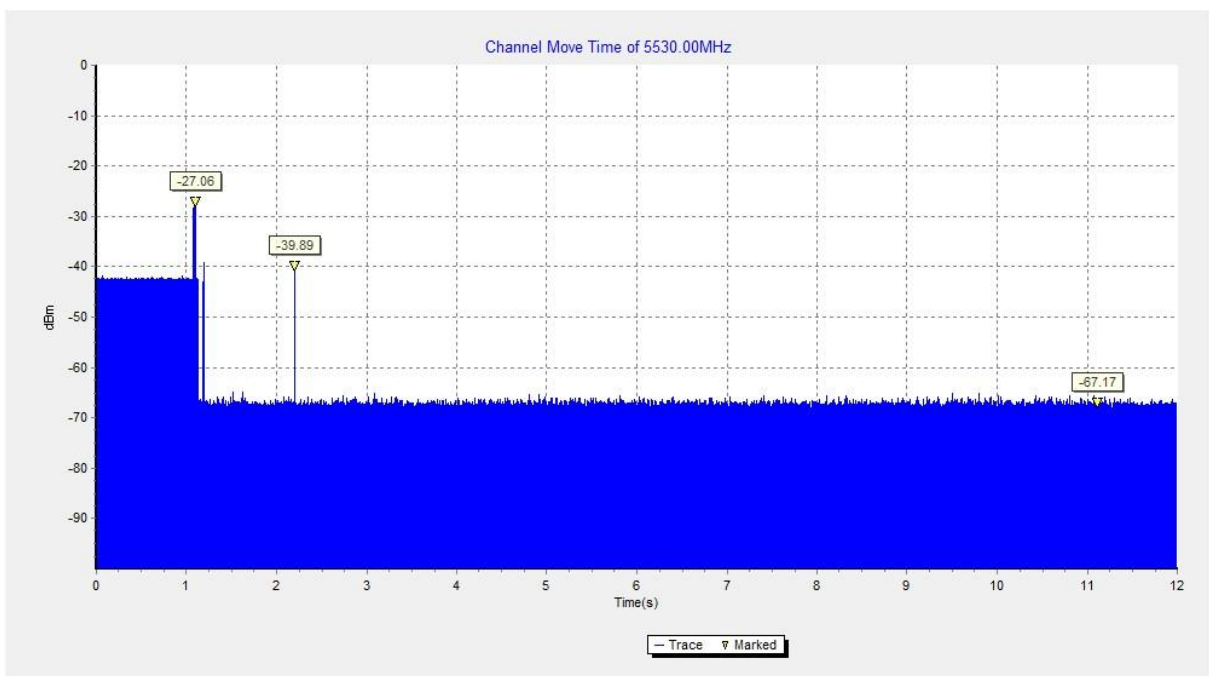

The channel move time is as the figure. It shows the time of the radar and the client pulses. The figure shows that the client stops transmission within 10 seconds, and no transmissions occur after 10 seconds later of the radar burst signal.

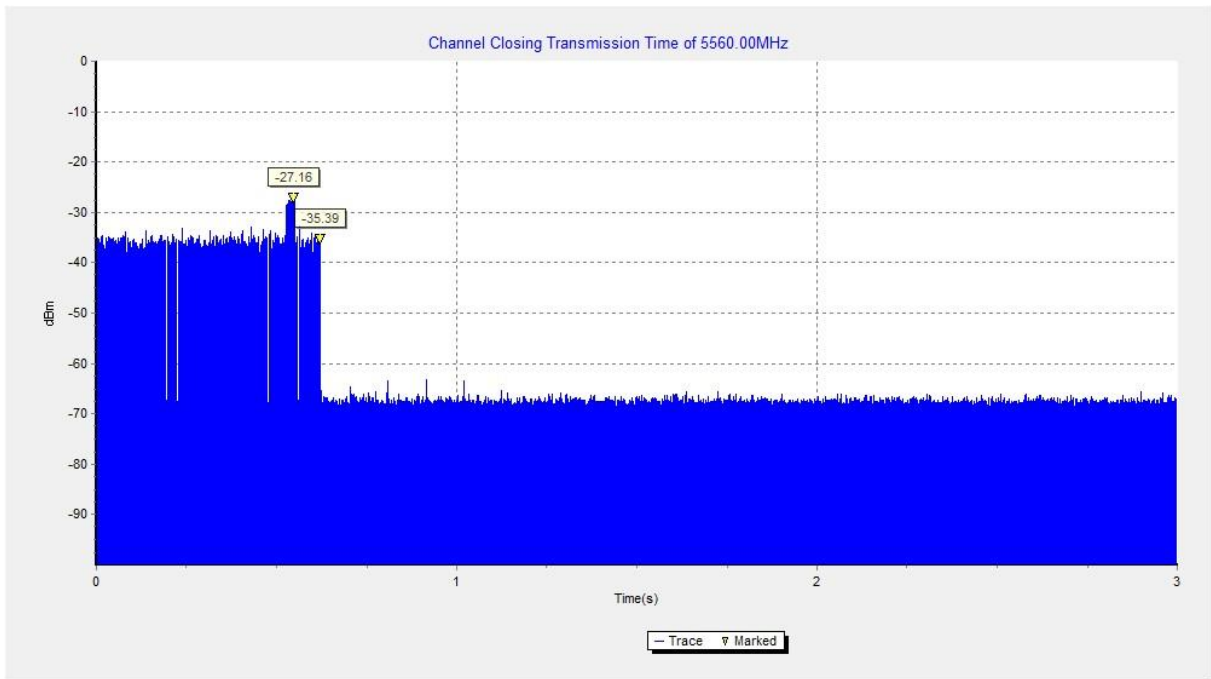

The closing transmission time is as the figure, and the result is 68.93ms

Conclusion: PASS

A.3. Non-Occupancy Period

Measurement Limit:

| Test Items | Limit |
|----------------------|----------|
| Non-Occupancy Period | > 1800 s |

A3.1 Associated test

Associate the master and client, transmit specified stream between the master and client; monitor the analyzer on the operating frequency to make sure no beacons have been transmitted for 1800 seconds.

HT20 Frequency Band: 5250MHz ~ 5350MHz

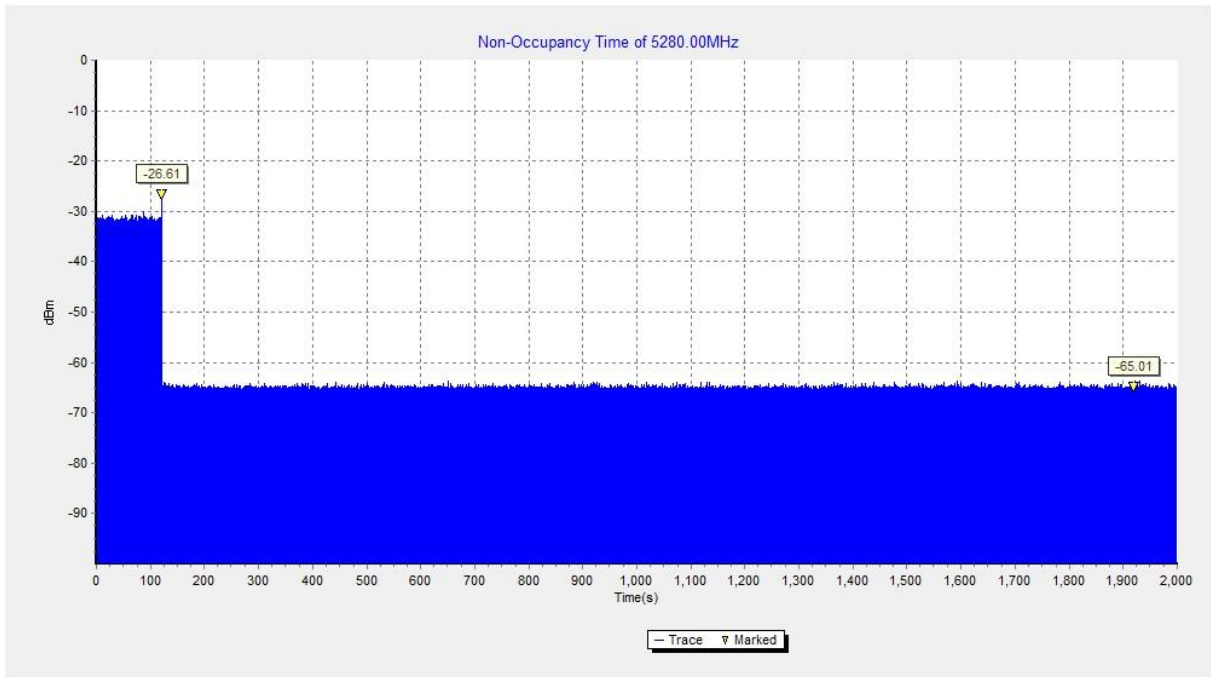

The figure above shows that the client does not transmit any emission within 1800 seconds after getting the order of “stop transmits” from the DFS master (access point).

HT80 Frequency Band: 5470MHz ~ 5725MHz

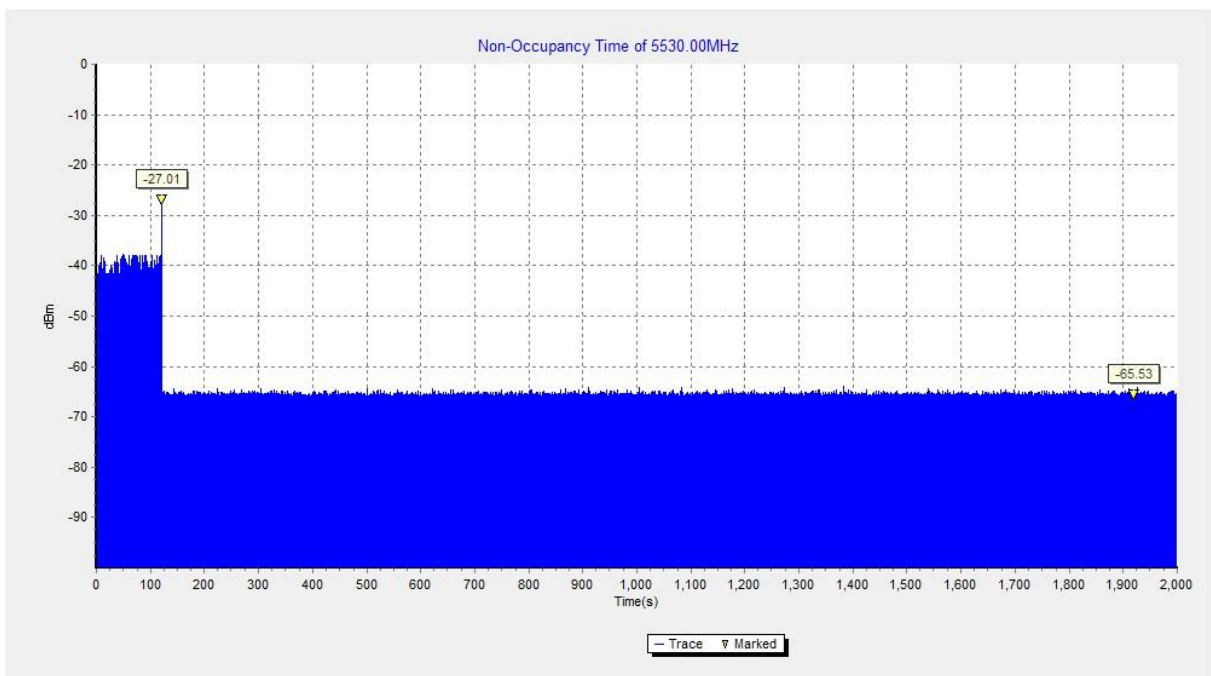

The figure above shows that the client does not transmit any emission within 1800 seconds after getting the order of “stop transmits” from the DFS master (access point).

Conclusion: PASS

ANNEX B: PHOTOGRAPHS OF THE TEST SET-UP

Layout of Conducted Test



ANNEX C: Accreditation Certificate

United States Department of Commerce
National Institute of Standards and Technology



Certificate of Accreditation to ISO/IEC 17025:2005

NVLAP LAB CODE: 600118-0

Telecommunication Technology Labs, CAICT

Beijing
China

*is accredited by the National Voluntary Laboratory Accreditation Program for specific services,
listed on the Scope of Accreditation, for:*

Electromagnetic Compatibility & Telecommunications

*This laboratory is accredited in accordance with the recognized International Standard ISO/IEC 17025:2005.
This accreditation demonstrates technical competence for a defined scope and the operation of a laboratory quality
management system (refer to joint ISO-ILAC-IAF Communique dated January 2009).*

2016-09-29 through 2017-09-30
Effective Dates

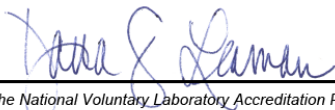

For the National Voluntary Laboratory Accreditation Program

*** END OF REPORT BODY ***