



HAC RF TESTREPORT

No. I18Z60073-SEM02

For

TCL Communication Ltd.

GSM Quad-band/HSPA-UMTS Six-band/ LTE 19-band mobile phone

Model Name: BBF100-1

With

Hardware Version: 09

Software Version: AAX573

FCC ID: 2ACCJN026

Results Summary: M Category = M4

Issued Date: 2018-5-9



Note:

The test results in this test report relate only to the devices specified in this report. This report shall not be reproduced except in full without the written approval of CTTL.

The report must not be used by the client to claim product certification, approval, or endorsement by NVLAP, NIST, or any agency of the U.S. Government.

Test Laboratory:

CTTL, Telecommunication Technology Labs, CAICT

No. 51, Xueyuan Road, Haidian District, Beijing, P. R. China 100191.

Tel:+86(0)10-62304633-2512, Fax:+86(0)10-62304633-2504



REPORT HISTORY

| Report Number | Revision | Issue Date | Description |
|----------------------|-----------------|-------------------|---------------------------------|
| I18Z60073-SEM02 | Rev.0 | 2018-5-9 | Initial creation of test report |

TABLE OF CONTENT

| | |
|--|-----------|
| 1 TEST LABORATORY | 5 |
| 1.1 TESTING LOCATION | 5 |
| 1.2 TESTING ENVIRONMENT..... | 5 |
| 1.3 PROJECT DATA | 5 |
| 1.4 SIGNATURE..... | 5 |
| 2 CLIENT INFORMATION | 6 |
| 2.1 APPLICANT INFORMATION | 6 |
| 2.2 MANUFACTURER INFORMATION | 6 |
| 3 EQUIPMENT UNDER TEST (EUT) AND ANCILLARY EQUIPMENT (AE) | 7 |
| 3.1 ABOUT EUT | 7 |
| 3.2 INTERNAL IDENTIFICATION OF EUT USED DURING THE TEST | 7 |
| 3.3 INTERNAL IDENTIFICATION OF AE USED DURING THE TEST..... | 7 |
| 3.4 AIR INTERFACES / BANDS INDICATING OPERATING MODES | 7 |
| 4 CONDUCTED OUTPUT POWER MEASUREMENT..... | 7 |
| 4.1 SUMMARY | 8 |
| 4.2 CONDUCTED POWER | 8 |
| 5 REFERENCE DOCUMENTS | 11 |
| 5.1 REFERENCE DOCUMENTS FOR TESTING | 11 |
| 6 OPERATIONAL CONDITIONS DURING TEST | 12 |
| 6.1 HAC MEASUREMENT SET-UP..... | 12 |
| 6.2 PROBE SPECIFICATION | 13 |
| 6.3 TEST ARCH PHANTOM & PHONE POSITIONER | 14 |
| 6.4 ROBOTIC SYSTEM SPECIFICATIONS | 14 |
| 7 EUT ARRANGEMENT | 15 |
| 7.1 WD RF EMISSION MEASUREMENTS REFERENCE AND PLANE | 15 |
| 8 SYSTEM VALIDATION..... | 16 |
| 8.1 VALIDATION PROCEDURE | 16 |
| 8.2 VALIDATION RESULT | 16 |
| 9 EVALUATION OF MIF | 17 |
| 9.1 INTRODUCTION..... | 17 |
| 9.2 MIF MEASUREMENT WITH THE AIA | 18 |
| 9.3 TEST EQUIPMENT FOR THE MIF MEASUREMENT | 18 |
| 9.4 TEST SIGNAL VALIDATION | 18 |
| 9.5 DUTMIF RESULTS | 19 |
| 10 EVALUATION FOR LOW-POWER EXEMPTION | 22 |
| 10.1 PRODUCT TESTING THRESHOLD | 22 |
| 10.2 CONDUCTED POWER | 22 |



| | |
|---|-----------|
| 10.3 CONCLUSION | 22 |
| 11 RF TEST PROCEDURES | 23 |
| 12 MEASUREMENT RESULTS (E-FIELD)..... | 24 |
| 13 ANSIC 63.19-2011 LIMITS | 25 |
| 14 MEASUREMENT UNCERTAINTY | 26 |
| 15 MAIN TEST INSTRUMENTS | 27 |
| 16 CONCLUSION..... | 27 |
| ANNEX A TEST LAYOUT..... | 28 |
| ANNEX B TEST PLOTS..... | 29 |
| ANNEX C SYSTEM VALIDATION RESULT | 50 |
| ANNEX D PROBE CALIBRATION CERTIFICATE | 50 |
| ANNEX E DIPOLE CALIBRATION CERTIFICATE | 63 |

1 Test Laboratory

1.1 Testing Location

| | |
|--------------|---|
| CompanyName: | CTTL(Shouxiang) |
| Address: | No. 51 Shouxiang Science Building, Xueyuan Road, Haidian District, Beijing, P. R. China100191 |

1.2 Testing Environment

| | |
|--|------------|
| Temperature: | 18°C~25°C, |
| Relative humidity: | 30%~ 70% |
| Ground system resistance: | < 0.5 Ω |
| Ambient noise is checked and found very low and in compliance with requirement of standards. Reflection of surrounding objects is minimized and in compliance with requirement of standards | |

1.3 Project Data

| | |
|---------------------|----------------|
| Project Leader: | Qi Dianyuan |
| Test Engineer: | Lin Hao |
| Testing Start Date: | April 29, 2018 |
| Testing End Date: | April 29, 2018 |

1.4 Signature



Lin Xiaojun
(Prepared this test report)

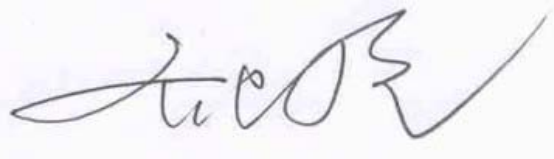

Qi Dianyuan
(Reviewed this test report)

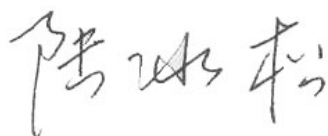

Lu Bingsong
Deputy Director of the laboratory
(Approved this test report)



2 Client Information

2.1 Applicant Information

| | |
|-----------------|--|
| Company Name | TCL Communication Ltd. |
| Company Address | 7/F, Block F4, TCL Communication Technology Building, TCL International E City, Zhong Shan Yuan Road, Nanshan District, Shenzhen, Guangdong, P.R. China 518052 |
| Post Code | 518052 |
| Contact Person | Zhizhou Gong |
| Tel | 0086-755-36611722 |
| Mobile | 0086-18217635320 |
| Fax | 0086-755-36612000 ext: 81722 |
| E-Mail | zhizhou.gong@tcl.com |
| Company URL | www.alcatel-mobile.com |

2.2 Manufacturer Information

| | |
|-----------------|--|
| Company Name | TCL Communication Ltd. |
| Company Address | 7/F, Block F4, TCL Communication Technology Building, TCL International E City, Zhong Shan Yuan Road, Nanshan District, Shenzhen, Guangdong, P.R. China 518052 |
| Post Code | 518052 |
| Contact Person | Zhizhou Gong |
| Tel | 0086-755-36611722 |
| Mobile | 0086-18217635320 |
| Fax | 0086-755-36612000 ext: 81722 |
| E-Mail | zhizhou.gong@tcl.com |
| Company URL | www.alcatel-mobile.com |

3 Equipment Under Test (EUT) and Ancillary Equipment (AE)

This EUT is a variant product and the report of original sample is No.I18Z60070-SEM02. According to the client request, we quote the test results of original sample directly. And increase the results of LTE band4/26.Delete the results of LTE band14/30/66.

3.1 About EUT

| | |
|--------------------|---|
| Description: | GSM Quad-band/HSPA-UMTS Six-band/ LTE 19-band mobile phone |
| Model name: | BBF100-1 |
| Operating mode(s): | GSM 850/900/1800/1900 WCDMA850/900/1700/1900/2100 LTE B1/2/3/4/5/7/8/12/13/17/19/20/26/28/32/38/39/40/41, BT, WLAN |

3.2 Internal Identification of EUT used during the test

| EUT ID* | IMEI | HW Version | SW Version |
|---------|-----------------|------------|------------|
| EUT1 | 015103000009634 | 09 | 4S3L |
| EUT2 | 015103000009683 | 09 | 4S3L |
| EUT3 | 353741090004971 | 09 | AAX573 |

*EUT ID: is used to identify the test sample in the lab internally.

3.3 Internal Identification of AE used during the test

| AE ID* | Description | Model | SN | Manufacturer |
|--------|-------------|----------|----|--------------|
| AE1 | Battery | TLp035B1 | / | BYD |

*AE ID: is used to identify the test sample in the lab internally.

3.4 Air Interfaces / Bands Indicating Operating Modes

| Air-interface | Band(MHz) | Type | C63.19/tested | Simultaneous Transmissions | OTT |
|---------------|--------------------------|------|---------------|----------------------------|-----|
| GSM | 850 | VO | Yes | BT, WLAN | NA |
| | 1900 | | | | |
| GPRS/EDGE | 850 | DT | NA | | |
| | 1900 | | | | |
| WCDMA (UMTS) | 850 | VO | Yes | | |
| | 1700 | | | | |
| | 1900 | | | | |
| | HSPA | DT | NA | | |
| LTE | Band 2/4/5/7/12/13/26/41 | V/D | Yes | BT, WLAN | NA |
| BT | 2450 | DT | NA | GSM, WCDMA, LTE | NA |
| WLAN | 2450 | V/D | Yes | GSM, WCDMA, LTE | NA |
| WLAN | 5G | V/D | Yes | GSM, WCDMA, LTE | NA |

VO: Voice CMRS/PSTN Service Only V/D: Voice CMRS/PSTN and Data Service DT: Digital Transport

* HAC Rating was not based on concurrent voice and data modes, Non current mode was found to represent worst case rating for both M and T rating

4 CONDUCTED OUTPUT POWER MEASUREMENT

4.1 Summary

During the process of testing, the EUT was controlled via Agilent Digital Radio Communication tester (E5515C) to ensure the maximum power transmission and proper modulation. This result contains conducted output power for the EUT. In all cases, the measured output power should be greater and within 5% than EMI measurement.

4.2 Conducted Power

| | | | |
|--------------------------------|---------------------------------|---------------------------------|---------------------------------|
| GSM 850MHz | Conducted Power (dBm) | | |
| | Channel 251(848.8MHz) | Channel 190(836.6MHz) | Channel 128(824.2MHz) |
| | 32.69 | 32.44 | 32.69 |
| GSM 1900MHz | Conducted Power(dBm) | | |
| | Channel 810(1909.8MHz) | Channel 661(1880MHz) | Channel 512(1850.2MHz) |
| | 30.40 | 30.30 | 30.26 |
| WCDMA 850MHz | Conducted Power (dBm) | | |
| | Channel 4233(846.6MHz) | Channel 4182(836.4MHz) | Channel 4132(826.4MHz) |
| | 23.68 | 23.56 | 23.58 |
| WCDMA 1700MHz | Conducted Power (dBm) | | |
| | Channel 1513 (1752.6MHz) | Channel 1412 (1732.4MHz) | Channel 1312 (1712.4MHz) |
| | 23.39 | 23.41 | 23.55 |
| WCDMA 1900MHz | Conducted Power (dBm) | | |
| | Channel 9538(1907.6MHz) | Channel 9400(1880MHz) | Channel 9262(1852.4MHz) |
| | 23.47 | 23.70 | 23.74 |
| LTE Band2 QPSK | Conducted Power (dBm) | | |
| | Channel 19100(1900MHz) | Channel18900(1880MHz) | Channel 18700(1860MHz) |
| | 23.32 | 23.53 | 23.32 |
| LTE Band5 QPSK | Conducted Power (dBm) | | |
| | Channel 20600(844MHz) | Channel 20525(836.5MHz) | Channel20450(829MHz) |
| | 23.16 | 23.14 | 23.12 |
| LTE Band7 QPSK | Conducted Power (dBm) | | |
| | Channel 21350(2560MHz) | Channel21100(2535MHz) | Channel 20850(2510MHz) |
| | 22.97 | 23.03 | 23.05 |
| LTE Band12 QPSK | Conducted Power (dBm) | | |
| | Channel 23130(711MHz) | Channel 23095(707.5MHz) | Channel23060(704MHz) |
| | 23.00 | 22.97 | 23.02 |
| LTE Band13 QPSK | Conducted Power (dBm) | | |
| | Channel 23230(782MHz) | | |
| | 23.21 | | |
| LTE | Conducted Power (dBm) | | |



| | | | | | |
|----------------------------------|--|--|--|--|--|
| Band41 QPSK | Channel 41490(2680MH z) | Channel 41055(2636.5M Hz) | Channel 40620(2593MH z) | Channel 40185(2549.5M Hz) | Channel 39750(2506MH z) |
| | 22.96 | 23.03 | 23.06 | 23.09 | 23.08 |
| LTE Band2 16-QAM | Conducted Power (dBm) | | | | |
| | Channel 19100(1900MHz) | Channel18900(1880MHz) | | Channel 18700(1860MHz) | |
| | 22.79 | 22.82 | | 22.88 | |
| LTE Band5 16-QAM | Conducted Power (dBm) | | | | |
| | Channel 20600(844MHz) | Channel 20525(836.5MHz) | | Channel20450(829MHz) | |
| | 22.16 | 22.00 | | 22.47 | |
| LTE Band7 16-QAM | Conducted Power (dBm) | | | | |
| | Channel 21350(2560MHz) | Channel21100(2535MHz) | | Channel 20850(2510MHz) | |
| | 22.50 | 22.57 | | 22.69 | |
| LTE Band12 16-QAM | Conducted Power (dBm) | | | | |
| | Channel 23130(711MHz) | Channel 23095(707.5MHz) | | Channel23060(704MHz) | |
| | 22.16 | 22.07 | | 22.49 | |
| LTE Band13 16-QAM | Conducted Power (dBm) | | | | |
| | Channel 23230(782MHz) | | | | |
| | 22.26 | | | | |
| LTE Band41 16-QAM | Conducted Power (dBm) | | | | |
| | Channel 41490(2680MH z) | Channel 41055(2636.5M Hz) | Channel 40620(2593MH z) | Channel 40185(2549.5M Hz) | Channel 39750(2506MH z) |
| | 22.14 | 22.41 | 22.42 | 22.31 | 22.45 |
| 2.4GHz 802.11b 1M | Conducted Power (dBm) | | | | |
| | Channel 11 (2462MHz) | Channel 6 (2437MHz) | | Channel 1 (2412MHz) | |
| | 22.74 | 22.65 | | 22.26 | |
| 5GHz 802.11a 18M | Conducted Power (dBm) | | | | |
| | Channel 157 (5785MHz) | | | | |
| | 18.29 | | | | |

| | | | | |
|----------------------------------|-------------------------------|--------------------------------|--|-------------------------------|
| LTE Band2 64-QAM | Conducted Power (dBm) | | | |
| | Channel 19100(1900MHz) | Channel18900(1880MHz) | | Channel 18700(1860MHz) |
| | 21.32 | 21.44 | | 21.48 |
| LTE Band5 64-QAM | Conducted Power (dBm) | | | |
| | Channel 20600(844MHz) | Channel 20525(836.5MHz) | | Channel20450(829MHz) |
| | 21.37 | 21.40 | | 21.36 |
| LTE Band7 64-QAM | Conducted Power (dBm) | | | |
| | Channel 21350(2560MHz) | Channel21100(2535MHz) | | Channel 20850(2510MHz) |
| | 21.25 | 21.21 | | 20.82 |
| LTE Band12 64-QAM | Conducted Power (dBm) | | | |
| | Channel 23130(711MHz) | Channel 23095(707.5MHz) | | Channel23060(704MHz) |
| | 21.42 | 21.38 | | 21.31 |



| | | | | | |
|----------------------------------|--|--|--|--|--|
| LTE Band13 64-QAM | Conducted Power (dBm) | | | | |
| | Channel 23230(782MHz) | | | | |
| | 21.21 | | | | |
| LTE Band41 64-QAM | Conducted Power (dBm) | | | | |
| | Channel 41490(2680MH z) | Channel 41055(2636.5M Hz) | Channel 40620(2593MH z) | Channel 40185(2549.5M Hz) | Channel 39750(2506MH z) |
| | 21.12 | 21.08 | 21.03 | 20.91 | 20.49 |

| | | | |
|----------------------------------|--------------------------------|---------------------------------|-------------------------------|
| LTE Band4 QPSK | Conducted Power (dBm) | | |
| | Channel 20300(1745MHz) | Channel 20175(1732.5MHz) | Channel20050(1720MHz) |
| | 22.96 | 22.91 | 23.10 |
| LTE Band4 16-QAM | Conducted Power (dBm) | | |
| | Channel 20300(1745MHz) | Channel 20175(1732.5MHz) | Channel20050(1720MHz) |
| | 22.20 | 22.49 | 22.54 |
| LTE Band4 64-QAM | Conducted Power (dBm) | | |
| | Channel 20300(1745MHz) | Channel 20175(1732.5MHz) | Channel20050(1720MHz) |
| | 22.34 | 22.32 | 22.23 |
| LTE Band26 QPSK | Conducted Power (dBm) | | |
| | Channel 26965(841.5MHz) | Channel 26865(831.5MHz) | Channel26775(822.5MHz) |
| | 23.03 | 23.15 | 23.18 |
| LTE Band26 16-QAM | Conducted Power (dBm) | | |
| | Channel 26965(841.5MHz) | Channel 26865(831.5MHz) | Channel26775(822.5MHz) |
| | 22.45 | 22.08 | 22.50 |
| LTE Band26 64-QAM | Conducted Power (dBm) | | |
| | Channel 26965(841.5MHz) | Channel 26865(831.5MHz) | Channel26775(822.5MHz) |
| | 21.39 | 21.37 | 21.38 |

5 Reference Documents

5.1 Reference Documents for testing

The following document listed in this section is referred for testing.

| Reference | Title | Version |
|-------------------|--|----------------|
| ANSI C63.19-2011 | American National Standard for Methods of Measurement of Compatibility between Wireless Communication Devices and Hearing Aids | 2011 Edition |
| FCC 47 CFR §20.19 | Hearing Aid Compatible Mobile Headsets | 2015 Edition |
| KDB 285076 D01 | Equipment Authorization Guidance for Hearing Aid Compatibility | v04 |

6 OPERATIONAL CONDITIONS DURING TEST

6.1 HAC MEASUREMENT SET-UP

These measurements are performed using the DASY5 NEO automated dosimetric assessment system. It is made by Schmid & Partner Engineering AG (SPEAG) in Zurich, Switzerland. It consists of high precision robotics system (Stäubli), robot controller, Intel Core2 computer, near-field probe, probe alignment sensor. The robot is a six-axis industrial robot performing precise movements. A cell controller system contains the power supply, robot controller, teach pendant (Joystick), and remote control, is used to drive the robot motors. The PC consists of the HP Intel Core2 1.86 GHz computer with Windows XP system and HAC Measurement Software DASY5 NEO, A/D interface card, monitor, mouse, and keyboard. The Stäubli Robot is connected to the cell controller to allow software manipulation of the robot. A data acquisition electronic (DAE) circuit performs the signal amplification, signal multiplexing, AD-conversion, offset measurements, mechanical surface detection, collision detection, etc. is connected to the Electro-optical coupler (EOC). The EOC performs the conversion from the optical into digital electric signal of the DAE and transfers data to the PC plug-in card.

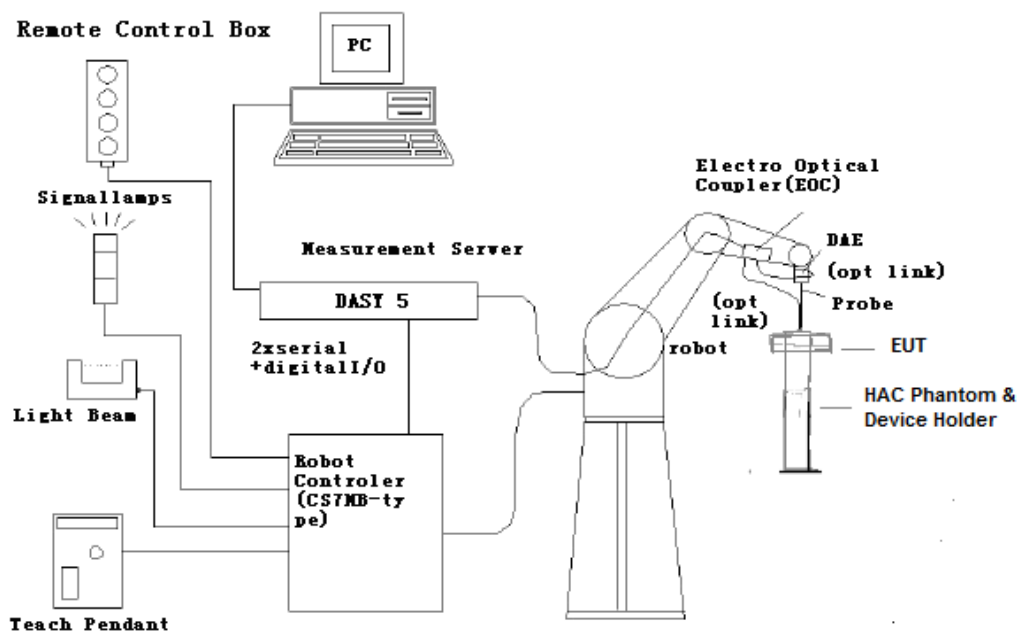

Fig. 1 HAC Test Measurement Set-up

The DAE4 consists of a highly sensitive electrometer-grade preamplifier with auto-zeroing, a channel and gain-switching multiplexer, a fast 16 bit AD-converter and a command decoder and control logic unit. Transmission to the PC-card is accomplished through an optical downlink for data and status information and an optical uplink for commands and clock lines. The mechanical probe mounting device includes two different sensor systems for frontal and sidewise probe contacts. They are also used for mechanical surface detection and probe collision detection. The robot uses its own controller with a built in VME-bus computer.

6.2 Probe Specification

E-Field Probe Description

| | |
|---------------|---|
| Construction | One dipole parallel, two dipoles normal to probe axis Built-in shielding against static charges PEEK enclosure material |
| Calibration | In air from 100 MHz to 3.0 GHz (absolute accuracy $\pm 6.0\%$, $k=2$) |
| Frequency | 40 MHz to > 6 GHz (can be extended to < 20 MHz) Linearity: ± 0.2 dB (100 MHz to 3 GHz) |
| Directivity | ± 0.2 dB in air (rotation around probe axis) ± 0.4 dB in air (rotation normal to probe axis) |
| Dynamic Range | 2 V/m to > 1000 V/m; Linearity: ± 0.2 dB |
| Dimensions | Overall length: 330 mm (Tip: 16 mm) Tip diameter: 8 mm (Body: 12 mm) Distance from probe tip to dipole centers: 2.5 mm |
| Application | General near-field measurements up to 6 GHz Field component measurements Fast automatic scanning in phantoms |



[ER3DV6]

6.3 Test Arch Phantom & Phone Positioner

The Test Arch phantom should be positioned horizontally on a stable surface. Reference markings on the Phantom allow the complete setup of all predefined phantom positions and measurement grids by manually teaching three points in the robot. It enables easy and well defined positioning of the phone and validation dipoles as well as simple teaching of the robot (Dimensions: 370 x 370 x 370 mm).

The Phone Positioner supports accurate and reliable positioning of any phone with effect on near field $< \pm 0.5$ dB.

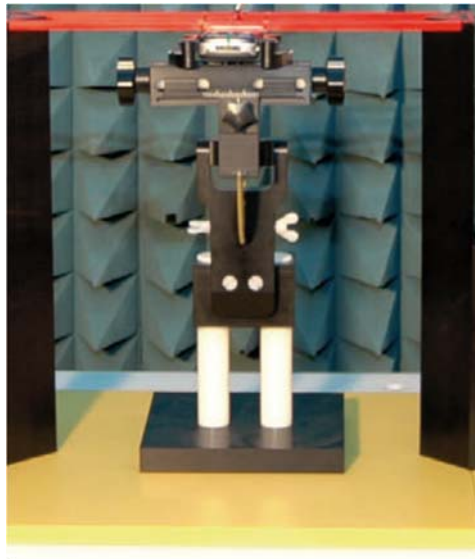

Fig. 2 HAC Phantom & Device Holder

6.4 Robotic System Specifications

Specifications

Positioner: Stäubli Unimation Corp. Robot Model: RX160L

Repeatability: ± 0.02 mm

No. of Axis: 6

Data Acquisition Electronic (DAE) System

Cell Controller

Processor: Intel Core2

Clock Speed: 1.86GHz

Operating System: Windows XP

Data Converter

Features: Signal Amplifier, multiplexer, A/D converter, and control logic

Software: DASY5 software

Connecting Lines: Optical downlink for data and status info.

Optical uplink for commands and clock

7 EUT ARRANGEMENT

7.1 WD RF Emission Measurements Reference and Plane

Figure 4 illustrates the references and reference plane that shall be used in the WD emissions measurement.

- The grid is 5 cm by 5 cm area that is divided into 9 evenly sized blocks or sub-grids.
- The grid is centered on the audio frequency output transducer of the WD (speaker or T-coil).
- The grid is located by reference to a reference plane. This reference plane is the planar area that contains the highest point in the area of the WD that normally rests against the user's ear
- The measurement plane is located parallel to the reference plane and 15 mm from it, out from the phone. The grid is located in the measurement plane.

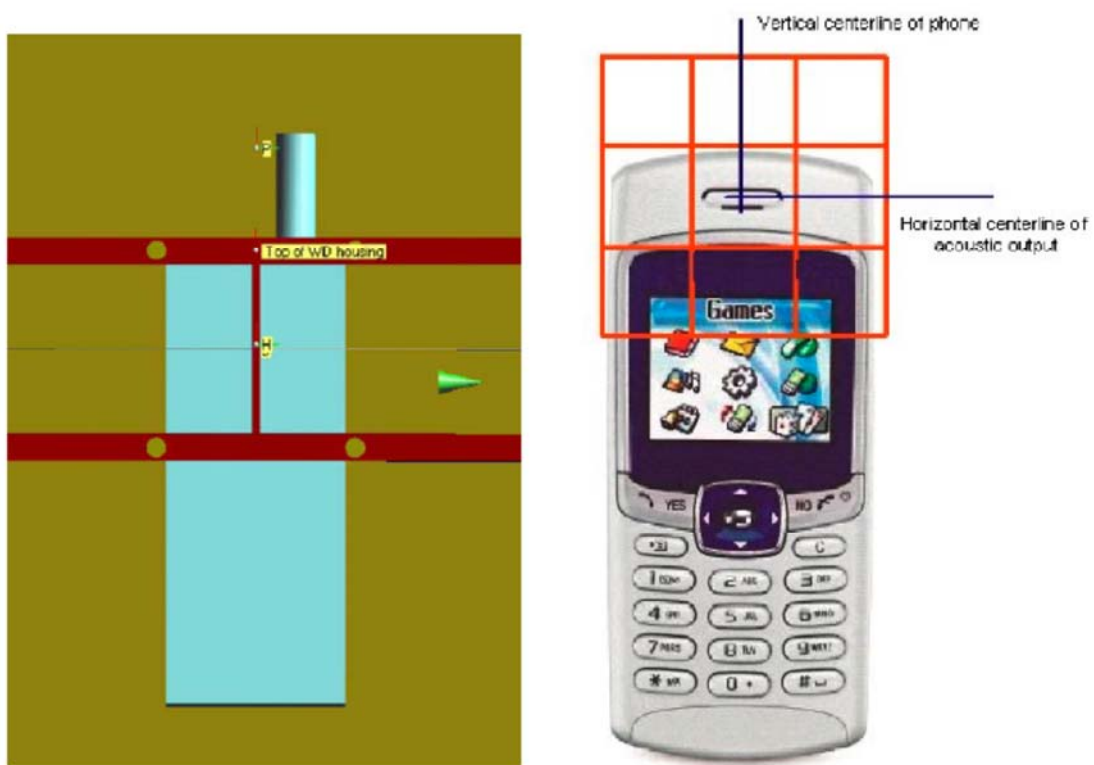

Fig. 3 WD reference and plane for RF emission measurements

8 SYSTEM VALIDATION

8.1 Validation Procedure

Place a dipole antenna meeting the requirements given in ANSI C63.19 in the position normally occupied by the WD. The dipole antenna serves as a known source for an electrical output. Position the E-field probes so that:

- The probes and their cables are parallel to the coaxial feed of the dipole antenna
- The probe cables and the coaxial feed of the dipole antenna approach the measurement area from opposite directions
- The center point of the probe element(s) are 15 mm from the closest surface of the dipole elements.

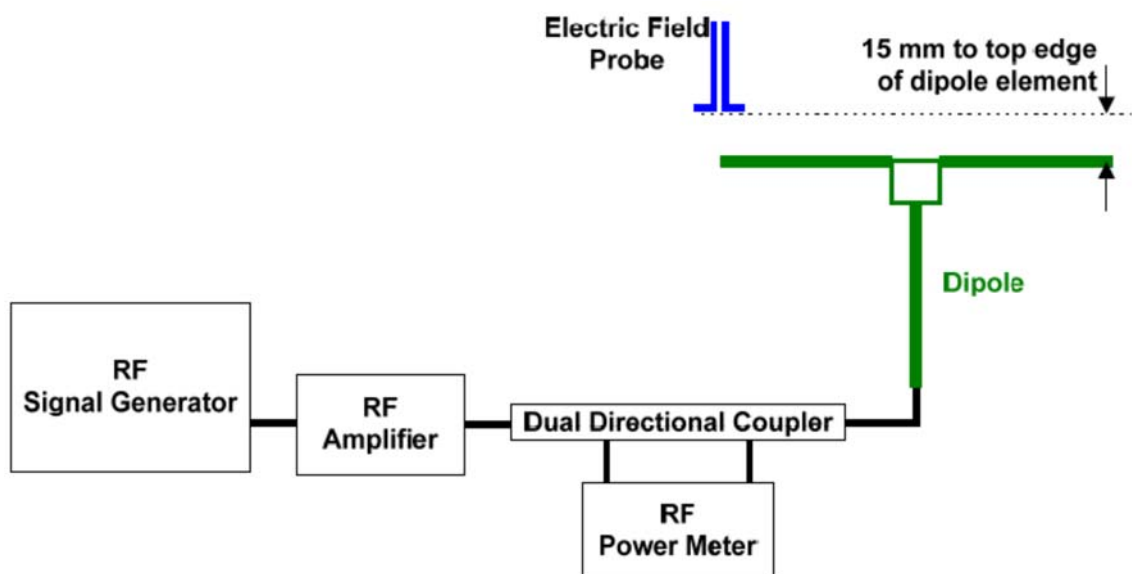

Fig. 4 Dipole Validation Setup

8.2 Validation Result

| E-Field Scan | | | | | | |
|--------------|-----------------|------------------|------------------------------------|----------------------------------|----------------------------|------------------------|
| Mode | Frequency (MHz) | Input Power (mW) | Measured ¹ Value(dBV/m) | Target ² Value(dBV/m) | Deviation ³ (%) | Limit ⁴ (%) |
| CW | 835 | 100 | 40.53 | 40.67 | -1.60 | ± 25 |
| CW | 1880 | 100 | 39.45 | 39.24 | 2.45 | ± 25 |
| CW | 2600 | 100 | 38.69 | 38.74 | -0.57 | ± 25 |

Notes:

1. Please refer to the attachment for detailed measurement data and plot.
2. Target value is provided by SPEAD in the calibration certificate of specific dipoles.
3. Deviation (%) = $100 * (\text{Measured value minus Target value}) / \text{Target value}$.
4. ANSI C63.19 requires values within ± 25% are acceptable, of which 12% is deviation and 13% is measurement uncertainty. Values independently validated for the dipole actually used in the measurements should be used, when available.

9 Evaluation of MIF

9.1 Introduction

The MIF (Modulation Interference Factor) is used to classify E-field emission to determine Hearing Aid Compatibility (HAC). It scales the power-averaged signal to the RF audio interference level and is characteristic to a modulation scheme. The HAC standard preferred "indirect" measurement method is based on average field measurement with separate scaling by the MIF. With an Audio Interference Analyzer (AIA) designed by SPEAG specifically for the MIF measurement, these values have been verified by practical measurements on an RF signal modulated with each of the waveforms. The resulting deviations from the simulated values are within the requirements of the HAC standard.

The AIA (Audio Interference Analyzer) is a USB powered electronic sensor to evaluate signals in the frequency range 698MHz - 6 GHz. It contains RMS detector and audio frequency circuits for sampling of the RF envelope.



Fig. 5 AIA Front View

9.2 MIF measurement with the AIA

The MIF is measured with the AIA as follows:

1. Connect the AIA via USB to the DASY5 PC and verify the configuration settings.
2. Couple the RF signal to be evaluated to an AIA via cable or antenna.
3. Generate a MIF measurement job for the unknown signal and select the measurement port and timing settings.
4. Document the results via the post processor in a report.

9.3 Test equipment for the MIF measurement

| No. | Name | Type | Serial Number | Manufacturer |
|-----|------------------|---------------|---------------|--------------|
| 01 | Signal Generator | E4438C | MY49071430 | Agilent |
| 02 | AIA | SE UMS 170 CB | 1029 | SPEAG |
| 03 | BTS | E5515C | MY50263375 | Agilent |

9.4 Test signal validation

The signal generator (E4438C) is used to generate a 1GHz signal with different modulation in the below table based on the ANSI C63.19-2011. The measured MIF with AIA are compared with the target values given in ANSI C63.19-2011 table D.3, D.4 and D5.

| Pulse modulation | Target MIF | Measured MIF | Deviation |
|--|-------------------|---------------------|------------------|
| 0.5ms pulse, 1000Hz repetition rate | -0.9 dB | -0.9 dB | 0 dB |
| 1ms pulse, 100Hz repetition rate | +3.9 dB | +3.7 dB | 0.2 dB |
| 0.1ms pulse, 100Hz repetition rate | +10.1 dB | +10.0 dB | 0.1 dB |
| 10ms pulse, 10Hz repetition rate | +1.6 dB | +1.7 dB | 0.1 dB |
| Sine-wave modulation | Target MIF | Measured MIF | Deviation |
| 1 kHz, 80% AM | -1.2 dB | -1.3 dB | 0.1 dB |
| 1 kHz, 10% AM | -9.1 dB | -9.0 dB | 0.1 dB |
| 1 kHz, 1% AM | -19.1 dB | -18.9 dB | 0.2 dB |
| 100 Hz, 10% AM | -16.1 dB | -16.0 dB | 0.1 dB |
| 10 kHz, 10% AM | -21.5 dB | -21.6 dB | 0.1 dB |
| Transmission protocol | Target MIF | Measured MIF | Deviation |
| GSM; full-rate version 2; speech codec/handset low | +3.5 dB | +3.47 dB | 0.03 dB |
| WCDMA; speech; speech codec low; AMR 12.2 kb/s | -20.0 dB | -19.8 dB | 0.2 dB |
| CDMA; speech; SO3; RC3; full frame rate; 8kEVRC | -19.0 dB | -19.1 dB | 0.1 dB |
| CDMA; speech; SO3; RC1; 1/8 th frame rate; 8kEVRC | +3.3 dB | +3.44 dB | 0.14 dB |

9.5 DUT MIF results

| Typical MIF levels in ANSI C63.19-2011 | |
|--|--------------------------------|
| Transmission protocol | Modulation interference factor |
| GSM; full-rate version 2; speech codec/handset low | +3.5 dB |
| WCDMA; speech; speech codec low; AMR 12.2 kb/s | -20.0 dB |
| LTE-FDD (SC-FDMA, 1RB, 20MHz, QPSK) | -15.63 dB |
| LTE-FDD (SC-FDMA, 1RB, 20MHz, 16QAM) | -9.76 dB |
| LTE-FDD (SC-FDMA, 1RB, 20MHz, 64QAM) | -9.93 dB |
| LTE-TDD (SC-FDMA, 1RB, 20MHz, QPSK) | -1.62 dB |
| LTE-TDD (SC-FDMA, 1RB, 20MHz, 16QAM) | -1.44 dB |
| LTE-TDD (SC-FDMA, 1RB, 20MHz, 64QAM) | -1.54 dB |

| Measured MIF levels | | |
|---------------------|---------|-------------------------------------|
| Band | Channel | Modulation interference factor (dB) |
| GSM 850 | 251 | 3.49 |
| | 190 | 3.5 |
| | 128 | 3.52 |
| GSM 1900 | 810 | 3.51 |
| | 661 | 3.49 |
| | 512 | 3.51 |
| WCDMA 850 | 4233 | -23.23 |
| | 4182 | -23.69 |
| | 4132 | -23.02 |
| WCDMA 1700 | 1513 | -24.04 |
| | 1412 | -24.32 |
| | 1312 | -23.46 |
| WCDMA 1900 | 9538 | -23.88 |
| | 9400 | -24.54 |
| | 9262 | -23.42 |
| LTE Band2 QPSK | 19100 | -14.71 |
| | 18900 | -14.16 |
| | 18700 | -14.34 |
| LTE Band5 QPSK | 20600 | -14.48 |
| | 20525 | -14.22 |
| | 20450 | -14.2 |
| LTE Band7 QPSK | 21350 | -14.18 |
| | 21100 | -14.53 |
| | 20850 | -14.7 |
| LTE Band12 QPSK | 23130 | -14.63 |
| | 23095 | -14.59 |
| | 23060 | -14.98 |
| LTE Band13 QPSK | 23230 | -14.75 |
| LTE Band41 QPSK | 41490 | -1.78 |
| | 41055 | -1.76 |
| | 40620 | -1.68 |
| | 40185 | -1.71 |



| | | |
|---------------------------|-------|--------|
| | 39750 | -1.69 |
| LTE Band2 16QAM | 19100 | -10.75 |
| | 18900 | -10.6 |
| | 18700 | -9.99 |
| LTE Band5 16QAM | 20600 | -10.28 |
| | 20525 | -11.07 |
| | 20450 | -11.04 |
| LTE Band7 16QAM | 21350 | -10.5 |
| | 21100 | -9.78 |
| | 20850 | -10.5 |
| LTE Band12 16QAM | 23130 | -10.08 |
| | 23095 | -11.02 |
| | 23060 | -9.73 |
| LTE Band13 16QAM | 23230 | -9.92 |
| LTE Band41 16QAM | 41490 | -1.73 |
| | 41055 | -1.59 |
| | 40620 | -1.57 |
| | 40185 | -1.67 |
| | 39750 | -1.50 |
| LTE Band2 64QAM | 19100 | -10.35 |
| | 18900 | -10.11 |
| | 18700 | -9.67 |
| LTE Band5 64QAM | 20600 | -10.68 |
| | 20525 | -10.88 |
| | 20450 | -10.32 |
| LTE Band7 64QAM | 21350 | -10.72 |
| | 21100 | -10.25 |
| | 20850 | -10.05 |
| LTE Band12 64QAM | 23130 | -10.21 |
| | 23095 | -10.66 |
| | 23060 | -9.87 |
| LTE Band13 64QAM | 23230 | -10.12 |
| LTE Band41 64QAM | 41490 | -1.64 |
| | 41055 | -1.53 |
| | 40620 | -1.49 |
| | 40185 | -1.46 |
| | 39750 | -1.56 |
| 2.4GHz 802.11b 5.5M | 11 | -8.98 |
| | 6 | -5.99 |
| | 1 | -9.60 |
| 5GHz 802.11a 18M | 157 | -9.17 |
| Band4 QPSK | 20300 | -14.58 |
| | 20175 | -14.30 |
| | 20050 | -14.77 |



| | | |
|------------------|-------|--------|
| Band26 QPSK | 26965 | -14.77 |
| | 26865 | -14.50 |
| | 26775 | -14.76 |
| Band4 16-QAM | 20300 | -10.72 |
| | 20175 | -10.06 |
| | 20050 | -10.66 |
| Band26 16-QAM | 26965 | -10.32 |
| | 26865 | -10.19 |
| | 26775 | -9.71 |
| Band4 64-QAM | 20300 | -9.87 |
| | 20175 | -9.54 |
| | 20050 | -9.64 |
| Band26 64-QAM | 26965 | -9.46 |
| | 26865 | -9.87 |
| | 26775 | -9.28 |

10 Evaluation for low-power exemption

10.1 Product testing threshold

There are two methods for exempting an RF air interface technology from testing. The first method requires evaluation of the MIF for the worst-case operating mode. An RF air interface technology of a device is exempt from testing when its average antenna input power plus its MIF is ≤ 17 dBm for any of its operating modes. The second method does not require determination of the MIF. The RF emissions testing exemption shall be applied to an RF air interface technology in a device whose peak antenna input power, averaged over intervals $\leq 50 \mu s$, is ≤ 23 dBm. An RF air interface technology that is exempted from testing by either method shall be rated as M4.

The first method is used to be exempt from testing for the RF air interface technology in this report.

10.2 Conducted power

| Band | Average power (dBm) | MIF (dB) | Sum (dBm) |
|------------|---------------------|----------|-----------|
| GSM 850 | 32.69 | 3.49 | 36.18 |
| GSM 1900 | 30.40 | 3.51 | 33.91 |
| WCDMA 850 | 23.68 | -23.23 | 0.45 |
| WCDMA 1700 | 23.55 | -23.46 | 0.09 |
| WCDMA 1900 | 23.74 | -23.42 | 0.32 |
| LTE B2 | 23.53 | -14.16 | 9.37 |
| LTE B5 | 23.16 | -14.48 | 8.68 |
| LTE B7 | 23.05 | -14.70 | 8.35 |
| LTE B12 | 23.02 | -14.98 | 8.04 |
| LTE B13 | 23.21 | -14.75 | 8.46 |
| LTE B41 | 23.09 | -1.71 | 21.38 |
| WiFi-2.4G | 22.74 | -8.98 | 13.76 |
| WiFi-5G | 18.29 | -9.17 | 9.12 |
| LTE B4 | 23.10 | -14.30 | 8.8 |
| LTE B26 | 23.18 | -10.06 | 13.12 |

10.3 Conclusion

According to the above table, the sums of average power and MIF for UMTS, LTE and WiFi are less than 17dBm. So it is only measured for GSM bands. The UMTS, LTE and WiFi are exempt from testing and rated as M4.



11 RF TEST PROCEDURES

The evaluation was performed with the following procedure:

- 1) Confirm proper operation of the field probe, probe measurement system and other instrumentation and the positioning system.
- 2) Position the WD in its intended test position. The gauge block can simplify this positioning.
- 3) Configure the WD normal operation for maximum rated RF output power, at the desired channel and other operating parameters (e.g., test mode), as intended for the test.
- 4) The center sub-grid shall be centered on the center of the T-Coil mode axial measurement point or the acoustic output, as appropriate. Locate the field probe at the initial test position in the 50 mm by 50 mm grid, which is contained in the measurement plane. If the field alignment method is used, align the probe for maximum field reception.
- 5) Record the reading.
- 6) Scan the entire 50 mm by 50 mm region in equally spaced increments and record the reading at each measurement point. The distance between measurement points shall be sufficient to assure the identification of the maximum reading.
- 7) Identify the five contiguous sub-grids around the center sub-grid whose maximum reading is the lowest of all available choices. This eliminates the three sub-grids with the maximum readings. Thus, the six areas to be used to determine the WD's highest emissions are identified.
- 8) Identify the maximum field reading within the non-excluded sub-grids identified in Step 7)
- 9) Evaluate the MIF and add to the maximum steady-state rms field-strength reading to obtain the RF audio interference level..
- 10) Compare this RF audio interference level with the categories and record the resulting WD category rating.



12 Measurement Results (E-Field)

| Frequency | | AWF | Measured Value (V/m) | Power Drift (dB) | Category M? | MIF |
|--------------------------|---------|-----|-------------------------|---------------------|----------------|--------------|
| MHz | Channel | | | | | |
| GSM 850 | | | | | | |
| | 251 | 0 | 34.69 | -0.02 | M4 | 3.49 |
| | 190 | 0 | 33.45 | -0.03 | M4 | 3.5 |
| | 128 | 0 | 35.52 | 0.03 | M4 | 3.52 |
| PCS 1900 | | | | | | |
| | 810 | 0 | 26.73 | -0.06 | M4 | 3.51 |
| | 661 | 0 | 26.47 | -0.04 | M4 | 3.49 |
| | 512 | 0 | 25.99 | -0.12 | M4 | 3.51 |
| LTE Band41 QPSK | | | | | | |
| | 41490 | 0 | 21.01 | -0.02 | M4 | -1.78 |
| | 41055 | 0 | 20.83 | -0.10 | M4 | -1.76 |
| | 40620 | 0 | 21.10 | -0.05 | M4 | -1.68 |
| | 40185 | 0 | 20.54 | 0.07 | M4 | -1.71 |
| | 39750 | 0 | 20.14 | 0.13 | M4 | -1.69 |
| LTE Band41 16-QAM | | | | | | |
| | 41490 | 0 | 20.78 | 0.05 | M4 | -1.73 |
| | 41055 | 0 | 20.66 | 0.02 | M4 | -1.59 |
| | 40620 | 0 | 20.90 | -0.15 | M4 | -1.57 |
| | 40185 | 0 | 21.05 | 0.17 | M4 | -1.67 |
| | 39750 | 0 | 20.35 | 0.08 | M4 | -1.50 |
| LTE Band41 64-QAM | | | | | | |
| | 41490 | 0 | 21.09 | 0.11 | M4 | -1.64 |
| | 41055 | 0 | 20.93 | -0.08 | M4 | -1.53 |
| | 40620 | 0 | 20.84 | 0.04 | M4 | -1.49 |
| | 40185 | 0 | 21.20 | -0.11 | M4 | -1.46 |
| | 39750 | 0 | 20.97 | -0.02 | M4 | -1.56 |

13 ANSIC 63.19-2011 LIMITS

WD RF audio interference level categories in logarithmic units

| Emission categories | < 960 MHz | |
|---------------------|-------------------|----------|
| | E-field emissions | |
| Category M1 | 50 to 55 | dB (V/m) |
| Category M2 | 45 to 50 | dB (V/m) |
| Category M3 | 40 to 45 | dB (V/m) |
| Category M4 | < 40 | dB (V/m) |
| Emission categories | >960 MHz | |
| | E-field emissions | |
| Category M1 | 40 to 45 | dB (V/m) |
| Category M2 | 35 to 40 | dB (V/m) |
| Category M3 | 30 to 35 | dB (V/m) |
| Category M4 | < 30 | dB (V/m) |

14 MEASUREMENT UNCERTAINTY

| No. | Error source | Type | Uncertainty Value(%) | Prob. Dist. | k | c _i E | Standard Uncertainty (%) u_i (%)E | Degree of freedom V_{eff} or ν_i |
|----------------------------|--------------------------------|------|----------------------|-------------|------------|------------------|-------------------------------------|--|
| Measurement System | | | | | | | | |
| 1 | Probe Calibration | B | 5. | N | 1 | 1 | 5.1 | ∞ |
| 2 | Axial Isotropy | B | 4.7 | R | $\sqrt{3}$ | 1 | 2.7 | ∞ |
| 3 | Sensor Displacement | B | 16.5 | R | $\sqrt{3}$ | 1 | 9.5 | ∞ |
| 4 | Boundary Effects | B | 2.4 | R | $\sqrt{3}$ | 1 | 1.4 | ∞ |
| 5 | Linearity | B | 4.7 | R | $\sqrt{3}$ | 1 | 2.7 | ∞ |
| 6 | Scaling to Peak Envelope Power | B | 2.0 | R | $\sqrt{3}$ | 1 | 1.2 | ∞ |
| 7 | System Detection Limit | B | 1.0 | R | $\sqrt{3}$ | 1 | 0.6 | ∞ |
| 8 | Readout Electronics | B | 0.3 | N | 1 | 1 | 0.3 | ∞ |
| 9 | Response Time | B | 0.8 | R | $\sqrt{3}$ | 1 | 0.5 | ∞ |
| 10 | Integration Time | B | 2.6 | R | $\sqrt{3}$ | 1 | 1.5 | ∞ |
| 11 | RF Ambient Conditions | B | 3.0 | R | $\sqrt{3}$ | 1 | 1.7 | ∞ |
| 12 | RF Reflections | B | 12.0 | R | $\sqrt{3}$ | 1 | 6.9 | ∞ |
| 13 | Probe Positioner | B | 1.2 | R | $\sqrt{3}$ | 1 | 0.7 | ∞ |
| 14 | Probe Positioning | A | 4.7 | R | $\sqrt{3}$ | 1 | 2.7 | ∞ |
| 15 | Extra. And Interpolation | B | 1.0 | R | $\sqrt{3}$ | 1 | 0.6 | ∞ |
| Test Sample Related | | | | | | | | |
| 16 | Device Positioning Vertical | B | 4.7 | R | $\sqrt{3}$ | 1 | 2.7 | ∞ |
| 17 | Device Positioning Lateral | B | 1.0 | R | $\sqrt{3}$ | 1 | 0.6 | ∞ |
| 18 | Device Holder and Phantom | B | 2.4 | R | $\sqrt{3}$ | 1 | 1.4 | ∞ |
| 19 | Power Drift | B | 5.0 | R | $\sqrt{3}$ | 1 | 2.9 | ∞ |

| | | | | | | | | |
|---|-------------------|--------------|-----|---|------------|---|------|----------|
| 20 | AIA measurement | B | 12 | R | $\sqrt{3}$ | 1 | 6.9 | ∞ |
| Phantom and Setup related | | | | | | | | |
| 21 | Phantom Thickness | B | 2.4 | R | $\sqrt{3}$ | 1 | 1.4 | ∞ |
| Combined standard uncertainty(%) | | | | | | | 16.2 | |
| Expanded uncertainty (confidence interval of 95 %) | | $u_e = 2u_c$ | | N | k=2 | | 32.4 | |

15 MAIN TEST INSTRUMENTS

Table 1: List of Main Instruments

| No. | Name | Type | Serial Number | Calibration Date | Valid Period |
|-----|------------------|---------------|---------------|--------------------------|--------------|
| 01 | Signal Generator | E4438C | MY49071430 | January 2, 2018 | One Year |
| 02 | Power meter | NRVD | 102083 | November 01, 2017 | One year |
| 03 | Power sensor | NRV-Z5 | 100542 | | |
| 04 | Amplifier | 60S1G4 | 0331848 | No Calibration Requested | |
| 05 | AIA | SE UMS 170 CB | 1029 | No Calibration Requested | |
| 06 | E-Field Probe | ER3DV6 | 2272 | December 19, 2017 | One year |
| 07 | DAE | SPEAG DAE4 | 777 | September 8, 2017 | One year |
| 08 | HAC Dipole | CD835V3 | 1023 | August 23, 2017 | One year |
| 09 | HAC Dipole | CD1880V3 | 1018 | August 23, 2017 | One year |
| 10 | HAC Dipole | CD2600V3 | 1005 | March 14, 2018 | One year |
| 11 | BTS | E5515C | MY50263375 | January 23, 2018 | One year |
| 12 | BTS | CMW 500 | 164049 | September 12, 2017 | One year |

16 CONCLUSION

The HAC measurement indicates that the EUT complies with the HAC limits of the ANSIC63.19-2011. The total M-rating is **M4**.

END OF REPORT BODY

ANNEX A TEST LAYOUT



Picture A1:HAC RF System Layout

ANNEX B TEST PLOTS

HAC RF E-Field GSM 850 High

Date: 2018-4-29

Electronics: DAE4 Sn777

Medium: Air

Medium parameters used: $\sigma = 0$ mho/m, $\epsilon_r = 1$; $\rho = 1000$ kg/m³

Ambient Temperature: 22.0°C

Communication System: GSM 850; Frequency: 848.8 MHz; Duty Cycle: 1:8.3

Probe: ER3DV6 - SN2272; ConvF(1, 1, 1)

E Scan - ER3DV6 - 2011: 15 mm from Probe Center to the Device/Hearing Aid

Compatibility Test (101x101x1): Interpolated grid: dx=0.5000 mm, dy=0.5000 mm

Device Reference Point: 0, 0, -6.3 mm

Reference Value = 41.61 V/m; Power Drift = -0.02 dB

Applied MIF = 3.49 dB

RF audio interference level = 34.69 dBV/m

Emission category: M4

MIF scaled E-field

| | | |
|--------------------------|--------------------------|--------------------------|
| Grid 1 M4 32.27 dBV/m | Grid 2 M4 33.83 dBV/m | Grid 3 M4 33.81 dBV/m |
| Grid 4 M4 33.46 dBV/m | Grid 5 M4 34.69 dBV/m | Grid 6 M4 34.69 dBV/m |
| Grid 7 M4 34.61 dBV/m | Grid 8 M4 35.35 dBV/m | Grid 9 M4 35.34 dBV/m |

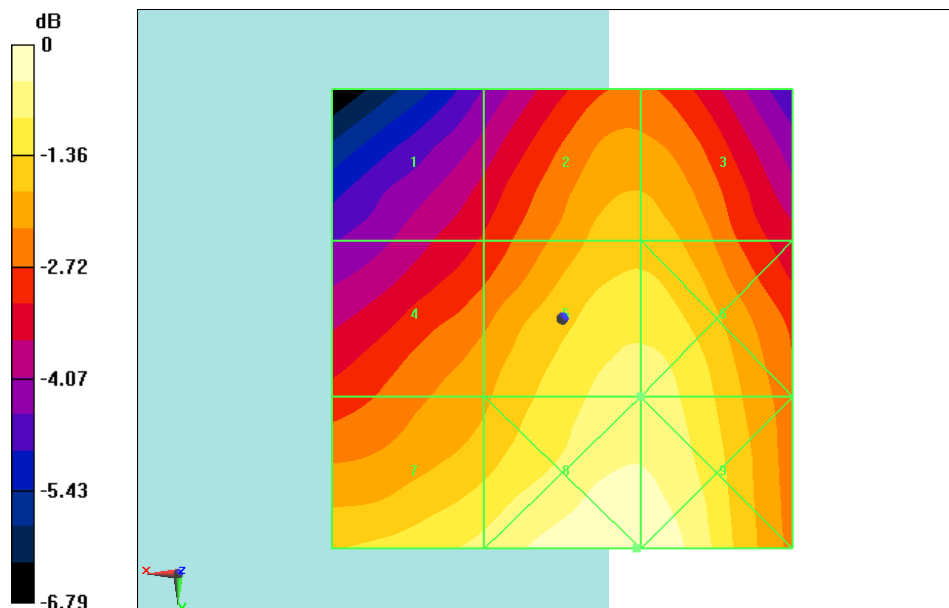

0 dB = 58.53 V/m = 35.35 dBV/m

Fig B.1 HAC RF E-Field GSM 850 High

HAC RF E-Field GSM 850 Middle

Date: 2018-4-29

Electronics: DAE4 Sn777

Medium: Air

Medium parameters used: $\sigma = 0$ mho/m, $\epsilon_r = 1$; $\rho = 1000$ kg/m³

Ambient Temperature: 22.0°C

Communication System: GSM 850; Frequency: 836.6 MHz; Duty Cycle: 1:8.3

Probe: ER3DV6 - SN2272;ConvF(1, 1, 1)

E Scan - ER3DV6 - 2011: 15 mm from Probe Center to the Device 2/Hearing Aid Compatibility Test (101x101x1): Interpolated grid: dx=0.5000 mm, dy=0.5000 mm

Device Reference Point: 0, 0, -6.3 mm

Reference Value = 31.34 V/m; Power Drift = -0.03 dB

Applied MIF = 3.50 dB

RF audio interference level = 33.45 dBV/m

Emission category: M4

MIF scaled E-field

| | | |
|--------------------------|--------------------------|--------------------------|
| Grid 1 M4 32.83 dBV/m | Grid 2 M4 31.78 dBV/m | Grid 3 M4 29.58 dBV/m |
| Grid 4 M4 34.27 dBV/m | Grid 5 M4 33.45 dBV/m | Grid 6 M4 30.49 dBV/m |
| Grid 7 M4 35.9 dBV/m | Grid 8 M4 35.12 dBV/m | Grid 9 M4 31.48 dBV/m |

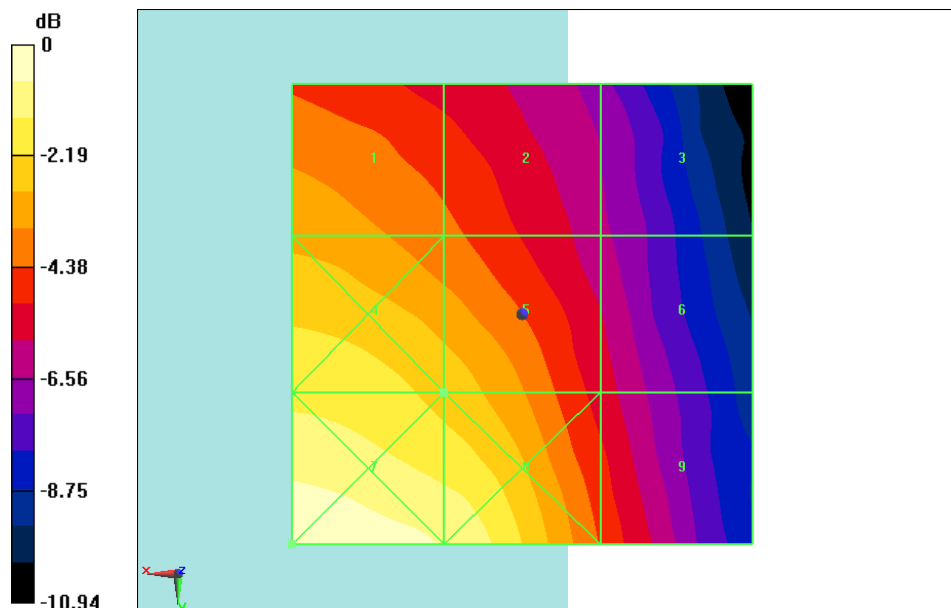

0 dB = 62.34 V/m = 35.90 dBV/m

Fig B.2 HAC RF E-Field GSM 850 Middle

HAC RF E-Field GSM 850 Low

Date: 2018-4-29

Electronics: DAE4 Sn777

Medium: Air

Medium parameters used: $\sigma = 0$ mho/m, $\epsilon_r = 1$; $\rho = 1000$ kg/m³

Ambient Temperature: 22.0°C

Communication System: GSM 850; Frequency: 824.2 MHz; Duty Cycle: 1:8.3

Probe: ER3DV6 - SN2272;ConvF(1, 1, 1)

E Scan - ER3DV6 - 2011: 15 mm from Probe Center to the Device 3/Hearing Aid Compatibility Test (101x101x1): Interpolated grid: dx=0.5000 mm, dy=0.5000 mm

Device Reference Point: 0, 0, -6.3 mm

Reference Value = 45.99 V/m; Power Drift = 0.03 dB

Applied MIF = 3.52 dB

RF audio interference level = 35.52 dBV/m

Emission category: M4

MIF scaled E-field

| | | |
|--------------------------|--------------------------|--------------------------|
| Grid 1 M4 33.25 dBV/m | Grid 2 M4 34.74 dBV/m | Grid 3 M4 34.72 dBV/m |
| Grid 4 M4 34.14 dBV/m | Grid 5 M4 35.52 dBV/m | Grid 6 M4 35.5 dBV/m |
| Grid 7 M4 34.77 dBV/m | Grid 8 M4 36.08 dBV/m | Grid 9 M4 36.07 dBV/m |

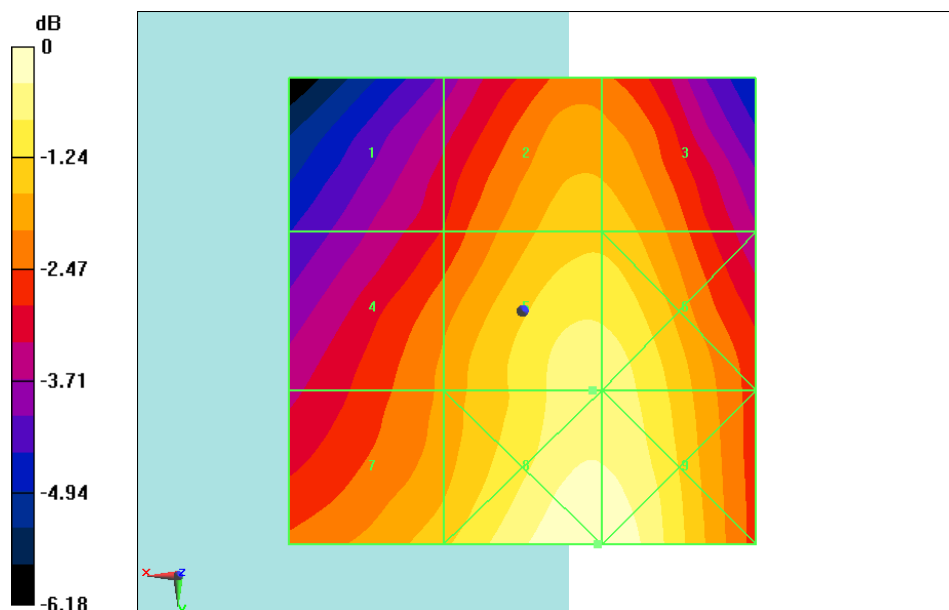

0 dB = 63.68 V/m = 36.08 dBV/m

Fig B.3 HAC RF E-Field GSM 850 Low

HAC RF E-Field GSM 1900 High

Date: 2018-4-29

Electronics: DAE4 Sn777

Medium: Air

Medium parameters used: $\sigma = 0$ mho/m, $\epsilon_r = 1$; $\rho = 1000$ kg/m³

Ambient Temperature: 22.0°C

Communication System: DCS 1900; Frequency: 1909.8 MHz; Duty Cycle: 1:8.3

Probe: ER3DV6 - SN2272; ConvF(1, 1, 1)

E Scan - ER3DV6 - 2011: 15 mm from Probe Center to the Device/Hearing Aid Compatibility Test (101x101x1): Interpolated grid: dx=0.5000 mm, dy=0.5000 mm

Device Reference Point: 0, 0, -6.3 mm

Reference Value = 9.741 V/m; Power Drift = -0.06 dB

Applied MIF = 3.51 dB

RF audio interference level = 26.73 dBV/m

Emission category: M4

MIF scaled E-field

| | | |
|---------------------------------|---------------------------------|---------------------------------|
| Grid 1 M4 27.61 dBV/m | Grid 2 M4 26.73 dBV/m | Grid 3 M4 25.62 dBV/m |
| Grid 4 M4 27.69 dBV/m | Grid 5 M4 25.52 dBV/m | Grid 6 M4 22.07 dBV/m |
| Grid 7 M4 27.3 dBV/m | Grid 8 M4 24.79 dBV/m | Grid 9 M4 22.82 dBV/m |

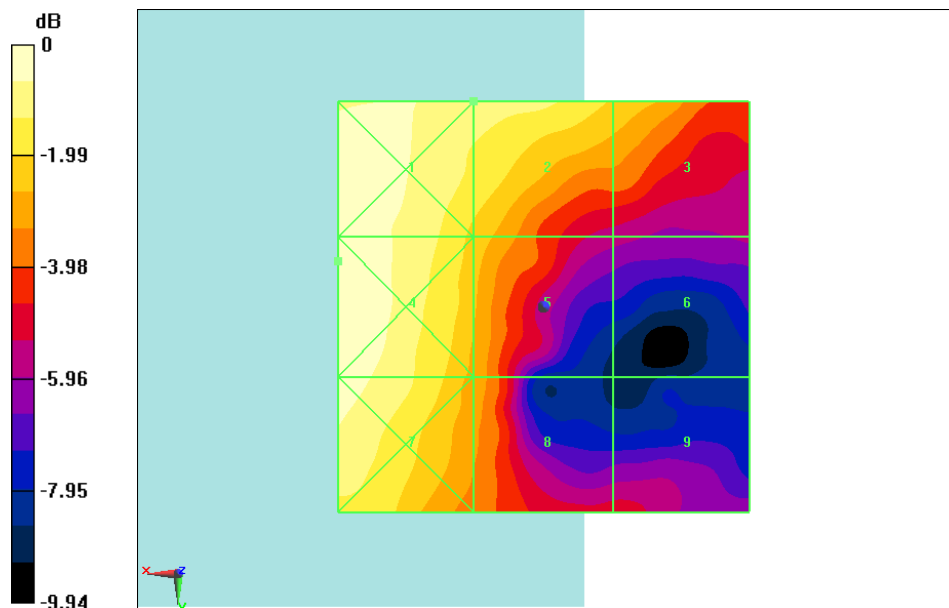

0 dB = 24.24 V/m = 27.69 dBV/m

Fig B.4 HAC RF E-Field GSM 1900 High

HAC RF E-Field GSM 1900 Middle

Date: 2018-4-29

Electronics: DAE4 Sn777

Medium: Air

Medium parameters used: $\sigma = 0$ mho/m, $\epsilon_r = 1$; $\rho = 1000$ kg/m³

Ambient Temperature: 22.0°C

Communication System: DCS 1900; Frequency: 1880 MHz; Duty Cycle: 1:8.3

Probe: ER3DV6 - SN2272;ConvF(1, 1, 1)

E Scan - ER3DV6 - 2011: 15 mm from Probe Center to the Device 2/Hearing Aid Compatibility Test (101x101x1): Interpolated grid: dx=0.5000 mm, dy=0.5000 mm

Device Reference Point: 0, 0, -6.3 mm

Reference Value = 9.644 V/m; Power Drift = -0.04 dB

Applied MIF = 3.49 dB

RF audio interference level = 26.47 dBV/m

Emission category: M4

MIF scaled E-field

| | | |
|---------------------------------|---------------------------------|---------------------------------|
| Grid 1 M4 27.44 dBV/m | Grid 2 M4 26.47 dBV/m | Grid 3 M4 24.84 dBV/m |
| Grid 4 M4 27.59 dBV/m | Grid 5 M4 25.31 dBV/m | Grid 6 M4 21.3 dBV/m |
| Grid 7 M4 27.25 dBV/m | Grid 8 M4 24.49 dBV/m | Grid 9 M4 22.66 dBV/m |

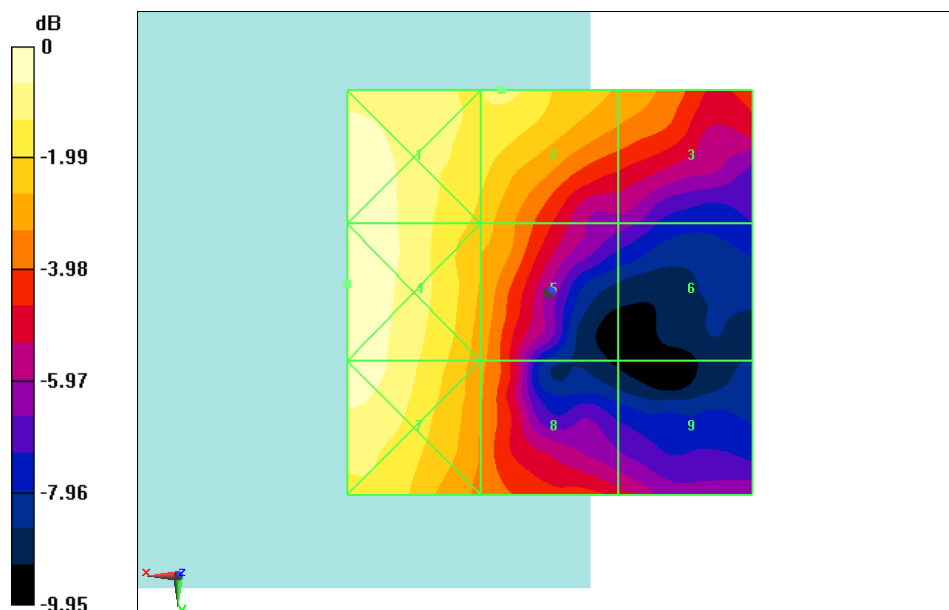

0 dB = 23.97 V/m = 27.59 dBV/m

Fig B.5 HAC RF E-Field GSM 1900 Middle

HAC RF E-Field GSM 1900 Low

Date: 2018-4-29

Electronics: DAE4 Sn777

Medium: Air

Medium parameters used: $\sigma = 0$ mho/m, $\epsilon_r = 1$; $\rho = 1000$ kg/m³

Ambient Temperature: 22.0°C

Communication System: DCS 1900; Frequency: 1850.2 MHz; Duty Cycle: 1:8.3

Probe: ER3DV6 - SN2272; ConvF(1, 1, 1)

E Scan - ER3DV6 - 2011: 15 mm from Probe Center to the Device 3/Hearing Aid Compatibility Test (101x101x1): Interpolated grid: dx=0.5000 mm, dy=0.5000 mm

Device Reference Point: 0, 0, -6.3 mm

Reference Value = 8.963 V/m; Power Drift = -0.12 dB

Applied MIF = 3.51 dB

RF audio interference level = 25.99 dBV/m

Emission category: M4

MIF scaled E-field

| | | |
|---------------------------------|---------------------------------|---------------------------------|
| Grid 1 M4 27.57 dBV/m | Grid 2 M4 25.99 dBV/m | Grid 3 M4 24.3 dBV/m |
| Grid 4 M4 27.55 dBV/m | Grid 5 M4 25.26 dBV/m | Grid 6 M4 20.26 dBV/m |
| Grid 7 M4 27.32 dBV/m | Grid 8 M4 24.82 dBV/m | Grid 9 M4 23.36 dBV/m |

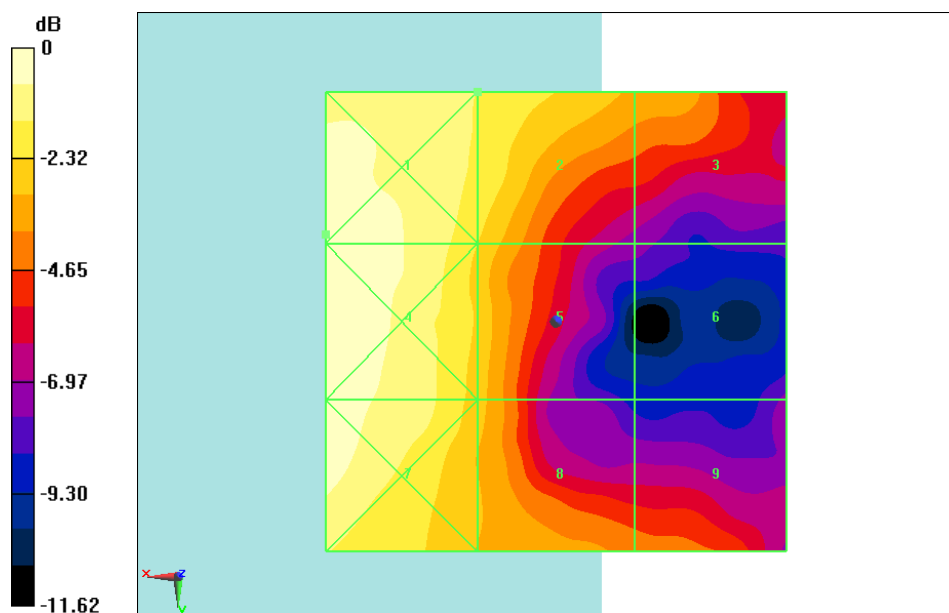

0 dB = 23.91 V/m = 27.57 dBV/m

Fig B.6 HAC RF E-Field GSM 1900 Low

HAC RF E-Field LTE Band41 QPSK High

Date: 2018-4-29

Electronics: DAE4 Sn777

Medium: Air

Medium parameters used: $\sigma = 0$ mho/m, $\epsilon_r = 1$; $\rho = 1000$ kg/m³

Ambient Temperature: 22.0°C

Communication System: LTE Band41; Frequency: 2680 MHz; Duty Cycle: 1:1.58

Probe: ER3DV6 - SN2272;ConvF(1, 1, 1)

E Scan - ER3DV6 - 2011: 15 mm from Probe Center to the Device/Hearing Aid Compatibility Test (101x101x1): Interpolated grid: dx=0.5000 mm, dy=0.5000 mm

Device Reference Point: 0, 0, -6.3 mm

Reference Value = 10.72 V/m; Power Drift = -0.02 dB

Applied MIF = -1.78 dB

RF audio interference level = 21.01 dBV/m

Emission category: M4

MIF scaled E-field

| | | |
|--------------------------|--------------------------|--------------------------|
| Grid 1 M4 23.25 dBV/m | Grid 2 M4 21.01 dBV/m | Grid 3 M4 19.46 dBV/m |
| Grid 4 M4 23.3 dBV/m | Grid 5 M4 20.6 dBV/m | Grid 6 M4 17.9 dBV/m |
| Grid 7 M4 22.76 dBV/m | Grid 8 M4 20.25 dBV/m | Grid 9 M4 14.68 dBV/m |

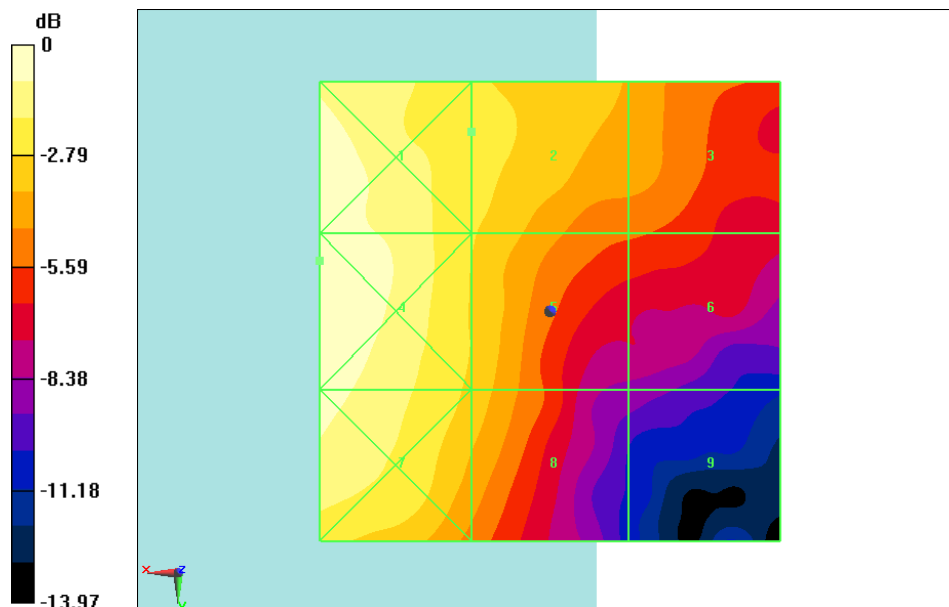

0 dB = 14.63 V/m = 23.30 dBV/m

Fig B.7 HAC RF E-Field LTE Band41 QPSK High

HAC RF E-Field LTE Band41 QPSK 2636.5MHz

Date: 2018-4-29

Electronics: DAE4 Sn777

Medium: Air

Medium parameters used: $\sigma = 0$ mho/m, $\epsilon_r = 1$; $\rho = 1000$ kg/m³

Ambient Temperature: 22.0°C

Communication System: LTE Band41; Frequency: 2636.5 MHz; Duty Cycle: 1:1.58

Probe: ER3DV6 - SN2272;ConvF(1, 1, 1)

E Scan - ER3DV6 - 2011: 15 mm from Probe Center to the Device 2/Hearing Aid

Compatibility Test (101x101x1): Interpolated grid: dx=0.5000 mm, dy=0.5000 mm

Device Reference Point: 0, 0, -6.3 mm

Reference Value = 10.40 V/m; Power Drift = -0.10 dB

Applied MIF = -1.76 dB

RF audio interference level = 20.83 dBV/m

Emission category: M4

MIF scaled E-field

| | | |
|--------------------------|--------------------------|--------------------------|
| Grid 1 M4 23.42 dBV/m | Grid 2 M4 20.83 dBV/m | Grid 3 M4 19.36 dBV/m |
| Grid 4 M4 23.38 dBV/m | Grid 5 M4 20.42 dBV/m | Grid 6 M4 17.52 dBV/m |
| Grid 7 M4 22.67 dBV/m | Grid 8 M4 20.02 dBV/m | Grid 9 M4 14.08 dBV/m |

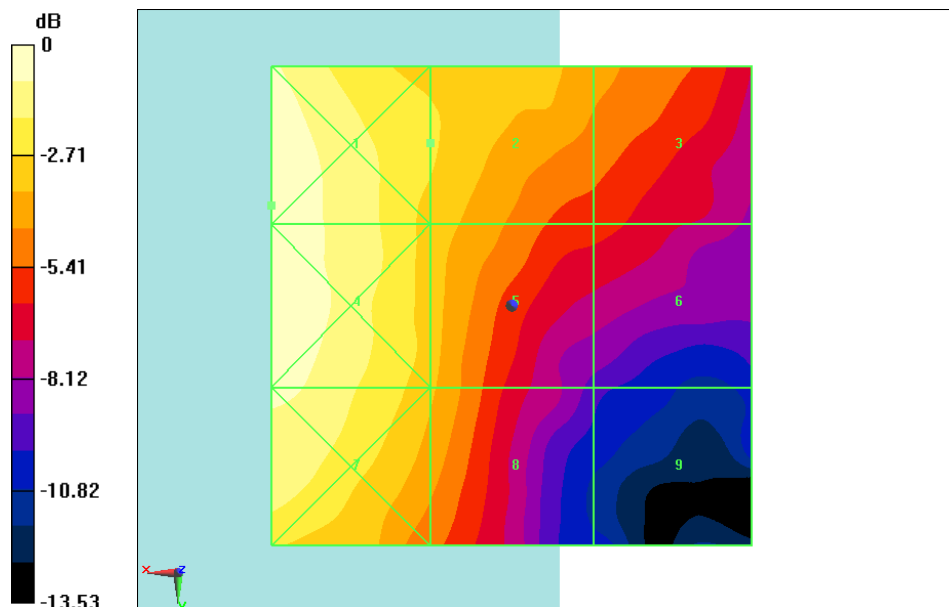

0 dB = 14.82 V/m = 23.42 dBV/m

Fig B.8 HAC RF E-Field LTE Band41 QPSK 2636.5MHz

HAC RF E-Field LTE Band41 QPSK Middle

Date: 2018-4-29

Electronics: DAE4 Sn777

Medium: Air

Medium parameters used: $\sigma = 0$ mho/m, $\epsilon_r = 1$; $\rho = 1000$ kg/m³

Ambient Temperature: 22.0°C

Communication System: LTE Band41; Frequency: 2593 MHz; Duty Cycle: 1:1.58

Probe: ER3DV6 - SN2272;ConvF(1, 1, 1)

E Scan - ER3DV6 - 2011: 15 mm from Probe Center to the Device 3/Hearing Aid

Compatibility Test (101x101x1): Interpolated grid: dx=0.5000 mm, dy=0.5000 mm

Device Reference Point: 0, 0, -6.3 mm

Reference Value = 10.91 V/m; Power Drift = -0.05 dB

Applied MIF = -1.68 dB

RF audio interference level = 21.20 dBV/m

Emission category: M4

MIF scaled E-field

| | | |
|--------------------------|--------------------------|--------------------------|
| Grid 1 M4 23.17 dBV/m | Grid 2 M4 21.2 dBV/m | Grid 3 M4 19.32 dBV/m |
| Grid 4 M4 23.2 dBV/m | Grid 5 M4 20.62 dBV/m | Grid 6 M4 17.26 dBV/m |
| Grid 7 M4 22.63 dBV/m | Grid 8 M4 19.85 dBV/m | Grid 9 M4 14.47 dBV/m |

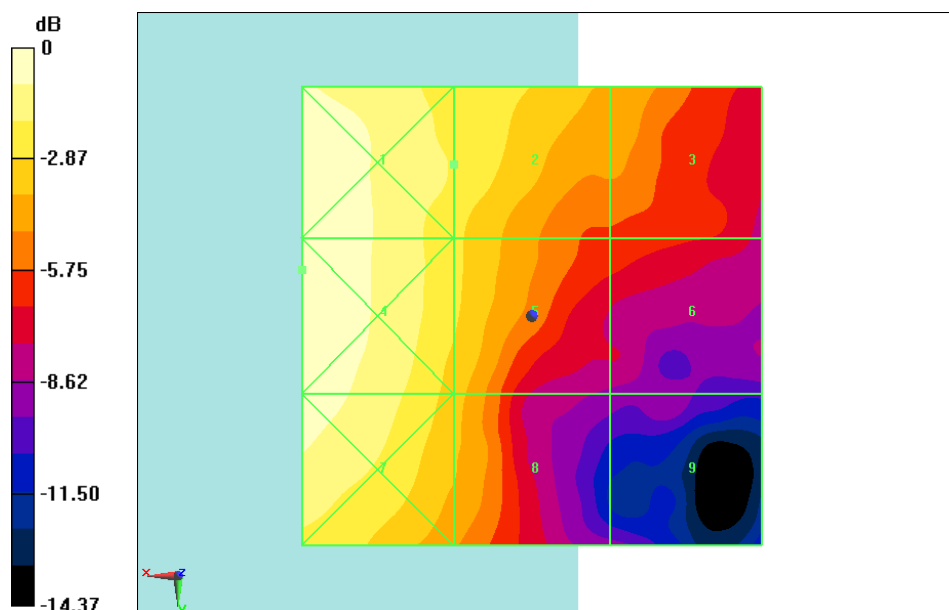

0 dB = 14.46 V/m = 23.20 dBV/m

Fig B.9 HAC RF E-Field LTE Band41 QPSK Middle

HAC RF E-Field LTE Band41 QPSK 2549.5MHz

Date: 2018-4-29

Electronics: DAE4 Sn777

Medium: Air

Medium parameters used: $\sigma = 0$ mho/m, $\epsilon_r = 1$; $\rho = 1000$ kg/m³

Ambient Temperature: 22.0°C

Communication System: LTE Band41; Frequency: 2549.5 MHz; Duty Cycle: 1:1.58

Probe: ER3DV6 - SN2272;ConvF(1, 1, 1)

E Scan - ER3DV6 - 2011: 15 mm from Probe Center to the Device 3 3/Hearing Aid

Compatibility Test (101x101x1): Interpolated grid: dx=0.5000 mm, dy=0.5000 mm

Device Reference Point: 0, 0, -6.3 mm

Reference Value = 9.910 V/m; Power Drift = 0.07 dB

Applied MIF = -1.71 dB

RF audio interference level = 20.54 dBV/m

Emission category: M4

MIF scaled E-field

| | | |
|--------------------------|--------------------------|--------------------------|
| Grid 1 M4 22.76 dBV/m | Grid 2 M4 20.54 dBV/m | Grid 3 M4 17.76 dBV/m |
| Grid 4 M4 22.78 dBV/m | Grid 5 M4 20.37 dBV/m | Grid 6 M4 16.49 dBV/m |
| Grid 7 M4 22.32 dBV/m | Grid 8 M4 19.82 dBV/m | Grid 9 M4 14.66 dBV/m |

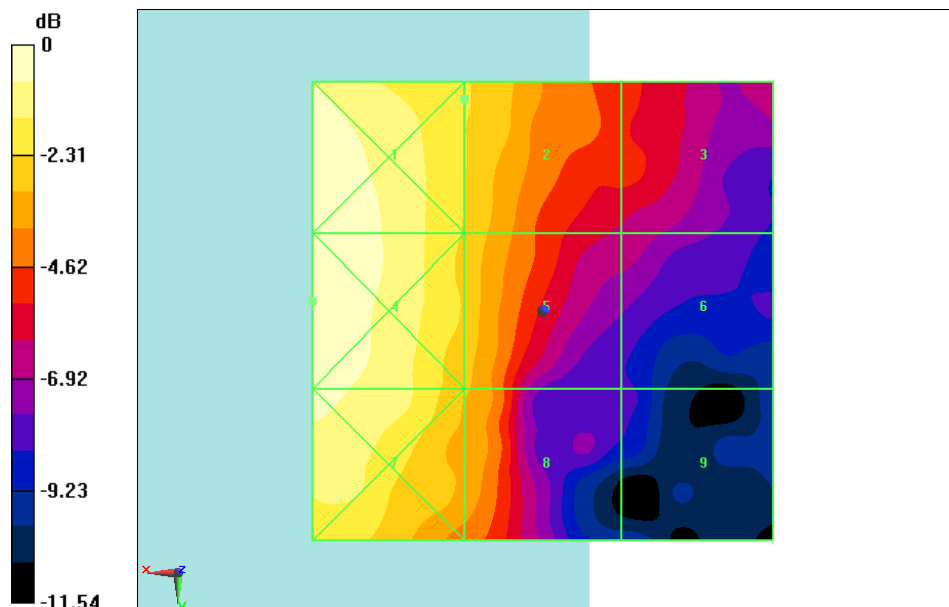

0 dB = 13.77 V/m = 22.78 dBV/m

Fig B.10 HAC RF E-Field LTE Band41 QPSK 2549.5MHz

HAC RF E-Field LTE Band41 QPSK Low

Date: 2018-4-29

Electronics: DAE4 Sn777

Medium: Air

Medium parameters used: $\sigma = 0$ mho/m, $\epsilon_r = 1$; $\rho = 1000$ kg/m³

Ambient Temperature: 22.0°C

Communication System: LTE Band41; Frequency: 2506 MHz; Duty Cycle: 1:1.58

Probe: ER3DV6 - SN2272;ConvF(1, 1, 1)

E Scan - ER3DV6 - 2011: 15 mm from Probe Center to the Device 3 2/Hearing Aid

Compatibility Test (101x101x1): Interpolated grid: dx=0.5000 mm, dy=0.5000 mm

Device Reference Point: 0, 0, -6.3 mm

Reference Value = 9.290 V/m; Power Drift = 0.13 dB

Applied MIF = -1.69 dB

RF audio interference level = 20.14 dBV/m

Emission category: M4

MIF scaled E-field

| | | |
|--------------------------|--------------------------|--------------------------|
| Grid 1 M4 22.5 dBV/m | Grid 2 M4 20.14 dBV/m | Grid 3 M4 16.89 dBV/m |
| Grid 4 M4 22.65 dBV/m | Grid 5 M4 19.95 dBV/m | Grid 6 M4 15.19 dBV/m |
| Grid 7 M4 22.11 dBV/m | Grid 8 M4 19.56 dBV/m | Grid 9 M4 13.36 dBV/m |

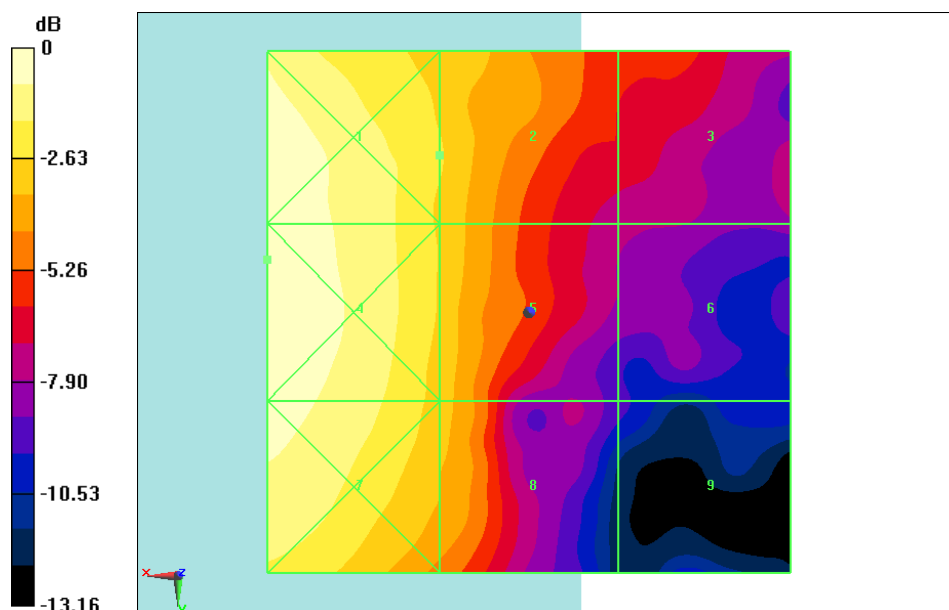

0 dB = 13.56 V/m = 22.65 dBV/m

Fig B.11 HAC RF E-Field LTE Band41 QPSK Low

HAC RF E-Field LTE Band41 16QAM High

Date: 2018-4-29

Electronics: DAE4 Sn777

Medium: Air

Medium parameters used: $\sigma = 0$ mho/m, $\epsilon_r = 1$; $\rho = 1000$ kg/m³

Ambient Temperature: 22.0°C

Communication System: LTE Band41; Frequency: 2680 MHz; Duty Cycle: 1:1.58

Probe: ER3DV6 - SN2272;ConvF(1, 1, 1)

E Scan - ER3DV6 - 2011: 15 mm from Probe Center to the Device/Hearing Aid Compatibility Test (101x101x1): Interpolated grid: dx=0.5000 mm, dy=0.5000 mm

Device Reference Point: 0, 0, -6.3 mm

Reference Value = 10.14 V/m; Power Drift = 0.25 dB

Applied MIF = -1.73 dB

RF audio interference level = 20.78 dBV/m

Emission category: M4

MIF scaled E-field

| | | |
|--------------------------|--------------------------|--------------------------|
| Grid 1 M4 23.03 dBV/m | Grid 2 M4 20.78 dBV/m | Grid 3 M4 19.02 dBV/m |
| Grid 4 M4 23.03 dBV/m | Grid 5 M4 20.53 dBV/m | Grid 6 M4 17.28 dBV/m |
| Grid 7 M4 22.65 dBV/m | Grid 8 M4 19.93 dBV/m | Grid 9 M4 15.05 dBV/m |

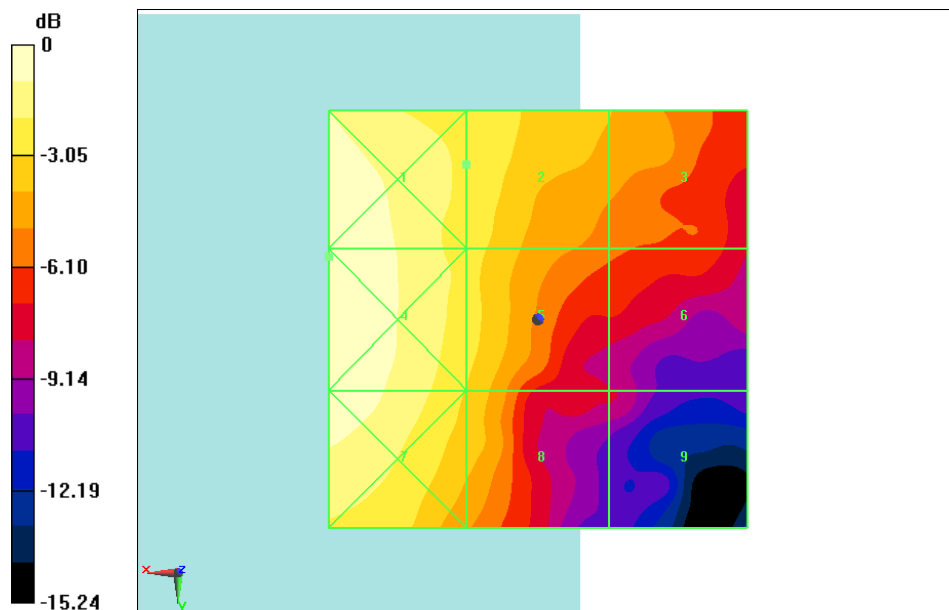

0 dB = 14.17 V/m = 23.03 dBV/m

Fig B.12 HAC RF E-Field LTE Band41 16QAM High

HAC RF E-Field LTE Band41 16QAM 2636.5MHz

Date: 2018-4-29

Electronics: DAE4 Sn777

Medium: Air

Medium parameters used: $\sigma = 0$ mho/m, $\epsilon_r = 1$; $\rho = 1000$ kg/m³

Ambient Temperature: 22.0°C

Communication System: LTE Band41; Frequency: 2636.5 MHz; Duty Cycle: 1:1.58

Probe: ER3DV6 - SN2272;ConvF(1, 1, 1)

E Scan - ER3DV6 - 2011: 15 mm from Probe Center to the Device 2/Hearing Aid

Compatibility Test (101x101x1): Interpolated grid: dx=0.5000 mm, dy=0.5000 mm

Device Reference Point: 0, 0, -6.3 mm

Reference Value = 10.49 V/m; Power Drift = 0.02 dB

Applied MIF = -1.59 dB

RF audio interference level = 20.66 dBV/m

Emission category: M4

MIF scaled E-field

| | | |
|--------------------------|--------------------------|--------------------------|
| Grid 1 M4 23.46 dBV/m | Grid 2 M4 20.66 dBV/m | Grid 3 M4 19.19 dBV/m |
| Grid 4 M4 23.47 dBV/m | Grid 5 M4 20.65 dBV/m | Grid 6 M4 17.12 dBV/m |
| Grid 7 M4 23 dBV/m | Grid 8 M4 20.35 dBV/m | Grid 9 M4 14.25 dBV/m |

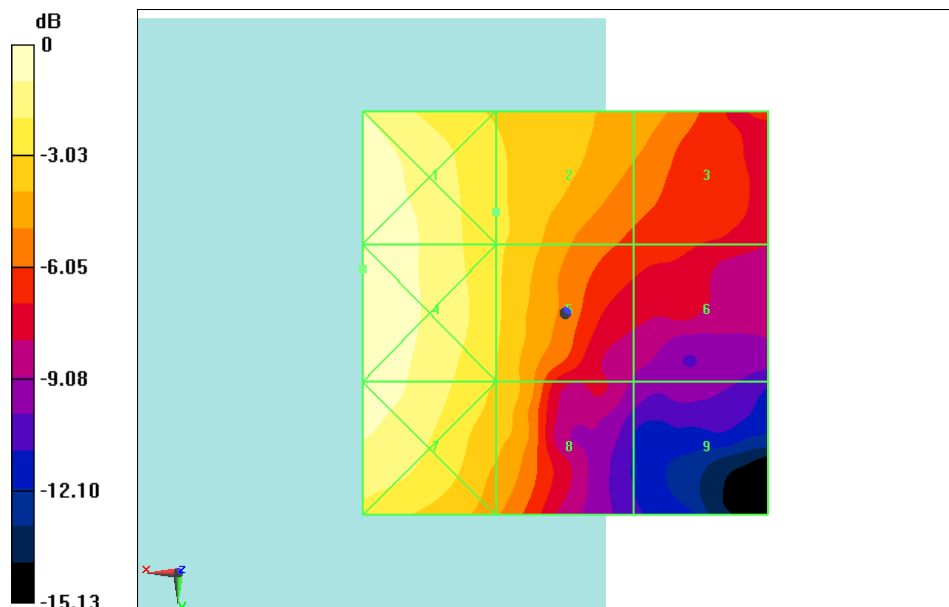

0 dB = 14.92 V/m = 23.48 dBV/m

Fig B.13 HAC RF E-Field LTE Band41 16QAM 2636.5MHz

HAC RF E-Field LTE Band41 16QAM Middle

Date: 2018-4-29

Electronics: DAE4 Sn777

Medium: Air

Medium parameters used: $\sigma = 0$ mho/m, $\epsilon_r = 1$; $\rho = 1000$ kg/m³

Ambient Temperature: 22.0°C

Communication System: LTE Band41; Frequency: 2593 MHz; Duty Cycle: 1:1.58

Probe: ER3DV6 - SN2272;ConvF(1, 1, 1)

E Scan - ER3DV6 - 2011: 15 mm from Probe Center to the Device 3/Hearing Aid

Compatibility Test (101x101x1): Interpolated grid: dx=0.5000 mm, dy=0.5000 mm

Device Reference Point: 0, 0, -6.3 mm

Reference Value = 10.34 V/m; Power Drift = -0.15 dB

Applied MIF = -1.57 dB

RF audio interference level = 20.90 dBV/m

Emission category: M4

MIF scaled E-field

| | | |
|---------------------------------|---------------------------------|---------------------------------|
| Grid 1 M4 23.29 dBV/m | Grid 2 M4 20.9 dBV/m | Grid 3 M4 18.62 dBV/m |
| Grid 4 M4 23.32 dBV/m | Grid 5 M4 20.74 dBV/m | Grid 6 M4 16.71 dBV/m |
| Grid 7 M4 22.77 dBV/m | Grid 8 M4 20.07 dBV/m | Grid 9 M4 14.77 dBV/m |

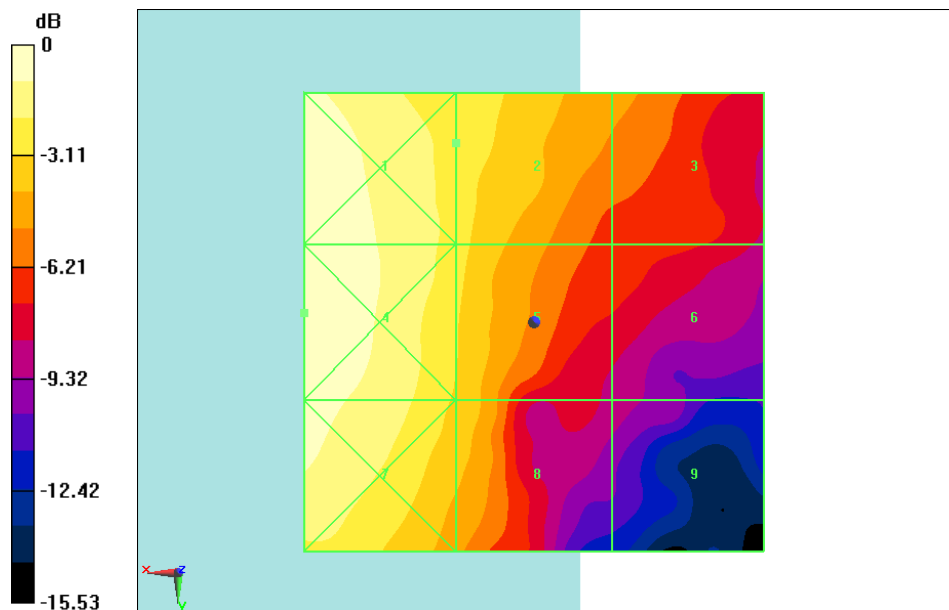

0 dB = 14.66 V/m = 23.32 dBV/m

Fig B.14 HAC RF E-Field LTE Band41 16QAM Middle

HAC RF E-Field LTE Band41 16QAM 2549.5MHz

Date: 2018-4-29

Electronics: DAE4 Sn777

Medium: Air

Medium parameters used: $\sigma = 0$ mho/m, $\epsilon_r = 1$; $\rho = 1000$ kg/m³

Ambient Temperature: 22.0°C

Communication System: LTE Band41; Frequency: 2549.5 MHz; Duty Cycle: 1:1.58

Probe: ER3DV6 - SN2272;ConvF(1, 1, 1)

E Scan - ER3DV6 - 2011: 15 mm from Probe Center to the Device 3 3/Hearing Aid

Compatibility Test (101x101x1): Interpolated grid: dx=0.5000 mm, dy=0.5000 mm

Device Reference Point: 0, 0, -6.3 mm

Reference Value = 10.22 V/m; Power Drift = 0.17 dB

Applied MIF = -1.67 dB

RF audio interference level = 21.05 dBV/m

Emission category: M4

MIF scaled E-field

| | | |
|--------------------------|--------------------------|--------------------------|
| Grid 1 M4 22.12 dBV/m | Grid 2 M4 21.05 dBV/m | Grid 3 M4 19.21 dBV/m |
| Grid 4 M4 21.88 dBV/m | Grid 5 M4 19.53 dBV/m | Grid 6 M4 16.92 dBV/m |
| Grid 7 M4 21.16 dBV/m | Grid 8 M4 18.24 dBV/m | Grid 9 M4 14.56 dBV/m |

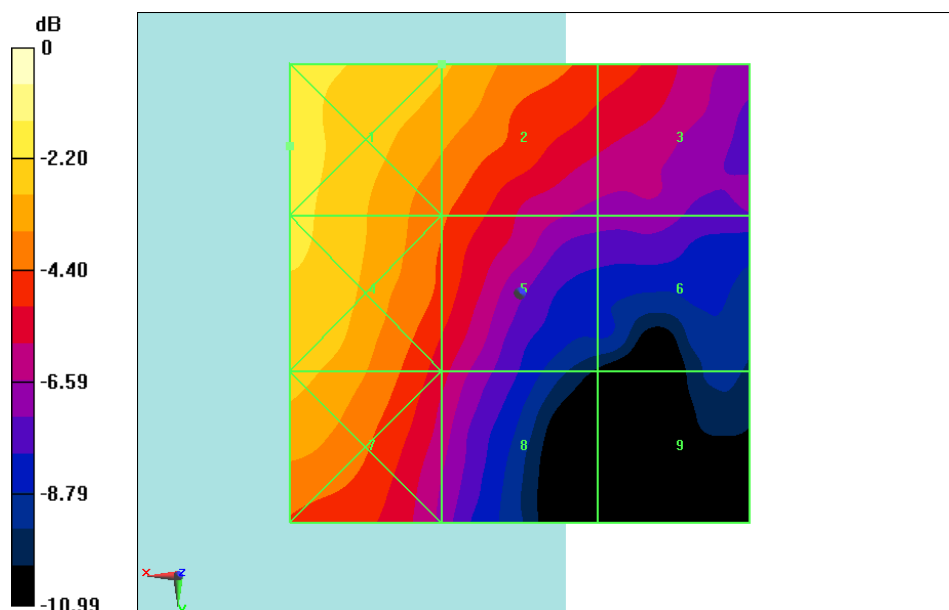

0 dB = 15.49 V/m = 23.80 dBV/m

Fig B.15 HAC RF E-Field LTE Band41 16QAM 2549.5MHz

HAC RF E-Field LTE Band41 16QAM Low

Date: 2018-4-29

Electronics: DAE4 Sn777

Medium: Air

Medium parameters used: $\sigma = 0$ mho/m, $\epsilon_r = 1$; $\rho = 1000$ kg/m³

Ambient Temperature: 22.0°C

Communication System: LTE Band41; Frequency: 2506 MHz; Duty Cycle: 1:1.58

Probe: ER3DV6 - SN2272;ConvF(1, 1, 1)

E Scan - ER3DV6 - 2011: 15 mm from Probe Center to the Device 3 2/Hearing Aid

Compatibility Test (101x101x1): Interpolated grid: dx=0.5000 mm, dy=0.5000 mm

Device Reference Point: 0, 0, -6.3 mm

Reference Value = 9.406 V/m; Power Drift = 0.08 dB

Applied MIF = -1.50 dB

RF audio interference level = 20.35 dBV/m

Emission category: M4

MIF scaled E-field

| | | |
|--------------------------|--------------------------|--------------------------|
| Grid 1 M4 22.82 dBV/m | Grid 2 M4 20.11 dBV/m | Grid 3 M4 16.66 dBV/m |
| Grid 4 M4 22.9 dBV/m | Grid 5 M4 20.35 dBV/m | Grid 6 M4 15.16 dBV/m |
| Grid 7 M4 22.61 dBV/m | Grid 8 M4 20.11 dBV/m | Grid 9 M4 13.66 dBV/m |

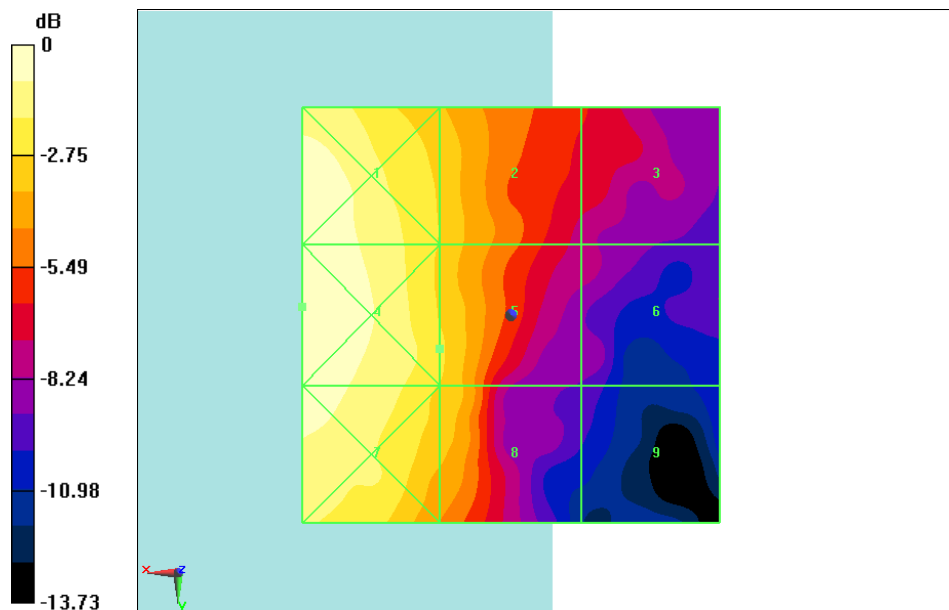

0 dB = 13.97 V/m = 22.90 dBV/m

Fig B.16 HAC RF E-Field LTE Band41 16QAM Low

HAC RF E-Field LTE Band41 64QAM High

Date: 2018-4-29

Electronics: DAE4 Sn777

Medium: Air

Medium parameters used: $\sigma = 0$ mho/m, $\epsilon_r = 1$; $\rho = 1000$ kg/m³

Ambient Temperature: 22.0°C

Communication System: LTE Band41; Frequency: 2680 MHz; Duty Cycle: 1:1.58

Probe: ER3DV6 - SN2272;ConvF(1, 1, 1)

E Scan - ER3DV6 - 2011: 15 mm from Probe Center to the Device/Hearing Aid Compatibility Test (101x101x1): Interpolated grid: dx=0.5000 mm, dy=0.5000 mm

Device Reference Point: 0, 0, -6.3 mm

Reference Value = 10.11 V/m; Power Drift = 0.11 dB

Applied MIF = -1.64 dB

RF audio interference level = 21.09 dBV/m

Emission category: M4

MIF scaled E-field

| | | |
|--------------------------|--------------------------|--------------------------|
| Grid 1 M4 22.21 dBV/m | Grid 2 M4 21.09 dBV/m | Grid 3 M4 19.16 dBV/m |
| Grid 4 M4 22.02 dBV/m | Grid 5 M4 19.73 dBV/m | Grid 6 M4 17.21 dBV/m |
| Grid 7 M4 21.29 dBV/m | Grid 8 M4 18.5 dBV/m | Grid 9 M4 13.72 dBV/m |

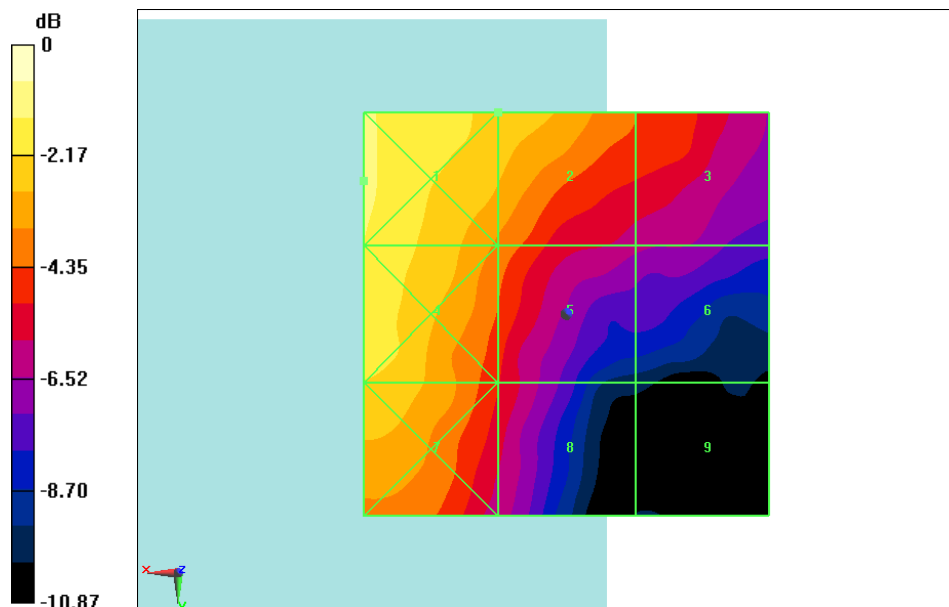

0 dB = 14.93 V/m = 23.48 dBV/m

Fig B.17 HAC RF E-Field LTE Band41 64QAM High

HAC RF E-Field LTE Band41 64QAM 2636.5MHz

Date: 2018-4-29

Electronics: DAE4 Sn777

Medium: Air

Medium parameters used: $\sigma = 0$ mho/m, $\epsilon_r = 1$; $\rho = 1000$ kg/m³

Ambient Temperature: 22.0°C

Communication System: LTE Band41; Frequency: 2636.5 MHz; Duty Cycle: 1:1.58

Probe: ER3DV6 - SN2272;ConvF(1, 1, 1)

E Scan - ER3DV6 - 2011: 15 mm from Probe Center to the Device 2/Hearing Aid

Compatibility Test (101x101x1): Interpolated grid: dx=0.5000 mm, dy=0.5000 mm

Device Reference Point: 0, 0, -6.3 mm

Reference Value = 10.70 V/m; Power Drift = -0.08 dB

Applied MIF = -1.53 dB

RF audio interference level = 20.93 dBV/m

Emission category: M4

MIF scaled E-field

| | | |
|--------------------------|--------------------------|--------------------------|
| Grid 1 M4 22.1 dBV/m | Grid 2 M4 20.93 dBV/m | Grid 3 M4 18.95 dBV/m |
| Grid 4 M4 21.85 dBV/m | Grid 5 M4 19.51 dBV/m | Grid 6 M4 17.22 dBV/m |
| Grid 7 M4 21.01 dBV/m | Grid 8 M4 18.15 dBV/m | Grid 9 M4 14.9 dBV/m |

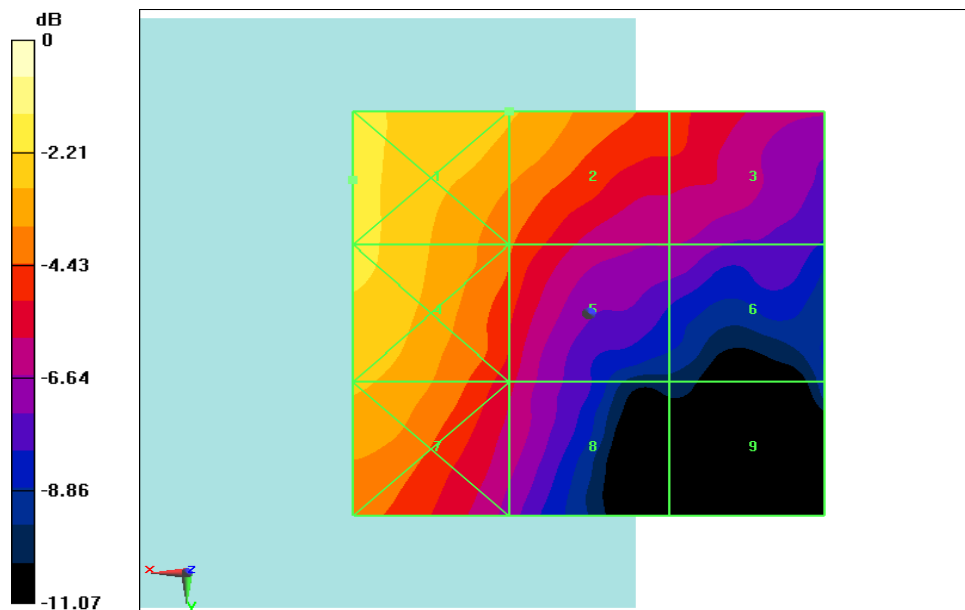

0 dB = 15.50 V/m = 23.81 dBV/m

Fig B.18 HAC RF E-Field LTE Band41 64QAM 2636.5MHz

HAC RF E-Field LTE Band41 64QAM Middle

Date: 2018-4-29

Electronics: DAE4 Sn777

Medium: Air

Medium parameters used: $\sigma = 0$ mho/m, $\epsilon_r = 1$; $\rho = 1000$ kg/m³

Ambient Temperature: 22.0°C

Communication System: LTE Band41; Frequency: 2593 MHz; Duty Cycle: 1:1.58

Probe: ER3DV6 - SN2272;ConvF(1, 1, 1)

E Scan - ER3DV6 - 2011: 15 mm from Probe Center to the Device 3/Hearing Aid

Compatibility Test (101x101x1): Interpolated grid: dx=0.5000 mm, dy=0.5000 mm

Device Reference Point: 0, 0, -6.3 mm

Reference Value = 10.28 V/m; Power Drift = 0.04 dB

Applied MIF = -1.49 dB

RF audio interference level = 20.84 dBV/m

Emission category: M4

MIF scaled E-field

| | | |
|--------------------------|--------------------------|--------------------------|
| Grid 1 M4 22.02 dBV/m | Grid 2 M4 20.84 dBV/m | Grid 3 M4 18.99 dBV/m |
| Grid 4 M4 21.96 dBV/m | Grid 5 M4 19.42 dBV/m | Grid 6 M4 16.87 dBV/m |
| Grid 7 M4 20.99 dBV/m | Grid 8 M4 18.3 dBV/m | Grid 9 M4 13.89 dBV/m |

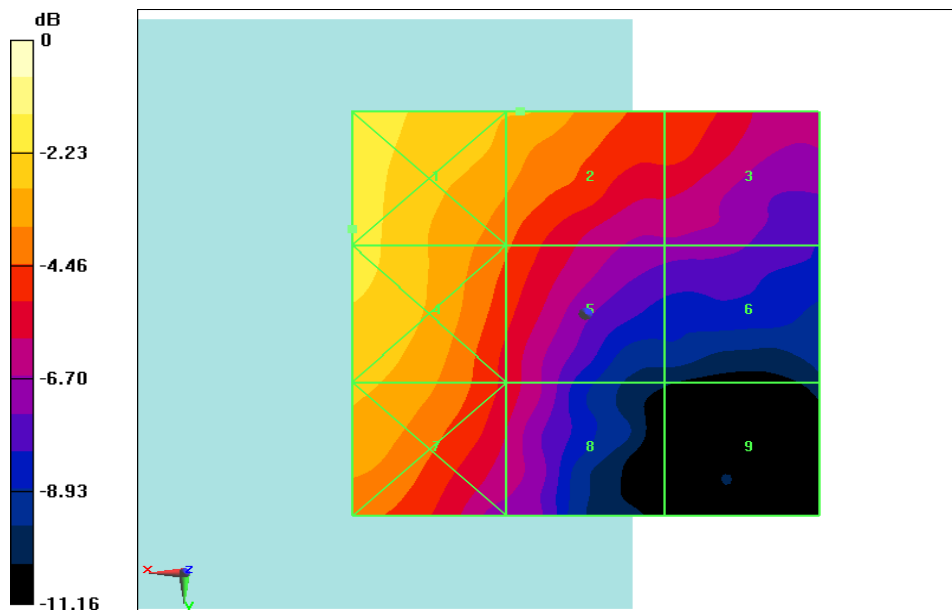

0 dB = 15.39 V/m = 23.74 dBV/m

Fig B.19 HAC RF E-Field LTE Band41 64QAM Middle

HAC RF E-Field LTE Band41 64QAM 2549.5MHz

Date: 2018-4-29

Electronics: DAE4 Sn777

Medium: Air

Medium parameters used: $\sigma = 0$ mho/m, $\epsilon_r = 1$; $\rho = 1000$ kg/m³

Ambient Temperature: 22.0°C

Communication System: LTE Band41; Frequency: 2549.5 MHz; Duty Cycle: 1:1.58

Probe: ER3DV6 - SN2272;ConvF(1, 1, 1)

E Scan - ER3DV6 - 2011: 15 mm from Probe Center to the Device 3 3/Hearing Aid

Compatibility Test (101x101x1): Interpolated grid: dx=0.5000 mm, dy=0.5000 mm

Device Reference Point: 0, 0, -6.3 mm

Reference Value = 10.55 V/m; Power Drift = -0.11 dB

Applied MIF = -1.46 dB

RF audio interference level = 21.20 dBV/m

Emission category: M4

MIF scaled E-field

| | | |
|--------------------------|--------------------------|--------------------------|
| Grid 1 M4 22.26 dBV/m | Grid 2 M4 21.2 dBV/m | Grid 3 M4 19.2 dBV/m |
| Grid 4 M4 22.12 dBV/m | Grid 5 M4 19.67 dBV/m | Grid 6 M4 17.08 dBV/m |
| Grid 7 M4 21.52 dBV/m | Grid 8 M4 18.58 dBV/m | Grid 9 M4 14.63 dBV/m |

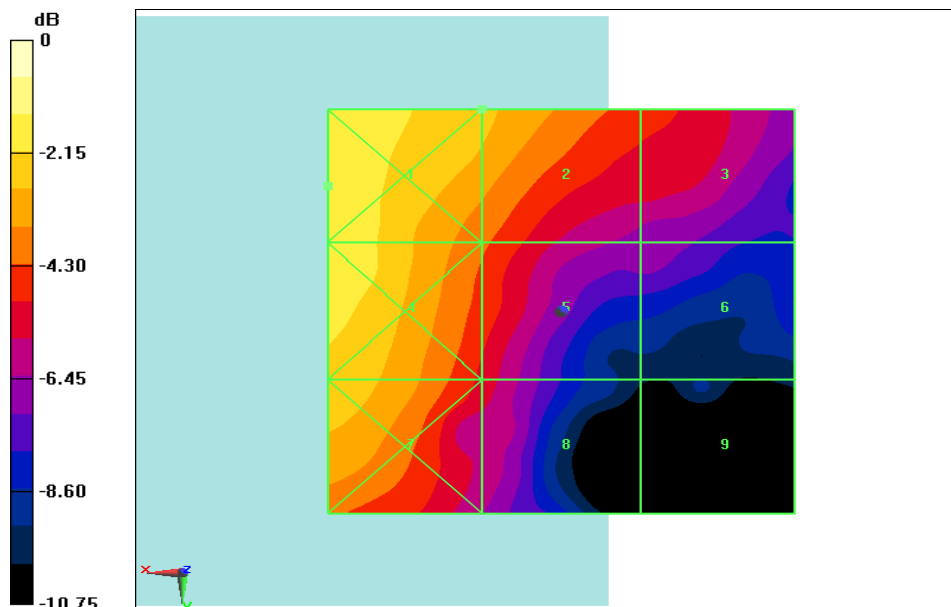

0 dB = 15.47 V/m = 23.79 dBV/m

Fig B.20 HAC RF E-Field LTE Band41 64QAM 2549.5MHz

HAC RF E-Field LTE Band41 64QAM Low

Date: 2018-4-29

Electronics: DAE4 Sn777

Medium: Air

Medium parameters used: $\sigma = 0$ mho/m, $\epsilon_r = 1$; $\rho = 1000$ kg/m³

Ambient Temperature: 22.0°C

Communication System: LTE Band41; Frequency: 2506 MHz; Duty Cycle: 1:1.58

Probe: ER3DV6 - SN2272;ConvF(1, 1, 1)

E Scan - ER3DV6 - 2011: 15 mm from Probe Center to the Device 3 2/Hearing Aid

Compatibility Test (101x101x1): Interpolated grid: dx=0.5000 mm, dy=0.5000 mm

Device Reference Point: 0, 0, -6.3 mm

Reference Value = 10.61 V/m; Power Drift = -0.02 dB

Applied MIF = -1.56 dB

RF audio interference level = 20.97 dBV/m

Emission category: M4

MIF scaled E-field

| | | |
|--------------------------|--------------------------|--------------------------|
| Grid 1 M4 21.96 dBV/m | Grid 2 M4 20.97 dBV/m | Grid 3 M4 18.98 dBV/m |
| Grid 4 M4 21.87 dBV/m | Grid 5 M4 19.36 dBV/m | Grid 6 M4 16.78 dBV/m |
| Grid 7 M4 21.1 dBV/m | Grid 8 M4 18.19 dBV/m | Grid 9 M4 13.81 dBV/m |

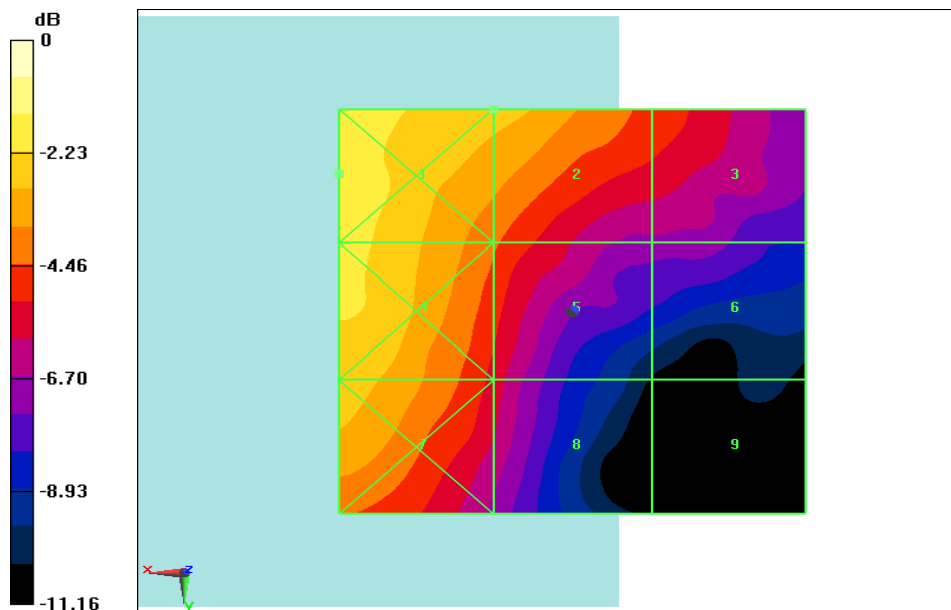

0 dB = 15.24 V/m = 23.66 dBV/m

Fig B.21 HAC RF E-Field LTE Band41 64QAM Low

ANNEX C SYSTEM VALIDATION RESULT

E SCAN of Dipole 835 MHz

Date: 2018-4-29

Electronics: DAE4 Sn777

Medium: Air

Medium parameters used: $\sigma = 0$ mho/m, $\epsilon_r = 1$; $\rho = 1000$ kg/m³

Communication System: CW; Frequency: 835 MHz; Duty Cycle: 1:1

Probe: ER3DV6 - SN2272;ConvF(1, 1, 1)

E Scan - measurement distance from the probe sensor center to CD835 Dipole = 15mm/Hearing Aid Compatibility Test (41x361x1): Interpolated grid: dx=0.5000 mm, dy=0.5000 mm

Device Reference Point: 0, 0, -6.3 mm

Reference Value = 106.9 V/m; Power Drift = -0.01 dB

Applied MIF = 0.00 dB

RF audio interference level = 40.53 dBV/m

Emission category: M3

MIF scaled E-field

| | | |
|--------------------------|--------------------------|--------------------------|
| Grid 1M3 40.39 dBV/m | Grid 2M3 40.51 dBV/m | Grid 3M3 40.33 dBV/m |
| Grid 4 M4 35.93 dBV/m | Grid 5 M4 36.04 dBV/m | Grid 6 M4 35.88 dBV/m |
| Grid 7 M3 40.34 dBV/m | Grid 8 M3 40.53 dBV/m | Grid 9 M3 40.46 dBV/m |

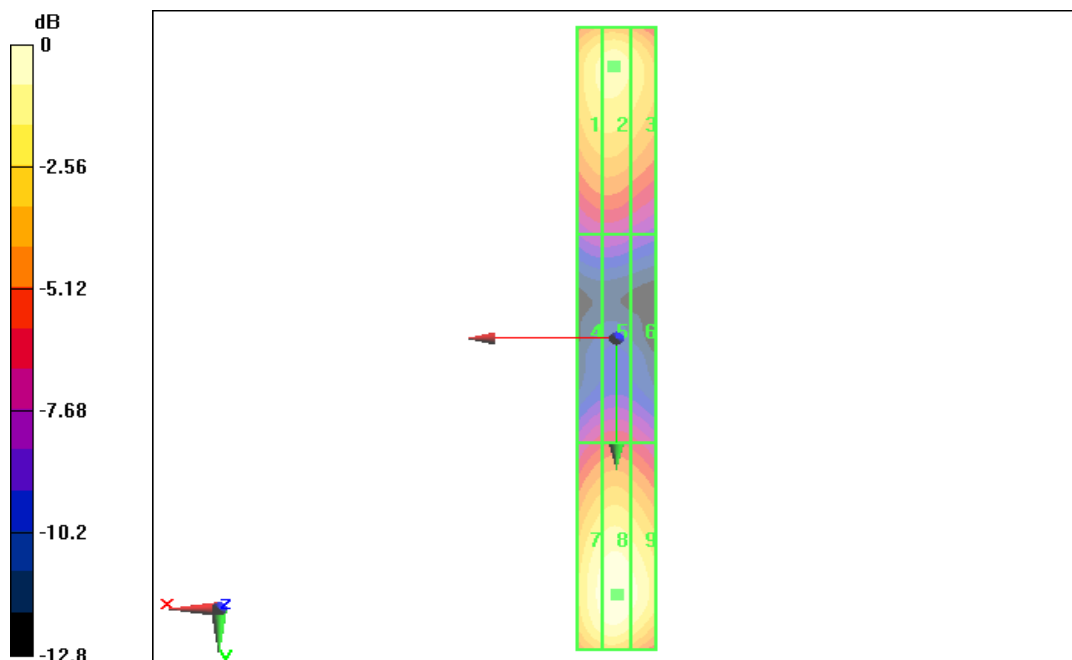

0 dB = 40.53 dBV/m

E SCAN of Dipole 1880 MHz

Date: 2018-4-29

Electronics: DAE4 Sn777

Medium: Air

Medium parameters used: $\sigma = 0$ mho/m, $\epsilon_r = 1$; $\rho = 1000$ kg/m³

Communication System: CW; Frequency: 1880 MHz; Duty Cycle: 1:1

Probe: ER3DV6 - SN2272;ConvF(1, 1, 1)

E Scan - measurement distance from the probe sensor center to CD1880 Dipole = 15mm/Hearing Aid Compatibility Test (41x181x1): Interpolated grid: dx=0.5000 mm, dy=0.5000 mm

Device Reference Point: 0, 0, -6.3 mm

Reference Value = 154.9 V/m; Power Drift = 0.02 dB

Applied MIF = 0.00 dB

RF audio interference level = 39.45 dBV/m

Emission category: M2

MIF scaled E-field

| | | |
|-------------------------|-------------------------|-------------------------|
| Grid 1M2 39.21 dBV/m | Grid 2M2 39.45 dBV/m | Grid 3M2 39.36 dBV/m |
| Grid 4M2 37.22 dBV/m | Grid 5M2 37.36 dBV/m | Grid 6M2 37.26 dBV/m |
| Grid 7M2 38.78 dBV/m | Grid 8M2 39.05dBV/m | Grid 9M2 38.98 dBV/m |

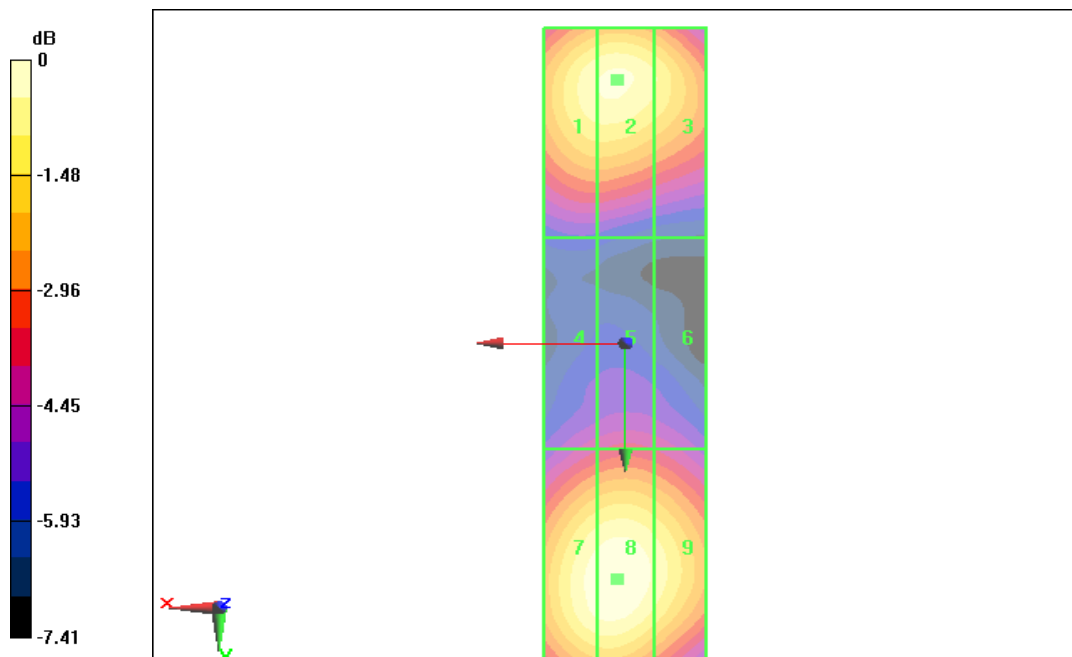

0 dB = 39.45 dBV/m

E SCAN of Dipole 2600 MHz

Date: 2018-4-29

Electronics: DAE4 Sn777

Medium: Air

Medium parameters used: $\sigma = 0$ mho/m, $\epsilon_r = 1$; $\rho = 1000$ kg/m³

Communication System: CW; Frequency: 2600 MHz; Duty Cycle: 1:1

Probe: ER3DV6 - SN2272;ConvF(1, 1, 1)

E Scan - measurement distance from the probe sensor center to CD2600 Dipole = 15mm/Hearing Aid Compatibility Test (41x181x1): Interpolated grid: dx=0.5000 mm, dy=0.5000 mm

Device Reference Point: 0, 0, -6.3 mm

Reference Value = 59.87 V/m; Power Drift = 0.02 dB

Applied MIF = 0.00 dB

RF audio interference level = 38.69 dBV/m

Emission category: M2

MIF scaled E-field

| | | |
|--------------------------------|--------------------------------|--------------------------------|
| Grid 1M2 38.21 dBV/m | Grid 2M2 38.45 dBV/m | Grid 3M2 38.36 dBV/m |
| Grid 4M2 38.22 dBV/m | Grid 5M2 38.36 dBV/m | Grid 6M2 38.69 dBV/m |
| Grid 7M2 38.58 dBV/m | Grid 8M2 38.05dBV/m | Grid 9M2 38.48 dBV/m |

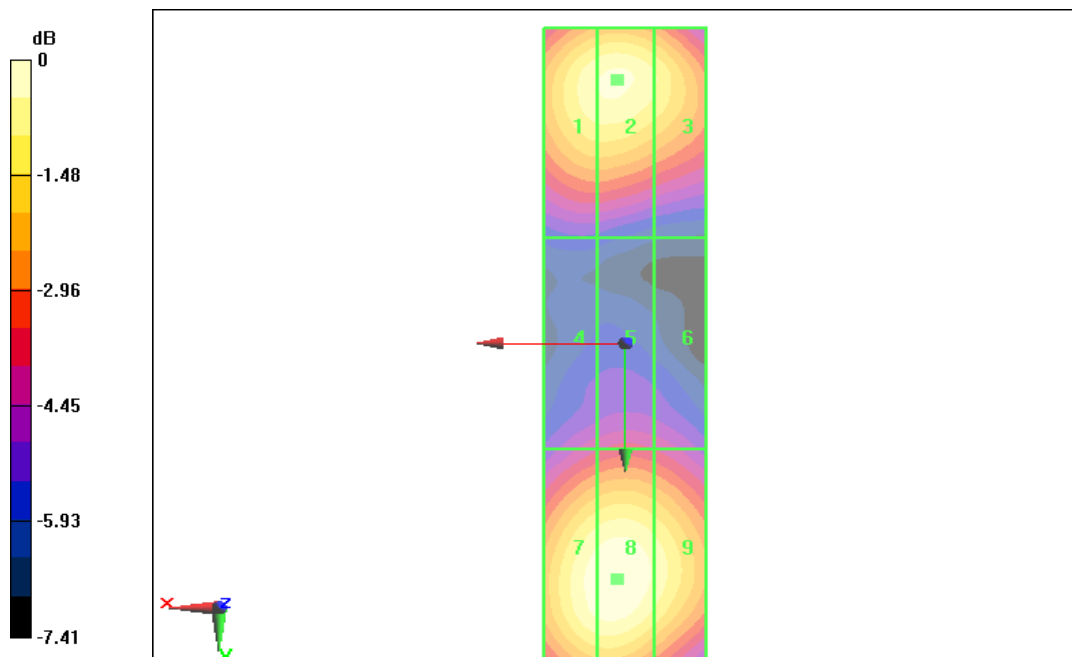

0 dB = 38.69 dBV/m

ANNEX D PROBE CALIBRATION CERTIFICATE

E_Probe ER3DV6

**Calibration Laboratory of
Schmid & Partner
Engineering AG**
Zeughausstrasse 43, 8004 Zurich, Switzerland



S Schweizerischer Kalibrierdienst
C Service suisse d'étalonnage
S Servizio svizzero di taratura
S Swiss Calibration Service

Accredited by the Swiss Accreditation Service (SAS)
The Swiss Accreditation Service is one of the signatories to the EA
Multilateral Agreement for the recognition of calibration certificates

Accreditation No.: **SCS 0108**

Client **CTTL (Auden)**

Certificate No: **ER3-2272_Dec17**

CALIBRATION CERTIFICATE

Object **ER3DV6 - SN:2272**

Calibration procedure(s) **QA CAL-02.v8, QA CAL-25.v6
Calibration procedure for E-field probes optimized for close near field
evaluations in air**



Calibration date: **December 19, 2017**

This calibration certificate documents the traceability to national standards, which realize the physical units of measurements (SI).
The measurements and the uncertainties with confidence probability are given on the following pages and are part of the certificate.

All calibrations have been conducted in the closed laboratory facility: environment temperature (22 ± 3)°C and humidity < 70%.

Calibration Equipment used (M&TE critical for calibration)

| Primary Standards | ID | Cal Date (Certificate No.) | Scheduled Calibration |
|----------------------------|------------------|-----------------------------------|------------------------|
| Power meter NRP | SN: 104778 | 04-Apr-17 (No. 217-02521/02522) | Apr-18 |
| Power sensor NRP-Z91 | SN: 103244 | 04-Apr-17 (No. 217-02521) | Apr-18 |
| Power sensor NRP-Z91 | SN: 103245 | 04-Apr-17 (No. 217-02525) | Apr-18 |
| Reference 20 dB Attenuator | SN: S5277 (20x) | 07-Apr-17 (No. 217-02528) | Apr-18 |
| Reference Probe ER3DV6 | SN: 2328 | 10-Oct-17 (No. ER3-2328_Oct17) | Oct-18 |
| DAE4 | SN: 789 | 2-Aug-17 (No. DAE4-789_Aug17) | Aug-18 |
| Secondary Standards | ID | Check Date (in house) | Scheduled Check |
| Power meter E4419B | SN: GB41293874 | 06-Apr-16 (in house check Jun-16) | In house check: Jun-18 |
| Power sensor E4412A | SN: MY41498087 | 06-Apr-16 (in house check Jun-16) | In house check: Jun-18 |
| Power sensor E4412A | SN: 000110210 | 06-Apr-16 (in house check Jun-16) | In house check: Jun-18 |
| RF generator HP 8648C | SN: US3642U01700 | 04-Aug-99 (in house check Jun-16) | In house check: Jun-18 |
| Network Analyzer HP 8753E | SN: US37390585 | 18-Oct-01 (in house check Oct-17) | In house check: Oct-18 |

| | | | |
|---|-------------------------------|--|--|
| Calibrated by: | Name Jeton Kastrati | Function Laboratory Technician | Signature  |
| Approved by: | Name Katja Pokovic | Function Technical Manager | Signature  |
| | | | Issued: December 20, 2017 |
| This calibration certificate shall not be reproduced except in full without written approval of the laboratory. | | | |

Calibration Laboratory of
Schmid & Partner
Engineering AG
Zeughausstrasse 43, 8004 Zurich, Switzerland



S Schweizerischer Kalibrierdienst
C Service suisse d'étalonnage
S Servizio svizzero di taratura
S Swiss Calibration Service

Accredited by the Swiss Accreditation Service (SAS)
The Swiss Accreditation Service is one of the signatories to the EA
Multilateral Agreement for the recognition of calibration certificates

Accreditation No.: **SCS 0108**

Glossary:

| | |
|--------------------------|---|
| NORM _{x,y,z} | sensitivity in free space |
| DCP | diode compression point |
| CF | crest factor (1/duty_cycle) of the RF signal |
| A, B, C, D | modulation dependent linearization parameters |
| Polarization φ | φ rotation around probe axis |
| Polarization ϑ | ϑ rotation around an axis that is in the plane normal to probe axis (at measurement center), i.e., $\vartheta = 0$ is normal to probe axis |
| Connector Angle | information used in DASY system to align probe sensor X to the robot coordinate system |

Calibration is Performed According to the Following Standards:

- a) IEEE Std 1309-2005, " IEEE Standard for calibration of electromagnetic field sensors and probes, excluding antennas, from 9 kHz to 40 GHz", December 2005
- b) CTIA Test Plan for Hearing Aid Compatibility, Rev 3.0, November 2013

Methods Applied and Interpretation of Parameters:

- **NORM_{x,y,z}**: Assessed for E-field polarization $\vartheta = 0$ for XY sensors and $\vartheta = 90$ for Z sensor ($f \leq 900$ MHz in TEM-cell; $f > 1800$ MHz: R22 waveguide).
- **NORM(f)_{x,y,z} = NORM_{x,y,z} * frequency_response** (see Frequency Response Chart).
- **DCP_{x,y,z}**: DCP are numerical linearization parameters assessed based on the data of power sweep with CW signal (no uncertainty required). DCP does not depend on frequency nor media.
- **PAR**: PAR is the Peak to Average Ratio that is not calibrated but determined based on the signal characteristics
- **A_{x,y,z}; B_{x,y,z}; C_{x,y,z}; D_{x,y,z}; VR_{x,y,z}**: A, B, C, D are numerical linearization parameters assessed based on the data of power sweep for specific modulation signal. The parameters do not depend on frequency nor media. VR is the maximum calibration range expressed in RMS voltage across the diode.
- **Spherical isotropy (3D deviation from isotropy)**: in a locally homogeneous field realized using an open waveguide setup.
- **Sensor Offset**: The sensor offset corresponds to the offset of virtual measurement center from the probe tip (on probe axis). No tolerance required.
- **Connector Angle**: The angle is assessed using the information gained by determining the NORM_x (no uncertainty required).



ER3DV6 – SN:2272

December 19, 2017

Probe ER3DV6

SN:2272

Manufactured: November 29, 2001
Calibrated: December 19, 2017

Calibrated for DASY/EASY Systems
(Note: non-compatible with DASY2 system!)



ER3DV6 – SN:2272

December 19, 2017

DASY/EASY - Parameters of Probe: ER3DV6 - SN:2272

Basic Calibration Parameters

| | Sensor X | Sensor Y | Sensor Z | Unc (k=2) |
|--|----------|----------|----------|--------------|
| Norm ($\mu\text{V}/(\text{V}/\text{m})^2$) | 1.60 | 1.67 | 1.72 | $\pm 10.1\%$ |
| DCP (mV) ^B | 101.0 | 97.8 | 100.7 | |

Modulation Calibration Parameters

| UID | Communication System Name | | A dB | B dB $\sqrt{\mu\text{V}}$ | C | D dB | VR mV | Unc ^E (k=2) |
|-----|---------------------------|---|---------|------------------------------|-----|---------|----------|---------------------------|
| 0 | CW | X | 0.0 | 0.0 | 1.0 | 0.00 | 200.2 | $\pm 3.5\%$ |
| | | Y | 0.0 | 0.0 | 1.0 | | 165.8 | |
| | | Z | 0.0 | 0.0 | 1.0 | | 197.0 | |

Note: For details on UID parameters see Appendix.

Sensor Model Parameters

| | C1 fF | C2 fF | α V^{-1} | T1 $\text{ms}\cdot\text{V}^{-2}$ | T2 $\text{ms}\cdot\text{V}^{-1}$ | T3 ms | T4 V^{-2} | T5 V^{-1} | T6 |
|---|----------|----------|-----------------------------|-------------------------------------|-------------------------------------|----------|-----------------------|-----------------------|-------|
| X | 94.34 | 448.4 | 35.94 | 25.97 | 1.333 | 5.10 | 0.00 | 0.662 | 1.014 |
| Y | 100.1 | 483.8 | 36.93 | 26.47 | 1.401 | 5.10 | 0.00 | 0.669 | 1.019 |
| Z | 83.01 | 396.9 | 36.42 | 29.84 | 3.892 | 5.10 | 0.00 | 0.874 | 1.016 |

The reported uncertainty of measurement is stated as the standard uncertainty of measurement multiplied by the coverage factor $k=2$, which for a normal distribution corresponds to a coverage probability of approximately 95%.

^B Numerical linearization parameter: uncertainty not required.

^E Uncertainty is determined using the max. deviation from linear response applying rectangular distribution and is expressed for the square of the field value.

ER3DV6 – SN:2272

December 19, 2017

Frequency Response of E-Field (TEM-Cell:ifi110 EXX, Waveguide: R22)

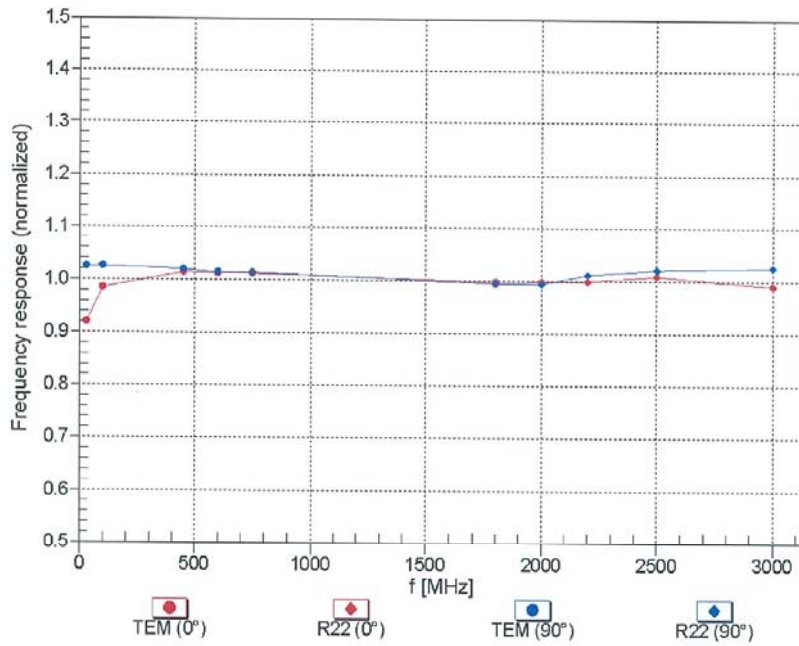

Uncertainty of Frequency Response of E-field: $\pm 6.3\%$ (k=2)

ER3DV6 – SN:2272

December 19, 2017

Receiving Pattern (ϕ), $\vartheta = 0^\circ$

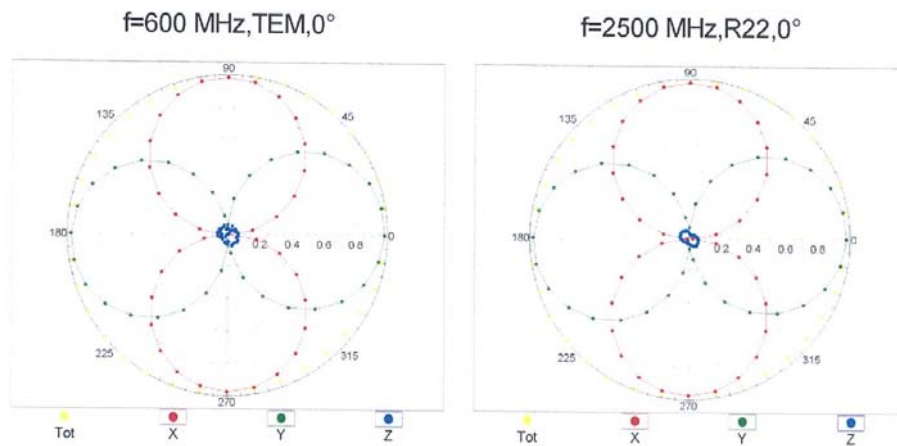

Receiving Pattern (ϕ), $\vartheta = 90^\circ$

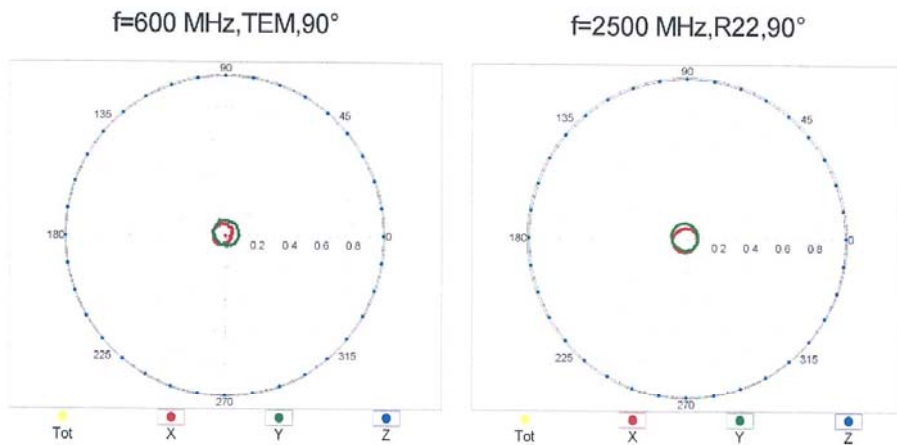

ER3DV6 – SN:2272

December 19, 2017

Receiving Pattern (ϕ), $\vartheta = 0^\circ$

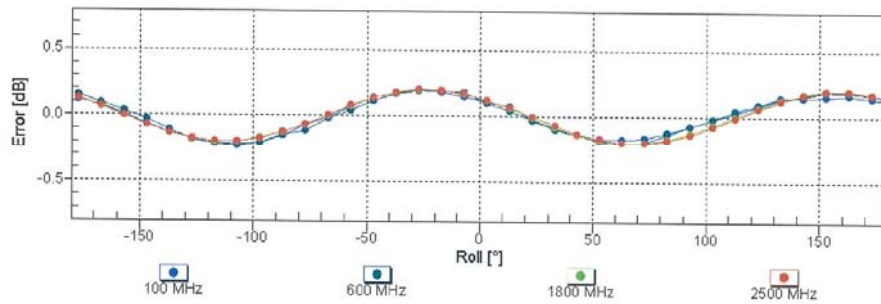

Uncertainty of Axial Isotropy Assessment: $\pm 0.5\%$ ($k=2$)

Receiving Pattern (ϕ), $\vartheta = 90^\circ$

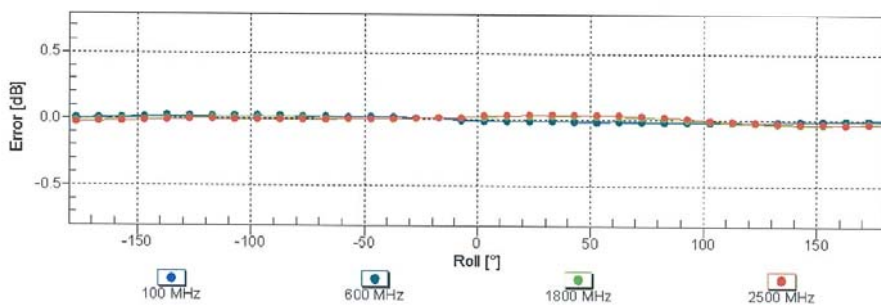

Uncertainty of Axial Isotropy Assessment: $\pm 0.5\%$ ($k=2$)

ER3DV6 – SN:2272

December 19, 2017

Dynamic Range f(E-field) (TEM cell , f = 900 MHz)

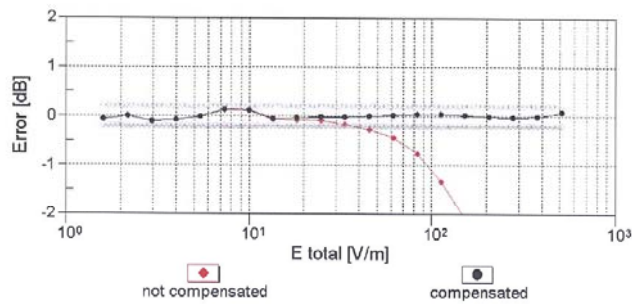
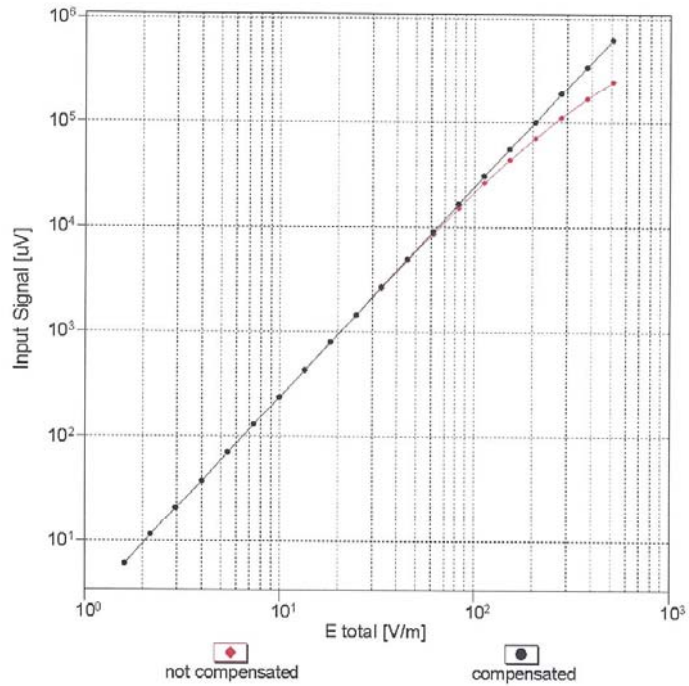

Uncertainty of Linearity Assessment: $\pm 0.6\%$ (k=2)

ER3DV6 – SN:2272

December 19, 2017

Deviation from Isotropy in Air Error (ϕ, θ), $f = 900$ MHz

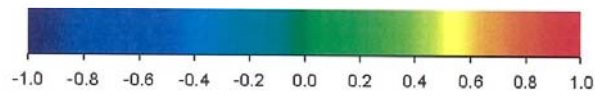
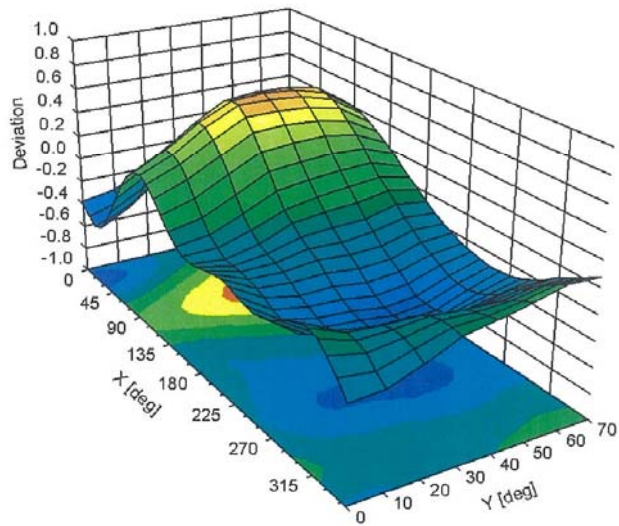

Uncertainty of Spherical Isotropy Assessment: $\pm 2.6\%$ ($k=2$)



ER3DV6 – SN:2272

December 19, 2017

DASY/EASY - Parameters of Probe: ER3DV6 - SN:2272

Other Probe Parameters

| | |
|---|-------------|
| Sensor Arrangement | Rectangular |
| Connector Angle (°) | 112.9 |
| Mechanical Surface Detection Mode | enabled |
| Optical Surface Detection Mode | disabled |
| Probe Overall Length | 337 mm |
| Probe Body Diameter | 10 mm |
| Tip Length | 10 mm |
| Tip Diameter | 8 mm |
| Probe Tip to Sensor X Calibration Point | 2.5 mm |
| Probe Tip to Sensor Y Calibration Point | 2.5 mm |
| Probe Tip to Sensor Z Calibration Point | 2.5 mm |

ANNEX E DIPOLE CALIBRATION CERTIFICATE

Dipole 835 MHz

**Calibration Laboratory of
Schmid & Partner
Engineering AG**
Zeughausstrasse 43, 8004 Zurich, Switzerland



S Schweizerischer Kalibrierdienst
S Service suisse d'étalonnage
S Servizio svizzero di taratura
S Swiss Calibration Service

Accredited by the Swiss Accreditation Service (SAS)
The Swiss Accreditation Service is one of the signatories to the EA
Multilateral Agreement for the recognition of calibration certificates

Accreditation No.: **SCS 0108**

Client **CTTL (Auden)**

Certificate No: **CD835V3-1023_Aug17**

CALIBRATION CERTIFICATE

Object **CD835V3 - SN: 1023**

Calibration procedure(s) **QA CAL-20.v6
Calibration procedure for dipoles in air**

Calibration date: **August 23, 2017**



This calibration certificate documents the traceability to national standards, which realize the physical units of measurements (SI).
The measurements and the uncertainties with confidence probability are given on the following pages and are part of the certificate.

All calibrations have been conducted in the closed laboratory facility: environment temperature (22 ± 3)°C and humidity < 70%.

Calibration Equipment used (M&TE critical for calibration)

| Primary Standards | ID # | Cal Date (Certificate No.) | Scheduled Calibration |
|-----------------------------|--------------------|---------------------------------|-----------------------|
| Power meter NRP | SN: 104778 | 04-Apr-17 (No. 217-02521/02522) | Apr-18 |
| Power sensor NRP-Z91 | SN: 103244 | 04-Apr-17 (No. 217-02521) | Apr-18 |
| Power sensor NRP-Z91 | SN: 103245 | 04-Apr-17 (No. 217-02522) | Apr-18 |
| Reference 20 dB Attenuator | SN: 5058 (20k) | 07-Apr-17 (No. 217-02528) | Apr-18 |
| Type-N mismatch combination | SN: 5047.2 / 06327 | 07-Apr-17 (No. 217-02529) | Apr-18 |
| Probe ER3DV6 | SN: 2336 | 30-Dec-16 (No. ER3-2336_Dec16) | Dec-17 |
| Probe H3DV6 | SN: 6065 | 30-Dec-16 (No. H3-6065_Dec16) | Dec-17 |
| DAE4 | SN: 781 | 13-Jul-17 (No. DAE4-781_Jul17) | Jul-18 |

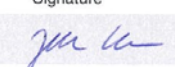
| Secondary Standards | ID # | Check Date (in house) | Scheduled Check |
|---------------------------|----------------|-----------------------------------|------------------------|
| Power meter Agilent 4419B | SN: GB42420191 | 09-Oct-09 (in house check Sep-14) | In house check: Oct-17 |
| Power sensor HP E4412A | SN: US38485102 | 05-Jan-10 (in house check Sep-14) | In house check: Oct-17 |
| Power sensor HP 8482A | SN: US37295597 | 09-Oct-09 (in house check Sep-14) | In house check: Oct-17 |
| RF generator R&S SMT-06 | SN: 832283/011 | 27-Aug-12 (in house check Oct-15) | In house check: Oct-17 |
| Network Analyzer HP 8753E | SN: US37390585 | 18-Oct-01 (in house check Oct-16) | In house check: Oct-17 |

| | Name | Function | Signature |
|----------------|------------------|-----------------------|---|
| Calibrated by: | Johannes Kurikka | Laboratory Technician |  |
| Approved by: | Katja Pokovic | Technical Manager |  |

Issued: August 23, 2017

This calibration certificate shall not be reproduced except in full without written approval of the laboratory.

Calibration Laboratory of
Schmid & Partner
Engineering AG
Zeughausstrasse 43, 8004 Zurich, Switzerland



S Schweizerischer Kalibrierdienst
S Service suisse d'étalonnage
S Servizio svizzero di taratura
S Swiss Calibration Service

Accredited by the Swiss Accreditation Service (SAS)
The Swiss Accreditation Service is one of the signatories to the EA
Multilateral Agreement for the recognition of calibration certificates

Accreditation No.: **SCS 0108**

References

- [1] ANSI-C63.19-2007
American National Standard for Methods of Measurement of Compatibility between Wireless Communications Devices and Hearing Aids.
- [2] ANSI-C63.19-2011
American National Standard, Methods of Measurement of Compatibility between Wireless Communications Devices and Hearing Aids.

Methods Applied and Interpretation of Parameters:

- **Coordinate System:** y-axis is in the direction of the dipole arms. z-axis is from the basis of the antenna (mounted on the table) towards its feed point between the two dipole arms. x-axis is normal to the other axes. In coincidence with the standards [1], the measurement planes (probe sensor center) are selected to be at a distance of 10 mm (15 mm for [2]) above the top metal edge of the dipole arms.
- **Measurement Conditions:** Further details are available from the hardcopies at the end of the certificate. All figures stated in the certificate are valid at the frequency indicated. The forward power to the dipole connector is set with a calibrated power meter connected and monitored with an auxiliary power meter connected to a directional coupler. While the dipole under test is connected, the forward power is adjusted to the same level.
- **Antenna Positioning:** The dipole is mounted on a HAC Test Arch phantom using the matching dipole positioner with the arms horizontal and the feeding cable coming from the floor. The measurements are performed in a shielded room with absorbers around the setup to reduce the reflections. It is verified before the mounting of the dipole under the Test Arch phantom, that its arms are perfectly in a line. It is installed on the HAC dipole positioner with its arms parallel below the dielectric reference wire and able to move elastically in vertical direction without changing its relative position to the top center of the Test Arch phantom. The vertical distance to the probe is adjusted after dipole mounting with a DASY5 Surface Check job. Before the measurement, the distance between phantom surface and probe tip is verified. The proper measurement distance is selected by choosing the matching section of the HAC Test Arch phantom with the proper device reference point (upper surface of the dipole) and the matching grid reference point (tip of the probe) considering the probe sensor offset. The vertical distance to the probe is essential for the accuracy.
- **Feed Point Impedance and Return Loss:** These parameters are measured using a HP 8753E Vector Network Analyzer. The impedance is specified at the SMA connector of the dipole. The influence of reflections was eliminated by applying the averaging function while moving the dipole in the air, at least 70cm away from any obstacles.
- **E-field distribution:** E field is measured in the x-y-plane with an isotropic ER3D-field probe with 100 mW forward power to the antenna feed point. In accordance with [1] and [2], the scan area is 20mm wide, its length exceeds the dipole arm length (180 or 90mm). The sensor center is 10 mm (15 mm for [2]) (in z) above the metal top of the dipole arms. Two 3D maxima are available near the end of the dipole arms. Assuming the dipole arms are perfectly in one line, the average of these two maxima (in subgrid 2 and subgrid 8) is determined to compensate for any non-parallelity to the measurement plane as well as the sensor displacement. The E-field value stated as calibration value represents the maximum of the interpolated 3D-E-field, in the plane above the dipole surface.
- **H-field distribution:** H-field is measured with an isotropic H-field probe with 100mW forward power to the antenna feed point, in the x-y-plane. The scan area and sensor distance is equivalent to the E-field scan. The maximum of the field is available at the center (subgrid 5) above the feed point. The H-field value stated as calibration value represents the maximum of the interpolated H-field, 10mm above the dipole surface at the feed point.

The reported uncertainty of measurement is stated as the standard uncertainty of measurement multiplied by the coverage factor $k=2$, which for a normal distribution corresponds to a coverage probability of approximately 95%.

Measurement Conditions

DASY system configuration, as far as not given on page 1.

| | | |
|---|---------------------|----------|
| DASY Version | DASY5 | V52.10.0 |
| Phantom | HAC Test Arch | |
| Distance Dipole Top - Probe Center | 10, 15 mm | |
| Scan resolution | dx, dy = 5 mm | |
| Frequency | 835 MHz \pm 1 MHz | |
| Input power drift | < 0.05 dB | |

Maximum Field values at 835 MHz

| H-field 10 mm above dipole surface | condition | interpolated maximum |
|---|--------------------|---|
| Maximum measured | 100 mW input power | 0.457 A/m \pm 8.2 % (k=2) |

| E-field 10 mm above dipole surface | condition | Interpolated maximum |
|---|--------------------|--|
| Maximum measured above high end | 100 mW input power | 168.6 V/m = 44.54 dBV/m |
| Maximum measured above low end | 100 mW input power | 165.9 V/m = 44.40 dBV/m |
| Averaged maximum above arm | 100 mW input power | 167.3 V/m \pm 12.8 % (k=2) |

| E-field 15 mm above dipole surface | condition | Interpolated maximum |
|---|--------------------|--|
| Maximum measured above high end | 100 mW input power | 108.0 V/m = 40.67 dBV/m |
| Maximum measured above low end | 100 mW input power | 107.9 V/m = 40.66 dBV/m |
| Averaged maximum above arm | 100 mW input power | 108.0 V/m \pm 12.8 % (k=2) |

Appendix (Additional assessments outside the scope of SCS 0108)

Antenna Parameters

| Frequency | Return Loss | Impedance |
|-----------|-------------|---------------------------------|
| 800 MHz | 16.8 dB | 41.0 Ω - 9.7 j Ω |
| 835 MHz | 23.2 dB | 53.2 Ω + 6.4 j Ω |
| 900 MHz | 15.7 dB | 52.8 Ω - 16.9 j Ω |
| 950 MHz | 23.1 dB | 48.9 Ω + 6.9 j Ω |
| 960 MHz | 16.9 dB | 58.6 Ω + 13.1 j Ω |

3.2 Antenna Design and Handling

The calibration dipole has a symmetric geometry with a built-in two stub matching network, which leads to the enhanced bandwidth.

The dipole is built of standard semirigid coaxial cable. The internal matching line is open ended. The antenna is therefore open for DC signals.

Do not apply force to dipole arms, as they are liable to bend. The soldered connections near the feedpoint may be damaged. After excessive mechanical stress or overheating, check the impedance characteristics to ensure that the internal matching network is not affected.

After long term use with 40W radiated power, only a slight warming of the dipole near the feedpoint can be measured.

Impedance Measurement Plot

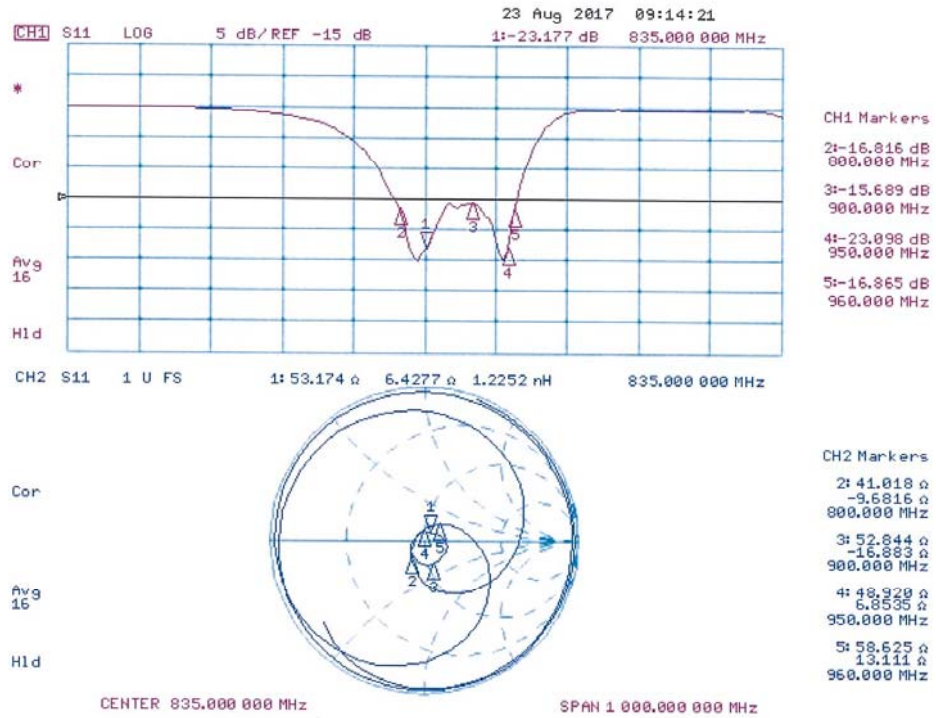

DASY5 H-field Result

Test Laboratory: SPEAG Lab2

Date: 22.08.2017

DUT: HAC-Dipole 835 MHz; Type: CD835V3; Serial: CD835V3 - SN: 1023

Communication System: UID 0 - CW ; Frequency: 835 MHz
 Medium parameters used: $\sigma = 0$ S/m, $\epsilon_r = 1$; $\rho = 1$ kg/m³
 Phantom section: RF Section
 Measurement Standard: DASY5 (IEEE/IEC/ANSI C63.19-2011)

DASY52 Configuration:

- Probe: H3DV6 - SN6065; ; Calibrated: 30.12.2016
- Sensor-Surface: (Fix Surface)
- Electronics: DAE4 Sn781; Calibrated: 13.07.2017
- Phantom: HAC Test Arch with AMCC; Type: SD HAC P01 BA; Serial: 1070
- DASY52 52.10.0(1446); SEMCAD X 14.6.10(7417)

Dipole H-Field measurement @ 835MHz/H-Scan - 835MHz d=10mm/Hearing Aid Compatibility Test (41x361x1): Interpolated grid: dx=0.5000 mm, dy=0.5000 mm

Device Reference Point: 0, 0, -6.3 mm
 Reference Value = 0.4830 A/m; Power Drift = 0.04 dB
 PMR not calibrated. PMF = 1.000 is applied.
 H-field emissions = 0.4568 A/m
Near-field category: M4 (AWF 0 dB)

PMF scaled H-field

| | | |
|------------------------|------------------------|------------------------|
| Grid 1 M4 0.368 A/m | Grid 2 M4 0.405 A/m | Grid 3 M4 0.392 A/m |
| Grid 4 M4 0.416 A/m | Grid 5 M4 0.457 A/m | Grid 6 M4 0.446 A/m |
| Grid 7 M4 0.373 A/m | Grid 8 M4 0.409 A/m | Grid 9 M4 0.398 A/m |

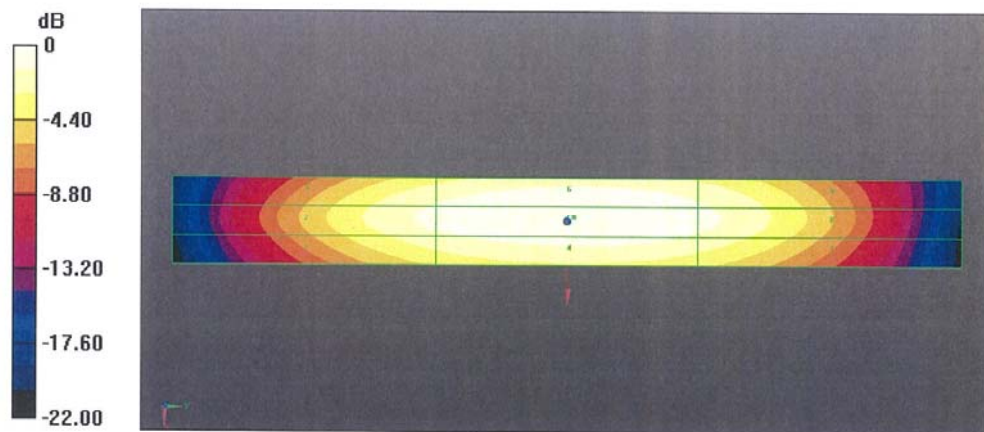

DASY5 E-field Result

Date: 22.08.2017

Test Laboratory: SPEAG Lab2

DUT: HAC-Dipole 835 MHz; Type: CD835V3; Serial: CD835V3 - SN: 1023

Communication System: UID 0 - CW ; Frequency: 835 MHz
 Medium parameters used: $\sigma = 0$ S/m, $\epsilon_r = 1$; $\rho = 1000$ kg/m³
 Phantom section: RF Section
 Measurement Standard: DASY5 (IEEE/IEC/ANSI C63.19-2011)

DASY52 Configuration:

- Probe: ER3DV6 - SN2336; ConvF(1, 1, 1); Calibrated: 30.12.2016;
- Sensor-Surface: (Fix Surface)
- Electronics: DAE4 Sn781; Calibrated: 13.07.2017
- Phantom: HAC Test Arch with AMCC; Type: SD HAC P01 BA; Serial: 1070
- DASY52 52.10.0(1446); SEMCAD X 14.6.10(7417)

Dipole E-Field measurement @ 835MHz/E-Scan - 835MHz d=10mm/Hearing Aid Compatibility Test

(41x361x1): Interpolated grid: dx=0.5000 mm, dy=0.5000 mm

Device Reference Point: 0, 0, -6.3 mm

Reference Value = 108.5 V/m; Power Drift = -0.03 dB

Applied MIF = 0.00 dB

RF audio interference level = 44.54 dBV/m

Emission category: M3

MIF scaled E-field

| | | |
|--------------------------|--------------------------|--------------------------|
| Grid 1 M3 44.17 dBV/m | Grid 2 M3 44.4 dBV/m | Grid 3 M3 44.08 dBV/m |
| Grid 4 M4 38.83 dBV/m | Grid 5 M4 39.1 dBV/m | Grid 6 M4 38.86 dBV/m |
| Grid 7 M3 44.02 dBV/m | Grid 8 M3 44.54 dBV/m | Grid 9 M3 44.45 dBV/m |

Dipole E-Field measurement @ 835MHz/E-Scan - 835MHz d=15mm/Hearing Aid Compatibility Test

(41x361x1): Interpolated grid: dx=0.5000 mm, dy=0.5000 mm

Device Reference Point: 0, 0, -6.3 mm

Reference Value = 108.0 V/m; Power Drift = 0.01 dB

Applied MIF = 0.00 dB

RF audio interference level = 40.67 dBV/m

Emission category: M3

MIF scaled E-field

| | | |
|--------------------------|--------------------------|--------------------------|
| Grid 1 M3 40.52 dBV/m | Grid 2 M3 40.66 dBV/m | Grid 3 M3 40.47 dBV/m |
| Grid 4 M4 36.06 dBV/m | Grid 5 M4 36.18 dBV/m | Grid 6 M4 36.03 dBV/m |
| Grid 7 M3 40.48 dBV/m | Grid 8 M3 40.67 dBV/m | Grid 9 M3 40.6 dBV/m |

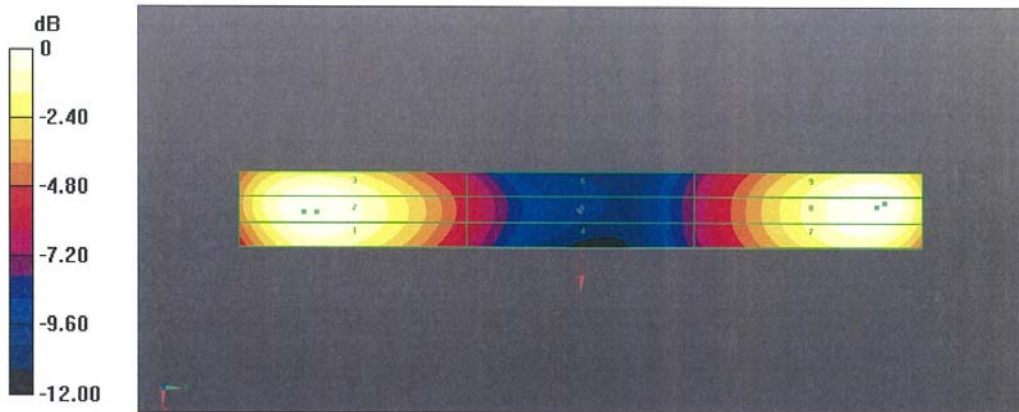

0 dB = 168.6 V/m = 44.54 dBV/m