



SAR TEST REPORT

No. I17Z62134-SEM01

For

TCL Communication Ltd.

HSUPA/HSDPA/UMTS Tri Band/GSM Quad Band/LTE 6 Bands mobile phone

Model name: A405DL

With

Hardware Version: 01

Software Version: WU15

FCC ID: 2ACCJN023

Issued Date: 2017-12-21



Note:

The test results in this test report relate only to the devices specified in this report. This report shall not be reproduced except in full without the written approval of CTTL.

The report must not be used by the client to claim product certification, approval, or endorsement by NVLAP, NIST, or any agency of the U.S. Government.

Test Laboratory:

CTTL, Telecommunication Technology Labs, CAICT

No. 51, Xueyuan Road, Haidian District, Beijing, P. R. China 100191.

Tel:+86(0)10-62304633-2512, Fax:+86(0)10-62304633-2504

Email: ctl_terminals@caict.ac.cn, website: www.caict.ac.cn



REPORT HISTORY

Report Number	Revision	Issue Date	Description
I17Z62134-SEM01	Rev.0	2017-12-21	Initial creation of test report

TABLE OF CONTENT

1 TEST LABORATORY	5
1.1 TESTING LOCATION	5
1.2 TESTING ENVIRONMENT.....	5
1.3 PROJECT DATA	5
1.4 SIGNATURE.....	5
2 STATEMENT OF COMPLIANCE	6
3 CLIENT INFORMATION	8
3.1 APPLICANT INFORMATION	8
3.2 MANUFACTURER INFORMATION	8
4 EQUIPMENT UNDER TEST (EUT) AND ANCILLARY EQUIPMENT (AE).....	9
4.1 ABOUT EUT	9
4.2 INTERNAL IDENTIFICATION OF EUT USED DURING THE TEST	9
4.3 INTERNAL IDENTIFICATION OF AE USED DURING THE TEST	9
5 TEST METHODOLOGY	10
5.1 APPLICABLE LIMIT REGULATIONS	10
5.2 APPLICABLE MEASUREMENT STANDARDS.....	10
6 SPECIFIC ABSORPTION RATE (SAR).....	11
6.1 INTRODUCTION.....	11
6.2 SAR DEFINITION.....	11
7 TISSUE SIMULATING LIQUIDS	12
7.1 TARGETS FOR TISSUE SIMULATING LIQUID	12
7.2 DIELECTRIC PERFORMANCE	12
8 SYSTEM VERIFICATION	18
8.1 SYSTEM SETUP.....	18
8.2 SYSTEM VERIFICATION.....	19
9 MEASUREMENT PROCEDURES	20
9.1 TESTS TO BE PERFORMED	20
9.2 GENERAL MEASUREMENT PROCEDURE.....	22
9.3 WCDMA MEASUREMENT PROCEDURES FOR SAR	23
9.4 SAR MEASUREMENT FOR LTE.....	24
9.5 BLUETOOTH & WI-FI MEASUREMENT PROCEDURES FOR SAR	24
9.6 POWER DRIFT.....	25
10 AREA SCAN BASED 1-G SAR.....	25
10.1 REQUIREMENT OF KDB.....	25
10.2 FAST SAR ALGORITHMS	25
11 CONDUCTED OUTPUT POWER.....	26



11.1 GSM MEASUREMENT RESULT	26
11.2 WCDMA MEASUREMENT RESULT.....	27
11.3 LTE MEASUREMENT RESULT	28
11.4 WI-FI AND BT MEASUREMENT RESULT	39
12 SIMULTANEOUS TX SAR CONSIDERATIONS.....	40
12.1 INTRODUCTION.....	40
12.2 TRANSMIT ANTENNA SEPARATION DISTANCES	40
12.3 STANDALONE SAR TEST EXCLUSION CONSIDERATIONS	41
13 EVALUATION OF SIMULTANEOUS.....	42
14 SAR TEST RESULT	43
14.1 SAR RESULTS FOR FAST SAR.....	44
14.2 SAR RESULTS FOR STANDARD PROCEDURE	51
14.3 WLAN EVALUATION FOR 2.4G	55
15 SAR MEASUREMENT VARIABILITY.....	58
16 MEASUREMENT UNCERTAINTY	59
16.1 MEASUREMENT UNCERTAINTY FOR NORMAL SAR TESTS (300MHZ~3GHZ)	59
16.2 MEASUREMENT UNCERTAINTY FOR NORMAL SAR TESTS (3~6GHZ)	60
16.3 MEASUREMENT UNCERTAINTY FOR FAST SAR TESTS (300MHZ~3GHZ)	61
16.4 MEASUREMENT UNCERTAINTY FOR FAST SAR TESTS (3~6GHZ).....	62
17 MAIN TEST INSTRUMENTS.....	63
ANNEX A GRAPH RESULTS.....	64
ANNEX B SYSTEM VERIFICATION RESULTS	94
ANNEX C SAR MEASUREMENT SETUP	106
ANNEX D POSITION OF THE WIRELESS DEVICE IN RELATION TO THE PHANTOM	112
ANNEX E EQUIVALENT MEDIA RECIPES.....	115
ANNEX F SYSTEM VALIDATION	116
ANNEX G PROBE CALIBRATION CERTIFICATE.....	117
ANNEX H DIPOLE CALIBRATION CERTIFICATE	128
ANNEX I ACCREDITATION CERTIFICATE.....	169

1 Test Laboratory

1.1 Testing Location

Company Name:	CTTL(Shouxiang)
Address:	No. 51 Shouxiang Science Building, Xueyuan Road, Haidian District, Beijing, P. R. China100191

1.2 Testing Environment

Temperature:	18°C~25°C,
Relative humidity:	30%~ 70%
Ground system resistance:	< 0.5 Ω
Ambient noise & Reflection:	< 0.012 W/kg

1.3 Project Data

Project Leader:	Qi Dianyuan
Test Engineer:	Lin Xiaojun
Testing Start Date:	December 10, 2017
Testing End Date:	December 14, 2017

1.4 Signature



Lin Xiaojun
(Prepared this test report)

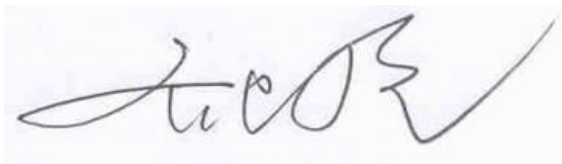

Qi Dianyuan
(Reviewed this test report)

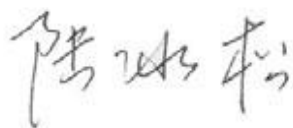

Lu Bingsong
Deputy Director of the laboratory
(Approved this test report)

2 Statement of Compliance

The maximum results of SAR found during testing for TCL Communication Ltd. HSUPA/HSDPA/UMTS Tri Band/GSM Quad Band/LTE 6 Bands mobile phone A405DL are as follows:

Table 2.1: Highest Reported SAR (1g)

Exposure Configuration	Technology Band	Highest Reported SAR 1g(W/kg)	Equipment Class
Head (Separation Distance 0mm)	GSM 850	1.08	PCE
	PCS 1900	0.66	
	UMTS FDD 5	0.62	
	UMTS FDD 4	0.38	
	UMTS FDD 2	0.83	
	LTE Band 2	0.27	
	LTE Band 5	0.61	
	LTE Band 12	0.27	
	LTE Band 13	0.61	
	LTE Band 66	0.40	
	WLAN 2.4 GHz	0.30	
Body-worn (Separation Distance 15mm)	GSM 850	0.89	PCE
	PCS 1900	0.45	
	UMTS FDD 5	0.53	
	UMTS FDD 4	1.21	
	UMTS FDD 2	0.68	
	LTE Band 2	0.65	
	LTE Band 5	0.58	
	LTE Band 12	0.35	
	LTE Band 13	0.39	
	LTE Band 66	0.78	
	WLAN 2.4 GHz	0.10	

The SAR values found for the Mobile Phone are below the maximum recommended levels of 1.6 W/Kg as averaged over any 1g tissue.

For body operation, this device has been tested and meets FCC RF exposure guidelines when used with any accessory that contains no metal and which provides a minimum separation distance of 15 mm for body worn between this device and the body of the user. Use of other accessories may not ensure compliance with FCC RF exposure guidelines.

The EUT battery must be fully charged and checked periodically during the test to ascertain uniform power output.

The measurement together with the test system set-up is described in annex C of this test report. A detailed description of the equipment under test can be found in chapter 4 of this test report. The highest reported SAR value is obtained at the case of **(Table 2.1)**, and the values are: **1.21 W/kg(1g)**.

Table 2.2: The sum of reported SAR values for main antenna and WiFi

	Position	Main antenna	WiFi	Sum
Highest reported SAR value for Head	Right hand, Touch cheek	1.08	0.30	1.38
Highest reported SAR value for Body	Rear fold	1.21	0.06	1.27
	Rear unfold	0.76	0.10	0.86

Table 2.3: The sum of reported SAR values for main antenna and BT

	Position	Main antenna	BT	Sum
Maximum reported SAR value for Head	Right hand, Touch cheek	1.08	0.40 ^[1]	1.48
Maximum reported SAR value for Body	Rear fold	1.21	0.20 ^[1]	1.41

[1] - Estimated SAR for Bluetooth (see the table 13.3)

According to the above tables, the highest sum of reported SAR values is **1.48 W/kg (1g)**. The detail for simultaneous transmission consideration is described in chapter 13.



3 Client Information

3.1 Applicant Information

Company Name:	TCL Communication Ltd.
Address/Post:	5F, C building, No. 232, Liang Jing Road ZhangJiang High-Tech Park, Pudong Area Shanghai, P.R. China. 201203
City:	Shanghai
Country:	China
Contact Person:	Gong Zhizhou
E-mail:	zhizhou.gong@tcl.com
Telephone:	0086-21-31363544
Fax:	0086-21-61460602

3.2 Manufacturer Information

Company Name:	TCL Communication Ltd.
Address/Post:	5F, C building, No. 232, Liang Jing Road ZhangJiang High-Tech Park, Pudong Area Shanghai, P.R. China. 201203
City:	Shanghai
Country:	China
Contact Person:	Gong Zhizhou
E-mail:	zhizhou.gong@tcl.com
Telephone:	0086-21-31363544
Fax:	0086-21-61460602

4 Equipment Under Test (EUT) and Ancillary Equipment (AE)

4.1 About EUT

Description:	HSUPA/HSDPA/UMTS Tri Band/GSM Quad Band/LTE 6 Bands mobile phone
Model name:	A405DL
Operating mode(s):	GSM 850/900/1800/1900, UMTS FDD 2/4/5, BT, Wi-Fi LTE Band 2/4/5/12/13/66
Tested Tx Frequency:	825 – 848.8 MHz (GSM 850)
	1850.2 – 1910 MHz (GSM 1900)
	826.4–846.6 MHz (WCDMA 850 Band V)
	1712.4 – 1752.6 MHz (WCDMA 1700 Band IV)
	1852.4–1907.6 MHz (WCDMA1900 Band II)
	1860 – 1900 MHz (LTE Band 2)
	824.7 – 848.3 MHz (LTE Band 5)
	699.7 – 715.3 MHz (LTE Band 12)
	779.5 –784.5 MHz (LTE Band 13)
	1710.7 –1779.3 MHz (LTE Band 66)
2412 – 2462 MHz (Wi-Fi 2.4G)	
GPRS/EGPRS Multislot Class:	12
GPRS capability Class:	B
Test device Production information:	Production unit
Device type:	Portable device
Antenna type:	Integrated antenna
Hotspot mode:	Not Support

4.2 Internal Identification of EUT used during the test

EUT ID*	IMEI	HW	SW Version
EUT1	015114000001786	01	WU15
EUT2	015114000001695	01	WU15
EUT3	015114000002016	01	WU15
EUT4	015114000101065	01	WU15
EUT5	015114000001026	01	WU15
EUT6	015114000101115	01	WU15

*EUT ID: is used to identify the test sample in the lab internally.

Note: It is performed to test SAR with the EUT1&2&3&4 and conducted power with the EUT5&6.

4.3 Internal Identification of AE used during the test

AE ID*	Description	Model	SN	Manufacturer
AE1	Battery	TLi013C1	/	BYD

*AE ID: is used to identify the test sample in the lab internally.



5 TEST METHODOLOGY

5.1 Applicable Limit Regulations

ANSI C95.1–1992:IEEE Standard for Safety Levels with Respect to Human Exposure to Radio Frequency Electromagnetic Fields, 3 kHz to 300 GHz.

It specifies the maximum exposure limit of **1.6 W/kg** as averaged over any 1 gram of tissue for portable devices being used within 20 cm of the user in the uncontrolled environment.

5.2 Applicable Measurement Standards

IEEE 1528–2013: Recommended Practice for Determining the Peak Spatial-Average Specific Absorption Rate (SAR) in the Human Head from Wireless Communications Devices: Measurement Techniques.

KDB447498 D01: General RF Exposure Guidance v06: Mobile and Portable Devices RF Exposure Procedures and Equipment Authorization Policies.

KDB648474 D04 Handset SAR v01r03: SAR Evaluation Considerations for Wireless Handsets.

KDB941225 D01 SAR test for 3G devices v03r01: SAR Measurement Procedures for 3G Devices

KDB941225 D05 SAR for LTE Devices v02r05: SAR Evaluation Considerations for LTE Devices

KDB248227 D01 802.11 Wi-Fi SAR v02r02: SAR GUIDANCE FOR IEEE 802.11 (Wi-Fi) TRANSMITTERS

KDB865664 D01 SAR measurement 100 MHz to 6 GHz v01r04: SAR Measurement Requirements for 100 MHz to 6 GHz.

KDB865664 D02 RF Exposure Reporting v01r02: RF Exposure Compliance Reporting and Documentation Considerations

6 Specific Absorption Rate (SAR)

6.1 Introduction

SAR is related to the rate at which energy is absorbed per unit mass in an object exposed to a radio field. The SAR distribution in a biological body is complicated and is usually carried out by experimental techniques or numerical modeling. The standard recommends limits for two tiers of groups, occupational/controlled and general population/uncontrolled, based on a person's awareness and ability to exercise control over his or her exposure. In general, occupational/controlled exposure limits are higher than the limits for general population/uncontrolled.

6.2 SAR Definition

The SAR definition is the time derivative (rate) of the incremental energy (dW) absorbed by (dissipated in) an incremental mass (dm) contained in a volume element (dv) of a given density (ρ). The equation description is as below:

$$SAR = \frac{d}{dt} \left(\frac{dW}{dm} \right) = \frac{d}{dt} \left(\frac{dW}{\rho dv} \right)$$

SAR is expressed in units of Watts per kilogram (W/kg)

SAR measurement can be either related to the temperature elevation in tissue by

$$SAR = c \left(\frac{\delta T}{\delta t} \right)$$

Where: C is the specific heat capacity, δT is the temperature rise and δt is the exposure duration, or related to the electrical field in the tissue by

$$SAR = \frac{\sigma |E|^2}{\rho}$$

Where: σ is the conductivity of the tissue, ρ is the mass density of tissue and E is the RMS electrical field strength.

However for evaluating SAR of low power transmitter, electrical field measurement is typically applied.

7 Tissue Simulating Liquids

7.1 Targets for tissue simulating liquid

Table 7.1: Targets for tissue simulating liquid

Frequency(MHz)	Liquid Type	Conductivity(σ)	$\pm 5\%$ Range	Permittivity(ϵ)	$\pm 5\%$ Range
750	Head	0.89	0.85~0.93	41.94	39.8~44.0
750	Body	0.96	0.91~1.01	55.5	52.7~58.3
835	Head	0.90	0.86~0.95	41.5	39.4~43.6
835	Body	0.97	0.92~1.02	55.2	52.4~58.0
1750	Head	1.37	1.30~1.44	40.08	38.1~42.1
1750	Body	1.49	1.42~1.56	53.4	50.7~56.1
1900	Head	1.40	1.33~1.47	40.0	38.0~42.0
1900	Body	1.52	1.44~1.60	53.3	50.6~56.0
2450	Head	1.80	1.71~1.89	39.2	37.2~41.2
2450	Body	1.95	1.85~2.05	52.7	50.1~55.3

7.2 Dielectric Performance

Table 7.2: Dielectric Performance of Tissue Simulating Liquid

Measurement Date (yyyy-mm-dd)	Type	Frequency	Permittivity ϵ	Drift (%)	Conductivity σ (S/m)	Drift (%)
2017-12-10	Head	750 MHz	42.61	1.60	0.88	-1.12
	Body	750 MHz	54.87	-1.14	0.969	0.94
2017-12-11	Head	835 MHz	41.69	0.46	0.882	-2.00
	Body	835 MHz	55.27	0.13	0.976	0.62
2017-12-12	Head	1750 MHz	40.29	0.52	1.385	1.09
	Body	1750 MHz	53.39	-0.02	1.484	-0.40
2017-12-13	Head	1900 MHz	40.17	0.43	1.39	-0.71
	Body	1900 MHz	52.82	-0.90	1.55	1.97
2017-12-14	Head	2450 MHz	39.01	-0.48	1.794	-0.33
	Body	2450 MHz	51.77	-1.76	1.957	0.36

Note: The liquid temperature is 22.0°C

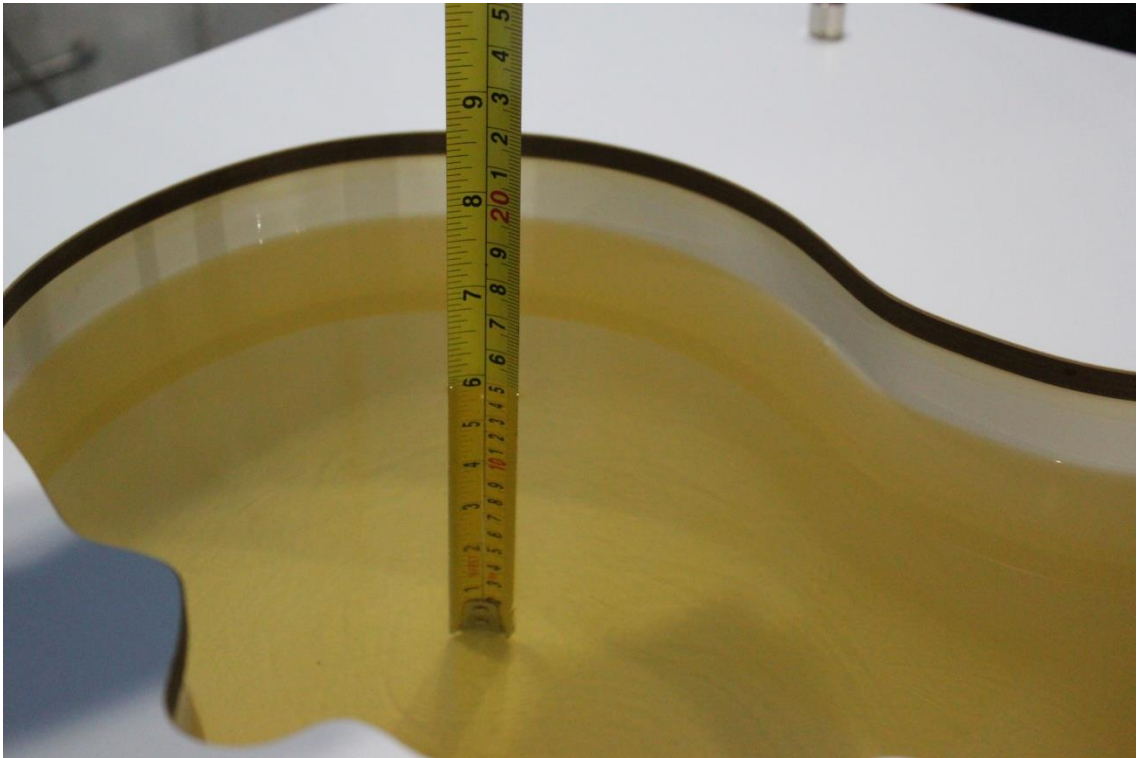

Picture 7-1 Liquid depth in the Head Phantom (750MHz)



Picture 7-2 Liquid depth in the Flat Phantom (750MHz)

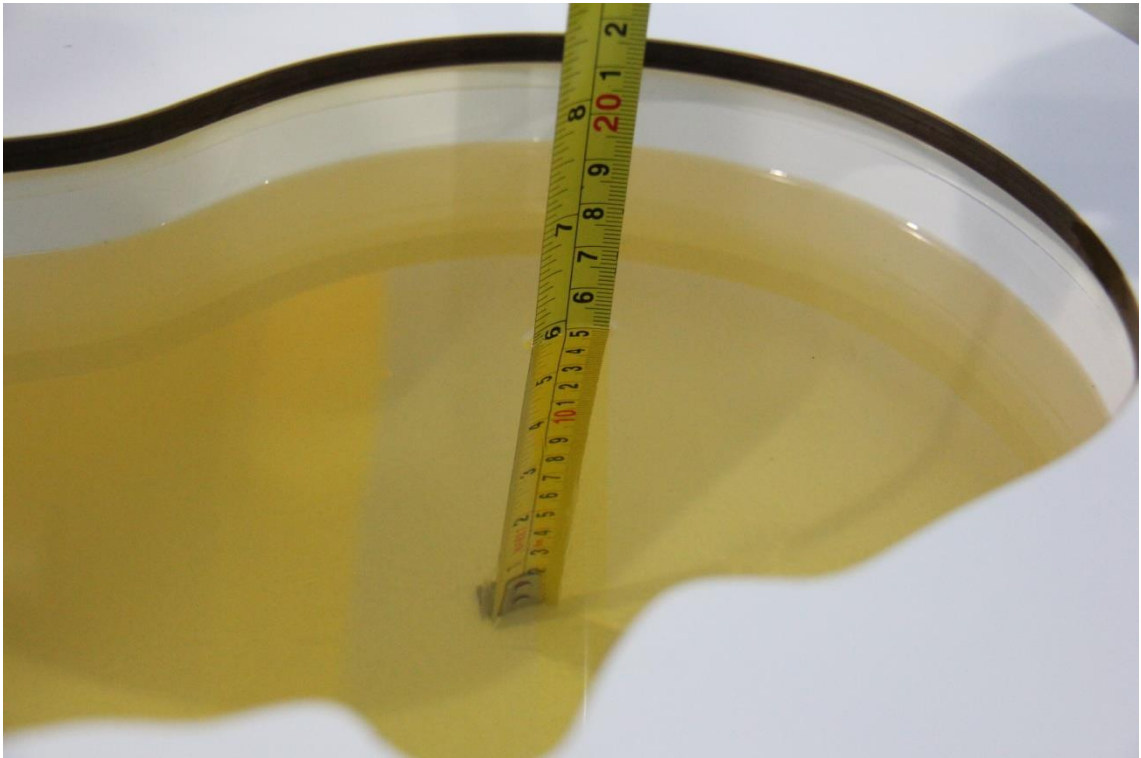

Picture 7-3 Liquid depth in the Head Phantom (835 MHz)

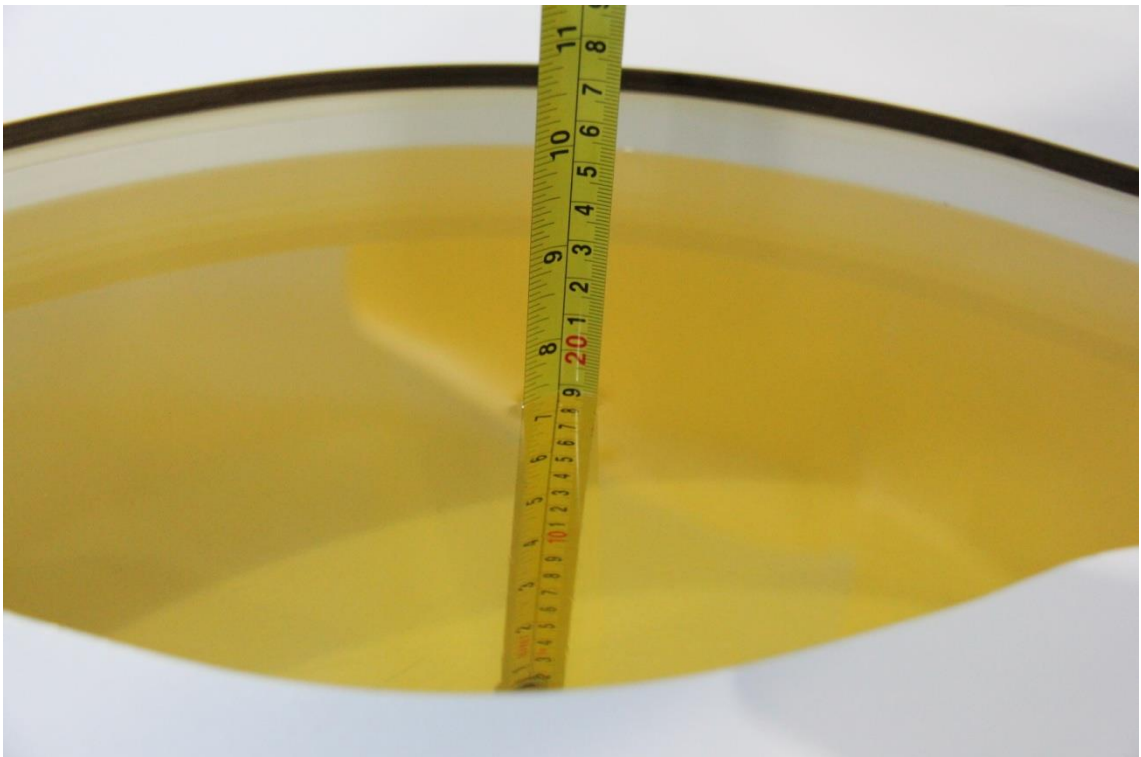

Picture 7-4 Liquid depth in the Flat Phantom (835 MHz)

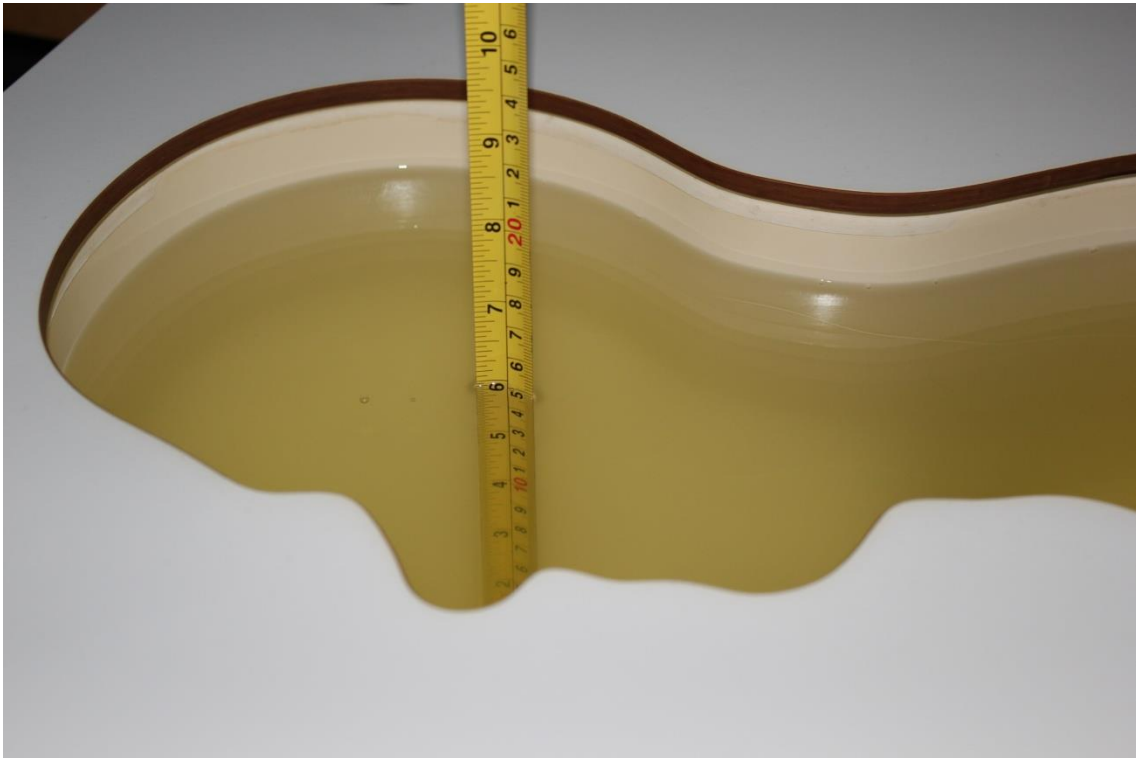

Picture 7-5 Liquid depth in the Head Phantom (1750 MHz)

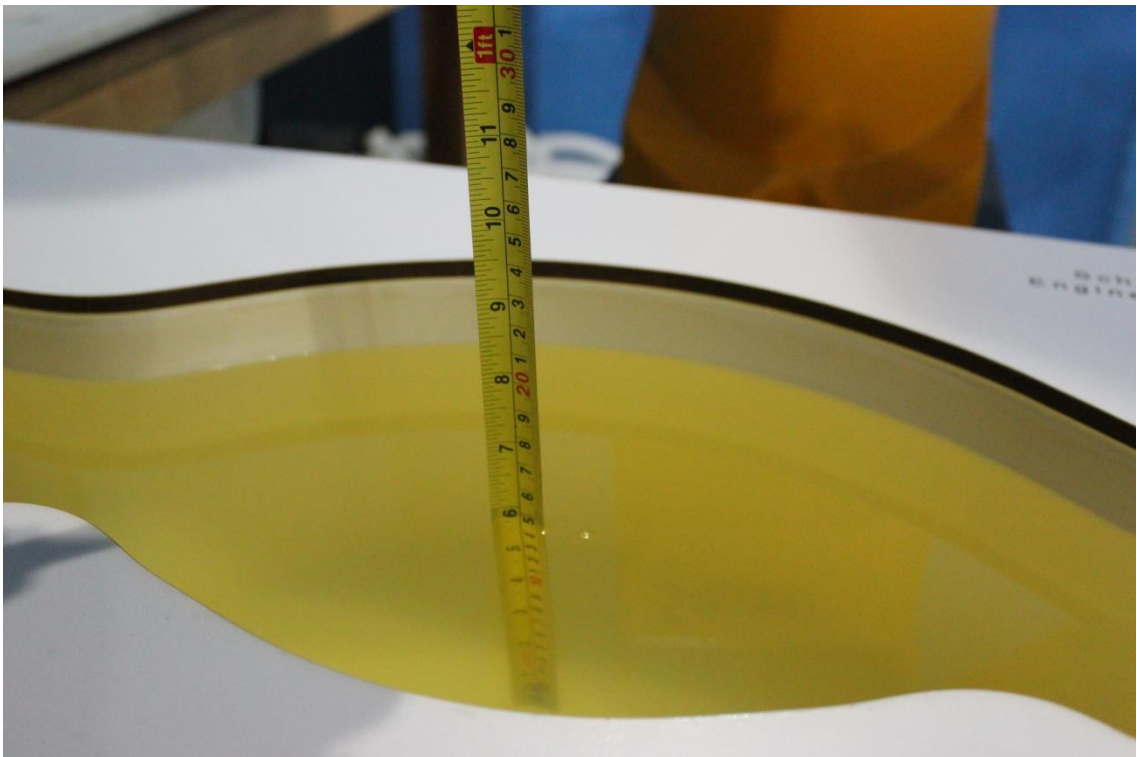

Picture 7-6 Liquid depth in the Flat Phantom (1750MHz)

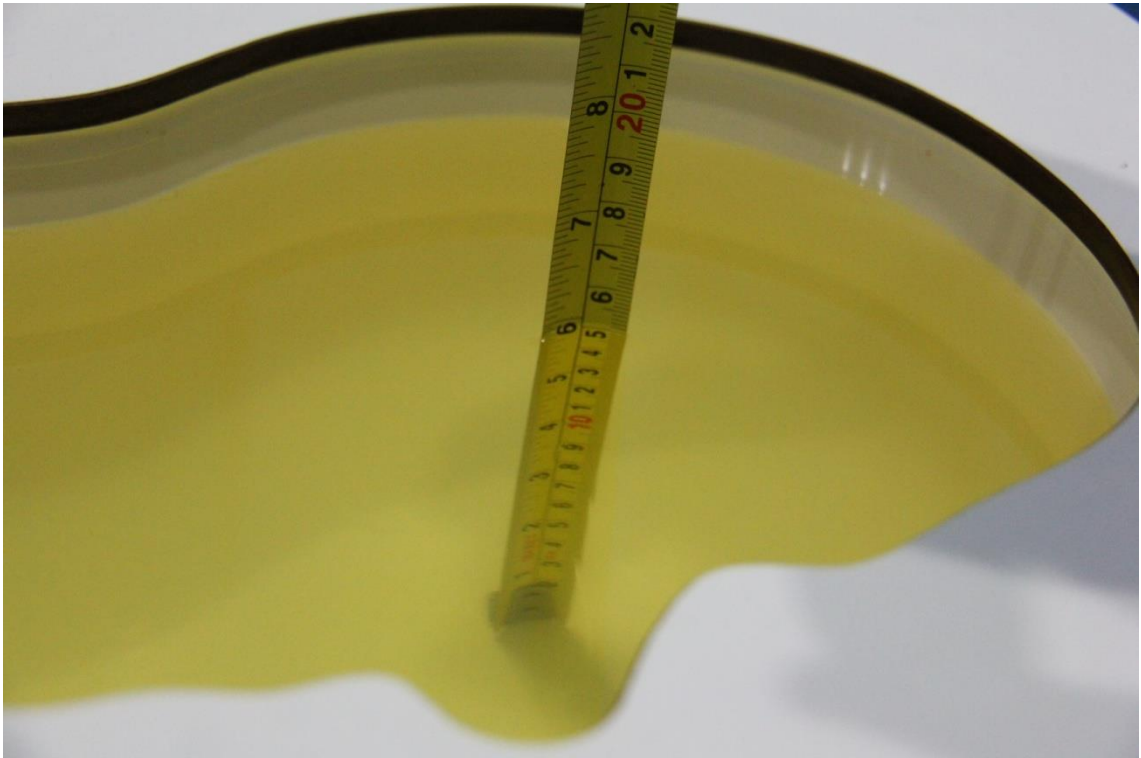

Picture 7-7 Liquid depth in the Head Phantom (1900 MHz)



Picture 7-8 Liquid depth in the Flat Phantom (1900MHz)

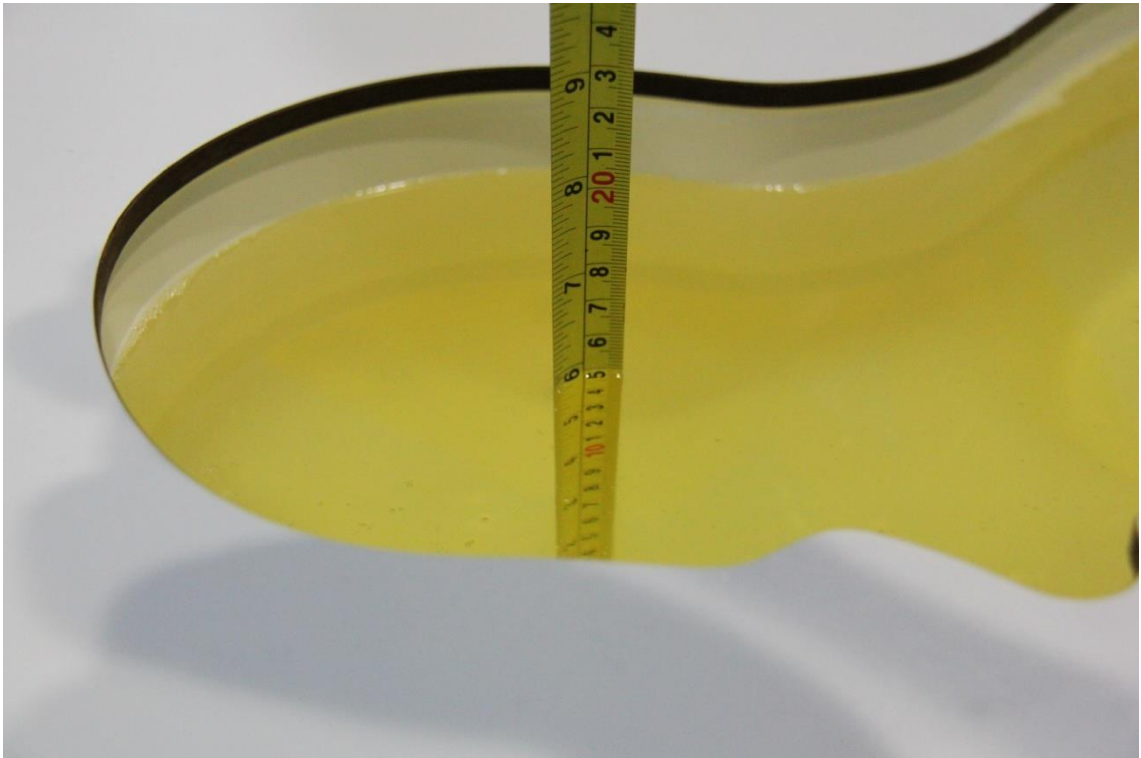

Picture 7-9 Liquid depth in the Head Phantom (2450MHz)

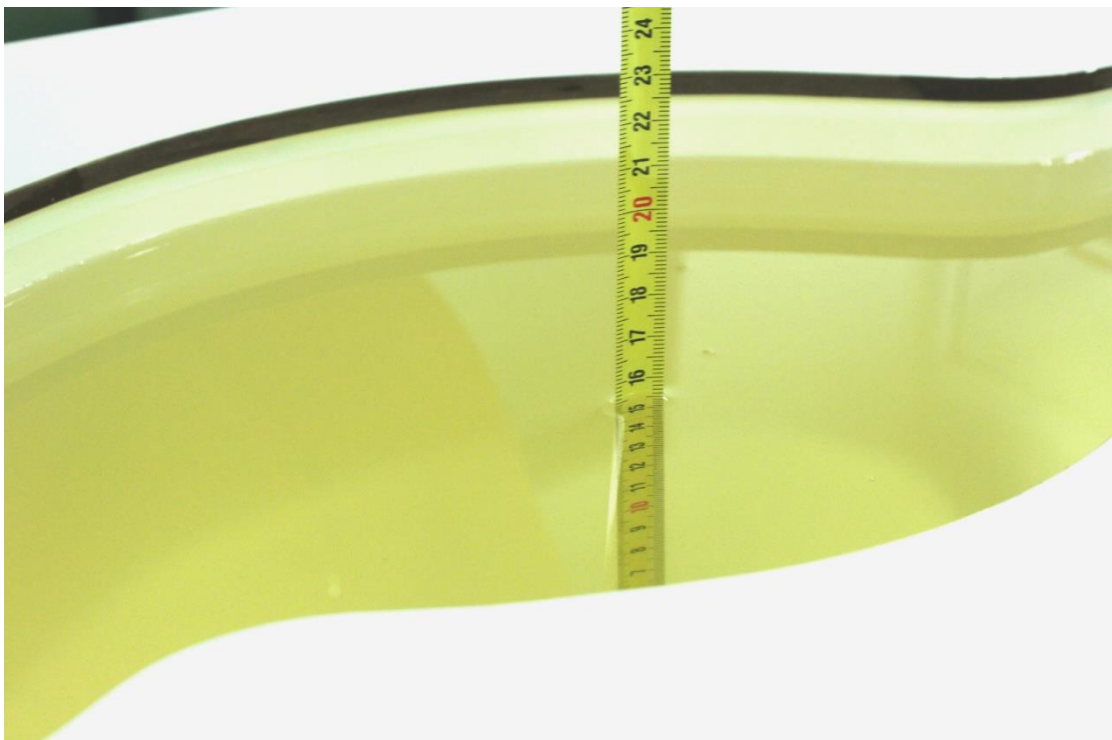

Picture 7-10 Liquid depth in the Flat Phantom (2450MHz)

8 System verification

8.1 System Setup

In the simplified setup for system evaluation, the DUT is replaced by a calibrated dipole and the power source is replaced by a continuous wave that comes from a signal generator. The calibrated dipole must be placed beneath the flat phantom section of the SAM twin phantom with the correct distance holder. The distance holder should touch the phantom surface with a light pressure at the reference marking and be oriented parallel to the long side of the phantom. The equipment setup is shown below:

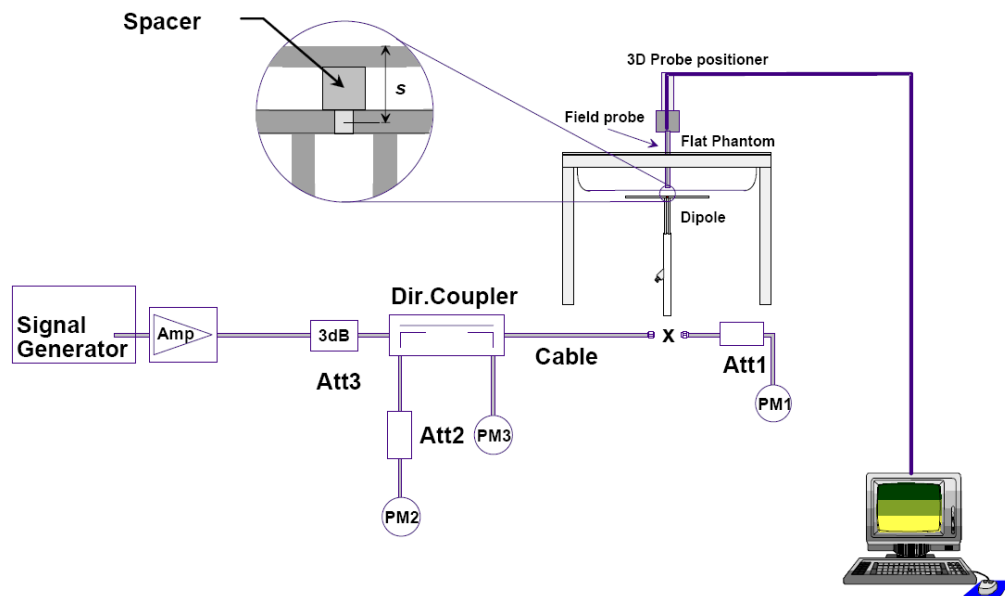

Picture 8.1 System Setup for System Evaluation



Picture 8.2 Photo of Dipole Setup

8.2 System Verification

SAR system verification is required to confirm measurement accuracy, according to the tissue dielectric media, probe calibration points and other system operating parameters required for measuring the SAR of a test device. The system verification must be performed for each frequency band and within the valid range of each probe calibration point required for testing the device.

The system verification results are required that the area scan estimated 1-g SAR is within 3% of the zoom scan 1-g SAR. The details are presented in annex B.

Table 8.1: System Verification of Head

Measurement Date (yyyy-mm-dd)	Frequency	Target value (W/kg)		Measured value(W/kg)		Deviation	
		10 g Average	1 g Average	10 g Average	1 g Average	10 g Average	1 g Average
2017-12-10	750 MHz	5.42	8.32	5.44	8.28	0.37%	-0.48%
2017-12-11	835 MHz	6.06	9.37	6.08	9.44	0.33%	0.75%
2017-12-12	1750 MHz	19.4	36.7	19.4	36.6	0.00%	-0.27%
2017-12-13	1900 MHz	21.0	40.0	20.8	40.04	-0.95%	0.10%
2017-12-14	2450 MHz	24.7	52.2	24.72	52.84	0.08%	1.23%

Table 8.2: System Verification of Body

Measurement Date (yyyy-mm-dd)	Frequency	Target value (W/kg)		Measured value (W/kg)		Deviation	
		10 g Average	1 g Average	10 g Average	1 g Average	10 g Average	1 g Average
2017-12-10	750 MHz	5.68	8.66	5.56	8.52	-2.11%	-1.62%
2017-12-11	835 MHz	6.12	9.41	6.12	9.32	0.00%	-0.96%
2017-12-12	1750 MHz	19.8	37.1	19.84	36.48	0.20%	-1.67%
2017-12-13	1900 MHz	21.5	40.5	21.12	40.32	-1.77%	-0.44%
2017-12-14	2450 MHz	23.8	50.4	23.4	51.36	-1.68%	1.90%

9 Measurement Procedures

9.1 Tests to be performed

In order to determine the highest value of the peak spatial-average SAR of a handset, all device positions, configurations and operational modes shall be tested for each frequency band according to steps 1 to 3 below. A flowchart of the test process is shown in picture 9.1.

Step 1: The tests described in 9.2 shall be performed at the channel that is closest to the centre of the transmit frequency band (f_c) for:

- a) all device positions (cheek and tilt, for both left and right sides of the SAM phantom, as described in annex D),
- b) all configurations for each device position in a), e.g., antenna extended and retracted, and
- c) all operational modes, e.g., analogue and digital, for each device position in a) and configuration in b) in each frequency band.

If more than three frequencies need to be tested according to 11.1 (i.e., $N_c > 3$), then all frequencies, configurations and modes shall be tested for all of the above test conditions.

Step 2: For the condition providing highest peak spatial-average SAR determined in Step 1, perform all tests described in 9.2 at all other test frequencies, i.e., lowest and highest frequencies. In addition, for all other conditions (device position, configuration and operational mode) where the peak spatial-average SAR value determined in Step 1 is within 3 dB of the applicable SAR limit, it is recommended that all other test frequencies shall be tested as well.

Step 3: Examine all data to determine the highest value of the peak spatial-average SAR found in Steps 1 to 2.

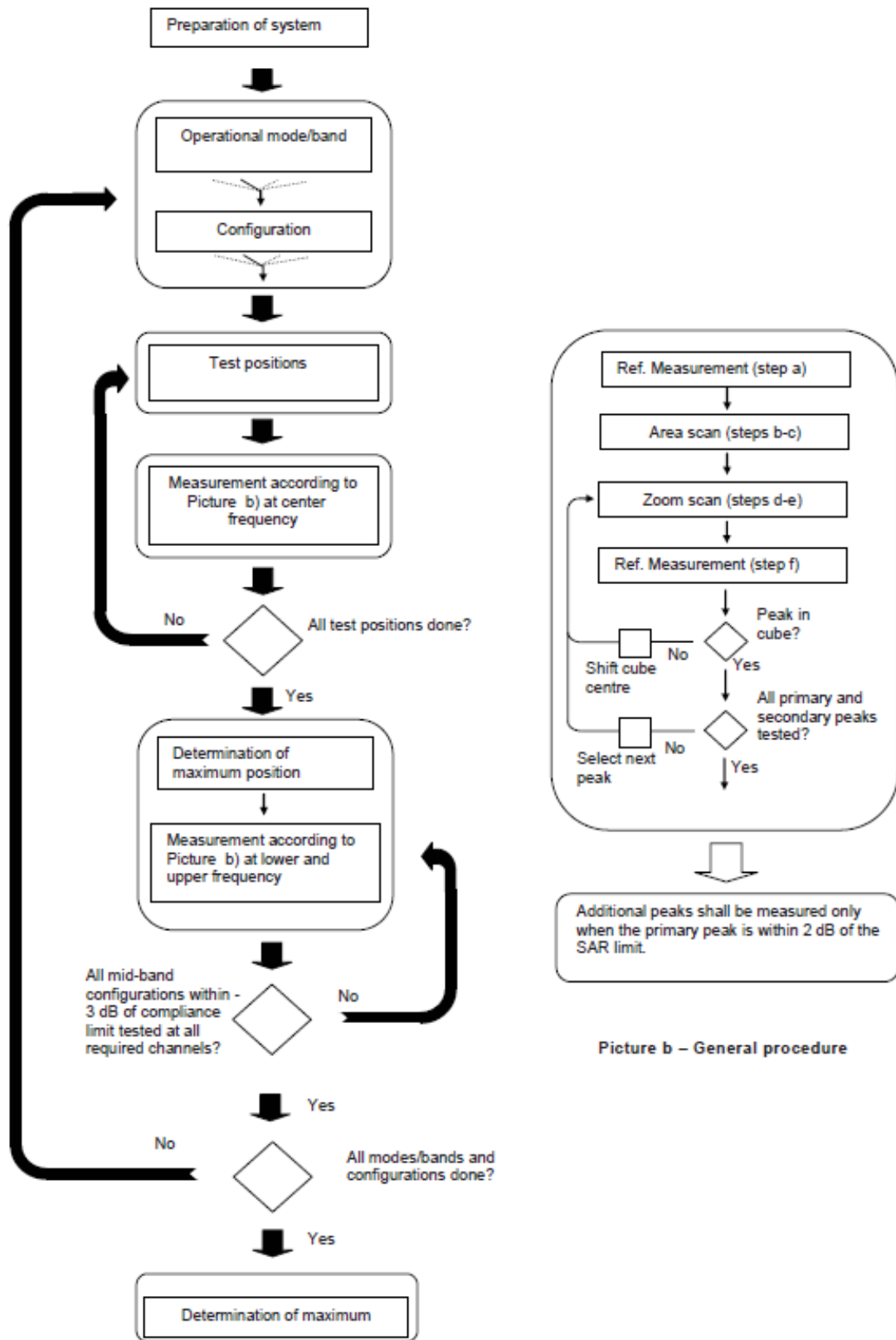

Picture a – Tests to be performed

Picture b – General procedure

Picture 9.1 Block diagram of the tests to be performed

9.2 General Measurement Procedure

The area and zoom scan resolutions specified in the table below must be applied to the SAR measurements and fully documented in SAR reports to qualify for TCB approval. Probe boundary effect error compensation is required for measurements with the probe tip closer than half a probe tip diameter to the phantom surface. Both the probe tip diameter and sensor offset distance must satisfy measurement protocols; to ensure probe boundary effect errors are minimized and the higher fields closest to the phantom surface can be correctly measured and extrapolated to the phantom surface for computing 1-g SAR. Tolerances of the post-processing algorithms must be verified by the test laboratory for the scan resolutions used in the SAR measurements, according to the reference distribution functions specified in IEEE Std 1528-2013. The results should be documented as part of the system validation records and may be requested to support test results when all the measurement parameters in the following table are not satisfied.

		≤ 3 GHz	> 3 GHz
Maximum distance from closest measurement point (geometric center of probe sensors) to phantom surface		5 ± 1 mm	$\frac{1}{2} \cdot \delta \cdot \ln(2) \pm 0.5$ mm
Maximum probe angle from probe axis to phantom surface normal at the measurement location		$30^\circ \pm 1^\circ$	$20^\circ \pm 1^\circ$
Maximum area scan spatial resolution: Δx_{Area} , Δy_{Area}		≤ 2 GHz: ≤ 15 mm 2 – 3 GHz: ≤ 12 mm	3 – 4 GHz: ≤ 12 mm 4 – 6 GHz: ≤ 10 mm
		When the x or y dimension of the test device, in the measurement plane orientation, is smaller than the above, the measurement resolution must be \leq the corresponding x or y dimension of the test device with at least one measurement point on the test device.	
Maximum zoom scan spatial resolution: Δx_{Zoom} , Δy_{Zoom}		≤ 2 GHz: ≤ 8 mm 2 – 3 GHz: ≤ 5 mm*	3 – 4 GHz: ≤ 5 mm* 4 – 6 GHz: ≤ 4 mm*
Maximum zoom scan spatial resolution, normal to phantom surface	uniform grid: $\Delta z_{Zoom}(n)$	≤ 5 mm	3 – 4 GHz: ≤ 4 mm 4 – 5 GHz: ≤ 3 mm 5 – 6 GHz: ≤ 2 mm
	graded grid	$\Delta z_{Zoom}(1)$: between 1 st two points closest to phantom surface	≤ 4 mm
		$\Delta z_{Zoom}(n>1)$: between subsequent points	$\leq 1.5 \cdot \Delta z_{Zoom}(n-1)$
Minimum zoom scan volume	x, y, z	≥ 30 mm	3 – 4 GHz: ≥ 28 mm 4 – 5 GHz: ≥ 25 mm 5 – 6 GHz: ≥ 22 mm
<p>Note: δ is the penetration depth of a plane-wave at normal incidence to the tissue medium; see draft standard IEEE P1528-2011 for details.</p> <p>* When zoom scan is required and the <i>reported</i> SAR from the area scan based 1-g SAR estimation procedures of KDB 447498 is ≤ 1.4 W/kg, ≤ 8 mm, ≤ 7 mm and ≤ 5 mm zoom scan resolution may be applied, respectively, for 2 GHz to 3 GHz, 3 GHz to 4 GHz and 4 GHz to 6 GHz.</p>			

9.3 WCDMA Measurement Procedures for SAR

The following procedures are applicable to WCDMA handsets operating under 3GPP Release99, Release 5 and Release 6. The default test configuration is to measure SAR with an established radio link between the DUT and a communication test set using a 12.2kbps RMC (reference measurement channel) configured in Test Loop Mode 1. SAR is selectively confirmed for other physical channel configurations (DPCCH & DPDCH_n), HSDPA and HSPA (HSUPA/HSDPA) modes according to output power, exposure conditions and device operating capabilities. Both uplink and downlink should be configured with the same RMC or AMR, when required. SAR for Release 5 HSDPA and Release 6 HSPA are measured using the applicable FRC (fixed reference channel) and E-DCH reference channel configurations. Maximum output power is verified according to applicable versions of 3GPP TS 34.121 and SAR must be measured according to these maximum output conditions. When Maximum Power Reduction (MPR) is not implemented according to Cubic Metric (CM) requirements for Release 6 HSPA, the following procedures do not apply.

For Release 5 HSDPA Data Devices:

Sub-test	β_c	β_d	β_d (SF)	β_c / β_d	β_{hs}	CM/dB
1	2/15	15/15	64	2/15	4/15	0.0
2	12/15	15/15	64	12/15	24/25	1.0
3	15/15	8/15	64	15/8	30/15	1.5
4	15/15	4/15	64	15/4	30/15	1.5

For Release 6 HSPA Data Devices

Sub-test	β_c	β_d	β_d (SF)	β_c / β_d	β_{hs}	β_{ec}	β_{ed}	β_{ed} (SF)	β_{ed} (codes)	CM (dB)	MPR (dB)	AG Index	E-TFCI
1	11/15	15/15	64	11/15	22/15	209/225	1039/225	4	1	1.5	1.5	20	75
2	6/15	15/15	64	6/15	12/15	12/15	12/15	4	1	1.5	1.5	12	67
3	15/15	9/15	64	15/9	30/15	30/15	$\beta_{ed1}:47/15$ $\beta_{ed2}:47/15$	4	2	1.5	1.5	15	92
4	2/15	15/15	64	2/15	4/15	4/15	56/75	4	1	1.5	1.5	17	71
5	15/15	15/15	64	15/15	24/15	30/15	134/15	4	1	1.5	1.5	21	81

Rel.8 DC-HSDPA (Cat 24)

SAR test exclusion for Rel.8 DC-HSDPA must satisfy the SAR test exclusion requirements of Rel.5 HSDPA. SAR test exclusion for DC-HSDPA devices is determined by power measurements according to the H-Set 12, Fixed Reference Channel (FRC) configuration in Table C.8.1.12 of 3GPP TS 34.121-1. A primary and a secondary serving HS-DSCH Cell are required to perform the power measurement and for the results to qualify for SAR test exclusion.

9.4 SAR Measurement for LTE

SAR tests for LTE are performed with a base station simulator, Rohde & Schwarz CMW500. Closed loop power control was used so the UE transmits with maximum output power during SAR testing. All powers were measured with the CMW 500.

It is performed for conducted power and SAR based on the KDB941225 D05.

SAR is evaluated separately according to the following procedures for the different test positions in each exposure condition – head, body, body-worn accessories and other use conditions. The procedures in the following subsections are applied separately to test each LTE frequency band.

1) QPSK with 1 RB allocation

Start with the largest channel bandwidth and measure SAR for QPSK with 1 RB allocation, using the RB offset and required test channel combination with the highest maximum output power among RB offsets at the upper edge, middle and lower edge of each required test channel. When the reported SAR is ≤ 0.8 W/kg, testing of the remaining RB offset configurations and required test channels is not required for 1 RB allocation; otherwise, SAR is required for the remaining required test channels and only for the RB offset configuration with the highest output power for that channel. When the reported SAR of a required test channel is > 1.45 W/kg, SAR is required for all three RB offset configurations for that required test channel.

2) QPSK with 50% RB allocation

The procedures required for 1 RB allocation in 1) are applied to measure the SAR for QPSK with 50% RB allocation.

3) QPSK with 100% RB allocation

For QPSK with 100% RB allocation, SAR is not required when the highest maximum output power for 100 % RB allocation is less than the highest maximum output power in 50% and 1 RB allocations and the highest reported SAR for 1 RB and 50% RB allocation in 1) and 2) are ≤ 0.8 W/kg. Otherwise, SAR is measured for the highest output power channel; and if the reported SAR is > 1.45 W/kg, the remaining required test channels must also be tested.

9.5 Bluetooth & Wi-Fi Measurement Procedures for SAR

Normal network operating configurations are not suitable for measuring the SAR of 802.11 transmitters in general. Unpredictable fluctuations in network traffic and antenna diversity conditions can introduce undesirable variations in SAR results. The SAR for these devices should be measured using chipset based test mode software to ensure that the results are consistent and reliable.

Chipset based test mode software is hardware dependent and generally varies among manufacturers. The device operating parameters established in a test mode for SAR measurements must be identical to those programmed in production units, including output power levels, amplifier gain settings and other RF performance tuning parameters. The test frequencies should correspond to actual channel frequencies defined for domestic use. SAR for devices with switched diversity should be measured with only one antenna transmitting at a time during each SAR measurement, according to a fixed modulation and data rate. The same data pattern should be used for all measurements.

9.6 Power Drift

To control the output power stability during the SAR test, DASY4 system calculates the power drift by measuring the E-field at the same location at the beginning and at the end of the measurement for each test position. These drift values can be found in section 14 labeled as: (Power Drift [dB]). This ensures that the power drift during one measurement is within 5%.

10 Area Scan Based 1-g SAR

10.1 Requirement of KDB

According to the KDB447498 D01 v05, when the implementation is based on the specific polynomial fit algorithm as presented at the 29th Bioelectromagnetics Society meeting (2007) and the estimated 1-g SAR is ≤ 1.2 W/kg, a zoom scan measurement is not required provided it is also not needed for any other purpose; for example, if the peak SAR location required for simultaneous transmission SAR test exclusion can be determined accurately by the SAR system or manually to discriminate between distinctive peaks and scattered noisy SAR distributions from area scans.

There must not be any warning or alert messages due to various measurement concerns identified by the SAR system; for example, noise in measurements, peaks too close to scan boundary, peaks are too sharp, spatial resolution and uncertainty issues etc. The SAR system verification must also demonstrate that the area scan estimated 1-g SAR is within 3% of the zoom scan 1-g SAR (See Annex B). When all the SAR results for each exposure condition in a frequency band and wireless mode are based on estimated 1-g SAR, the 1-g SAR for the highest SAR configuration must be determined by a zoom scan.

10.2 Fast SAR Algorithms

The approach is based on the area scan measurement applying a frequency dependent attenuation parameter. This attenuation parameter was empirically determined by analyzing a large number of phones. The MOTOROLA FAST SAR was developed and validated by the MOTOROLA Research Group in Ft. Lauderdale.

In the initial study, an approximation algorithm based on Linear fit was developed. The accuracy of the algorithm has been demonstrated across a broad frequency range (136-2450 MHz) and for both 1- and 10-g averaged SAR using a sample of 264 SAR measurements from 55 wireless handsets. For the sample size studied, the root-mean-squared errors of the algorithm were 1.2% and 5.8% for 1- and 10-g averaged SAR, respectively. The paper describing the algorithm in detail is expected to be published in August 2004 within the Special Issue of Transactions on MTT.

In the second step, the same research group optimized the fitting algorithm to an Polynomial fit whereby the frequency validity was extended to cover the range 30-6000 MHz. Details of this study can be found in the BEMS 2007 Proceedings.

Both algorithms are implemented in DASY software.

11 Conducted Output Power

11.1 GSM Measurement result

During the process of testing, the EUT was controlled via Agilent Digital Radio Communication tester (E5515C) to ensure the maximum power transmission and proper modulation. This result contains conducted output power for the EUT. In all cases, the measured peak output power should be greater and within 5% than EMI measurement.

Table 11.1-1: The conducted power measurement results for GSM, GPRS and EGPRS

GSM 850 Speech (GMSK)	Measured Power (dBm)			Tune up	calculation	Averaged Power (dBm)		
	251	190	128			251	190	128
/	32.62	32.48	32.39	33.2	/	/	/	/
GSM 850 GPRS (GMSK)	Measured Power (dBm)				calculation	Averaged Power (dBm)		
	251	190	128			251	190	128
1 Txslot	32.84	32.63	32.88	33.2	-9.03	23.81	23.60	23.85
2 Txslots	30.47	30.28	30.78	31.2	-6.02	24.45	24.26	24.76
3Txslots	29.25	29.32	29.54	29.7	-4.26	24.99	25.06	25.28
4 Txslots	27.55	27.83	27.59	28.2	-3.01	24.54	24.82	24.58
GSM 850 EGPRS (GMSK)	Measured Power (dBm)				calculation	Averaged Power (dBm)		
	251	190	128			251	190	128
1 Txslot	32.52	32.38	32.30	33.2	-9.03	23.49	23.35	23.27
2 Txslots	30.21	30.06	30.27	31.2	-6.02	24.19	24.04	24.25
3Txslots	28.91	29.24	29.05	29.7	-4.26	24.65	24.98	24.79
4 Txslots	27.31	27.62	27.53	28.2	-3.01	24.30	24.61	24.52
GSM 850 EGPRS (8PSK)	Measured Power (dBm)				calculation	Averaged Power (dBm)		
	251	190	128			251	190	128
1 Txslot	26.84	26.86	26.92	27.7	-9.03	17.81	17.83	17.89
2 Txslots	26.27	26.28	26.28	26.7	-6.02	20.25	20.26	20.26
3Txslots	24.79	24.80	24.79	25.2	-4.26	20.53	20.54	20.53
4 Txslots	23.77	23.70	23.98	24.2	-3.01	20.76	20.69	20.97
PCS1900 Speech (GMSK)	Measured Power (dBm)			Tune up	calculation	Averaged Power (dBm)		
	810	661	512			810	661	512
/	30.50	30.10	30.08	30.7	/	/	/	/
PCS1900 GPRS (GMSK)	Measured Power (dBm)				calculation	Averaged Power (dBm)		
	810	661	512			810	661	512
1 Txslot	30.39	30.11	30.02	30.7	-9.03	21.36	21.08	20.99
2 Txslots	27.60	27.49	27.50	28.2	-6.02	21.58	21.47	21.48
3Txslots	26.20	26.10	26.07	26.7	-4.26	21.94	21.84	21.81
4 Txslots	24.99	24.94	24.93	25.2	-3.01	21.98	21.93	21.92
PCS1900 EGPRS (GMSK)	Measured Power (dBm)				calculation	Averaged Power (dBm)		
	810	661	512			810	661	512
1 Txslot	30.40	30.00	29.94	30.7	-9.03	21.37	20.97	20.91

2 Txslots	27.44	27.37	27.41	28.2	-6.02	21.42	21.35	21.39
3Txslots	26.14	25.99	25.99	26.7	-4.26	21.88	21.73	21.73
4 Txslots	24.90	24.84	24.84	25.2	-3.01	21.89	21.83	21.83
PCS1900 EGPRS (8PSK)	Measured Power (dBm)				calculation	Averaged Power (dBm)		
	810	661	512			810	661	512
1 Txslot	26.91	26.89	26.90	27	-9.03	17.88	17.86	17.87
2 Txslots	25.79	25.57	25.55	26	-6.02	19.77	19.55	19.53
3Txslots	24.25	24.22	24.26	24.7	-4.26	19.99	19.96	20.00
4 Txslots	22.66	22.61	22.62	23.2	-3.01	19.65	19.60	19.61

NOTES:

1) Division Factors

To average the power, the division factor is as follows:

1TX-slot = 1 transmit time slot out of 8 time slots=> conducted power divided by (8/1) => -9.03dB

2TX-slots = 2 transmit time slots out of 8 time slots=> conducted power divided by (8/2) => -6.02dB

3TX-slots = 3 transmit time slots out of 8 time slots=> conducted power divided by (8/3) => -4.26dB

4TX-slots = 4 transmit time slots out of 8 time slots=> conducted power divided by (8/4) => -3.01dB

According to the conducted power as above, the body measurements are performed with 3Txslots for GSM850 and 4Txslots for GSM1900.

11.2 WCDMA Measurement result

Table 11.2-1: The conducted Power for WCDMA

Item	band	FDDV result			
	ARFCN	4233 (846.6MHz)	4182 (836.4MHz)	4132 (826.4MHz)	Tune up
WCDMA	\	23.15	23.23	23.14	23.7
HSUPA	1	21.71	21.16	21.81	22.7
	2	20.50	20.60	20.56	21.7
	3	20.67	20.78	20.79	21.7
	4	21.24	21.26	21.28	22.7
	5	21.64	21.71	21.69	23.2
DC-HSDPA	1	21.55	21.57	21.56	22.7
	2	21.54	21.58	21.55	22.7
	3	21.58	21.61	21.54	22.7
	4	21.60	21.63	21.57	22.7
Item	band	FDDIV result			
	ARFCN	1513 (1752.6MHz)	1412 (1732.4MHz)	1312 (1712.4MHz)	
WCDMA	\	23.30	23.25	23.21	23.7
HSUPA	1	21.31	21.35	21.39	22.7
	2	20.68	20.71	20.76	21.8
	3	20.36	21.05	20.45	21.7
	4	21.60	21.54	21.42	22.7
	5	21.99	22.08	22.08	23.2

DC-HSDPA	1	21.97	21.83	21.77	22.7
	2	21.98	21.82	21.78	22.7
	3	21.96	21.80	21.79	22.7
	4	21.95	21.84	21.81	22.7
Item	band	FDDII result			
	ARFCN	9538 (1907.6MHz)	9400 (1880MHz)	9262 (1852.4MHz)	
WCDMA	\	23.13	23.22	23.11	23.7
HSUPA	1	21.30	22.07	21.42	22.7
	2	20.67	20.84	20.80	21.7
	3	20.35	21.02	20.48	21.8
	4	20.87	21.70	21.56	22.7
	5	21.97	22.11	22.15	23.2
DC-HSDPA	1	21.85	21.92	21.83	22.7
	2	21.81	21.98	21.82	22.7
	3	21.86	21.95	21.86	22.7
	4	21.83	21.93	21.90	22.7

11.3 LTE Measurement result

Table 11.3-1: The conducted Power for LTE

Band 2							
Bandwidth (MHz)	RB allocation	Frequency (MHz)	Max. Target Power (dBm)	QPSK		16QAM	
	RB offset (Start RB)			Actual output power (dBm)	MPR	Actual output power (dBm)	MPR
1.4 MHz	1RB High (5)	1909.3	24	23.38	0	22.59	1
		1880	24	23.49	0	22.60	1
		1850.7	24	23.44	0	22.38	1
	1RB Middle (3)	1909.3	24	23.47	0	22.44	1
		1880	24	23.55	0	22.56	1
		1850.7	24	23.55	0	22.22	1
	1RB Low (0)	1909.3	24	23.50	0	22.55	1
		1880	24	23.53	0	22.53	1
		1850.7	24	23.50	0	22.39	1
	3RB High (3)	1909.3	24	23.36	0	22.53	1
		1880	24	23.47	0	22.42	1
		1850.7	24	23.40	0	22.14	1
	3RB Middle (1)	1909.3	24	23.59	0	22.54	1
		1880	24	23.49	0	22.36	1
		1850.7	24	23.52	0	22.21	1
	3RB Low (0)	1909.3	24	23.57	0	22.53	1
		1880	24	23.44	0	22.42	1
		1850.7	24	23.48	0	22.47	1
	6RB (0)	1909.3	24	22.40	1	21.20	2
		1880	24	22.44	1	21.42	2
		1850.7	24	22.48	1	21.18	2

3 MHz	1RB High (14)	1908.5	24	23.58	0	22.58	1
		1880	24	23.50	0	22.51	1
		1851.5	24	23.41	0	22.30	1
	1RB Middle (7)	1908.5	24	23.53	0	22.57	1
		1880	24	23.51	0	22.09	1
		1851.5	24	23.54	0	22.57	1
	1RB Low (0)	1908.5	24	23.58	0	22.56	1
		1880	24	23.46	0	22.50	1
		1851.5	24	23.43	0	22.53	1
	8RB High (7)	1908.5	24	22.48	1	21.54	2
		1880	24	22.44	1	21.45	2
		1851.5	24	22.41	1	21.24	2
	8RB Middle (4)	1908.5	24	22.52	1	21.54	2
		1880	24	22.48	1	21.54	2
		1851.5	24	22.47	1	21.32	2
	8RB Low (0)	1908.5	24	22.58	1	21.55	2
		1880	24	22.47	1	21.52	2
		1851.5	24	22.37	1	21.31	2
15RB (0)	1908.5	24	22.50	1	21.49	2	
	1880	24	22.46	1	21.51	2	
	1851.5	24	22.36	1	21.09	2	
5 MHz	1RB High (24)	1907.5	24	23.30	0	21.64	1
		1880	24	23.18	0	22.24	1
		1852.5	24	23.39	0	22.07	1
	1RB Middle (12)	1907.5	24	23.51	0	22.00	1
		1880	24	23.45	0	22.26	1
		1852.5	24	23.53	0	22.38	1
	1RB Low (0)	1907.5	24	23.51	0	21.87	1
		1880	24	23.29	0	22.10	1
		1852.5	24	23.12	0	21.76	1
	12RB High (13)	1907.5	24	22.37	1	21.47	2
		1880	24	22.42	1	21.21	2
		1852.5	24	22.27	1	21.17	2
	12RB Middle (6)	1907.5	24	22.52	1	21.54	2
		1880	24	22.48	1	21.27	2
		1852.5	24	22.46	1	21.46	2
	12RB Low (0)	1907.5	24	22.51	1	21.55	2
		1880	24	22.44	1	21.25	2
		1852.5	24	22.46	1	21.47	2
25RB (0)	1907.5	24	22.44	1	21.51	2	
	1880	24	22.44	1	21.36	2	
	1852.5	24	22.31	1	21.24	2	
10 MHz	1RB High (49)	1905	24	23.58	0	22.55	1
		1880	24	23.17	0	22.53	1
		1855	24	23.39	0	22.48	1
	1RB Middle (24)	1905	24	23.51	0	22.56	1
		1880	24	23.44	0	21.87	1
		1855	24	23.20	0	22.58	1

	1RB Low (0)	1905	24	23.41	0	22.54	1
		1880	24	23.37	0	21.86	1
		1855	24	23.32	0	22.33	1
	25RB High (25)	1905	24	22.37	1	21.45	2
		1880	24	22.47	1	21.60	2
		1855	24	22.36	1	21.43	2
	25RB Middle (12)	1905	24	22.50	1	21.52	2
		1880	24	22.46	1	21.52	2
		1855	24	22.33	1	21.43	2
	25RB Low (0)	1905	24	22.43	1	21.37	2
		1880	24	22.34	1	21.47	2
		1855	24	22.39	1	21.59	2
	50RB (0)	1905	24	22.43	1	21.35	2
		1880	24	22.37	1	21.42	2
		1855	24	22.32	1	21.35	2
15 MHz	1RB High (74)	1902.5	24	23.54	0	22.59	1
		1880	24	23.14	0	22.21	1
		1857.5	24	23.29	0	22.58	1
	1RB Middle (37)	1902.5	24	23.59	0	22.55	1
		1880	24	23.39	0	22.55	1
		1857.5	24	23.21	0	22.59	1
	1RB Low (0)	1902.5	24	23.56	0	22.29	1
		1880	24	23.26	0	22.52	1
		1857.5	24	23.21	0	22.50	1
	36RB High (38)	1902.5	24	22.33	1	21.19	2
		1880	24	22.41	1	21.47	2
		1857.5	24	22.39	1	21.28	2
	36RB Middle (19)	1902.5	24	22.45	1	21.32	2
		1880	24	22.46	1	21.44	2
		1857.5	24	22.32	1	21.38	2
	36RB Low (0)	1902.5	24	22.33	1	21.30	2
		1880	24	22.31	1	21.32	2
		1857.5	24	22.26	1	21.13	2
	75RB (0)	1902.5	24	22.33	1	21.32	2
		1880	24	22.28	1	21.35	2
		1857.5	24	22.34	1	21.43	2
20 MHz	1RB High (99)	1900	24	23.46	0	22.12	1
		1880	24	23.56	0	21.93	1
		1860	24	23.03	0	21.67	1
	1RB Middle (50)	1900	24	23.45	0	22.40	1
		1880	24	23.45	0	22.25	1
		1860	24	23.34	0	22.22	1
	1RB Low (0)	1900	24	23.53	0	22.12	1
		1880	24	23.17	0	22.31	1
		1860	24	23.12	0	21.74	1
	50RB High (50)	1900	24	22.38	1	21.24	2
		1880	24	22.37	1	21.36	2
		1860	24	22.30	1	21.29	2

	50RB Middle (25)	1900	24	22.42	1	21.50	2
		1880	24	22.38	1	21.39	2
		1860	24	22.32	1	21.45	2
	50RB Low (0)	1900	24	22.43	1	21.52	2
		1880	24	22.21	1	21.22	2
		1860	24	22.29	1	21.37	2
	100RB (0)	1900	24	22.33	1	21.30	2
		1880	24	22.29	1	21.21	2
		1860	24	22.22	1	21.32	2
Band 5							
Bandwidth (MHz)	RB allocation	Frequency (MHz)	Max. Target Power (dBm)	QPSK		16QAM	
	RB offset (Start RB)			Actual output power (dBm)	MPR	Actual output power (dBm)	MPR
1.4 MHz	1RB High (5)	848.3	24	23.21	0	22.41	1
		836.5	24	23.27	0	22.28	1
		824.7	24	23.08	0	22.33	1
	1RB Middle (3)	848.3	24	23.38	0	22.40	1
		836.5	24	23.24	0	22.35	1
		824.7	24	23.11	0	22.37	1
	1RB Low (0)	848.3	24	23.25	0	22.42	1
		836.5	24	23.29	0	22.29	1
		824.7	24	23.10	0	22.40	1
	3RB High (3)	848.3	24	23.29	0	22.59	1
		836.5	24	23.35	0	22.15	1
		824.7	24	23.22	0	22.56	1
	3RB Middle (1)	848.3	24	23.38	0	22.52	1
		836.5	24	23.27	0	22.38	1
		824.7	24	23.46	0	22.56	1
	3RB Low (0)	848.3	24	23.36	0	22.52	1
		836.5	24	23.42	0	22.42	1
		824.7	24	23.30	0	22.45	1
6RB (0)	848.3	24	22.35	1	21.58	2	
	836.5	24	22.41	1	21.43	2	
	824.7	24	22.30	1	21.53	2	
3 MHz	1RB High (14)	847.5	24	23.13	0	22.36	1
		836.5	24	23.45	0	22.31	1
		825.5	24	23.26	0	21.95	1
	1RB Middle (7)	847.5	24	23.46	0	22.52	1
		836.5	24	23.56	0	22.58	1
		825.5	24	23.41	0	22.58	1
	1RB Low (0)	847.5	24	23.36	0	22.45	1
		836.5	24	23.58	0	22.49	1
		825.5	24	23.29	0	21.97	1
	8RB High (7)	847.5	24	22.35	1	21.25	2
		836.5	24	22.52	1	21.55	2
		825.5	24	22.37	1	21.37	2

	8RB Middle (4)	847.5	24	22.49	1	21.26	2	
		836.5	24	22.50	1	21.31	2	
		825.5	24	22.28	1	21.39	2	
	8RB Low (0)	847.5	24	22.46	1	21.11	2	
		836.5	24	22.45	1	21.35	2	
		825.5	24	22.30	1	21.40	2	
	15RB (0)	847.5	24	22.36	1	21.16	2	
		836.5	24	22.46	1	21.40	2	
		825.5	24	22.33	1	21.47	2	
5 MHz	1RB High (24)	846.5	24	23.26	0	22.14	1	
		836.5	24	23.22	0	22.11	1	
		826.5	24	22.96	0	22.08	1	
	1RB Middle (12)	846.5	24	23.57	0	22.36	1	
		836.5	24	23.51	0	22.38	1	
		826.5	24	23.50	0	22.54	1	
	1RB Low (0)	846.5	24	23.51	0	21.98	1	
		836.5	24	23.34	0	21.81	1	
		826.5	24	22.81	0	21.94	1	
	12RB High (13)	846.5	24	22.41	1	21.25	2	
		836.5	24	22.44	1	21.43	2	
		826.5	24	22.36	1	21.33	2	
	12RB Middle (6)	846.5	24	22.50	1	21.52	2	
		836.5	24	22.49	1	21.47	2	
		826.5	24	22.31	1	21.24	2	
	12RB Low (0)	846.5	24	22.49	1	21.48	2	
		836.5	24	22.39	1	21.38	2	
		826.5	24	22.35	1	21.10	2	
	25RB (0)	846.5	24	22.37	1	21.42	2	
		836.5	24	22.39	1	21.50	2	
		826.5	24	22.42	1	21.41	2	
	10 MHz	1RB High (49)	844.0	24	23.27	0	22.09	1
			836.5	24	23.49	0	22.38	1
			829.0	24	23.22	0	22.07	1
1RB Middle (24)		844.0	24	23.60	0	22.51	1	
		836.5	24	23.55	0	22.53	1	
		829.0	24	23.50	0	22.55	1	
1RB Low (0)		844.0	24	23.37	0	22.23	1	
		836.5	24	23.54	0	22.47	1	
		829.0	24	23.28	0	21.89	1	
25RB High (25)		844.0	24	22.35	1	21.50	2	
		836.5	24	22.47	1	21.54	2	
		829.0	24	22.50	1	21.48	2	
25RB Middle (12)		844.0	24	22.54	1	21.59	2	
		836.5	24	22.52	1	21.38	2	
		829.0	24	22.58	1	21.56	2	
25RB Low (0)		844.0	24	22.41	1	21.52	2	
		836.5	24	22.43	1	21.28	2	
		829.0	24	22.37	1	21.43	2	



	50RB (0)	844.0	24	22.45	1	21.36	2
		836.5	24	22.37	1	21.30	2
		829.0	24	22.44	1	21.40	2

Band 12								
Bandwidth (MHz)	RB allocation RB offset (Start RB)	Frequency (MHz)	Max. Target Power (dBm)	QPSK		16QAM		
				Actual output power (dBm)	MPR	Actual output power (dBm)	MPR	
1.4 MHz	1RB High (5)	715.3	24	23.03	0	22.51	1	
		707.5	24	23.20	0	22.36	1	
		699.7	24	23.29	0	22.17	1	
	1RB Middle (3)	715.3	24	23.10	0	22.58	1	
		707.5	24	23.33	0	22.33	1	
		699.7	24	23.27	0	22.28	1	
	1RB Low (0)	715.3	24	23.16	0	22.42	1	
		707.5	24	23.17	0	22.19	1	
		699.7	24	23.25	0	22.21	1	
	3RB High (3)	715.3	24	23.01	0	22.10	1	
		707.5	24	23.28	0	22.41	1	
		699.7	24	23.20	0	22.15	1	
	3RB Middle (1)	715.3	24	23.33	0	22.17	1	
		707.5	24	23.36	0	22.29	1	
		699.7	24	23.38	0	22.12	1	
	3RB Low (0)	715.3	24	23.24	0	22.12	1	
		707.5	24	23.28	0	22.34	1	
		699.7	24	23.43	0	22.14	1	
	6RB (0)	715.3	24	22.24	1	21.37	2	
		707.5	24	22.28	1	21.34	2	
		699.7	24	22.42	1	21.13	2	
	3 MHz	1RB High (14)	714.5	24	23.13	0	22.27	1
			707.5	24	23.35	0	22.33	1
			700.5	24	23.23	0	21.90	1
		1RB Middle (7)	714.5	24	23.39	0	22.37	1
			707.5	24	23.33	0	22.60	1
			700.5	24	23.46	0	22.04	1
1RB Low (0)		714.5	24	23.35	0	22.26	1	
		707.5	24	23.37	0	22.39	1	
		700.5	24	23.27	0	22.51	1	
8RB High (7)		714.5	24	22.19	1	21.20	2	
		707.5	24	22.39	1	21.28	2	
		700.5	24	22.40	1	21.43	2	
8RB Middle (4)		714.5	24	22.36	1	21.20	2	
		707.5	24	22.32	1	21.48	2	
		700.5	24	22.34	1	21.39	2	

	8RB Low (0)	714.5	24	22.36	1	21.10	2	
		707.5	24	22.27	1	21.35	2	
		700.5	24	22.24	1	21.37	2	
	15RB (0)	714.5	24	22.30	1	21.14	2	
		707.5	24	22.34	1	21.24	2	
		700.5	24	22.36	1	21.37	2	
5 MHz	1RB High (24)	713.5	24	23.03	0	21.79	1	
		707.5	24	23.49	0	22.21	1	
		701.5	24	23.05	0	21.70	1	
	1RB Middle (12)	713.5	24	23.34	0	22.33	1	
		707.5	24	23.51	0	21.79	1	
		701.5	24	23.51	0	21.91	1	
	1RB Low (0)	713.5	24	23.40	0	22.17	1	
		707.5	24	23.46	0	21.75	1	
		701.5	24	23.10	0	21.89	1	
	12RB High (13)	713.5	24	22.16	1	21.16	2	
		707.5	24	22.36	1	21.17	2	
		701.5	24	22.32	1	21.11	2	
	12RB Middle (6)	713.5	24	22.24	1	21.45	2	
		707.5	24	22.40	1	21.19	2	
		701.5	24	22.39	1	21.20	2	
	12RB Low (0)	713.5	24	22.33	1	21.37	2	
		707.5	24	22.29	1	21.20	2	
		701.5	24	22.28	1	21.09	2	
	25RB (0)	713.5	24	22.21	1	21.24	2	
		707.5	24	22.40	1	21.43	2	
		701.5	24	22.31	1	21.31	2	
	10 MHz	1RB High (49)	711	24	23.06	0	21.96	1
			707.5	24	23.28	0	22.27	1
			704	24	23.21	0	22.57	1
1RB Middle (24)		711	24	23.57	0	22.52	1	
		707.5	24	23.59	0	22.52	1	
		704	24	23.31	0	21.89	1	
1RB Low (0)		711	24	23.29	0	22.30	1	
		707.5	24	23.29	0	22.35	1	
		704	24	23.33	0	21.71	1	
25RB High (25)		711	24	22.28	1	21.49	2	
		707.5	24	22.39	1	21.43	2	
		704	24	22.38	1	21.47	2	
25RB Middle (12)		711	24	22.41	1	21.53	2	
		707.5	24	22.39	1	21.35	2	
		704	24	22.42	1	21.41	2	
25RB Low (0)		711	24	22.35	1	21.38	2	
		707.5	24	22.36	1	21.21	2	
		704	24	22.31	1	21.29	2	
50RB (0)		711	24	22.33	1	21.40	2	
		707.5	24	22.38	1	21.30	2	
		704	24	22.36	1	21.34	2	

Band 13							
Bandwidth (MHz)	RB allocation	Frequency (MHz)	Max. Target Power (dBm)	QPSK		16QAM	
	RB offset (Start RB)			Actual output power (dBm)	MPR	Actual output power (dBm)	MPR
5 MHz	1RB High (24)	784.5	24	23.01	0	22.01	1
		782	24	22.80	0	21.66	1
		779.5	24	23.31	0	21.82	1
	1RB Middle (12)	784.5	24	23.26	0	21.70	1
		782	24	23.30	0	21.68	1
		779.5	24	23.49	0	22.06	1
	1RB Low (0)	784.5	24	23.11	0	21.45	1
		782	24	22.93	0	21.65	1
		779.5	24	23.07	0	21.77	1
	12RB High (13)	784.5	24	22.08	1	21.04	2
		782	24	22.15	1	21.07	2
		779.5	24	22.24	1	21.19	2
	12RB Middle (6)	784.5	24	22.19	1	20.95	2
		782	24	22.15	1	21.07	2
		779.5	24	22.14	1	21.19	2
	12RB Low (0)	784.5	24	22.05	1	20.81	2
		782	24	22.04	1	21.14	2
		779.5	24	22.22	1	21.07	2
	25RB (0)	784.5	24	22.09	1	21.32	2
		782	24	22.13	1	21.00	2
		779.5	24	22.25	1	21.22	2
10 MHz	1RB High (49)	782	24	23.16	0	22.18	1
	1RB Middle (24)	782	24	23.26	0	22.39	1
	1RB Low (0)	782	24	23.27	0	22.32	1
	25RB High (25)	782	24	22.11	1	20.93	2
	25RB Middle (12)	782	24	22.19	1	20.98	2
	25RB Low (0)	782	24	22.06	1	21.06	2
	50RB (0)	782	24	22.18	1	21.17	2

Band 66								
Bandwidth (MHz)	RB allocation	Frequency (MHz)	Max. Target Power (dBm)	QPSK		16QAM		
	RB offset (Start RB)			Actual output power (dBm)	MPR	Actual output power (dBm)	MPR	
1.4 MHz	1RB High (5)	1779.3	24	23.55	0	22.51	1	
		1745	24	23.29	0	22.34	1	
		1710.7	24	23.77	0	22.90	1	
	1RB Middle (3)	1779.3	24	23.37	0	22.58	1	
		1745	24	23.40	0	22.43	1	
		1710.7	24	23.80	0	22.91	1	
	1RB Low (0)	1779.3	24	23.49	0	22.56	1	
		1745	24	23.26	0	22.37	1	
		1710.7	24	23.71	0	22.64	1	
	3RB High (3)	1779.3	24	23.25	0	22.51	1	
		1745	24	23.31	0	22.67	1	
		1710.7	24	23.71	0	22.98	1	
	3RB Middle (1)	1779.3	24	23.54	0	22.48	1	
		1745	24	23.40	0	22.63	1	
		1710.7	24	23.64	0	22.81	1	
	3RB Low (0)	1779.3	24	23.17	0	22.42	1	
		1745	24	23.27	0	22.57	1	
		1710.7	24	23.49	0	22.71	1	
	6RB (0)	1779.3	24	22.46	1	21.57	2	
		1745	24	22.34	1	21.27	2	
		1710.7	24	22.43	1	21.51	2	
	3 MHz	1RB High (14)	1778.5	24	23.50	0	22.54	1
			1745	24	23.36	0	22.21	1
			1711.5	24	23.55	0	22.95	1
1RB Middle (7)		1778.5	24	23.04	0	22.60	1	
		1745	24	23.28	0	22.53	1	
		1711.5	24	23.51	0	22.96	1	
1RB Low (0)		1778.5	24	23.07	0	22.57	1	
		1745	24	23.26	0	22.61	1	
		1711.5	24	23.70	0	22.88	1	
8RB High (7)		1778.5	24	22.50	1	21.36	2	
		1745	24	22.35	1	21.66	2	
		1711.5	24	22.63	1	21.84	2	
8RB Middle (4)		1778.5	24	22.32	1	21.40	2	
		1745	24	22.38	1	21.42	2	
		1711.5	24	22.55	1	21.69	2	
8RB Low (0)		1778.5	24	22.34	1	21.58	2	
		1745	24	22.34	1	21.57	2	
		1711.5	24	22.55	1	21.86	2	
15RB (0)		1778.5	24	22.56	1	21.31	2	
		1745	24	22.44	1	21.56	2	
		1711.5	24	22.63	1	21.60	2	

5 MHz	1RB High (24)	1777.5	24	23.25	0	21.91	1
		1745	24	23.25	0	21.76	1
		1712.5	24	23.54	0	22.28	1
	1RB Middle (12)	1777.5	24	23.38	0	21.97	1
		1745	24	23.31	0	21.90	1
		1712.5	24	23.70	0	22.13	1
	1RB Low (0)	1777.5	24	23.21	0	21.93	1
		1745	24	23.20	0	21.77	1
		1712.5	24	23.60	0	21.81	1
	12RB High (13)	1777.5	24	22.46	1	21.58	2
		1745	24	22.41	1	21.37	2
		1712.5	24	22.51	1	21.56	2
	12RB Middle (6)	1777.5	24	22.59	1	21.25	2
		1745	24	22.35	1	21.48	2
		1712.5	24	22.63	1	21.76	2
	12RB Low (0)	1777.5	24	22.37	1	21.47	2
		1745	24	22.39	1	21.38	2
		1712.5	24	22.54	1	21.59	2
	25RB (0)	1777.5	24	22.52	1	21.71	2
		1745	24	22.31	1	21.48	2
		1712.5	24	22.48	1	21.60	2
10 MHz	1RB High (49)	1775	24	23.34	0	22.41	1
		1745	24	23.18	0	22.19	1
		1715	24	23.33	0	22.56	1
	1RB Middle (24)	1775	24	23.33	0	22.48	1
		1745	24	23.47	0	22.47	1
		1715	24	23.63	0	22.93	1
	1RB Low (0)	1775	24	23.39	0	22.47	1
		1745	24	23.66	0	22.24	1
		1715	24	23.56	0	22.76	1
	25RB High (25)	1775	24	22.54	1	21.79	2
		1745	24	22.42	1	21.66	2
		1715	24	22.44	1	21.43	2
	25RB Middle (12)	1775	24	22.63	1	21.42	2
		1745	24	22.47	1	21.61	2
		1715	24	22.58	1	21.66	2
	25RB Low (0)	1775	24	22.53	1	21.68	2
		1745	24	22.39	1	21.52	2
		1715	24	22.58	1	21.50	2
	50RB (0)	1775	24	22.49	1	21.58	2
		1745	24	22.40	1	21.47	2
		1715	24	22.53	1	21.61	2
15 MHz	1RB High (74)	1772.5	24	23.50	0	22.54	1
		1745	24	23.61	0	22.68	1
		1717.5	24	23.31	0	22.75	1
	1RB Middle (37)	1772.5	24	23.69	0	22.62	1
		1717.5	24	23.70	0	22.91	1

	1RB Low (0)	1772.5	24	23.60	0	22.62	1
		1745	24	23.66	0	22.64	1
		1717.5	24	23.55	0	22.76	1
	36RB High (38)	1772.5	24	22.38	1	21.49	2
		1745	24	22.44	1	21.40	2
		1717.5	24	22.59	1	21.46	2
	36RB Middle (19)	1772.5	24	22.59	1	21.42	2
		1745	24	22.51	1	21.47	2
		1717.5	24	22.48	1	21.53	2
	36RB Low (0)	1772.5	24	22.38	1	21.39	2
		1745	24	22.41	1	21.39	2
		1717.5	24	22.55	1	21.47	2
	75RB (0)	1772.5	24	22.42	1	21.54	2
		1745	24	22.31	1	21.35	2
		1717.5	24	22.42	1	21.50	2
20 MHz	1RB High (99)	1770	24	23.14	0	22.29	1
		1745	24	22.95	0	22.73	1
		1720	24	23.29	0	22.73	1
	1RB Middle (50)	1770	24	23.55	0	22.88	1
		1745	24	23.01	0	22.97	1
		1720	24	23.80	0	22.93	1
	1RB Low (0)	1770	24	23.05	0	22.23	1
		1745	24	22.97	0	22.69	1
		1720	24	23.37	0	22.34	1
	50RB High (50)	1770	24	22.36	1	21.37	2
		1745	24	22.27	1	21.36	2
		1720	24	22.49	1	21.52	2
	50RB Middle (25)	1770	24	22.35	1	21.34	2
		1745	24	22.34	1	21.42	2
		1720	24	22.47	1	21.54	2
	50RB Low (0)	1770	24	22.35	1	21.39	2
		1745	24	22.34	1	21.37	2
		1720	24	22.40	1	21.61	2
	100RB (0)	1770	24	22.24	1	21.32	2
		1745	24	22.27	1	21.25	2
		1720	24	22.37	1	21.34	2



11.4 Wi-Fi and BT Measurement result

The output power of BT antenna is as following:

Mode	Conducted Power (dBm)		
	Channel 0 (2402MHz)	Channel 39 (2441MHz)	Channel 78(2480MHz)
GFSK	7.95	8.82	7.39
Tune up	9.5	9.5	9
EDR2M-4_DQPSK	8.63	9.32	8.25
Tune up	9.5	9.8	9.5
EDR3M-8DPSK	9.06	9.57	8.48
Tune up	9.5	9.8	9.5

The average conducted power for Wi-Fi is as following:
802.11b (dBm)

Channel\data rate	1Mbps	2Mbps	5.5Mbps	11Mbps
1	18.75	/	/	/
6	19.53	19.25	19.24	18.88
11	19.34	/	/	/
Tune up	20	20	20	20

802.11g (dBm)

Channel\data rate	6Mbps	9Mbps	12Mbps	18Mbps	24Mbps	36Mbps	48Mbps	54Mbps
1	14.17	/	/	/	/	/	/	/
6	14.63	/	/	/	/	/	/	/
11	14.83	14.54	14.43	14.15	13.76	13.28	12.82	12.59
Tune up	15.5	15.5	15.5	15.5	15.5	15	14.5	14

802.11n (dBm) - HT20 (2.4G)

Channel\data rate	MCS0	MCS1	MCS2	MCS3	MCS4	MCS5	MCS6	MCS7
1	12.37	/	/	/	/	/	/	/
6	12.61	/	/	/	/	/	/	/
11	12.95	12.44	12.13	11.87	11.28	10.89	10.72	10.54
Tune up	13.5	13.5	13.5	13.5	13	12.5	12.5	12

12 Simultaneous TX SAR Considerations

12.1 Introduction

The following procedures adopted from “FCC SAR Considerations for Cell Phones with Multiple Transmitters” are applicable to handsets with built-in unlicensed transmitters such as 802.11 a/b/g and Bluetooth devices which may simultaneously transmit with the licensed transmitter.

For this device, the BT and Wi-Fi can transmit simultaneous with other transmitters.

12.2 Transmit Antenna Separation Distances

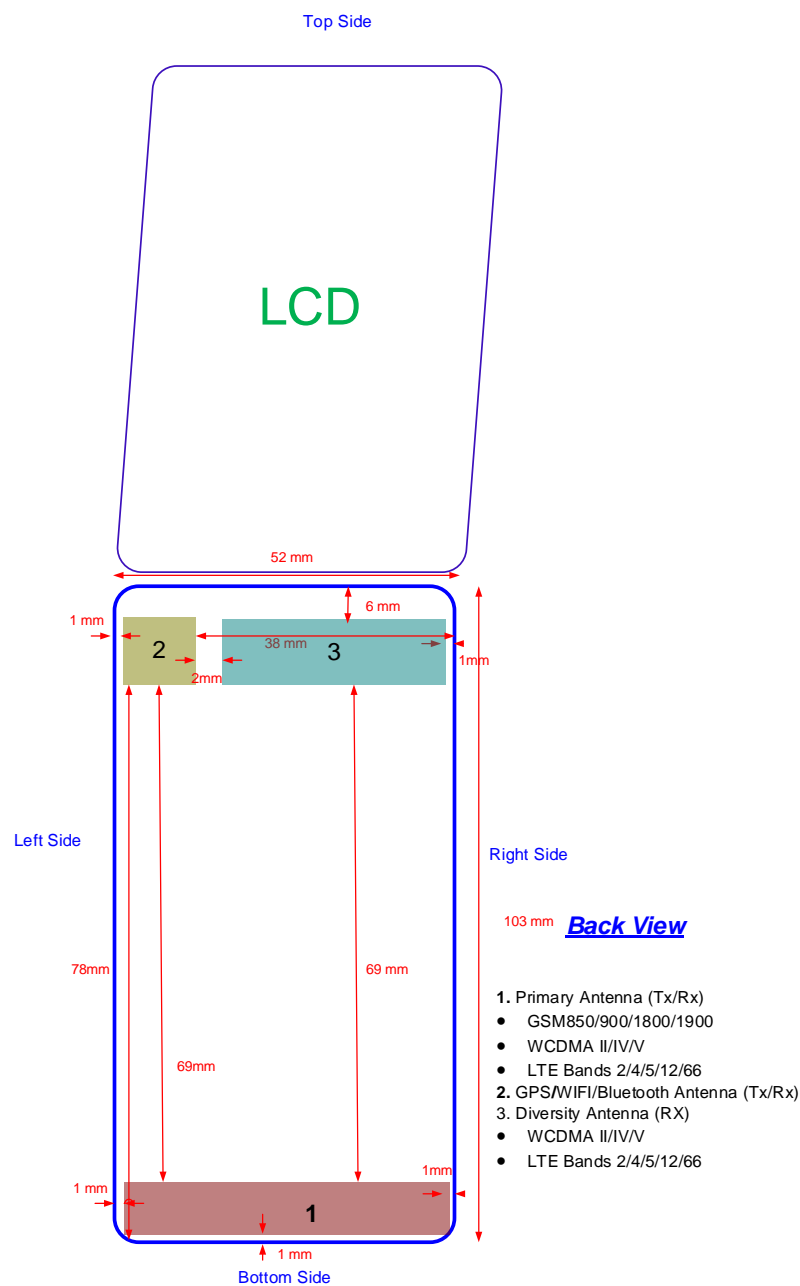

Picture 12.1 Antenna Locations

12.3 Standalone SAR Test Exclusion Considerations

Standalone 1-g head or body SAR evaluation by measurement or numerical simulation is not required when the corresponding SAR Exclusion Threshold condition, listed below, is satisfied. The 1-g SAR test exclusion threshold for 100 MHz to 6 GHz at test separation distances ≤ 50 mm are determined by:

$[(\text{max. power of channel, including tune-up tolerance, mW}) / (\text{min. test separation distance, mm})] \cdot [\sqrt{f(\text{GHz})}] \leq 3.0$ for 1-g SAR, where

- $f(\text{GHz})$ is the RF channel transmit frequency in GHz
- Power and distance are rounded to the nearest mW and mm before calculation
- The result is rounded to one decimal place for comparison

Table 12.1: Standalone SAR test exclusion considerations

Band/Mode	F(GHz)	Position	SAR test exclusion threshold(mW)	RF output power		SAR test exclusion
				dBm	mW	
Bluetooth	2.441	Head	9.60	9.8	9.55	Yes
		Body	19.20	9.8	9.55	Yes
2.4GHz WLAN	2.45	Head	9.58	20	100	No
		Body	19.17	20	100	No

13 Evaluation of Simultaneous

Table 13.1: The sum of reported SAR values for main antenna and WiFi

	Position	Main antenna	WiFi	Sum
Highest reported SAR value for Head	Right hand, Touch cheek	1.08	0.30	1.38
Highest reported SAR value for Body	Rear fold	1.21	0.06	1.27
	Rear unfold	0.76	0.10	0.86

Table 13.2: The sum of reported SAR values for main antenna and BT

	Position	Main antenna	BT	Sum
Maximum reported SAR value for Head	Right hand, Touch cheek	1.08	0.40 ^[1]	1.48
Maximum reported SAR value for Body	Rear fold	1.21	0.20 ^[1]	1.41

[1] - Estimated SAR for Bluetooth (see the table 13.3)

Table 13.3: Estimated SAR for Bluetooth

Mode/Band	F (GHz)	Position	Distance (mm)	Upper limit of power *		Estimated _{1g} (W/kg)
				dBm	mW	
Bluetooth	2.441	Head	5	9.8	9.55	0.40
Bluetooth	2.441	Body	10	9.8	9.55	0.20

* - Maximum possible output power declared by manufacturer

When standalone SAR test exclusion applies to an antenna that transmits simultaneously with other antennas, the standalone SAR must be estimated according to following to determine simultaneous transmission SAR test exclusion:

$(\text{max. power of channel, including tune-up tolerance, mW}) / (\text{min. test separation distance, mm}) \cdot [\sqrt{f(\text{GHz})} / x]$ W/kg for test separation distances ≤ 50 mm;
where $x = 7.5$ for 1-g SAR.

When the minimum test separation distance is < 5 mm, a distance of 5 mm is applied to determine SAR test exclusion

Conclusion:

According to the above tables, the sum of reported SAR values is < 1.6 W/kg. So the simultaneous transmission SAR with volume scans is not required.

14 SAR Test Result

It is determined by user manual for the distance between the EUT and the phantom bottom.
The distance is 15mm and just applied to the condition of body worn accessory.

It is performed for all SAR measurements with area scan based 1-g SAR estimation (Fast SAR). A zoom scan measurement is added when the estimated 1-gSAR is the highest measured SAR in each exposure configuration, wireless mode and frequency band combination or more than 1.2W/kg.

The calculated SAR is obtained by the following formula:

$$\text{Reported SAR} = \text{Measured SAR} \times 10^{(P_{\text{Target}} - P_{\text{Measured}})/10}$$

Where P_{Target} is the power of manufacturing upper limit;

P_{Measured} is the measured power in chapter 11.

Table 14.1: Duty Cycle

Mode	Duty Cycle
Speech for GSM850/1900	1:8.3
GPRS&EGPRS for GSM850	1:2.67
GPRS&EGPRS for GSM1900	1:2
WCDMA<E FDD	1:1

14.1 SAR results for Fast SAR

Table 14.1-1: SAR Values (GSM 850 MHz Band - Head)

Frequency		Side	Test Position	Figure No./ Note	Conducted Power (dBm)	Max. tune-up Power (dBm)	Measured SAR(10g) (W/kg)	Reported SAR(10g) (W/kg)	Measured SAR(1g) (W/kg)	Reported SAR(1g) (W/kg)	Power Drift (dB)
Ch.	MHz										
Ambient Temperature: 22.9 °C Liquid Temperature: 22.5 °C											
251	848.8	Left	Touch	/	32.62	33.2	0.452	0.52	0.691	0.79	0.03
190	836.6	Left	Touch	/	32.48	33.2	0.482	0.57	0.736	0.87	0.05
128	824.2	Left	Touch	/	32.39	33.2	0.468	0.56	0.715	0.86	0.06
190	836.6	Left	Tilt	/	32.48	33.2	0.231	0.27	0.335	0.40	-0.03
251	848.8	Right	Touch	/	32.62	33.2	0.548	0.63	0.867	0.99	0.01
190	836.6	Right	Touch	Fig.1	32.48	33.2	0.583	0.69	0.919	1.08	-0.05
128	824.2	Right	Touch	/	32.39	33.2	0.569	0.69	0.898	1.08	0.08
190	836.6	Right	Tilt	/	32.48	33.2	0.278	0.33	0.401	0.47	-0.10

Table 14.1-2: SAR Values (GSM 850 MHz Band - Body)

Frequency		Mode (number of timeslots)	Test Position	Figure No./ Note	Conducted Power (dBm)	Max. tune-up Power (dBm)	Measured SAR(10g) (W/kg)	Reported SAR(10g) (W/kg)	Measured SAR(1g) (W/kg)	Reported SAR(1g) (W/kg)	Power Drift (dB)
Ch.	MHz										
Ambient Temperature: 22.9 °C Liquid Temperature: 22.5 °C											
190	836.6	GPRS (3)	Front fold	/	29.35	29.7	0.175	0.19	0.222	0.24	0.07
251	848.8	GPRS (3)	Rear fold	/	29.25	29.7	0.569	0.63	0.805	0.89	-0.03
190	836.6	GPRS (3)	Rear fold	Fig.2	29.32	29.7	0.579	0.63	0.811	0.89	-0.15
128	824.2	GPRS (3)	Rear fold	/	29.54	29.7	0.565	0.59	0.791	0.82	0.06
190	836.6	GPRS (3)	Rear unfold	/	29.35	29.7	0.287	0.31	0.457	0.50	0.12
190	836.6	EGPRS (3)	Rear fold	/	29.24	29.7	0.566	0.63	0.799	0.89	0.04

Note: The distance between the EUT and the phantom bottom is 15mm.

Table 14.1-3: SAR Values (GSM 1900 MHz Band - Head)

Frequency		Side	Test Position	Figure No./ Note	Conducted Power (dBm)	Max. tune-up Power (dBm)	Measured SAR(10g) (W/kg)	Reported SAR(10g) (W/kg)	Measured SAR(1g) (W/kg)	Reported SAR(1g) (W/kg)	Power Drift (dB)
Ch.	MHz										
Ambient Temperature: 22.9 °C Liquid Temperature: 22.5 °C											
810	1909.8	Left	Touch	/	30.05	30.7	0.365	0.42	0.511	0.59	0.12
661	1880	Left	Touch	/	30.10	30.7	0.396	0.45	0.555	0.64	0.04
512	1850.2	Left	Touch	Fig.3	30.08	30.7	0.398	0.46	0.574	0.66	-0.05
661	1880	Left	Tilt	/	30.10	30.7	0.063	0.07	0.087	0.10	0.03
661	1880	Right	Touch	/	30.10	30.7	0.199	0.23	0.305	0.35	0.12
661	1880	Right	Tilt	/	30.10	30.7	0.070	0.08	0.093	0.11	0.14

Table 14.1-4: SAR Values (GSM 1900 MHz Band - Body)

Frequency		Mode (number of timeslots)	Test Position	Figure No./ Note	Conducted Power (dBm)	Max. tune-up Power (dBm)	Measured SAR(10g) (W/kg)	Reported SAR(10g) (W/kg)	Measured SAR(1g) (W/kg)	Reported SAR(1g) (W/kg)	Power Drift (dB)
Ch.	MHz										
Ambient Temperature: 22.9 °C						Liquid Temperature: 22.5 °C					
661	1880	GPRS (4)	Front fold	/	24.94	25.2	0.064	0.07	0.100	0.11	0.09
810	1909.8	GPRS (4)	Rear fold	Fig.4	24.99	25.2	0.260	0.27	0.425	0.45	0.03
661	1880	GPRS (4)	Rear fold	/	24.94	25.2	0.229	0.24	0.368	0.39	0.14
512	1850.2	GPRS (4)	Rear fold	/	24.93	25.2	0.247	0.26	0.390	0.42	-0.05
661	1880	GPRS (4)	Rear unfold	/	24.94	25.2	0.126	0.13	0.199	0.21	0.11
810	1909.8	EGPRS (4)	Rear fold	/	24.90	25.2	0.246	0.26	0.417	0.45	0.02

Note: The distance between the EUT and the phantom bottom is 15mm.

Table 14.1-5: SAR Values (WCDMA 850 MHz Band - Head)

Frequency		Side	Test Position	Figure No./ Note	Conducted Power (dBm)	Max. tune-up Power (dBm)	Measured SAR(10g) (W/kg)	Reported SAR(10g) (W/kg)	Measured SAR(1g) (W/kg)	Reported SAR(1g) (W/kg)	Power Drift (dB)
Ch.	MHz										
Ambient Temperature: 22.9 °C						Liquid Temperature: 22.5 °C					
4182	836.4	Left	Touch	/	23.23	23.7	0.272	0.30	0.360	0.40	-0.01
4182	836.4	Left	Tilt	/	23.23	23.7	0.142	0.16	0.180	0.20	0.09
4233	846.6	Right	Touch	/	23.15	23.7	0.305	0.35	0.447	0.51	0.01
4182	836.4	Right	Touch	/	23.23	23.7	0.316	0.35	0.495	0.55	0.06
4132	826.4	Right	Touch	Fig.5	23.14	23.7	0.349	0.40	0.547	0.62	0.01
4182	836.4	Right	Tilt	/	23.23	23.7	0.152	0.17	0.189	0.21	0.02

Table 14.1-6: SAR Values (WCDMA 850 MHz Band - Body)

Frequency		Test Position	Figure No./ Note	Conducted Power (dBm)	Max. tune-up Power (dBm)	Measured SAR(10g) (W/kg)	Reported SAR(10g) (W/kg)	Measured SAR(1g) (W/kg)	Reported SAR(1g) (W/kg)	Power Drift (dB)	
Ch.	MHz										
Ambient Temperature: 22.9 °C						Liquid Temperature: 22.5 °C					
4182	836.4	Front fold	/	23.23	23.7	0.108	0.12	0.139	0.15	0.03	
4233	846.6	Rear fold	/	23.15	23.7	0.330	0.37	0.469	0.53	0.03	
4182	836.4	Rear fold	Fig.6	23.23	23.7	0.338	0.38	0.475	0.53	0.11	
4132	826.4	Rear fold	/	23.14	23.7	0.337	0.38	0.460	0.52	0.03	
4182	836.4	Rear unfold	/	23.23	23.7	0.186	0.21	0.296	0.33	0.06	

Note: The distance between the EUT and the phantom bottom is 15mm.

Table 14.1-7: SAR Values (WCDMA 1700 MHz Band - Head)

Frequency		Side	Test Position	Figure No./Note	Conducted Power (dBm)	Max. tune-up Power (dBm)	Measured SAR(10g) (W/kg)	Reported SAR(10g) (W/kg)	Measured SAR(1g) (W/kg)	Reported SAR(1g) (W/kg)	Power Drift (dB)
Ch.	MHz										
Ambient Temperature: 22.9 °C Liquid Temperature: 22.5 °C											
1513	1752.6	Left	Touch	/	23.30	23.7	0.175	0.19	0.297	0.33	0.02
1412	1732.4	Left	Touch	Fig.7	23.25	23.7	0.215	0.24	0.339	0.38	0.13
1312	1712.4	Left	Touch	/	23.21	23.7	0.193	0.22	0.317	0.35	0.08
1412	1732.4	Left	Tilt	/	23.25	23.7	0.063	0.07	0.095	0.11	0.14
1412	1732.4	Right	Touch	/	23.25	23.7	0.196	0.22	0.290	0.32	0.09
1412	1732.4	Right	Tilt	/	23.25	23.7	0.075	0.08	0.107	0.12	0.07

Table 14.1-8: SAR Values (WCDMA 1700 MHz Band - Body)

Frequency		Test Position	Figure No./Note	Conducted Power (dBm)	Max. tune-up Power (dBm)	Measured SAR(10g) (W/kg)	Reported SAR(10g) (W/kg)	Measured SAR(1g) (W/kg)	Reported SAR(1g) (W/kg)	Power Drift (dB)
Ch.	MHz									
Ambient Temperature: 22.9 °C Liquid Temperature: 22.5 °C										
1412	1732.4	Front fold	/	23.25	23.7	0.224	0.25	0.362	0.40	0.09
1513	1752.6	Rear fold	Fig.8	23.30	23.7	0.671	0.74	1.10	1.21	-0.01
1412	1732.4	Rear fold	/	23.25	23.7	0.621	0.69	1.01	1.12	0.02
1312	1712.4	Rear fold	/	23.21	23.7	0.593	0.66	0.969	1.08	-0.05
1412	1732.4	Rear unfold	/	23.25	23.7	0.426	0.47	0.682	0.76	0.14

Note1: The distance between the EUT and the phantom bottom is 15mm.

Table 14.1-9: SAR Values (WCDMA 1900 MHz Band - Head)

Frequency		Side	Test Position	Figure No./Note	Conducted Power (dBm)	Max. tune-up Power (dBm)	Measured SAR(10g) (W/kg)	Reported SAR(10g) (W/kg)	Measured SAR(1g) (W/kg)	Reported SAR(1g) (W/kg)	Power Drift (dB)
Ch.	MHz										
Ambient Temperature: 22.9 °C Liquid Temperature: 22.5 °C											
9938	1907.6	Left	Touch	/	23.13	23.7	0.490	0.56	0.713	0.81	0.08
9800	1880	Left	Touch	Fig.9	23.22	23.7	0.504	0.56	0.741	0.83	0.02
9662	1852.4	Left	Touch	/	23.11	23.7	0.495	0.57	0.728	0.83	0.04
9800	1880	Left	Tilt	/	23.22	23.7	0.087	0.10	0.117	0.13	0.06
9800	1880	Right	Touch	/	23.22	23.7	0.230	0.26	0.338	0.38	0.11
9800	1880	Right	Tilt	/	23.22	23.7	0.075	0.08	0.099	0.11	0.13

Table 14.1-10: SAR Values (WCDMA 1900 MHz Band - Body)

Frequency		Test Position	Figure No./ Note	Conducted Power (dBm)	Max. tune-up Power (dBm)	Measured SAR(10g) (W/kg)	Reported SAR(10g) (W/kg)	Measured SAR(1g) (W/kg)	Reported SAR(1g) (W/kg)	Power Drift (dB)
Ch.	MHz									
Ambient Temperature: 22.9 °C Liquid Temperature: 22.5 °C										
9800	1880	Front fold	/	23.22	23.7	0.098	0.11	0.147	0.16	0.02
9938	1907.6	Rear fold	Fig.10	23.13	23.7	0.363	0.41	0.597	0.68	0.14
9800	1880	Rear fold	/	23.22	23.7	0.317	0.35	0.519	0.58	0.08
9662	1852.4	Rear fold	/	23.11	23.7	0.358	0.41	0.581	0.67	0.11
9800	1880	Rear unfold	/	23.22	23.7	0.097	0.11	0.147	0.16	0.06

Note1: The distance between the EUT and the phantom bottom is 15mm.

Table 14.1-11: SAR Values (LTE Band2 - Head)

Frequency		Mode	Side	Test Position	Figure No./ Note	Conducted Power (dBm)	Max. tune-up Power (dBm)	Measured SAR(10g) (W/kg)	Reported SAR(10g) (W/kg)	Measured SAR(1g) (W/kg)	Reported SAR(1g) (W/kg)	Power Drift (dB)
Ch.	MHz											
Ambient Temperature: 22.9 °C Liquid Temperature: 22.5 °C												
18900	1880	1RB_High	Left	Touch	Fig.11	23.56	24	0.163	0.18	0.240	0.27	0.06
18900	1880	1RB_High	Left	Tilt	/	23.56	24	0.028	0.03	0.040	0.04	0.09
18900	1880	1RB_High	Right	Touch	/	23.56	24	0.074	0.08	0.122	0.14	0.02
18900	1880	1RB_High	Right	Tilt	/	23.56	24	0.027	0.03	0.036	0.04	-0.11
19100	1900	50RB_Low	Left	Touch	/	22.43	23	0.133	0.15	0.198	0.23	0.05
19100	1900	50RB_Low	Left	Tilt	/	22.43	23	0.027	0.03	0.035	0.04	0.18
19100	1900	50RB_Low	Right	Touch	/	22.43	23	0.064	0.07	0.104	0.12	0.02
19100	1900	50RB_Low	Right	Tilt	/	22.43	23	0.022	0.03	0.030	0.03	0.07

Note1: The LTE mode is QPSK_20MHz.

Table 14.1-12: SAR Values (LTE Band2 - Body)

Frequency		Mode	Test Position	Figure No./ Note	Conducted Power (dBm)	Max. tune-up Power (dBm)	Measured SAR(10g) (W/kg)	Reported SAR(10g) (W/kg)	Measured SAR(1g) (W/kg)	Reported SAR(1g) (W/kg)	Power Drift (dB)
Ch.	MHz										
Ambient Temperature: 22.9 °C Liquid Temperature: 22.5 °C											
18900	1880	1RB_High	Front fold	/	23.56	24	0.101	0.11	0.160	0.18	0.05
18900	1880	1RB_High	Rear fold	Fig.12	23.56	24	0.366	0.41	0.587	0.65	0.10
18900	1880	1RB_High	Rear unfold	/	23.56	24	0.302	0.33	0.463	0.51	0.09
19100	1900	50RB_Low	Front fold	/	22.43	23	0.088	0.10	0.140	0.16	0.14
19100	1900	50RB_Low	Rear fold	/	22.43	23	0.300	0.34	0.496	0.57	0.06
19100	1900	50RB_Low	Rear unfold	/	22.43	23	0.279	0.32	0.436	0.50	-0.07

Note1: The distance between the EUT and the phantom bottom is 15mm.

Note2: The LTE mode is QPSK_20MHz.

Table 14.1-13: SAR Values (LTE Band5 - Head)

Ambient Temperature: 22.9°C							Liquid Temperature: 22.5°C					
Frequency		Mode	Side	Test Position	Figure No.	Conducted Power (dBm)	Max. tune-up Power (dBm)	Measured SAR(10g) (W/kg)	Reported SAR(10g) (W/kg)	Measured SAR(1g) (W/kg)	Reported SAR(1g) (W/kg)	Power Drift (dB)
Ch.	MHz											
20600	844	1RB_Mid	Left	Touch	/	23.60	24	0.313	0.34	0.459	0.50	0.07
20600	844	1RB_Mid	Left	Tilt	/	23.60	24	0.146	0.16	0.202	0.22	0.01
20600	844	1RB_Mid	Right	Touch	Fig.13	23.60	24	0.368	0.40	0.556	0.61	-0.01
20600	844	1RB_Mid	Right	Tilt	/	23.60	24	0.158	0.17	0.217	0.24	0.08
20450	829	25RB_Mid	Left	Touch	/	22.58	23	0.286	0.32	0.415	0.46	-0.06
20450	829	25RB_Mid	Left	Tilt	/	22.58	23	0.141	0.16	0.197	0.22	0.12
20450	829	25RB_Mid	Right	Touch	/	22.58	23	0.350	0.39	0.528	0.58	0.07
20450	829	25RB_Mid	Right	Tilt	/	22.58	23	0.164	0.18	0.225	0.25	0.03

Note1: The LTE mode is QPSK_10MHz.

Table 14.1-14: SAR Values (LTE Band5 - Body)

Ambient Temperature: 22.9°C							Liquid Temperature: 22.5°C					
Frequency		Mode	Test Position	Figure No.	Conducted Power (dBm)	Max. tune-up Power (dBm)	Measured SAR(10g) (W/kg)	Reported SAR(10g) (W/kg)	Measured SAR(1g) (W/kg)	Reported SAR(1g) (W/kg)	Power Drift (dB)	
Ch.	MHz											
20600	844	1RB_Mid	Front fold	/	23.60	24	0.105	0.12	0.138	0.15	0.06	
20600	844	1RB_Mid	Rear fold	Fig.14	23.60	24	0.369	0.40	0.525	0.58	0.15	
20600	844	1RB_Mid	Rear unfold	/	23.60	24	0.171	0.19	0.266	0.29	-0.09	
20450	829	25RB_Mid	Front fold	/	22.58	23	0.092	0.10	0.114	0.13	0.08	
20450	829	25RB_Mid	Rear fold	/	22.58	23	0.262	0.29	0.348	0.38	0.03	
20450	829	25RB_Mid	Rear unfold	/	22.58	23	0.164	0.18	0.222	0.24	0.06	

Note1: The distance between the EUT and the phantom bottom is 15mm. Note2: The LTE mode is QPSK_10MHz.

Table 14.1-15: SAR Values (LTE Band12 - Head)

Ambient Temperature: 22.9°C							Liquid Temperature: 22.5°C					
Frequency		Mode	Side	Test Position	Figure No./ Note	Conducted Power (dBm)	Max. tune-up Power (dBm)	Measured SAR(10g) (W/kg)	Reported SAR(10g) (W/kg)	Measured SAR(1g) (W/kg)	Reported SAR(1g) (W/kg)	Power Drift (dB)
Ch.	MHz											
23095	707.5	1RB_Mid	Left	Touch	/	23.59	24	0.125	0.14	0.188	0.21	0.03
23095	707.5	1RB_Mid	Left	Tilt	/	23.59	24	0.053	0.06	0.070	0.08	0.02
23095	707.5	1RB_Mid	Right	Touch	Fig.15	23.59	24	0.170	0.19	0.250	0.27	0.03
23095	707.5	1RB_Mid	Right	Tilt	/	23.59	24	0.065	0.07	0.088	0.10	0.01
23060	704	25RB_Mid	Left	Touch	/	22.42	23	0.088	0.10	0.134	0.15	0.18
23060	704	25RB_Mid	Left	Tilt	/	22.42	23	0.034	0.04	0.044	0.05	0.06
23060	704	25RB_Mid	Right	Touch	/	22.42	23	0.140	0.16	0.207	0.24	0.09
23060	704	25RB_Mid	Right	Tilt	/	22.42	23	0.048	0.05	0.066	0.08	-0.03

Note1: The LTE mode is QPSK_10MHz.

Table 14.1-16: SAR Values (LTE Band12 - Body)

Ambient Temperature: 22.9 °C						Liquid Temperature: 22.5 °C					
Frequency		Mode	Test Position	Figure No./ Note	Conducted Power (dBm)	Max. tune-up Power (dBm)	Measured SAR(10g) (W/kg)	Reported SAR(10g) (W/kg)	Measured SAR(1g) (W/kg)	Reported SAR(1g) (W/kg)	Power Drift (dB)
Ch.	MHz										
23095	707.5	1RB_Mid	Front fold	/	23.59	24	0.056	0.06	0.072	0.08	0.06
23095	707.5	1RB_Mid	Rear fold	Fig.16	23.59	24	0.234	0.26	0.315	0.35	0.05
23095	707.5	1RB_Mid	Rear unfold	/	23.59	24	0.201	0.22	0.273	0.30	0.01
23060	704	25RB_Mid	Front fold	/	22.42	23	0.040	0.05	0.050	0.06	0.16
23060	704	25RB_Mid	Rear fold	/	22.42	23	0.174	0.20	0.232	0.27	0.03
23060	704	25RB_Mid	Rear unfold	/	22.42	23	0.170	0.19	0.234	0.27	-0.08

Note1: The distance between the EUT and the phantom bottom is 15mm.

Note2: The LTE mode is QPSK_10MHz.

Table 14.1-17: SAR Values (LTE Band13 - Head)

Ambient Temperature: 22.9 °C						Liquid Temperature: 22.5 °C						
Frequency		Mode	Side	Test Position	Figure No./ Note	Conducted Power (dBm)	Max. tune-up Power (dBm)	Measured SAR(10g) (W/kg)	Reported SAR(10g) (W/kg)	Measured SAR(1g) (W/kg)	Reported SAR(1g) (W/kg)	Power Drift (dB)
Ch.	MHz											
23230	782	1RB_Low	Left	Touch	/	23.27	24	0.293	0.35	0.418	0.49	0.08
23230	782	1RB_Low	Left	Tilt	/	23.27	24	0.138	0.16	0.182	0.22	0.12
23230	782	1RB_Low	Right	Touch	Fig.17	23.27	24	0.355	0.42	0.516	0.61	-0.19
23230	782	1RB_Low	Right	Tilt	/	23.27	24	0.145	0.17	0.185	0.22	-0.03
23230	782	25RB_Mid	Left	Touch	/	22.19	23	0.243	0.29	0.345	0.42	0.09
23230	782	25RB_Mid	Left	Tilt	/	22.19	23	0.119	0.14	0.154	0.19	0.01
23230	782	25RB_Mid	Right	Touch	/	22.19	23	0.292	0.35	0.424	0.51	0.19
23230	782	25RB_Mid	Right	Tilt	/	22.19	23	0.130	0.16	0.166	0.20	0.03

Note1: The LTE mode is QPSK_10MHz.

Table 14.1-18: SAR Values (LTE Band13 - Body)

Ambient Temperature: 22.9 °C						Liquid Temperature: 22.5 °C					
Frequency		Mode	Test Position	Figure No./ Note	Conducted Power (dBm)	Max. tune-up Power (dBm)	Measured SAR(10g) (W/kg)	Reported SAR(10g) (W/kg)	Measured SAR(1g) (W/kg)	Reported SAR(1g) (W/kg)	Power Drift (dB)
Ch.	MHz										
23230	782	1RB_Low	Front fold	/	23.27	24	0.100	0.12	0.129	0.15	0.09
23230	782	1RB_Low	Rear fold	Fig.18	23.27	24	0.242	0.29	0.329	0.39	0.02
23230	782	1RB_Low	Rear unfold	/	23.27	24	0.212	0.25	0.321	0.38	0.12
23230	782	25RB_Mid	Front fold	/	22.19	23	0.084	0.10	0.107	0.13	-0.15
23230	782	25RB_Mid	Rear fold	/	22.19	23	0.223	0.27	0.304	0.37	0.03
23230	782	25RB_Mid	Rear unfold	/	22.19	23	0.185	0.22	0.268	0.32	0.08

Note1: The distance between the EUT and the phantom bottom is 15mm.

Note2: The LTE mode is QPSK_10MHz.