



# SAR TEST REPORT

No. I17Z61036-SEM02

For

**TCL Communication Ltd.**

**GSM Quad-band/HSPA-UMTS Six-band/LTE 19-band mobile phone**

**Modelname: BBD100-1**

With

**Hardware Version: 04**

**Software Version: AAN966**

**FCC ID: 2ACCJN019**

**Issued Date:2017-9-21**



**Note:**

The test results in this test report relate only to the devices specified in this report. This report shall not be reproduced except in full without the written approval of CTTL.

The report must not be used by the client to claim product certification, approval, or endorsement by NVLAP, NIST, or any agency of the U.S. Government.

**Test Laboratory:**

CTTL, Telecommunication Technology Labs, CAICT

No.51, Xueyuan Road, Haidian District, Beijing, P. R. China 100191.

Tel:+86(0)10-62304633-2512,Fax:+86(0)10-62304633-2504

Email:[ctl\\_terminals@caict.ac.cn](mailto:ctl_terminals@caict.ac.cn), website:[www.caict.ac.cn](http://www.caict.ac.cn)



## **REPORT HISTORY**

<b>Report Number</b>	<b>Revision</b>	<b>Issue Date</b>	<b>Description</b>
I17Z61036-SEM02	Rev.0	2017-9-7	Initial creation of test report
I17Z61036-SEM02	Rev.1	2017-9-18	Update the power table of LTE CA on page 63
I17Z61036-SEM02	Rev.2	2017-9-21	Remove the test results of LTE B40



## TABLE OF CONTENT

<b>1 TEST LABORATORY .....</b>	<b>5</b>
1.1 TESTING LOCATION .....	5
1.2 TESTING ENVIRONMENT.....	5
1.3 PROJECT DATA .....	5
1.4 SIGNATURE.....	5
<b>2 STATEMENT OF COMPLIANCE .....</b>	<b>6</b>
<b>3 CLIENT INFORMATION.....</b>	<b>8</b>
3.1 APPLICANT INFORMATION .....	8
3.2 MANUFACTURER INFORMATION .....	8
<b>4 EQUIPMENT UNDER TEST (EUT) AND ANCILLARY EQUIPMENT (AE) .....</b>	<b>9</b>
4.1 ABOUT EUT .....	9
4.2 INTERNAL IDENTIFICATION OF EUT USED DURING THE TEST .....	9
4.3 INTERNAL IDENTIFICATION OF AE USED DURING THE TEST.....	9
<b>5 TEST METHODOLOGY .....</b>	<b>10</b>
5.1 APPLICABLE LIMIT REGULATIONS .....	10
5.2 APPLICABLE MEASUREMENT STANDARDS.....	10
<b>6 SPECIFIC ABSORPTION RATE (SAR).....</b>	<b>11</b>
6.1 INTRODUCTION.....	11
6.2 SAR DEFINITION.....	11
<b>7 TISSUE SIMULATING LIQUIDS.....</b>	<b>12</b>
7.1 TARGETS FOR TISSUE SIMULATING LIQUID .....	12
7.2 DIELECTRIC PERFORMANCE .....	13
<b>8 SYSTEM VERIFICATION.....</b>	<b>21</b>
8.1 SYSTEM SETUP.....	21
8.2 SYSTEM VERIFICATION.....	22
<b>9 MEASUREMENT PROCEDURES .....</b>	<b>23</b>
9.1 TESTS TO BE PERFORMED .....	23
9.2 GENERAL MEASUREMENT PROCEDURE.....	24
9.3 WCDMA MEASUREMENT PROCEDURES FOR SAR .....	26
9.4 SAR MEASUREMENT FOR LTE.....	27
9.5 BLUETOOTH & WI-FI MEASUREMENT PROCEDURES FOR SAR .....	29
9.6 POWER DRIFT.....	29
<b>10 AREA SCAN BASED 1-G SAR .....</b>	<b>30</b>
10.1 REQUIREMENT OF KDB.....	30
10.2 FAST SAR ALGORITHMS .....	30
<b>11 CONDUCTED OUTPUT POWER.....</b>	<b>31</b>



11.1 GSM MEASUREMENT RESULT .....	31
11.2 WCDMA MEASUREMENT RESULT.....	33
11.3 LTE MEASUREMENT RESULT .....	34
11.4 WI-FI AND BT MEASUREMENT RESULT .....	61
<b>12 SIMULTANEOUS TX SAR CONSIDERATIONS .....</b>	<b>64</b>
12.1 INTRODUCTION.....	64
12.2 TRANSMIT ANTENNA SEPARATION DISTANCES.....	64
12.3 SAR MEASUREMENT POSITIONS .....	65
12.4 STANDALONE SAR TEST EXCLUSION CONSIDERATIONS .....	65
<b>13 EVALUATION OF SIMULTANEOUS.....</b>	<b>66</b>
<b>14 SAR TEST RESULT.....</b>	<b>67</b>
14.1 SAR RESULTS FOR FAST SAR.....	68
14.2 SAR RESULTS FOR STANDARD PROCEDURE.....	82
14.3 WLAN EVALUATION FOR 2.4G .....	88
14.4 WLAN EVALUATION FOR 5G.....	91
<b>15 SAR MEASUREMENT VARIABILITY.....</b>	<b>96</b>
<b>16 MEASUREMENT UNCERTAINTY .....</b>	<b>98</b>
16.1 MEASUREMENT UNCERTAINTY FOR NORMAL SAR TESTS (300MHZ~3GHZ).....	98
16.2 MEASUREMENT UNCERTAINTY FOR NORMAL SAR TESTS (3~6GHZ) .....	99
16.3 MEASUREMENT UNCERTAINTY FOR FAST SAR TESTS (300MHZ~3GHZ) .....	100
16.4 MEASUREMENT UNCERTAINTY FOR FAST SAR TESTS (3~6GHZ).....	101
<b>17 MAIN TEST INSTRUMENTS .....</b>	<b>102</b>
<b>ANNEX A GRAPH RESULTS.....</b>	<b>103</b>
<b>ANNEX B SYSTEM VERIFICATION RESULTS.....</b>	<b>173</b>
<b>ANNEX C SAR MEASUREMENT SETUP .....</b>	<b>194</b>
<b>ANNEX D POSITION OF THE WIRELESS DEVICE IN RELATION TO THE PHANTOM .....</b>	<b>200</b>
<b>ANNEX E EQUIVALENT MEDIA RECIPES .....</b>	<b>203</b>
<b>ANNEX F SYSTEM VALIDATION .....</b>	<b>204</b>
<b>ANNEX G PROBE CALIBRATION CERTIFICATE .....</b>	<b>205</b>
<b>ANNEX H DIPOLE CALIBRATION CERTIFICATE.....</b>	<b>216</b>
<b>ANNEX I SPOT CHECK.....</b>	<b>281</b>
<b>ANNEX J ACCREDITATION CERTIFICATE.....</b>	<b>315</b>

## 1 Test Laboratory

### 1.1 Testing Location

Company Name:	CTTL(Shouxiang)
Address:	No. 51 Shouxiang Science Building, Xueyuan Road, Haidian District, Beijing, P. R. China100191

### 1.2 Testing Environment

Temperature:	18°C~25°C,
Relative humidity:	30%~ 70%
Ground system resistance:	< 0.5 $\Omega$
Ambient noise & Reflection:	< 0.012 W/kg

### 1.3 Project Data

Project Leader:	Qi Dianyuan
Test Engineer:	Lin Xiaojun
Testing Start Date:	August4, 2017
Testing End Date:	August15, 2017

### 1.4 Signature



---

Lin Xiaojun  
(Prepared this test report)

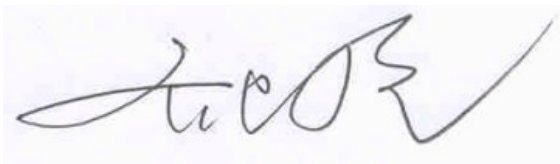

---

Qi Dianyuan  
(Reviewed this test report)

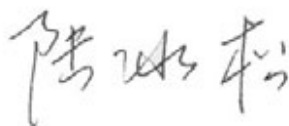

---

Lu Bingsong  
Deputy Director of the laboratory  
(Approved this test report)

## 2 Statement of Compliance

This EUT is a variant product and the report of original sample is No.I17Z60970-SEM01. We share the test results of original sample and do spot check. The results of spot check are presented in the annex I. Remove the LTE B30/66 and add the measurements of LTE B4/26.

The maximum results of SAR found during testing for TCL Communication Ltd.GSMQuad-band/HSPA-UMTS Six-band/LTE 19-band mobile phoneBBD100-1are as follows:

**Table 2.1: Highest Reported SAR(1g)**

Exposure Configuration	Technology Band	Highest Reported SAR1g(W/kg)	Equipment Class
Head (Separation Distance 0mm)	GSM 850	0.63	PCE
	PCS 1900	0.21	
	UMTS FDD 5	0.34	
	UMTS FDD 4	0.26	
	UMTS FDD 2	0.20	
	LTE Band 2	0.17	
	LTE Band 5	0.43	
	LTE Band 7	0.46	
	LTE Band 12	0.18	
	LTE Band 13	0.33	
	LTE Band 38	0.09	
	LTE Band 41	0.08	
	LTE Band 4	0.25	
	LTE Band 26	0.40	
	WLAN 2.4 GHz	1.16	
	WLAN 5 GHz	0.95	UNII
	Hotspot (Separation Distance 10mm)	GSM 850	1.17
PCS 1900		1.04	
UMTS FDD 5		0.78	
UMTS FDD 4		1.11	
UMTS FDD 2		1.26	
LTE Band 2		0.80	
LTE Band 5		0.68	
LTE Band 7		1.09	
LTE Band 12		0.39	
LTE Band 13		0.50	
LTE Band 38		0.70	
LTE Band 41		1.18	
LTE Band 4		1.12	
LTE Band 26		0.78	
WLAN 2.4 GHz		0.53	DTS
WLAN 5 GHz		0.25	UNII

Body-worn (Separation Distance 15mm)	UMTS FDD 4	0.82	PCE
	LTE Band 4	1.03	
	LTE Band 7	0.65	

The SAR values found for the Mobile Phone are below the maximum recommended levels of 1.6 W/Kg as averaged over any 1g tissue according to the ANSI C95.1-1992.

For body operation, this device has been tested and meets FCC RF exposure guidelines when used with any accessory that contains no metal and which provides a minimum separation distance of 10 mm for hotspot and 15mm for body worn between this device and the body of the user. Use of other accessories may not ensure compliance with FCC RF exposure guidelines.

The EUT battery must be fully charged and checked periodically during the test to ascertain uniform power output.

The measurement together with the test system set-up is described in annex C of this test report. A detailed description of the equipment under test can be found in chapter 4 of this test report. The highest reported SAR value is obtained at the case of (**Table 2.1**), and the values are:**1.26W/kg(1g)**.

**Table 2.2: The sum of reported SAR values for main antenna and WiFi**

	Position	Main antenna	WiFi	Sum
<b>Highest reported SAR value for Head</b>	Left hand, Touch cheek	0.42	1.04	<b>1.46</b>
	Left hand, Tilt 15°	0.23	1.16	<b>1.39</b>
	Right hand, Touch cheek	0.63	0.88	<b>1.51</b>
	Right hand, Tilt 15°	0.33	0.95	<b>1.28</b>
<b>Highest reported SAR value for Body</b>	Front	1.26	0.31	<b>1.57</b>
	Top	/	0.53	<b>0.53</b>

Note: we have evaluated and chose the highest value of WiFi 2.4G and 5G in the above table

**Table 2.3: The sum of reported SAR values for main antenna and BT**

	Position	Main antenna	BT	Sum
<b>Maximum reported SAR value for Head</b>	Right hand, Touch cheek	0.63	0.33 <sup>[1]</sup>	<b>0.96</b>
<b>Maximum reported SAR value for Body</b>	Front	1.26	0.17 <sup>[1]</sup>	<b>1.43</b>

[1] - Estimated SAR for Bluetooth (see the table 13.3)

According to the above tables, the highest sum of reported SAR values is **1.57 W/kg (1g)**. The detail for simultaneous transmission consideration is described in chapter 13.

According to the KDB648474 D04, the UMPC mini-tablet procedures must also be applied to test

the SAR of all surfaces and edges with an antenna located at  $\leq 25$  mm from that surface or edge, in direct contact with a flat phantom, for 10-g extremity SAR according to the body-equivalent tissue dielectric parameters in KDB Publication 865664 D01 to address interactive hand use exposure conditions. When hotspot mode applies, 10-g extremity SAR is required only for the surfaces and edges with hotspot mode 1-g reported SAR  $> 1.2$  W/kg

**Table 2.4: 0mm Reported SAR for phablet (10g)**

Exposure Configuration	Technology Band	Highest Reported SAR 10g(W/kg)	Limit 10g (W/kg)
Hotspot (Separation Distance 0mm)	UMTS FDD 2	3.14	4.0
	UMTS FDD 4	3.89	4.0
	LTE Band 4	1.65	4.0
	LTE Band 7	3.00	4.0

### 3 Client Information

#### 3.1 Applicant Information

Company Name:	TCL Communication Ltd.
Address/Post:	5F, C building, No. 232, Liang Jing Road ZhangJiang High-Tech Park, Pudong Area Shanghai, P.R. China. 201203
City:	Shanghai
Country:	China
Contact Person:	Gong Zhizhou
E-mail:	zhizhou.gong@tcl.com
Telephone:	0086-21-31363544
Fax:	0086-21-61460602

#### 3.2 Manufacturer Information

Company Name:	TCL Communication Ltd.
Address/Post:	5F, C building, No. 232, Liang Jing Road ZhangJiang High-Tech Park, Pudong Area Shanghai, P.R. China. 201203
City:	Shanghai
Country:	China
Contact Person:	Gong Zhizhou
E-mail:	zhizhou.gong@tcl.com
Telephone:	0086-21-31363544
Fax:	0086-21-61460602



## 4 Equipment Under Test (EUT) and Ancillary Equipment (AE)

### 4.1 About EUT

Description:	GSMQuad-band/HSPA-UMTS Six-band/LTE 19-band mobile phone
Model name:	BBD100-1
Operating mode(s):	GSM 850/900/1800/1900, UMTS FDD 1/2/4/5/6/8, BT, Wi-Fi LTE Band 1/2/3/4/5/7/8/12/13/17/19/20/26/28/32/38/39/40/41
Tested Tx Frequency:	825 – 848.8 MHz (GSM 850)
	1850.2 – 1910 MHz (GSM 1900)
	826.4–846.6 MHz (WCDMA 850 Band V)
	1712.4 – 1752.6 MHz (WCDMA 1700 Band IV)
	1852.4–1907.6 MHz (WCDMA1900 Band II)
	1860 – 1900 MHz (LTE Band 2)
	824.7 – 848.3 MHz (LTE Band 5)
	2502.5 – 2567.5 MHz (LTE Band 7)
	699.7 – 715.3 MHz (LTE Band 12)
	779.5 –784.5 MHz (LTE Band 13)
	2570 – 2620 MHz (LTE Band 38)
	2498.5 – 2687.5 MHz (LTE Band41)
	1720 – 1745 MHz (LTE Band 4)
	814.7–848.3 MHz (LTE Band 26)
2412 – 2462 MHz (Wi-Fi 2.4G)	
5150-5825 MHz(Wi-Fi 5G)	
GPRS/EGPRS Multislot Class:	12
GPRS capability Class:	B
Test device Production information:	Production unit
Device type:	Portable device
Antenna type:	Integrated antenna
Accessories/Body-wornconfigurations:	Headset
Hotspot mode:	Support
VoIP:	Support
Product Dimension:	L: 155.8mm W: 75.5mm overall diagonal: 173mm

### 4.2 Internal Identification of EUT used during the test

EUT ID*	IMEI	HW	SW Version
EUT1	359265080002666	04	AAN966
EUT2	359265080004290	04	AAN966
EUT3	359265080003581	04	AAN966
EUT4	359265080003847	04	AAN966
EUT5	359265080002948	04	AAN966

\*EUT ID: is used to identify the test sample in the lab internally.

**Note:** It is performed to test SAR with the EUT1&2&3 and conducted power with the EUT4&5.

### 4.3 Internal Identification of AE used during the test

AE ID*	Description	Model	SN	Manufacturer
AE1	Battery	TLp038B1	/	BYD
AE2	Headset	CCB0055A11C1	/	Juwei

\*AE ID: is used to identify the test sample in the lab internally.



## 5 TEST METHODOLOGY

### 5.1 Applicable Limit Regulations

**ANSI C95.1–1992:**IEEE Standard for Safety Levels with Respect to Human Exposure to Radio Frequency Electromagnetic Fields, 3 kHz to 300 GHz.

It specifies the maximum exposure limit of **1.6 W/kg** as averaged over any 1 gram of tissue for portable devices being used within 20 cm of the user in the uncontrolled environment.

### 5.2 Applicable Measurement Standards

**IEEE 1528–2013:** Recommended Practice for Determining the Peak Spatial-Average Specific Absorption Rate (SAR) in the Human Head from Wireless Communications Devices: Measurement Techniques.

**KDB447498 D01: General RF Exposure Guidance v06:** Mobile and Portable Devices RF Exposure Procedures and Equipment Authorization Policies.

**KDB648474 D04 Handset SAR v01r03:** SAR Evaluation Considerations for Wireless Handsets.

**KDB941225 D01 SAR test for 3G devices v03r01:** SAR Measurement Procedures for 3G Devices

**KDB941225 D05 SAR for LTE Devices v02r05:** SAR Evaluation Considerations for LTE Devices

**KDB941225 D06 Hotspot Mode SAR v02r01:** SAR Evaluation Procedures for Portable Devices with Wireless Router Capabilities

**KDB248227 D01 802.11 Wi-Fi SAR v02r02:** SAR GUIDANCE FOR IEEE 802.11 (Wi-Fi) TRANSMITTERS

**KDB865664 D01 SAR measurement 100 MHz to 6 GHz v01r04:** SAR Measurement Requirements for 100 MHz to 6 GHz.

**KDB865664 D02 RF Exposure Reporting v01r02:** RF Exposure Compliance Reporting and Documentation Considerations

## 6 Specific Absorption Rate(SAR)

### 6.1 Introduction

SAR is related to the rate at which energy is absorbed per unit mass in an object exposed to a radio field. The SAR distribution in a biological body is complicated and is usually carried out by experimental techniques or numerical modeling. The standard recommends limits for two tiers of groups, occupational/controlled and general population/uncontrolled, based on a person's awareness and ability to exercise control over his or her exposure. In general, occupational/controlled exposure limits are higher than the limits for general population/uncontrolled.

### 6.2 SAR Definition

The SAR definition is the time derivative (rate) of the incremental energy ( $dW$ ) absorbed by (dissipated in) an incremental mass ( $dm$ ) contained in a volume element ( $dv$ ) of a given density ( $\rho$ ). The equation description is as below:

$$SAR = \frac{d}{dt} \left( \frac{dW}{dm} \right) = \frac{d}{dt} \left( \frac{dW}{\rho dv} \right)$$

SAR is expressed in units of Watts per kilogram (W/kg)

SAR measurement can be either related to the temperature elevation in tissue by

$$SAR = c \left( \frac{\delta T}{\delta t} \right)$$

Where:  $C$  is the specific heat capacity,  $\delta T$  is the temperature rise and  $\delta t$  is the exposure duration, or related to the electrical field in the tissue by

$$SAR = \frac{\sigma |E|^2}{\rho}$$

Where:  $\sigma$  is the conductivity of the tissue,  $\rho$  is the mass density of tissue and  $E$  is the RMS electrical field strength.

However for evaluating SAR of low power transmitter, electrical field measurement is typically applied.

## 7 Tissue Simulating Liquids

### 7.1 Targets for tissue simulating liquid

Table 7.1: Targets for tissue simulating liquid

Frequency(MHz)	Liquid Type	Conductivity( $\sigma$ )	$\pm 5\%$ Range	Permittivity( $\epsilon$ )	$\pm 5\%$ Range
750	Head	0.89	0.85~0.93	41.94	39.8~44.0
750	Body	0.96	0.91~1.01	55.5	52.7~58.3
835	Head	0.90	0.86~0.95	41.5	39.4~43.6
835	Body	0.97	0.92~1.02	55.2	52.4~58.0
1750	Head	1.37	1.30~1.44	40.08	38.1~42.1
1750	Body	1.49	1.42~1.56	53.4	50.7~56.1
1900	Head	1.40	1.33~1.47	40.0	38.0~42.0
1900	Body	1.52	1.44~1.60	53.3	50.6~56.0
2450	Head	1.80	1.71~1.89	39.2	37.2~41.2
2450	Body	1.95	1.85~2.05	52.7	50.1~55.3
2600	Head	1.96	1.86~2.06	39.01	37.1~41.0
2600	Body	2.16	2.05~2.27	52.5	49.9~55.1
5200	Head	4.66	4.43~4.89	35.99	34.19~37.79
5200	Body	5.30	5.04~5.56	49.0	46.6~51.4
5300	Head	4.76	4.52~5.00	35.87	34.08~37.66
5300	Body	5.42	5.15~5.69	48.9	46.46~51.34
5600	Head	5.07	4.82~5.32	35.53	33.75~37.31
5600	Body	5.77	5.48~6.06	48.5	46.08~50.92
5800	Head	5.27	5.01~5.53	35.3	33.5~37.1
5800	Body	6.00	5.70~6.30	48.2	45.8~50.6

## 7.2 Dielectric Performance

Table 7.2: Dielectric Performance of Tissue Simulating Liquid

Measurement Date (yyyy-mm-dd)	Type	Frequency	Permittivity $\epsilon$	Drift (%)	Conductivity $\sigma$ (S/m)	Drift (%)
2017-8-10	Head	750 MHz	42.31	0.88	0.886	-0.45
	Body	750 MHz	56.42	1.66	0.944	-1.67
2017-8-8	Head	835 MHz	41.76	0.63	0.908	0.89
	Body	835 MHz	55.91	1.29	0.979	0.93
2017-8-13	Head	1750 MHz	40.41	0.82	1.421	3.72
	Body	1750 MHz	53.72	0.60	1.506	1.07
2017-8-9	Head	1900 MHz	40.61	1.53	1.411	0.79
	Body	1900 MHz	52.71	-1.11	1.527	0.46
2017-8-14	Head	2450 MHz	38.91	-0.74	1.811	0.61
	Body	2450 MHz	52.09	-1.16	1.982	1.64
2017-8-12	Head	2600 MHz	38.49	-1.33	1.949	-0.56
	Body	2600 MHz	51.81	-1.31	2.14	-0.93
2017-8-15	Head	5300 MHz	36	0.36	4.718	-0.88
	Body	5300 MHz	47.5	-2.86	5.291	-2.38
	Head	5600 MHz	35.3	-0.65	5.06	-0.20
	Body	5600 MHz	46.84	-3.42	5.709	-1.06
	Head	5800 MHz	34.91	-1.10	5.271	0.02
	Body	5800 MHz	46.44	-3.65	5.988	-0.20
2017-8-4	Head	835 MHz	40.89	-1.47	0.903	0.33
	Body	835 MHz	56.08	1.59	0.971	0.10

Note: The liquid temperature is 22.0°C

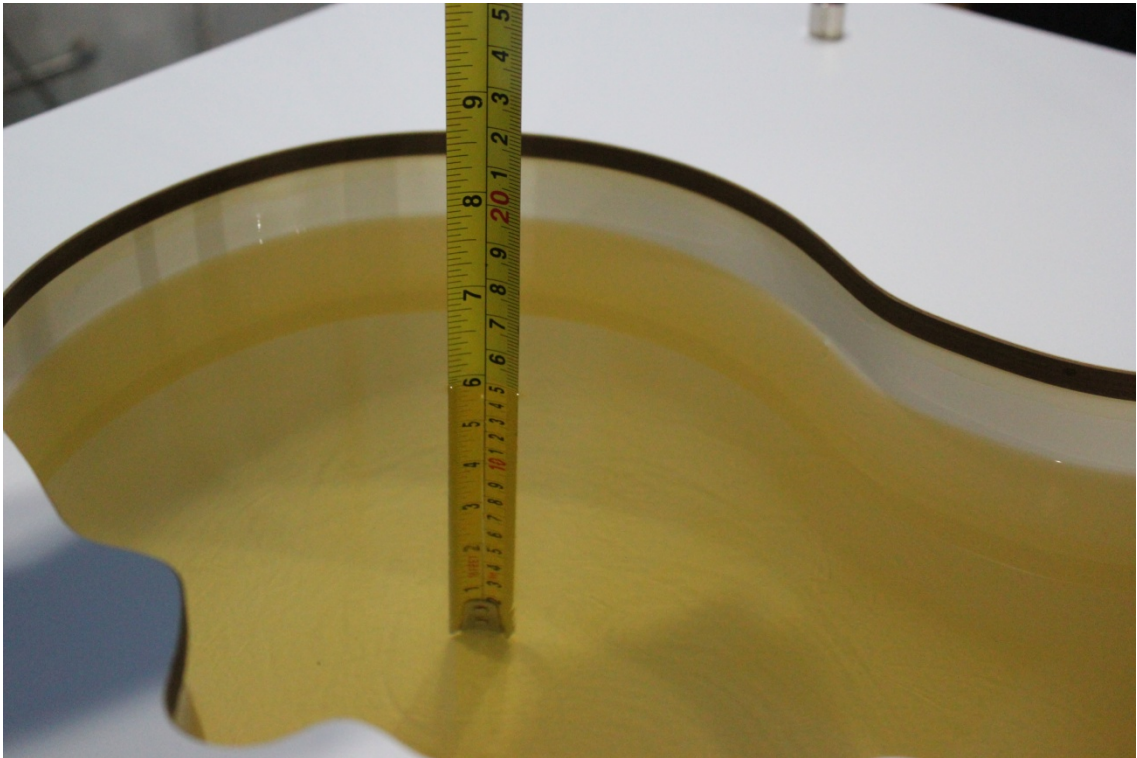

**Picture 7-1 Liquid depth in the Head Phantom (750MHz)**



**Picture 7-2 Liquid depth in the Flat Phantom (750MHz)**

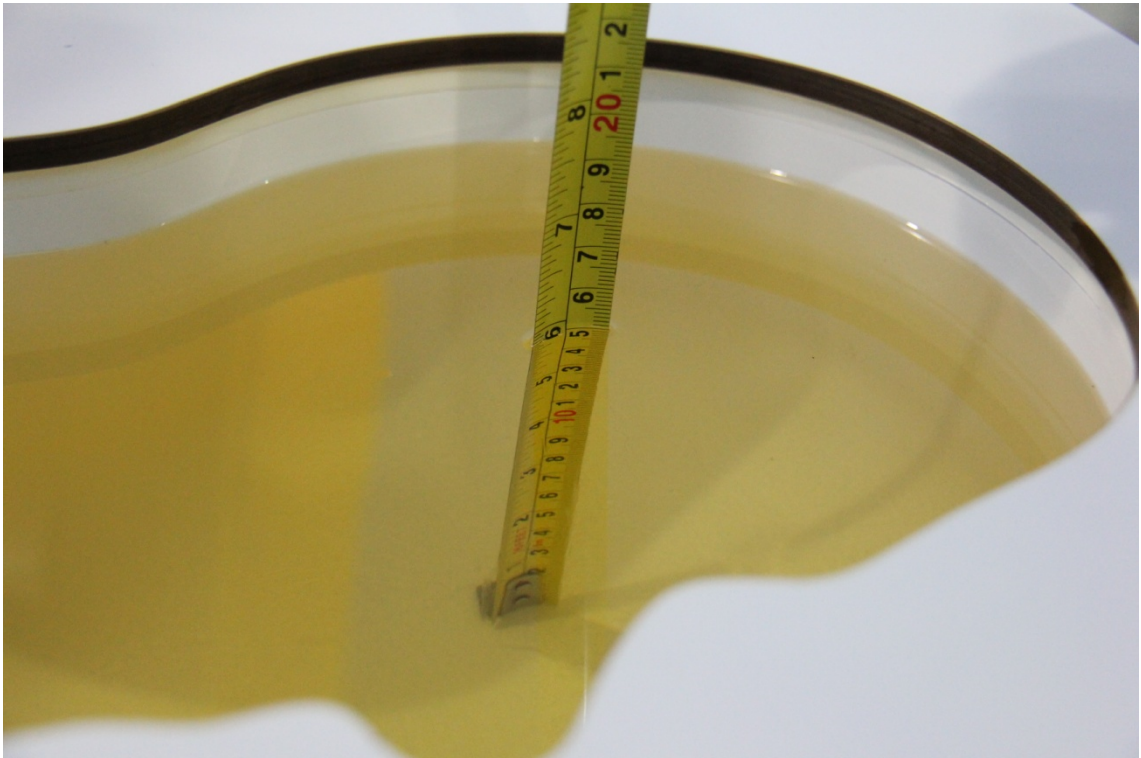

**Picture 7-3 Liquid depth in the Head Phantom (835 MHz)**

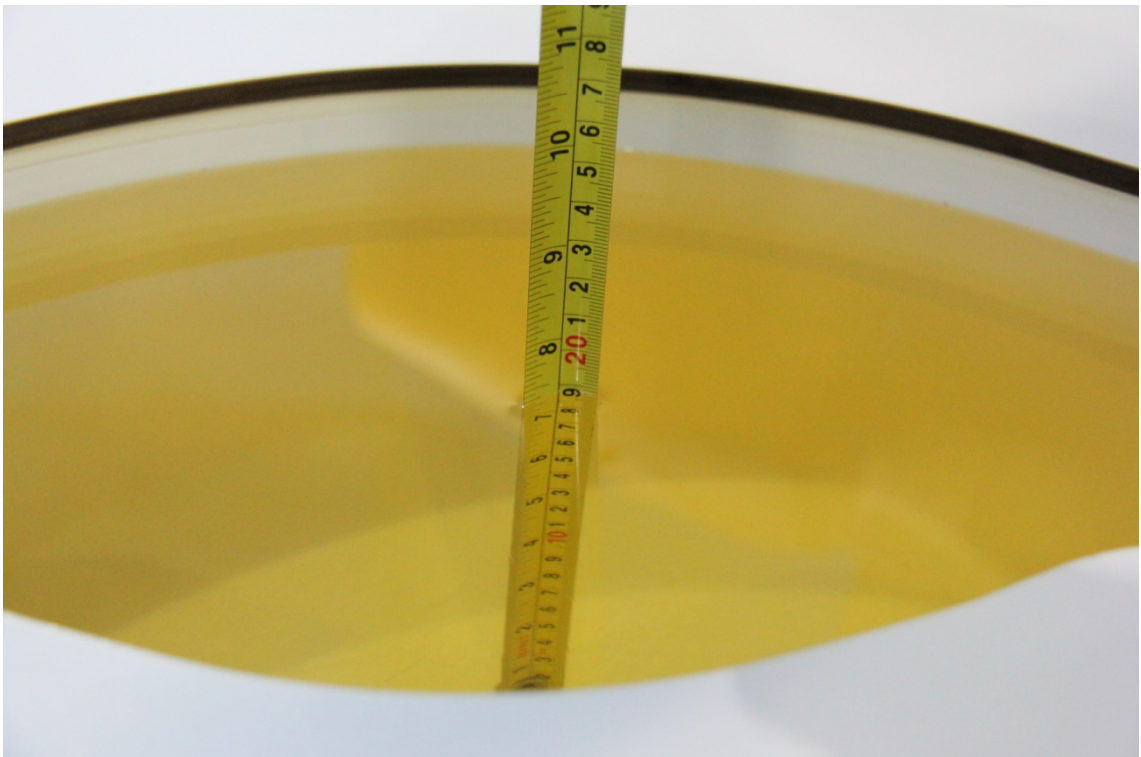

**Picture 7-4 Liquid depth in the Flat Phantom (835 MHz)**



**Picture 7-5 Liquid depth in the Head Phantom (1750 MHz)**

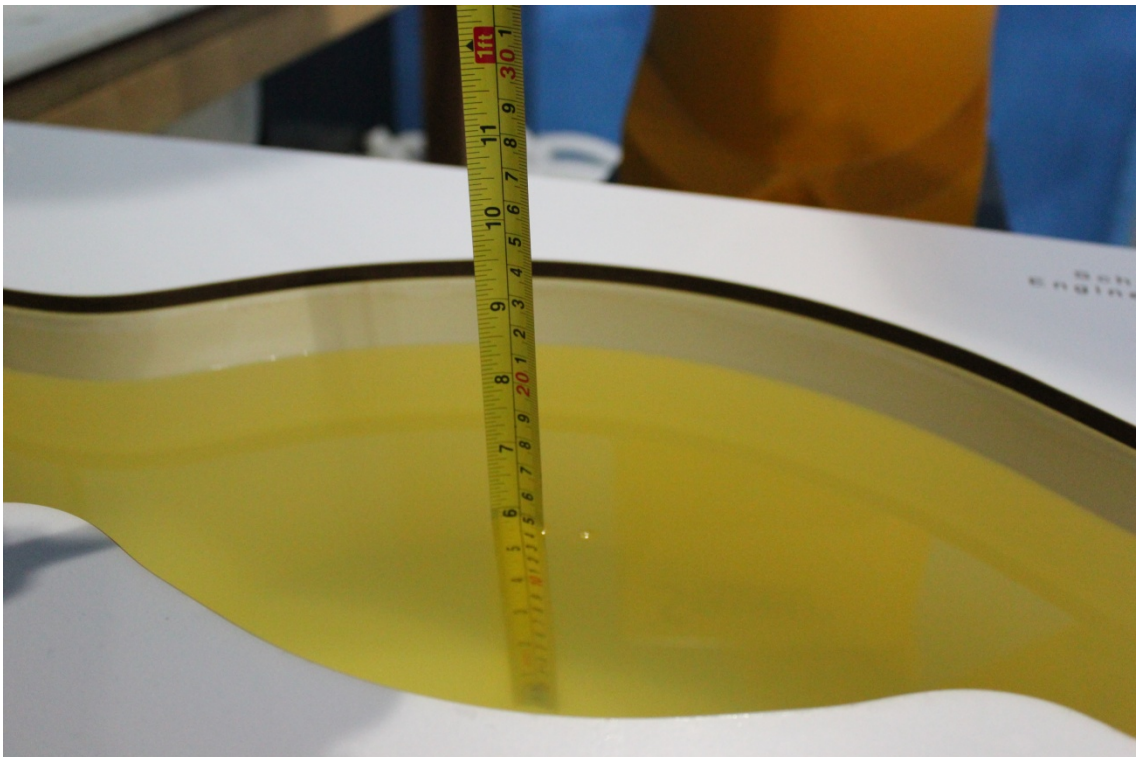

**Picture 7-6 Liquid depth in the Flat Phantom (1750MHz)**



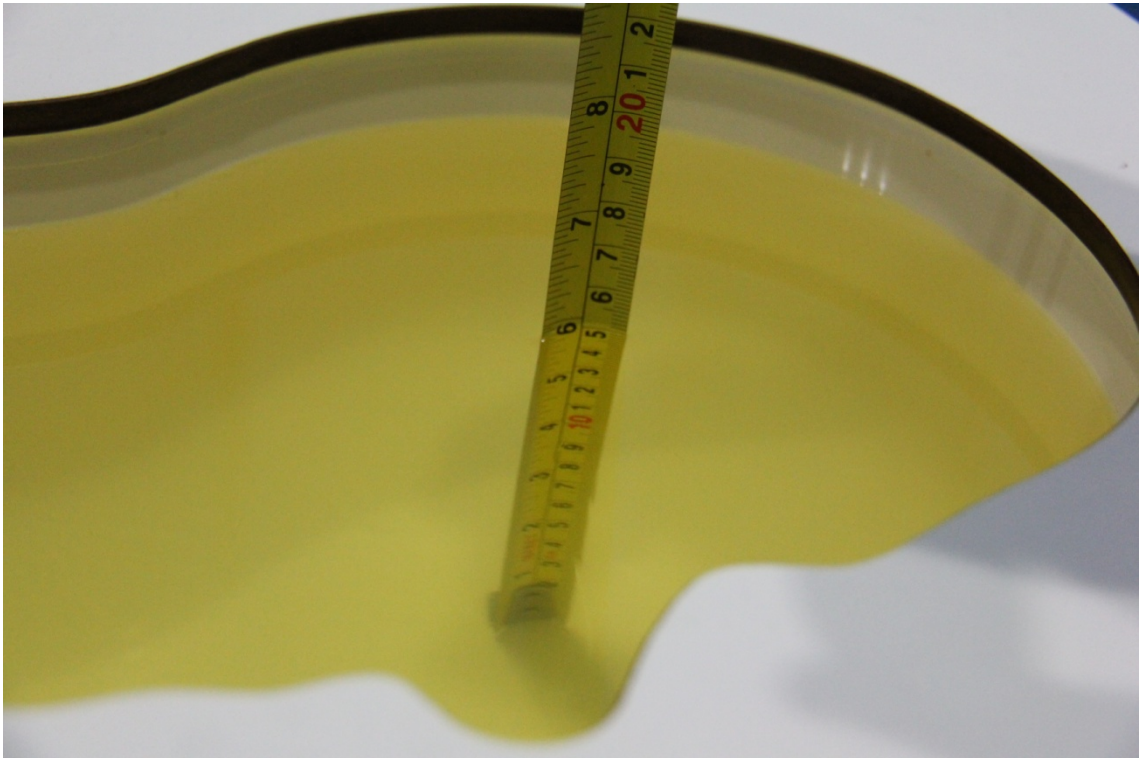

**Picture 7-7 Liquid depth in the Head Phantom (1900 MHz)**

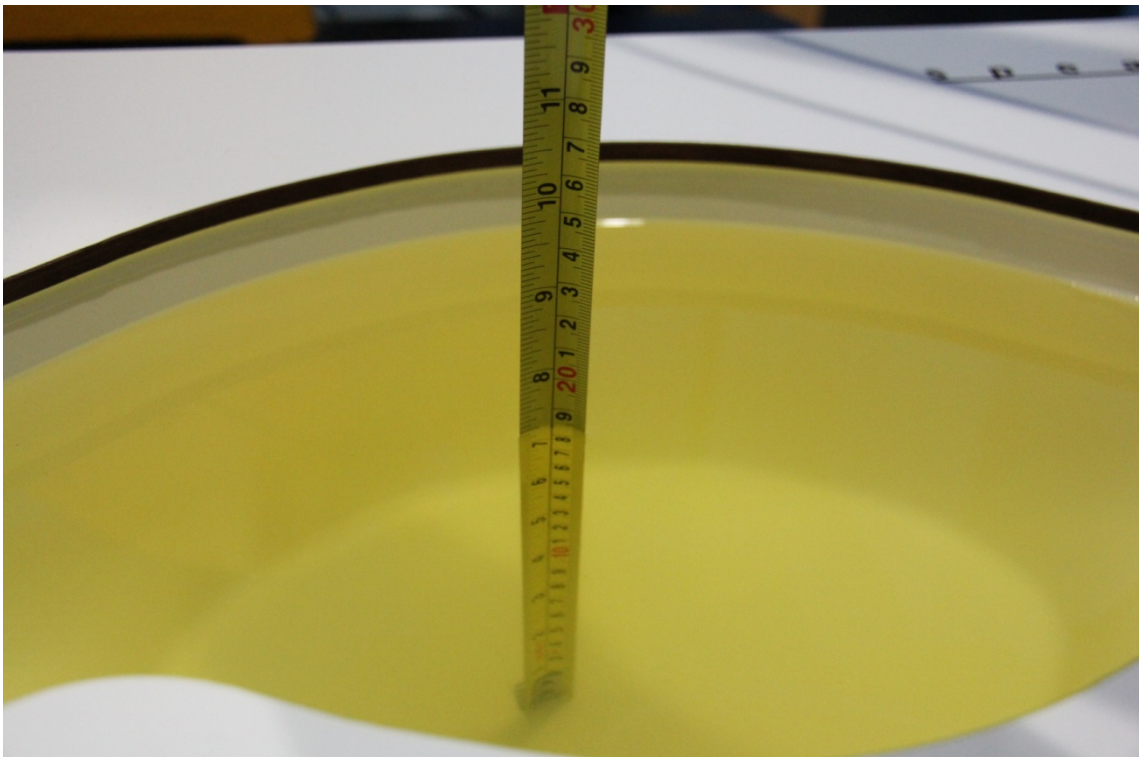

**Picture 7-8 Liquid depth in the Flat Phantom (1900MHz)**

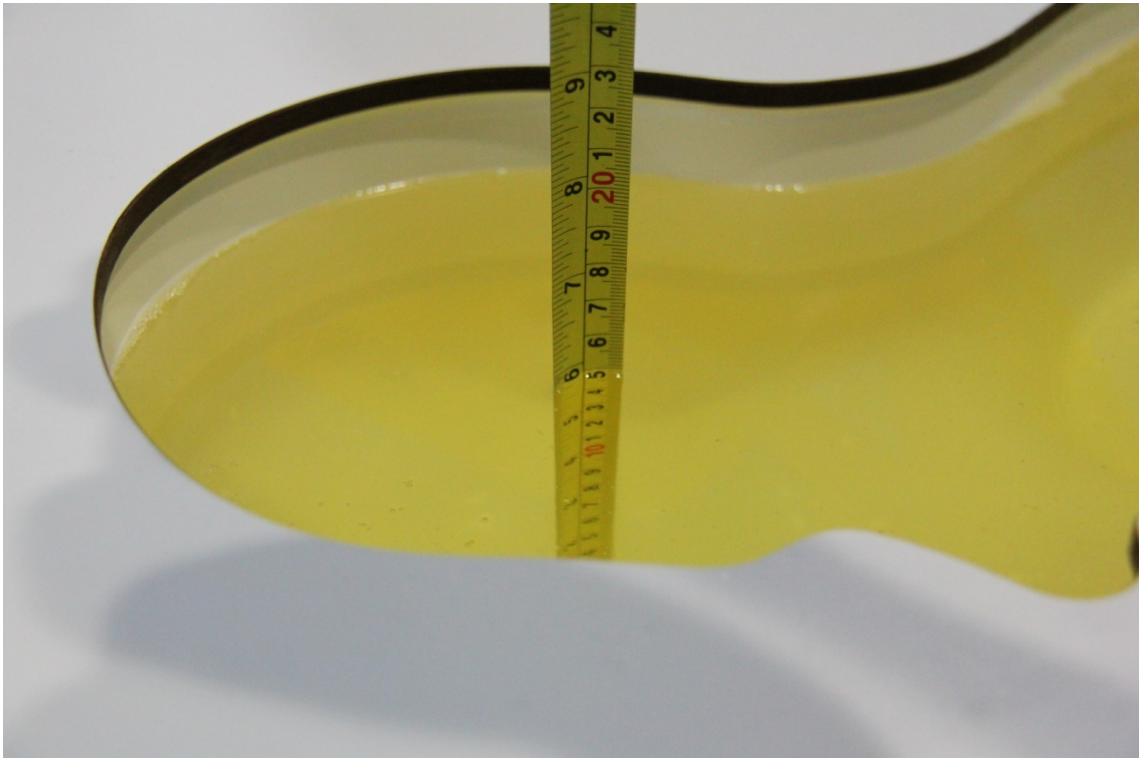

**Picture 7-9 Liquid depth in the Head Phantom (2450MHz)**

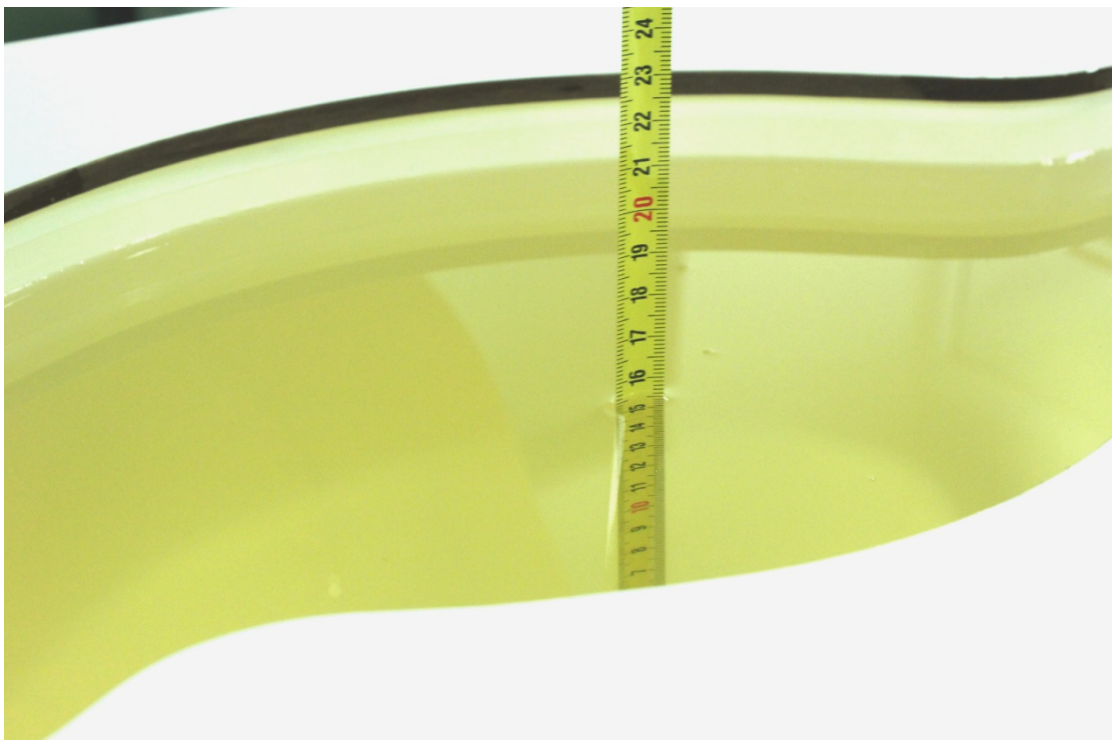

**Picture 7-10 Liquid depth in the Flat Phantom (2450MHz)**

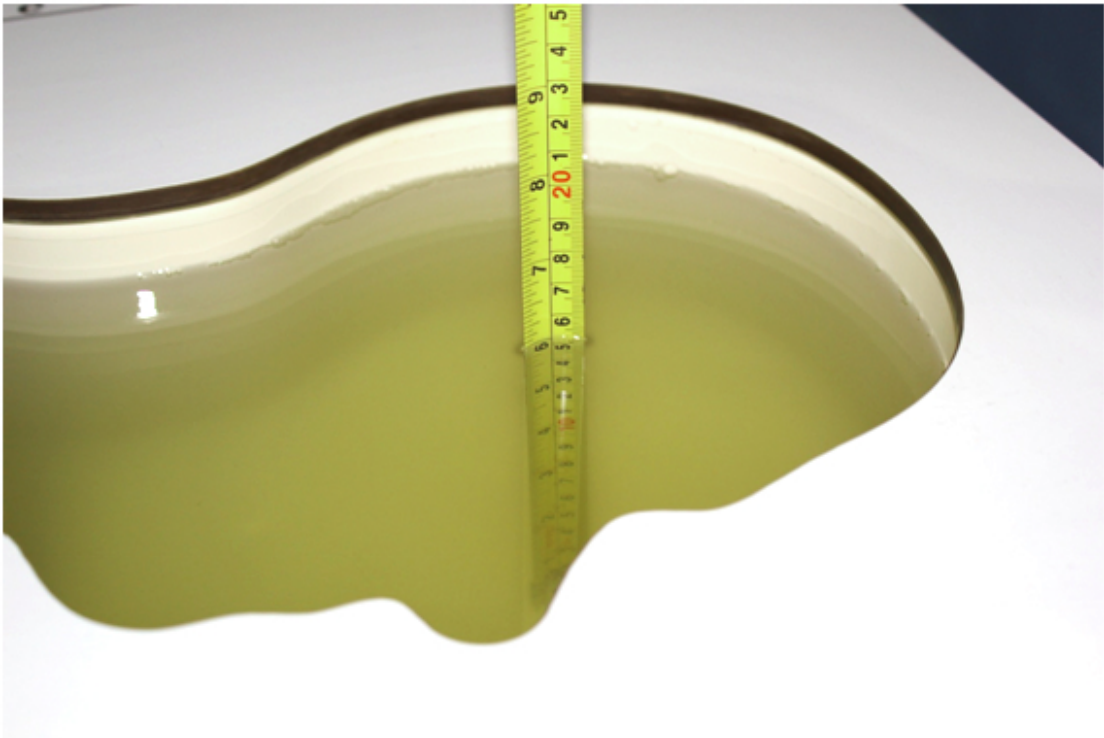

**Picture 7-11 Liquid depth in the HeadPhantom (2600 MHz Head)**

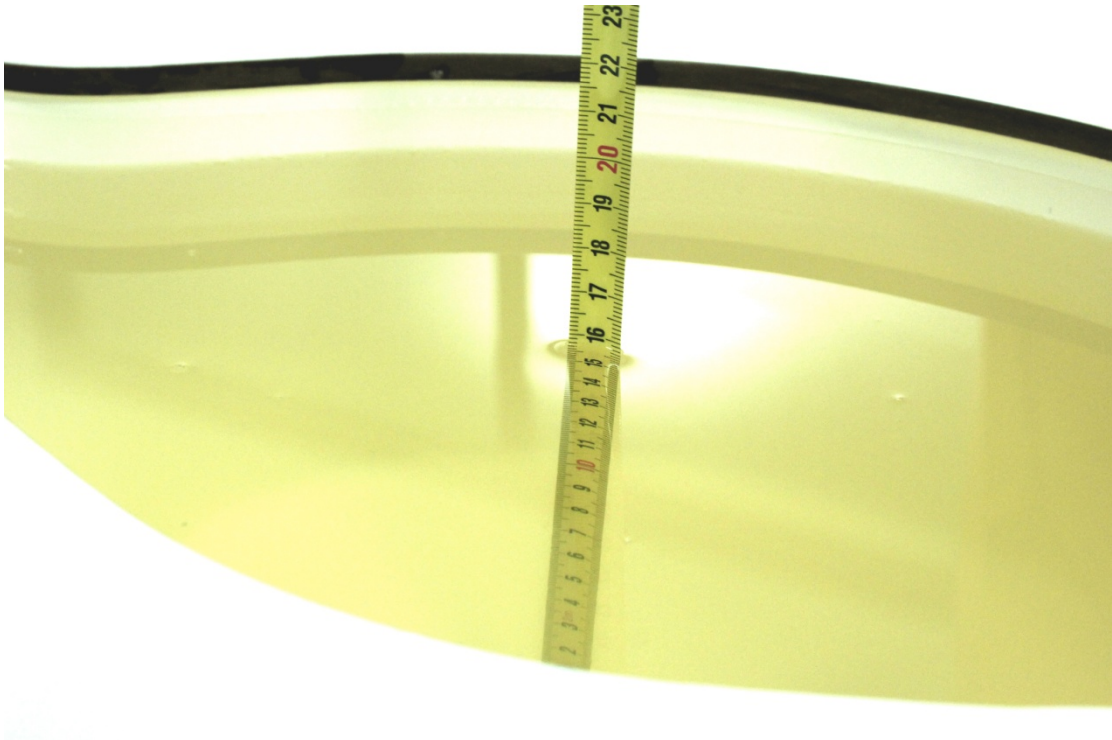

**Picture 7-12 Liquid depth in the Flat Phantom (2600MHz)**

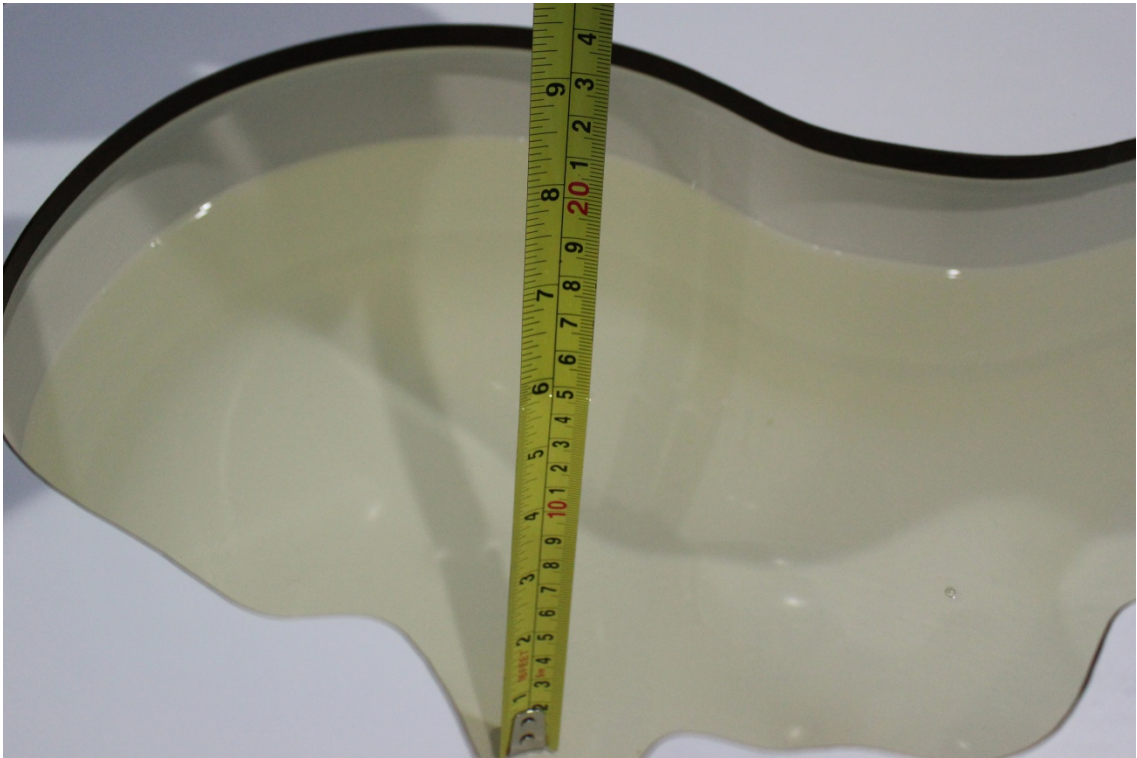

**Picture 7-13 Liquid depth in the Head Phantom (5GHz)**

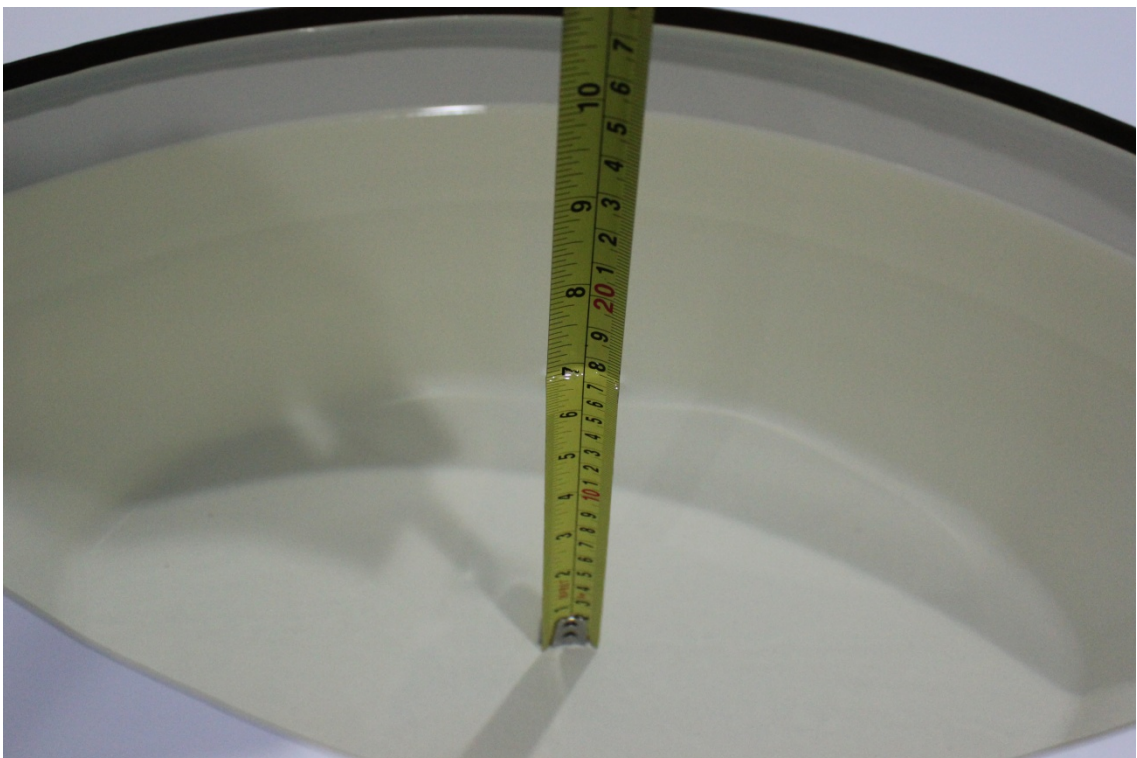

**Picture 7-14 Liquid depth in the Flat Phantom (5GHz)**

## 8 System verification

### 8.1 System Setup

In the simplified setup for system evaluation, the DUT is replaced by a calibrated dipole and the power source is replaced by a continuous wave that comes from a signal generator. The calibrated dipole must be placed beneath the flat phantom section of the SAM twin phantom with the correct distance holder. The distance holder should touch the phantom surface with a light pressure at the reference marking and be oriented parallel to the long side of the phantom. The equipment setup is shown below:

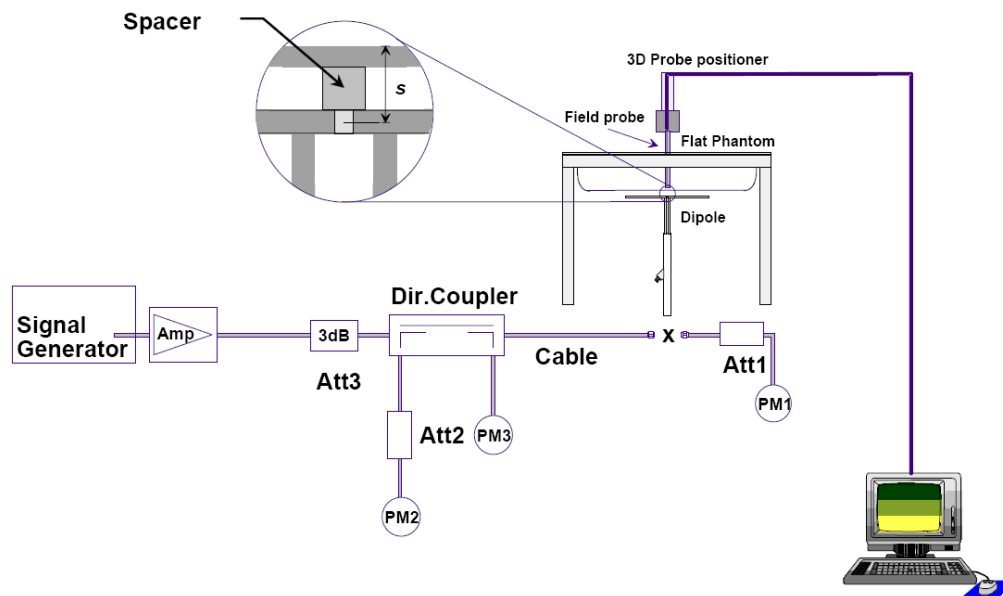

Picture 8.1 System Setup for System Evaluation



Picture 8.2 Photo of Dipole Setup

## 8.2 System Verification

SAR system verification is required to confirm measurement accuracy, according to the tissue dielectric media, probe calibration points and other system operating parameters required for measuring the SAR of a test device. The system verification must be performed for each frequency band and within the valid range of each probe calibration point required for testing the device.

The system verification results are required that the area scan estimated 1-g SAR is within 3% of the zoom scan 1-g SAR. The details are presented in annex B.

**Table 8.1: System Verification of Head**

Measurement Date (yyyy-mm-dd)	Frequency	Target value (W/kg)		Measured value (W/kg)		Deviation	
		10 g Average	1 g Average	10 g Average	1 g Average	10 g Average	1 g Average
2017-8-10	750 MHz	5.42	8.32	5.52	8.20	1.85%	-1.44%
2017-8-8	835 MHz	6.06	9.37	6.12	9.48	0.99%	1.17%
2017-8-13	1750 MHz	19.4	36.7	19.5	36.7	0.62%	0.05%
2017-8-9	1900 MHz	21.0	40.0	21.5	40.8	2.48%	2.00%
2017-8-14	2450 MHz	24.7	52.2	25.1	53.2	1.54%	1.92%
2017-8-12	2600 MHz	25.8	57.9	26.2	58.4	1.55%	0.86%
2017-8-15	5200 MHz	24.0	83.8	23.5	80.8	-2.08%	-3.58%
	5600 MHz	24.1	84.5	23.4	81.6	-2.90%	-3.43%
	5800 MHz	22.9	80.9	22.5	79.7	-1.75%	-1.48%
2017-8-4	835 MHz	6.06	9.37	6.08	9.4	0.33%	0.32%

**Table 8.2: System Verification of Body**

Measurement Date (yyyy-mm-dd)	Frequency	Target value (W/kg)		Measured value (W/kg)		Deviation	
		10 g Average	1 g Average	10 g Average	1 g Average	10 g Average	1 g Average
2017-8-10	750 MHz	5.68	8.66	5.76	8.76	1.41%	1.15%
2017-8-8	835 MHz	6.12	9.41	6.36	9.72	3.92%	3.29%
2017-8-13	1750 MHz	19.8	37.1	19.96	37.68	0.81%	1.56%
2017-8-9	1900 MHz	21.5	40.5	21.96	41.60	2.14%	2.72%
2017-8-14	2450 MHz	23.8	50.4	24.32	52.00	2.18%	3.17%
2017-8-12	2600 MHz	24.8	55.5	25.40	57.20	2.42%	3.06%
2017-8-15	5200 MHz	21.6	77.0	21.30	75.80	-1.39%	-1.56%
	5600 MHz	22.6	80.5	22.10	79.10	-2.21%	-1.74%
	5800 MHz	21.7	78.0	21.20	75.50	-2.30%	-3.21%
2017-8-4	835 MHz	6.12	9.41	6.2	9.4	1.31%	-0.11%

## 9 Measurement Procedures

### 9.1 Tests to be performed

In order to determine the highest value of the peak spatial-average SAR of a handset, all device positions, configurations and operational modes shall be tested for each frequency band according to steps 1 to 3 below. A flowchart of the test process is shown in picture 9.1.

**Step 1:** The tests described in 9.2 shall be performed at the channel that is closest to the centre of the transmit frequency band ( $f_c$ ) for:

- a) all device positions (cheek and tilt, for both left and right sides of the SAM phantom, as described in annex D),
- b) all configurations for each device position in a), e.g., antenna extended and retracted, and
- c) all operational modes, e.g., analogue and digital, for each device position in a) and configuration in b) in each frequency band.

If more than three frequencies need to be tested according to 11.1 (i.e.,  $N_c > 3$ ), then all frequencies, configurations and modes shall be tested for all of the above test conditions.

**Step 2:** For the condition providing highest peak spatial-average SAR determined in Step 1, perform all tests described in 9.2 at all other test frequencies, i.e., lowest and highest frequencies. In addition, for all other conditions (device position, configuration and operational mode) where the peak spatial-average SAR value determined in Step 1 is within 3 dB of the applicable SAR limit, it is recommended that all other test frequencies shall be tested as well.

**Step 3:** Examine all data to determine the highest value of the peak spatial-average SAR found in Steps 1 to 2.

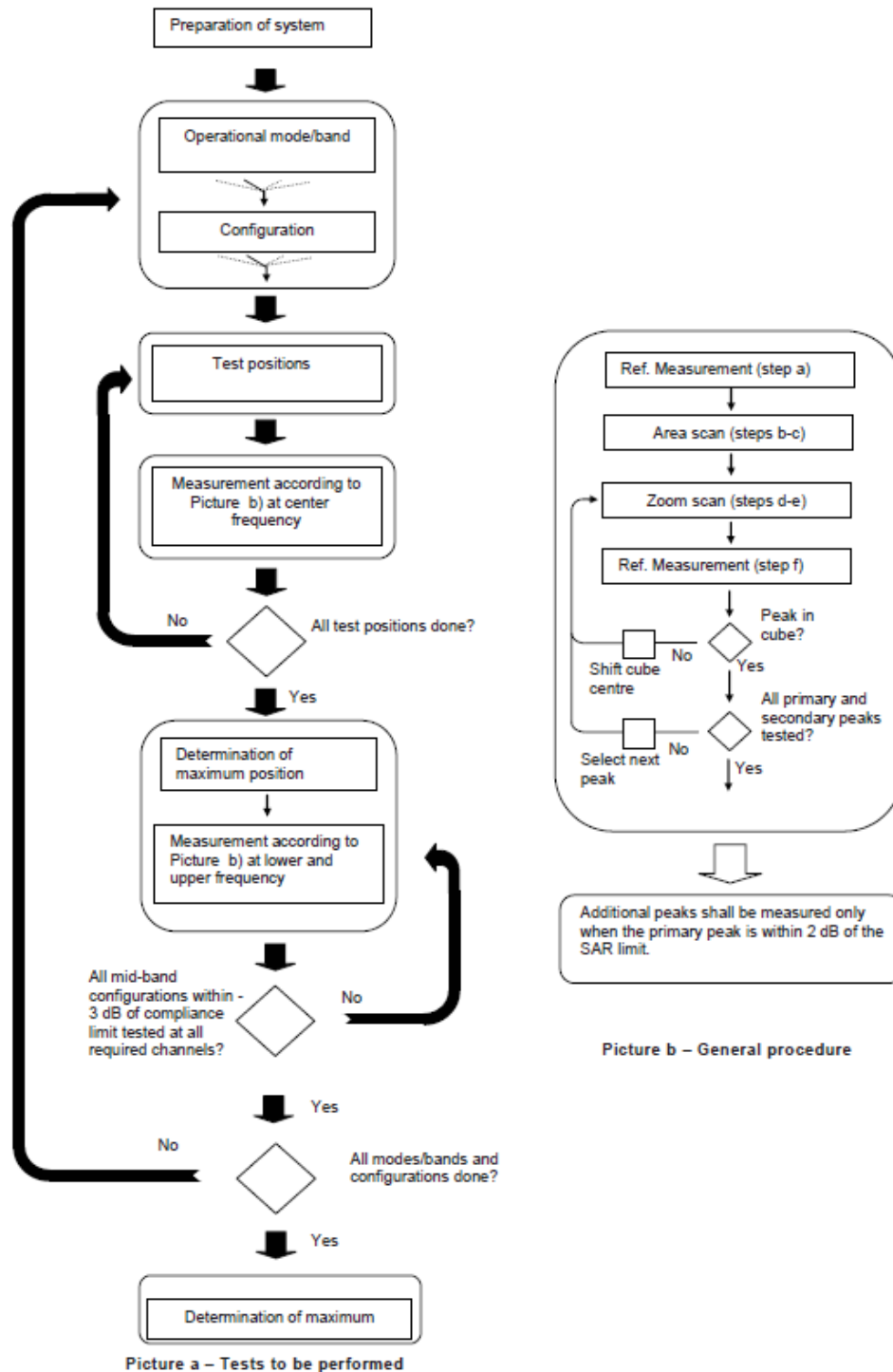

**Picture 9.1**Block diagram of the tests to be performed

## 9.2 General Measurement Procedure

The area and zoom scan resolutions specified in the table below must be applied to the SAR measurements and fully documented in SAR reports to qualify for TCB approval. Probe boundary effect error compensation is required for measurements with the probe tip closer than half a probe tip diameter to the phantom surface. Both the probe tip diameter and sensor offset distance must satisfy measurement protocols; to ensure probe boundary effect errors are minimized and the higher



fields closest to the phantom surface can be correctly measured and extrapolated to the phantom surface for computing 1-g SAR. Tolerances of the post-processing algorithms must be verified by the test laboratory for the scan resolutions used in the SAR measurements, according to their reference distribution functions specified in IEEE Std 1528-2003. The results should be documented as part of the system validation records and may be requested to support test results when all the measurement parameters in the following table are not satisfied.

		$\leq 3$ GHz	$> 3$ GHz	
Maximum distance from closest measurement point (geometric center of probe sensors) to phantom surface		$5 \pm 1$ mm	$\frac{1}{4} \delta \cdot \ln(2) \pm 0.5$ mm	
Maximum probe angle from probe axis to phantom surface normal at the measurement location		$30^\circ \pm 1^\circ$	$20^\circ \pm 1^\circ$	
Maximum area scan spatial resolution: $\Delta x_{Area}$ , $\Delta y_{Area}$		$\leq 2$ GHz: $\leq 15$ mm 2 – 3 GHz: $\leq 12$ mm	3 – 4 GHz: $\leq 12$ mm 4 – 6 GHz: $\leq 10$ mm	
		When the x or y dimension of the test device, in the measurement plane orientation, is smaller than the above, the measurement resolution must be $\leq$ the corresponding x or y dimension of the test device with at least one measurement point on the test device.		
Maximum zoom scan spatial resolution: $\Delta x_{Zoom}$ , $\Delta y_{Zoom}$		$\leq 2$ GHz: $\leq 8$ mm 2 – 3 GHz: $\leq 5$ mm*	3 – 4 GHz: $\leq 5$ mm* 4 – 6 GHz: $\leq 4$ mm*	
Maximum zoom scan spatial resolution, normal to phantom surface	uniform grid: $\Delta z_{Zoom}(n)$	$\leq 5$ mm	3 – 4 GHz: $\leq 4$ mm 4 – 5 GHz: $\leq 3$ mm 5 – 6 GHz: $\leq 2$ mm	
	graded grid	$\Delta z_{Zoom}(1)$ : between 1 <sup>st</sup> two points closest to phantom surface	$\leq 4$ mm	3 – 4 GHz: $\leq 3$ mm 4 – 5 GHz: $\leq 2.5$ mm 5 – 6 GHz: $\leq 2$ mm
		$\Delta z_{Zoom}(n>1)$ : between subsequent points	$\leq 1.5 \cdot \Delta z_{Zoom}(n-1)$	
Minimum zoom scan volume	x, y, z	$\geq 30$ mm	3 – 4 GHz: $\geq 28$ mm 4 – 5 GHz: $\geq 25$ mm 5 – 6 GHz: $\geq 22$ mm	
<p>Note: <math>\delta</math> is the penetration depth of a plane-wave at normal incidence to the tissue medium; see draft standard IEEE P1528-2011 for details.</p> <p>* When zoom scan is required and the <i>reported</i> SAR from the area scan based 1-g SAR estimation procedures of KDB 447498 is <math>\leq 1.4</math> W/kg, <math>\leq 8</math> mm, <math>\leq 7</math> mm and <math>\leq 5</math> mm zoom scan resolution may be applied, respectively, for 2 GHz to 3 GHz, 3 GHz to 4 GHz and 4 GHz to 6 GHz.</p>				

### 9.3 WCDMA Measurement Procedures for SAR

The following procedures are applicable to WCDMA handsets operating under 3GPP Release99, Release 5 and Release 6. The default test configuration is to measure SAR with an established radio link between the DUT and a communication test set using a 12.2kbps RMC (reference measurement channel) configured in Test Loop Mode 1. SAR is selectively confirmed for other physical channel configurations (DPCCH & DPDCH<sub>n</sub>), HSDPA and HSPA (HSUPA/HSDPA) modes according to output power, exposure conditions and device operating capabilities. Both uplink and downlink should be configured with the same RMC or AMR, when required. SAR for Release 5 HSDPA and Release 6 HSPA are measured using the applicable FRC (fixed reference channel) and E-DCH reference channel configurations. Maximum output power is verified according to applicable versions of 3GPP TS 34.121 and SAR must be measured according to these maximum output conditions. When Maximum Power Reduction (MPR) is not implemented according to Cubic Metric (CM) requirements for Release 6 HSPA, the following procedures do not apply.

#### For Release 5 HSDPA Data Devices:

Sub-test	$\beta_c$	$\beta_d$	$\beta_d$ (SF)	$\beta_c / \beta_d$	$\beta_{hs}$	CM/dB
1	2/15	15/15	64	2/15	4/15	0.0
2	12/15	15/15	64	12/15	24/25	1.0
3	15/15	8/15	64	15/8	30/15	1.5
4	15/15	4/15	64	15/4	30/15	1.5

#### For Release 6 HSPA Data Devices

Sub-test	$\beta_c$	$\beta_d$	$\beta_d$ (SF)	$\beta_c / \beta_d$	$\beta_{hs}$	$\beta_c$	$\beta_{ed}$	$\beta_{ed}$ (SF)	$\beta_{ed}$ (codes)	CM (dB)	MPR (dB)	AG Index	E-TFCI
1	11/15	15/15	64	11/15	22/15	209/225	1039/225	4	1	1.5	1.5	20	75
2	6/15	15/15	64	6/15	12/15	12/15	12/15	4	1	1.5	1.5	12	67
3	15/15	9/15	64	15/9	30/15	30/15	$\beta_{ed1}:47/15$ $\beta_{ed2}:47/15$	4	2	1.5	1.5	15	92
4	2/15	15/15	64	2/15	4/15	4/15	56/75	4	1	1.5	1.5	17	71
5	15/15	15/15	64	15/15	24/15	30/15	134/15	4	1	1.5	1.5	21	81

#### Rel.8 DC-HSDPA (Cat 24)

SAR test exclusion for Rel.8 DC-HSDPA must satisfy the SAR test exclusion requirements of Rel.5 HSDPA. SAR test exclusion for DC-HSDPA devices is determined by power measurements according to the H-Set 12, Fixed Reference Channel (FRC) configuration in Table C.8.1.12 of 3GPP TS 34.121-1. A primary and a secondary serving HS-DSCH Cell are required to perform the power measurement and for the results to qualify for SAR test exclusion.

## 9.4 SAR Measurement for LTE

SAR tests for LTE are performed with a base station simulator, Rohde & Schwarz CMW500. Closed loop power control was used so the UE transmits with maximum output power during SAR testing. All powers were measured with the CMW 500.

It is performed for conducted power and SAR based on the KDB941225 D05.

SAR is evaluated separately according to the following procedures for the different test positions in each exposure condition – head, body, body-worn accessories and other use conditions. The procedures in the following subsections are applied separately to test each LTE frequency band.

### 1) QPSK with 1 RB allocation

Start with the largest channel bandwidth and measure SAR for QPSK with 1 RB allocation, using the RB offset and required test channel combination with the highest maximum output power among RB offsets at the upper edge, middle and lower edge of each required test channel. When the reported SAR is  $\leq 0.8$  W/kg, testing of the remaining RB offset configurations and required test channels is not required for 1 RB allocation; otherwise, SAR is required for the remaining required test channels and only for the RB offset configuration with the highest output power for that channel. When the reported SAR of a required test channel is  $> 1.45$  W/kg, SAR is required for all three RB offset configurations for that required test channel.

### 2) QPSK with 50% RB allocation

The procedures required for 1 RB allocation in 1) are applied to measure the SAR for QPSK with 50% RB allocation.

### 3) QPSK with 100% RB allocation

For QPSK with 100% RB allocation, SAR is not required when the highest maximum output power for 100 % RB allocation is less than the highest maximum output power in 50% and 1 RB allocations and the highest reported SAR for 1 RB and 50% RB allocation in 1) and 2) are  $\leq 0.8$  W/kg. Otherwise, SAR is measured for the highest output power channel; and if the reported SAR is  $> 1.45$  W/kg, the remaining required test channels must also be tested.

## TDD test:

TDD testing is performed using guidance from FCC KDB 941225 D05v02r05 and the SAR test guidance provided in April 2013 TCB works hop notes. TDD is tested at the highest duty factor using UL-DL configuration 0 with special subframe configuration 6 and applying the FDD LTE procedures in KDB 941225 D05v02r05. SAR testing is performed using the extended cyclic prefix listed in 3GPP TS 36.211.

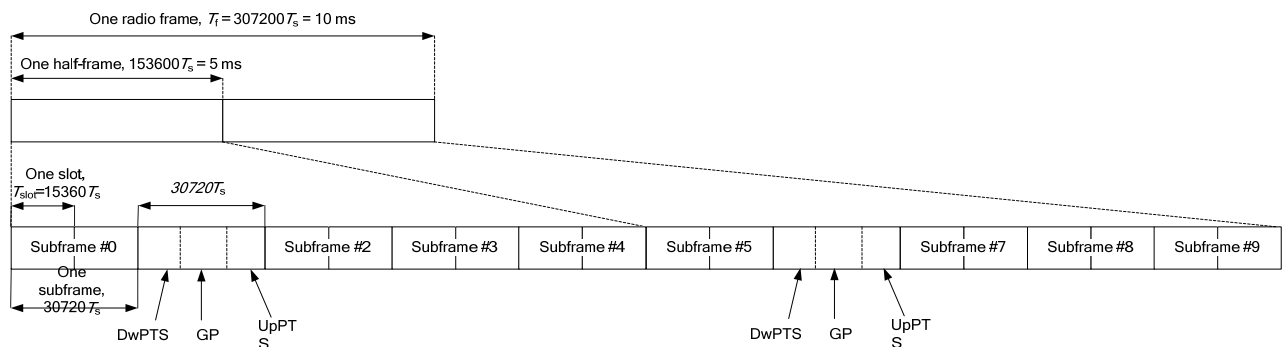

Figure 9.2: Frame structure type 2 (for 5 ms switch-point periodicity)

**Table 9.1: Configuration of special subframe (lengths of DwPTS/GP/UpPTS)**

Special subframe configuration	Normal cyclic prefix in downlink			Extended cyclic prefix in downlink		
	DwPTS	UpPTS		DwPTS	UpPTS	
		Normal cyclic prefix in uplink	Extended cyclic prefix in uplink		Normal cyclic prefix in uplink	Extended cyclic prefix in uplink
0	$6592 \cdot T_s$	$2192 \cdot T_s$	$2560 \cdot T_s$	$7680 \cdot T_s$	$2192 \cdot T_s$	$2560 \cdot T_s$
1	$19760 \cdot T_s$			$20480 \cdot T_s$		
2	$21952 \cdot T_s$			$23040 \cdot T_s$		
3	$24144 \cdot T_s$			$25600 \cdot T_s$		
4	$26336 \cdot T_s$			$7680 \cdot T_s$		
5	$6592 \cdot T_s$	$4384 \cdot T_s$	$5120 \cdot T_s$	$20480 \cdot T_s$	$4384 \cdot T_s$	$5120 \cdot T_s$
6	$19760 \cdot T_s$			$23040 \cdot T_s$		
7	$21952 \cdot T_s$			$12800 \cdot T_s$		
8	$24144 \cdot T_s$			-		
9	$13168 \cdot T_s$			-		

**Table 9.2: Uplink-downlink configurations**

Uplink-downlink configuration	Downlink-to-Uplink Switch-point periodicity	Subframe number									
		0	1	2	3	4	5	6	7	8	9
0	5 ms	D	S	U	U	U	D	S	U	U	U
1	5 ms	D	S	U	U	D	D	S	U	U	D
2	5 ms	D	S	U	D	D	D	S	U	D	D
3	10 ms	D	S	U	U	U	D	D	D	D	D
4	10 ms	D	S	U	U	D	D	D	D	D	D
5	10 ms	D	S	U	D	D	D	D	D	D	D
6	5 ms	D	S	U	U	U	D	S	U	U	D

Duty factor is calculated by:

Duty factor=uplink frame\*6+UpPTS\*2/one frame length

$$= (30720 \cdot T_s * 6 + 5120 \cdot T_s * 2) / 307200 \cdot T_s$$

$$= 0.633$$

According to the KDB 447498 D01, SAR should be evaluated at more than 3 frequencies for devices supporting transmit bands wider than 100MHz. Oct.2014 FCC-TCB conference notes (Dec. 2014 rev.) specifies the 5 test channels to use for 3GPP band 41 SARevaluation.

## **9.5 Bluetooth & Wi-Fi Measurement Procedures for SAR**

Normal network operating configurations are not suitable for measuring the SAR of 802.11 transmitters in general. Unpredictable fluctuations in network traffic and antenna diversity conditions can introduce undesirable variations in SAR results. The SAR for these devices should be measured using chipset based test mode software to ensure that the results are consistent and reliable.

Chipset based test mode software is hardware dependent and generally varies among manufacturers. The device operating parameters established in a test mode for SAR measurements must be identical to those programmed in production units, including output power levels, amplifier gain settings and other RF performance tuning parameters. The test frequencies should correspond to actual channel frequencies defined for domestic use. SAR for devices with switched diversity should be measured with only one antenna transmitting at a time during each SAR measurement, according to a fixed modulation and data rate. The same data pattern should be used for all measurements.

## **9.6 Power Drift**

To control the output power stability during the SAR test, DASY4 system calculates the power drift by measuring the E-field at the same location at the beginning and at the end of the measurement for each test position. These drift values can be found in section 14 labeled as: (Power Drift [dB]). This ensures that the power drift during one measurement is within 5%.

## 10 Area Scan Based 1-g SAR

### 10.1 Requirement of KDB

According to the KDB447498 D01 v05, when the implementation is based the specific polynomial fit algorithm as presented at the 29th Bioelectromagnetics Society meeting (2007) and the estimated 1-g SAR is  $\leq 1.2$  W/kg, a zoom scan measurement is not required provided it is also not needed for any other purpose; for example, if the peak SAR location required for simultaneous transmission SAR test exclusion can be determined accurately by the SAR system or manually to discriminate between distinctive peaks and scattered noisy SAR distributions from area scans.

There must not be any warning or alert messages due to various measurement concerns identified by the SAR system; for example, noise in measurements, peaks too close to scan boundary, peaks are too sharp, spatial resolution and uncertainty issues etc. The SAR system verification must also demonstrate that the area scan estimated 1-g SAR is within 3% of the zoom scan 1-g SAR (See Annex B). When all the SAR results for each exposure condition in a frequency band and wireless mode are based on estimated 1-g SAR, the 1-g SAR for the highest SAR configuration must be determined by a zoom scan.

### 10.2 Fast SAR Algorithms

The approach is based on the area scan measurement applying a frequency dependent attenuation parameter. This attenuation parameter was empirically determined by analyzing a large number of phones. The MOTOROLA FAST SAR was developed and validated by the MOTOROLA Research Group in Ft. Lauderdale.

In the initial study, an approximation algorithm based on Linear fit was developed. The accuracy of the algorithm has been demonstrated across a broad frequency range (136-2450 MHz) and for both 1- and 10-g averaged SAR using a sample of 264 SAR measurements from 55 wireless handsets. For the sample size studied, the root-mean-squared errors of the algorithm are 1.2% and 5.8% for 1- and 10-g averaged SAR, respectively. The paper describing the algorithm in detail is expected to be published in August 2004 within the Special Issue of Transactions on MTT.

In the second step, the same research group optimized the fitting algorithm to an Polynomial fit whereby the frequency validity was extended to cover the range 30-6000 MHz. Details of this study can be found in the BEMS 2007 Proceedings.

Both algorithms are implemented in DASY software.

## 11 Conducted Output Power

For Main antenna, there are two sets of tune-up power, Normal power and Low power, used for different use cases for W1700 and LTE Band4/7. Normal power status is applied for head test and body worn test of above bands. Low power status is applied for hotspot test of above bands. For other bands, Normal power status is applied for both head and body test.

For WiFi antenna, there are two sets of tune-up power, Normal power and Low power, used for different use cases for WiFi-2.4G. Normal power status is applied for body test. Low power status is applied for head test. For WiFi-5G, Normal power status is applied for both head and body test.

The device supports downlink Release 10 LTE Carrier Aggregation (CA) only. It supports a maximum of 2 carriers in the downlink. Other Release 10 features are not supported, including Uplink Carrier Aggregation, Enhanced SC-FDMA and Uplink MIMO or other antenna diversity configurations etc. All uplink communications are identical to the Release 8 Specifications. According to KDB 941225 D05A, the downlink LTE CA SAR test is not required and PAG requirements can be excluded.

### 11.1 GSM Measurement result

During the process of testing, the EUT was controlled via Agilent Digital Radio Communication tester (E5515C) to ensure the maximum power transmission and proper modulation. This result contains conducted output power for the EUT. In all cases, the measured peak output power should be greater and within 5% than EMI measurement.

#### Normal Power

**Table 11.1-1: The conducted power measurement results for GSM, GPRS and EGPRS**

GSM 850 Speech (GMSK)	Measured Power (dBm)			Tune up	calculation	Averaged Power (dBm)		
	251	190	128			251	190	128
1 Txslot	32.85	32.62	32.76	<b>33</b>	/	/	/	/
GSM 850 GPRS (GMSK)	Measured Power (dBm)				calculation	Averaged Power (dBm)		
	251	190	128			251	190	128
1 Txslot	32.88	32.65	32.74	<b>33</b>	-9.03	23.85	23.62	23.71
2 Txslots	32.01	31.75	31.41	<b>32.5</b>	-6.02	25.99	25.73	25.39
<b>3Txslots</b>	30.35	30.17	29.95	<b>30.5</b>	-4.26	<b>26.09</b>	<b>25.91</b>	<b>25.69</b>
4 Txslots	29.02	28.76	28.34	<b>29.5</b>	-3.01	26.01	25.75	25.33
GSM 850 EGPRS (GMSK)	Measured Power (dBm)				calculation	Averaged Power (dBm)		
	251	190	128			251	190	128
1 Txslot	32.88	32.65	32.75	<b>33</b>	-9.03	23.85	23.62	23.72
2 Txslots	32.06	31.79	31.44	<b>32.5</b>	-6.02	26.04	25.77	25.42
<b>3Txslots</b>	30.43	30.26	29.98	<b>30.5</b>	-4.26	<b>26.17</b>	<b>26.00</b>	<b>25.72</b>
4 Txslots	29.06	28.85	28.57	<b>29.5</b>	-3.01	26.05	25.84	25.56

GSM 850 EGPRS (8PSK)	Measured Power (dBm)				calculation	Averaged Power (dBm)		
	251	190	128			251	190	128
1 Txslot	27.80	27.61	27.43	<b>28</b>	-9.03	18.77	18.58	18.40
2 Txslots	26.76	26.61	26.45	<b>27</b>	-6.02	20.74	20.59	20.43
3Txslots	25.01	24.85	24.69	<b>25.5</b>	-4.26	20.75	20.59	20.43
4 Txslots	23.48	23.34	23.20	<b>24</b>	-3.01	20.47	20.33	20.19
PCS1900 Speech (GMSK)	Measured Power (dBm)			Tune up	calculation	Averaged Power (dBm)		
	810	661	512			810	661	512
1 Txslot	30.56	30.55	30.40	<b>31</b>	/	/	/	/
PCS1900 GPRS (GMSK)	Measured Power (dBm)				calculation	Averaged Power (dBm)		
	810	661	512			810	661	512
1 Txslot	30.69	30.65	30.50	<b>31</b>	-9.03	21.66	21.62	21.47
2 Txslots	30.28	30.27	30.03	<b>30.5</b>	-6.02	24.26	24.25	24.01
3Txslots	28.84	28.70	28.38	<b>29</b>	-4.26	24.58	24.44	24.12
<b>4 Txslots</b>	27.65	27.53	27.26	<b>28</b>	-3.01	<b>24.64</b>	<b>24.52</b>	<b>24.25</b>
PCS1900 EGPRS (GMSK)	Measured Power (dBm)				calculation	Averaged Power (dBm)		
	810	661	512			810	661	512
1 Txslot	30.43	30.69	30.54	<b>31</b>	-9.03	21.40	21.66	21.51
2 Txslots	30.29	30.27	30.08	<b>30.5</b>	-6.02	24.27	24.25	24.06
3Txslots	28.87	28.76	28.40	<b>29</b>	-4.26	24.61	24.50	24.14
<b>4 Txslots</b>	27.65	27.60	27.31	<b>28</b>	-3.01	<b>24.64</b>	<b>24.59</b>	<b>24.30</b>
PCS1900 EGPRS (8PSK)	Measured Power (dBm)				calculation	Averaged Power (dBm)		
	810	661	512			810	661	512
1 Txslot	26.89	26.93	26.75	<b>27</b>	-9.03	17.86	17.90	17.72
2 Txslots	25.84	25.88	25.67	<b>26</b>	-6.02	19.82	19.86	19.65
3Txslots	24.01	24.09	23.93	<b>24.5</b>	-4.26	19.75	19.83	19.67
4 Txslots	22.23	22.32	22.19	<b>22.5</b>	-3.01	19.22	19.31	19.18

NOTES:

1) Division Factors

To average the power, the division factor is as follows:

1TX-slot = 1 transmit time slot out of 8 time slots=> conducted power divided by (8/1) => -9.03dB

2TX-slots = 2 transmit time slots out of 8 time slots=> conducted power divided by (8/2) => -6.02dB

3TX-slots = 3 transmit time slots out of 8 time slots=> conducted power divided by (8/3) => -4.26dB

4TX-slots = 4 transmit time slots out of 8 time slots=> conducted power divided by (8/4) => -3.01dB

**According to the conducted power as above, the body measurements are performed with 3Txslots for GSM850 and 4Txslots for GSM1900.**



## 11.2WCDMA Measurement result

Normal power

Table 11.2-1: The conducted Power for WCDMA

Item	band	FDDV result			
	ARFCN	4132(826.4MHz)	4182(836.4MHz)	4233(846.6MHz)	Tune up
WCDMA	\	23.76	23.71	23.86	24
HSUPA	1	22.87	22.85	23.05	23.5
	2	22.44	22.35	22.45	23
	3	22.96	22.89	22.97	23.5
	4	22.95	22.87	22.95	23.5
	5	22.97	22.88	22.99	23.5
HSPA+	1	23.24	23.16	23.36	24
DC-HSDPA	1	22.47	22.41	22.49	23
	2	22.43	22.38	22.48	23
	3	22.46	22.40	22.47	23
	4	22.44	22.39	22.48	23
Item	band	FDDIV result			
	ARFCN	1312(1712.4MHz)	1412(1732.4MHz)	1513(1752.6MHz)	
WCDMA	\	23.68	23.57	23.50	24
HSUPA	1	23.46	23.37	23.12	24
	2	23.06	22.84	22.54	23.5
	3	23.44	23.38	23.14	24
	4	23.55	23.35	23.11	24
	5	23.58	23.37	23.15	24
HSPA+	1	23.57	23.36	23.04	24
DC-HSDPA	1	22.90	22.76	22.59	23.5
	2	22.89	22.75	22.57	23.5
	3	22.96	22.76	22.64	23.5
	4	22.99	22.79	22.58	23.5
Item	band	FDDII result			
	ARFCN	9262(1852.4MHz)	9400(1880MHz)	9538(1907.6MHz)	
WCDMA	\	24.35	24.26	24.24	24.5
HSUPA	1	23.34	23.29	23.29	24
	2	23.36	23.34	23.35	24
	3	23.38	23.35	23.37	24
	4	23.34	23.32	23.35	24
	5	23.41	23.35	23.36	24
HSPA+	1	22.98	22.87	23.08	23.5
DC-HSDPA	1	22.95	22.93	22.97	23.5
	2	22.95	22.92	22.94	23.5
	3	22.94	22.93	22.92	23.5
	4	22.96	22.94	22.95	23.5

Low power

Table 11.2-2: The conducted Power for WCDMA

Item	band	FDDIV result			
	ARFCN	1312(1712.4MHz)	1412(1732.4MHz)	1513(1752.6MHz)	
WCDMA	\	22.06	21.96	21.88	<b>22.5</b>
HSUPA	1	21.91	21.71	21.40	<b>22.5</b>
	2	21.42	21.27	21.05	<b>22</b>
	3	21.92	21.74	21.42	<b>22.5</b>
	4	21.89	21.73	21.52	<b>22.5</b>
	5	21.95	21.76	21.53	<b>22.5</b>
HSPA+	1	21.85	21.64	21.43	<b>22.5</b>
DC-HSDPA	1	21.28	21.14	20.98	<b>21.5</b>
	2	21.29	21.24	20.97	<b>21.5</b>
	3	21.27	21.16	20.98	<b>21.5</b>
	4	21.28	21.14	20.96	<b>21.5</b>

11.3 LTE Measurement result

Normal power

Table 11.3-1: The conducted Power for LTE

Band 2							
Bandwidth (MHz)	RB allocation	Frequency (MHz)	Max. Target Power (dBm)	QPSK		16QAM	
	RB offset (Start RB)			Actual output power (dBm)	MPR	Actual output power (dBm)	MPR
1.4 MHz	1RB High (5)	1909.3	<b>24</b>	23.39	0	22.39	1
		1880	<b>24</b>	23.55	0	22.72	1
		1850.7	<b>24</b>	23.30	0	22.69	1
	1RB Middle (3)	1909.3	<b>24</b>	23.31	0	22.41	1
		1880	<b>24</b>	23.63	0	22.65	1
		1850.7	<b>24</b>	23.35	0	22.71	1
	1RB Low (0)	1909.3	<b>24</b>	23.17	0	22.34	1
		1880	<b>24</b>	23.68	0	22.73	1
		1850.7	<b>24</b>	23.32	0	22.66	1
	3RB High (3)	1909.3	<b>24</b>	23.21	0	22.55	1
		1880	<b>24</b>	23.59	0	22.59	1
		1850.7	<b>24</b>	23.28	0	22.37	1
	3RB Middle (1)	1909.3	<b>24</b>	23.19	0	22.59	1
		1880	<b>24</b>	23.58	0	22.63	1
		1850.7	<b>24</b>	23.32	0	22.46	1
	3RB Low (0)	1909.3	<b>24</b>	23.11	0	22.52	1
		1880	<b>24</b>	23.56	0	22.74	1
		1850.7	<b>24</b>	23.28	0	22.49	1
	6RB (0)	1909.3	<b>24</b>	22.10	1	21.53	2
		1880	<b>24</b>	22.52	1	21.64	2
		1850.7	<b>24</b>	22.30	1	21.42	2

3 MHz	1RB High (14)	1908.5	24	23.52	0	22.45	1
		1880	24	23.59	0	22.43	1
		1851.5	24	23.33	0	22.78	1
	1RB Middle (7)	1908.5	24	23.35	0	22.43	1
		1880	24	23.53	0	22.79	1
		1851.5	24	23.24	0	22.82	1
	1RB Low (0)	1908.5	24	23.15	0	22.33	1
		1880	24	23.58	0	22.50	1
		1851.5	24	23.37	0	22.67	1
	8RB High (7)	1908.5	24	22.82	1	21.90	2
		1880	24	22.63	1	21.76	2
		1851.5	24	22.41	1	21.43	2
	8RB Middle (4)	1908.5	24	22.80	1	21.87	2
		1880	24	22.66	1	21.78	2
		1851.5	24	22.41	1	21.50	2
	8RB Low (0)	1908.5	24	22.86	1	21.93	2
		1880	24	22.66	1	21.74	2
		1851.5	24	22.34	1	21.44	2
15RB (0)	1908.5	24	22.84	1	21.79	2	
	1880	24	22.67	1	21.66	2	
	1851.5	24	22.39	1	21.45	2	
5 MHz	1RB High (24)	1907.5	24	23.48	0	22.43	1
		1880	24	23.84	0	22.85	1
		1852.5	24	23.37	0	22.88	1
	1RB Middle (12)	1907.5	24	23.31	0	22.37	1
		1880	24	23.75	0	22.73	1
		1852.5	24	23.15	0	22.88	1
	1RB Low (0)	1907.5	24	23.19	0	22.33	1
		1880	24	23.88	0	22.86	1
		1852.5	24	23.56	0	22.94	1
	12RB High (13)	1907.5	24	22.87	1	21.91	2
		1880	24	22.66	1	21.74	2
		1852.5	24	22.44	1	21.49	2
	12RB Middle (6)	1907.5	24	22.90	1	21.95	2
		1880	24	22.70	1	21.79	2
		1852.5	24	22.39	1	21.52	2
	12RB Low (0)	1907.5	24	23.00	1	21.94	2
		1880	24	22.71	1	21.80	2
		1852.5	24	22.48	1	21.53	2
25RB (0)	1907.5	24	22.92	1	21.80	2	
	1880	24	22.73	1	21.73	2	
	1852.5	24	22.39	1	21.48	2	
10 MHz	1RB High (49)	1905	24	23.30	0	22.21	1
		1880	24	23.75	0	22.61	1
		1855	24	23.53	0	22.87	1
	1RB Middle (24)	1905	24	23.42	0	22.50	1
		1880	24	23.58	0	22.54	1
		1855	24	23.36	0	22.64	1

	1RB Low (0)	1905	24	23.45	0	22.59	1	
		1880	24	23.68	0	22.61	1	
		1855	24	23.45	0	22.78	1	
	25RB High (25)	1905	24	22.80	1	21.91	2	
		1880	24	22.71	1	21.75	2	
		1855	24	22.42	1	21.40	2	
	25RB Middle (12)	1905	24	22.77	1	21.84	2	
		1880	24	22.67	1	21.64	2	
		1855	24	22.37	1	21.41	2	
	25RB Low (0)	1905	24	22.78	1	21.84	2	
		1880	24	22.61	1	21.61	2	
		1855	24	22.40	1	21.37	2	
	50RB (0)	1905	24	22.78	1	21.77	2	
		1880	24	22.64	1	21.57	2	
		1855	24	22.38	1	21.38	2	
15 MHz	1RB High (74)	1902.5	24	23.53	0	22.75	1	
		1880	24	23.85	0	22.70	1	
		1857.5	24	23.81	0	22.91	1	
	1RB Middle (37)	1902.5	24	23.67	0	22.95	1	
		1880	24	23.56	0	22.59	1	
		1857.5	24	23.52	0	22.92	1	
	1RB Low (0)	1902.5	24	23.98	0	22.98	1	
		1880	24	23.79	0	22.71	1	
		1857.5	24	23.70	0	22.91	1	
	36RB High (38)	1902.5	24	22.75	1	21.75	2	
		1880	24	22.71	1	21.60	2	
		1857.5	24	22.60	1	21.62	2	
	36RB Middle (19)	1902.5	24	22.82	1	21.83	2	
		1880	24	22.71	1	21.67	2	
		1857.5	24	22.60	1	21.61	2	
	36RB Low (0)	1902.5	24	22.80	1	21.76	2	
		1880	24	22.67	1	21.57	2	
		1857.5	24	22.55	1	21.58	2	
	75RB (0)	1902.5	24	22.76	1	21.73	2	
		1880	24	22.65	1	21.62	2	
		1857.5	24	22.54	1	21.57	2	
	20 MHz	1RB High (99)	1900	24	23.51	0	22.95	1
			1880	24	23.51	0	22.96	1
			1860	24	23.21	0	22.65	1
		1RB Middle (50)	1900	24	23.75	0	22.96	1
			1880	24	23.46	0	22.93	1
			1860	24	23.46	0	22.87	1
1RB Low (0)		1900	24	23.76	0	23.00	1	
		1880	24	23.52	0	22.98	1	
		1860	24	23.43	0	22.91	1	
50RB High (50)		1900	24	22.72	1	21.77	2	
		1880	24	22.56	1	21.58	2	
		1860	24	22.52	1	21.47	2	

	50RB Middle (25)	1900	24	22.85	1	21.94	2
		1880	24	22.70	1	21.75	2
		1860	24	22.59	1	21.56	2
	50RB Low (0)	1900	24	22.77	1	21.82	2
		1880	24	22.63	1	21.67	2
		1860	24	22.56	1	21.49	2
	100RB (0)	1900	24	22.86	1	21.84	2
		1880	24	22.62	1	21.59	2
		1860	24	22.55	1	21.55	2
Band 5							
Bandwidth (MHz)	RB allocation	Frequency (MHz)	Max. Target Power (dBm)	QPSK		16QAM	
	RB offset (Start RB)			Actual output power (dBm)	MPR	Actual output power (dBm)	MPR
1.4 MHz	1RB High (5)	848.3	24	23.43	0	22.44	1
		836.5	24	23.26	0	22.33	1
		824.7	24	23.27	0	22.72	1
	1RB Middle (3)	848.3	24	23.29	0	22.43	1
		836.5	24	23.44	0	22.37	1
		824.7	24	23.34	0	22.71	1
	1RB Low (0)	848.3	24	23.35	0	22.34	1
		836.5	24	23.27	0	22.28	1
		824.7	24	23.33	0	22.71	1
	3RB High (3)	848.3	24	23.28	0	22.52	1
		836.5	24	23.27	0	22.33	1
		824.7	24	23.21	0	22.38	1
	3RB Middle (1)	848.3	24	23.32	0	22.50	1
		836.5	24	23.29	0	22.33	1
		824.7	24	23.32	0	22.53	1
	3RB Low (0)	848.3	24	23.36	0	22.44	1
		836.5	24	23.27	0	22.34	1
		824.7	24	23.27	0	22.43	1
6RB (0)	848.3	24	22.34	1	21.46	2	
	836.5	24	22.27	1	21.26	2	
	824.7	24	22.32	1	21.53	2	
3 MHz	1RB High (14)	847.5	24	23.35	0	22.38	1
		836.5	24	23.24	0	22.08	1
		825.5	24	23.35	0	22.90	1
	1RB Middle (7)	847.5	24	23.42	0	22.39	1
		836.5	24	23.31	0	22.24	1
		825.5	24	23.46	0	22.84	1
	1RB Low (0)	847.5	24	23.36	0	22.39	1
		836.5	24	23.25	0	22.15	1
		825.5	24	23.28	0	22.80	1
8RB High (7)	847.5	24	22.37	1	21.45	2	
	836.5	24	22.34	1	21.45	2	
	825.5	24	22.44	1	21.37	2	

	8RB Middle (4)	847.5	24	22.43	1	21.42	2	
		836.5	24	22.42	1	21.51	2	
		825.5	24	22.41	1	21.56	2	
	8RB Low (0)	847.5	24	22.35	1	21.37	2	
		836.5	24	22.27	1	21.42	2	
		825.5	24	22.36	1	21.41	2	
	15RB (0)	847.5	24	22.41	1	21.35	2	
		836.5	24	22.38	1	21.40	2	
		825.5	24	22.39	1	21.47	2	
5 MHz	1RB High (24)	846.5	24	23.55	0	22.52	1	
		836.5	24	23.56	0	22.62	1	
		826.5	24	23.29	0	22.90	1	
	1RB Middle (12)	846.5	24	23.19	0	22.40	1	
		836.5	24	23.38	0	22.24	1	
		826.5	24	23.33	0	22.95	1	
	1RB Low (0)	846.5	24	23.48	0	22.43	1	
		836.5	24	23.49	0	22.54	1	
		826.5	24	23.31	0	22.88	1	
	12RB High (13)	846.5	24	22.46	1	21.53	2	
		836.5	24	22.35	1	21.42	2	
		826.5	24	22.46	1	21.39	2	
	12RB Middle (6)	846.5	24	22.42	1	21.46	2	
		836.5	24	22.38	1	21.47	2	
		826.5	24	22.49	1	21.42	2	
	12RB Low (0)	846.5	24	22.51	1	21.51	2	
		836.5	24	22.38	1	21.43	2	
		826.5	24	22.40	1	21.63	2	
	25RB (0)	846.5	24	22.40	1	21.33	2	
		836.5	24	22.42	1	21.43	2	
		826.5	24	22.44	1	21.48	2	
	10 MHz	1RB High (49)	844.0	24	23.70	0	22.93	1
			836.5	24	23.58	0	22.55	1
			829.0	24	23.72	0	22.60	1
1RB Middle (24)		844.0	24	23.41	0	22.74	1	
		836.5	24	23.37	0	22.31	1	
		829.0	24	23.28	0	22.12	1	
1RB Low (0)		844.0	24	23.42	0	22.63	1	
		836.5	24	23.47	0	22.38	1	
		829.0	24	23.60	0	22.47	1	
25RB High (25)		844.0	24	22.54	1	21.52	2	
		836.5	24	22.48	1	21.59	2	
		829.0	24	22.48	1	21.49	2	
25RB Middle (12)		844.0	24	22.47	1	21.48	2	
		836.5	24	22.44	1	21.55	2	
		829.0	24	22.47	1	21.39	2	
25RB Low (0)		844.0	24	22.47	1	21.45	2	
		836.5	24	22.32	1	21.51	2	
		829.0	24	22.47	1	21.42	2	



	50RB (0)	844.0	24	22.48	1	21.50	2	
		836.5	24	22.48	1	21.47	2	
		829.0	24	22.46	1	21.44	2	
Band 7								
Bandwidth (MHz)	RB allocation	Frequency (MHz)	Max. Target Power (dBm)	QPSK		16QAM		
	RB offset (Start RB)			Actual output power (dBm)	MPR	Actual output power (dBm)	MPR	
5 MHz	1RB High (24)	2567.5	24.5	22.97	0	22.09	1	
		2535	24.5	22.78	0	22.27	1	
		2502.5	24.5	22.86	0	21.99	1	
	1RB Middle (12)	2567.5	24.5	22.91	0	22.07	1	
		2535	24.5	22.79	0	22.39	1	
		2502.5	24.5	22.91	0	22.03	1	
	1RB Low (0)	2567.5	24.5	22.94	0	22.12	1	
		2535	24.5	22.91	0	22.38	1	
		2502.5	24.5	22.93	0	21.96	1	
	12RB High (13)	2567.5	24.5	21.94	1	21.03	2	
		2535	24.5	21.88	1	20.98	2	
		2502.5	24.5	21.89	1	20.98	2	
	12RB Middle (6)	2567.5	24.5	21.95	1	21.02	2	
		2535	24.5	21.91	1	21.02	2	
		2502.5	24.5	21.95	1	20.95	2	
	12RB Low (0)	2567.5	24.5	21.95	1	20.98	2	
		2535	24.5	21.87	1	21.02	2	
		2502.5	24.5	21.92	1	21.00	2	
	25RB (0)	2567.5	24.5	21.91	1	20.98	2	
		2535	24.5	21.86	1	20.92	2	
		2502.5	24.5	21.91	1	20.85	2	
	10 MHz	1RB High (49)	2565	24.5	22.92	0	21.91	1
			2535	24.5	22.94	0	22.35	1
			2505	24.5	23.08	0	22.17	1
1RB Middle (24)		2565	24.5	22.80	0	21.71	1	
		2535	24.5	22.86	0	22.28	1	
		2505	24.5	22.78	0	21.82	1	
1RB Low (0)		2565	24.5	23.05	0	21.96	1	
		2535	24.5	23.11	0	22.49	1	
		2505	24.5	23.34	0	22.02	1	
25RB High (25)		2565	24.5	21.88	1	20.93	2	
		2535	24.5	21.82	1	20.87	2	
		2505	24.5	21.87	1	20.93	2	
25RB Middle (12)		2565	24.5	21.88	1	20.90	2	
		2535	24.5	21.87	1	20.89	2	
		2505	24.5	21.85	1	20.93	2	
25RB Low (0)		2565	24.5	21.95	1	20.99	2	
		2535	24.5	21.90	1	20.94	2	
		2505	24.5	21.91	1	20.98	2	

	50RB (0)	2565	24.5	21.87	1	20.94	2	
		2535	24.5	21.94	1	20.92	2	
		2505	24.5	21.89	1	20.89	2	
15 MHz	1RB High (74)	2562.5	24.5	22.91	0	22.00	1	
		2535	24.5	22.86	0	22.18	1	
		2507.5	24.5	23.04	0	22.38	1	
	1RB Middle (37)	2562.5	24.5	22.86	0	21.68	1	
		2535	24.5	23.05	0	22.41	1	
		2507.5	24.5	23.05	0	22.39	1	
	1RB Low (0)	2562.5	24.5	22.89	0	21.88	1	
		2535	24.5	23.04	0	22.41	1	
		2507.5	24.5	23.03	0	22.34	1	
	36RB High (38)	2562.5	24.5	22.01	1	21.03	2	
		2535	24.5	22.07	1	21.10	2	
		2507.5	24.5	22.07	1	21.02	2	
	36RB Middle (19)	2562.5	24.5	22.01	1	20.96	2	
		2535	24.5	22.02	1	21.11	2	
		2507.5	24.5	22.13	1	21.06	2	
	36RB Low (0)	2562.5	24.5	22.00	1	20.96	2	
		2535	24.5	22.01	1	21.07	2	
		2507.5	24.5	22.15	1	21.08	2	
	75RB (0)	2562.5	24.5	21.92	1	20.96	2	
		2535	24.5	21.95	1	21.05	2	
		2507.5	24.5	22.05	1	21.10	2	
	20 MHz	1RB High (99)	2560	24.5	23.04	0	22.47	1
			2535	24.5	23.01	0	22.42	1
			2510	24.5	23.11	0	22.50	1
		1RB Middle (50)	2560	24.5	22.90	0	22.40	1
			2535	24.5	23.01	0	22.41	1
			2510	24.5	22.99	0	22.49	1
1RB Low (0)		2560	24.5	22.94	0	22.50	1	
		2535	24.5	23.03	0	22.40	1	
		2510	24.5	23.26	0	22.50	1	
50RB High (50)		2560	24.5	22.02	1	21.15	2	
		2535	24.5	22.04	1	21.05	2	
		2510	24.5	22.07	1	21.07	2	
50RB Middle (25)		2560	24.5	21.97	1	21.07	2	
		2535	24.5	22.05	1	21.05	2	
		2510	24.5	22.10	1	21.14	2	
50RB Low (0)		2560	24.5	21.96	1	20.99	2	
		2535	24.5	22.05	1	21.03	2	
		2510	24.5	22.13	1	21.14	2	
100RB (0)		2560	24.5	22.13	1	21.03	2	
		2535	24.5	22.06	1	21.00	2	
		2510	24.5	22.11	1	21.15	2	



Band 12								
Bandwidth(MHz )	RB allocation RB offset (Start RB)	Frequency (MHz)	Max. Target Power (dBm)	QPSK		16QAM		
				Actual output power (dBm)	MPR	Actual output power (dBm)	MPR	
1.4 MHz	1RB High (5)	715.3	24	23.24	0	22.70	1	
		707.5	24	23.16	0	22.25	1	
		699.7	24	23.14	0	22.15	1	
	1RB Middle (3)	715.3	24	23.70	0	22.60	1	
		707.5	24	23.20	0	22.27	1	
		699.7	24	23.15	0	22.12	1	
	1RB Low (0)	715.3	24	23.34	0	22.93	1	
		707.5	24	23.18	0	22.27	1	
		699.7	24	23.10	0	22.14	1	
	3RB High (3)	715.3	24	23.32	0	22.43	1	
		707.5	24	23.22	0	22.35	1	
		699.7	24	23.03	0	22.04	1	
	3RB Middle (1)	715.3	24	23.28	0	22.63	1	
		707.5	24	23.27	0	22.36	1	
		699.7	24	23.37	0	22.28	1	
	3RB Low (0)	715.3	24	23.29	0	22.73	1	
		707.5	24	23.25	0	22.37	1	
		699.7	24	23.16	0	22.18	1	
	6RB (0)	715.3	24	22.42	1	21.43	2	
		707.5	24	22.25	1	21.41	2	
		699.7	24	22.15	1	21.11	2	
	3 MHz	1RB High (14)	714.5	24	23.55	0	22.95	1
			707.5	24	23.20	0	22.23	1
			700.5	24	23.06	0	22.02	1
		1RB Middle (7)	714.5	24	23.37	0	22.66	1
			707.5	24	23.21	0	22.29	1
			700.5	24	23.10	0	22.01	1
1RB Low (0)		714.5	24	23.41	0	22.90	1	
		707.5	24	23.22	0	22.26	1	
		700.5	24	23.01	0	21.98	1	
8RB High (7)		714.5	24	22.40	1	21.42	2	
		707.5	24	22.25	1	21.27	2	
		700.5	24	22.11	1	21.23	2	
8RB Middle (4)		714.5	24	22.26	1	21.42	2	
		707.5	24	22.23	1	21.30	2	
		700.5	24	22.19	1	21.33	2	
8RB Low (0)		714.5	24	22.35	1	21.41	2	
		707.5	24	22.24	1	21.35	2	
		700.5	24	22.10	1	21.29	2	
15RB (0)		714.5	24	22.39	1	21.48	2	
		707.5	24	22.23	1	21.18	2	
		700.5	24	22.19	1	21.21	2	

5 MHz	1RB High (24)	713.5	24	23.41	0	22.61	1	
		707.5	24	23.63	0	22.82	1	
		701.5	24	23.51	0	22.26	1	
	1RB Middle (12)	713.5	24	23.25	0	22.43	1	
		707.5	24	23.33	0	22.74	1	
		701.5	24	23.45	0	22.18	1	
	1RB Low (0)	713.5	24	23.33	0	22.46	1	
		707.5	24	23.59	0	22.78	1	
		701.5	24	23.19	0	22.33	1	
	12RB High (13)	713.5	24	22.33	1	21.35	2	
		707.5	24	22.31	1	21.44	2	
		701.5	24	22.17	1	21.18	2	
	12RB Middle (6)	713.5	24	22.42	1	21.50	2	
		707.5	24	22.28	1	21.38	2	
		701.5	24	22.25	1	21.17	2	
	12RB Low (0)	713.5	24	22.46	1	21.53	2	
		707.5	24	22.26	1	21.38	2	
		701.5	24	22.21	1	21.25	2	
	25RB (0)	713.5	24	22.50	1	21.41	2	
		707.5	24	22.25	1	21.32	2	
		701.5	24	22.16	1	21.10	2	
	10 MHz	1RB High (49)	711	24	23.84	0	22.96	1
			707.5	24	23.51	0	22.79	1
			704	24	23.45	0	22.37	1
1RB Middle (24)		711	24	23.34	0	22.83	1	
		707.5	24	23.25	0	22.34	1	
		704	24	23.21	0	22.29	1	
1RB Low (0)		711	24	23.58	0	22.91	1	
		707.5	24	23.60	0	22.54	1	
		704	24	23.74	0	22.49	1	
25RB High (25)		711	24	22.46	1	21.38	2	
		707.5	24	22.37	1	21.38	2	
		704	24	22.28	1	21.31	2	
25RB Middle (12)		711	24	22.45	1	21.45	2	
		707.5	24	22.27	1	21.38	2	
		704	24	22.30	1	21.33	2	
25RB Low (0)		711	24	22.39	1	21.43	2	
		707.5	24	22.34	1	21.48	2	
		704	24	22.37	1	21.40	2	
50RB (0)		711	24	22.47	1	21.49	2	
		707.5	24	22.28	1	21.33	2	
		704	24	22.35	1	21.31	2	

Band 13							
Bandwidth (MHz)	RB allocation RB offset (Start RB)	Frequency (MHz)	Max. Target Power (dBm)	QPSK		16QAM	
				Actual output power (dBm)	MPR	Actual output power (dBm)	MPR
5 MHz	1RB High (24)	784.5	24	23.30	0	22.25	1
		782	24	23.11	0	22.34	1
		779.5	24	23.64	0	22.84	1
	1RB Middle (12)	784.5	24	23.59	0	21.99	1
		782	24	23.49	0	22.45	1
		779.5	24	23.72	0	22.95	1
	1RB Low (0)	784.5	24	23.30	0	22.49	1
		782	24	23.62	0	22.67	1
		779.5	24	23.40	0	22.81	1
	12RB High (13)	784.5	24	22.31	1	21.36	2
		782	24	22.42	1	21.42	2
		779.5	24	22.36	1	21.53	2
	12RB Middle (6)	784.5	24	22.28	1	21.43	2
		782	24	22.38	1	21.43	2
		779.5	24	22.43	1	21.59	2
	12RB Low (0)	784.5	24	22.32	1	21.36	2
		782	24	22.40	1	21.49	2
		779.5	24	22.39	1	21.47	2
	25RB (0)	784.5	24	22.31	1	21.35	2
		782	24	22.41	1	21.39	2
		779.5	24	22.44	1	21.49	2
10 MHz	1RB High (49)	782	24	23.48	0	22.21	1
	1RB Middle (24)	782	24	23.36	0	22.45	1
	1RB Low (0)	782	24	23.54	0	22.43	1
	25RB High (25)	782	24	22.44	1	21.45	2
	25RB Middle (12)	782	24	22.39	1	21.46	2
	25RB Low (0)	782	24	22.40	1	21.38	2
	50RB (0)	782	24	22.47	1	21.42	2

Band 38								
Bandwidth (MHz)	RB allocation RB offset (Start RB)	Frequency (MHz)	Max. Target Power (dBm)	QPSK		16QAM		
				Actual output power (dBm)	MPR	Actual output power (dBm)	MPR	
5 MHz	1RB High (24)	2617.5	24	23.73	0	22.94	1	
		2595	24	23.47	0	22.44	1	
		2572.5	24	23.21	0	22.41	1	
	1RB Middle (12)	2617.5	24	23.64	0	22.92	1	
		2595	24	23.36	0	22.58	1	
		2572.5	24	23.18	0	22.32	1	
	1RB Low (0)	2617.5	24	23.75	0	22.91	1	
		2595	24	23.18	0	22.51	1	
		2572.5	24	23.34	0	22.57	1	
	12RB High (13)	2617.5	24	22.78	1	21.50	2	
		2595	24	22.41	1	21.26	2	
		2572.5	24	22.23	1	21.30	2	
	12RB Middle (6)	2617.5	24	22.79	1	21.54	2	
		2595	24	22.39	1	21.40	2	
		2572.5	24	22.21	1	21.29	2	
	12RB Low (0)	2617.5	24	22.39	1	21.83	2	
		2595	24	22.31	1	21.36	2	
		2572.5	24	22.19	1	21.43	2	
	25RB (0)	2617.5	24	22.54	1	21.68	2	
		2595	24	22.42	1	21.20	2	
		2572.5	24	22.07	1	21.38	2	
	10 MHz	1RB High (49)	2615	24	23.55	0	22.96	1
			2595	24	23.45	0	22.94	1
			2575	24	23.49	0	22.99	1
1RB Middle (24)		2615	24	23.99	0	22.85	1	
		2595	24	23.23	0	22.54	1	
		2575	24	23.15	0	22.57	1	
1RB Low (0)		2615	24	23.68	0	22.93	1	
		2595	24	23.31	0	22.73	1	
		2575	24	23.28	0	22.81	1	
25RB High (25)		2615	24	22.49	1	21.85	2	
		2595	24	22.53	1	21.53	2	
		2575	24	22.32	1	21.15	2	
25RB Middle (12)		2615	24	22.73	1	21.80	2	
		2595	24	22.43	1	21.36	2	
		2575	24	22.24	1	21.19	2	
25RB Low (0)		2615	24	22.63	1	21.71	2	
		2595	24	22.38	1	21.35	2	
		2575	24	22.23	1	21.14	2	
50RB (0)		2615	24	22.78	1	21.71	2	
		2595	24	22.16	1	21.35	2	
		2575	24	22.25	1	21.22	2	
15 MHz		1RB High (74)	2612.5	24	23.52	0	22.98	1
			2595	24	23.26	0	22.66	1
			2577.5	24	23.43	0	22.76	1

	1RB Middle (37)	2612.5	24	23.19	0	22.95	1	
		2595	24	23.24	0	22.59	1	
		2577.5	24	23.39	0	22.55	1	
	1RB Low (0)	2612.5	24	23.32	0	22.84	1	
		2595	24	23.31	0	22.48	1	
		2577.5	24	23.28	0	22.59	1	
	36RB High (38)	2612.5	24	22.66	1	21.75	2	
		2595	24	22.31	1	21.29	2	
		2577.5	24	22.47	1	21.43	2	
	36RB Middle (19)	2612.5	24	22.56	1	21.67	2	
		2595	24	22.24	1	21.21	2	
		2577.5	24	22.31	1	21.26	2	
	36RB Low (0)	2612.5	24	22.59	1	21.55	2	
		2595	24	22.12	1	21.24	2	
		2577.5	24	22.23	1	21.19	2	
	75RB (0)	2612.5	24	22.51	1	21.63	2	
		2595	24	22.09	1	21.25	2	
		2577.5	24	22.34	1	21.26	2	
	20 MHz	1RB High (99)	2610	24	23.61	0	22.92	1
			2595	24	23.61	0	22.97	1
			2580	24	23.47	0	22.72	1
		1RB Middle (50)	2610	24	23.82	0	22.58	1
			2595	24	23.17	0	22.67	1
			2580	24	23.26	0	22.61	1
		1RB Low (0)	2610	24	23.37	0	22.81	1
			2595	24	23.10	0	22.48	1
			2580	24	23.21	0	22.63	1
50RB High (50)		2610	24	22.61	1	21.67	2	
		2595	24	22.41	1	21.33	2	
		2580	24	22.35	1	21.42	2	
50RB Middle (25)		2610	24	22.68	1	21.44	2	
		2595	24	22.48	1	21.26	2	
		2580	24	22.25	1	21.19	2	
50RB Low (0)		2610	24	22.62	1	21.36	2	
		2595	24	22.25	1	21.21	2	
		2580	24	22.30	1	21.12	2	
100RB (0)		2610	24	22.70	1	21.65	2	
		2595	24	22.37	1	21.37	2	
		2580	24	22.29	1	21.35	2	

Band 41							
Bandwidth (MHz)	RB allocation	Frequency (MHz)	Max. Target Power (dBm)	QPSK		16QAM	
	RB offset (Start RB)			Actual output power (dBm)	MPR	Actual output power (dBm)	MPR
5 MHz	1RB High (24)	2687.5	24	23.35	0	22.92	1
		2640.3	24	23.49	0	22.69	1
		2593	24	22.55	0	21.92	1
		2545.8	24	22.67	0	22.00	1
		2498.5	24	22.37	0	21.86	1
	1RB Middle (12)	2687.5	24	23.40	0	22.96	1
		2640.3	24	22.86	0	22.39	1
		2593	24	22.41	0	21.99	1
		2545.8	24	22.71	0	21.93	1
		2498.5	24	22.38	0	21.87	1
	1RB Low (0)	2687.5	24	23.50	0	22.97	1
		2640.3	24	23.34	0	22.63	1
		2593	24	22.85	0	22.02	1
		2545.8	24	22.66	0	21.97	1
		2498.5	24	22.65	0	21.98	1
	12RB High (13)	2687.5	24	22.44	1	21.38	2
		2640.3	24	22.58	1	21.53	2
		2593	24	21.70	1	20.73	2
		2545.8	24	21.59	1	20.68	2
		2498.5	24	21.45	1	20.60	2
	12RB Middle (6)	2687.5	24	22.45	1	21.40	2
		2640.3	24	22.54	1	21.60	2
		2593	24	21.63	1	20.83	2
		2545.8	24	21.37	1	20.63	2
		2498.5	24	21.52	1	20.68	2
	12RB Low (0)	2687.5	24	22.77	1	21.74	2
		2640.3	24	22.27	1	21.37	2
		2593	24	21.88	1	20.85	2
		2545.8	24	21.28	1	20.57	2
		2498.5	24	21.56	1	20.73	2
	25RB (0)	2687.5	24	22.45	1	21.45	2
		2640.3	24	22.57	1	21.44	2
		2593	24	21.87	1	20.86	2
		2545.8	24	21.60	1	20.44	2
		2498.5	24	21.25	1	20.65	2
	10 MHz	1RB High (49)	2685	24	23.78	0	22.95
2639			24	23.74	0	22.83	1
2593			24	23.53	0	22.38	1



		2547	24	22.82	0	22.30	1	
		2501	24	23.24	0	22.31	1	
	1RB Middle (24)	2685	24	23.47	0	22.91	1	
		2639	24	23.55	0	22.90	1	
		2593	24	23.15	0	22.05	1	
		2547	24	22.55	0	22.27	1	
		2501	24	22.77	0	21.85	1	
		2685	24	23.77	0	22.97	1	
	1RB Low (0)	2639	24	23.35	0	22.93	1	
		2593	24	22.77	0	22.22	1	
		2547	24	22.65	0	22.32	1	
		2501	24	22.43	0	22.14	1	
		2685	24	22.52	1	21.75	2	
	25RB High (25)	2639	24	22.46	1	21.73	2	
		2593	24	21.66	1	20.97	2	
		2547	24	21.73	1	20.66	2	
		2501	24	21.49	1	20.71	2	
		2685	24	22.46	1	21.80	2	
	25RB Middle (12)	2639	24	22.26	1	21.65	2	
		2593	24	21.63	1	20.88	2	
		2547	24	21.37	1	20.57	2	
		2501	24	21.48	1	20.57	2	
		2685	24	22.37	1	21.70	2	
	25RB Low (0)	2639	24	22.55	1	21.64	2	
		2593	24	21.66	1	20.84	2	
		2547	24	21.54	1	20.35	2	
		2501	24	21.46	1	20.67	2	
		2685	24	22.53	1	21.72	2	
	50RB (0)	2639	24	22.26	1	21.52	2	
		2593	24	21.69	1	20.88	2	
		2547	24	21.42	1	20.72	2	
		2501	24	21.44	1	20.68	2	
		15 MHz	1RB High (74)	2682.5	24	23.81	0	22.99
	2637.8			24	23.49	0	22.88	1
	2593			24	23.00	0	21.95	1
	2548.3			24	22.79	0	21.98	1
	2503.5			24	22.40	0	21.90	1
	1RB Middle (37)		2682.5	24	23.37	0	22.97	1
			2637.8	24	23.29	0	22.26	1
			2593	24	22.59	0	21.79	1
2548.3			24	22.57	0	21.84	1	
2503.5			24	22.20	0	21.72	1	

	1RB Low (0)	2682.5	24	23.88	0	22.91	1
		2637.8	24	23.27	0	22.30	1
		2593	24	22.58	0	22.01	1
		2548.3	24	22.63	0	22.22	1
		2503.5	24	22.31	0	22.06	1
	36RB High (38)	2682.5	24	22.66	1	21.85	2
		2637.8	24	22.56	1	21.39	2
		2593	24	21.79	1	20.54	2
		2548.3	24	21.63	1	20.64	2
		2503.5	24	21.49	1	20.58	2
	36RB Middle (19)	2682.5	24	22.56	1	21.70	2
		2637.8	24	22.57	1	21.42	2
		2593	24	21.75	1	20.51	2
		2548.3	24	21.41	1	20.59	2
		2503.5	24	21.43	1	20.59	2
	36RB Low (0)	2682.5	24	22.62	1	21.69	2
		2637.8	24	22.14	1	21.21	2
		2593	24	21.74	1	20.79	2
		2548.3	24	21.54	1	20.44	2
		2503.5	24	21.61	1	20.29	2
	75RB (0)	2682.5	24	22.60	1	21.59	2
		2637.8	24	22.54	1	21.34	2
		2593	24	21.83	1	20.79	2
		2548.3	24	21.54	1	20.58	2
		2503.5	24	21.59	1	20.53	2
20 MHz	1RB High (99)	2680	24	23.79	0	22.90	1
		2636.5	24	23.42	0	22.81	1
		2593	24	23.01	0	22.37	1
		2549.5	24	22.56	0	21.92	1
		2506	24	22.58	0	21.68	1
	1RB Middle (50)	2680	24	23.54	0	22.78	1
		2636.5	24	23.25	0	22.63	1
		2593	24	22.96	0	21.81	1
		2549.5	24	22.29	0	21.91	1
		2506	24	22.41	0	21.69	1
	1RB Low (0)	2680	24	23.43	0	22.59	1
		2636.5	24	23.05	0	22.23	1
		2593	24	22.53	0	21.71	1
		2549.5	24	22.23	0	21.54	1
		2506	24	22.44	0	21.26	1
	50RB High (50)	2680	24	22.53	1	21.50	2
		2636.5	24	22.32	1	21.29	2





		2593	24	21.92	1	20.76	2
		2549.5	24	21.39	1	20.61	2
		2506	24	21.51	1	20.55	2
	50RB Middle (25)	2680	24	22.68	1	21.76	2
		2636.5	24	22.63	1	21.38	2
		2593	24	21.72	1	20.74	2
		2549.5	24	21.33	1	20.49	2
		2506	24	21.60	1	20.50	2
	50RB Low (0)	2680	24	22.58	1	21.40	2
		2636.5	24	22.04	1	21.05	2
		2593	24	21.83	1	20.73	2
		2549.5	24	21.45	1	20.36	2
		2506	24	21.38	1	20.52	2
	100RB (0)	2680	24	22.43	1	21.50	2
		2636.5	24	22.05	1	21.04	2
		2593	24	21.77	1	20.74	2
		2549.5	24	21.59	1	20.53	2
		2506	24	21.57	1	20.55	2

Band 4							
Bandwidth (MHz)	RB allocation	Frequency (MHz)	Max. Target Power (dBm)	QPSK		16QAM	
	RB offset (Start RB)			Actual output power (dBm)	MPR	Actual output power (dBm)	MPR
1.4 MHz	1RB High (5)	1754.3	25	23.97	0	22.99	1
		1732.5	25	24.15	0	23.28	1
		1710.7	25	24.34	0	23.80	1
	1RB Middle (3)	1754.3	25	23.96	0	23.11	1
		1732.5	25	24.19	0	23.27	1
		1710.7	25	24.39	0	23.66	1
	1RB Low (0)	1754.3	25	23.92	0	23.07	1
		1732.5	25	24.22	0	23.27	1
		1710.7	25	24.34	0	23.66	1
	3RB High (3)	1754.3	25	23.87	0	23.09	1
		1732.5	25	24.14	0	23.20	1
		1710.7	25	24.28	0	23.52	1
	3RB Middle (1)	1754.3	25	23.95	0	23.09	1
		1732.5	25	24.18	0	23.24	1
		1710.7	25	24.37	0	23.51	1
	3RB Low (0)	1754.3	25	23.95	0	23.11	1
		1732.5	25	24.16	0	23.22	1
		1710.7	25	24.35	0	23.56	1
	6RB (0)	1754.3	25	23.91	1	22.78	2
		1732.5	25	23.86	1	22.88	2
1710.7		25	24.00	1	22.99	2	

3 MHz	1RB High (14)	1753.5	25	23.93	0	23.22	1
		1732.5	25	24.22	0	23.25	1
		1711.5	25	24.31	0	23.22	1
	1RB Middle (7)	1753.5	25	24.24	0	23.41	1
		1732.5	25	24.23	0	23.43	1
		1711.5	25	24.41	0	23.28	1
	1RB Low (0)	1753.5	25	24.07	0	23.49	1
		1732.5	25	24.27	0	23.46	1
		1711.5	25	24.36	0	23.37	1
	8RB High (7)	1753.5	25	22.91	1	22.02	2
		1732.5	25	23.11	1	22.17	2
		1711.5	25	23.33	1	22.38	2
	8RB Middle (4)	1753.5	25	22.90	1	22.02	2
		1732.5	25	23.14	1	22.23	2
		1711.5	25	23.32	1	22.43	2
8RB Low (0)	1753.5	25	22.97	1	22.09	2	
	1732.5	25	23.16	1	22.26	2	
	1711.5	25	23.37	1	22.48	2	
15RB (0)	1753.5	25	22.97	1	22.00	2	
	1732.5	25	23.18	1	22.12	2	
	1711.5	25	23.35	1	22.38	2	
5 MHz	1RB High (24)	1752.5	25	24.02	0	23.12	1
		1732.5	25	24.24	0	23.27	1
		1712.5	25	24.35	0	23.84	1
	1RB Middle (12)	1752.5	25	24.03	0	23.20	1
		1732.5	25	24.25	0	23.35	1
		1712.5	25	24.27	0	23.87	1
	1RB Low (0)	1752.5	25	24.18	0	23.42	1
		1732.5	25	24.47	0	23.48	1
		1712.5	25	24.59	0	24.00	1
	12RB High (13)	1752.5	25	22.97	1	22.08	2
		1732.5	25	23.15	1	22.20	2
		1712.5	25	23.23	1	22.37	2
	12RB Middle (6)	1752.5	25	23.06	1	22.09	2
		1732.5	25	23.18	1	22.27	2
		1712.5	25	23.31	1	22.45	2
	12RB Low (0)	1752.5	25	23.08	1	22.20	2
		1732.5	25	23.23	1	22.32	2
		1712.5	25	23.34	1	22.54	2
25RB (0)	1752.5	25	23.01	1	21.98	2	
	1732.5	25	23.18	1	22.19	2	
	1712.5	25	23.36	1	22.36	2	
10 MHz	1RB High (49)	1750	25	24.52	0	23.84	1
		1732.5	25	24.61	0	23.67	1
		1715	25	24.58	0	23.79	1
	1RB Middle (24)	1750	25	24.06	0	23.44	1
		1732.5	25	24.09	0	23.14	1
		1715	25	24.29	0	23.05	1

	1RB Low (0)	1750	25	24.36	0	23.75	1	
		1732.5	25	24.58	0	23.58	1	
		1715	25	24.63	0	23.68	1	
	25RB High (25)	1750	25	23.15	1	22.13	2	
		1732.5	25	23.24	1	22.36	2	
		1715	25	23.44	1	22.48	2	
	25RB Middle (12)	1750	25	23.05	1	22.08	2	
		1732.5	25	23.21	1	22.27	2	
		1715	25	23.26	1	22.29	2	
	25RB Low (0)	1750	25	23.02	1	22.06	2	
		1732.5	25	23.23	1	22.31	2	
		1715	25	23.32	1	22.35	2	
50RB (0)	1750	25	23.11	1	22.15	2		
	1732.5	25	23.28	1	22.30	2		
	1715	25	23.36	1	22.35	2		
15 MHz	1RB High (74)	1747.5	25	23.85	0	23.26	1	
		1732.5	25	24.17	0	23.11	1	
		1717.5	25	24.07	0	23.46	1	
	1RB Middle (37)	1747.5	25	23.88	0	23.24	1	
		1732.5	25	24.10	0	22.97	1	
		1717.5	25	24.19	0	23.50	1	
	1RB Low (0)	1747.5	25	24.22	0	23.61	1	
		1732.5	25	24.21	0	23.20	1	
		1717.5	25	24.43	0	23.67	1	
	36RB High (38)	1747.5	25	22.90	1	21.89	2	
		1732.5	25	23.05	1	22.03	2	
		1717.5	25	23.06	1	22.11	2	
	36RB Middle (19)	1747.5	25	22.88	1	21.80	2	
		1732.5	25	23.13	1	22.13	2	
		1717.5	25	23.15	1	22.19	2	
	36RB Low (0)	1747.5	25	22.94	1	21.92	2	
		1732.5	25	23.17	1	22.21	2	
		1717.5	25	23.15	1	22.21	2	
	75RB (0)	1747.5	25	22.83	1	21.88	2	
		1732.5	25	23.11	1	22.09	2	
		1717.5	25	23.13	1	22.16	2	
	20 MHz	1RB High (99)	1745	25	23.94	0	23.48	1
			1732.5	25	24.10	0	23.54	1
			1720	25	24.12	0	23.70	1
1RB Middle (50)		1745	25	23.81	0	23.31	1	
		1732.5	25	24.02	0	23.55	1	
		1720	25	23.90	0	23.65	1	
1RB Low (0)		1745	25	24.00	0	23.39	1	
		1732.5	25	24.07	0	23.55	1	
		1720	25	24.06	0	23.71	1	
50RB High (50)		1745	25	22.89	1	21.87	2	
		1732.5	25	22.98	1	21.94	2	
		1720	25	22.97	1	22.00	2	

	50RB Middle (25)	1745	25	22.92	1	21.89	2
		1732.5	25	23.03	1	22.06	2
		1720	25	23.06	1	22.16	2
	50RB Low (0)	1745	25	22.99	1	21.96	2
		1732.5	25	23.18	1	22.13	2
		1720	25	23.08	1	22.09	2
	100RB (0)	1745	25	22.90	1	21.91	2
		1732.5	25	23.07	1	22.07	2
		1720	25	23.06	1	22.10	2

Band 26							
Bandwidth (MHz)	RB allocation RB offset (Start RB)	Frequency (MHz)	Max. Target Power (dBm)	QPSK		16QAM	
				Actual output power (dBm)	MPR	Actual output power (dBm)	MPR
1.4 MHz	1RB High (5)	848.3	24.5	23.97	0	22.97	1
		831.5	24.5	24.15	0	23.49	1
		814.7	24.5	23.77	0	22.76	1
	1RB Middle (3)	848.3	24.5	23.80	0	23.00	1
		831.5	24.5	24.13	0	23.47	1
		814.7	24.5	23.77	0	22.72	1
	1RB Low (0)	848.3	24.5	23.94	0	22.91	1
		831.5	24.5	23.98	0	23.41	1
		814.7	24.5	23.76	0	22.90	1
	3RB High (3)	848.3	24.5	23.87	0	22.80	1
		831.5	24.5	24.09	0	23.06	1
		814.7	24.5	23.77	0	22.71	1
	3RB Middle (1)	848.3	24.5	23.96	0	22.87	1
		831.5	24.5	23.99	0	23.01	1
		814.7	24.5	23.82	0	22.77	1
	3RB Low (0)	848.3	24.5	23.87	0	22.78	1
		831.5	24.5	23.83	0	23.15	1
		814.7	24.5	23.77	0	22.77	1
	6RB (0)	848.3	24.5	23.36	1	22.44	2
		831.5	24.5	23.44	1	22.49	2
		814.7	24.5	23.33	1	22.47	2
3 MHz	1RB High (14)	847.5	24.5	23.86	0	23.34	1
		831.5	24.5	23.90	0	22.77	1
		815.5	24.5	24.03	0	22.77	1
	1RB Middle (7)	847.5	24.5	23.90	0	23.25	1
		831.5	24.5	23.82	0	22.69	1
		815.5	24.5	23.85	0	22.73	1
	1RB Low (0)	847.5	24.5	23.98	0	23.31	1
		831.5	24.5	23.90	0	23.02	1
		815.5	24.5	23.90	0	22.83	1
	8RB High (7)	847.5	24.5	22.96	1	22.00	2
		831.5	24.5	22.98	1	22.02	2
		815.5	24.5	22.99	1	22.06	2

	8RB Middle (4)	847.5	24.5	23.07	1	22.00	2	
		831.5	24.5	22.97	1	22.08	2	
		815.5	24.5	22.97	1	22.04	2	
	8RB Low (0)	847.5	24.5	22.97	1	21.95	2	
		831.5	24.5	22.89	1	21.94	2	
		815.5	24.5	22.89	1	21.98	2	
	15RB (0)	847.5	24.5	23.04	1	21.95	2	
		831.5	24.5	22.92	1	21.92	2	
		815.5	24.5	22.93	1	21.82	2	
5 MHz	1RB High (24)	846.5	24.5	23.88	0	23.49	1	
		831.5	24.5	23.85	0	23.08	1	
		816.5	24.5	24.05	0	22.96	1	
	1RB Middle (12)	846.5	24.5	23.93	0	23.48	1	
		831.5	24.5	23.95	0	22.90	1	
		816.5	24.5	23.85	0	22.85	1	
	1RB Low (0)	846.5	24.5	24.07	0	23.45	1	
		831.5	24.5	23.92	0	23.04	1	
		816.5	24.5	24.12	0	22.90	1	
	12RB High (13)	846.5	24.5	23.00	1	22.16	2	
		831.5	24.5	23.05	1	22.15	2	
		816.5	24.5	23.06	1	21.85	2	
	12RB Middle (6)	846.5	24.5	23.22	1	22.13	2	
		831.5	24.5	23.03	1	21.99	2	
		816.5	24.5	23.08	1	21.85	2	
	12RB Low (0)	846.5	24.5	23.04	1	22.18	2	
		831.5	24.5	23.04	1	22.08	2	
		816.5	24.5	23.17	1	21.91	2	
	25RB (0)	846.5	24.5	23.05	1	22.02	2	
		831.5	24.5	22.96	1	21.95	2	
		816.5	24.5	22.98	1	21.81	2	
	10 MHz	1RB High (49)	844	24.5	23.61	0	22.96	1
			831.5	24.5	23.88	0	22.45	1
			820	24.5	23.78	0	22.23	1
1RB Middle (24)		844	24.5	24.01	0	23.38	1	
		831.5	24.5	24.30	0	22.88	1	
		820	24.5	24.06	0	22.69	1	
1RB Low (0)		844	24.5	23.74	0	22.90	1	
		831.5	24.5	24.06	0	22.49	1	
		820	24.5	23.55	0	22.40	1	
25RB High (25)		844	24.5	22.92	1	21.83	2	
		831.5	24.5	22.86	1	21.91	2	
		820	24.5	22.69	1	21.72	2	
25RB Middle (12)		844	24.5	23.05	1	22.01	2	
		831.5	24.5	22.92	1	21.97	2	
		820	24.5	22.86	1	21.88	2	
25RB Low (0)		844	24.5	22.79	1	21.89	2	
		831.5	24.5	22.88	1	21.88	2	
		820	24.5	22.70	1	21.70	2	

	50RB (0)	844	24.5	22.94	1	21.95	2
		831.5	24.5	22.84	1	21.81	2
		820	24.5	22.78	1	21.75	2
15 MHz	1RB High (74)	841.5	24.5	24.13	0	23.28	1
		831.5	24.5	24.00	0	22.90	1
		822.5	24.5	24.04	0	23.23	1
	1RB Middle (37)	841.5	24.5	23.83	0	23.35	1
		831.5	24.5	23.88	0	22.73	1
		822.5	24.5	23.87	0	23.48	1
	1RB Low (0)	841.5	24.5	24.18	0	23.43	1
		831.5	24.5	23.96	0	22.98	1
		822.5	24.5	24.16	0	23.24	1
	36RB High (38)	841.5	24.5	22.99	1	22.06	2
		831.5	24.5	22.91	1	21.95	2
		822.5	24.5	22.91	1	21.98	2
	36RB Middle (19)	841.5	24.5	23.09	1	22.03	2
		831.5	24.5	22.89	1	21.88	2
		822.5	24.5	22.84	1	21.93	2
	36RB Low (0)	841.5	24.5	23.18	1	22.16	2
		831.5	24.5	23.00	1	22.01	2
		822.5	24.5	22.93	1	21.97	2
	75RB (0)	841.5	24.5	23.12	1	22.15	2
		831.5	24.5	22.87	1	21.89	2
		822.5	24.5	22.89	1	21.95	2

**Low power**

**Table 11.3-2: The conducted Power for LTE**

Band 7							
Bandwidth (MHz)	RB allocation	Frequency (MHz)	Max. Target Power (dBm)	QPSK		16QAM	
	RB offset (Start RB)			Actual output power (dBm)	MPR	Actual output power (dBm)	MPR
5 MHz	1RB High (24)	2567.5	20.5	20.00	/	20.44	/
		2535	20.5	20.10	/	20.22	/
		2502.5	20.5	19.98	/	20.34	/
	1RB Middle (12)	2567.5	20.5	20.03	/	20.24	/
		2535	20.5	20.17	/	20.17	/
		2502.5	20.5	19.98	/	20.33	/
	1RB Low (0)	2567.5	20.5	20.18	/	20.38	/
		2535	20.5	20.23	/	20.35	/
		2502.5	20.5	20.16	/	20.45	/
	12RB High (13)	2567.5	20.5	20.03	/	20.23	/
		2535	20.5	20.05	/	20.21	/
		2502.5	20.5	20.09	/	20.26	/
	12RB Middle (6)	2567.5	20.5	20.06	/	20.25	/
		2535	20.5	20.06	/	20.21	/
		2502.5	20.5	20.13	/	20.31	/

	12RB Low (0)	2567.5	20.5	20.05	/	20.28	/	
		2535	20.5	20.10	/	20.25	/	
		2502.5	20.5	20.15	/	20.33	/	
	25RB (0)	2567.5	20.5	20.04	/	20.16	/	
		2535	20.5	20.12	/	20.18	/	
		2502.5	20.5	20.16	/	20.22	/	
10 MHz	1RB High (49)	2565	20.5	20.13	/	20.27	/	
		2535	20.5	20.14	/	20.13	/	
		2505	20.5	20.33	/	20.43	/	
	1RB Middle (24)	2565	20.5	19.91	/	20.11	/	
		2535	20.5	19.97	/	19.96	/	
		2505	20.5	20.04	/	20.41	/	
	1RB Low (0)	2565	20.5	20.22	/	20.30	/	
		2535	20.5	20.16	/	20.20	/	
		2505	20.5	20.31	/	20.45	/	
	25RB High (25)	2565	20.5	19.99	/	20.20	/	
		2535	20.5	20.00	/	20.10	/	
		2505	20.5	20.04	/	20.13	/	
	25RB Middle (12)	2565	20.5	20.04	/	20.15	/	
		2535	20.5	20.04	/	20.09	/	
		2505	20.5	20.07	/	20.19	/	
	25RB Low (0)	2565	20.5	20.09	/	20.31	/	
		2535	20.5	20.11	/	20.14	/	
		2505	20.5	20.14	/	20.21	/	
	50RB (0)	2565	20.5	20.08	/	20.16	/	
		2535	20.5	20.08	/	20.10	/	
		2505	20.5	20.09	/	20.14	/	
	15 MHz	1RB High (74)	2562.5	20.5	20.18	/	20.48	/
			2535	20.5	20.09	/	20.11	/
			2507.5	20.5	20.18	/	20.41	/
1RB Middle (37)		2562.5	20.5	20.07	/	20.44	/	
		2535	20.5	20.08	/	20.06	/	
		2507.5	20.5	20.20	/	20.44	/	
1RB Low (0)		2562.5	20.5	20.15	/	20.48	/	
		2535	20.5	20.04	/	20.09	/	
		2507.5	20.5	20.28	/	20.48	/	
36RB High (38)		2562.5	20.5	20.26	/	20.31	/	
		2535	20.5	20.27	/	20.27	/	
		2507.5	20.5	20.28	/	20.33	/	
36RB Middle (19)		2562.5	20.5	20.15	/	20.22	/	
		2535	20.5	20.22	/	20.25	/	
		2507.5	20.5	20.30	/	20.39	/	
36RB Low (0)		2562.5	20.5	20.11	/	20.21	/	
		2535	20.5	20.20	/	20.24	/	
		2507.5	20.5	20.26	/	20.38	/	
75RB (0)		2562.5	20.5	20.04	/	20.17	/	
		2535	20.5	20.19	/	20.25	/	
		2507.5	20.5	20.28	/	20.33	/	

20 MHz	1RB High (99)	2560	20.5	20.17	/	20.41	/
		2535	20.5	20.22	/	20.49	/
		2510	20.5	20.28	/	20.45	/
	1RB Middle (50)	2560	20.5	20.31	/	20.48	/
		2535	20.5	20.13	/	20.47	/
		2510	20.5	20.22	/	20.43	/
	1RB Low (0)	2560	20.5	20.21	/	20.47	/
		2535	20.5	20.00	/	20.44	/
		2510	20.5	20.26	/	20.49	/
	50RB High (50)	2560	20.5	20.21	/	20.31	/
		2535	20.5	20.18	/	20.23	/
		2510	20.5	20.25	/	20.25	/
	50RB Middle (25)	2560	20.5	20.18	/	20.29	/
		2535	20.5	20.20	/	20.26	/
		2510	20.5	20.36	/	20.29	/
	50RB Low (0)	2560	20.5	20.16	/	20.16	/
		2535	20.5	20.24	/	20.23	/
		2510	20.5	20.29	/	20.35	/
	100RB (0)	2560	20.5	20.21	/	20.20	/
		2535	20.5	20.21	/	20.21	/
		2510	20.5	20.28	/	20.38	/

Band 4							
Bandwidth (MHz)	RB allocation	Frequency (MHz)	Max. Target Power (dBm)	QPSK		16QAM	
	RB offset (Start RB)			Actual output power (dBm)	MPR	Actual output power (dBm)	MPR
1.4 MHz	1RB High (5)	1754.3	23.5	22.49	/	22.48	/
		1732.5	23.5	22.64	/	22.74	/
		1710.7	23.5	22.80	/	23.21	/
	1RB Middle (3)	1754.3	23.5	22.46	/	22.51	/
		1732.5	23.5	22.74	/	22.80	/
		1710.7	23.5	22.91	/	23.24	/
	1RB Low (0)	1754.3	23.5	22.45	/	22.49	/
		1732.5	23.5	22.68	/	22.79	/
		1710.7	23.5	22.91	/	23.23	/
	3RB High (3)	1754.3	23.5	22.42	/	22.58	/
		1732.5	23.5	22.62	/	22.68	/
		1710.7	23.5	22.85	/	22.97	/
	3RB Middle (1)	1754.3	23.5	22.44	/	22.66	/
		1732.5	23.5	22.63	/	22.75	/
		1710.7	23.5	22.89	/	23.02	/
	3RB Low (0)	1754.3	23.5	22.39	/	22.66	/
		1732.5	23.5	22.67	/	22.70	/
		1710.7	23.5	22.85	/	23.02	/
	6RB (0)	1754.3	23.5	22.40	/	22.60	/
		1732.5	23.5	22.66	/	22.70	/
		1710.7	23.5	22.87	/	23.01	/



3 MHz	1RB High (14)	1753.5	23.5	22.40	/	22.54	/
		1732.5	23.5	22.60	/	22.58	/
		1711.5	23.5	22.83	/	23.23	/
	1RB Middle (7)	1753.5	23.5	22.53	/	22.64	/
		1732.5	23.5	22.65	/	22.67	/
		1711.5	23.5	22.83	/	23.23	/
	1RB Low (0)	1753.5	23.5	22.50	/	22.76	/
		1732.5	23.5	22.75	/	22.73	/
		1711.5	23.5	22.93	/	23.33	/
	8RB High (7)	1753.5	23.5	22.46	/	22.08	/
		1732.5	23.5	22.62	/	22.28	/
		1711.5	23.5	22.85	/	22.42	/
	8RB Middle (4)	1753.5	23.5	22.48	/	22.15	/
		1732.5	23.5	22.64	/	22.33	/
		1711.5	23.5	22.84	/	22.47	/
8RB Low (0)	1753.5	23.5	22.51	/	22.16	/	
	1732.5	23.5	22.69	/	22.29	/	
	1711.5	23.5	22.90	/	22.46	/	
15RB (0)	1753.5	23.5	22.50	/	22.05	/	
	1732.5	23.5	22.69	/	22.24	/	
	1711.5	23.5	22.81	/	22.40	/	
5 MHz	1RB High (24)	1752.5	23.5	22.53	/	22.64	/
		1732.5	23.5	22.70	/	22.92	/
		1712.5	23.5	22.82	/	23.31	/
	1RB Middle (12)	1752.5	23.5	22.53	/	22.56	/
		1732.5	23.5	22.72	/	22.75	/
		1712.5	23.5	22.64	/	23.31	/
	1RB Low (0)	1752.5	23.5	22.72	/	22.79	/
		1732.5	23.5	22.94	/	23.05	/
		1712.5	23.5	23.03	/	23.42	/
	12RB High (13)	1752.5	23.5	22.53	/	22.04	/
		1732.5	23.5	22.64	/	22.21	/
		1712.5	23.5	22.79	/	22.44	/
	12RB Middle (6)	1752.5	23.5	22.55	/	22.15	/
		1732.5	23.5	22.67	/	22.30	/
		1712.5	23.5	22.83	/	22.49	/
	12RB Low (0)	1752.5	23.5	22.61	/	22.20	/
		1732.5	23.5	22.75	/	22.36	/
		1712.5	23.5	22.89	/	22.52	/
25RB (0)	1752.5	23.5	22.59	/	22.04	/	
	1732.5	23.5	22.70	/	22.23	/	
	1712.5	23.5	22.84	/	22.46	/	
10 MHz	1RB High (49)	1750	23.5	22.95	/	22.92	/
		1732.5	23.5	23.09	/	23.04	/
		1715	23.5	23.31	/	23.47	/
	1RB Middle (24)	1750	23.5	22.56	/	22.48	/
		1732.5	23.5	22.59	/	22.63	/
		1715	23.5	22.74	/	23.11	/

	1RB Low (0)	1750	23.5	22.88	/	22.87	/	
		1732.5	23.5	23.03	/	22.97	/	
		1715	23.5	23.18	/	23.45	/	
	25RB High (25)	1750	23.5	22.68	/	22.23	/	
		1732.5	23.5	22.76	/	22.32	/	
		1715	23.5	22.94	/	22.50	/	
	25RB Middle (12)	1750	23.5	22.59	/	22.14	/	
		1732.5	23.5	22.69	/	22.18	/	
		1715	23.5	22.79	/	22.35	/	
	25RB Low (0)	1750	23.5	22.54	/	22.12	/	
		1732.5	23.5	22.74	/	22.25	/	
		1715	23.5	22.87	/	22.40	/	
50RB (0)	1750	23.5	22.64	/	22.18	/		
	1732.5	23.5	22.76	/	22.26	/		
	1715	23.5	22.88	/	22.39	/		
15 MHz	1RB High (74)	1747.5	23.5	22.40	/	22.71	/	
		1732.5	23.5	22.43	/	22.52	/	
		1717.5	23.5	22.58	/	22.94	/	
	1RB Middle (37)	1747.5	23.5	22.34	/	22.73	/	
		1732.5	23.5	22.55	/	22.53	/	
		1717.5	23.5	22.61	/	23.02	/	
	1RB Low (0)	1747.5	23.5	22.63	/	22.98	/	
		1732.5	23.5	22.71	/	22.63	/	
		1717.5	23.5	22.79	/	23.22	/	
	36RB High (38)	1747.5	23.5	22.40	/	21.88	/	
		1732.5	23.5	22.57	/	22.05	/	
		1717.5	23.5	22.64	/	22.13	/	
	36RB Middle (19)	1747.5	23.5	22.38	/	21.87	/	
		1732.5	23.5	22.61	/	22.13	/	
		1717.5	23.5	22.68	/	22.26	/	
	36RB Low (0)	1747.5	23.5	22.44	/	21.86	/	
		1732.5	23.5	22.70	/	22.20	/	
		1717.5	23.5	22.68	/	22.22	/	
	75RB (0)	1747.5	23.5	22.38	/	21.87	/	
		1732.5	23.5	22.60	/	22.11	/	
		1717.5	23.5	22.65	/	22.19	/	
	20 MHz	1RB High (99)	1745	23.5	22.39	/	22.83	/
			1732.5	23.5	22.50	/	22.92	/
			1720	23.5	22.63	/	23.14	/
		1RB Middle (50)	1745	23.5	22.35	/	22.79	/
			1732.5	23.5	22.46	/	22.84	/
			1720	23.5	22.88	/	23.04	/
1RB Low (0)		1745	23.5	22.40	/	22.81	/	
		1732.5	23.5	22.51	/	22.92	/	
		1720	23.5	22.67	/	23.07	/	
50RB High (50)		1745	23.5	22.41	/	21.97	/	
		1732.5	23.5	22.38	/	21.96	/	
		1720	23.5	22.48	/	22.07	/	



	50RB Middle (25)	1745	23.5	22.40	/	21.94	/
		1732.5	23.5	22.49	/	22.11	/
		1720	23.5	22.60	/	22.12	/
	50RB Low (0)	1745	23.5	22.49	/	22.00	/
		1732.5	23.5	22.58	/	22.15	/
		1720	23.5	22.59	/	22.12	/
	100RB (0)	1745	23.5	22.43	/	21.94	/
		1732.5	23.5	22.46	/	22.08	/
		1720	23.5	22.58	/	22.11	/

The following conducted power measurement results of downlink LTE carrier aggregation are provided to quantify downlink only carrier aggregation SAR test exclusion per KDB 941225 D05A. Uplink maximum output power is measured with downlink carrier aggregation active, using the channel with highest measured maximum output power when downlink carrier aggregation is inactive, to confirm that when downlink carrier aggregation is active uplink maximum output power remains within the specified tune-up tolerance limits and not more than ¼ dB higher than the maximum output power measured when downlink carrier aggregation inactive.

The conducted power measurement results of downlink LTE CA are as below(**LowPower**):

DL LTE CA Class	PCC								SCC			Power		
	PCC Band	PCC Band width(MHz)	PCC ULR B size	PCC ULR B offset	PCC DLR B size	PCC DLR B offset	PCC UL Channel	PCC DL Channel	SCC Band	SCC Band width (MHz)	SCC DL Channel	Rel 8 LTETx Power(dBm)	Rel 10 DL LTE CATx Power(dBm)	Tune-up
7A-7A	7	20	50	25	100	0	20850	2850	7	20	3350	20.36	20.44	20.5
7C	7	20	50	25	100	0	20850	2850	7	20	3048	20.36	20.41	20.5
7A-1A	7	20	50	25	100	0	20850	2850	1	20	300	20.36	20.44	20.5
7A-3A	7	20	50	25	100	0	20850	2850	3	20	1575	20.36	20.44	20.5
7A-20A	7	20	50	25	100	0	20850	2850	20	20	6300	20.36	20.43	20.5
7A-28A	7	20	50	25	100	0	20850	2850	28	20	9460	20.36	20.42	20.5

Note: Testing is not required in bands or modes not intended/allowed for US operation.

The conducted power measurement results of downlink LTE CA are as below(**NormalPower**):

DL LTE CA Class	PCC								SCC			Power		
	PCC Band	PCC Band width(MHz)	PCC ULR B size	PCC ULR B offset	PCC DLR B size	PCC DLR B offset	PCC UL Channel	PCC DL Channel	SCC Band	SCC Band width (MHz)	SCC DL Channel	Rel 8 LTETx Power(dBm)	Rel 10 DL LTE CATx Power(dBm)	Tune-up
5A-3A	5	10	1	49	50	0	20450	2450	3	20	1575	23.72	23.65	24
7A-7A	7	10	1	0	50	0	20800	2800	7	20	3350	23.34	23.37	24.5
7C	7	20	1	0	100	0	20850	2850	7	20	3048	23.26	23.29	24.5
7A-1A	7	10	1	0	50	0	20800	2800	1	20	300	23.34	23.36	24.5
7A-3A	7	10	1	0	50	0	20800	2800	3	20	1575	23.34	23.32	24.5
7A-20A	7	10	1	0	50	0	20800	2800	20	20	6300	23.34	23.34	24.5
7A-28A	7	10	1	0	50	0	20800	2800	28	20	9460	23.34	23.33	24.5
38C	38	20	1	50	100	0	38150	38150	38	20	37952	23.82	23.88	24
40C	40	20	1	99	100	0	38750	38750	40	20	38948	24.24	24.21	24.5

Note: Testing is not required in bands or modes not intended/allowed for US operation.



### 11.4 Wi-Fi and BT Measurement result

The output power of BT antenna is as following:

Mode	Conducted Power (dBm)		
	Channel 0 (2402MHz)	Channel 39 (2441MHz)	Channel 78(2480MHz)
GFSK	7.25	8.75	8.05
Tune up	<b>7.5</b>	<b>9</b>	<b>8.5</b>
EDR2M-4_DQPSK	7.11	8.64	7.89
Tune up	<b>7.5</b>	<b>9</b>	<b>8.5</b>
EDR3M-8DPSK	7.36	8.95	8.25
Tune up	<b>7.5</b>	<b>9</b>	<b>8.5</b>

The average conducted power for Wi-Fi is as following:

#### NormalPower

802.11b (dBm)

Channel\data rate	1Mbps	2Mbps	5.5Mbps	11Mbps
1	18.16	/	18.31	/
6	18.49	18.35	18.50	18.00
11	18.19	/	18.29	/
Tune up	<b>19</b>	<b>19</b>	<b>19</b>	<b>19</b>

802.11g (dBm)

Channel\data rate	6Mbps	9Mbps	12Mbps	18Mbps	24Mbps	36Mbps	48Mbps	54Mbps
1	16.02	/	/	/	/	/	/	/
6	16.19	15.97	15.76	15.37	14.99	13.38	12.87	12.70
11	16.06	/	/	/	/	/	/	/
Tune up	<b>17</b>	<b>17</b>	<b>17</b>	<b>17</b>	<b>16</b>	<b>15</b>	<b>14</b>	<b>14</b>

802.11n (dBm) - HT20 (2.4G)

Channel\data rate	MCS0	MCS1	MCS2	MCS3	MCS4	MCS5	MCS6	MCS7
1	15.22	/	/	/	/	/	/	/
6	15.38	14.93	14.57	14.22	11.62	11.17	10.98	10.76
11	15.24	/	/	/	/	/	/	/
Tune up	<b>16</b>	<b>16</b>	<b>16</b>	<b>15</b>	<b>12</b>	<b>12</b>	<b>12</b>	<b>12</b>

802.11n (dBm) – HT40 (2.4G)

Channel\data rate	MCS0	MCS1	MCS2	MCS3	MCS4	MCS5	MCS6	MCS7
3	12.81	/	/	/	/	/	/	/
6	13.00	12.28	11.69	11.23	8.26	7.76	7.56	7.34
9	12.64	/	/	/	/	/	/	/
Tune up	<b>14</b>	<b>14</b>	<b>13</b>	<b>13</b>	<b>9</b>	<b>9</b>	<b>9</b>	<b>9</b>



**LowPower**

802.11b (dBm)

Channel\data rate	1Mbps	2Mbps	5.5Mbps	11Mbps
1	13.92	13.87	/	/
6	14.19	14.23	14.20	14.06
11	13.91	13.88	/	/
Tune up	<b>14.5</b>	<b>14.5</b>	<b>14.5</b>	<b>14.5</b>

802.11g (dBm)

Channel\data rate	6Mbps	9Mbps	12Mbps	18Mbps	24Mbps	36Mbps	48Mbps	54Mbps
1	13.72	/	/	/	/	/	/	/
6	13.96	13.91	13.84	13.70	13.55	13.92	13.11	13.03
11	13.86	/	/	/	/	/	/	/
Tune up	<b>14</b>	<b>14</b>	<b>14</b>	<b>14</b>	<b>14</b>	<b>14</b>	<b>14</b>	<b>14</b>

802.11n (dBm) - HT20 (2.4G)

Channel\data rate	MCS0	MCS1	MCS2	MCS3	MCS4	MCS5	MCS6	MCS7
1	13.80	/	/	/	/	/	/	/
6	13.94	13.87	13.73	13.56	13.31	13.08	12.99	12.87
11	13.93	/	/	/	/	/	/	/
Tune up	<b>14</b>	<b>14</b>	<b>14</b>	<b>14</b>	<b>14</b>	<b>14</b>	<b>14</b>	<b>14</b>

802.11n (dBm) – HT40 (2.4G)

Channel\data rate	MCS0	MCS1	MCS2	MCS3	MCS4	MCS5	MCS6	MCS7
3	11.44	/	/	/	/	/	/	/
6	11.70	11.46	11.22	10.94	10.50	10.15	9.97	9.85
9	11.33	/	/	/	/	/	/	/
Tune up	<b>12</b>	<b>12</b>	<b>12</b>	<b>12</b>	<b>11</b>	<b>11</b>	<b>11</b>	<b>11</b>



802.11a (dBm)

Channel\data rate	6Mbps	9Mbps	12Mbps	18Mbps	24Mbps	36Mbps	48Mbps	54Mbps
36	12.66	/	/	/	/	/	/	/
40	12.72	/	/	/	/	/	/	/
44	13.23	/	/	/	/	/	/	/
48	<b>13.37</b>	13.09	12.87	12.48	12.11	11.51	11.01	10.82
52	<b>13.64</b>	13.16	12.95	12.55	12.17	11.57	11.06	10.87
56	12.75	/	/	/	/	/	/	/
60	13.01	/	/	/	/	/	/	/
64	12.81	/	/	/	/	/	/	/
Tune up	<b>14</b>	<b>14</b>	<b>14</b>	<b>14</b>	<b>14</b>	<b>12</b>	<b>12</b>	<b>12</b>
100	11.27	/	/	/	/	/	/	/
104	11.11	/	/	/	/	/	/	/
108	11.33	/	/	/	/	/	/	/
112	11.76	/	/	/	/	/	/	/
116	<b>11.87</b>	11.83	11.61	11.22	10.84	9.93	9.73	9.53
120	11.81	/	/	/	/	/	/	/
124	11.42	/	/	/	/	/	/	/
128	10.77	/	/	/	/	/	/	/
132	10.29	/	/	/	/	/	/	/
136	10.09	/	/	/	/	/	/	/
140	10.41	/	/	/	/	/	/	/
144	11.11	/	/	/	/	/	/	/
Tune up	<b>12</b>	<b>12</b>	<b>12</b>	<b>12</b>	<b>12</b>	<b>10</b>	<b>10</b>	<b>10</b>
149	12.17	/	/	/	/	/	/	/
153	<b>12.45</b>	12.10	11.86	11.47	11.09	10.49	9.98	9.80
157	12.10	/	/	/	/	/	/	/
161	11.54	/	/	/	/	/	/	/
165	11.05	/	/	/	/	/	/	/
Tune up	<b>13</b>	<b>13</b>	<b>13</b>	<b>13</b>	<b>13</b>	<b>11</b>	<b>11</b>	<b>11</b>

## 12 Simultaneous TX SAR Considerations

### 12.1 Introduction

The following procedures adopted from “FCC SAR Considerations for Cell Phones with Multiple Transmitters” are applicable to handsets with built-in unlicensed transmitters such as 802.11 a/b/g and Bluetooth devices which may simultaneously transmit with the licensed transmitter.

For this device, the BT and Wi-Fi can transmit simultaneous with other transmitters.

### 12.2 Transmit Antenna Separation Distances

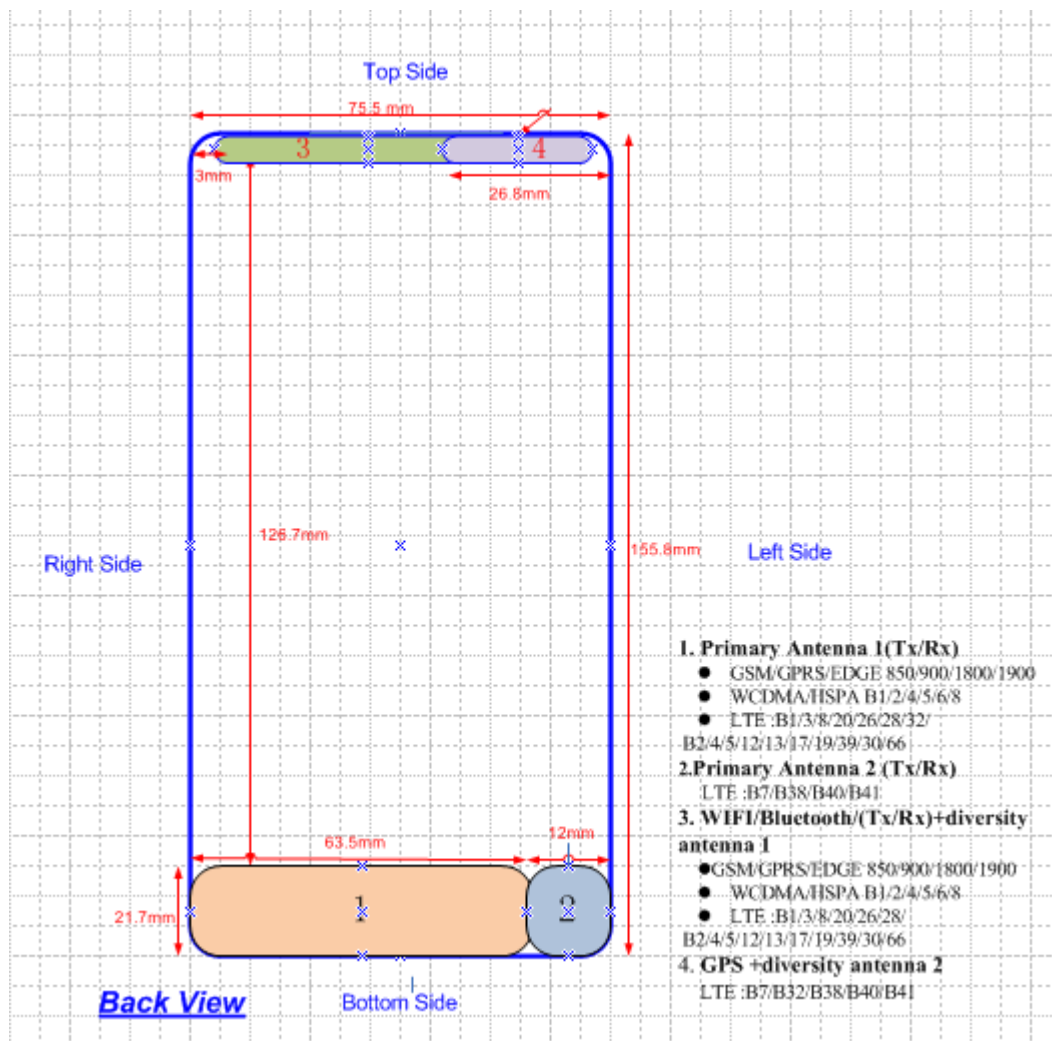

Picture 12.1 Antenna Locations



### 12.3 SAR Measurement Positions

According to the KDB941225 D06 Hot Spot SAR v01, the edges with less than 2.5 cm distance to the antennas need to be tested for SAR.

SAR measurement positions						
Mode	Front	Rear	Left edge	Right edge	Top edge	Bottom edge
Primary antenna 1	Yes	Yes	Yes	Yes	No	Yes
Primary antenna 2	Yes	Yes	Yes	No	No	Yes
WLAN	Yes	Yes	No	Yes	Yes	No

### 12.4 Standalone SAR Test Exclusion Considerations

Standalone 1-g head or body SAR evaluation by measurement or numerical simulation is not required when the corresponding SAR Exclusion Threshold condition, listed below, is satisfied. The 1-g SAR test exclusion threshold for 100 MHz to 6 GHz at test separation distances  $\leq 50$  mm are determined by:

$[(\text{max. power of channel, including tune-up tolerance, mW}) / (\text{min. test separation distance, mm})] \cdot [\sqrt{f(\text{GHz})}] \leq 3.0$  for 1-g SAR, where

- $f(\text{GHz})$  is the RF channel transmit frequency in GHz
- Power and distance are rounded to the nearest mW and mm before calculation
- The result is rounded to one decimal place for comparison

**Table 12.1: Standalone SAR test exclusion considerations**

Band/Mode	F(GHz)	Position	SAR test exclusion threshold(mW)	RF output power		SAR test exclusion
				dBm	mW	
Bluetooth	2.441	Head	9.60	9	7.94	Yes
		Body	19.20	9	7.94	Yes
2.4GHz WLAN	2.45	Head	9.58	19	79.43	No
		Body	19.17	19	79.43	No

### 13 Evaluation of Simultaneous

**Table 13.1: The sum of reported SAR values for main antenna and WiFi**

	Position	Main antenna	WiFi	Sum
<b>Highest reported SAR value for Head</b>	Left hand, Touch cheek	0.42	1.04	<b>1.46</b>
	Left hand, Tilt 15°	0.23	1.16	<b>1.39</b>
	Right hand, Touch cheek	0.63	0.88	<b>1.51</b>
	Right hand, Tilt 15°	0.33	0.95	<b>1.28</b>
<b>Highest reported SAR value for Body</b>	Front	1.26	0.31	<b>1.57</b>
	Top	/	0.53	<b>0.53</b>

Note: we have evaluated and chose the highest value of WiFi 2.4G and 5G in the above table

**Table 13.2: The sum of reported SAR values for main antenna and BT**

	Position	Main antenna	BT	Sum
<b>Maximum reported SAR value for Head</b>	Right hand, Touch cheek	0.63	0.33 <sup>[1]</sup>	<b>0.96</b>
<b>Maximum reported SAR value for Body</b>	Front	1.26	0.17 <sup>[1]</sup>	<b>1.43</b>

[1] - Estimated SAR for Bluetooth (see the table 13.3)

**Table 13.3: Estimated SAR for Bluetooth**

Mode/Band	F (GHz)	Position	Distance (mm)	Upper limit of power *		Estimated <sub>1g</sub> (W/kg)
				dBm	mW	
Bluetooth	2.441	Head	5	9	7.94	0.33
Bluetooth	2.441	Body	10	9	7.94	0.17

\* - Maximum possible output power declared by manufacturer

When standalone SAR test exclusion applies to an antenna that transmits simultaneously with other antennas, the standalone SAR must be estimated according to following to determine simultaneous transmission SAR test exclusion:

(max. power of channel, including tune-up tolerance, mW)/(min. test separation distance, mm) · [√f(GHz)/x] W/kg for test separation distances ≤ 50 mm;

where x = 7.5 for 1-g SAR.

When the minimum test separation distance is < 5 mm, a distance of 5 mm is applied to determine SAR test exclusion

#### Conclusion:

According to the above tables, the sum of reported SAR values is < 1.6 W/kg. So the simultaneous transmission SAR with volume scans is not required.

## 14 SAR Test Result

It is determined by user manual for the distance between the EUT and the phantom bottom. The distance is 10 mm or 15mm and just applied to the condition of body worn accessory.

It is performed for all SAR measurements with area scan based 1-g SAR estimation (Fast SAR). A zoom scan measurement is added when the estimated 1-g SAR is the highest measured SAR in each exposure configuration, wireless mode and frequency band combination or more than 1.2W/kg.

The calculated SAR is obtained by the following formula:

$$\text{Reported SAR} = \text{Measured SAR} \times 10^{(P_{\text{Target}} - P_{\text{Measured}})/10}$$

Where  $P_{\text{Target}}$  is the power of manufacturing upper limit;

$P_{\text{Measured}}$  is the measured power in chapter 11.

**Table 14.1: Duty Cycle**

Mode	Duty Cycle
Speech for GSM850	1:2.67
Speech for GSM1900	1:2
GPRS&EGPRS for GSM850	1:2.67
GPRS&EGPRS for GSM1900	1:2
WCDMA&LTE FDD	1:1
LTE TDD	1:1.58

### 14.1 SAR results for Fast SAR

**Table 14.1-1: SAR Values (GSM 850 MHz Band - Head)**

Frequency		Side	Test Position	Figure No./Note	Conducted Power (dBm)	Max. tune-up Power (dBm)	Measured SAR(10g) (W/kg)	Reported SAR(10g) (W/kg)	Measured SAR(1g) (W/kg)	Reported SAR(1g) (W/kg)	Power Drift (dB)
Ch.	MHz										
190	836.6	Left	Touch	/	30.17	30.5	0.241	<b>0.26</b>	0.294	<b>0.32</b>	0.06
190	836.6	Left	Tilt	/	30.17	30.5	0.175	<b>0.19</b>	0.217	<b>0.23</b>	-0.03
251	848.8	Right	Touch	/	30.35	30.5	0.350	<b>0.36</b>	0.453	<b>0.47</b>	-0.07
190	836.6	Right	Touch	/	30.17	30.5	0.401	<b>0.43</b>	0.525	<b>0.57</b>	0.02
128	824.2	Right	Touch	Fig.1	29.95	30.5	0.434	<b>0.49</b>	0.558	<b>0.63</b>	-0.05
190	836.6	Right	Tilt	/	30.17	30.5	0.239	<b>0.26</b>	0.308	<b>0.33</b>	0.01

Note: the head SAR of GSM850 is tested with GPRS (3Txslots) mode because of VoIP.

**Table 14.1-2: SAR Values (GSM 850 MHz Band - Body)**

Frequency		Mode (number of timeslots)	Test Position	Figure No./Note	Conducted Power (dBm)	Max. tune-up Power (dBm)	Measured SAR(10g) (W/kg)	Reported SAR(10g) (W/kg)	Measured SAR(1g) (W/kg)	Reported SAR(1g) (W/kg)	Power Drift (dB)
Ch.	MHz										
251	848.8	GPRS (3)	Front	/	30.35	30.5	0.627	<b>0.65</b>	0.924	<b>0.96</b>	0.12
190	836.6	GPRS (3)	Front	/	30.17	30.5	0.697	<b>0.75</b>	1.02	<b>1.10</b>	0.04
128	824.2	GPRS (3)	Front	Fig.2	29.95	30.5	0.724	<b>0.82</b>	1.03	<b>1.17</b>	0.04
251	848.8	GPRS (3)	Rear	/	30.35	30.5	0.617	<b>0.64</b>	0.906	<b>0.94</b>	0.06
190	836.6	GPRS (3)	Rear	/	30.17	30.5	0.680	<b>0.73</b>	0.999	<b>1.08</b>	0.01
128	824.2	GPRS (3)	Rear	/	29.95	30.5	0.688	<b>0.78</b>	1.01	<b>1.15</b>	0.03
190	836.6	GPRS (3)	Left	/	30.17	30.5	0.088	<b>0.09</b>	0.127	<b>0.14</b>	0.07
190	836.6	GPRS (3)	Right	/	30.17	30.5	0.115	<b>0.12</b>	0.190	<b>0.20</b>	-0.11
190	836.6	GPRS (3)	Bottom	/	30.17	30.5	0.207	<b>0.22</b>	0.402	<b>0.43</b>	-0.08
128	824.2	EGPRS (3)	Front	/	29.98	30.5	0.706	<b>0.80</b>	1.01	<b>1.14</b>	0.09

Note: The distance between the EUT and the phantom bottom is 10mm.

**Table 14.1-3: SAR Values(GSM 1900 MHz Band - Head)**

Frequency		Side	Test Position	Figure No./Note	Conducted Power (dBm)	Max. tune-up Power (dBm)	Measured SAR(10g) (W/kg)	Reported SAR(10g) (W/kg)	Measured SAR(1g) (W/kg)	Reported SAR(1g) (W/kg)	Power Drift (dB)
Ch.	MHz										
810	1909.8	Left	Touch	/	27.65	28	0.117	<b>0.13</b>	0.173	<b>0.19</b>	-0.09
661	1880	Left	Touch	/	27.53	28	0.112	<b>0.12</b>	0.176	<b>0.20</b>	0.02
512	1850.2	Left	Touch	Fig.3	27.26	28	0.117	<b>0.14</b>	0.178	<b>0.21</b>	0.01
661	1880	Left	Tilt	/	27.53	28	0.031	<b>0.03</b>	0.053	<b>0.06</b>	0.12
661	1880	Right	Touch	/	27.53	28	0.112	<b>0.12</b>	0.173	<b>0.19</b>	0.01
661	1880	Right	Tilt	/	27.53	28	0.023	<b>0.03</b>	0.043	<b>0.05</b>	0.05

Note: the head SAR of GSM1900 is tested with GPRS (4Txslots) mode because of VoIP.

**Table 14.1-4: SAR Values (GSM 1900 MHz Band - Body)**

Ambient Temperature: 22.9 °C						Liquid Temperature: 22.5 °C					
Frequency		Mode (number of timeslots)	Test Position	Figure No./Note	Conducted Power (dBm)	Max. tune-up Power (dBm)	Measured SAR(10g) (W/kg)	Reported SAR(10g) (W/kg)	Measured SAR(1g) (W/kg)	Reported SAR(1g) (W/kg)	Power Drift (dB)
Ch.	MHz										
810	1909.8	GPRS (4)	Front	/	27.65	28	0.509	<b>0.55</b>	0.882	<b>0.96</b>	-0.03
661	1880	GPRS (4)	Front	Fig.4	27.53	28	0.544	<b>0.61</b>	0.936	<b>1.04</b>	-0.09
512	1850.2	GPRS (4)	Front	/	27.26	28	0.413	<b>0.49</b>	0.864	<b>1.02</b>	0.02
810	1909.8	GPRS (4)	Rear	/	27.65	28	0.468	<b>0.51</b>	0.794	<b>0.86</b>	0.08
661	1880	GPRS (4)	Rear	/	27.53	28	0.498	<b>0.55</b>	0.843	<b>0.94</b>	-0.09
512	1850.2	GPRS (4)	Rear	/	27.26	28	0.459	<b>0.54</b>	0.778	<b>0.92</b>	-0.07
661	1880	GPRS (4)	Left	/	27.53	28	0.029	<b>0.03</b>	0.048	<b>0.05</b>	-0.07
661	1880	GPRS (4)	Right	/	27.53	28	0.160	<b>0.18</b>	0.331	<b>0.37</b>	0.12
661	1880	GPRS (4)	Bottom	/	27.53	28	0.304	<b>0.34</b>	0.543	<b>0.61</b>	0.05
661	1880	GPRS (4)	Front	/	27.60	28	0.526	<b>0.58</b>	0.920	<b>1.01</b>	0.05

Note: The distance between the EUT and the phantom bottom is 10mm.

**Table 14.1-5: SAR Values (WCDMA 850 MHz Band - Head)**

Ambient Temperature: 22.9 °C						Liquid Temperature: 22.5 °C					
Frequency		Side	Test Position	Figure No./Note	Conducted Power (dBm)	Max. tune-up Power (dBm)	Measured SAR(10g) (W/kg)	Reported SAR(10g) (W/kg)	Measured SAR(1g) (W/kg)	Reported SAR(1g) (W/kg)	Power Drift (dB)
Ch.	MHz										
4182	836.4	Left	Touch	/	23.68	24	0.139	<b>0.15</b>	0.173	<b>0.19</b>	0.06
4182	836.4	Left	Tilt	/	23.68	24	0.102	<b>0.11</b>	0.128	<b>0.14</b>	-0.01
4233	846.6	Right	Touch	Fig.5	23.86	24	0.250	<b>0.26</b>	0.329	<b>0.34</b>	-0.08
4182	836.4	Right	Touch	/	23.68	24	0.225	<b>0.24</b>	0.296	<b>0.32</b>	-0.05
4132	826.4	Right	Touch	/	23.76	24	0.237	<b>0.25</b>	0.310	<b>0.33</b>	0.03
4182	836.4	Right	Tilt	/	23.68	24	0.136	<b>0.15</b>	0.179	<b>0.19</b>	0.01

**Table 14.1-6: SAR Values (WCDMA 850 MHz Band - Body)**

Ambient Temperature: 22.9 °C						Liquid Temperature: 22.5 °C					
Frequency		Test Position	Figure No./Note	Conducted Power (dBm)	Max. tune-up Power (dBm)	Measured SAR(10g) (W/kg)	Reported SAR(10g) (W/kg)	Measured SAR(1g) (W/kg)	Reported SAR(1g) (W/kg)	Power Drift (dB)	
Ch.	MHz										
4182	836.4	Front	/	23.68	24	0.493	<b>0.53</b>	0.719	<b>0.77</b>	0.02	
4233	846.6	Rear	Fig.6	23.86	24	0.529	<b>0.55</b>	0.758	<b>0.78</b>	-0.06	
4182	836.4	Rear	/	23.71	24	0.510	<b>0.55</b>	0.733	<b>0.78</b>	0.07	
4132	826.4	Rear	/	23.76	24	0.518	<b>0.55</b>	0.731	<b>0.77</b>	0.11	
4182	836.4	Left	/	23.68	24	0.073	<b>0.08</b>	0.106	<b>0.11</b>	0.02	
4182	836.4	Right	/	23.68	24	0.080	<b>0.09</b>	0.124	<b>0.13</b>	0.01	
4182	836.4	Bottom	/	23.68	24	0.100	<b>0.11</b>	0.199	<b>0.21</b>	0.07	

Note: The distance between the EUT and the phantom bottom is 10mm.

**Table 14.1-7: SAR Values(WCDMA 1700 MHz Band - Head)**

Frequency		Side	Test Position	Figure No./Note	Conducted Power (dBm)	Max. tune-up Power (dBm)	Measured SAR(10g) (W/kg)	Reported SAR(10g) (W/kg)	Measured SAR(1g) (W/kg)	Reported SAR(1g) (W/kg)	Power Drift (dB)
Ch.	MHz										
Ambient Temperature: 22.9 °C      Liquid Temperature: 22.5 °C											
1738	1752.6	Left	Touch	/	23.50	24	0.152	<b>0.17</b>	0.222	<b>0.25</b>	-0.02
1637	1732.4	Left	Touch	/	23.57	24	0.129	<b>0.14</b>	0.194	<b>0.21</b>	0.09
1537	1712.4	Left	Touch	Fig.7	23.68	24	0.164	<b>0.18</b>	0.237	<b>0.26</b>	0.17
1637	1732.4	Left	Tilt	/	23.57	24	0.049	<b>0.05</b>	0.071	<b>0.08</b>	0.13
1637	1732.4	Right	Touch	/	23.57	24	0.105	<b>0.12</b>	0.162	<b>0.18</b>	0.12
1637	1732.4	Right	Tilt	/	23.57	24	0.084	<b>0.09</b>	0.124	<b>0.14</b>	0.04

**Table 14.1-8: SAR Values (WCDMA 1700 MHz Band - Body)**

Frequency		Test Position	Figure No./Note	Conducted Power (dBm)	Max. tune-up Power (dBm)	Measured SAR(10g) (W/kg)	Reported SAR(10g) (W/kg)	Measured SAR(1g) (W/kg)	Reported SAR(1g) (W/kg)	Power Drift (dB)
Ch.	MHz									
Ambient Temperature: 22.9 °C      Liquid Temperature: 22.5 °C										
1738	1752.6	Front	Fig.8	21.88	22.5	0.562	<b>0.65</b>	0.960	<b>1.11</b>	-0.10
1637	1732.4	Front	/	21.96	22.5	0.490	<b>0.55</b>	0.874	<b>0.99</b>	0.05
1537	1712.4	Front	/	22.06	22.5	0.497	<b>0.55</b>	0.879	<b>0.97</b>	-0.12
1738	1752.6	Rear	/	21.88	22.5	0.432	<b>0.50</b>	0.803	<b>0.93</b>	0.06
1637	1732.4	Rear	/	21.96	22.5	0.393	<b>0.45</b>	0.730	<b>0.83</b>	0.02
1537	1712.4	Rear	/	22.06	22.5	0.407	<b>0.45</b>	0.756	<b>0.84</b>	0.07
1637	1732.4	Left	/	21.96	22.5	0.051	<b>0.06</b>	0.087	<b>0.10</b>	0.08
1637	1732.4	Right	/	21.96	22.5	0.131	<b>0.15</b>	0.269	<b>0.30</b>	0.02
1738	1752.6	Bottom	/	21.88	22.5	0.405	<b>0.47</b>	0.855	<b>0.99</b>	-0.05
1637	1732.4	Bottom	/	21.96	22.5	0.369	<b>0.42</b>	0.777	<b>0.88</b>	0.01
1537	1712.4	Bottom	/	22.06	22.5	0.378	<b>0.42</b>	0.797	<b>0.88</b>	0.04

Note1: The distance between the EUT and the phantom bottom is 10mm.

**Table 14.1-9: SAR Values (WCDMA 1700 MHz Band - Body)**

Frequency		Test Position	Figure No./Note	Conducted Power (dBm)	Max. tune-up Power (dBm)	Measured SAR(10g) (W/kg)	Reported SAR(10g) (W/kg)	Measured SAR(1g) (W/kg)	Reported SAR(1g) (W/kg)	Power Drift (dB)
Ch.	MHz									
Ambient Temperature: 22.9 °C      Liquid Temperature: 22.5 °C										
1738	1752.6	Front	/	23.50	24	0.341	<b>0.38</b>	0.693	<b>0.78</b>	-0.04
1637	1732.4	Front	/	23.57	24	0.399	<b>0.44</b>	0.668	<b>0.74</b>	-0.11
1537	1712.4	Front	Fig.9	23.68	24	0.468	<b>0.50</b>	0.759	<b>0.82</b>	-0.17
1637	1732.4	Rear	/	23.57	24	0.343	<b>0.38</b>	0.588	<b>0.65</b>	0.06

Note1: The distance between the EUT and the phantom bottom is 15mm.

**Table 14.1-10: SAR Values(WCDMA 1900 MHz Band - Head)**

Frequency		Side	Test Position	Figure No./Note	Conducted Power (dBm)	Max. tune-up Power (dBm)	Measured SAR(10g) (W/kg)	Reported SAR(10g) (W/kg)	Measured SAR(1g) (W/kg)	Reported SAR(1g) (W/kg)	Power Drift (dB)
Ch.	MHz										
Ambient Temperature: 22.9°C      Liquid Temperature: 22.5°C											
9938	1907.6	Left	Touch	Fig.10	24.24	24.5	0.095	<b>0.10</b>	0.138	<b>0.15</b>	0.18
9800	1880	Left	Touch	/	24.26	24.5	0.087	<b>0.09</b>	0.128	<b>0.14</b>	0.06
9662	1852.4	Left	Touch	/	24.15	24.5	0.087	<b>0.09</b>	0.131	<b>0.14</b>	0.05
9800	1880	Left	Tilt	/	24.26	24.5	0.043	<b>0.05</b>	0.066	<b>0.07</b>	0.02
9800	1880	Right	Touch	/	24.26	24.5	0.084	<b>0.09</b>	0.122	<b>0.13</b>	0.11
9800	1880	Right	Tilt	/	24.26	24.5	0.052	<b>0.05</b>	0.083	<b>0.09</b>	0.14

**Table 14.1-11: SAR Values (WCDMA 1900 MHz Band - Body)**

Frequency		Test Position	Figure No./Note	Conducted Power (dBm)	Max. tune-up Power (dBm)	Measured SAR(10g) (W/kg)	Reported SAR(10g) (W/kg)	Measured SAR(1g) (W/kg)	Reported SAR(1g) (W/kg)	Power Drift (dB)
Ch.	MHz									
Ambient Temperature: 22.9°C      Liquid Temperature: 22.5°C										
9938	1907.6	Front	/	24.24	24.5	0.668	<b>0.71</b>	1.17	<b>1.24</b>	-0.01
9800	1880	Front	/	24.26	24.5	0.678	<b>0.72</b>	1.18	<b>1.25</b>	0.04
9662	1852.4	Front	Fig.11	24.35	24.5	0.708	<b>0.73</b>	1.22	<b>1.26</b>	-0.08
9938	1907.6	Rear	/	24.24	24.5	0.597	<b>0.63</b>	1.01	<b>1.07</b>	-0.06
9800	1880	Rear	/	24.26	24.5	0.604	<b>0.64</b>	1.02	<b>1.08</b>	0.05
9662	1852.4	Rear	/	24.35	24.5	0.622	<b>0.64</b>	1.05	<b>1.09</b>	0.08
9800	1880	Left	/	24.26	24.5	0.061	<b>0.06</b>	0.095	<b>0.10</b>	-0.13
9800	1880	Right	/	24.26	24.5	0.239	<b>0.25</b>	0.488	<b>0.52</b>	0.17
9800	1880	Bottom	/	24.26	24.5	0.332	<b>0.35</b>	0.584	<b>0.62</b>	0.03
9662	1852.4	Front	/	24.35	24.5	0.665	<b>0.69</b>	1.12	<b>1.16</b>	0.08

Note1: The distance between the EUT and the phantom bottom is 10mm.

**Table 14.1-12: SAR Values (LTE Band2 - Head)**

Frequency		Mode	Side	Test Position	Figure No./Note	Conducted Power (dBm)	Max. tune-up Power (dBm)	Measured SAR(10g) (W/kg)	Reported SAR(10g) (W/kg)	Measured SAR(1g) (W/kg)	Reported SAR(1g) (W/kg)	Power Drift (dB)
Ch.	MHz											
Ambient Temperature: 22.9°C      Liquid Temperature: 22.5°C												
19100	1900	1RB_Low	Left	Touch	Fig.12	23.76	24	0.108	<b>0.11</b>	0.163	<b>0.17</b>	0.01
19100	1900	1RB_Low	Left	Tilt	/	23.76	24	0.041	<b>0.04</b>	0.060	<b>0.06</b>	0.08
19100	1900	1RB_Low	Right	Touch	/	23.76	24	0.095	<b>0.10</b>	0.122	<b>0.13</b>	0.14
19100	1900	1RB_Low	Right	Tilt	/	23.76	24	0.025	<b>0.03</b>	0.048	<b>0.05</b>	0.06
19100	1900	50RB_Mid	Left	Touch	/	22.85	23	0.087	<b>0.09</b>	0.129	<b>0.13</b>	-0.11
19100	1900	50RB_Mid	Left	Tilt	/	22.85	23	0.038	<b>0.04</b>	0.059	<b>0.06</b>	0.09
19100	1900	50RB_Mid	Right	Touch	/	22.85	23	0.077	<b>0.08</b>	0.036	<b>0.04</b>	0.13
19100	1900	50RB_Mid	Right	Tilt	/	22.85	23	0.019	<b>0.02</b>	0.039	<b>0.04</b>	-0.03

Note1: The LTE mode is QPSK\_20MHz.

**Table 14.1-13: SAR Values (LTE Band2 - Body)**

Frequency		Mode	Test Position	Figure No./ Note	Ambient Temperature: 22.9°C		Liquid Temperature: 22.5°C		Measured SAR(1g) (W/kg)	Reported SAR(1g) (W/kg)	Power Drift (dB)
Ch.	MHz				Conducted Power (dBm)	Max. tune-up Power (dBm)	Measured SAR(10g) (W/kg)	Reported SAR(10g) (W/kg)			
19100	1900	1RB_Low	Front	/	23.76	24	0.437	<b>0.46</b>	0.747	<b>0.79</b>	0.06
19100	1900	1RB_Low	Rear	Fig.13	23.76	24	0.444	<b>0.47</b>	0.761	<b>0.80</b>	0.09
19100	1900	1RB_Low	Left	/	23.76	24	0.038	<b>0.04</b>	0.057	<b>0.06</b>	-0.03
19100	1900	1RB_Low	Right	/	23.76	24	0.122	<b>0.13</b>	0.251	<b>0.27</b>	-0.01
19100	1900	1RB_Low	Bottom	/	23.76	24	0.237	<b>0.25</b>	0.394	<b>0.42</b>	0.07
19100	1900	50RB_Mid	Front	/	22.85	23	0.327	<b>0.34</b>	0.557	<b>0.58</b>	0.02
19100	1900	50RB_Mid	Rear	/	22.85	23	0.370	<b>0.38</b>	0.647	<b>0.67</b>	-0.05
19100	1900	50RB_Mid	Left	/	22.85	23	0.031	<b>0.03</b>	0.046	<b>0.05</b>	-0.01
19100	1900	50RB_Mid	Right	/	22.85	23	0.105	<b>0.11</b>	0.216	<b>0.22</b>	0.06
19100	1900	50RB_Mid	Bottom	/	22.85	23	0.203	<b>0.21</b>	0.352	<b>0.36</b>	0.02

Note1: The distance between the EUT and the phantom bottom is 10mm.

Note2: The LTE mode is QPSK\_20MHz.

**Table 14.1-14: SAR Values(LTE Band5 - Head)**

Frequency		Mode	Side	Test Position	Figure No.	Ambient Temperature: 22.9°C		Liquid Temperature: 22.5°C		Measured SAR(1g) (W/kg)	Reported SAR(1g) (W/kg)	Power Drift (dB)
Ch.	MHz					Conducted Power (dBm)	Max. tune-up Power (dBm)	Measured SAR(10g) (W/kg)	Reported SAR(10g) (W/kg)			
20450	829	1RB_High	Left	Touch	/	23.72	24	0.190	<b>0.20</b>	0.241	<b>0.26</b>	0.06
20450	829	1RB_High	Left	Tilt	/	23.72	24	0.128	<b>0.14</b>	0.158	<b>0.17</b>	-0.01
20450	829	1RB_High	Right	Touch	Fig.14	23.72	24	0.310	<b>0.33</b>	0.407	<b>0.43</b>	0.18
20450	829	1RB_High	Right	Tilt	/	23.72	24	0.152	<b>0.16</b>	0.200	<b>0.21</b>	0.02
20600	844	25RB_High	Left	Touch	/	22.54	23	0.136	<b>0.15</b>	0.172	<b>0.19</b>	0.06
20600	844	25RB_High	Left	Tilt	/	22.54	23	0.094	<b>0.10</b>	0.118	<b>0.13</b>	0.03
20600	844	25RB_High	Right	Touch	/	22.54	23	0.198	<b>0.22</b>	0.258	<b>0.29</b>	-0.06
20600	844	25RB_High	Right	Tilt	/	22.54	23	0.100	<b>0.11</b>	0.132	<b>0.15</b>	0.01

Note1: The LTE mode is QPSK\_10MHz.



**Table 14.1-15: SAR Values (LTE Band5-Body)**

Frequency		Mode	Test Position	Figure No.	Ambient Temperature: 22.9°C		Liquid Temperature: 22.5°C		Measured SAR(1g) (W/kg)	Reported SAR(1g) (W/kg)	Power Drift (dB)
Ch.	MHz				Conducted Power (dBm)	Max. tune-up Power (dBm)	Measured SAR(10g) (W/kg)	Reported SAR(10g) (W/kg)			
20450	829	1RB_High	Front	/	23.72	24	0.444	<b>0.47</b>	0.625	<b>0.67</b>	0.14
20450	829	1RB_High	Rear	Fig.15	23.72	24	0.461	<b>0.49</b>	0.641	<b>0.68</b>	-0.03
20450	829	1RB_High	Left	/	23.72	24	0.051	<b>0.05</b>	0.085	<b>0.09</b>	0.06
20450	829	1RB_High	Right	/	23.72	24	0.203	<b>0.22</b>	0.284	<b>0.30</b>	0.02
20450	829	1RB_High	Bottom	/	23.72	24	0.158	<b>0.17</b>	0.271	<b>0.29</b>	0.13
20600	844	25RB_High	Front	/	22.54	23	0.319	<b>0.35</b>	0.454	<b>0.50</b>	0.09
20600	844	25RB_High	Rear	/	22.54	23	0.328	<b>0.36</b>	0.455	<b>0.51</b>	0.06
20600	844	25RB_High	Left	/	22.54	23	0.039	<b>0.04</b>	0.063	<b>0.07</b>	0.05
20600	844	25RB_High	Right	/	22.54	23	0.148	<b>0.16</b>	0.210	<b>0.23</b>	0.13
20600	844	25RB_High	Bottom	/	22.54	23	0.110	<b>0.12</b>	0.199	<b>0.22</b>	0.16

Note1: The distance between the EUT and the phantom bottom is 10mm.

Note2: The LTE mode is QPSK\_10MHz.

**Table 14.1-16: SAR Values(LTE Band7 - Head)**

Frequency		Mode	Side	Test Position	Figure No./ Note	Ambient Temperature: 22.9°C		Liquid Temperature: 22.5°C		Measured SAR(1g) (W/kg)	Reported SAR(1g) (W/kg)	Power Drift (dB)
Ch.	MHz					Conducted Power (dBm)	Max. tune-up Power (dBm)	Measured SAR(10g) (W/kg)	Reported SAR(10g) (W/kg)			
20850	2510	1RB_Low	Left	Touch	/	23.26	24.5	0.170	<b>0.23</b>	0.316	<b>0.42</b>	0.06
20850	2510	1RB_Low	Left	Tilt	/	23.26	24.5	0.047	<b>0.06</b>	0.100	<b>0.13</b>	0.02
20850	2510	1RB_Low	Right	Touch	Fig.16	23.26	24.5	0.183	<b>0.24</b>	0.347	<b>0.46</b>	0.07
20850	2510	1RB_Low	Right	Tilt	/	23.26	24.5	0.105	<b>0.14</b>	0.191	<b>0.25</b>	-0.08
20850	2510	50RB_Low	Left	Touch	/	22.13	23.5	0.141	<b>0.19</b>	0.262	<b>0.36</b>	0.02
20850	2510	50RB_Low	Left	Tilt	/	22.13	23.5	0.043	<b>0.06</b>	0.078	<b>0.11</b>	-0.01
20850	2510	50RB_Low	Right	Touch	/	22.13	23.5	0.165	<b>0.23</b>	0.319	<b>0.44</b>	-0.05
20850	2510	50RB_Low	Right	Tilt	/	22.13	23.5	0.082	<b>0.11</b>	0.149	<b>0.20</b>	0.02

Note1: The LTE mode is QPSK\_20MHz.

**Table 14.1-17: SAR Values (LTE Band7 - Body)**

Ambient Temperature: 22.9°C					Liquid Temperature: 22.5°C						
Frequency		Mode	Test Position	Figure No./Note	Conducted Power (dBm)	Max. tune-up Power (dBm)	Measured SAR(10g) (W/kg)	Reported SAR(10g) (W/kg)	Measured SAR(1g) (W/kg)	Reported SAR(1g) (W/kg)	Power Drift (dB)
Ch.	MHz										
21350	2560	1RB_Mid	Front	/	20.31	20.5	0.231	<b>0.24</b>	0.412	<b>0.43</b>	0.05
21350	2560	1RB_Mid	Rear	/	20.31	20.5	0.252	<b>0.26</b>	0.454	<b>0.47</b>	0.01
21350	2560	1RB_Mid	Left	/	20.31	20.5	0.120	<b>0.13</b>	0.240	<b>0.25</b>	0.04
21350	2560	1RB_Mid	Bottom	/	20.31	20.5	0.477	<b>0.50</b>	0.937	<b>0.98</b>	0.01
21100	2535	1RB_High	Bottom	Fig.17	20.22	20.5	0.476	<b>0.51</b>	0.925	<b>0.99</b>	0.07
20850	2510	1RB_High	Bottom	/	20.28	20.5	0.517	<b>0.54</b>	1.00	<b>1.06</b>	0.11
20850	2510	50RB_Mid	Front	/	20.36	20.5	0.256	<b>0.26</b>	0.437	<b>0.45</b>	0.03
20850	2510	50RB_Mid	Rear	/	20.36	20.5	0.264	<b>0.27</b>	0.475	<b>0.49</b>	0.07
20850	2510	50RB_Mid	Left	/	20.36	20.5	0.171	<b>0.18</b>	0.350	<b>0.36</b>	0.08
21350	2560	50RB_High	Bottom	/	20.21	20.5	0.467	<b>0.50</b>	0.911	<b>0.97</b>	0.07
21100	2535	50RB_Low	Bottom	/	20.24	20.5	0.504	<b>0.54</b>	0.978	<b>1.04</b>	0.11
20850	2510	50RB_Mid	Bottom	/	20.36	20.5	0.528	<b>0.55</b>	1.02	<b>1.05</b>	0.01
20850	2510	100RB	Bottom	/	20.28	20.5	0.538	<b>0.57</b>	1.04	<b>1.09</b>	0.01

Note1: The distance between the EUT and the phantom bottom is 10mm.

Note2: The LTE mode is QPSK\_20MHz.

**Table 14.1-18: SAR Values (LTE Band7 - Body)**

Ambient Temperature: 22.9°C					Liquid Temperature: 22.5°C						
Frequency		Mode	Test Position	Figure No./Note	Conducted Power (dBm)	Max. tune-up Power (dBm)	Measured SAR(10g) (W/kg)	Reported SAR(10g) (W/kg)	Measured SAR(1g) (W/kg)	Reported SAR(1g) (W/kg)	Power Drift (dB)
Ch.	MHz										
20850	2510	1RB_Low	Front	Fig.18	23.26	24.5	0.278	<b>0.37</b>	0.488	<b>0.65</b>	-0.02
20850	2510	1RB_Low	Rear	/	23.26	24.5	0.258	<b>0.34</b>	0.467	<b>0.62</b>	0.03
20850	2510	50RB_Low	Front	/	22.13	23.5	0.224	<b>0.31</b>	0.395	<b>0.54</b>	0.05
20850	2510	50RB_Low	Rear	/	22.13	23.5	0.206	<b>0.28</b>	0.372	<b>0.51</b>	-0.07

Note1: The distance between the EUT and the phantom bottom is 15mm.

Note2: The LTE mode is QPSK\_20MHz.

**Table 14.1-19: SAR Values(LTE Band12 - Head)**

Ambient Temperature: 22.9°C						Liquid Temperature: 22.5°C						
Frequency		Mode	Side	Test Position	Figure No./ Note	Conducted Power (dBm)	Max. tune-up Power (dBm)	Measured SAR(10g) (W/kg)	Reported SAR(10g) (W/kg)	Measured SAR(1g) (W/kg)	Reported SAR(1g) (W/kg)	Power Drift (dB)
Ch.	MHz											
23130	711	1RB_High	Left	Touch	/	23.84	24	0.052	<b>0.05</b>	0.060	<b>0.06</b>	0.06
23130	711	1RB_High	Left	Tilt	/	23.84	24	0.023	<b>0.02</b>	0.033	<b>0.03</b>	-0.02
23130	711	1RB_High	Right	Touch	Fig.19	23.84	24	0.119	<b>0.12</b>	0.147	<b>0.15</b>	0.03
23130	711	1RB_High	Right	Tilt	/	23.84	24	0.046	<b>0.05</b>	0.056	<b>0.06</b>	-0.07
23130	711	25RB_High	Left	Touch	/	22.46	23	0.041	<b>0.05</b>	0.047	<b>0.05</b>	0.03
23130	711	25RB_High	Left	Tilt	/	22.46	23	0.018	<b>0.02</b>	0.026	<b>0.03</b>	0.01
23130	711	25RB_High	Right	Touch	/	22.46	23	0.073	<b>0.08</b>	0.090	<b>0.10</b>	0.01
23130	711	25RB_High	Right	Tilt	/	22.46	23	0.040	<b>0.05</b>	0.047	<b>0.05</b>	0.06

Note1: The LTE mode is QPSK\_10MHz.

**Table 14.1-20: SAR Values (LTE Band12 - Body)**

Ambient Temperature: 22.9°C						Liquid Temperature: 22.5°C					
Frequency		Mode	Test Position	Figure No./ Note	Conducted Power (dBm)	Max. tune-up Power (dBm)	Measured SAR(10g) (W/kg)	Reported SAR(10g) (W/kg)	Measured SAR(1g) (W/kg)	Reported SAR(1g) (W/kg)	Power Drift (dB)
Ch.	MHz										
23130	711	1RB_High	Front	/	23.84	24	0.185	<b>0.19</b>	0.262	<b>0.27</b>	0.04
23130	711	1RB_High	Rear	Fig.20	23.84	24	0.200	<b>0.21</b>	0.281	<b>0.29</b>	0.02
23130	711	1RB_High	Left	/	23.84	24	0.044	<b>0.05</b>	0.061	<b>0.06</b>	0.05
23130	711	1RB_High	Right	/	23.84	24	0.092	<b>0.10</b>	0.131	<b>0.14</b>	0.09
23130	711	1RB_High	Bottom	/	23.84	24	0.059	<b>0.06</b>	0.118	<b>0.12</b>	0.12
23130	711	25RB_High	Front	/	22.46	23	0.131	<b>0.15</b>	0.186	<b>0.21</b>	-0.05
23130	711	25RB_High	Rear	/	22.46	23	0.159	<b>0.18</b>	0.223	<b>0.25</b>	0.09
23130	711	25RB_High	Left	/	22.46	23	0.034	<b>0.04</b>	0.049	<b>0.06</b>	-0.04
23130	711	25RB_High	Right	/	22.46	23	0.074	<b>0.08</b>	0.105	<b>0.12</b>	0.11
23130	711	25RB_High	Bottom	/	22.46	23	0.046	<b>0.05</b>	0.093	<b>0.11</b>	0.06

Note1: The distance between the EUT and the phantom bottom is 10mm.

Note2: The LTE mode is QPSK\_10MHz.

**Table 14.1-21: SAR Values(LTE Band13 - Head)**

Frequency		Mode	Side	Test Position	Figure No./ Note	Conducted Power (dBm)	Max. tune-up Power (dBm)	Measured SAR(10g) (W/kg)	Reported SAR(10g) (W/kg)	Measured SAR(1g) (W/kg)	Reported SAR(1g) (W/kg)	Power Drift (dB)
Ch.	MHz											
23230	782	1RB_Low	Left	Touch	/	23.54	24	0.154	<b>0.17</b>	0.189	<b>0.21</b>	0.07
23230	782	1RB_Low	Left	Tilt	/	23.54	24	0.090	<b>0.10</b>	0.107	<b>0.12</b>	-0.09
23230	782	1RB_Low	Right	Touch	Fig.21	23.54	24	0.229	<b>0.25</b>	0.293	<b>0.33</b>	0.02
23230	782	1RB_Low	Right	Tilt	/	23.54	24	0.113	<b>0.13</b>	0.143	<b>0.16</b>	-0.03
23230	782	25RB_High	Left	Touch	/	22.44	23	0.116	<b>0.13</b>	0.142	<b>0.16</b>	0.02
23230	782	25RB_High	Left	Tilt	/	22.44	23	0.075	<b>0.09</b>	0.089	<b>0.10</b>	0.01
23230	782	25RB_High	Right	Touch	/	22.44	23	0.181	<b>0.21</b>	0.233	<b>0.27</b>	0.01
23230	782	25RB_High	Right	Tilt	/	22.44	23	0.090	<b>0.10</b>	0.115	<b>0.13</b>	0.05

Note1: The LTE mode is QPSK\_10MHz.

**Table 14.1-22: SAR Values (LTE Band13 - Body)**

Frequency		Mode	Test Position	Figure No./ Note	Conducted Power (dBm)	Max. tune-up Power (dBm)	Measured SAR(10g) (W/kg)	Reported SAR(10g) (W/kg)	Measured SAR(1g) (W/kg)	Reported SAR(1g) (W/kg)	Power Drift (dB)
Ch.	MHz										
23230	782	1RB_Low	Front	/	23.54	24	0.248	<b>0.28</b>	0.393	<b>0.44</b>	0.02
23230	782	1RB_Low	Rear	Fig.22	23.54	24	0.284	<b>0.32</b>	0.446	<b>0.50</b>	0.05
23230	782	1RB_Low	Left	/	23.54	24	0.057	<b>0.06</b>	0.093	<b>0.10</b>	-0.13
23230	782	1RB_Low	Right	/	23.54	24	0.134	<b>0.15</b>	0.218	<b>0.24</b>	0.05
23230	782	1RB_Low	Bottom	/	23.54	24	0.095	<b>0.11</b>	0.199	<b>0.22</b>	0.09
23230	782	25RB_High	Front	/	22.44	23	0.196	<b>0.22</b>	0.312	<b>0.35</b>	0.04
23230	782	25RB_High	Rear	/	22.44	23	0.227	<b>0.26</b>	0.356	<b>0.40</b>	0.15
23230	782	25RB_High	Left	/	22.44	23	0.042	<b>0.05</b>	0.068	<b>0.08</b>	-0.09
23230	782	25RB_High	Right	/	22.44	23	0.081	<b>0.09</b>	0.129	<b>0.15</b>	0.04
23230	782	25RB_High	Bottom	/	22.44	23	0.078	<b>0.09</b>	0.166	<b>0.19</b>	-0.03

Note1: The distance between the EUT and the phantom bottom is 10mm.

Note2: The LTE mode is QPSK\_10MHz.

**Table 14.1-23: SAR Values(LTE Band38 - Head)**

Frequency		Mode	Side	Test Position	Figure No./ Note	Conducted Power (dBm)	Max. tune-up Power (dBm)	Measured SAR(10g) (W/kg)	Reported SAR(10g) (W/kg)	Measured SAR(1g) (W/kg)	Reported SAR(1g) (W/kg)	Power Drift (dB)
Ch.	MHz											
38150	2610	1RB_Mid	Left	Touch	/	23.82	24	0.036	<b>0.04</b>	0.067	<b>0.07</b>	0.09
38150	2610	1RB_Mid	Left	Tilt	/	23.82	24	0.020	<b>0.02</b>	0.039	<b>0.04</b>	0.01
38150	2610	1RB_Mid	Right	Touch	Fig.23	23.82	24	0.044	<b>0.05</b>	0.083	<b>0.09</b>	0.06
38150	2610	1RB_Mid	Right	Tilt	/	23.82	24	0.025	<b>0.03</b>	0.049	<b>0.05</b>	-0.03
38150	2610	50RB_Mid	Left	Touch	/	22.68	23	0.028	<b>0.03</b>	0.052	<b>0.06</b>	0.01
38150	2610	50RB_Mid	Left	Tilt	/	22.68	23	0.013	<b>0.01</b>	0.031	<b>0.03</b>	-0.06
38150	2610	50RB_Mid	Right	Touch	/	22.68	23	0.039	<b>0.04</b>	0.076	<b>0.08</b>	-0.04
38150	2610	50RB_Mid	Right	Tilt	/	22.68	23	0.024	<b>0.03</b>	0.048	<b>0.05</b>	0.01

Note1: The LTE mode is QPSK\_20MHz.

**Table 14.1-24: SAR Values (LTE Band38 - Body)**

Frequency		Mode	Test Position	Figure No./ Note	Conducted Power (dBm)	Max. tune-up Power (dBm)	Measured SAR(10g) (W/kg)	Reported SAR(10g) (W/kg)	Measured SAR(1g) (W/kg)	Reported SAR(1g) (W/kg)	Power Drift (dB)
Ch.	MHz										
38150	2610	1RB_Mid	Front	/	23.82	24	0.167	<b>0.17</b>	0.298	<b>0.31</b>	0.03
38150	2610	1RB_Mid	Rear	/	23.82	24	0.183	<b>0.19</b>	0.323	<b>0.34</b>	0.12
38150	2610	1RB_Mid	Left	/	23.82	24	0.081	<b>0.08</b>	0.163	<b>0.17</b>	0.06
38150	2610	1RB_Mid	Bottom	Fig.24	23.82	24	0.345	<b>0.36</b>	0.672	<b>0.70</b>	-0.03
38150	2610	50RB_Mid	Front	/	22.68	23	0.142	<b>0.15</b>	0.255	<b>0.27</b>	0.05
38150	2610	50RB_Mid	Rear	/	22.68	23	0.146	<b>0.16</b>	0.260	<b>0.28</b>	0.15
38150	2610	50RB_Mid	Left	/	22.68	23	0.068	<b>0.07</b>	0.139	<b>0.15</b>	0.02
38150	2610	50RB_Mid	Bottom	/	22.68	23	0.282	<b>0.30</b>	0.550	<b>0.59</b>	-0.11

Note1: The distance between the EUT and the phantom bottom is 10mm.

Note2: The LTE mode is QPSK\_20MHz.

**Table 14.1-27: SAR Values(LTE Band41 - Head)**

Frequency		Mode	Side	Test Position	Figure No./ Note	Conducted Power (dBm)	Max. tune-up Power (dBm)	Measured SAR(10g) (W/kg)	Reported SAR(10g) (W/kg)	Measured SAR(1g) (W/kg)	Reported SAR(1g) (W/kg)	Power Drift (dB)
Ch.	MHz											
41490	2680	1RB_High	Left	Touch	/	23.79	24	0.028	<b>0.03</b>	0.053	<b>0.06</b>	-0.12
41490	2680	1RB_High	Left	Tilt	/	23.79	24	0.016	<b>0.02</b>	0.026	<b>0.03</b>	0.05
41490	2680	1RB_High	Right	Touch	Fig.27	23.79	24	0.041	<b>0.04</b>	0.080	<b>0.08</b>	0.04
41490	2680	1RB_High	Right	Tilt	/	23.79	24	0.025	<b>0.03</b>	0.048	<b>0.05</b>	-0.08
41490	2680	50RB_Mid	Left	Touch	/	22.68	23	0.020	<b>0.02</b>	0.035	<b>0.04</b>	0.05
41490	2680	50RB_Mid	Left	Tilt	/	22.68	23	0.012	<b>0.01</b>	0.020	<b>0.02</b>	0.02
41490	2680	50RB_Mid	Right	Touch	/	22.68	23	0.032	<b>0.03</b>	0.061	<b>0.07</b>	0.01
41490	2680	50RB_Mid	Right	Tilt	/	22.68	23	0.019	<b>0.02</b>	0.032	<b>0.03</b>	-0.14

Note1: The LTE mode is QPSK\_20MHz.

**Table 14.1-28: SAR Values (LTE Band41 - Body)**

Frequency		Mode	Test Position	Figure No./ Note	Conducted Power (dBm)	Max. tune-up Power (dBm)	Measured SAR(10g) (W/kg)	Reported SAR(10g) (W/kg)	Measured SAR(1g) (W/kg)	Reported SAR(1g) (W/kg)	Power Drift (dB)
Ch.	MHz										
41490	2680	1RB_High	Front	/	23.79	24	0.186	<b>0.20</b>	0.345	<b>0.36</b>	0.13
41490	2680	1RB_High	Rear	/	23.79	24	0.278	<b>0.29</b>	0.446	<b>0.47</b>	0.14
41490	2680	1RB_High	Left	/	23.79	24	0.083	<b>0.09</b>	0.175	<b>0.18</b>	0.05
41490	2680	1RB_High	Bottom	/	23.79	24	0.399	<b>0.42</b>	0.804	<b>0.84</b>	0.07
41055	2636.5	1RB_High	Bottom	/	23.42	24	0.390	<b>0.45</b>	0.778	<b>0.89</b>	-0.02
40620	2593	1RB_High	Bottom	/	23.01	24	0.356	<b>0.45</b>	0.702	<b>0.88</b>	-0.09
40185	2549.5	1RB_High	Bottom	/	22.56	24	0.387	<b>0.54</b>	0.757	<b>1.05</b>	0.06
39750	2506	1RB_High	Bottom	Fig.28	22.58	24	0.443	<b>0.61</b>	0.853	<b>1.18</b>	-0.14
41490	2680	50RB_Mid	Front	/	22.68	23	0.151	<b>0.16</b>	0.280	<b>0.30</b>	0.13
41490	2680	50RB_Mid	Rear	/	22.68	23	0.172	<b>0.19</b>	0.319	<b>0.34</b>	0.09
41490	2680	50RB_Mid	Left	/	22.68	23	0.073	<b>0.08</b>	0.158	<b>0.17</b>	0.02
41490	2680	50RB_Mid	Bottom	/	22.68	23	0.289	<b>0.31</b>	0.586	<b>0.63</b>	0.01
41490	2680	100RB	Bottom	/	22.43	23	0.311	<b>0.35</b>	0.629	<b>0.72</b>	0.06

Note1: The distance between the EUT and the phantom bottom is 10mm.

Note2: The LTE mode is QPSK\_20MHz.

**Table 14.1-29: SAR Values(LTE Band4 - Head)**



Ambient Temperature: 22.9°C						Liquid Temperature: 22.5°C						
Frequency		Mode	Side	Test Position	Figure No./ Note	Conducted Power (dBm)	Max. tune-up Power (dBm)	Measured SAR(10g) (W/kg)	Reported SAR(10g) (W/kg)	Measured SAR(1g) (W/kg)	Reported SAR(1g) (W/kg)	Power Drift (dB)
Ch.	MHz											
20050	1720	1RB_High	Left	Touch	Fig.29	24.12	25	0.138	<b>0.17</b>	0.207	<b>0.25</b>	0.10
20050	1720	1RB_High	Left	Tilt	/	24.12	25	0.044	<b>0.05</b>	0.064	<b>0.08</b>	0.06
20050	1720	1RB_High	Right	Touch	/	24.12	25	0.086	<b>0.11</b>	0.137	<b>0.17</b>	-0.02
20050	1720	1RB_High	Right	Tilt	/	24.12	25	0.071	<b>0.09</b>	0.112	<b>0.14</b>	-0.02
20175	1732.5	50RB_Low	Left	Touch	/	23.18	24	0.121	<b>0.15</b>	0.181	<b>0.22</b>	0.01
20175	1732.5	50RB_Low	Left	Tilt	/	23.18	24	0.035	<b>0.04</b>	0.051	<b>0.06</b>	0.05
20175	1732.5	50RB_Low	Right	Touch	/	23.18	24	0.070	<b>0.08</b>	0.111	<b>0.13</b>	0.03
20175	1732.5	50RB_Low	Right	Tilt	/	23.18	24	0.061	<b>0.07</b>	0.094	<b>0.11</b>	0.07

Note1: The LTE mode is QPSK\_20MHz.

**Table 14.1-30: SAR Values (LTE Band4 - Body)**

Ambient Temperature: 22.9°C						Liquid Temperature: 22.5°C					
Frequency		Mode	Test Position	Figure No./ Note	Conducted Power (dBm)	Max. tune-up Power (dBm)	Measured SAR(10g) (W/kg)	Reported SAR(10g) (W/kg)	Measured SAR(1g) (W/kg)	Reported SAR(1g) (W/kg)	Power Drift (dB)
Ch.	MHz										
20300	1745	1RB_Low	Front	/	22.40	23.5	0.479	<b>0.62</b>	0.799	<b>1.03</b>	-0.02
20175	1732.5	1RB_Low	Front	/	22.51	23.5	0.448	<b>0.56</b>	0.750	<b>0.94</b>	-0.03
20050	1720	1RB_Mid	Front	/	22.88	23.5	0.443	<b>0.51</b>	0.789	<b>0.91</b>	-0.02
20050	1720	1RB_Mid	Rear	/	22.88	23.5	0.378	<b>0.44</b>	0.664	<b>0.77</b>	-0.01
20050	1720	1RB_Mid	Left	/	22.88	23.5	0.046	<b>0.05</b>	0.078	<b>0.09</b>	0.08
20050	1720	1RB_Mid	Right	/	22.88	23.5	0.102	<b>0.12</b>	0.201	<b>0.23</b>	-0.01
20300	1745	1RB_Low	Bottom	/	22.40	23.5	0.474	<b>0.61</b>	0.821	<b>1.06</b>	0.03
20175	1732.5	1RB_Low	Bottom	/	22.51	23.5	0.471	<b>0.59</b>	0.817	<b>1.03</b>	0.02
20050	1720	1RB_Mid	Bottom	/	22.88	23.5	0.470	<b>0.54</b>	0.815	<b>0.94</b>	0.07
20300	1745	50RB_Low	Front	/	22.49	23.5	0.506	<b>0.64</b>	0.878	<b>1.11</b>	0.04
20175	1732.5	50RB_Low	Front	/	22.58	23.5	0.487	<b>0.60</b>	0.848	<b>1.05</b>	-0.06
20050	1720	50RB_Mid	Front	/	22.60	23.5	0.454	<b>0.56</b>	0.770	<b>0.95</b>	-0.09
20050	1720	50RB_Mid	Rear	/	22.60	23.5	0.372	<b>0.46</b>	0.654	<b>0.80</b>	-0.01
20050	1720	50RB_Mid	Left	/	22.60	23.5	0.047	<b>0.06</b>	0.080	<b>0.10</b>	0.03
20050	1720	50RB_Mid	Right	/	22.60	23.5	0.105	<b>0.13</b>	0.206	<b>0.25</b>	0.02
20300	1745	50RB_Low	Bottom	Fig.30	22.49	23.5	0.510	<b>0.64</b>	0.884	<b>1.12</b>	-0.04
20175	1732.5	50RB_Low	Bottom	/	22.58	23.5	0.496	<b>0.61</b>	0.871	<b>1.08</b>	0.08
20050	1720	50RB_Mid	Bottom	/	22.60	23.5	0.465	<b>0.57</b>	0.807	<b>0.99</b>	0.01
20050	1720	100RB	Front	/	22.58	23.5	0.447	<b>0.55</b>	0.745	<b>0.92</b>	-0.01
20050	1720	100RB	Bottom	/	22.58	23.5	0.459	<b>0.57</b>	0.806	<b>1.00</b>	0.03

Note1: The distance between the EUT and the phantom bottom is 10mm.

Note2: The LTE mode is QPSK\_20MHz.

**Table 14.1-31: SAR Values (LTE Band4 - Body)**

Ambient Temperature: 22.9°C						Liquid Temperature: 22.5°C					
Frequency		Mode	Test Position	Figure No./Note	Conducted Power (dBm)	Max. tune-up Power (dBm)	Measured SAR(10g) (W/kg)	Reported SAR(10g) (W/kg)	Measured SAR(1g) (W/kg)	Reported SAR(1g) (W/kg)	Power Drift (dB)
Ch.	MHz										
20300	1745	1RB_Low	Front	/	24.00	25	0.390	<b>0.49</b>	0.656	<b>0.83</b>	0.02
20175	1732.5	1RB_High	Front	Fig.31	24.10	25	0.505	<b>0.62</b>	0.838	<b>1.03</b>	0.04
20050	1720	1RB_High	Front	/	24.12	25	0.423	<b>0.52</b>	0.691	<b>0.85</b>	-0.03
20300	1745	1RB_Low	Rear	/	24.00	25	0.341	<b>0.43</b>	0.582	<b>0.73</b>	-0.06
20175	1732.5	1RB_High	Rear	/	24.10	25	0.382	<b>0.47</b>	0.658	<b>0.81</b>	0.09
20050	1720	1RB_High	Rear	/	24.12	25	0.407	<b>0.50</b>	0.681	<b>0.83</b>	0.05
20175	1732.5	50RB_Low	Front	/	23.18	24	0.346	<b>0.42</b>	0.566	<b>0.68</b>	-0.01
20175	1732.5	50RB_Low	Rear	/	23.18	24	0.350	<b>0.42</b>	0.560	<b>0.68</b>	0.07
20175	1732.5	100RB	Front	/	23.07	24	0.381	<b>0.47</b>	0.648	<b>0.80</b>	-0.01
20175	1732.5	100RB	Rear	/	23.07	24	0.293	<b>0.36</b>	0.507	<b>0.63</b>	0.03

Note1: The distance between the EUT and the phantom bottom is 15mm.

Note2: The LTE mode is QPSK\_20MHz.

**Table 14.1-32: SAR Values (LTE band26 - Head)**

Ambient Temperature: 22.9°C						Liquid Temperature: 22.5°C						
Frequency		Mode	Side	Test Position	Figure No.	Conducted Power (dBm)	Max. tune-up Power (dBm)	Measured SAR(10g) (W/kg)	Reported SAR(10g) (W/kg)	Measured SAR(1g) (W/kg)	Reported SAR(1g) (W/kg)	Power Drift (dB)
Ch.	MHz											
26965	841.5	1RB_Low	Left	Touch	/	24.18	24.5	0.182	<b>0.20</b>	0.229	<b>0.25</b>	0.05
26965	841.5	1RB_Low	Left	Tilt	/	24.18	24.5	0.123	<b>0.13</b>	0.154	<b>0.17</b>	-0.08
26965	841.5	1RB_Low	Right	Touch	Fig.32	24.18	24.5	0.278	<b>0.30</b>	0.370	<b>0.40</b>	-0.07
26965	841.5	1RB_Low	Right	Tilt	/	24.18	24.5	0.157	<b>0.17</b>	0.208	<b>0.22</b>	0.01
26965	841.5	36RB_Low	Left	Touch	/	23.18	23.5	0.145	<b>0.16</b>	0.182	<b>0.20</b>	0.02
26965	841.5	36RB_Low	Left	Tilt	/	23.18	23.5	0.105	<b>0.11</b>	0.133	<b>0.14</b>	-0.02
26965	841.5	36RB_Low	Right	Touch	/	23.18	23.5	0.223	<b>0.24</b>	0.295	<b>0.32</b>	-0.04
26965	841.5	36RB_Low	Right	Tilt	/	23.18	23.5	0.126	<b>0.14</b>	0.168	<b>0.18</b>	0.05

Note1: The LTE mode is QPSK\_15MHz.

**Table 14.1-33: SAR Values (LTE band26 - Body)**



Ambient Temperature: 22.9°C						Liquid Temperature: 22.5°C					
Frequency		Mode	Test Position	Figure No./ Note	Conducted Power (dBm)	Max. tune-up Power (dBm)	Measured SAR(10g) (W/kg)	Reported SAR(10g) (W/kg)	Measured SAR(1g) (W/kg)	Reported SAR(1g) (W/kg)	Power Drift (dB)
Ch.	MHz										
26965	841.5	1RB_Low	Front	/	24.18	24.5	0.461	<b>0.50</b>	0.634	<b>0.68</b>	0.06
26965	841.5	1RB_Low	Rear	Fig.33	24.18	24.5	0.505	<b>0.54</b>	0.720	<b>0.78</b>	-0.03
26965	841.5	1RB_Low	Left	/	24.18	24.5	0.063	<b>0.07</b>	0.107	<b>0.12</b>	-0.01
26965	841.5	1RB_Low	Right	/	24.18	24.5	0.245	<b>0.26</b>	0.349	<b>0.38</b>	-0.09
26965	841.5	1RB_Low	Bottom	/	24.18	24.5	0.205	<b>0.22</b>	0.360	<b>0.39</b>	0.04
26965	841.5	36RB_Low	Front	/	23.18	23.5	0.395	<b>0.43</b>	0.548	<b>0.59</b>	0.02
26965	841.5	36RB_Low	Rear	/	23.18	23.5	0.407	<b>0.44</b>	0.577	<b>0.62</b>	-0.06
26965	841.5	36RB_Low	Left	/	23.18	23.5	0.051	<b>0.05</b>	0.087	<b>0.09</b>	-0.01
26965	841.5	36RB_Low	Right	/	23.18	23.5	0.195	<b>0.21</b>	0.278	<b>0.30</b>	0.01
26965	841.5	36RB_Low	Bottom	/	23.18	23.5	0.169	<b>0.18</b>	0.296	<b>0.32</b>	0.06

Note1: The distance between the EUT and the phantom bottom is 10mm.

Note2: The LTE mode is QPSK\_15MHz.

### 14.2SAR results for Standard procedure

There is zoom scan measurement to be added for the highest measured SAR in each exposure configuration/band.

**Table 14.2-1: SAR Values (GSM 850 MHz Band - Head)**

Ambient Temperature: 22.9 °C						Liquid Temperature: 22.5 °C					
Frequency		Side	Test Position	Figure No./Note	Conducted Power (dBm)	Max. tune-up Power (dBm)	Measured SAR(10g) (W/kg)	Reported SAR(10g) (W/kg)	Measured SAR(1g) (W/kg)	Reported SAR(1g) (W/kg)	Power Drift (dB)
Ch.	MHz										
128	824.2	Right	Touch	Fig.1	29.95	30.5	0.434	<b>0.49</b>	0.558	<b>0.63</b>	-0.05

Note: the head SAR of GSM850 is tested with GPRS (3Txslots) mode because of VoIP.

**Table 14.2-2: SAR Values (GSM 850 MHz Band - Body)**

Ambient Temperature: 22.9 °C						Liquid Temperature: 22.5 °C					
Frequency		Mode (number of timeslots)	Test Position	Figure No./Note	Conducted Power (dBm)	Max. tune-up Power (dBm)	Measured SAR(10g) (W/kg)	Reported SAR(10g) (W/kg)	Measured SAR(1g) (W/kg)	Reported SAR(1g) (W/kg)	Power Drift (dB)
Ch.	MHz										
128	824.2	GPRS (3)	Front	Fig.2	29.95	30.5	0.724	<b>0.82</b>	1.03	<b>1.17</b>	0.04

Note: The distance between the EUT and the phantom bottom is 10mm.

**Table 14.2-3: SAR Values(GSM 1900 MHz Band - Head)**

Ambient Temperature: 22.9 °C						Liquid Temperature: 22.5 °C					
Frequency		Side	Test Position	Figure No./Note	Conducted Power (dBm)	Max. tune-up Power (dBm)	Measured SAR(10g) (W/kg)	Reported SAR(10g) (W/kg)	Measured SAR(1g) (W/kg)	Reported SAR(1g) (W/kg)	Power Drift (dB)
Ch.	MHz										
512	1850.2	Left	Touch	Fig.3	27.26	28	0.117	<b>0.14</b>	0.178	<b>0.21</b>	0.01

Note: the head SAR of GSM1900 is tested with GPRS (4Txslots) mode because of VoIP.

**Table 14.2-4: SAR Values (GSM 1900 MHz Band - Body)**

Ambient Temperature: 22.9 °C						Liquid Temperature: 22.5 °C					
Frequency		Mode (number of timeslots)	Test Position	Figure No./Note	Conducted Power (dBm)	Max. tune-up Power (dBm)	Measured SAR(10g) (W/kg)	Reported SAR(10g) (W/kg)	Measured SAR(1g) (W/kg)	Reported SAR(1g) (W/kg)	Power Drift (dB)
Ch.	MHz										
661	1880	GPRS (4)	Front	Fig.4	27.53	28	0.544	<b>0.61</b>	0.936	<b>1.04</b>	-0.09

Note: The distance between the EUT and the phantom bottom is 10mm.

**Table 14.2-5: SAR Values (WCDMA 850 MHz Band - Head)**

Ambient Temperature: 22.9 °C						Liquid Temperature: 22.5 °C					
Frequency		Side	Test Position	Figure No./Note	Conducted Power (dBm)	Max. tune-up Power (dBm)	Measured SAR(10g) (W/kg)	Reported SAR(10g) (W/kg)	Measured SAR(1g) (W/kg)	Reported SAR(1g) (W/kg)	Power Drift (dB)
Ch.	MHz										
4233	846.6	Right	Touch	Fig.5	23.86	24	0.250	<b>0.26</b>	0.329	<b>0.34</b>	-0.08

**Table 14.2-6: SAR Values (WCDMA 850 MHz Band - Body)**

Frequency		Test Position	Figure No./Note	Conducted Power (dBm)	Max. tune-up Power (dBm)	Measured SAR(10g) (W/kg)	Reported SAR(10g) (W/kg)	Measured SAR(1g) (W/kg)	Reported SAR(1g) (W/kg)	Power Drift (dB)
Ch.	MHz									
4233	846.6	Rear	Fig.6	23.86	24	0.529	<b>0.55</b>	0.758	<b>0.78</b>	-0.06

Note: The distance between the EUT and the phantom bottom is 10mm.

**Table 14.2-7: SAR Values(WCDMA 1700 MHz Band - Head)**

Frequency		Side	Test Position	Figure No./Note	Conducted Power (dBm)	Max. tune-up Power (dBm)	Measured SAR(10g) (W/kg)	Reported SAR(10g) (W/kg)	Measured SAR(1g) (W/kg)	Reported SAR(1g) (W/kg)	Power Drift (dB)
Ch.	MHz										
1537	1712.4	Left	Touch	Fig.7	23.68	24	0.164	<b>0.18</b>	0.237	<b>0.26</b>	0.17

**Table 14.2-8: SAR Values (WCDMA 1700 MHz Band - Body)**

Frequency		Test Position	Figure No./Note	Conducted Power (dBm)	Max. tune-up Power (dBm)	Measured SAR(10g) (W/kg)	Reported SAR(10g) (W/kg)	Measured SAR(1g) (W/kg)	Reported SAR(1g) (W/kg)	Power Drift (dB)
Ch.	MHz									
1738	1752.6	Front	Fig.8	21.88	22.5	0.562	<b>0.65</b>	0.960	<b>1.11</b>	-0.10

Note1: The distance between the EUT and the phantom bottom is 10mm.

**Table 14.2-9: SAR Values (WCDMA 1700 MHz Band - Body)**

Frequency		Test Position	Figure No./Note	Conducted Power (dBm)	Max. tune-up Power (dBm)	Measured SAR(10g) (W/kg)	Reported SAR(10g) (W/kg)	Measured SAR(1g) (W/kg)	Reported SAR(1g) (W/kg)	Power Drift (dB)
Ch.	MHz									
1537	1712.4	Front	Fig.9	23.68	24	0.468	<b>0.50</b>	0.759	<b>0.82</b>	-0.17

Note1: The distance between the EUT and the phantom bottom is 15mm.

**Table 14.2-10: SAR Values (WCDMA 1900 MHz Band - Head)**

Frequency		Side	Test Position	Figure No./Note	Conducted Power (dBm)	Max. tune-up Power (dBm)	Measured SAR(10g) (W/kg)	Reported SAR(10g) (W/kg)	Measured SAR(1g) (W/kg)	Reported SAR(1g) (W/kg)	Power Drift (dB)
Ch.	MHz										
9938	1907.6	Left	Touch	Fig.10	24.24	24.5	0.095	<b>0.10</b>	0.138	<b>0.15</b>	0.18

**Table 14.2-11: SAR Values (WCDMA 1900 MHz Band - Body)**

Frequency		Test Position	Figure No./Note	Conducted Power (dBm)	Max. tune-up Power (dBm)	Measured SAR(10g) (W/kg)	Reported SAR(10g) (W/kg)	Measured SAR(1g) (W/kg)	Reported SAR(1g) (W/kg)	Power Drift (dB)
Ch.	MHz									
9662	1852.4	Front	Fig.11	24.35	24.5	0.708	<b>0.73</b>	1.22	<b>1.26</b>	-0.08

Note1: The distance between the EUT and the phantom bottom is 10mm.

**Table 14.2-12: SAR Values (LTE Band2 - Head)**

Ambient Temperature: 22.9°C						Liquid Temperature: 22.5°C						
Frequency		Mode	Side	Test Position	Figure No./ Note	Conducted Power (dBm)	Max. tune-up Power (dBm)	Measured SAR(10g) (W/kg)	Reported SAR(10g) (W/kg)	Measured SAR(1g) (W/kg)	Reported SAR(1g) (W/kg)	Power Drift (dB)
Ch.	MHz											
19100	1900	1RB_Low	Left	Touch	Fig.12	23.76	24	0.108	<b>0.11</b>	0.163	<b>0.17</b>	0.01

Note1: The LTE mode is QPSK\_20MHz.

**Table 14.2-13: SAR Values (LTE Band2 - Body)**

Ambient Temperature: 22.9°C						Liquid Temperature: 22.5°C					
Frequency		Mode	Test Position	Figure No./ Note	Conducted Power (dBm)	Max. tune-up Power (dBm)	Measured SAR(10g) (W/kg)	Reported SAR(10g) (W/kg)	Measured SAR(1g) (W/kg)	Reported SAR(1g) (W/kg)	Power Drift (dB)
Ch.	MHz										
19100	1900	1RB_Low	Rear	Fig.13	23.76	24	0.444	<b>0.47</b>	0.761	<b>0.80</b>	0.09

Note1: The distance between the EUT and the phantom bottom is 10mm.

Note2: The LTE mode is QPSK\_20MHz.

**Table 14.2-14: SAR Values (LTE Band5 - Head)**

Ambient Temperature: 22.9°C						Liquid Temperature: 22.5°C						
Frequency		Mode	Side	Test Position	Figure No.	Conducted Power (dBm)	Max. tune-up Power (dBm)	Measured SAR(10g) (W/kg)	Reported SAR(10g) (W/kg)	Measured SAR(1g) (W/kg)	Reported SAR(1g) (W/kg)	Power Drift (dB)
Ch.	MHz											
20450	829	1RB_High	Right	Touch	Fig.14	23.72	24	0.310	<b>0.33</b>	0.407	<b>0.43</b>	0.18

Note1: The LTE mode is QPSK\_10MHz.

**Table 14.2-15: SAR Values (LTE Band5 -Body)**

Ambient Temperature: 22.9°C						Liquid Temperature: 22.5°C					
Frequency		Mode	Test Position	Figure No.	Conducted Power (dBm)	Max. tune-up Power (dBm)	Measured SAR(10g) (W/kg)	Reported SAR(10g) (W/kg)	Measured SAR(1g) (W/kg)	Reported SAR(1g) (W/kg)	Power Drift (dB)
Ch.	MHz										
20450	829	1RB_High	Rear	Fig.15	23.72	24	0.461	<b>0.49</b>	0.641	<b>0.68</b>	-0.03

Note1: The distance between the EUT and the phantom bottom is 10mm.

Note2: The LTE mode is QPSK\_10MHz.

**Table 14.2-16: SAR Values(LTE Band7 - Head)**

Ambient Temperature: 22.9°C						Liquid Temperature: 22.5°C						
Frequency		Mode	Side	Test Position	Figure No./ Note	Conducted Power (dBm)	Max. tune-up Power (dBm)	Measured SAR(10g) (W/kg)	Reported SAR(10g) (W/kg)	Measured SAR(1g) (W/kg)	Reported SAR(1g) (W/kg)	Power Drift (dB)
Ch.	MHz											
20850	2510	1RB_Low	Right	Touch	Fig.16	23.26	24.5	0.183	<b>0.24</b>	0.347	<b>0.46</b>	0.07

Note1: The LTE mode is QPSK\_20MHz.

**Table 14.2-17: SAR Values (LTE Band7 - Body)**

Ambient Temperature: 22.9°C						Liquid Temperature: 22.5°C					
Frequency		Mode	Test Position	Figure No./Note	Conducted Power (dBm)	Max. tune-up Power (dBm)	Measured SAR(10g) (W/kg)	Reported SAR(10g) (W/kg)	Measured SAR(1g) (W/kg)	Reported SAR(1g) (W/kg)	Power Drift (dB)
Ch.	MHz										
20850	2510	100RB	Bottom	/	20.28	20.5	0.538	<b>0.57</b>	1.04	<b>1.09</b>	0.01

Note1: The distance between the EUT and the phantom bottom is 10mm.

Note2: The LTE mode is QPSK\_20MHz.

**Table 14.2-18: SAR Values (LTE Band7 - Body)**

Ambient Temperature: 22.9°C						Liquid Temperature: 22.5°C					
Frequency		Mode	Test Position	Figure No./Note	Conducted Power (dBm)	Max. tune-up Power (dBm)	Measured SAR(10g) (W/kg)	Reported SAR(10g) (W/kg)	Measured SAR(1g) (W/kg)	Reported SAR(1g) (W/kg)	Power Drift (dB)
Ch.	MHz										
20850	2510	1RB_Low	Front	Fig.18	23.26	24.5	0.278	<b>0.37</b>	0.488	<b>0.65</b>	-0.02

Note1: The distance between the EUT and the phantom bottom is 15mm.

Note2: The LTE mode is QPSK\_20MHz.

**Table 14.2-19: SAR Values(LTE Band12 - Head)**

Ambient Temperature: 22.9°C						Liquid Temperature: 22.5°C						
Frequency		Mode	Side	Test Position	Figure No./Note	Conducted Power (dBm)	Max. tune-up Power (dBm)	Measured SAR(10g) (W/kg)	Reported SAR(10g) (W/kg)	Measured SAR(1g) (W/kg)	Reported SAR(1g) (W/kg)	Power Drift (dB)
Ch.	MHz											
23130	711	1RB_High	Right	Touch	Fig.19	23.84	24	0.119	<b>0.12</b>	0.147	<b>0.15</b>	0.03

Note1: The LTE mode is QPSK\_10MHz.

**Table 14.2-20: SAR Values (LTE Band12 - Body)**

Ambient Temperature: 22.9°C						Liquid Temperature: 22.5°C					
Frequency		Mode	Test Position	Figure No./Note	Conducted Power (dBm)	Max. tune-up Power (dBm)	Measured SAR(10g) (W/kg)	Reported SAR(10g) (W/kg)	Measured SAR(1g) (W/kg)	Reported SAR(1g) (W/kg)	Power Drift (dB)
Ch.	MHz										
23130	711	1RB_High	Rear	Fig.20	23.84	24	0.200	<b>0.21</b>	0.281	<b>0.29</b>	0.02

Note1: The distance between the EUT and the phantom bottom is 10mm.

Note2: The LTE mode is QPSK\_10MHz.

**Table 14.2-21: SAR Values(LTE Band13 - Head)**

Ambient Temperature: 22.9°C						Liquid Temperature: 22.5°C						
Frequency		Mode	Side	Test Position	Figure No./Note	Conducted Power (dBm)	Max. tune-up Power (dBm)	Measured SAR(10g) (W/kg)	Reported SAR(10g) (W/kg)	Measured SAR(1g) (W/kg)	Reported SAR(1g) (W/kg)	Power Drift (dB)
Ch.	MHz											
23230	782	1RB_Low	Right	Touch	Fig.21	23.54	24	0.229	<b>0.25</b>	0.293	<b>0.33</b>	0.02

Note1: The LTE mode is QPSK\_10MHz.

**Table 14.2-22: SAR Values (LTE Band13 - Body)**

Ambient Temperature: 22.9°C						Liquid Temperature: 22.5°C					
Frequency		Mode	Test Position	Figure No./Note	Conducted Power (dBm)	Max. tune-up Power (dBm)	Measured SAR(10g) (W/kg)	Reported SAR(10g) (W/kg)	Measured SAR(1g) (W/kg)	Reported SAR(1g) (W/kg)	Power Drift (dB)
Ch.	MHz										
23230	782	1RB_Low	Rear	Fig.22	23.54	24	0.284	<b>0.32</b>	0.446	<b>0.50</b>	0.05

Note1: The distance between the EUT and the phantom bottom is 10mm.

Note2: The LTE mode is QPSK\_10MHz.

**Table 14.2-23: SAR Values(LTE Band38 - Head)**

Ambient Temperature: 22.9°C						Liquid Temperature: 22.5°C						
Frequency		Mode	Side	Test Position	Figure No./Note	Conducted Power (dBm)	Max. tune-up Power (dBm)	Measured SAR(10g) (W/kg)	Reported SAR(10g) (W/kg)	Measured SAR(1g) (W/kg)	Reported SAR(1g) (W/kg)	Power Drift (dB)
Ch.	MHz											
38150	2610	1RB_Mid	Right	Touch	Fig.23	23.82	24	0.044	<b>0.05</b>	0.083	<b>0.09</b>	0.06

Note1: The LTE mode is QPSK\_20MHz.

**Table 14.2-24: SAR Values (LTE Band38 - Body)**

Ambient Temperature: 22.9°C						Liquid Temperature: 22.5°C					
Frequency		Mode	Test Position	Figure No./Note	Conducted Power (dBm)	Max. tune-up Power (dBm)	Measured SAR(10g) (W/kg)	Reported SAR(10g) (W/kg)	Measured SAR(1g) (W/kg)	Reported SAR(1g) (W/kg)	Power Drift (dB)
Ch.	MHz										
38150	2610	1RB_Mid	Bottom	Fig.24	23.82	24	0.345	<b>0.36</b>	0.672	<b>0.70</b>	-0.03

Note1: The distance between the EUT and the phantom bottom is 10mm.

Note2: The LTE mode is QPSK\_20MHz.

**Table 14.2-27: SAR Values(LTE Band41 - Head)**

Ambient Temperature: 22.9°C						Liquid Temperature: 22.5°C						
Frequency		Mode	Side	Test Position	Figure No./Note	Conducted Power (dBm)	Max. tune-up Power (dBm)	Measured SAR(10g) (W/kg)	Reported SAR(10g) (W/kg)	Measured SAR(1g) (W/kg)	Reported SAR(1g) (W/kg)	Power Drift (dB)
Ch.	MHz											
41490	2680	1RB_High	Right	Touch	Fig.27	23.79	24	0.041	<b>0.04</b>	0.080	<b>0.08</b>	0.04

Note1: The LTE mode is QPSK\_20MHz.

**Table 14.2-28: SAR Values (LTE Band41 - Body)**

Ambient Temperature: 22.9°C						Liquid Temperature: 22.5°C					
Frequency		Mode	Test Position	Figure No./Note	Conducted Power (dBm)	Max. tune-up Power (dBm)	Measured SAR(10g) (W/kg)	Reported SAR(10g) (W/kg)	Measured SAR(1g) (W/kg)	Reported SAR(1g) (W/kg)	Power Drift (dB)
Ch.	MHz										
39750	2506	1RB_High	Bottom	Fig.28	22.58	24	0.443	<b>0.61</b>	0.853	<b>1.18</b>	-0.14

Note1: The distance between the EUT and the phantom bottom is 10mm.

Note2: The LTE mode is QPSK\_20MHz.

**Table 14.1-29: SAR Values(LTE Band4 - Head)**

Ambient Temperature: 22.9°C						Liquid Temperature: 22.5°C						
Frequency		Mode	Side	Test Position	Figure No./ Note	Conducted Power (dBm)	Max. tune-up Power (dBm)	Measured SAR(10g) (W/kg)	Reported SAR(10g) (W/kg)	Measured SAR(1g) (W/kg)	Reported SAR(1g) (W/kg)	Power Drift (dB)
Ch.	MHz											
20050	1720	1RB_High	Left	Touch	Fig.29	24.12	25	0.138	<b>0.17</b>	0.207	<b>0.25</b>	0.10

Note1: The LTE mode is QPSK\_20MHz.

**Table 14.1-30: SAR Values (LTE Band4 - Body)**

Ambient Temperature: 22.9°C						Liquid Temperature: 22.5°C					
Frequency		Mode	Test Position	Figure No./ Note	Conducted Power (dBm)	Max. tune-up Power (dBm)	Measured SAR(10g) (W/kg)	Reported SAR(10g) (W/kg)	Measured SAR(1g) (W/kg)	Reported SAR(1g) (W/kg)	Power Drift (dB)
Ch.	MHz										
20300	1745	50RB_Low	Bottom	Fig.30	22.49	23.5	0.510	<b>0.64</b>	0.884	<b>1.12</b>	-0.04

Note1: The distance between the EUT and the phantom bottom is 10mm.

Note2: The LTE mode is QPSK\_20MHz.

**Table 14.1-31: SAR Values (LTE Band4 - Body)**

Ambient Temperature: 22.9°C						Liquid Temperature: 22.5°C					
Frequency		Mode	Test Position	Figure No./ Note	Conducted Power (dBm)	Max. tune-up Power (dBm)	Measured SAR(10g) (W/kg)	Reported SAR(10g) (W/kg)	Measured SAR(1g) (W/kg)	Reported SAR(1g) (W/kg)	Power Drift (dB)
Ch.	MHz										
20175	1732.5	1RB_High	Front	Fig.31	24.10	25	0.505	<b>0.62</b>	0.838	<b>1.03</b>	0.04

Note1: The distance between the EUT and the phantom bottom is 15mm.

Note2: The LTE mode is QPSK\_20MHz.

**Table 14.1-32: SAR Values (LTE band26 - Head)**

Ambient Temperature: 22.9°C						Liquid Temperature: 22.5°C						
Frequency		Mode	Side	Test Position	Figure No.	Conducted Power (dBm)	Max. tune-up Power (dBm)	Measured SAR(10g) (W/kg)	Reported SAR(10g) (W/kg)	Measured SAR(1g) (W/kg)	Reported SAR(1g) (W/kg)	Power Drift (dB)
Ch.	MHz											
26965	841.5	1RB_Low	Right	Touch	Fig.32	24.18	24.5	0.278	<b>0.30</b>	0.370	<b>0.40</b>	-0.07

Note1: The LTE mode is QPSK\_15MHz.

**Table 14.1-33: SAR Values (LTE band26 - Body)**

Ambient Temperature: 22.9°C						Liquid Temperature: 22.5°C					
Frequency		Mode	Test Position	Figure No./ Note	Conducted Power (dBm)	Max. tune-up Power (dBm)	Measured SAR(10g) (W/kg)	Reported SAR(10g) (W/kg)	Measured SAR(1g) (W/kg)	Reported SAR(1g) (W/kg)	Power Drift (dB)
Ch.	MHz										
26965	841.5	1RB_Low	Rear	Fig.33	24.18	24.5	0.505	<b>0.54</b>	0.720	<b>0.78</b>	-0.03

Note1: The distance between the EUT and the phantom bottom is 10mm.

Note2: The LTE mode is QPSK\_15MHz.

### 14.3WLAN Evaluation for 2.4G

According to the KDB248227 D01, SAR is measured for 2.4GHz 802.11b DSSS using the initial test position procedure.

#### Head Evaluation

**Table 14.3-1: SAR Values(WLAN - Head)– 802.11b (Fast SAR)**

Frequency		Side	Test Position	Figure No./ Note	Conducted Power (dBm)	Max. tune-up Power (dBm)	Measured SAR(10g) (W/kg)	Reported SAR(10g) (W/kg)	Measured SAR(1g) (W/kg)	Reported SAR(1g) (W/kg)	Power Drift (dB)	
MHz	Ch.											
		Ambient Temperature: 22.9°C						Liquid Temperature: 22.5°C				
2437	6	Left	Touch	/	14.23	14.5	0.397	<b>0.42</b>	0.869	<b>0.92</b>	-0.19	
2437	6	Left	Tilt	/	14.23	14.5	0.431	<b>0.46</b>	0.932	<b>0.99</b>	0.06	
2437	6	Right	Touch	/	14.23	14.5	0.229	<b>0.24</b>	0.484	<b>0.52</b>	-0.19	
2437	6	Right	Tilt	/	14.23	14.5	0.245	<b>0.26</b>	0.530	<b>0.56</b>	-0.07	

As shown above table, the initial test position for head is “LeftTilt”. So the head SAR of WLAN is presented as below:

**Table 14.3-2: SAR Values(WLAN - Head)– 802.11b (Full SAR)**

Frequency		Side	Test Position	Figure No./ Note	Conducted Power (dBm)	Max. tune-up Power (dBm)	Measured SAR(10g) (W/kg)	Reported SAR(10g) (W/kg)	Measured SAR(1g) (W/kg)	Reported SAR(1g) (W/kg)	Power Drift (dB)	
MHz	Ch.											
		Ambient Temperature: 22.9°C						Liquid Temperature: 22.5°C				
2437	6	Left	Tilt	Fig.34	14.23	14.5	0.435	<b>0.46</b>	1.06	<b>1.13</b>	0.06	
2437	6	Left	Touch	/	14.23	14.5	0.400	<b>0.43</b>	0.957	<b>1.02</b>	-0.19	
2437	6	Right	Tilt	/	14.23	14.5	0.256	<b>0.27</b>	0.582	<b>0.62</b>	-0.07	
2462	11	Left	Tilt	/	13.88	14.5	0.307	<b>0.35</b>	0.779	<b>0.90</b>	0.07	
2462	11	Left	Touch	/	13.88	14.5	0.270	<b>0.31</b>	0.677	<b>0.78</b>	0.07	

Note1: When the reported SAR of the initial test position is > 0.4 W/kg, SAR is repeated for the 802.11 transmission mode configuration tested in the initial test position using subsequent highest estimated 1-g SAR conditions determined by area scans, on the highest maximum output power channel, until the reported SAR is ≤ 0.8 W/kg.

Note2: For all positions/configurations tested using the initial test position and subsequent test positions, when the reported SAR is > 0.8 W/kg, SAR is measured for these test positions/configurations on the subsequent next highest measured output power channel until the reported SAR is ≤ 1.2 W/kg or all required channels are tested.

According to the KDB248227 D01, The reported SAR must be scaled to 100% transmission duty factor to determine compliance at the maximum tune-up tolerance limit. The scaled reported SAR is presented as below.

**Table 14.3-3: SAR Values (WLAN - Head) – 802.11b (Scaled Reported SAR)**

Frequency		Side	Test Position	Actual duty factor	maximum duty factor	Reported SAR (1g)(W/kg)	Scaled reported SAR (1g)(W/kg)		
MHz	Ch.								
		Ambient Temperature: 22.9°C						Liquid Temperature: 22.5°C	
2437	6	Left	Tilt	97.63%	100%	<b>1.13</b>	<b>1.16</b>		
2437	6	Left	Touch	97.63%	100%	<b>1.02</b>	<b>1.04</b>		

SAR is not required for OFDM because the 802.11b adjusted SAR ≤ 1.2 W/kg.



**Body Evaluation**

**Table 14.3-4: SAR Values(WLAN - Body)– 802.11b (Fast SAR)**

Frequency		Test Position	Figure No./ Note	Ambient Temperature: 22.9 °C		Liquid Temperature: 22.5 °C				Power Drift (dB)
MHz	Ch.			Conducted Power (dBm)	Max. tune-up Power (dBm)	Measured SAR(10g) (W/kg)	Reported SAR(10g) (W/kg)	Measured SAR(1g) (W/kg)	Reported SAR(1g) (W/kg)	
2437	6	Front	/	18.50	19	0.144	<b>0.16</b>	0.268	<b>0.30</b>	0.09
2437	6	Rear	/	18.50	19	0.130	<b>0.15</b>	0.256	<b>0.29</b>	0.19
2437	6	Right	/	18.50	19	0.053	<b>0.06</b>	0.109	<b>0.12</b>	-0.11
2437	6	Top	/	18.50	19	0.204	<b>0.23</b>	0.435	<b>0.49</b>	-0.03

As shown above table, the initial test position for body is “Front”. So the body SAR of WLAN is presented as below:

**Table 14.3-5: SAR Values(WLAN - Body)– 802.11b (Full SAR)**

Frequency		Test Position	Figure No./ Note	Ambient Temperature: 22.9 °C		Liquid Temperature: 22.5 °C				Power Drift (dB)
MHz	Ch.			Conducted Power (dBm)	Max. tune-up Power (dBm)	Measured SAR(10g) (W/kg)	Reported SAR(10g) (W/kg)	Measured SAR(1g) (W/kg)	Reported SAR(1g) (W/kg)	
2437	6	Top	Fig.35	18.50	19	0.228	<b>0.26</b>	0.463	<b>0.52</b>	-0.03

Note1: When the reported SAR of the initial test position is > 0.4 W/kg, SAR is repeated for the 802.11 transmission mode configuration tested in the initial test position using subsequent highest estimated 1-g SAR conditions determined by area scans, on the highest maximum output power channel, until the reported SAR is ≤ 0.8 W/kg.

Note2: For all positions/configurations tested using the initial test position and subsequent test positions, when the reported SAR is > 0.8 W/kg, SAR is measured for these test positions/configurations on the subsequent next highest measured output power channel until the reported SAR is ≤ 1.2 W/kg or all required channels are tested.

According to the KDB248227 D01, The reported SAR must be scaled to 100% transmission duty factor to determine compliance at the maximum tune-up tolerance limit. The scaled reported SAR is presented as below.

**Table 14.3-6: SAR Values (WLAN - Body) – 802.11b (Scaled Reported SAR)**

Frequency		Test Position	Ambient Temperature: 22.9 °C		Liquid Temperature: 22.5 °C	
MHz	Ch.		Actual duty factor	maximum duty factor	Reported SAR (1g)(W/kg)	Scaled reported SAR (1g)(W/kg)
2437	6	Front	97.63%	100%	<b>0.30</b>	<b>0.31</b>
2437	6	Top	97.63%	100%	<b>0.52</b>	<b>0.53</b>

SAR is not required for OFDM because the 802.11b adjusted SAR ≤ 1.2 W/kg.

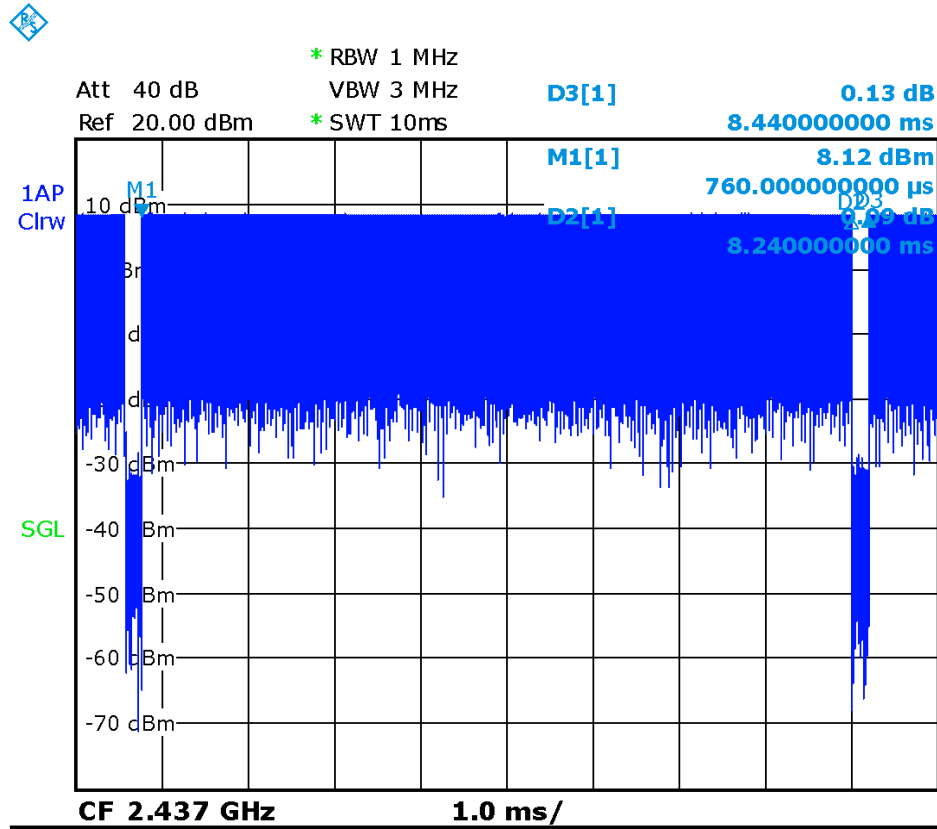

Picture 14.1 Duty factor plot for head

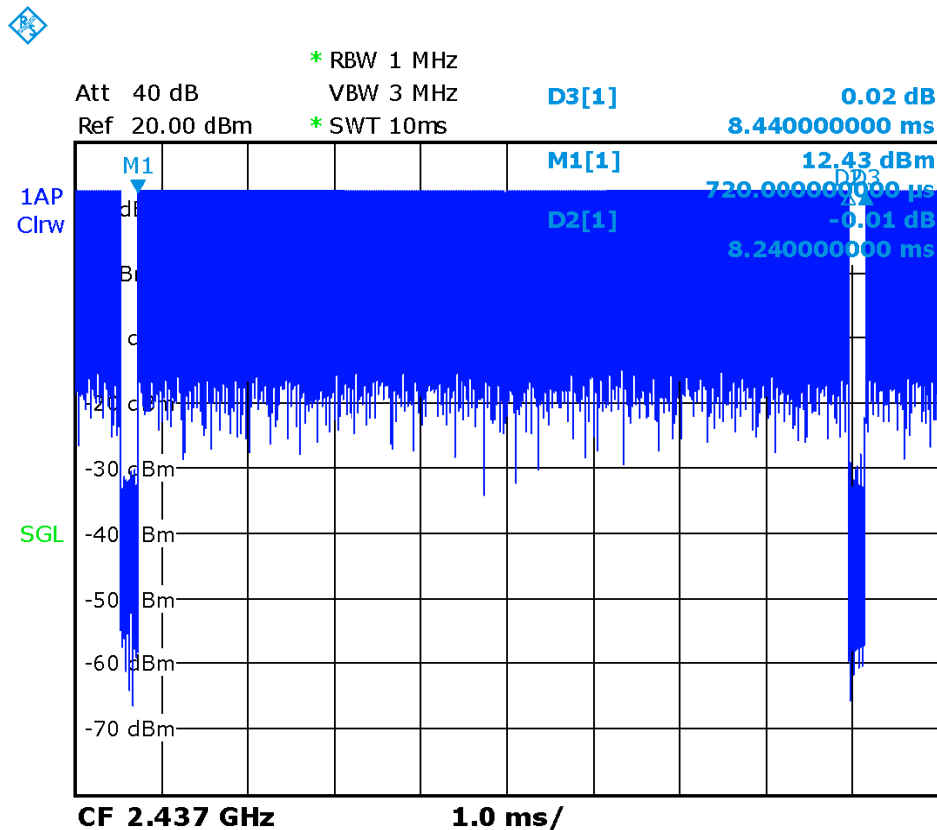

Picture 14.2 Duty factor plot for body

### 14.4 WLAN Evaluation For 5G

**Table 14.4-1: OFDM mode specified maximum output power of WLAN antenna**

802.11 mode	a	g	n		ac			
Ch. BW(MHz)	20	20	20	40	20	40	80	160
U-NII-1	X		X	X	X	X	X	
U-NII-2A	X		X	X	X	X	X	
U-NII-2C	X		X	X	X	X	X	
U-NII-3	X		X	X	X	X	X	
§ 15.247 (5.8 GHz)								

X: maximum(conducted) output power(mW), including tolerance, specified for production units

**Table 14.4-2: Maximum output power specified of WLAN antenna**

802.11 mode	a	g	n		ac			
Ch. BW(MHz)	20	20	20	40	20	40	80	160
U-NII-1	25		20	13	16	10	7	
U-NII-2A	25		20	13	16	10	7	
U-NII-2C	16		13	10	11	8	4	
U-NII-3	20		16	18	13	14	7	
§ 15.247 (5.8 GHz)								

- The maximum output power specified for production units is the same for all channels, modulations and data rates in each channel bandwidth configuration of the 802.11a/g/n/ac modes.
- The **blue highlighted** cells represent highest output configurations in each standalone or aggregated frequency band, with tune-up tolerance included.

**Table 14.4-3: Maximum output power measured of WLAN antenna, for the applicable OFDM configurations according to the default power measurement procedures for selection initial test configurations**

802.11 mode	a	n		ac		
BW(MHz)	20	20	40	20	40	80
U-NII-1	36/40/44/48 18/19/21/22	36/40/44/48 Lower power	38/46 Lower power	36/40/44/48 Lower power	38/46 Lower power	42 Lower power
U-NII-2A	52/56/60/64 23/19/20/19	52/56/60/64 Lower power	54/62 Lower power	52/56/60/64 Lower power	54/62 Lower power	58 Lower power
U-NII-2C	100/104/108/112 13/13/14/15 116/120/124/128 15/15/14/12 132/136/140/144 11/10/11/13	100/104/108/112 116/132/136/140 Lower power	102/110/134 Lower power	100/104/108 /112 116/132/136/ 140 Lower power	102/110/134 Lower power	106 Lower power
U-NII-3	149/153/157/161/165 16/18/16/14/13	149/153/157/16 1/165 Lower power	151/159 Lower power	149/153/157 /161/165 Lower power	151/159 Lower power	155 Lower power

- Channels with measured maximum power within 0.25dB are considered to have the same measured output. Channels selected for initial test configuration are **highlighted in yellow**.

**Table 14.4-4: Reported SAR of initial test configuration for Head**

802.11 mode	a	n		ac		
BW(MHz)	20	20	40	20	40	80
U-NII-1	36/40/44/48 U-NII-2A exclusion applied	36/40/44/48	38/46	36/40/44/48	38/46	42
U-NII-2A	52/56/60/64 0.95 / 0.94	52/56/60/64	54/62	52/56/60/64	54/62	58
U-NII-2C	100/104/108/112/116/120/124/128/132/136/140/144 0.92 / 0.95	100/104/108/112/116/132/136/140	102/110/118/126/134	100/104/108/112/116/132/136/140	102/110/134	106
U-NII-3	149/153/157/161/165 0.73	149/153/157/161/165	151/159	149/153/157/161/165	151/159	155

U-NII-1 and U-NII-2A bands have the same specified maximum output and tolerance; SAR is measured for U-NII-2A band first. Adjusted SAR of U-NII-2A band is  $\leq 1.2\text{W/kg}$ , SAR is not required for U-NII-1 band. Initial test configuration SAR for U-NII-2A band is  $> 0.8\text{ W/kg}$ , SAR is required for next highest output channel in initial test configuration. The next highest output channel SAR is  $\leq 1.2\text{ W/kg}$ , SAR is not required for subsequent next highest output channel. Similar circumstances apply to U-NII-2C band and U-NII-3 band. The green highlighted channels are next highest measured output channel in the initial test configuration. Highest measured output power channel tested initially are in yellow highlight.

**Table 14.4-5: Reported SAR of initial test configuration for Body**

802.11 mode	a	n		ac		
BW(MHz)	20	20	40	20	40	80
U-NII-1	36/40/44/48 U-NII-2A exclusion applied	36/40/44/48	38/46	36/40/44/48	38/46	42
U-NII-2A	52/56/60/64 0.05	52/56/60/64	54/62	52/56/60/64	54/62	58
U-NII-2C	100/104/108/112/116/120/124/128/132/136/140/144 0.16	100/104/108/112/116/132/136/140	102/110/118/126/134	100/104/108/112/116/132/136/140	102/110/134	106
U-NII-3	149/153/157/161/165 0.16	149/153/157/161/165	151/159	149/153/157/161/165	151/159	155

U-NII-1 and U-NII-2A bands have the same specified maximum output and tolerance; SAR is measured for U-NII-2A band first. Adjusted SAR of U-NII-2A band is  $\leq 1.2\text{W/kg}$ , SAR is not required for U-NII-1 band. Highest measured output power channel tested initially are in yellow highlight.

**Table 14.4-6: SAR Values(WLAN - Head)– 802.11a 6Mbps**

Frequency		Side	Test Position	Figure No.	Conducted Power (dBm)	Max. tune-upPower (dBm)	Measured SAR(10g) (W/kg)	Reported SAR(10g) (W/kg)	Measured SAR(1g) (W/kg)	Reported SAR(1g)(W/kg)	Power Drift (dB)
MHz	Ch.										
5260	52	Left	Touch	/	13.64	14	0.169	<b>0.18</b>	0.646	<b>0.70</b>	0.08
5260	52	Left	Tilt	/	13.64	14	0.176	<b>0.19</b>	0.661	<b>0.72</b>	-0.02
5260	52	Right	Touch	/	13.64	14	0.186	<b>0.20</b>	0.710	<b>0.77</b>	-0.09
5260	52	Right	Tilt	/	13.64	14	0.231	<b>0.25</b>	0.767	<b>0.83</b>	-0.17
5300	60	Right	Tilt	/	13.01	14	0.192	<b>0.24</b>	0.655	<b>0.82</b>	-0.02
5600	120	Left	Touch	/	11.81	12	0.216	<b>0.23</b>	0.765	<b>0.80</b>	0.05
5600	120	Left	Tilt	/	11.81	12	0.197	<b>0.21</b>	0.670	<b>0.70</b>	-0.01
5600	120	Right	Touch	/	11.81	12	0.204	<b>0.21</b>	0.701	<b>0.73</b>	0.02
5600	120	Right	Tilt	Fig.36	11.81	12	0.225	<b>0.24</b>	0.796	<b>0.83</b>	-0.16
5580	116	Right	Tilt	/	11.87	12	0.182	<b>0.19</b>	0.781	<b>0.80</b>	-0.06
5765	153	Left	Touch	/	12.45	13	0.134	<b>0.15</b>	0.436	<b>0.49</b>	0.15
5765	153	Left	Tilt	/	12.45	13	0.138	<b>0.16</b>	0.407	<b>0.46</b>	-0.05
5765	153	Right	Touch	/	12.45	13	0.132	<b>0.15</b>	0.439	<b>0.50</b>	0.02
5765	153	Right	Tilt	/	12.45	13	0.153	<b>0.17</b>	0.561	<b>0.64</b>	-0.07

**Table 14.4-7: SAR Values (WLAN - Body)– 802.11a6Mbps**

Frequency		Test Position	Figure No.	Conducted Power (dBm)	Max. tune-upPower (dBm)	Measured SAR(10g) (W/kg)	Reported SAR(10g) (W/kg)	Measured SAR(1g) (W/kg)	Reported SAR(1g)(W/kg)	Power Drift (dB)
MHz	Ch.									
5260	52	Front	/	13.64	14	0.008	<b>0.01</b>	0.024	<b>0.03</b>	0.01
5260	52	Rear	/	13.64	14	0.020	<b>0.02</b>	0.038	<b>0.04</b>	0.01
5260	52	Right	/	13.64	14	< 0.01	<b>&lt; 0.01</b>	< 0.01	<b>&lt; 0.01</b>	-0.08
5260	52	Top	/	13.64	14	0.016	<b>0.02</b>	0.018	<b>0.02</b>	-0.01
5600	120	Front	/	11.81	12	0.024	<b>0.03</b>	0.081	<b>0.09</b>	0.09
5600	120	Rear	/	11.81	12	0.039	<b>0.04</b>	0.116	<b>0.12</b>	-0.05
5600	120	Right	/	11.81	12	0.016	<b>0.02</b>	0.045	<b>0.05</b>	0.05
5600	120	Top	Fig.37	11.81	12	0.045	<b>0.05</b>	0.132	<b>0.14</b>	0.09
5765	153	Front	/	12.45	13	0.024	<b>0.03</b>	0.081	<b>0.09</b>	0.05
5765	153	Rear	/	12.45	13	0.033	<b>0.04</b>	0.098	<b>0.11</b>	0.05
5765	153	Right	/	12.45	13	0.009	<b>0.01</b>	0.029	<b>0.03</b>	-0.01
5765	153	Top	/	12.45	13	0.041	<b>0.05</b>	0.124	<b>0.14</b>	0.06

Note: The distance between the EUT and the phantom bottom is 10mm.

According to the KDB248227 D01, The reported SAR must be scaled to 100% transmission duty factor to determine compliance at the maximum tune-up tolerance limit. The scaled reported SAR is presented as below.

**Table 14.4-8: SAR Values (WLAN - Head) – 802.11a 6Mbps (Scaled Reported SAR)**

Frequency		Side	Test Position	Actual duty factor	maximum duty factor	Reported SAR (1g)(W/kg)	Scaled reported SAR (1g)(W/kg)
MHz	Ch.						
5260	52	Right	Tilt	87.31%	100%	<b>0.83</b>	<b>0.95</b>
5300	60	Right	Tilt	87.31%	100%	<b>0.82</b>	<b>0.94</b>
5600	120	Right	Tilt	87.31%	100%	<b>0.83</b>	<b>0.95</b>
5580	116	Right	Tilt	87.31%	100%	<b>0.80</b>	<b>0.92</b>
5765	153	Right	Tilt	87.31%	100%	<b>0.64</b>	<b>0.73</b>
5260	52	Right	Touch	87.31%	100%	<b>0.77</b>	<b>0.88</b>

**Table 14.4-9: SAR Values (WLAN - Body) – 802.11a 6Mbps (Scaled Reported SAR)**

Frequency		Test Position	D (mm)	Actual duty factor	maximum duty factor	Reported SAR (1g)(W/kg)	Scaled reported SAR (1g)(W/kg)
MHz	Ch.						
5260	52	Rear	10	87.31%	100%	<b>0.04</b>	<b>0.05</b>
5600	120	Top	10	87.31%	100%	<b>0.14</b>	<b>0.16</b>
5765	153	Top	10	87.31%	100%	<b>0.14</b>	<b>0.16</b>

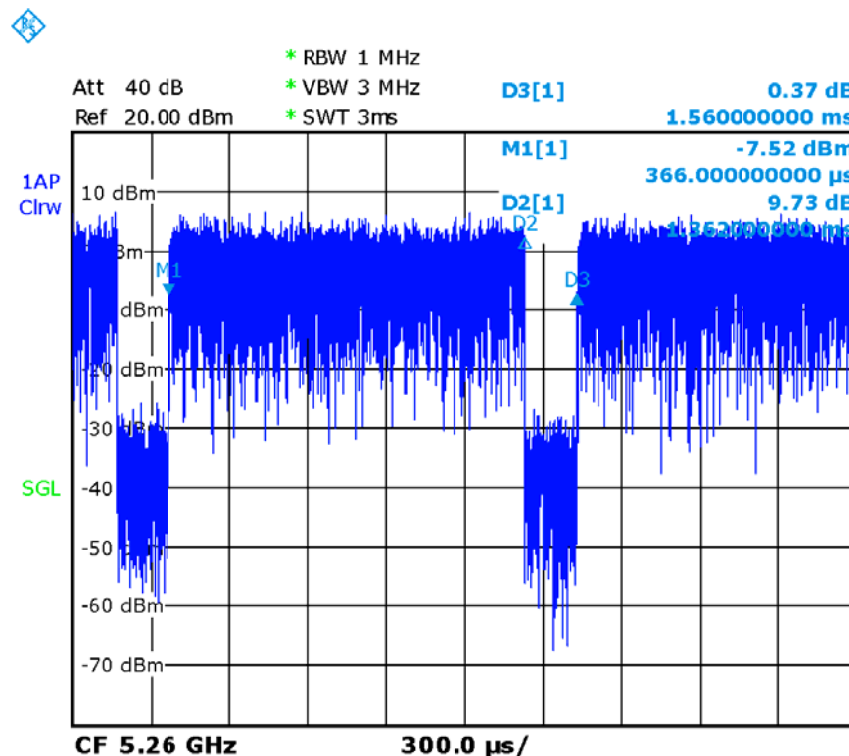

Picture 14.3 The plot of duty factor for U-NII-2A

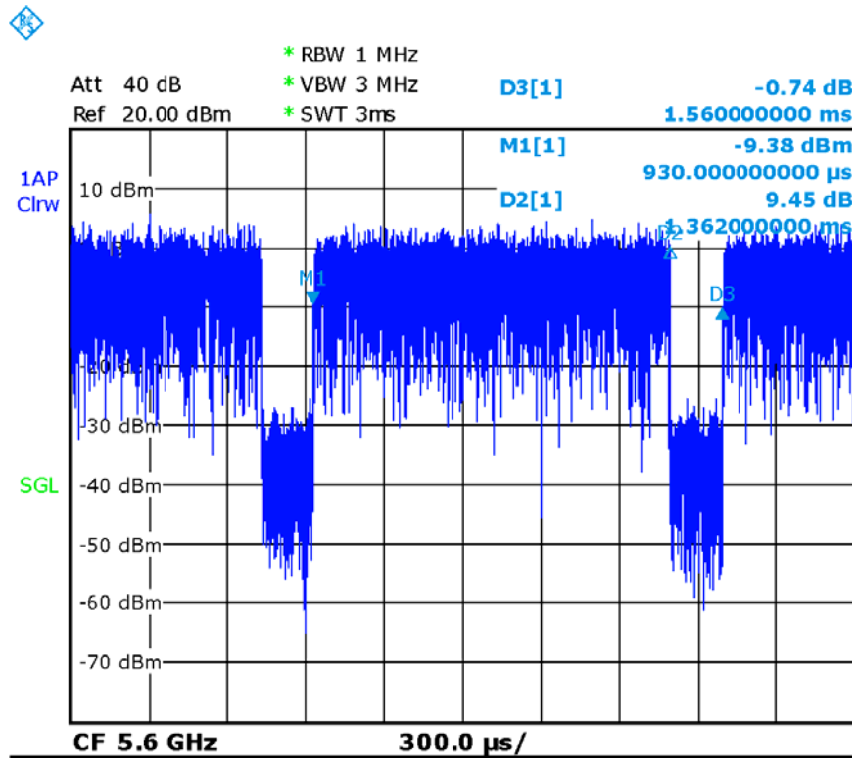

Picture 14.4 The plot of duty factor for U-NII-2C

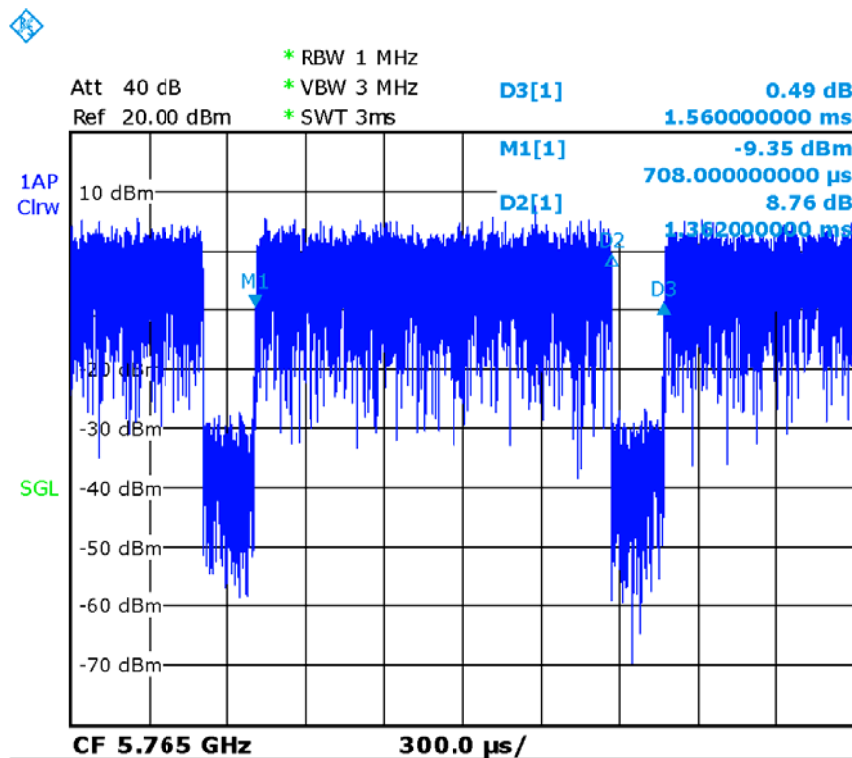

Picture 14.5 The plot of duty factor for U-NII-3

## 15SAR Measurement Variability

SAR measurement variability must be assessed for each frequency band, which is determined by the SARprobe calibration point and tissue-equivalent medium used for the device measurements. When both head and body tissue-equivalent media are required for SAR measurements in a frequency band, the variability measurement procedures should be applied to the tissue medium with the highest measured SAR, using the highest measured SAR configuration for that tissue-equivalent medium.

The following procedures are applied to determine if repeated measurements are required.

- 1) Repeated measurement is not required when the original highest measured SAR is  $< 0.80$  W/kg; steps 2) through 4) do not apply.
- 2) When the original highest measured SAR is  $\geq 0.80$  W/kg, repeat that measurement once.
- 3) Perform a second repeated measurement only if the ratio of largest to smallest SAR for the original and first repeated measurements is  $> 1.20$  or when the original or repeated measurement is  $\geq 1.45$  W/kg ( $\sim 10\%$  from the 1-g SAR limit).
- 4) Perform a third repeated measurement only if the original, first or second repeated measurement is  $\geq 1.5$  W/kg and the ratio of largest to smallest SAR for the original, first and second repeated measurements is  $> 1.20$ .

**Table 15.1: SAR Measurement Variability for Body GSM850 (1g)**

Frequency		Test Position	Spacing (mm)	Original SAR (W/kg)	First Repeated SAR (W/kg)	The Ratio	Second Repeated SAR (W/kg)
Ch.	MHz						
128	824.2	Front	10	1.03	1.02	1.01	/

**Table 15.2: SAR Measurement Variability for Body PCS1900 (1g)**

Frequency		Test Position	Spacing (mm)	Original SAR (W/kg)	First Repeated SAR (W/kg)	The Ratio	Second Repeated SAR (W/kg)
Ch.	MHz						
661	1880	Front	10	0.936	0.927	1.01	/

**Table 15.3: SAR Measurement Variability for Body W1700 (1g)**

Frequency		Test Position	Spacing (mm)	Original SAR (W/kg)	First Repeated SAR (W/kg)	The Ratio	Second Repeated SAR (W/kg)
Ch.	MHz						
1738	1752.6	Front	10	0.960	0.953	1.01	/

**Table 15.4: SAR Measurement Variability for Body W1900 (1g)**

Frequency		Test Position	Spacing (mm)	Original SAR (W/kg)	First Repeated SAR (W/kg)	The Ratio	Second Repeated SAR (W/kg)
Ch.	MHz						
8662	1852.4	Front	10	1.22	1.20	1.02	/



**Table 15.5: SAR Measurement Variability for Body LTE B7 (1g)**

Frequency		Mode	Test Position	Spacing (mm)	Original SAR (W/kg)	First Repeated SAR (W/kg)	The Ratio	Second Repeated SAR (W/kg)
Ch.	MHz							
20850	2510	100RB	Bottom	10	1.04	1.03	1.01	/

**Table 15.6: SAR Measurement Variability for Body LTE B41 (1g)**

Frequency		Mode	Test Position	Spacing (mm)	Original SAR (W/kg)	First Repeated SAR (W/kg)	The Ratio	Second Repeated SAR (W/kg)
Ch.	MHz							
39750	2506	1RB_High	Bottom	10	0.853	0.845	1.01	/

**Table 15.7: SAR Measurement Variability for Body LTE B4 (1g)**

Frequency		Mode	Test Position	Spacing (mm)	Original SAR (W/kg)	First Repeated SAR (W/kg)	The Ratio	Second Repeated SAR (W/kg)
Ch.	MHz							
20300	1745	50RB_Low	Bottom	10	0.884	0.871	1.01	/

**Table 15.8: SAR Measurement Variability for Body LTE B4 (1g)**

Frequency		Mode	Test Position	Spacing (mm)	Original SAR (W/kg)	First Repeated SAR (W/kg)	The Ratio	Second Repeated SAR (W/kg)
Ch.	MHz							
20175	1732.5	1RB_High	Front	15	0.838	0.831	1.01	/

## 16 Measurement Uncertainty

### 16.1 Measurement Uncertainty for Normal SAR Tests (300MHz~3GHz)

No.	Error Description	Type	Uncertainty value	Probably Distribution	Div.	(Ci) 1g	(Ci) 10g	Std. Unc. (1g)	Std. Unc. (10g)	Degree of freedom
<b>Measurement system</b>										
1	Probe calibration	B	6.0	N	1	1	1	6.0	6.0	$\infty$
2	Isotropy	B	4.7	R	$\sqrt{3}$	0.7	0.7	1.9	1.9	$\infty$
3	Boundary effect	B	1.0	R	$\sqrt{3}$	1	1	0.6	0.6	$\infty$
4	Linearity	B	4.7	R	$\sqrt{3}$	1	1	2.7	2.7	$\infty$
5	Detection limit	B	1.0	N	1	1	1	0.6	0.6	$\infty$
6	Readout electronics	B	0.3	R	$\sqrt{3}$	1	1	0.3	0.3	$\infty$
7	Response time	B	0.8	R	$\sqrt{3}$	1	1	0.5	0.5	$\infty$
8	Integration time	B	2.6	R	$\sqrt{3}$	1	1	1.5	1.5	$\infty$
9	RF ambient conditions-noise	B	0	R	$\sqrt{3}$	1	1	0	0	$\infty$
10	RF ambient conditions-reflection	B	0	R	$\sqrt{3}$	1	1	0	0	$\infty$
11	Probe positioned mech. restrictions	B	0.4	R	$\sqrt{3}$	1	1	0.2	0.2	$\infty$
12	Probe positioning with respect to phantom shell	B	2.9	R	$\sqrt{3}$	1	1	1.7	1.7	$\infty$
13	Post-processing	B	1.0	R	$\sqrt{3}$	1	1	0.6	0.6	$\infty$
<b>Test sample related</b>										
14	Test sample positioning	A	3.3	N	1	1	1	3.3	3.3	71
15	Device holder uncertainty	A	3.4	N	1	1	1	3.4	3.4	5
16	Drift of output power	B	5.0	R	$\sqrt{3}$	1	1	2.9	2.9	$\infty$
<b>Phantom and set-up</b>										
17	Phantom uncertainty	B	4.0	R	$\sqrt{3}$	1	1	2.3	2.3	$\infty$
18	Liquid conductivity (target)	B	5.0	R	$\sqrt{3}$	0.64	0.43	1.8	1.2	$\infty$
19	Liquid conductivity (meas.)	A	2.06	N	1	0.64	0.43	1.32	0.89	43
20	Liquid permittivity (target)	B	5.0	R	$\sqrt{3}$	0.6	0.49	1.7	1.4	$\infty$
21	Liquid permittivity (meas.)	A	1.6	N	1	0.6	0.49	1.0	0.8	521

Combined standard uncertainty	$u_c = \sqrt{\sum_{i=1}^{21} c_i^2 u_i^2}$							9.55	9.43	257
Expanded uncertainty (confidence interval of 95 %)	$u_e = 2u_c$							19.1	18.9	

**16.2 Measurement Uncertainty for Normal SAR Tests (3~6GHz)**

No.	Error Description	Type	Uncertainty value	Probably Distribution	Div.	(Ci) 1g	(Ci) 10g	Std. Unc. (1g)	Std. Unc. (10g)	Degree of freedom
<b>Measurement system</b>										
1	Probe calibration	B	6.55	N	1	1	1	6.55	6.55	∞
2	Isotropy	B	4.7	R	$\sqrt{3}$	0.7	0.7	1.9	1.9	∞
3	Boundary effect	B	2.0	R	$\sqrt{3}$	1	1	1.2	1.2	∞
4	Linearity	B	4.7	R	$\sqrt{3}$	1	1	2.7	2.7	∞
5	Detection limit	B	1.0	R	$\sqrt{3}$	1	1	0.6	0.6	∞
6	Readout electronics	B	0.3	R	$\sqrt{3}$	1	1	0.3	0.3	∞
7	Response time	B	0.8	R	$\sqrt{3}$	1	1	0.5	0.5	∞
8	Integration time	B	2.6	R	$\sqrt{3}$	1	1	1.5	1.5	∞
9	RF ambient conditions-noise	B	0	R	$\sqrt{3}$	1	1	0	0	∞
10	RF ambient conditions-reflection	B	0	R	$\sqrt{3}$	1	1	0	0	∞
11	Probe positioned mech. restrictions	B	0.8	R	$\sqrt{3}$	1	1	0.5	0.5	∞
12	Probe positioning with respect to phantom shell	B	6.7	R	$\sqrt{3}$	1	1	3.9	3.9	∞
13	Post-processing	B	4.0	R	$\sqrt{3}$	1	1	2.3	2.3	∞
<b>Test sample related</b>										
14	Test sample positioning	A	3.3	N	1	1	1	3.3	3.3	71
15	Device holder uncertainty	A	3.4	N	1	1	1	3.4	3.4	5
16	Drift of output power	B	5.0	R	$\sqrt{3}$	1	1	2.9	2.9	∞
<b>Phantom and set-up</b>										
17	Phantom uncertainty	B	4.0	R	$\sqrt{3}$	1	1	2.3	2.3	∞
18	Liquid conductivity (target)	B	5.0	R	$\sqrt{3}$	0.64	0.43	1.8	1.2	∞
19	Liquid conductivity (meas.)	A	2.06	N	1	0.64	0.43	1.32	0.89	43
20	Liquid permittivity	B	5.0	R	$\sqrt{3}$	0.6	0.49	1.7	1.4	∞

	(target)									
21	Liquid permittivity (meas.)	A	1.6	N	1	0.6	0.49	1.0	0.8	521
Combined standard uncertainty		$u_c' = \sqrt{\sum_{i=1}^{21} c_i^2 u_i^2}$						10.7	10.6	257
Expanded uncertainty (confidence interval of 95 %)		$u_e = 2u_c$						21.4	21.1	

### 16.3 Measurement Uncertainty for Fast SAR Tests (300MHz~3GHz)

No.	Error Description	Type	Uncertainty value	Probably Distribution	Div.	(Ci) 1g	(Ci) 10g	Std. Unc. (1g)	Std. Unc. (10g)	Degree of freedom
<b>Measurement system</b>										
1	Probe calibration	B	6.0	N	1	1	1	6.0	6.0	∞
2	Isotropy	B	4.7	R	$\sqrt{3}$	0.7	0.7	1.9	1.9	∞
3	Boundary effect	B	1.0	R	$\sqrt{3}$	1	1	0.6	0.6	∞
4	Linearity	B	4.7	R	$\sqrt{3}$	1	1	2.7	2.7	∞
5	Detection limit	B	1.0	R	$\sqrt{3}$	1	1	0.6	0.6	∞
6	Readout electronics	B	0.3	R	$\sqrt{3}$	1	1	0.3	0.3	∞
7	Response time	B	0.8	R	$\sqrt{3}$	1	1	0.5	0.5	∞
8	Integration time	B	2.6	R	$\sqrt{3}$	1	1	1.5	1.5	∞
9	RF ambient conditions-noise	B	0	R	$\sqrt{3}$	1	1	0	0	∞
10	RF ambient conditions-reflection	B	0	R	$\sqrt{3}$	1	1	0	0	∞
11	Probe positioned mech. Restrictions	B	0.4	R	$\sqrt{3}$	1	1	0.2	0.2	∞
12	Probe positioning with respect to phantom shell	B	2.9	R	$\sqrt{3}$	1	1	1.7	1.7	∞
13	Post-processing	B	1.0	R	$\sqrt{3}$	1	1	0.6	0.6	∞
14	Fast SAR z-Approximation	B	7.0	R	$\sqrt{3}$	1	1	4.0	4.0	∞
<b>Test sample related</b>										
15	Test sample positioning	A	3.3	N	1	1	1	3.3	3.3	71
16	Device holder uncertainty	A	3.4	N	1	1	1	3.4	3.4	5
17	Drift of output power	B	5.0	R	$\sqrt{3}$	1	1	2.9	2.9	∞
<b>Phantom and set-up</b>										
18	Phantom uncertainty	B	4.0	R	$\sqrt{3}$	1	1	2.3	2.3	∞

19	Liquid conductivity (target)	B	5.0	R	$\sqrt{3}$	0.64	0.43	1.8	1.2	$\infty$
20	Liquid conductivity (meas.)	A	2.06	N	1	0.64	0.43	1.32	0.89	43
21	Liquid permittivity (target)	B	5.0	R	$\sqrt{3}$	0.6	0.49	1.7	1.4	$\infty$
22	Liquid permittivity (meas.)	A	1.6	N	1	0.6	0.49	1.0	0.8	521
Combined standard uncertainty		$u_c = \sqrt{\sum_{i=1}^{22} c_i^2 u_i^2}$						10.4	10.3	257
Expanded uncertainty (confidence interval of 95 %)		$u_e = 2u_c$						20.8	20.6	

#### 16.4 Measurement Uncertainty for Fast SAR Tests (3~6GHz)

No.	Error Description	Type	Uncertainty value	Probably Distribution	Div.	(Ci) 1g	(Ci) 10g	Std. Unc. (1g)	Std. Unc. (10g)	Degree of freedom
<b>Measurement system</b>										
1	Probe calibration	B	6.55	N	1	1	1	6.55	6.55	$\infty$
2	Isotropy	B	4.7	R	$\sqrt{3}$	0.7	0.7	1.9	1.9	$\infty$
3	Boundary effect	B	2.0	R	$\sqrt{3}$	1	1	1.2	1.2	$\infty$
4	Linearity	B	4.7	R	$\sqrt{3}$	1	1	2.7	2.7	$\infty$
5	Detection limit	B	1.0	R	$\sqrt{3}$	1	1	0.6	0.6	$\infty$
6	Readout electronics	B	0.3	R	$\sqrt{3}$	1	1	0.3	0.3	$\infty$
7	Response time	B	0.8	R	$\sqrt{3}$	1	1	0.5	0.5	$\infty$
8	Integration time	B	2.6	R	$\sqrt{3}$	1	1	1.5	1.5	$\infty$
9	RF ambient conditions-noise	B	0	R	$\sqrt{3}$	1	1	0	0	$\infty$
10	RF ambient conditions-reflection	B	0	R	$\sqrt{3}$	1	1	0	0	$\infty$
11	Probe positioned mech. Restrictions	B	0.8	R	$\sqrt{3}$	1	1	0.5	0.5	$\infty$
12	Probe positioning with respect to phantom shell	B	6.7	R	$\sqrt{3}$	1	1	3.9	3.9	$\infty$
13	Post-processing	B	1.0	R	$\sqrt{3}$	1	1	0.6	0.6	$\infty$
14	Fast SAR z-Approximation	B	14.0	R	$\sqrt{3}$	1	1	8.1	8.1	$\infty$
<b>Test sample related</b>										
15	Test sample positioning	A	3.3	N	1	1	1	3.3	3.3	71
16	Device holder	A	3.4	N	1	1	1	3.4	3.4	5

	uncertainty									
17	Drift of output power	B	5.0	R	$\sqrt{3}$	1	1	2.9	2.9	$\infty$
<b>Phantom and set-up</b>										
18	Phantom uncertainty	B	4.0	R	$\sqrt{3}$	1	1	2.3	2.3	$\infty$
19	Liquid conductivity (target)	B	5.0	R	$\sqrt{3}$	0.64	0.43	1.8	1.2	$\infty$
20	Liquid conductivity (meas.)	A	2.06	N	1	0.64	0.43	1.32	0.89	43
21	Liquid permittivity (target)	B	5.0	R	$\sqrt{3}$	0.6	0.49	1.7	1.4	$\infty$
22	Liquid permittivity (meas.)	A	1.6	N	1	0.6	0.49	1.0	0.8	521
Combined standard uncertainty		$u_c = \sqrt{\sum_{i=1}^{22} c_i^2 u_i^2}$						13.5	13.4	257
Expanded uncertainty (confidence interval of 95 %)		$u_e = 2u_c$						27.0	26.8	

## 17 MAIN TEST INSTRUMENTS

Table 17.1: List of Main Instruments

No.	Name	Type	Serial Number	Calibration Date	Valid Period
01	Network analyzer	E5071C	MY46110673	January 13, 2017	One year
02	Power meter	NRVD	102083	September 22, 2016	One year
03	Power sensor	NRV-Z5	100595		
04	Signal Generator	E4438C	MY49071430	January13,2017	One Year
05	Amplifier	60S1G4	0331848	No Calibration Requested	
06	BTS	E5515C	MY50263375	January 16, 2017	One year
07	BTS	CMW500	159890	November 25, 2016	One year
08	E-field Probe	SPEAG EX3DV4	3846	January13, 2017	One year
09	DAE	SPEAG DAE4	1331	January19, 2017	One year
10	Dipole Validation Kit	SPEAG D750V3	1017	July 19,2017	One year
11	Dipole Validation Kit	SPEAG D835V2	4d069	July 19,2017	One year
12	Dipole Validation Kit	SPEAG D1750V2	1003	July 21,2017	One year
13	Dipole Validation Kit	SPEAG D1900V2	5d101	July 26,2017	One year
14	Dipole Validation Kit	SPEAG D2300V2	1018	July 21,2017	One year
15	Dipole Validation Kit	SPEAG D2450V2	853	July 21,2017	One year
16	Dipole Validation Kit	SPEAG D2600V2	1012	July 21,2017	One year
17	Dipole Validation Kit	SPEAG D5GHzV2	1060	July 25,2017	One year

\*\*\*END OF REPORT BODY\*\*\*

## ANNEX A Graph Results

### 850 Right Cheek Low

Date: 2017-8-8

Electronics: DAE4 Sn1331

Medium: Head 850 MHz

Medium parameters used:  $f = 825$  MHz;  $\sigma = 0.889$  mho/m;  $\epsilon_r = 42.02$ ;  $\rho = 1000$  kg/m<sup>3</sup>

Ambient Temperature: 22.9°C      Liquid Temperature: 22.5°C

Communication System: GSM 850 GPRS Frequency: 824.2 MHz Duty Cycle: 1:2.67

Probe: EX3DV4 –SN3846ConvF(9.33, 9.33, 9.33)

**Area Scan (81x131x1):** Interpolated grid: dx=1.000 mm, dy=1.000 mm

Maximum value of SAR (interpolated) = 0.618 W/kg

**Zoom Scan (7x7x7)/Cube 0:** Measurement grid: dx=5mm, dy=5mm, dz=5mm

Reference Value = 5.729 V/m; Power Drift = -0.05 dB

Peak SAR (extrapolated) = 0.727 W/kg

**SAR(1 g) = 0.558 W/kg; SAR(10 g) = 0.434 W/kg**

Maximum value of SAR (measured) = 0.604 W/kg

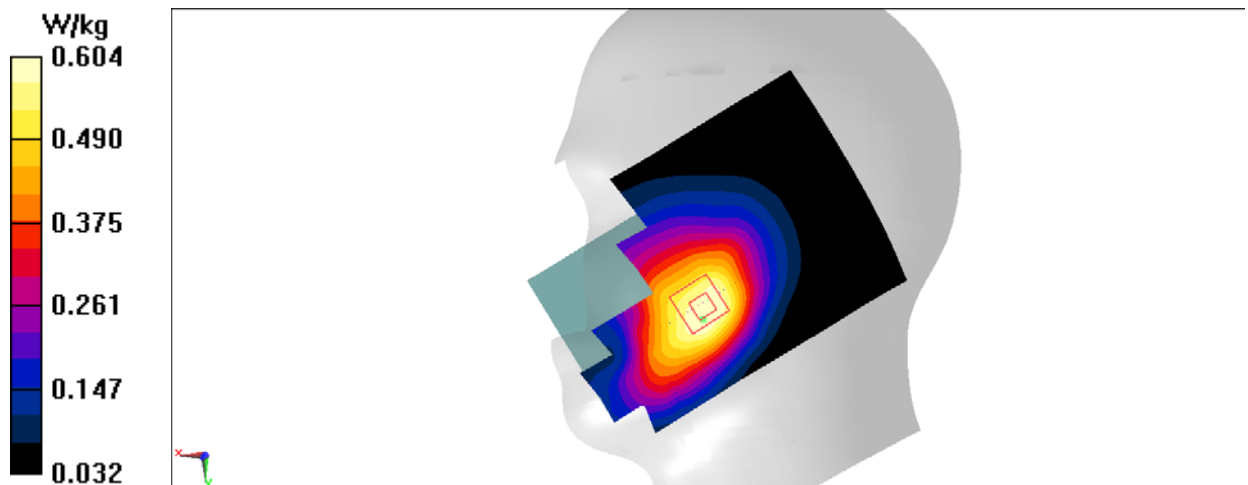

Fig.1 850MHz

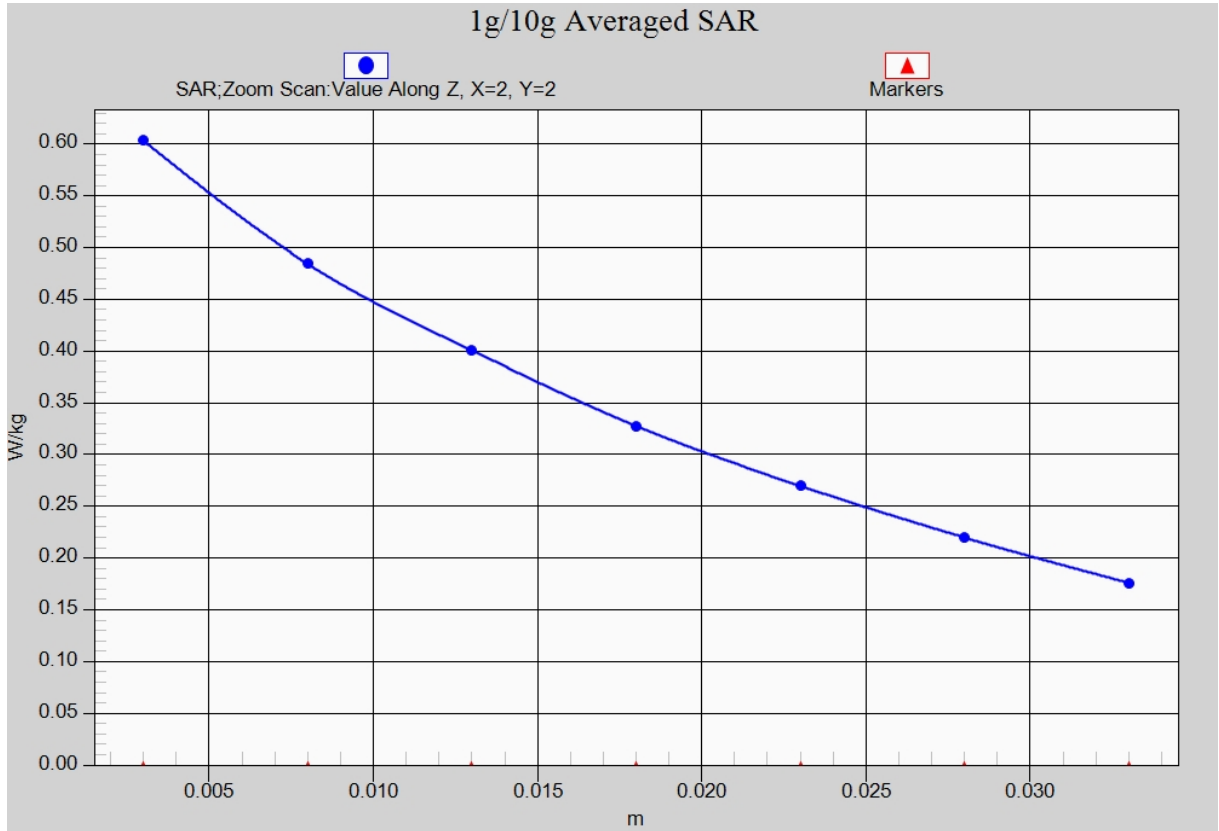

Fig. 1-1 Z-Scan at power reference point (850 MHz)



### 850Body FrontLow

Date: 2017-8-8

Electronics: DAE4 Sn1331

Medium: Body 850 MHz

Medium parameters used:  $f = 825$  MHz;  $\sigma = 0.96$  mho/m;  $\epsilon_r = 56.1$ ;  $\rho = 1000$  kg/m<sup>3</sup>

Ambient Temperature: 22.9°C      Liquid Temperature: 22.5°C

Communication System: GSM 850 GPRS Frequency: 824.2 MHz Duty Cycle: 1:2.67

Probe: EX3DV4 –SN3846ConvF(9.52, 9.52, 9.52)

**Area Scan (131x81x1):** Interpolated grid: dx=1.000 mm, dy=1.000 mm

Maximum value of SAR (interpolated) = 1.21 W/kg

**Zoom Scan (7x7x7)/Cube 0:** Measurement grid: dx=5mm, dy=5mm, dz=5mm

Reference Value = 22.42 V/m; Power Drift = 0.04 dB

Peak SAR (extrapolated) = 1.39 W/kg

**SAR(1 g) = 1.03 W/kg; SAR(10 g) = 0.724 W/kg**

Maximum value of SAR (measured) = 1.08 W/kg

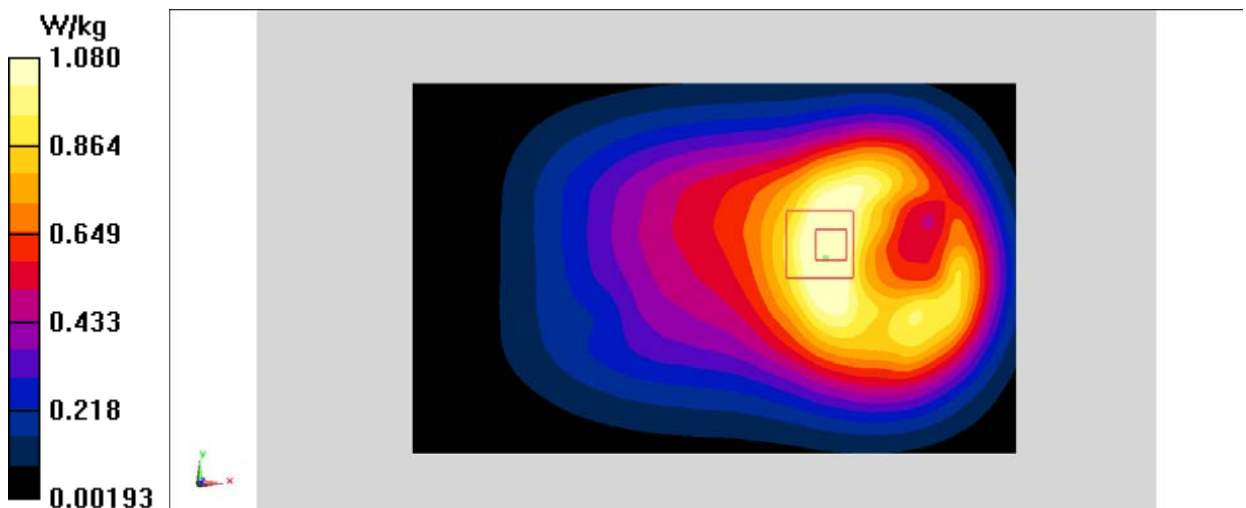

Fig.2 850 MHz

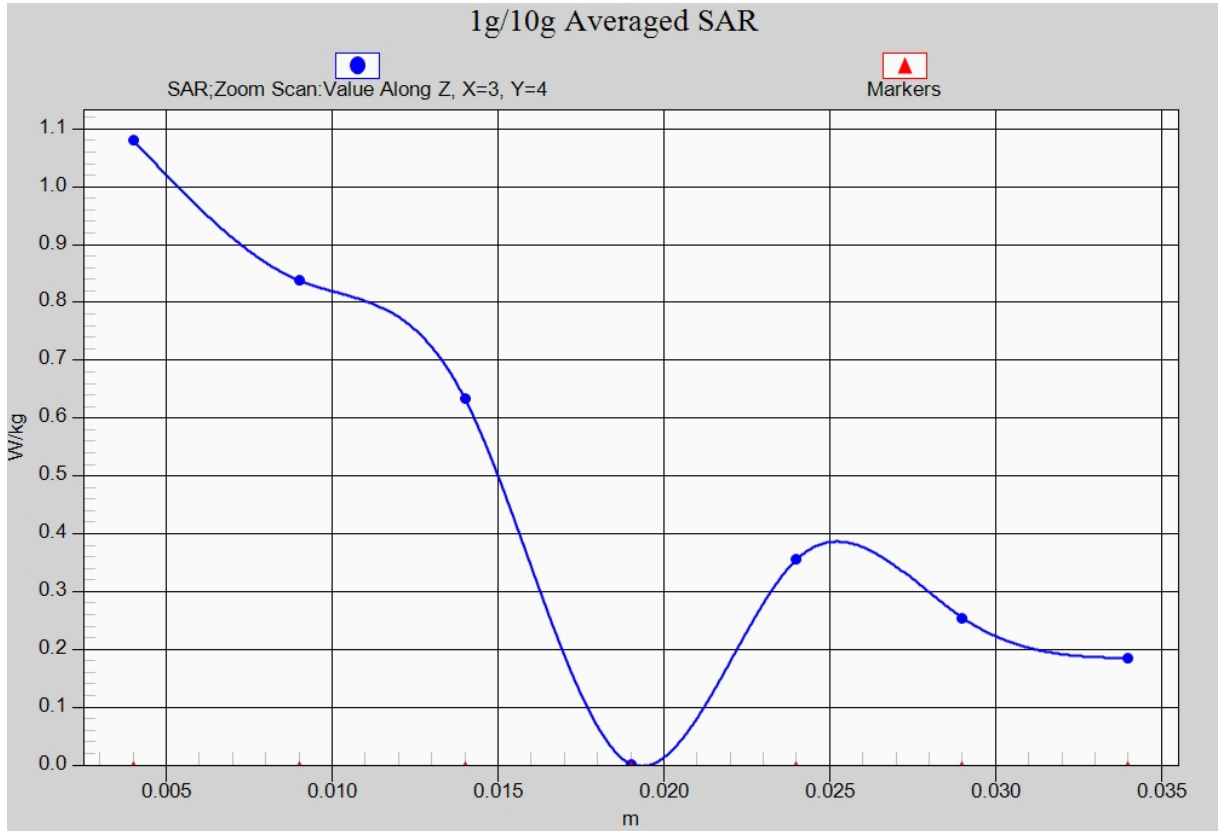

Fig. 2-1Z-Scan at power reference point (850 MHz)

### 1900 LeftCheek Low

Date: 2017-8-9

Electronics: DAE4 Sn1331

Medium: Head 1900 MHz

Medium parameters used (interpolated):  $f = 1850.2$  MHz;  $\sigma = 1.399$  mho/m;  $\epsilon_r = 40.66$ ;  $\rho = 1000$  kg/m<sup>3</sup>

Ambient Temperature: 22.9°C      Liquid Temperature: 22.5°C

Communication System: GSM 1900MHzFrequency: 1850.2 MHz Duty Cycle: 1:2

Probe: EX3DV4-SN3846 ConvF(7.89, 7.89, 7.89)

**Area Scan (71x121x1):** Interpolated grid: dx=1.000 mm, dy=1.000 mm

Maximum value of SAR (interpolated) = 0.373 W/kg

**Zoom Scan (7x7x7)/Cube 0:** Measurement grid: dx=5mm, dy=5mm, dz=5mm

Reference Value = 5.867 V/m; Power Drift = 0.01 dB

Peak SAR (extrapolated) = 0.251 W/kg

**SAR(1 g) = 0.178 W/kg; SAR(10 g) = 0.117 W/kg**

Maximum value of SAR (measured) = 0.200 W/kg

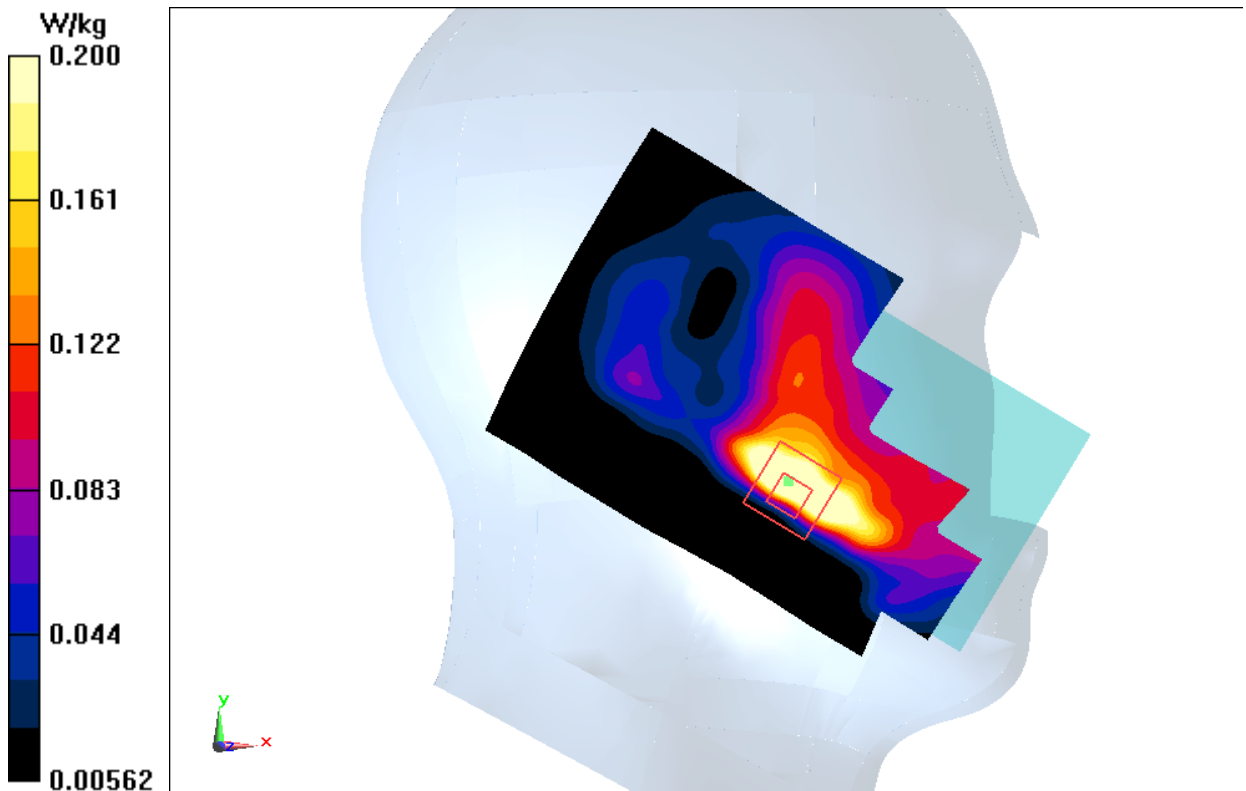

Fig.3 1900 MHz

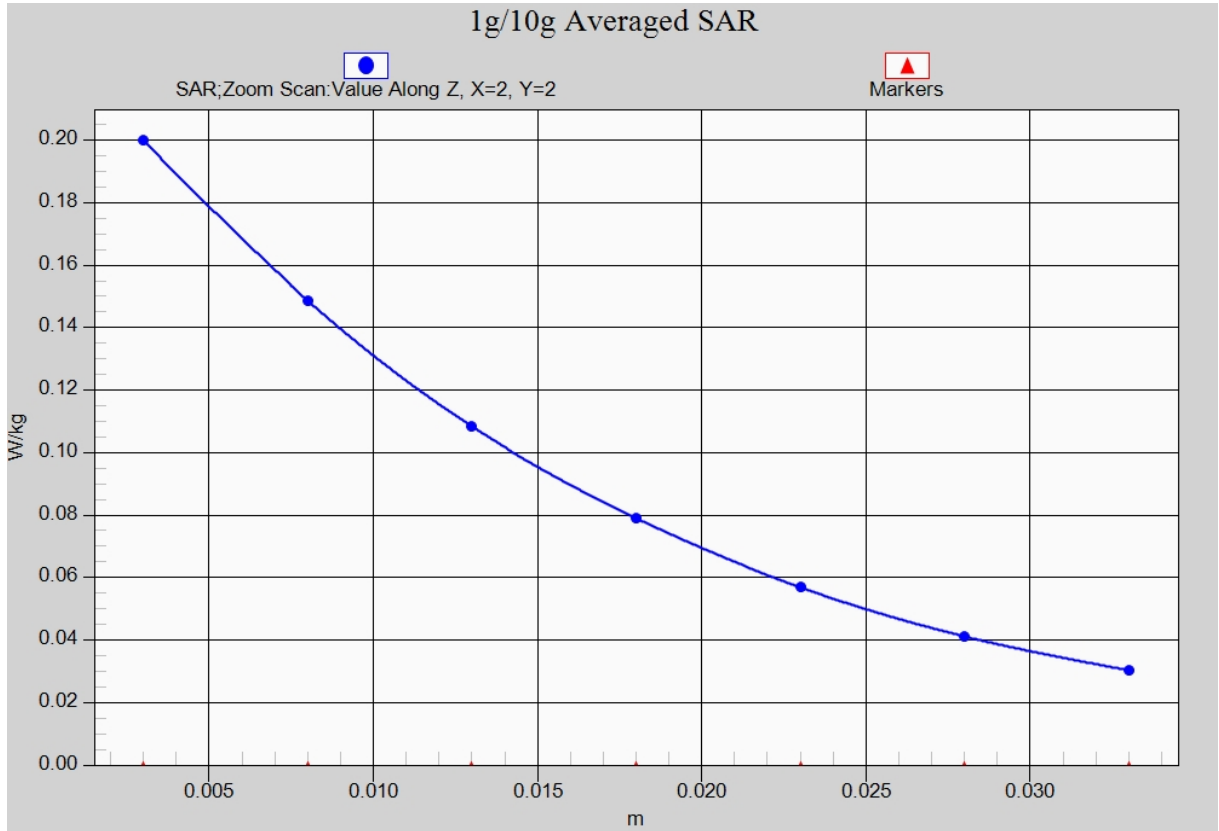

Fig. 3-1Z-Scan at power reference point (1900 MHz)

### 1900 Body FrontMiddle

Date: 2017-8-9

Electronics: DAE4 Sn1331

Medium: Body 1900 MHz

Medium parameters used:  $f = 1880$  MHz;  $\sigma = 1.545$  mho/m;  $\epsilon_r = 52.73$ ;  $\rho = 1000$  kg/m<sup>3</sup>

Ambient Temperature: 22.9°C      Liquid Temperature: 22.5°C

Communication System: GSM 1900MHz GPRS Frequency: 1880 MHz Duty Cycle: 1:2

Probe: EX3DV4-SN3846 ConvF(7.57, 7.57, 7.57)

**Area Scan (131x81x1):** Interpolated grid: dx=1.000 mm, dy=1.000 mm

Maximum value of SAR (interpolated) = 1.22 W/kg

**Zoom Scan (7x7x7)/Cube 0:** Measurement grid: dx=5mm, dy=5mm, dz=5mm

Reference Value = 12.75 V/m; Power Drift = -0.09 dB

Peak SAR (extrapolated) = 1.53 W/kg

**SAR(1 g) = 0.936 W/kg; SAR(10 g) = 0.544 W/kg**

Maximum value of SAR (measured) = 1.02 W/kg

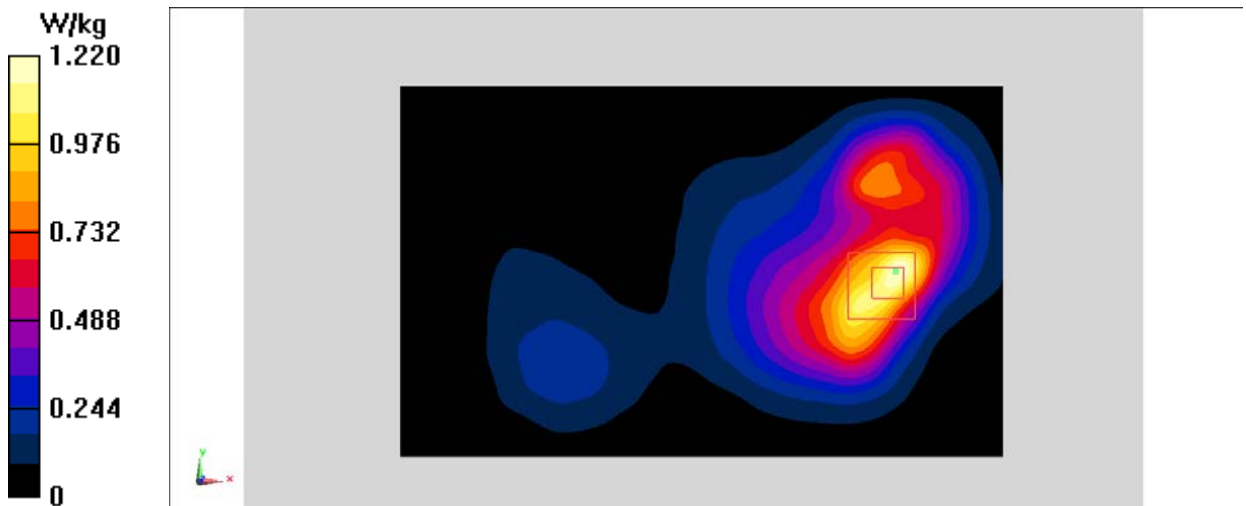

Fig.4 1900 MHz

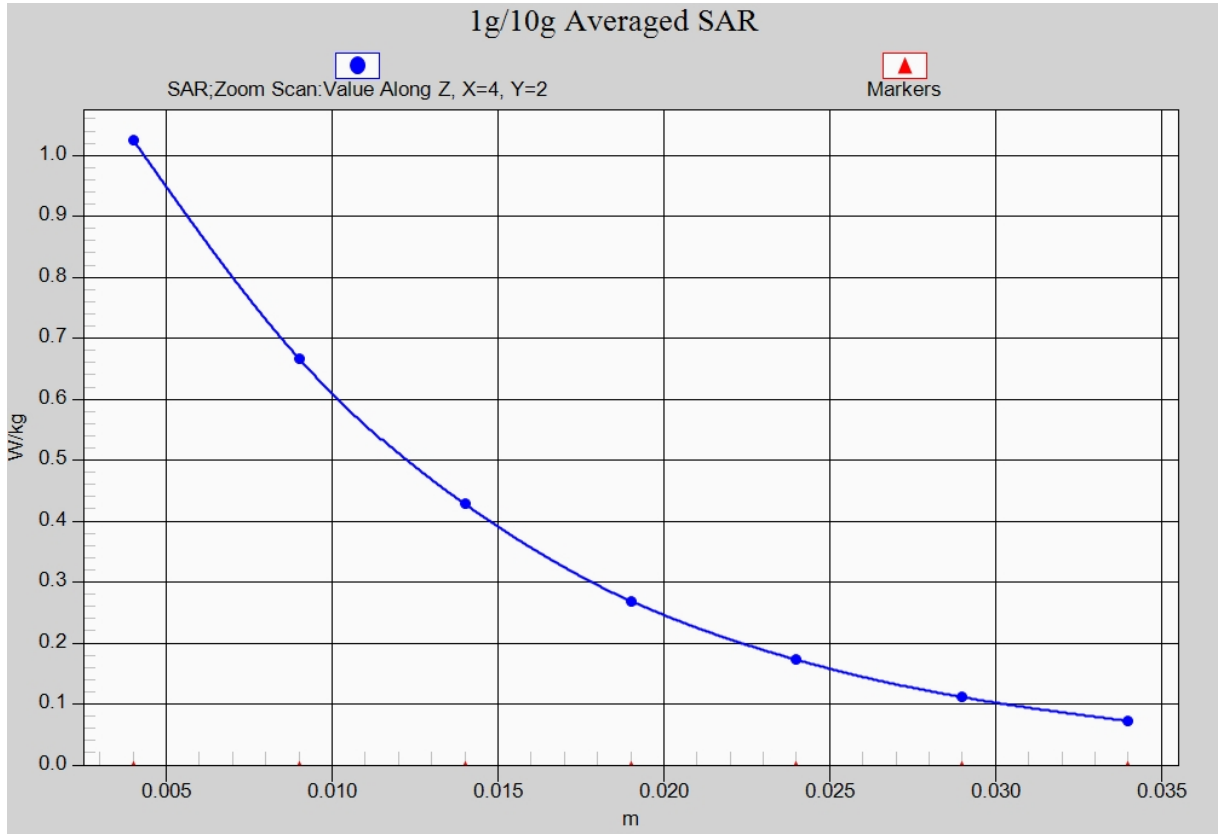

Fig. 4-1Z-Scan at power reference point (1900 MHz)

### WCDMA 850 Right Cheek High

Date: 2017-8-8

Electronics: DAE4 Sn1331

Medium: Head 850 MHz

Medium parameters used (interpolated):  $f = 846.6$  MHz;  $\sigma = 0.909$  mho/m;  $\epsilon_r = 41.725$ ;  $\rho = 1000$  kg/m<sup>3</sup>

Ambient Temperature: 22.9°C      Liquid Temperature: 22.5°C

Communication System: WCDMA; Frequency: 846.6 MHz; Duty Cycle: 1:1

Probe: EX3DV4 –SN3846ConvF(9.33, 9.33, 9.33)

**Area Scan (81x131x1):** Interpolated grid: dx=1.000 mm, dy=1.000 mm

Maximum value of SAR (interpolated) = 0.378 W/kg

**Zoom Scan (7x7x7)/Cube 0:** Measurement grid: dx=5mm, dy=5mm, dz=5mm

Reference Value = 6.155 V/m; Power Drift = -0.08 dB

Peak SAR (extrapolated) = 0.430 W/kg

**SAR(1 g) = 0.329 W/kg; SAR(10 g) = 0.250 W/kg**

Maximum value of SAR (measured) = 0.362 W/kg

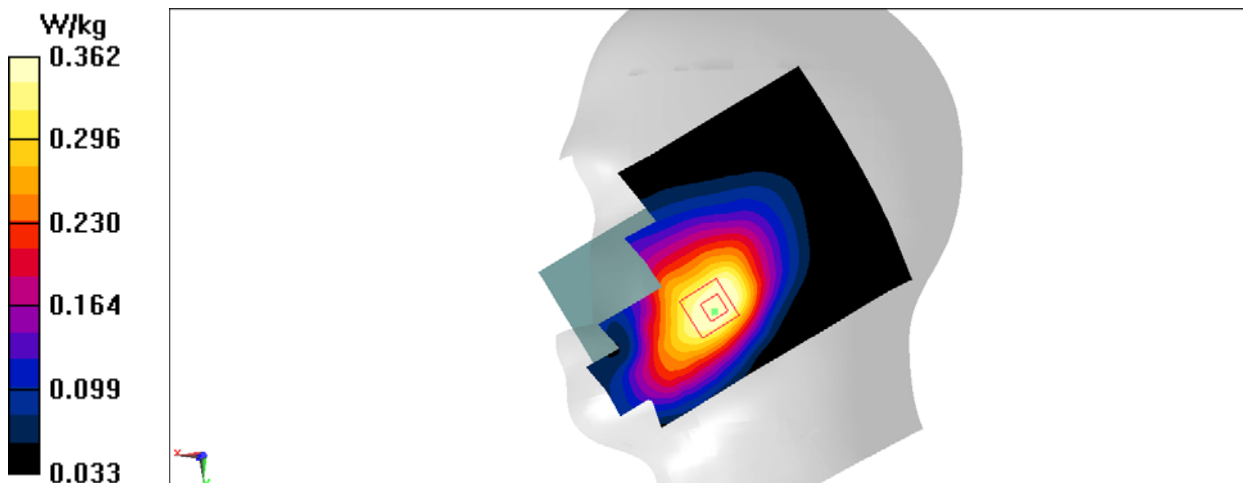

Fig.5 WCDMA 850

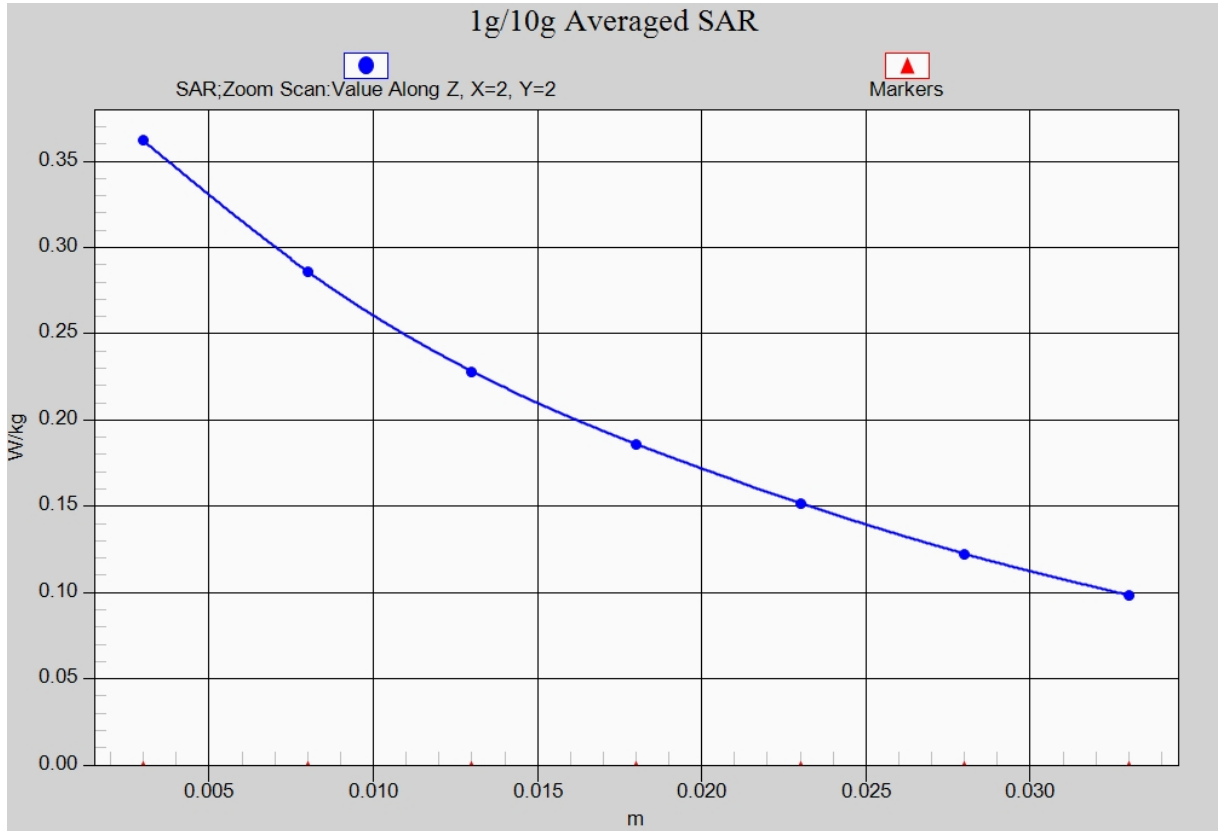

Fig. 5-1Z-Scan at power reference point (850 MHz)



### WCDMA 850Body RearHigh

Date: 2017-8-8

Electronics: DAE4 Sn1331

Medium: Body 850 MHz

Medium parameters used (interpolated):  $f = 846.6$  MHz;  $\sigma = 0.981$  mho/m;  $\epsilon_r = 55.876$ ;  $\rho = 1000$  kg/m<sup>3</sup>

Ambient Temperature: 22.9°C      Liquid Temperature: 22.5°C

Communication System: WCDMA; Frequency: 846.6 MHz; Duty Cycle: 1:1

Probe: EX3DV4 –SN3846ConvF(9.52, 9.52, 9.52)

**Area Scan (131x81x1):** Interpolated grid: dx=1.000 mm, dy=1.000 mm

Maximum value of SAR (interpolated) = 0.903 W/kg

**Zoom Scan (7x7x7)/Cube 0:** Measurement grid: dx=5mm, dy=5mm, dz=5mm

Reference Value = 18.82 V/m; Power Drift = -0.06 dB

Peak SAR (extrapolated) = 1.05 W/kg

**SAR(1 g) = 0.758 W/kg; SAR(10 g) = 0.529 W/kg**

Maximum value of SAR (measured) = 0.811 W/kg

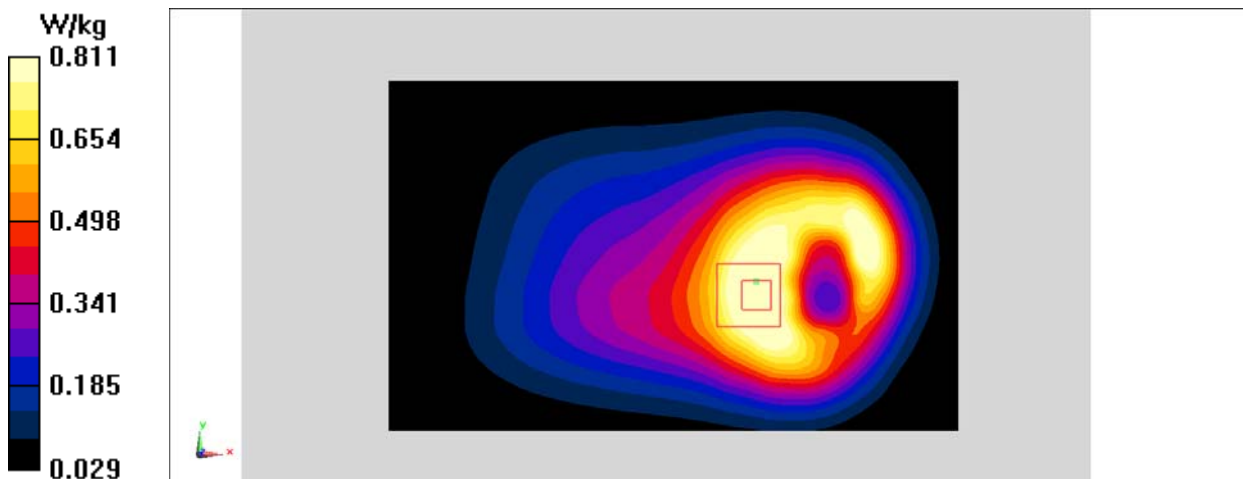

Fig.6 WCDMA 850

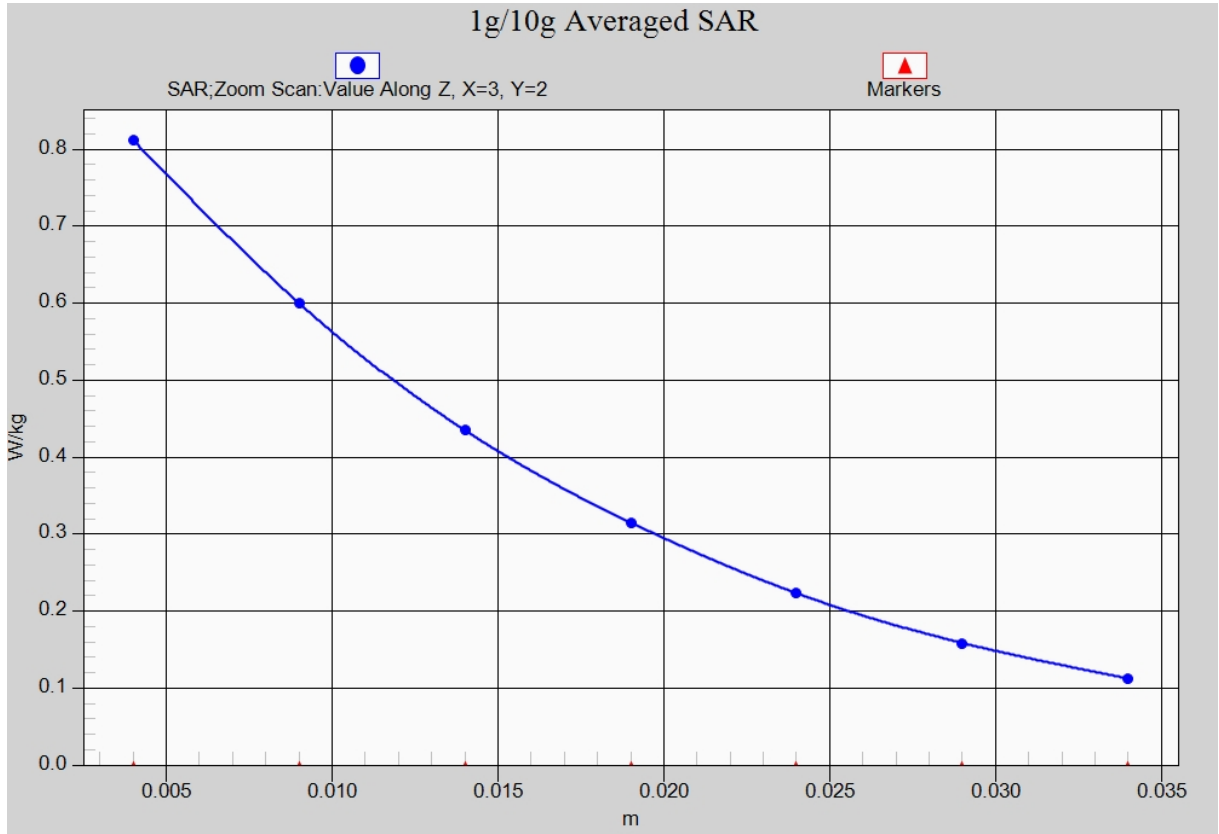

Fig. 6-1 Z-Scan at power reference point (WCDMA850)

### WCDMA 1700Left Cheek Low

Date: 2017-8-13

Electronics: DAE4 Sn1331

Medium: Head 1750 MHz

Medium parameters used (interpolated):  $f = 1712.4$  MHz;  $\sigma = 1.307$  mho/m;  $\epsilon_r = 40.677$ ;  $\rho = 1000$  kg/m<sup>3</sup>

Ambient Temperature: 22.9°C      Liquid Temperature: 22.5°C

Communication System: WCDMA 1750 Frequency: 1712.4 MHz Duty Cycle: 1:1

Probe: EX3DV4– SN3846 ConvF(8.16, 8.16, 8.16)

**Area Scan (71x121x1):** Interpolated grid: dx=1.000 mm, dy=1.000 mm

Maximum value of SAR (interpolated) = 0.263 W/kg

**Zoom Scan (7x7x7)/Cube 0:** Measurement grid: dx=4mm, dy=4mm, dz=5mm

Reference Value = 5.815 V/m; Power Drift = 0.17 dB

Peak SAR (extrapolated) = 0.317 W/kg

**SAR(1 g) = 0.237 W/kg; SAR(10 g) = 0.164 W/kg**

Maximum value of SAR (measured) = 0.268 W/kg

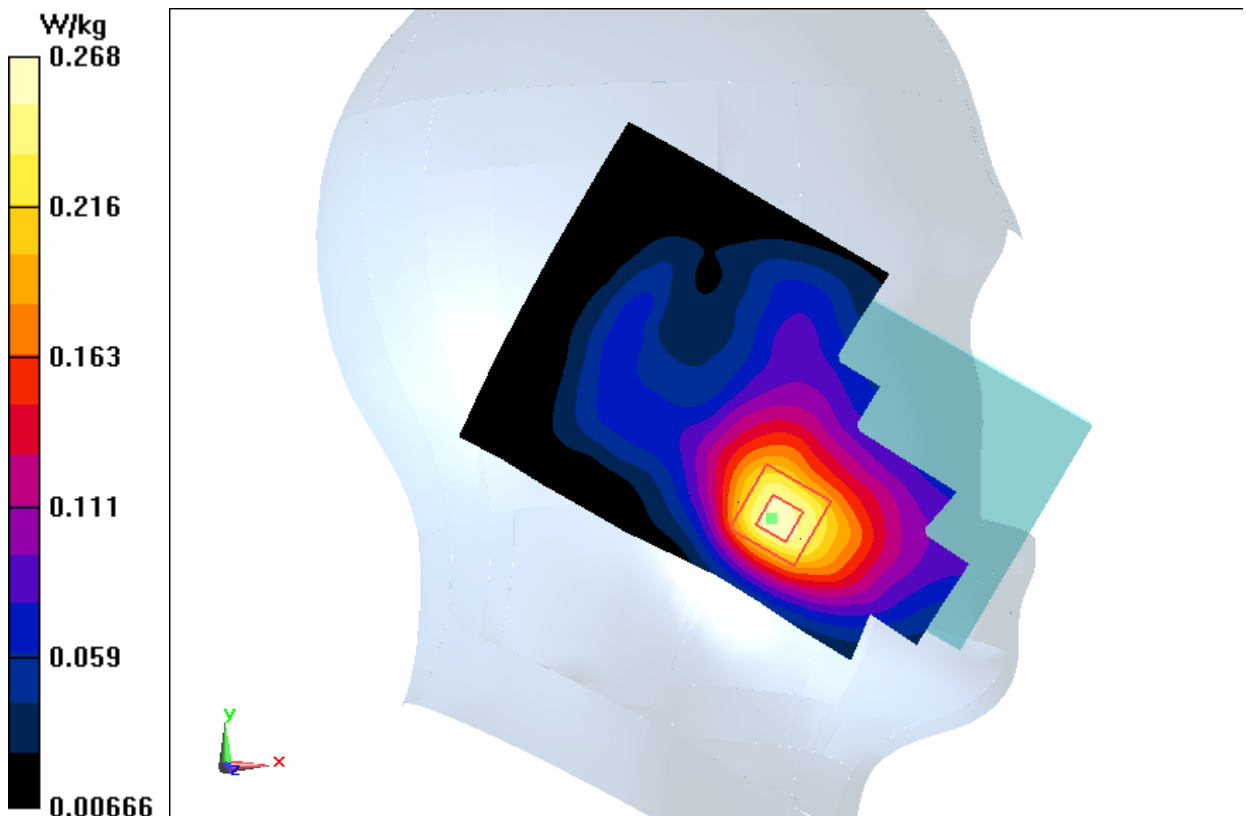
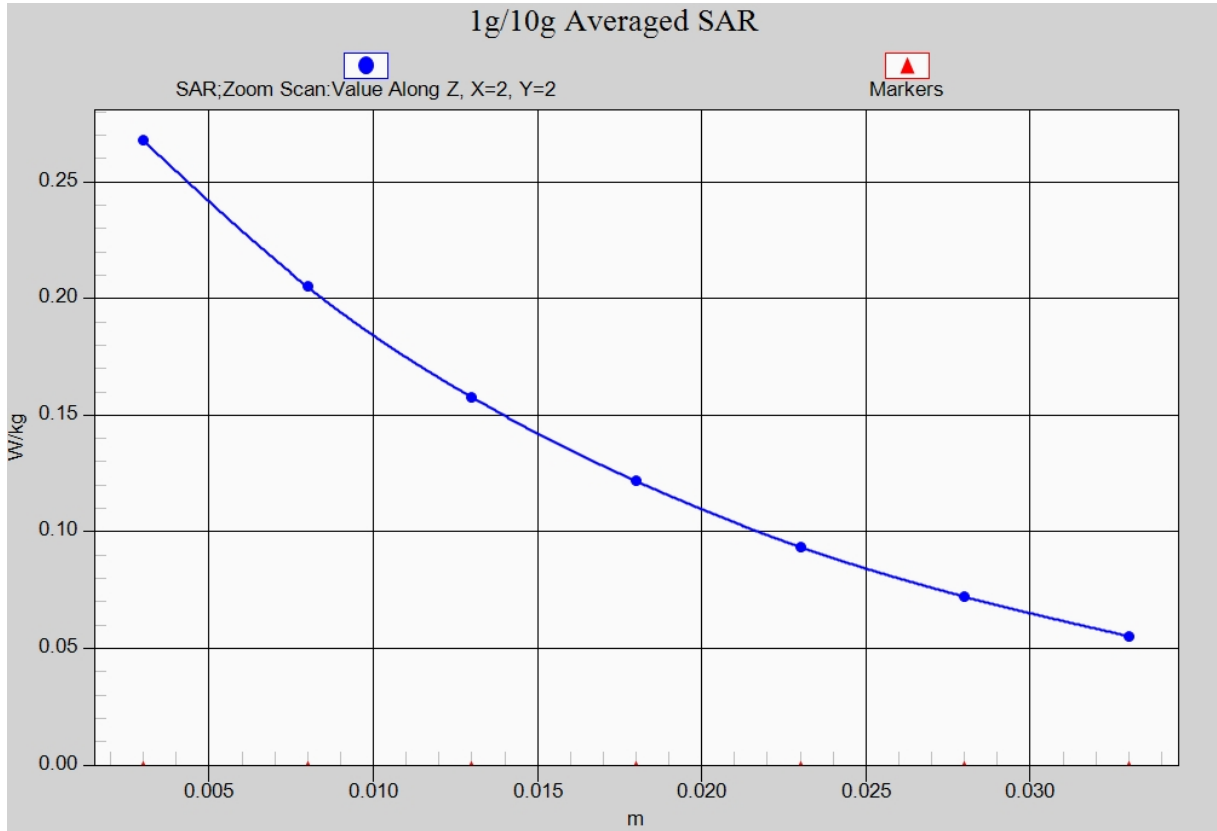

Fig.7WCDMA1700



**Fig. 7-1 Z-Scan at power reference point (WCDMA1700)**

### WCDMA 1700 Body FrontHigh – 10mm

Date: 2017-8-13

Electronics: DAE4 Sn1331

Medium: Body 1750 MHz

Medium parameters used (interpolated):  $f = 1752.6$  MHz;  $\sigma = 1.509$  mho/m;  $\epsilon_r = 53.718$ ;  $\rho = 1000$  kg/m<sup>3</sup>

Ambient Temperature: 22.9°C      Liquid Temperature: 22.5°C

Communication System: WCDMA 1900 Frequency: 1752.6 MHz Duty Cycle: 1:1

Probe: EX3DV4– SN3846 ConvF(7.90, 7.90, 7.90)

**Area Scan (131x81x1):** Interpolated grid: dx=1.000 mm, dy=1.000 mm

Maximum value of SAR (interpolated) = 1.25 W/kg

**Zoom Scan (7x7x7)/Cube 0:** Measurement grid: dx=5mm, dy=5mm, dz=5mm

Reference Value = 9.901 V/m; Power Drift = -0.10 dB

Peak SAR (extrapolated) = 1.54 W/kg

**SAR(1 g) = 0.960 W/kg; SAR(10 g) = 0.562 W/kg**

Maximum value of SAR (measured) = 1.06 W/kg

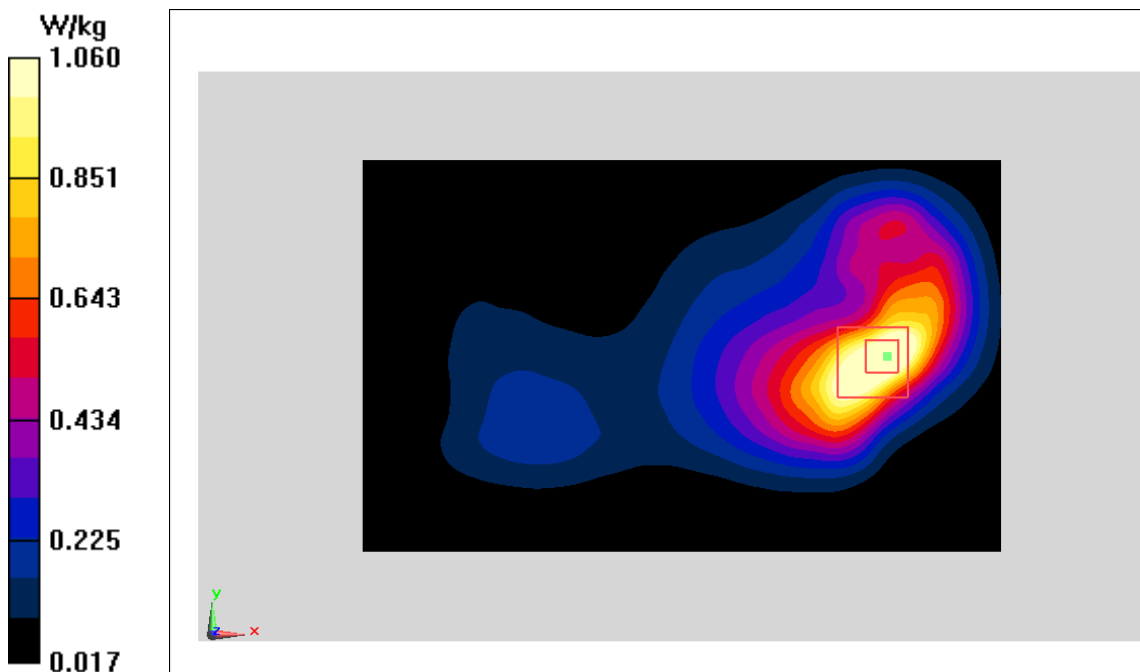

Fig.8WCDMA1700

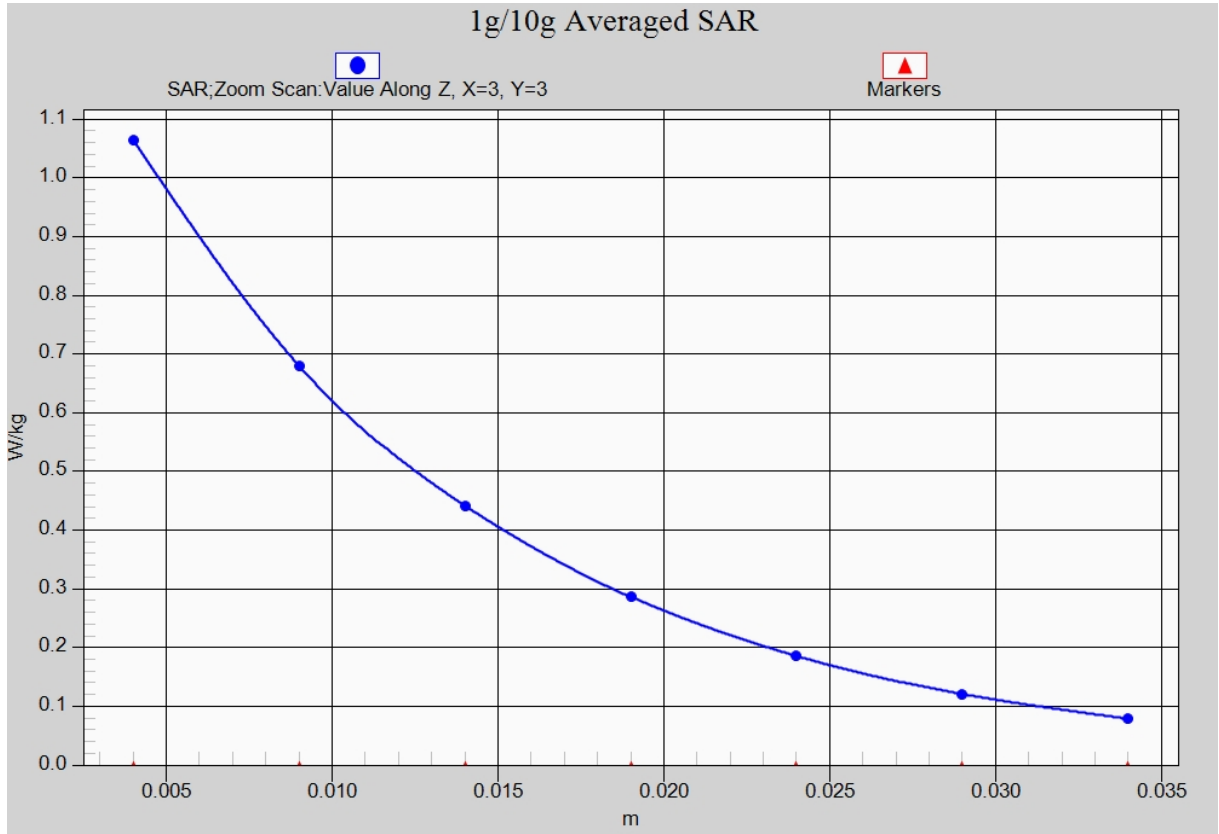

Fig. 8-1 Z-Scan at power reference point (WCDMA1700)

### WCDMA 1700 Body Front Low – 15mm

Date: 2017-8-13

Electronics: DAE4 Sn1331

Medium: Body 1750 MHz

Medium parameters used (interpolated):  $f = 1712.4$  MHz;  $\sigma = 1.481$  mho/m;  $\epsilon_r = 53.828$ ;  $\rho = 1000$  kg/m<sup>3</sup>

Ambient Temperature: 22.9°C      Liquid Temperature: 22.5°C

Communication System: WCDMA 1900 Frequency: 1712.4 MHz Duty Cycle: 1:1

Probe: EX3DV4– SN3846 ConvF(7.90, 7.90, 7.90)

**Area Scan (131x81x1):** Interpolated grid: dx=1.000 mm, dy=1.000 mm

Maximum value of SAR (interpolated) = 0.991 W/kg

**Zoom Scan (7x7x7)/Cube 0:** Measurement grid: dx=5mm, dy=5mm, dz=5mm

Reference Value = 9.206 V/m; Power Drift = -0.17 dB

Peak SAR (extrapolated) = 1.18 W/kg

**SAR(1 g) = 0.759 W/kg; SAR(10 g) = 0.468 W/kg**

Maximum value of SAR (measured) = 0.831 W/kg

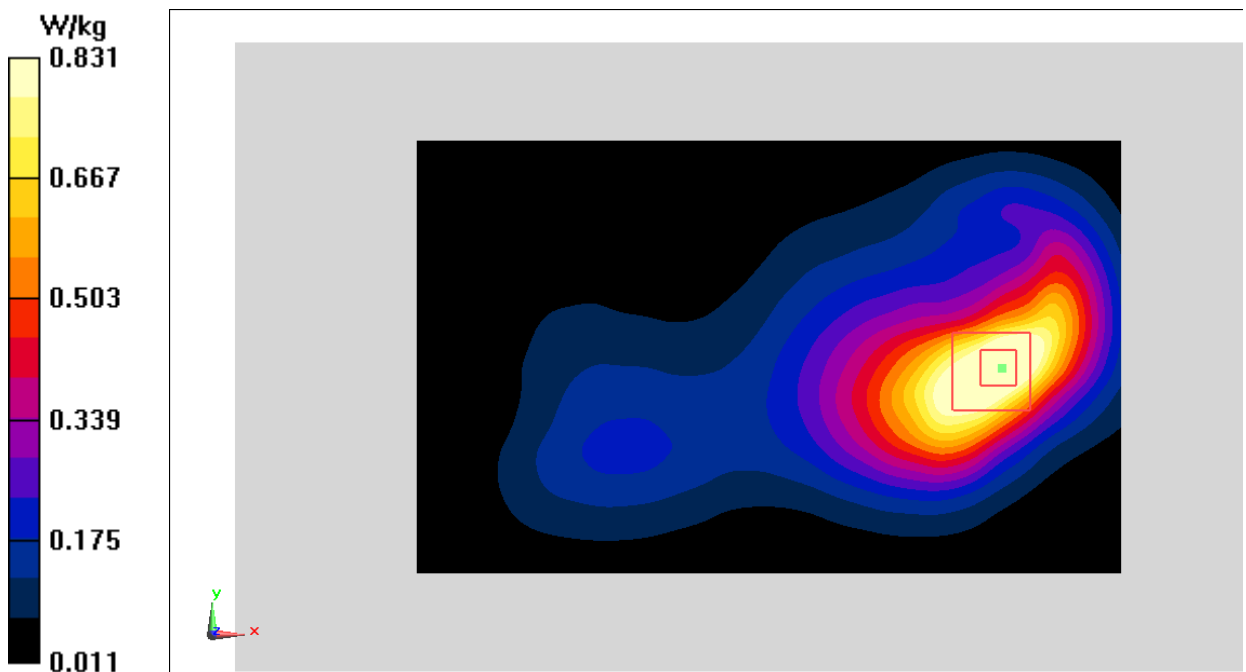

Fig.9WCDMA1700

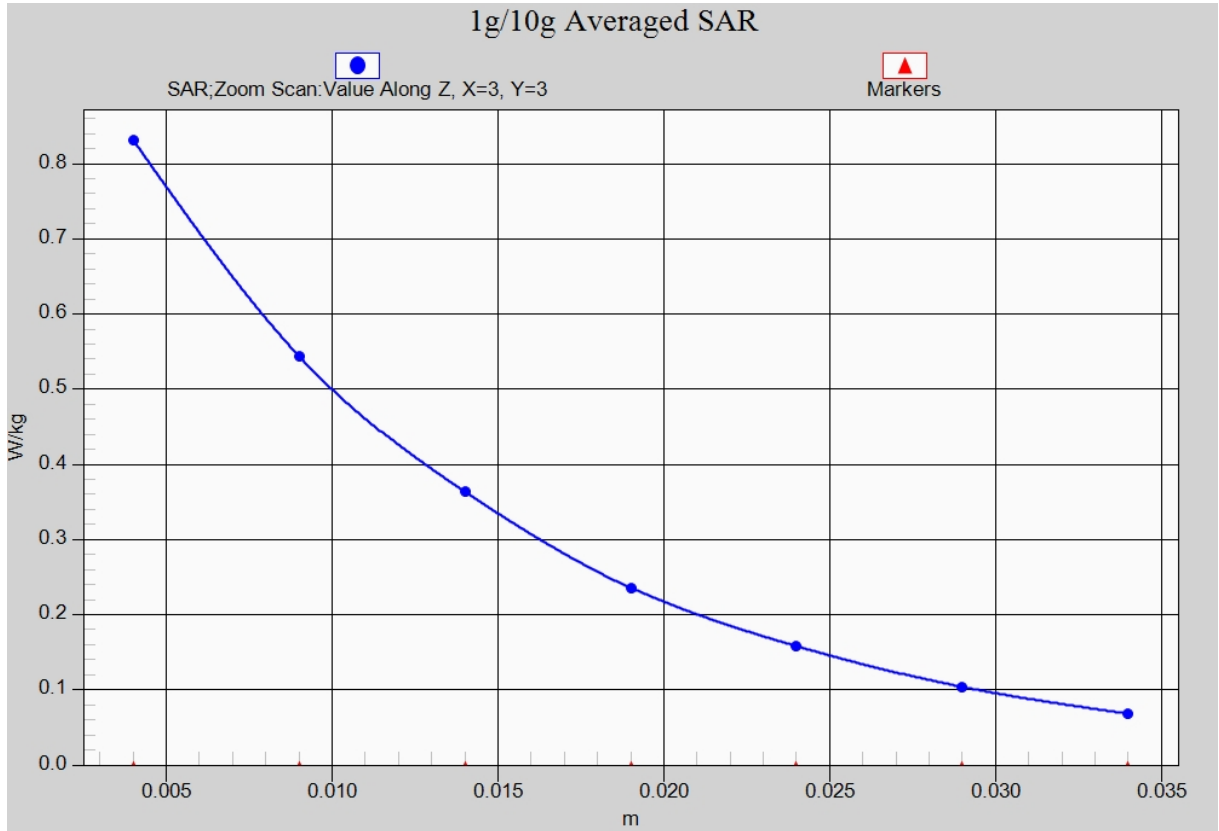

Fig. 9-1 Z-Scan at power reference point (WCDMA1700)



### WCDMA 1900 Left Cheek High

Date: 2017-8-9

Electronics: DAE4 Sn1331

Medium: Head 1900 MHz

Medium parameters used (interpolated):  $f = 1907.6$  MHz;  $\sigma = 1.465$  mho/m;  $\epsilon_r = 40.806$ ;  $\rho = 1000$  kg/m<sup>3</sup>

Ambient Temperature: 22.9°C      Liquid Temperature: 22.5°C

Communication System: WCDMA 1900 Frequency: 1907.6 MHz Duty Cycle: 1:1

Probe: EX3DV4-SN3846 ConvF(7.89, 7.89, 7.89)

**Area Scan (71x121x1):** Interpolated grid: dx=1.000 mm, dy=1.000 mm

Maximum value of SAR (interpolated) = 0.183 W/kg

**Zoom Scan (7x7x7)/Cube 0:** Measurement grid: dx=5mm, dy=5mm, dz=5mm

Reference Value = 4.674 V/m; Power Drift = 0.18 dB

Peak SAR (extrapolated) = 0.194 W/kg

**SAR(1 g) = 0.138 W/kg; SAR(10 g) = 0.095 W/kg**

Maximum value of SAR (measured) = 0.157 W/kg

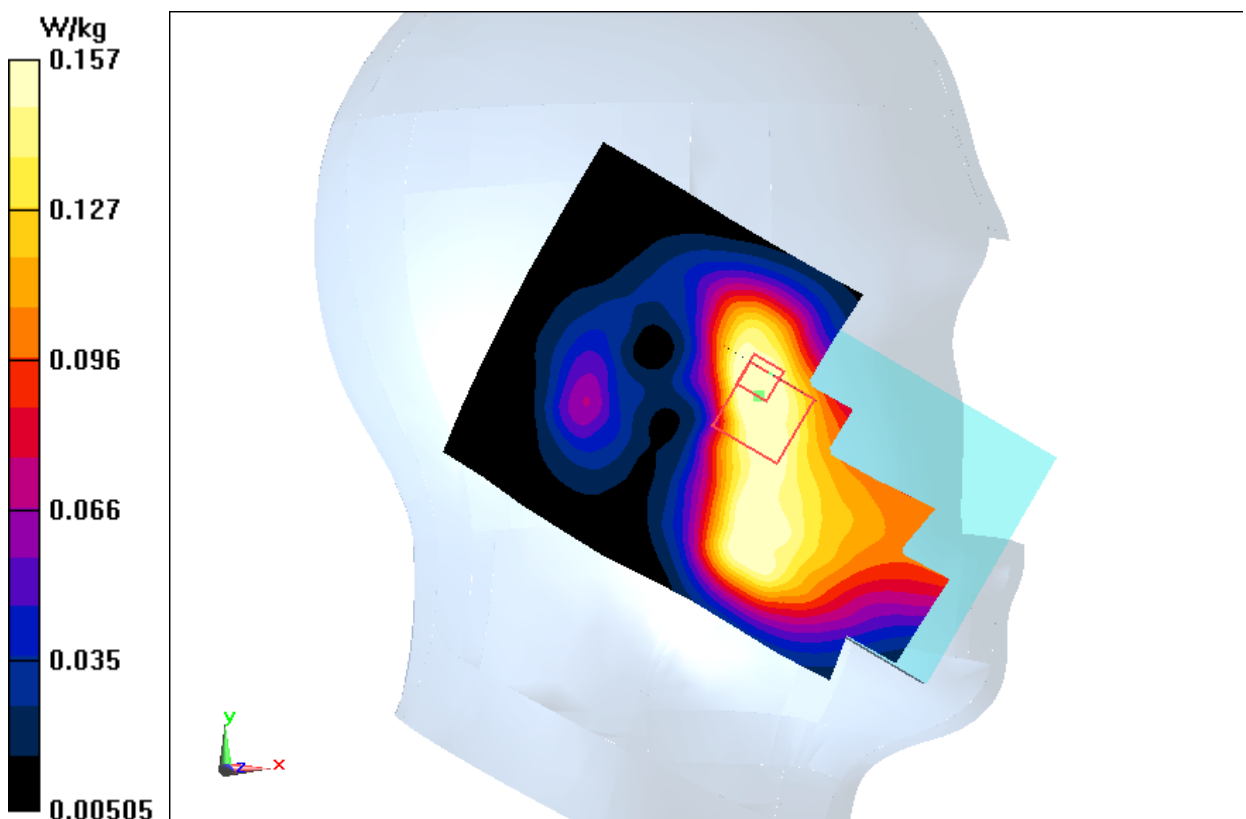

Fig.10WCDMA1900