



**FCC PART 15
TEST REPORT
No.I17Z61036-IOT08**

for

TCL Communication Ltd.

GSM Quad-band/HSPA-UMTS Six-band/LTE 19-band mobile phone

BBD100-1

With

FCC ID: 2ACCJN019

Hardware Version: 04

Software Version: AAN966

Issued Date: 2017-09-04



Note:

The test results in this test report relate only to the devices specified in this report. This report shall not be reproduced except in full without the written approval of CTTL.

The report must not be used by the client to claim product certification, approval, or endorsement by NVLAP, NIST, or any agency of the U.S. Government.

Test Laboratory:

CTTL, Telecommunication Technology Labs, CAICT

No. 52, Huayuan North Road, Haidian District, Beijing, P. R. China 100191.

Tel:+86(0)10-62304633-2512, Fax:+86(0)10-62304633-2504

Email: ctl_terminals@caict.ac.cn, website: www.caict.ac.cn



REPORT HISTORY

Report Number	Revision	Description	Issue Date
.I17Z61036-IOT08	Rev.0	1st edition	2017-09-04



CONTENTS

CONTENTS	3
1. TEST LATORATORY	4
1.1. TESTING LOCATION	4
1.2. TESTING ENVIRONMENT	4
1.3. PROJECT DATA	4
1.4. SIGNATURE	4
2. CLIENT INFORMATION	5
2.1. APPLICANT INFORMATION	5
2.2. MANUFACTURER INFORMATION	错误!未定义书签。
3. EQUIPMENT UNDER TEST (EUT) AND ANCILLARY EQUIPMENT(AE)	6
3.1. ABOUT EUT	6
3.2. INTERNAL IDENTIFICATION OF EUT USED DURING THE TEST	6
3.3. GENERAL DESCRIPTION	6
4. REFERENCE DOCUMENTS	7
4.1. DOCUMENTS SUPPLIED BY APPLICANT	7
4.2. REFERENCE DOCUMENTS FOR TESTING	7
5. LABORATORY ENVIRONMENT	7
6. SUMMARY OF TEST RESULTS	7
6.1. SUMMARY OF TEST RESULTS	7
6.2. STATEMENTS	7
7. TEST EQUIPMENTS UTILIZED	8
ANNEX A: MEASUREMENT RESULTS	9
A.1. MEASUREMENT METHOD	9
A.2. CHANNEL MOVE TIME AND CHANNEL CLOSING TRANSMISSION TIME	11
ANNEX B: PHOTOGRAPHS OF THE TEST SET-UP	16
ANNEX C: ACCREDITATION CERTIFICATE	17

1. TEST LATORATORY

1.1. Testing Location

Location 1:CTTL(huayuan North Road)

Address: No. 52, Huayuan North Road, Haidian District, Beijing,
P. R. China100191

Location 2:CTTL(Shouxiang)

Address: No. 51 Shouxiang Science Building, Xueyuan Road,
Haidian District, Beijing, P. R. China100191

1.2. Testing Environment

Normal Temperature: 15-35℃
Extreme Temperature: -10/+55℃
Relative Humidity: 20-75%

1.3. Project data

Testing Start Date: 2017-06-29
Testing End Date: 2017-08-24

1.4. Signature



Jiang Xue

(Prepared this test report)

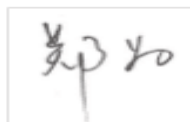

Zheng Wei

(Reviewed this test report)

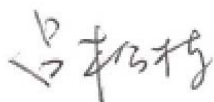

Lv Songdong

(Approved this test report)



2. CLIENT INFORMATION

2.1. Applicant Information

Company Name: TCL Communication Ltd.
Address: 5F, C building, No. 232, Liang Jing Road ZhangJiang High-Tech Park,
Pudong Area Shanghai, P.R. China. 201203
City: Shanghai
Postal Code: 201203
Country: China
Telephone: 0086-21-31363544
Fax: 0086-21-61460602

2.2. Manufacturer Information

Company Name: TCL Communication Ltd.
Address: 5F, C building, No. 232, Liang Jing Road ZhangJiang High-Tech Park,
Pudong Area Shanghai, P.R. China. 201203
City: Shanghai
Postal Code: 201203
Country: China
Telephone: 0086-21-31363544
Fax: 0086-21-61460602



3. EQUIPMENT UNDER TEST (EUT) AND ANCILLARY

EQUIPMENT(AE)

3.1. About EUT

Description	GSM Quad-band/HSPA-UMTS Six-band/LTE 19-band mobile phone
Model name	BBD100-1
FCC ID	2ACCJN019
WLAN Frequency Range	ISM Band: -5250MHz~5350MHz -5470MHz~5725MHz
Type of modulation	OFDM
Antenna	Integral Antenna
Extreme vol. Limits	3.8V DC by Battery
Device Type (DFS)	Client without radar detection(only support client mode)
TPC mechanism	Not support

3.2. Internal Identification of EUT used during the test

EUT ID*	S/N	HW Version	SW Version
EUT1	/	04	AAN966

*EUT ID: is used to identify the test sample in the lab internally.

3.3. General Description

The Equipment Under Test (EUT) is a model of GSM Quad-band/HSPA-UMTS Six-band/LTE 19-band mobile phone with integrated antenna. It consists of normal options: lithium battery, charger. Manual and specifications of the EUT were provided to fulfil the test.



4. REFERENCE DOCUMENTS

4.1. Documents supplied by applicant

EUT feature information is supplied by the applicant or manufacturer, which is the basis of testing.

4.2. Reference Documents for testing

The following documents listed in this section are referred for testing.

	FCC CFR 47, Part 15, Subpart C:	
	15.205 Restricted bands of operation;	
FCC Part15	15.209 Radiated emission limits, general requirements;	2016
	15.247 Operation within the bands 902–928MHz, 2400–2483.5 MHz, and 5725–5850 MHz.	
FCC 06-96	Revision of Parts 2 and 15 of the Commission’s Rules to Permit Unlicensed National Information Infrastructure (U-NII) devices in the 5 GHz band	2006

5. LABORATORY ENVIRONMENT

Measurement is performed in shielding room.

6. SUMMARY OF TEST RESULTS

6.1. Summary of Test Results

SUMMARY OF MEASUREMENT RESULTS	Sub-clause of Part15E	Verdict
Channel move time and channel closing transmission time	15.407 (h)(2)(iii)	P
Non-Occupancy Period	15.407 (h)(2) (iv)	P

Please refer to **ANNEX A** for detail.

Terms used in Verdict column

P	Pass, The EUT complies with the essential requirements in the standard.
NM	Not measured, The test was not measured by CTTL
NA	Not Applicable, The test was not applicable
F	Fail, The EUT does not comply with the essential requirements in the standard

6.2. Statements

CTTL has evaluated the test cases requested by the client/manufacturer as listed in section 6.1 of this report for the EUT specified in section 3 according to the standards or reference documents listed in section 4.1.

This report only deal with the UNII DFS functions among the features described in section 3, and The EUT met all requirements of the reference documents.

The end user is not available to get and modify the parameters of the detected Radar Waveforms in this product.

This model is a variant product which market name is BBD100-2; and all the test results have been tested from BBD100-2.



Test Conditions

T nom	Normal Temperature
T min	Low Temperature
T max	High Temperature
V nom	Normal Voltage
V min	Low Voltage
V max	High Voltage
H nom	Norm Humidity
A nom	Norm Air Pressure

For this report, all the test case listed above is tested under Normal Temperature and Normal Voltage, and also under norm humidity, the specific conditions as following:

Temperature	T nom	26°C
Voltage	V nom	3.8V(By battery)
Humidity	H nom	44%
Air Pressure	A nom	1010hPa

7. TEST EQUIPMENTS UTILIZED

Conducted test system

No.	Equipment	Model	Serial Number	Manufacturer	Calibration Date	Calibration Due Date
1	Vector Signal Analyzer	FSQ40	200089	Rohde & Schwarz	2017-06-02	2018-06-01
2	Vector Signal General	SMU200A	103752	Rohde & Schwarz	2017-06-02	2018-06-01
3	Shielding Room	S81	/	ETS-Lindgren	/	/

ANNEX A: MEASUREMENT RESULTS

A.1. Measurement Method

A.1.1. Conducted Measurements

The below figure shows the DFS setup, where the EUT is a RLAN device operating in slave mode, without Radar Interference Detection function. This setup also contains a device operating in master mode. The radar test signals are injected into the master device. The EUT (slave device) is associated with the master device. WLAN traffic is generated by streaming the mpeg file from the master to the slave in full monitor video mode using the media player.

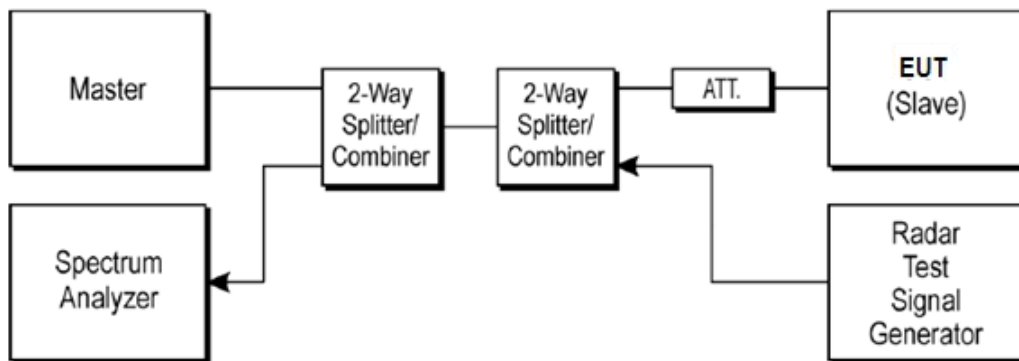

Note:

- 1) All Measurements are performed with the EUT's narrowest channel bandwidth.
- 2) The master device information is as follows
Vendor: Cisco
Model: AIR-AP1252AG-A-K9
FCC ID: LDK102061, 1DK102062
- 3) The software of radar signal generator (R&S SMU200A) is completely designed based on FCC-06-96A1/NTIA requirement.

A.1.2. Parameters of DFS test signal

1). Interference threshold values, master or client incorporation in service monitoring. For device power less than 23dBm (E.I.R.P.), the threshold level is -62 dBm at the antenna port after correction for antenna gain and procedural adjustments.

Because of conducted measurement performed, the calibration power from radar signal generator to antenna port of DFS test equipment is -62 dBm.

Maximum Transmit Power	Value
> 200 mW	-64 dBm
< 200 mW	-62 dBm

2). DFS requirement values

The required values are as the following table.

Parameter	Value
Non-occupancy	> 1800 s
Channel Availability Check Time	60 s
Channel Move Time	10 s
Channel Closing Transmission Time	200 ms + 60 ms
U-NII Detection Bandwidth	Minimum 80% of the 99% transmission power bandwidth

As the EUT is IP based system, the MPEG video file from NTIA website is used to steam to EUT via the Master device.

A.1.3. Measurement Uncertainty

Item	Measurement Uncertainty
Time	0.70 ms
Power	0.75 dBm

A.2. Channel move time and channel closing transmission time

Measurement Limit:

Test Items	Limit
channel closing transmission time	< 200 ms + 60 ms
Channel move time	< 10 s

Measurement Results:

Frequency Band: 5250MHz ~ 5350MHz

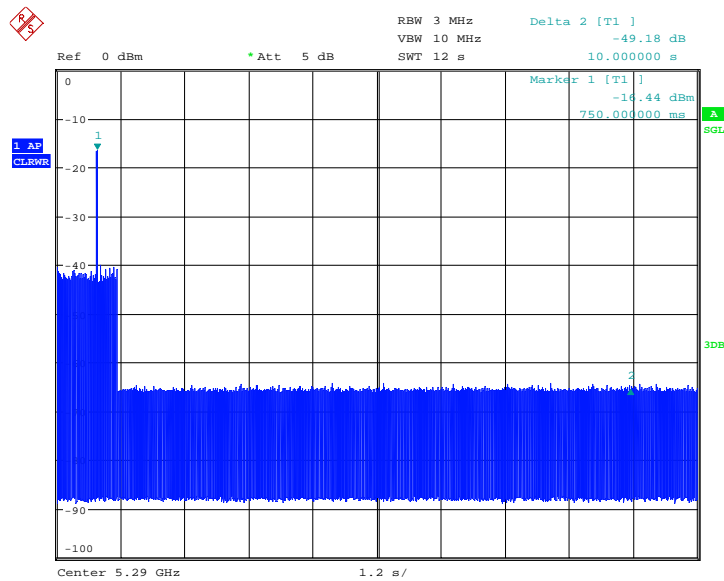

Date: 1.JAN.2003 07:10:45

The channel move time is as the figure. It shows the time of the radar and the client pulses. The figure shows that the client stops transmission within 10 seconds, and no transmissions occur after 10 seconds later of the radar burst signal.

Frequency Band: 5250MHz ~ 5350MHz

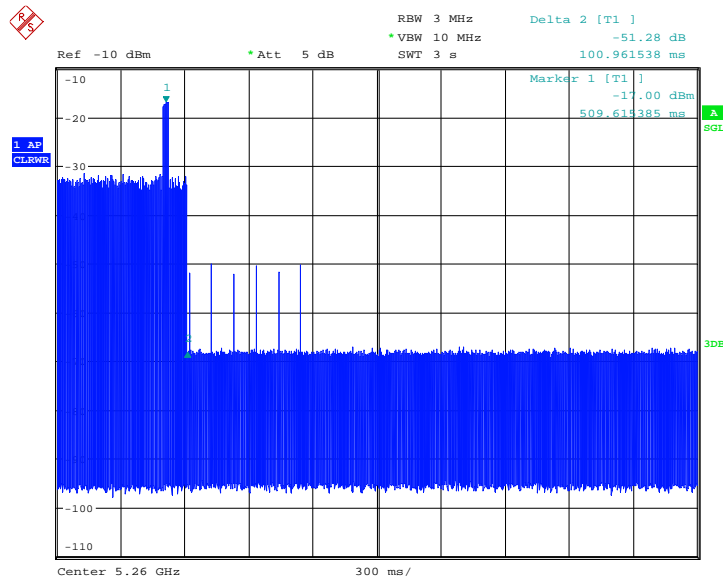

Date: 1.JAN.2003 07:14:01

The closing transmission time is as the figure, and the result is 100.96ms.

Conclusion: PASS

Frequency Band 5470MHz ~ 5725MHz

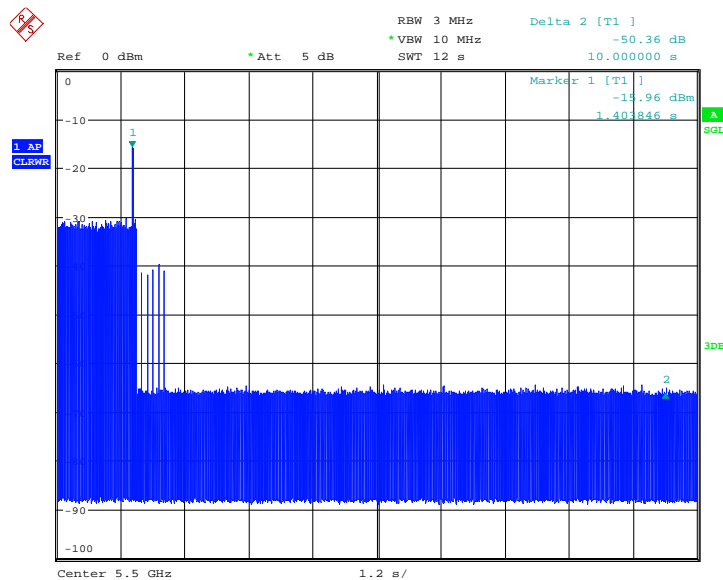

Date: 4.JAN.2003 07:15:15

The channel move time is as the figure. It shows the time of the radar and the client pulses. The figure shows that the client stops transmission within 10 seconds, and no transmissions occur after 10 seconds later of the radar burst signal.



Frequency Band 5470MHz ~ 5725MHz

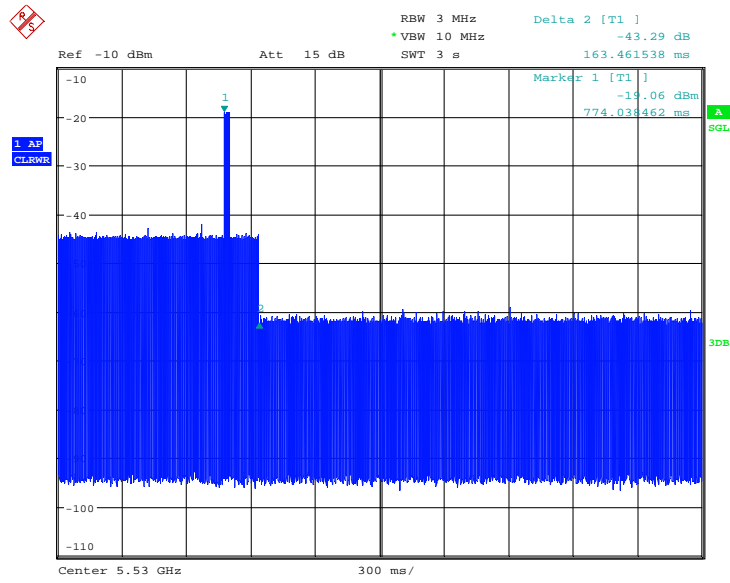

Date: 28.AUG.2017 14:42:59

The closing transmission time is as the figure, and the result is 163.46ms

Conclusion: PASS

A.3.Non-Occupancy Period

Measurement Limit:

Test Items	Limit
Non-Occupancy Period	> 1800 s

A3.1 Associated test

Associate the master and client, transmit specified stream between the master and client; monitor the analyzer on the operating frequency to make sure no beacons have been transmitted for 1800 seconds.

Frequency Band: 5150MHz ~ 5350MHz

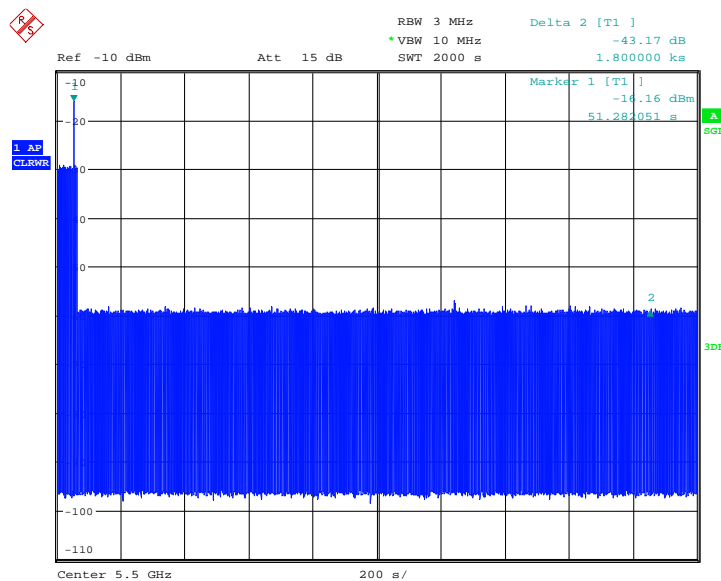

Date: 1.JAN.2003 08:45:40

The figure above shows that the client does not transmit any emission within 1800 seconds after getting the order of “stop transmits” from the DFS master (access point).



Frequency Band: 5470MHz ~ 5725MHz

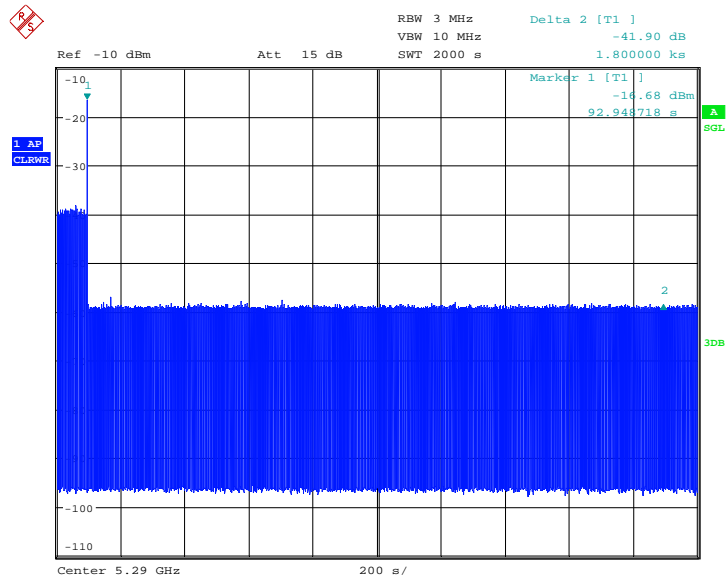

Date: 2.JAN.2003 01:30:48

The figure above shows that the client does not transmit any emission within 1800 seconds after getting the order of "stop transmits" from the DFS master (access point).

Conclusion: PASS

ANNEX B: PHOTOGRAPHS OF THE TEST SET-UP

Layout of Conducted Test



ANNEX C: Accreditation Certificate

United States Department of Commerce
National Institute of Standards and Technology



Certificate of Accreditation to ISO/IEC 17025:2005

NVLAP LAB CODE: 600118-0

Telecommunication Technology Labs, CAICT

Beijing
China

*is accredited by the National Voluntary Laboratory Accreditation Program for specific services,
listed on the Scope of Accreditation, for:*

Electromagnetic Compatibility & Telecommunications

*This laboratory is accredited in accordance with the recognized International Standard ISO/IEC 17025:2005.
This accreditation demonstrates technical competence for a defined scope and the operation of a laboratory quality
management system (refer to joint ISO-ILAC-IAF Communique dated January 2009).*

2016-09-29 through 2017-09-30
Effective Dates

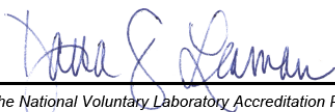

For the National Voluntary Laboratory Accreditation Program

*** END OF REPORT BODY ***