



# TEST REPORT

## No. I16Z42454-SRD01

for

**TCL Communication Ltd.**

**GSM Quad-band/HSPA-UMTS Six-band/LTE 19 band mobile phone**

**MODEL NAME: BBB100-1**

**FCC ID: 2ACCJN016**

**IC ID: 9238A-0075**

with

**Hardware Version: 05**

**Software Version: AAJ048**

**Issued Date: 2017-02-24**



**Note:**

The test results in this test report relate only to the devices specified in this report. This report shall not be reproduced except in full without the written approval of CTTL.

**Test Laboratory:**

CTTL, Telecommunication Technology Labs, Academy of Telecommunication Research, MIIT

No. 52, Huayuan North Road, Haidian District, Beijing, P. R. China 100191.

Tel:+86(0)10-62304633-2512, Fax:+86(0)10-62304633-2504

Email: [ctl\\_terminals@catr.cn](mailto:ctl_terminals@catr.cn), website: [www.chinattl.com](http://www.chinattl.com)



## **REPORT HISTORY**

<b>Report Number</b>	<b>Revision</b>	<b>Description</b>	<b>Issue Date</b>
I16Z42454-SRD01	Rev.0	1st edition	2017-02-24

---



## **CONTENTS**

<b>1. TEST LABORATORY .....</b>	<b>4</b>
1.1. TESTING LOCATION .....	4
1.2. TESTING ENVIRONMENT .....	4
1.3. PROJECT DATA .....	4
1.4. SIGNATURE .....	4
<b>2. CLIENT INFORMATION .....</b>	<b>5</b>
2.1. APPLICANT INFORMATION.....	5
2.2. MANUFACTURER INFORMATION .....	5
<b>3. EQUIPMENT UNDER TEST (EUT) AND ANCILLARY EQUIPMENT (AE) .....</b>	<b>6</b>
3.1. ABOUT EUT .....	6
3.2. INTERNAL IDENTIFICATION OF EUT USED DURING THE TEST .....	6
3.3. INTERNAL IDENTIFICATION OF AE USED DURING THE TEST.....	6
3.4. GENERAL DESCRIPTION .....	8
3.5. EUT SET-UPS .....	9
<b>4. REFERENCE DOCUMENTS .....</b>	<b>10</b>
4.1. DOCUMENTS SUPPLIED BY THE APPLICANT .....	10
4.2. REGULATIONS AND STANDARDS .....	10
<b>5. LABORATORY ENVIRONMENT .....</b>	<b>11</b>
<b>6. SUMMARY OF TEST RESULTS .....</b>	<b>12</b>
6.1. SUMMARY OF TEST RESULTS .....	12
6.2. TERMS USED IN THE SUMMARY OF TEST RESULTS .....	13
6.3. STATEMENTS .....	13
<b>7. TEST EQUIPMENTS UTILIZED .....</b>	<b>14</b>
<b>ANNEX A: MEASUREMENT RESULTS .....</b>	<b>15</b>
A.1. ELECTRIC FIELD STRENGTH OF FUNDAMENTAL AND OUTSIDE THE ALLOCATED BANDS .....	15
A.2. ELECTRIC FIELD RADIATED EMISSIONS (< 30MHz) .....	17
A.3. ELECTRIC FIELD RADIATED EMISSIONS (≥30MHz) .....	20
A.4. FREQUENCY TOLERANCE .....	24
A.5. 20dB BANDWIDTH.....	26
A.6. CONDUCTED EMISSION .....	28
<b>FINAL RESULT 1.....</b>	<b>29</b>
A.7. 99% EMISSION BANDWIDTH .....	31

## **1. Test Laboratory**

### **1.1. Testing Location**

Location 1: CTTL (Hua yuan North Road)

Address: No. 52, Huayuan North Road, Haidian District, Beijing,  
P. R. China 100191

Location 2: CTTL(Shouxiang)

Address: No. 51 Shouxiang Science Building, Xueyuan Road,  
Haidian District, Beijing, P. R. China 100191

### **1.2. Testing Environment**

Normal Temperature: 15 ~ 25 °C  
Extreme Temperature: 30 ~ 60 %  
Relative Humidity: 860 ~ 1060 mbar

### **1.3. Project data**

Testing Start Date: 2017-01-03  
Testing End Date: 2017-02-24

### **1.4. Signature**

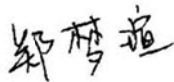

---

**Zheng Mengxuan**  
**(Prepared this test report)**



---

**Zhu Liang**  
**( Reviewed this test report)**

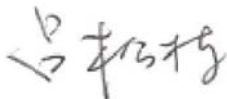

---

**Lv Songdong**  
**(Approved this test report)**



## **2. Client Information**

### **2.1. Applicant Information**

Company Name: TCL Communication Ltd.  
Address: 5F, C building, No. 232, Liang Jing Road ZhangJiang High-Tech Park,  
Pudong Area Shanghai, P.R. China. 201203  
Country: China  
Contact: Gong Zhizhou  
Email: zhizhou.gong@tcl.com  
Telephone: 0086-21-31363544

### **2.2. Manufacturer Information**

Company Name: TCL Communication Ltd.  
Address: 5F, C building, No. 232, Liang Jing Road ZhangJiang High-Tech Park,  
Pudong Area Shanghai, P.R. China. 201203  
Country: China  
Contact: Gong Zhizhou  
Email: zhizhou.gong@tcl.com  
Telephone: 0086-21-31363544



### **3. Equipment Under Test (EUT) and Ancillary Equipment (AE)**

#### **3.1. About EUT**

Description:	GSM Quad-band/HSPA-UMTS Six-band/LTE 19 band mobile phone
FCC ID	2ACCJN016
IC	9238A-0075
With NFC Function:	Yes
Frequency:	13.56 MHz
Antenna:	Internal
Operation Voltage:	3.8VDC

Note : High and low voltage values of extreme conditions are given by the manufacturer.

#### **3.2. Internal Identification of EUT Used during the Test**

##### **Mobile phone identification**

EUT ID*	IMEI	HW Version	SW Version
EUT10a	004402243183229	05	AAJ048

\*EUT ID: is used to identify the test sample in the lab internally.

#### **3.3. Internal Identification of AE Used during the Test**

AE ID*	Description	SN	Reversion
AE1	battery	/	/
AE2	battery	/	/
AE3	Travel charger	/	16TCT-CH-1886
AE4	Travel charger	/	16TCT-CH-1872
AE5	Travel charger	/	16TCT-CH-0005
AE6	USB Cable	/	/
AE7	USB Cable	/	/
AE60	NFC Card	/	/
AE10	Travel charger	/	/
AE11	Travel charger	/	/

##### **AE1**

Model	BAT-63108-003
SN	CAC3440001C3
Manufacturer	ATL
Capacitance	3440 mAh



Nominal voltage	3.85V
AE2	
Model	TLp034E1
SN	CAC3440003C1
Manufacturer	BYD
Capacitance	3440 mAh
Nominal voltage	3.85V
AE3	
Name	CBA0060AGHC1
Model	QC10US
Manufacturer	BYD
Length of cable	/
AE4	
Name	CBA0060ACHC1
Model	QC10AU
Manufacturer	BYD
Length of cable	/
AE5	
Name	CBA0060AJHC1
Model	QC10IN
Manufacturer	BYD
Length of cable	/
AE6	
Model	CDA0000105CF
Manufacturer	LUXSHARE
Length of cable	99cm
AE7	
Model	CDA0000108C2
Manufacturer	SHENGHUA
Length of cable	99cm
AE60	
Model	/
Manufacturer	/
AE10	
Name	CBA0060AAHC1
Model	QC10EU
Manufacturer	BYD
Length of cable	/
AE11	
Name	CBA0060ABHC1
Model	QC10UK





### 3.5. EUT Set-ups

<b>EUT Set-up No.</b>	<b>Combination of EUT and AE</b>	<b>Remarks</b>
Set. NFC01_1	EUT10 + AE1 + AE6 + AE3 + AE60	--
Set. NFC01_2	EUT10 + AE1 + AE6 + AE4 + AE60	
Set. NFC01_3	EUT10 + AE1 + AE6 + AE5 + AE60	
Set. NFC02	EUT1	--
Set. NFC03	EUT10 + AE60	

The Transmit State of NFC: the NFC function is on. The EUT will transmit the NFC data and command continuously during the test.

The Transmit State of without modulation: The EUT will transmit the CW signal at the operating frequency.

## 4. Reference Documents

### 4.1. Documents Supplied by the Applicant

EUT feature information is supplied by the applicant or manufacturer, which is the basis of testing.

### 4.2. Regulations and Standards

The following documents listed in this section are referred for testing.

Reference	Title	Version
RSS - Gen	Spectrum Management and Telecommunications - Radio Standards Specification General Requirements and Information for the Certification of Radiocommunication Equipment	Issue4 Nov 2014
RSS -210	Licence-exempt Radio Apparatus (All Frequency Bands): Category I Equipment	Issue8
CFR 47 Part 2	Part 2 — Frequency Allocations and Radio Treaty Matters; General Rules and Regulations.	2015
CFR 47 Part 15	Part 15 — Radio Frequency Devices. Subpart C — Intentional RadiatorsH. § 15.35 Measurement detector functions and bandwidths. § 15.207 Conducted limits. § 15.209 Radiated emission limits, general requirements. § 15.215 Additional provisions to the general radiated emission limitations. § 15.225 Operation within the band 13.110–14.010 MHz.	2015
ANSI C63.10	American National Standard of Procedures for Compliance Testing of Unlicensed Wireless Devices	2013

## 5. LABORATORY ENVIRONMENT

**Semi-anechoic chamber SAC-1** (23 meters×17meters×10meters) did not exceed following limits along the EMC testing:

Temperature	Min. = 15 °C, Max. = 35 °C
Relative humidity	Min. = 15 %, Max. = 75 %
Shielding effectiveness	0.014MHz - 1MHz, >60dB; 1MHz - 1000MHz, >90dB.
Electrical insulation	> 2 MΩ
Ground system resistance	< 4Ω
Normalised site attenuation (NSA)	< ± 4 dB, 3m/10m distance, from 30 to 1000 MHz
Site voltage standing-wave ratio ( $S_{VSWR}$ )	Between 0 and 6 dB, from 1GHz to 18GHz
Uniformity of field strength	Between 0 and 6 dB, from 80 to 3000 MHz

**Fully-Anechoic Chamber FAC-3** (8.6m×6.1m×3.85m) did not exceed following limits along the testing:

Temperature	Min. = 15 °C, Max. = 25 °C
Relative humidity	Min. = 30 %, Max. = 60 %
Shielding effectiveness	> 110 dB
Electrical insulation	> 2 MΩ
Ground system resistance	< 1 Ω
Site voltage standing-wave ratio ( $S_{VSWR}$ )	Between 0 and 6 dB, from 1 to 18GHz
Uniformity of field strength	Between 0 and 6 dB, from 80 to 4000 MHz

**Conducted Chamber** did not exceed following limits along the testing:

Temperature	Min. = 15 °C, Max. = 25 °C
Relative humidity	Min. = 30 %, Max. = 60 %
Shielding effectiveness	> 110 dB
Electrical insulation	> 2 MΩ
Ground system resistance	< 0.5 Ω

**Control Room** did not exceed following limits along the testing:

Temperature	Min. = 15 °C, Max. = 25 °C
Relative humidity	Min. =30 %, Max. = 60 %
Shielding effectiveness	> 110 dB
Electrical insulation	> 2 MΩ
Ground system resistance	< 0.5 Ω

## 6. SUMMARY OF TEST RESULTS

### 6.1. Summary of Test Results

No	Test Cases	Clause in Regulation	Section in This Report	Verdict
1	Electric Field Strength of Fundamental Emissions	CFR 47 § 15.225(a)	A.1	P (Set. NFC03)
2	Electric Field Strength of Outside the Allocated Bands	CFR 47 § 15.225(b) CFR 47 § 15.225(c)		P (Set. NFC03)
3	Electric Field Radiated Emissions	CFR 47 § 15.209 CFR 47 § 15.225(d)	A.2	P (Set. NFC01_1, NFC 01_2, NFC01_3)
			A.3	P (Set. NFC01)
4	Frequency Tolerance	CFR 47 § 15.225(e)	A.4	P (Set. NFC02)
5	20dB Bandwidth	CFR 47 § 15.215(c)	A.5	P (Set. NFC02, 03)
6	Conducted Emissions	CFR 47 § 15.207	A.6	P (Set. NFC01_1, NFC 01_2, NFC01_3)
7	99% Emission Bandwidth	\	RSS-GEN 4.6.1	P (Set. NFC02, 03)
The measurement is carried out according to ANSI C63.4. See <b>ANNEX A</b> for details.				

#### Test Conditions:

For this report, all the test cases listed above were tested under normal Temperature, Voltage, Humidity, and Air Pressure. The specific conditions are as following:

Temperature	T min	-10 °C
	T nom	25 °C
	T max	55 °C
Voltage	V min	3.6 V
	V nom	3.8 V
	V max	4.2 V
Humidity	H nom	44%
Air Pressure	A nom	1010 mbar

## 6.2. Terms Used in the Summary of Test Results

### Terms Used in Condition Column:

T nom	Normal Temperature
T min	Low Temperature
T max	High Temperature
V nom	Normal Voltage
V min	Low Voltage
V max	High voltage
H nom	Norm Humidity
A nom	Norm Air Pressure

### Terms Used in Verdict Column:

P	Pass, The EUT complies with the essential requirements in the standard.
NP	Not Perform, The test was not performed by CTTL
NA	Not Applicable, The test was not applicable
F	Fail, The EUT does not comply with the essential requirements in the standard

### Abbreviations:

AC	Alternating Current
AFH	Adaptive Frequency Hopping
BW	Band Width
E.I.R.P.	equivalent isotropical radiated power
ISM	Industrial, Scientific and Medical
RF	Radio Frequency
Tx	Transmitter

## 6.3. Statements

The test cases listed in Section 6.1 of this report for the EUT specified in Section 3 were performed by CTTL according to the reference documents in Section 4.

The EUT meets all applicable requirements of the regulations and standards in Section 4.2.

This report only deals with the NFC function among the features described in section 3.

**7. Test Equipments Utilized**

<b>NO.</b>	<b>NAME</b>	<b>TYPE</b>	<b>SERIES NUMBER</b>	<b>PRODUCER</b>	<b>CAL. DUE DATE</b>
1.	Thermal Chamber	PL-2G	343074	ESPEC	2017-05-12
2.	Spectrum Analyzer	RSA3408A	B 010277	Tektronix	2017-05-27
3.	H-field Antenna	HFH2-Z2	829324/0007	R&S	2017-12-16
4.	EMI Antenna	VULB 9163	9163-235	Schwarz beck	2017-03-02
5.	Test Receiver	ESCI	100344	R&S	2017-03-01
6.	Universal Radio Communication Tester	CMW500	143008	R&S	2017-12-01
7.	Universal Radio Communication Tester	CMW500	116588	R&S	2017-12-01
8.	Spectrum Analyzer	E4440A	MY48250642	Agilent	2017-03-03
9.	LISN	ESH2-Z5	829991/012	R&S	2017-04-11

## **ANNEX A: MEASUREMENT RESULTS**

### **A.1. Electric Field Strength of Fundamental and Outside the Allocated bands**

#### **A.1.1. Reference**

See Clause 13.5, Clause 13.4, Clause 8, and Annex E of ANSI C63.4-2009 specifically.  
See Clause 4, Clause 5, and Clause 6 of ANSI C63.4-2009 generally.

#### **A.1.2. Measurement Methods**

The transmitter carrier output levels (E-Field) from the EUT are measured in a semi-anechoic chamber. The EUT is placed on a non-conductive stand of 80cm high, and at a measurement distance of 3m from the receiving antenna. The center of the receiving loop antenna is 1.0 meter above the ground. The E-field is measured with a shielded loop antenna connected to a measurement receiver. Detected E-field was maximized by rotating the EUT through 360° and adjusting the receiving antenna polarizations. The maximization processes were repeated with the EUT positioned respectively in its three orthogonal axes. The measurements were performed with the peak detector and if required, the quasi-peak detector.

The measurement bandwidth is:

Frequency of Emission (MHz)	RBW/VBW
12.56-14.56	10/30 kHz

The E-field measured at 3m is calculated as:

$$\text{E-field (dB}\mu\text{V/m)} = \text{Rx (dB}\mu\text{V)} + \text{Cable Loss (dB)} + \text{AF@3m (dB/m)}$$

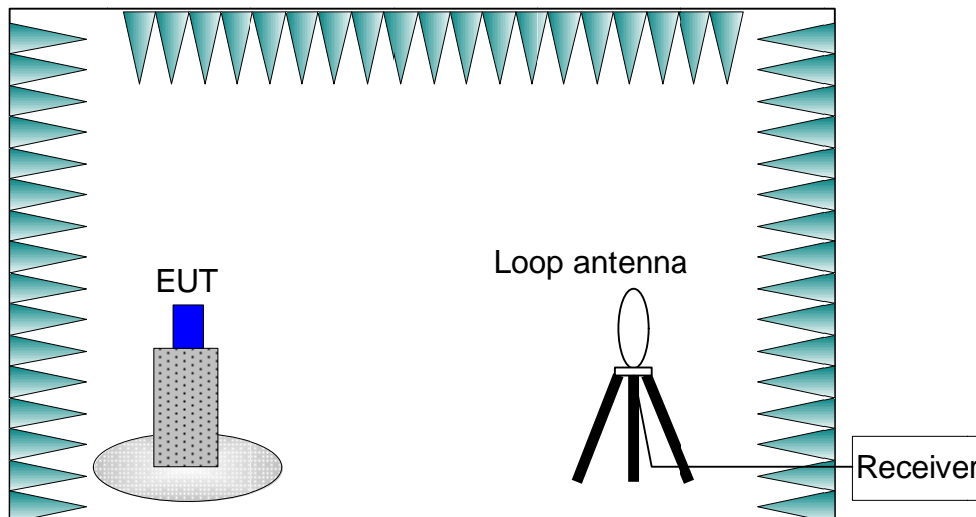

#### **A.1.3. EUT Operating Mode and Test Conditions**

The measurement of EUT is carried out under the transmit state of NFC (See 3.5).

The EUT is powered by a travel adapter.

During the measurements, the ambient temperature of the electromagnetic anechoic chamber is in the range of 15 ~ 25 °C.

#### A.1.4. Limits

Frequency Range (MHz)	E-field Strength Limit @ 30 m (μV/m)	E-field Strength Limit @ 3 m (dBμV/m)
13.560 ± 0.007	+15,848	124
13.410 to 13.553 13.567 to 13.710	+334	90
13.110 to 13.410 13.710 to 14.010	+106	81

Note: Where the limits have been defined at one distance, and a signal level measured at another, the limits have been extrapolated using the following formula:

$$\text{Extrapolation(dB)} = 40\log_{10}(\text{Measurement Distance}/\text{Specification Distance})$$

#### A.1.5. Measurement Results

Measurement results of normal conditions see Figure A-1 for different set-ups of EUT. The result displayed take into account applicable antenna factors and cable losses.

**Conclusions:** Set. NFC03, **PASS**.

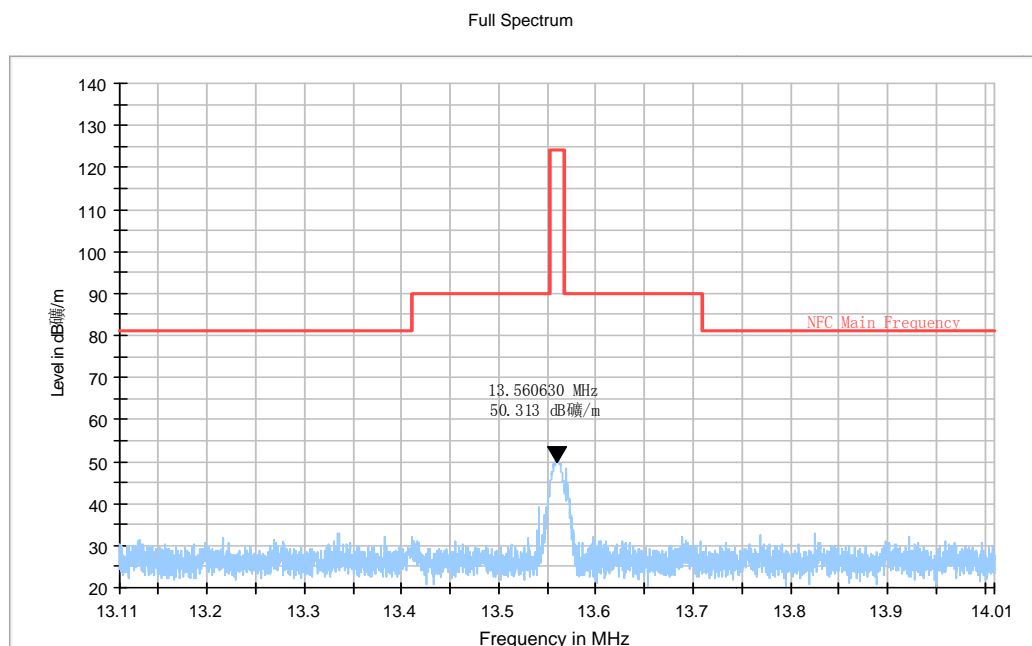

**Figure A-1: Set. NFC03**

#### A.1.6. Measurement Uncertainty

Measurement uncertainty:  $U = 3.94$  dB,  $k=2$ .



## **A.2. Electric Field Radiated Emissions (< 30MHz)**

### **A.2.1. Reference**

See Clause 6.4 of ANSI C63.10-2013 specifically.

See Clause 4 and Clause 5 of ANSI C63.10-2013 generally.

### **A.2.2. Measurement Methods**

The transmitter carrier output levels (E-Field) from the EUT are measured in a semi-anechoic chamber. The EUT is placed on a non-conductive stand of 80cm high, and at a measurement distance of 3m from the receiving antenna. The center of the receiving loop antenna is 1.0 meter above the ground. The E-field is measured with a shielded loop antenna connected to a measurement receiver. Detected E-field was maximized by rotating the EUT through 360° and adjusting the receiving antenna polarizations. The maximization processes were repeated with the EUT positioned respectively in its three orthogonal axes. The measurements were performed with the peak detector and if required, the quasi-peak detector.

The measurement bandwidth is:

Frequency of Emission (MHz)	RBW/VBW
0.009-0.15	100/300 Hz
0.15-30	10/30 kHz

The E-field measured at 3m is calculated as:

$$\text{E-field (dB}\mu\text{V/m)} = \text{Rx (dB}\mu\text{V)} + \text{Cable Loss (dB)} + \text{AF@3m (dB/m)}$$

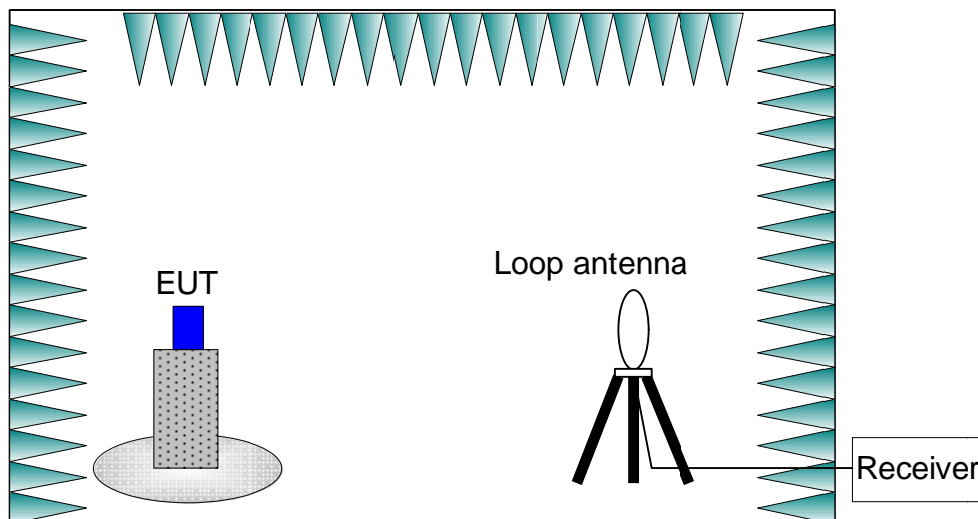

### **A.2.3. EUT Operating Mode and Test Conditions**

The measurement of EUT is carried out under the transmit state of NFC (See 3.5).

The EUT is powered by a travel adapter.

During the measurements, the ambient temperature of the electromagnetic anechoic chamber is in the range of 15 ~ 25 °C.

**A.2.4. Limits**

Frequency Range (MHz)	E-field Strength Limit @ 30m (mV/m)	E-field Strength Limit @ 3m (dBµV/m)
0.009-0.490	2400/F(kHz)	129-94
0.490-1.705	24000/F(kHz)	74-63
1.705-30	30	70

Note: Where the limits have been defined at one distance, and a signal level measured at another, the limits have been extrapolated using the following formula:

$$\text{Extrapolation(dB)} = 40\log_{10}(\text{Measurement Distance}/\text{Specification Distance})$$

**A.2.5. Measurement Results**

Measurement results of normal conditions see Figure A-2 for different set-ups of EUT. The result displayed take into account applicable antenna factors and cable losses.

**Conclusions:** Set. NFC01, **PASS**.

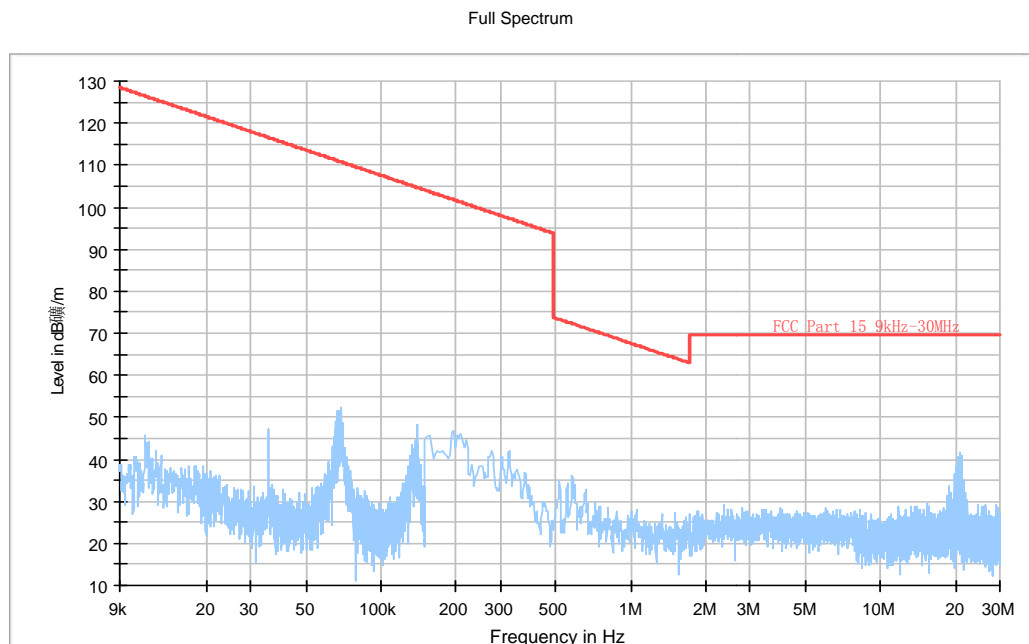

**Figure A-2: Set. NFC01\_1**

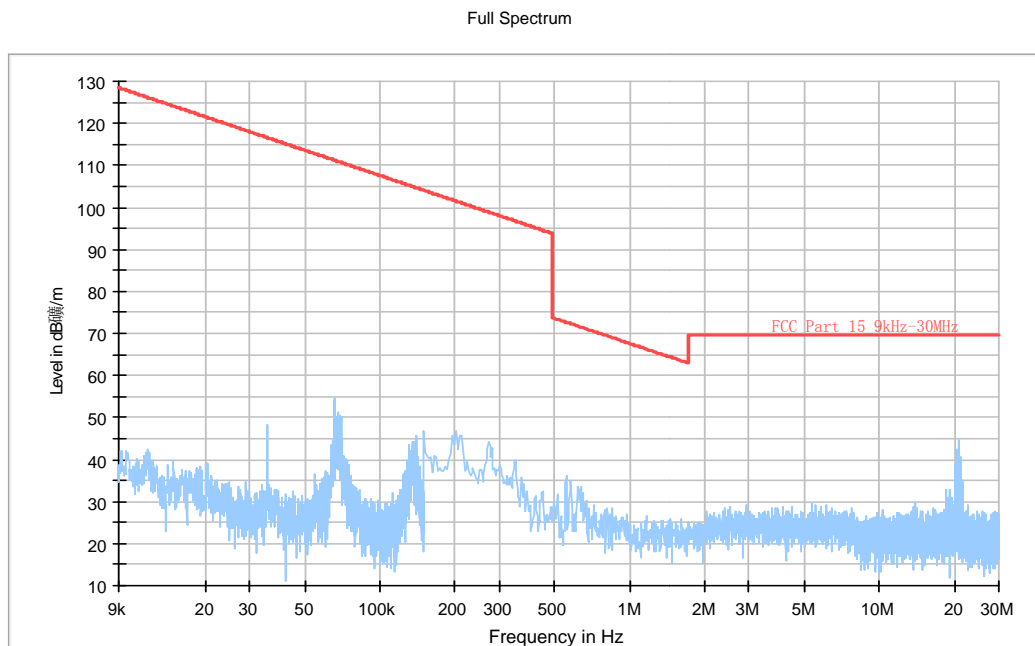

**Figure A-3: Set. NFC01\_2**

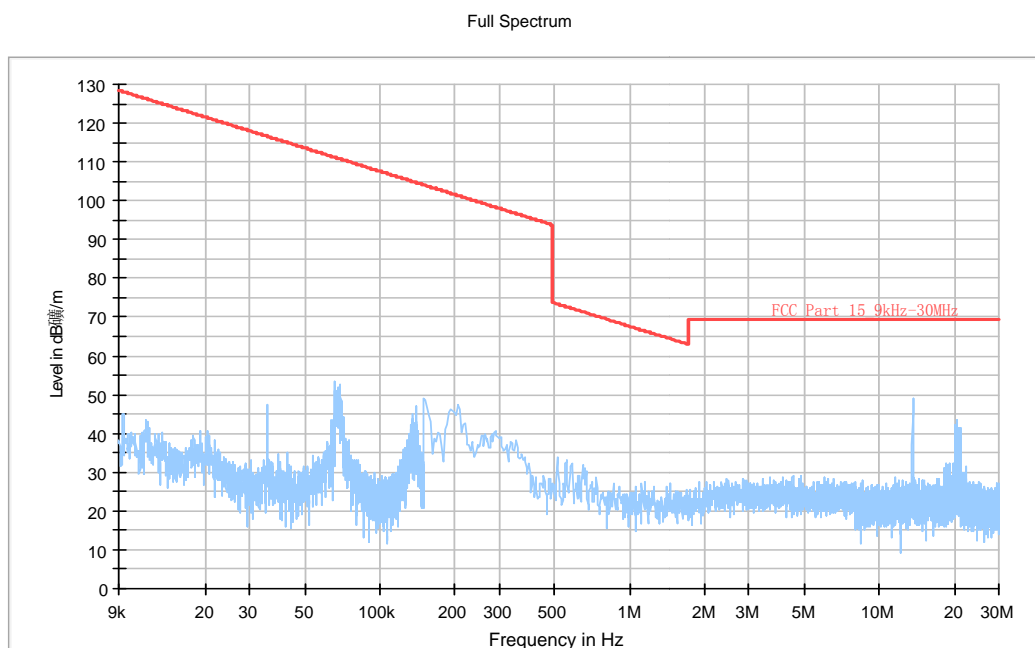

**Figure A-4: Set. NFC01\_3**

**A.2.6. Measurement Uncertainty**

Measurement uncertainty:  $U = 3.94$  dB,  $k=2$ .

### **A.3. Electric Field Radiated Emissions ( $\geq 30\text{MHz}$ )**

#### **A.3.1. Reference**

See Clause 6.5 of ANSI C63.10-2013 specifically.

See Clause 4 and Clause 5 of ANSI C63.10-2013 generally.

#### **A.3.2. Measurement Methods**

The electric field radiated emissions from the EUT are measured in a semi-anechoic chamber. The EUT is placed on a non-conductive stand of 80cm high, and at a measurement distance of 10m from the receiving antenna. The receiving antennas connected to a measurement receiver comply with Clause 15 of ANSI C63.2-1996 and Clause 4.1.5 of ANSI C63.4-2009. In order to search for maximum field strength emitted from the EUT, the receiving antenna can be moved between the height of 1.0 m to 4.0 m. Detected E-field was maximized at each frequency by rotating the EUT through 360° and adjusting the receiving antenna positions for both vertical and horizontal antenna polarizations. The maximization processes were repeated with the EUT positioned respectively in its three orthogonal axes. The measurements were performed with the peak detector and if required, the quasi-peak detector.

The measurement bandwidth is:

Frequency of Emission (MHz)	RBW/VBW
30-1000	120kHz

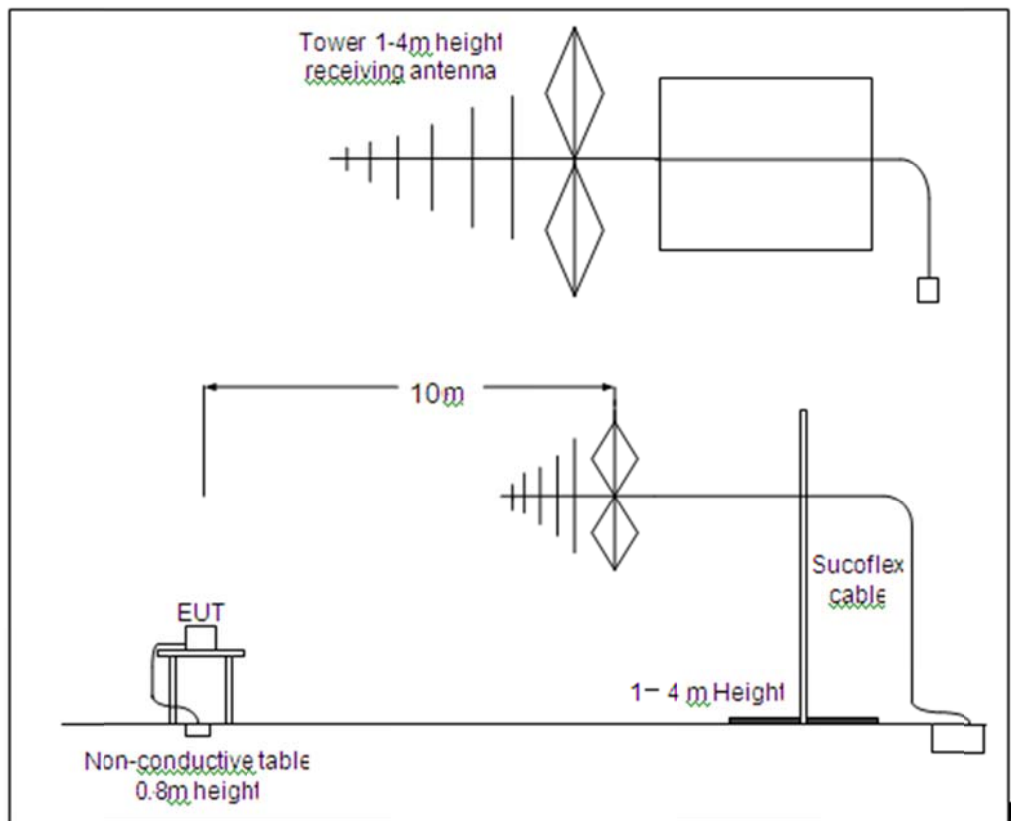

### A.3.3. EUT Operating Mode and Test Conditions

The measurement of EUT is carried out under the transmit state of NFC (See 3.5).

EUT1 had been connected to a travel adapter.

During the measurements, the ambient temperature of the electromagnetic anechoic chamber is in the range of 15 ~ 25 °C.

### A.3.4. Limits

Frequency Range (MHz)	E-field Strength Limit @ 3m (mV/m)	E-field Strength Limit @ 3m (dBµV/m)	E-field Strength Limit @ 10m (dBµV/m)
30-88	100	40	30
88-216	150	43.5	33.5
216-960	200	46	36
960-1000	500	54	44

### A.3.5. Measurement Results

Measurement results of normal conditions see Figure A-3 for different set-ups of EUT. The result displayed take into account applicable antenna factors and cable losses.

**Conclusions:** Set. NFC01, **PASS**.

### A.3.6. Measurement Uncertainty

Measurement uncertainty:  $U = 3.9$  dB,  $k=2$

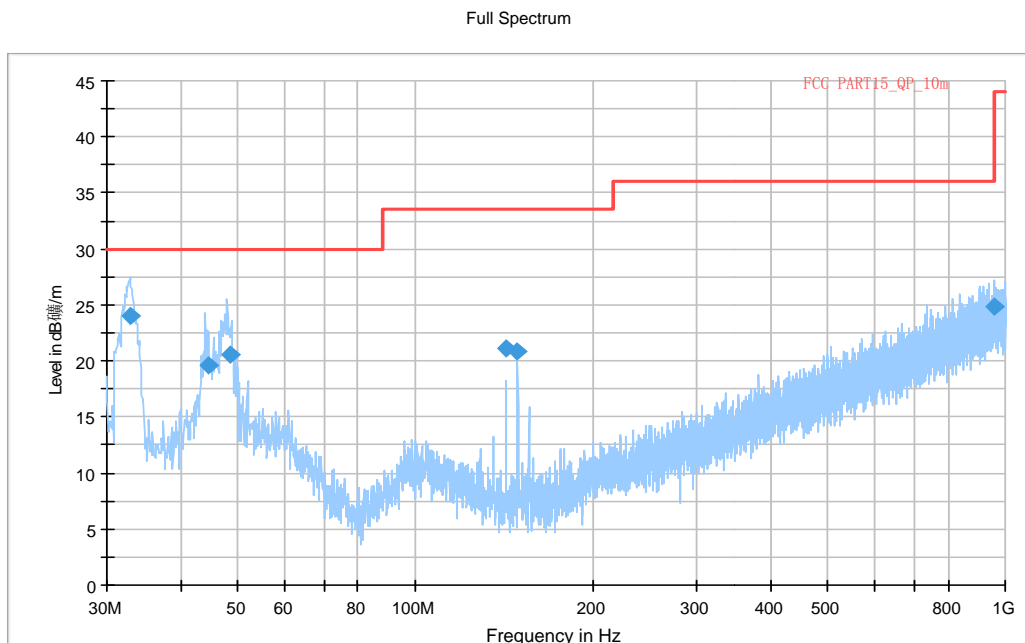
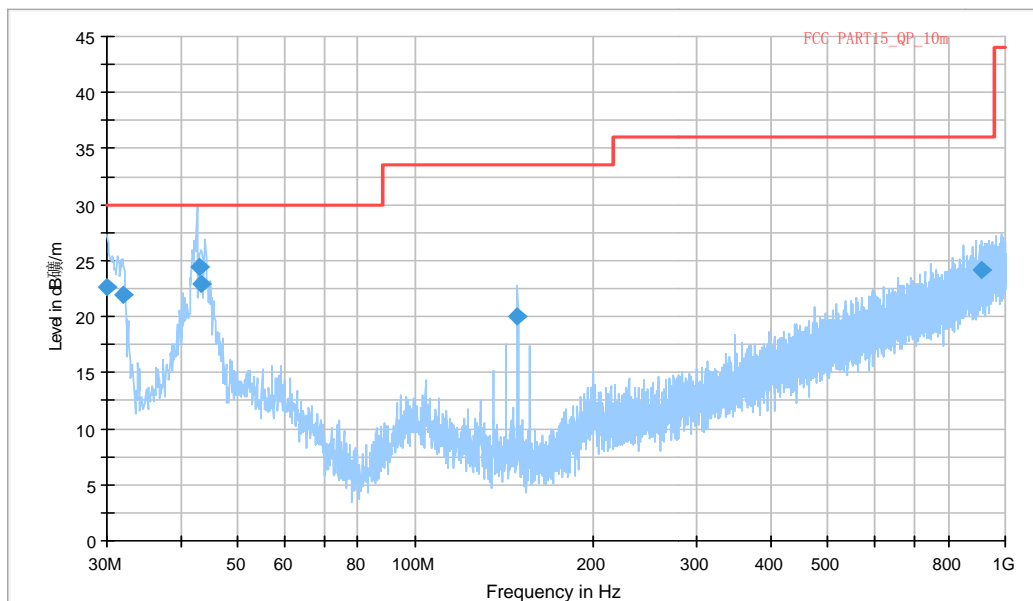

**Figure A-5: Set. NFC01**

**Final\_Result**

Frequency (MHz)	QuasiPeak (dB $\mu$ V/m)	Limit (dB $\mu$ V/m)	Margin (dB)	Meas. Time	Bandwidth (kHz)	Height (cm)	Pol	Azimuth (deg)
32.790000	23.95	30.00	6.05	1000.0	120.000	119.0	V	68.0
44.605000	19.64	30.00	10.36	1000.0	120.000	185.0	V	169.0
48.462000	20.52	30.00	9.48	1000.0	120.000	210.0	V	201.0
142.326000	21.07	33.50	12.45	1000.0	120.000	125.0	V	61.0
149.116000	20.86	33.50	12.66	1000.0	120.000	119.0	V	60.0
957.602000	24.83	36.00	11.19	1000.0	120.000	216.0	V	107.0

Full Spectrum



**Figure A-6: Set. NFC01\_2**

**Final\_Result**

Frequency (MHz)	QuasiPeak (dB $\mu$ V/m)	Limit (dB $\mu$ V/m)	Margin (dB)	Meas. Time	Bandwidth (kHz)	Height (cm)	Pol	Azimuth (deg)
30.000000	22.68	30.00	7.32	1000.0	120.000	225.0	V	106.0
31.880000	21.98	30.00	8.02	1000.0	120.000	193.0	V	60.0
43.030000	24.49	30.00	5.51	1000.0	120.000	175.0	V	173.0
43.465000	22.93	30.00	7.07	1000.0	120.000	290.0	V	184.0
149.153000	19.95	33.50	13.57	1000.0	120.000	283.0	V	150.0
910.848000	24.14	36.00	11.88	1000.0	120.000	112.0	V	175.0

Full Spectrum

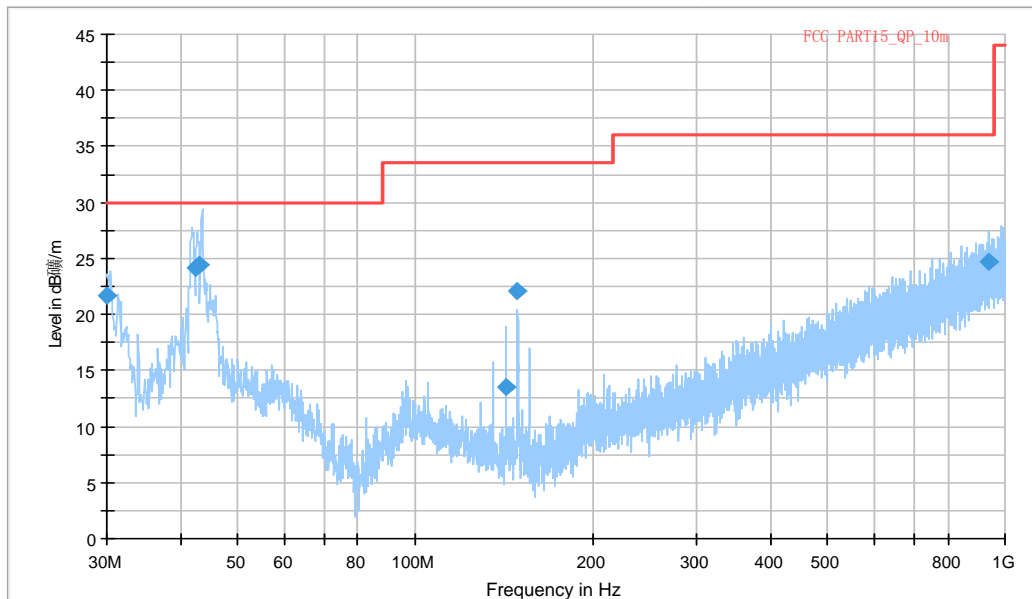

Figure A-7: Set. NFC01\_3

Final\_Result

Frequency (MHz)	QuasiPeak (dBµV/m)	Limit (dBµV/m)	Margin (dB)	Meas. Time	Bandwidth (kHz)	Height (cm)	Pol	Azimuth (deg)
30.000000	21.74	30.00	8.26	1000.0	120.000	125.0	V	150.0
42.374000	24.22	30.00	5.78	1000.0	120.000	297.0	V	61.0
42.980000	24.39	30.00	5.61	1000.0	120.000	225.0	V	183.0
142.363000	13.58	33.50	19.94	1000.0	120.000	295.0	V	210.0
149.153000	22.13	33.50	11.39	1000.0	120.000	175.0	V	60.0
940.128000	24.68	36.00	11.34	1000.0	120.000	225.0	V	120.0

## **A.4. Frequency Tolerance**

### **A.4.1. Reference**

See Clause 13.6 of ANSI C63.4-2009 specifically.

See Clause 4, Clause 5, and Clause 6 of ANSI C63.4-2009 generally.

### **A.4.2. Measurement Methods**

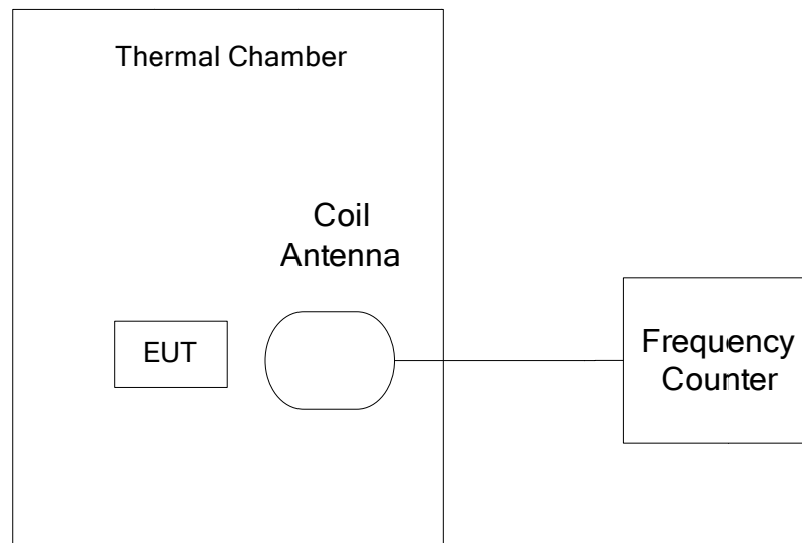

The transmitter output signal was picked up by coil antenna connected to the frequency counter. The center frequency was measured with 30Hz RBW and 1kHz span.

During the test, the EUT was placed in a thermal chamber until thermal balance and lasting appropriate time.

### **A.4.3. EUT Operating Mode and Test Conditions**

The measurement of EUT is carried out under the transmit state of without modulation (See 3.5). EUT1 had been not connected to a travel adapter.

Operation Temperature: T min, T nom, and T max with V nom.

Operation Voltage: V min and V max with T nom.

### **A.4.4. Test Layouts**

See A.4.2.

### **A.4.5. Limits**

The frequency tolerance of the carrier signal shall be maintained within +/- 0.01% of the operating frequency.

### **A.4.6. Measurement Results**

Measurement results see Table A-1 for different test conditions.

**Conclusions:** Set. NFC02, **PASS**.



**Table A-1: Frequency Stability VS Temperature and Voltage**

Temperature	Voltage	Frequency Error (MHz)			
		Startup	2 Min Later	5 Min Later	10 Min Later
T min	V nom	13.5599938	13.5601488	13.5600350	13.5600970
T max	V nom	13.5600099	13.5600175	13.5599957	13.5600561
T nom	V nom	13.5599831	13.5599882	13.5599963	13.5599894
T nom	V min	13.5601113	13.5601790	13.5601080	13.5601235
T nom	V max	13.5599176	13.5601457	13.5601231	13.5601272

Temperature	Voltage	Frequency Error (%)			
		Startup	2 Min Later	5 Min Later	10 Min Later
T min	V nom	0.000	0.001	0.000	0.001
T max	V nom	0.000	0.000	0.000	0.000
T nom	V nom	0.000	0.000	0.000	0.000
T nom	V min	0.001	0.001	0.001	0.001
T nom	V max	-0.001	0.001	0.001	0.001

**A.4.7. Measurement Uncertainty**

Measurement uncertainty:  $U = 77$  Hz,  $k=2$

## **A.5. 20dB Bandwidth**

### **A.5.1. Reference**

See Clause 13.7 of ANSI C63.4-2009 specifically.

See Clause 4, Clause 5, and Clause 6 of ANSI C63.4-2009 generally.

### **A.5.2. Measurement Methods**

The transmitter output signal was picked up by coil antenna to the spectrum analyzer.

The transmitter output signal was picked up by coil antenna connected to the spectrum analyzer.

The bandwidth of the center frequency was measured with 140Hz RBW, 420Hz VBW and 14kHz span.

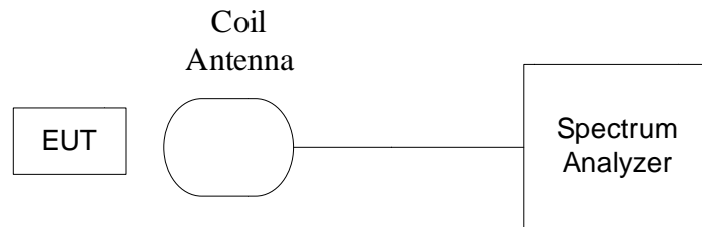

### **A.5.3. EUT Operating Mode and Test Conditions**

The measurement of EUT is carried out under the transmit state of NFC and without modulation (See 3.5).

EUT had been not connected to a travel adapter..

During the measurements, the ambient temperature is in the range of 15 ~ 25 °C.

### **A.5.4. Test Layouts**

See A.5.2.

### **A.5.5. Limits**

The 20dB bandwidth shall be less than 80% of the permitted frequency band. For 13.56 MHz NFC, the permitted frequency band is 14kHz, so the limit is 11.2 kHz.

### **A.5.6. Measurement Results**

Measurement results see Figure A-4.

**Conclusions:** Set. NFC02 and NFC03, **PASS**.

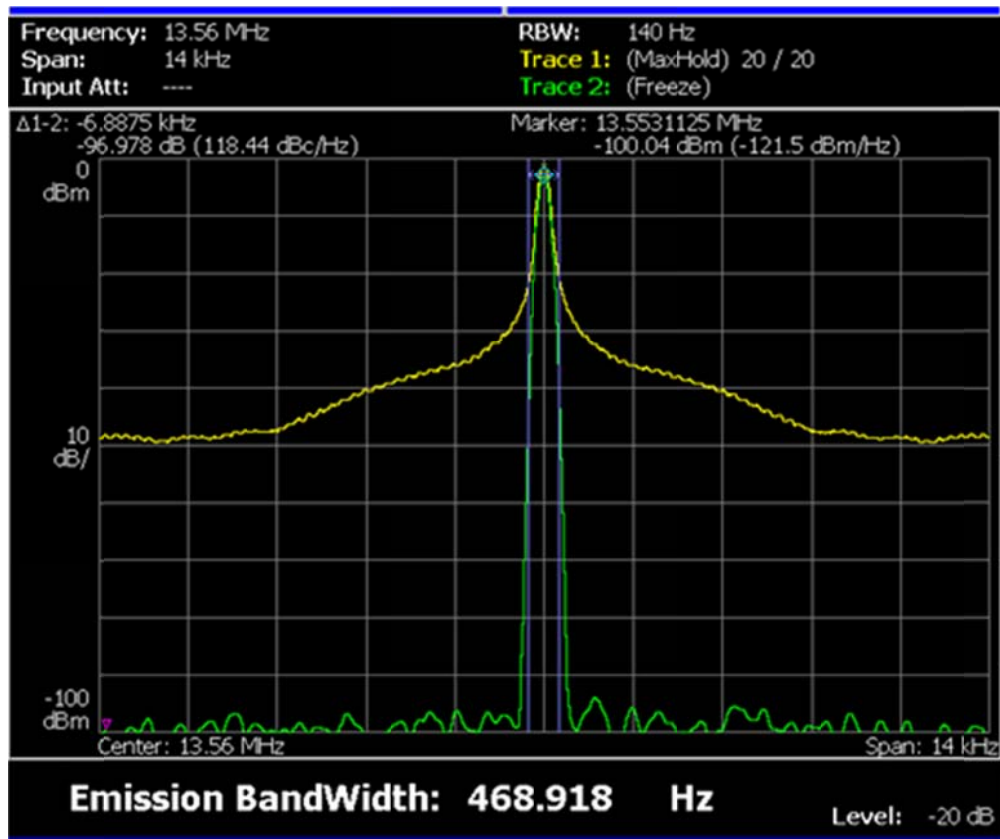

Figure A-8: Test result of EUT1 at test set. NFC02

#### A.5.7. Measurement Uncertainty

Measurement uncertainty:  $U = 77 \text{ Hz}$ ,  $k=2$

## **A.6. Conducted emission**

### **A.6.1. Reference**

See Clause 13.3 and Clause 7 of ANSI C63.4-2013 specifically.

See Clause 4, Clause 5, and Clause 6 of ANSI C63.4-2013 generally.

### **A.6.2. Measurement Methods**

The conducted emissions from the AC port of the EUT are measured in a shielding room. The EUT is connected to a Line Impedance Stabilization Network (LISN). An overview sweep with peak detection was performed. The measurements were performed with a quasi-peak detector and if required, an average detector.

The conducted emission measurements were made with the following detector of the test receiver: Quasi-Peak / Average Detector.

The measurement bandwidth is:

Frequency of Emission (MHz)	RBW/VBW
0.15-30	9kHz

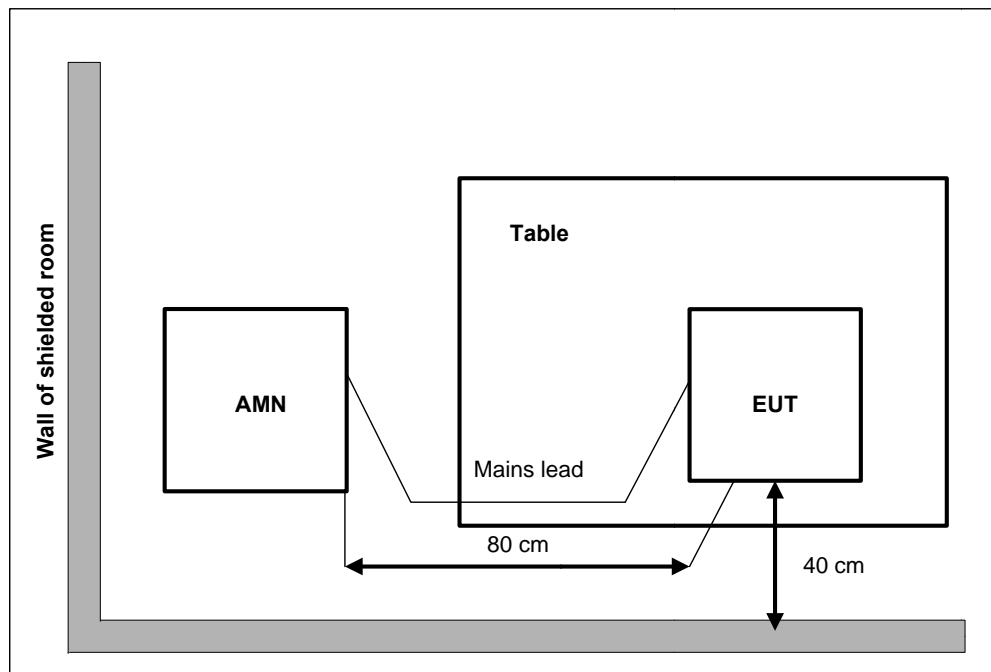

### **A.6.3. EUT Operating Mode and Test Conditions**

The measurement of EUT is carried out under the transmit state of NFC (See 3.5).

The EUT is powered by a travel adapter.

During the measurements, the ambient temperature is in the range of 15 ~ 25 °C.

### **A.6.4. Limits**

Frequency range (MHz)	Quasi-peak Limit (dB $\mu$ V)	Average Limit (dB $\mu$ V)
0.15 to 0.5	66 to 56	56 to 46
0.5 to 5	56	46

5 to 30	60	50
---------	----	----

### A.6.5. Measurement Results

Measurement results see Figure C-5.

**Conclusions:** Set. NFC01\_1, **PASS**.

Note: The measurement result at 13.56MHz is the fundamental emission of NFC signal.

#### CBA0060AGHC1(the worst case)

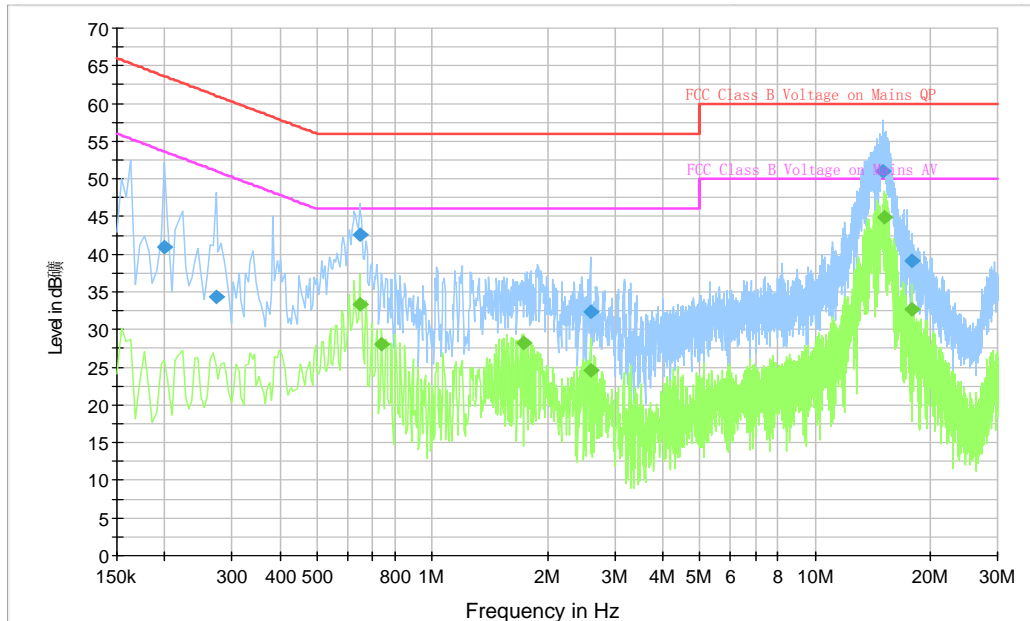

#### Final Result 1

Frequency (MHz)	QuasiPeak (dBµV)	Meas. Time	Bandwidth (kHz)	Filter	Line	Corr. (dB)	Margin (dB)	Limit (dBµV)
0.199500	40.9	2000.0	9.000	On	L1	19.8	22.7	63.6
0.271500	34.4	2000.0	9.000	On	L1	19.8	26.7	61.1
0.645000	42.7	2000.0	9.000	On	L1	19.8	13.3	56.0
2.589000	32.4	2000.0	9.000	On	N	19.1	23.6	56.0
15.072000	50.9	2000.0	9.000	On	L1	19.8	9.1	60.0
17.911500	39.2	2000.0	9.000	On	N	19.9	20.8	60.0

#### Final Result 2

Frequency (MHz)	Average (dBµV)	Meas. Time	Bandwidth (kHz)	Filter	Line	Corr. (dB)	Margin (dB)	Limit (dBµV)
0.645000	33.3	2000.0	9.000	On	L1	19.8	12.7	46.0
0.739500	28.1	2000.0	9.000	On	L1	19.8	17.9	46.0
1.738500	28.3	2000.0	9.000	On	N	19.7	17.7	46.0
2.589000	24.5	2000.0	9.000	On	N	19.1	21.5	46.0
15.189000	44.9	2000.0	9.000	On	L1	19.8	5.1	50.0
17.911500	32.7	2000.0	9.000	On	N	19.9	17.3	50.0

Figure A-9: Test result of EUT1 at test set. NFC01



**A.6.6. Measurement Uncertainty**

Measurement uncertainty:  $U = 3.38$  dB,  $k=2$

## **A.7. 99% Emission Bandwidth**

### **A.7.1. Reference**

See Clause 4.6.1 of RSS-GEN specifically.

### **A.7.2. Measurement Methods**

The transmitter output signal was picked up by coil antenna to the spectrum analyzer.

The transmitter output signal was picked up by coil antenna connected to the spectrum analyzer.

The bandwidth of the center frequency was measured with 10kHz RBW, 30kHz VBW and 1MHz span.

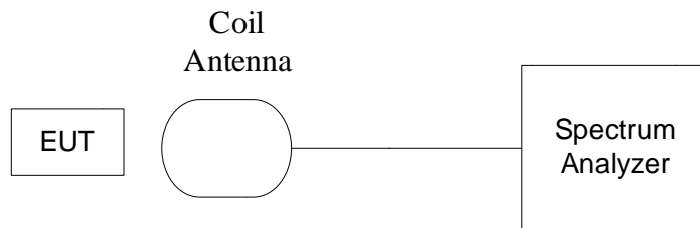

### **A.7.3. EUT Operating Mode and Test Conditions**

The measurement of EUT is carried out under the transmit state of NFC and with modulation (See 3.5).

EUT1 had been not connected to a travel adapter.

### **A.7.4. Measurement Results**

Test Conditions		99% Emission Bandwidth
$T_{nom}$	$V_{nom}$	421.516KHz

Measurement results see Figure A-6.

**Conclusions:** Set. NFC02 and NFC03, **PASS**.

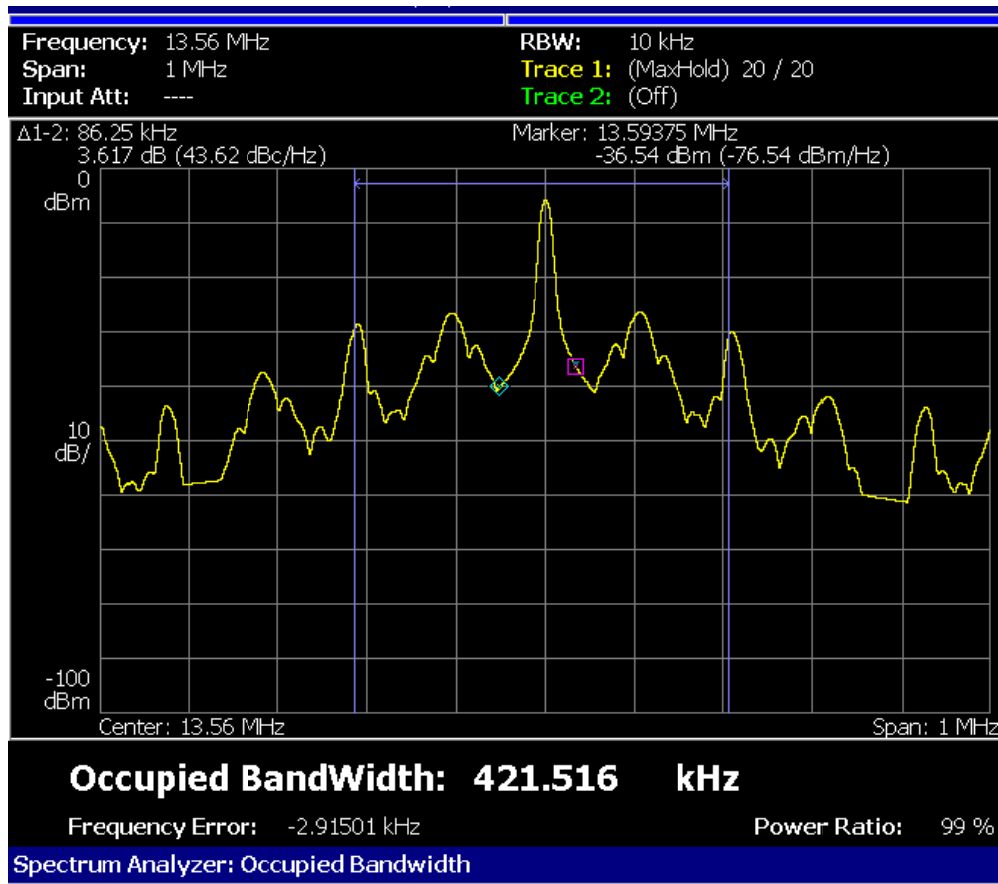

Figure A-10: Test result of EUT1 at test set. NFC02

#### A.7.5. Measurement Uncertainty

Measurement uncertainty:  $U = 77 \text{ Hz}$ ,  $k=2$

\*\*\*END OF REPORT\*\*\*