

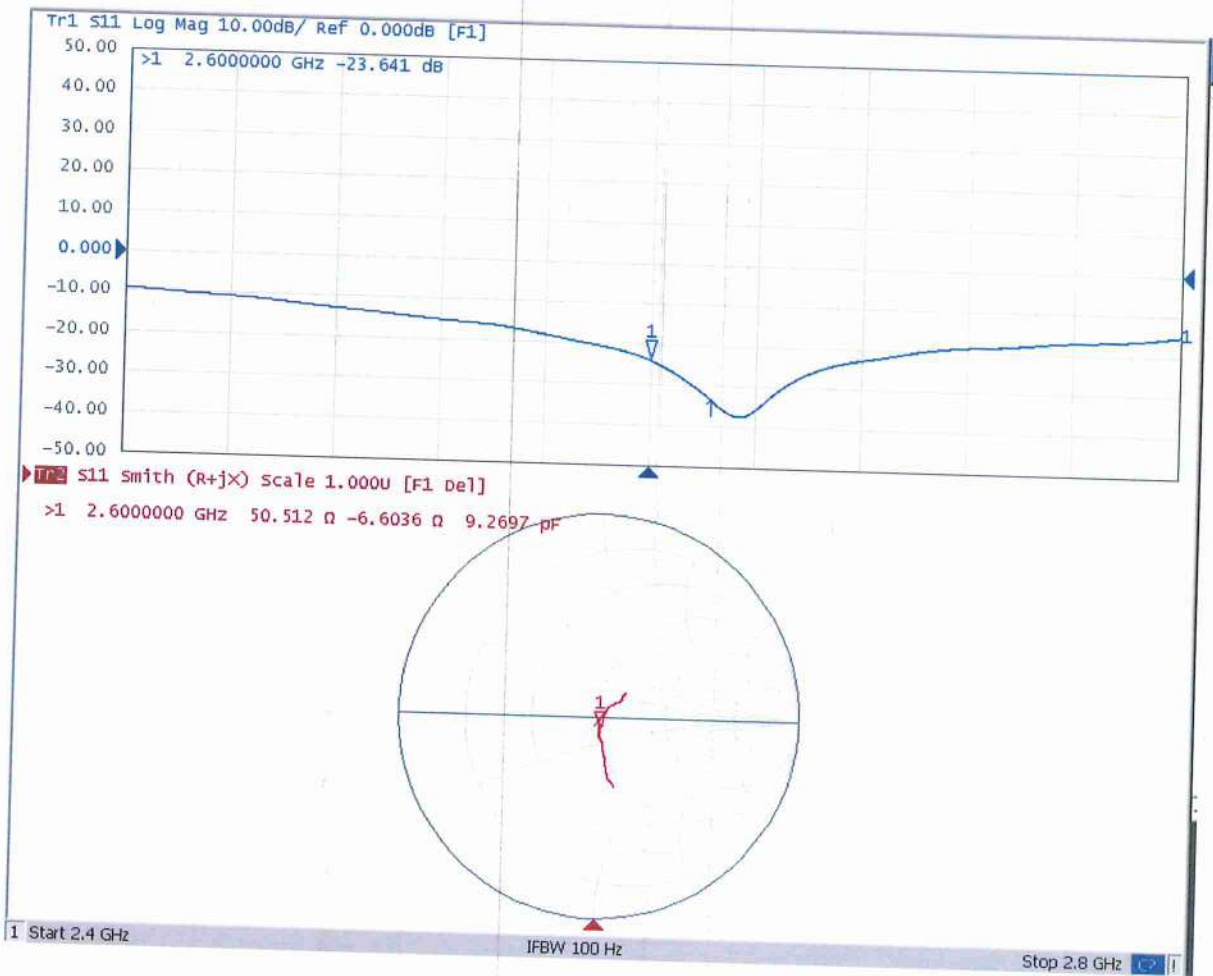

In Collaboration with
s p e a g
CALIBRATION LABORATORY

Add: No.52 HuaYuanBei Road, Haidian District, Beijing, 100191, China
Tel: +86-10-62304633-2079 Fax: +86-10-62304633-2504
E-mail: cttl@chinattl.com http://www.chinattl.cn

Impedance Measurement Plot for Head TSL





D2600V2, Serial No. 1070 Extended Dipole Calibrations

If dipoles are verified in return loss (<-20dB, within 20% of prior calibration), and in impedance (within 5 ohm of prior calibration), the annual calibration is not necessary and the calibration interval can be extended.

| D2600V2 – serial no. 1070 | | | | | | |
|---------------------------|------------------|-----------|----------------------|-------------|---------------------------|-------------|
| 2600 Head | | | | | | |
| Date of Measurement | Return-Loss (dB) | Delta (%) | Real Impedance (ohm) | Delta (ohm) | Imaginary Impedance (ohm) | Delta (ohm) |
| 2021.12.20 | -23.6 | | 50.5 | | -6.6 | |
| 2022.12.19 | -24.0 | 1.6% | 51.2 | -0.7 | -6.3 | -0.3 |
| 2023.12.19 | -23.7 | 0.4% | 51.9 | -1.4 | -6.4 | -0.2 |

<Justification of the extended calibration>

The return loss is < -20dB, within 20% of prior calibration; the impedance is within 5 ohm of prior calibration. Therefore the verification result should support extended calibration.

Dipole Verification Data> D2600V2, serial no. 1070

2600MHz – Head----2022.12.19

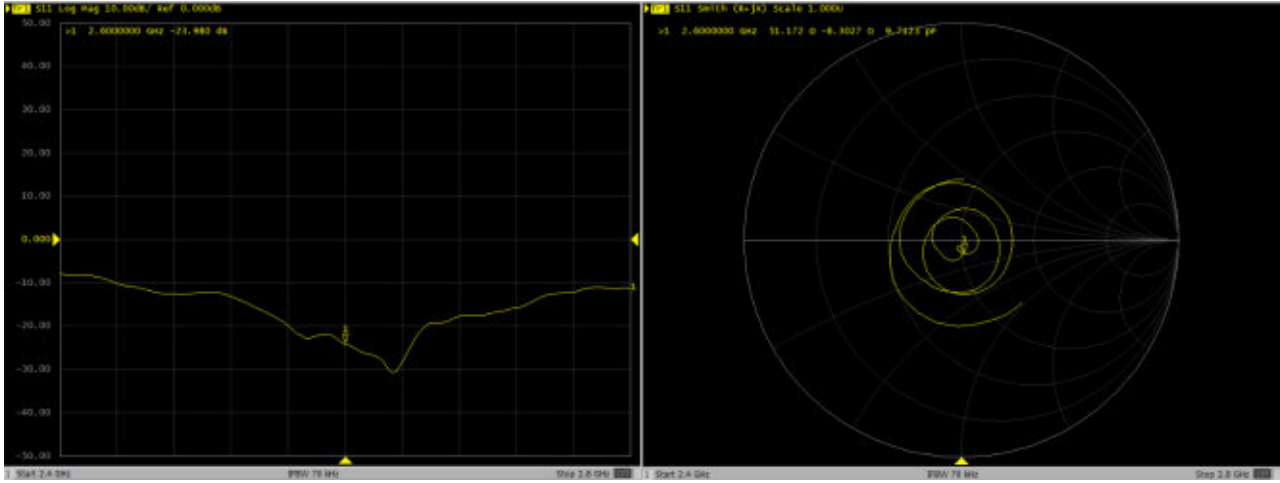

2600MHz – Head----2023.12.19

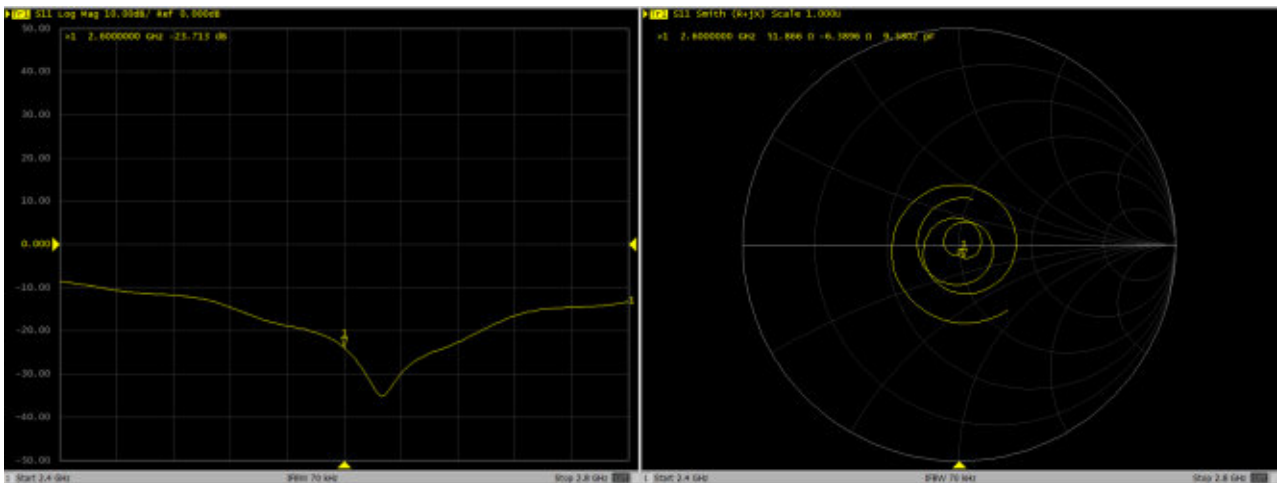

Add: No.52 HuaYuanBei Road, Haidian District, Beijing, 100191
Tel: +86-10-62304633-2117
E-mail: cttl@chinattl.com http://www.caict.ac.cn

Client

Sporton

Certificate No: **Z22-60145**

CALIBRATION CERTIFICATE

Object: **D3500V2 - SN: 1076**

Calibration Procedure(s):
FF-Z11-003-01
Calibration Procedures for dipole validation kits

Calibration date: **May 9, 2022**

This calibration Certificate documents the traceability to national standards, which realize the physical units of measurements (SI). The measurements and the uncertainties with confidence probability are given on the following pages and are part of the certificate.

All calibrations have been conducted in the closed laboratory facility: environment temperature (22±3)°C and humidity<70%.

Calibration Equipment used (M&TE critical for calibration)

| Primary Standards | ID # | Cal Date (Calibrated by, Certificate No.) | Scheduled Calibration |
|-------------------------|------------|---|-----------------------|
| Power Meter NRP2 | 106277 | 24-Sep-21 (CTTL, No.J21X08326) | Sep-22 |
| Power sensor NRP8S | 104291 | 24-Sep-21 (CTTL, No.J21X08326) | Sep-22 |
| Reference Probe EX3DV4 | SN 7307 | 26-May-21(SPEAG,No.EX3-7307_May21) | May-22 |
| DAE4 | SN 1556 | 12-Jan-22(CTTL-SPEAG,No.Z22-60007) | Jan-23 |
| Secondary Standards | ID # | Cal Date (Calibrated by, Certificate No.) | Scheduled Calibration |
| Signal Generator E4438C | MY49071430 | 13-Jan-22 (CTTL, No.J22X00409) | Jan-23 |
| Network Analyzer E5071C | MY46110673 | 14-Jan-22 (CTTL, No.J22X00406) | Jan-23 |

| | Name | Function | Signature |
|----------------|-------------|--------------------|---|
| Calibrated by: | Zhao Jing | SAR Test Engineer |  |
| Reviewed by: | Lin Hao | SAR Test Engineer |  |
| Approved by: | Qi Dianyuan | SAR Project Leader |  |

Issued: May 13, 2022

This calibration certificate shall not be reproduced except in full without written approval of the laboratory.



Add: No.52 HuaYuanBei Road, Haidian District, Beijing, 100191, China
Tel: +86-10-62304633-2117
E-mail: cttl@chinattl.com <http://www.caict.ac.cn>

Glossary:

| | |
|-------|--|
| TSL | tissue simulating liquid |
| ConvF | sensitivity in TSL / NORM _{x,y,z} |
| N/A | not applicable or not measured |

Calibration is Performed According to the Following Standards:

- a) IEC/IEEE 62209-1528, "Measurement Procedure for The Assessment of Specific Absorption Rate of Human Exposure to Radio Frequency Fields from Hand-held and Body-mounted Wireless Communication Devices- Part 1528: Human Models, Instrumentation and Procedures (Frequency range of 4 MHz to 10 GHz)", October 2020
- b) KDB 865664, "SAR Measurement Requirements for 100 MHz to 6 GHz"

Additional Documentation:

- c) DASY4/5 System Handbook

Methods Applied and Interpretation of Parameters:

- *Measurement Conditions:* Further details are available from the Validation Report at the end of the certificate. All figures stated in the certificate are valid at the frequency indicated.
- *Antenna Parameters with TSL:* The dipole is mounted with the spacer to position its feed point exactly below the center marking of the flat phantom section, with the arms oriented parallel to the body axis.
- *Feed Point Impedance and Return Loss:* These parameters are measured with the dipole positioned under the liquid filled phantom. The impedance stated is transformed from the measurement at the SMA connector to the feed point. The Return Loss ensures low reflected power. No uncertainty required.
- *Electrical Delay:* One-way delay between the SMA connector and the antenna feed point. No uncertainty required.
- *SAR measured:* SAR measured at the stated antenna input power.
- *SAR normalized:* SAR as measured, normalized to an input power of 1 W at the antenna connector.
- *SAR for nominal TSL parameters:* The measured TSL parameters are used to calculate the nominal SAR result.

The reported uncertainty of measurement is stated as the standard uncertainty of Measurement multiplied by the coverage factor $k=2$, which for a normal distribution Corresponds to a coverage probability of approximately 95%.



Add: No.52 HuaYuanBei Road, Haidian District, Beijing, 100191, China
Tel: +86-10-62304633-2117
E-mail: cttl@chinattl.com <http://www.caict.ac.cn>

Measurement Conditions

DASY system configuration, as far as not given on page 1.

| | | |
|------------------------------|----------------------------|----------------------------------|
| DASY Version | DASY52 | 52.10.4 |
| Extrapolation | Advanced Extrapolation | |
| Phantom | Triple Flat Phantom 5.1C | |
| Distance Dipole Center - TSL | 10 mm | with Spacer |
| Zoom Scan Resolution | dx, dy = 4 mm, dz = 1.4 mm | Graded Ratio = 1.4 (Z direction) |
| Frequency | 3500 MHz \pm 1 MHz | |

Head TSL parameters

The following parameters and calculations were applied.

| | Temperature | Permittivity | Conductivity |
|---|---------------------|----------------|----------------------|
| Nominal Head TSL parameters | 22.0 °C | 37.9 | 2.91 mho/m |
| Measured Head TSL parameters | (22.0 \pm 0.2) °C | 38.1 \pm 6 % | 2.92 mho/m \pm 6 % |
| Head TSL temperature change during test | <1.0 °C | --- | --- |

SAR result with Head TSL

| | | |
|---|--------------------|--|
| SAR averaged over 1 cm³ (1 g) of Head TSL | Condition | |
| SAR measured | 100 mW input power | 6.62 W/kg |
| SAR for nominal Head TSL parameters | normalized to 1W | 66.2 W/kg \pm 24.4 % (k=2) |
| SAR averaged over 10 cm³ (10 g) of Head TSL | Condition | |
| SAR measured | 100 mW input power | 2.55 W/kg |
| SAR for nominal Head TSL parameters | normalized to 1W | 25.5 W/kg \pm 24.2 % (k=2) |



Add: No.52 HuaYuanBei Road, Haidian District, Beijing, 100191, China
 Tel: +86-10-62304633-2117
 E-mail: cttl@chinattl.com <http://www.caict.ac.cn>

Appendix (Additional assessments outside the scope of CNAS L0570)

Antenna Parameters with Head TSL

| | |
|--------------------------------------|---------------|
| Impedance, transformed to feed point | 55.1Ω- 6.03jΩ |
| Return Loss | - 22.5dB |

General Antenna Parameters and Design

| | |
|----------------------------------|----------|
| Electrical Delay (one direction) | 1.046 ns |
|----------------------------------|----------|

After long term use with 100W radiated power, only a slight warming of the dipole near the feed-point can be measured.

The dipole is made of standard semirigid coaxial cable. The center conductor of the feeding line is directly connected to the second arm of the dipole. The antenna is therefore short-circuited for DC-signals. On some of the dipoles, small end caps are added to the dipole arms in order to improve matching when loaded according to the position as explained in the "Measurement Conditions" paragraph. The SAR data are not affected by this change. The overall dipole length is still according to the Standard. No excessive force must be applied to the dipole arms, because they might bend or the soldered connections near the feed-point may be damaged.

Additional EUT Data

| | |
|-----------------|-------|
| Manufactured by | SPEAG |
|-----------------|-------|

Add: No.52 HuaYuanBei Road, Haidian District, Beijing, 100191, China
Tel: +86-10-62304633-2117
E-mail: cttl@chinattl.com <http://www.caict.ac.cn>

DASY5 Validation Report for Head TSL

Date: 2022-05-09

Test Laboratory: CTTL, Beijing, China

DUT: Dipole 3500 MHz; Type: D3500V2; Serial: D3500V2 - SN: 1076

Communication System: UID 0, CW; Frequency: 3500 MHz; Duty Cycle: 1:1

Medium parameters used: $f = 3500$ MHz; $\sigma = 2.924$ S/m; $\epsilon_r = 38.1$; $\rho = 1000$ kg/m³

Phantom section: Right Section

Measurement Standard: DASY5 (IEEE/IEC/ANSI C63.19-2007)

DASY5 Configuration:

- Probe: EX3DV4 - SN7307; ConvF(6.87, 6.87, 6.87) @ 3500 MHz; Calibrated: 2021-05-26
- Sensor-Surface: 1.4mm (Mechanical Surface Detection)
- Electronics: DAE4 Sn1556; Calibrated: 2022-01-12
- Phantom: MFP_V5.1C (20deg probe tilt); Type: QD 000 P51 Cx; Serial: 1062
- DASY52 52.10.4(1535); SEMCAD X 14.6.14(7501)

Dipole Calibration /Pin=100mW, d=10mm, f=3500 MHz/Zoom Scan,

dist=1.4mm (8x8x7)/Cube 0: Measurement grid: dx=4mm, dy=4mm, dz=1.4mm

Reference Value = 62.00 V/m; Power Drift = -0.02 dB

Peak SAR (extrapolated) = 16.9 W/kg

SAR(1 g) = 6.62 W/kg; SAR(10 g) = 2.55 W/kg

Smallest distance from peaks to all points 3 dB below = 8 mm

Ratio of SAR at M2 to SAR at M1 = 76.4%

Maximum value of SAR (measured) = 12.1 W/kg

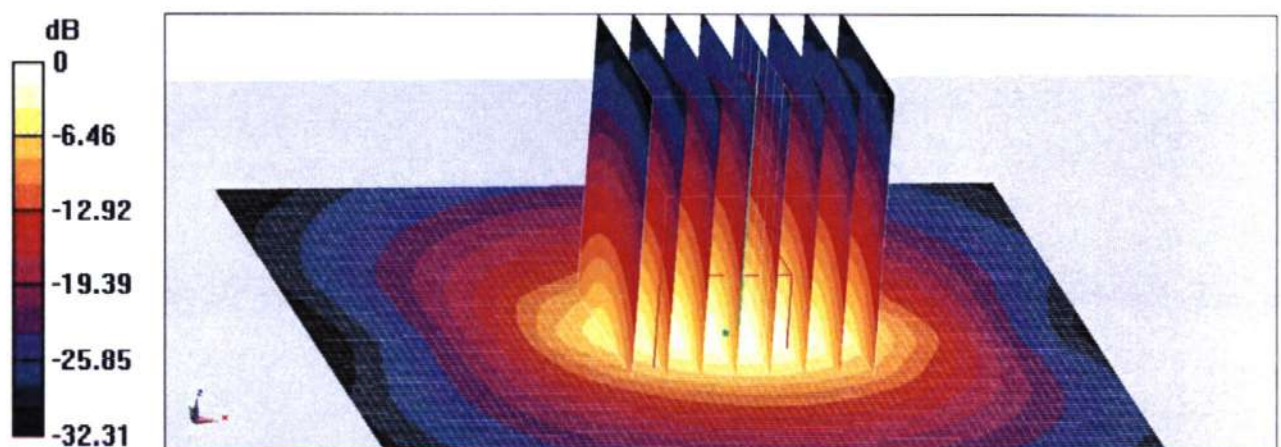

0 dB = 12.1 W/kg = 10.83 dBW/kg



Add: No.52 HuaYuanBei Road, Haidian District, Beijing, 100191, China
Tel: +86-10-62304633-2117
E-mail: cttl@chinattl.com <http://www.caict.ac.cn>

Impedance Measurement Plot for Head TSL

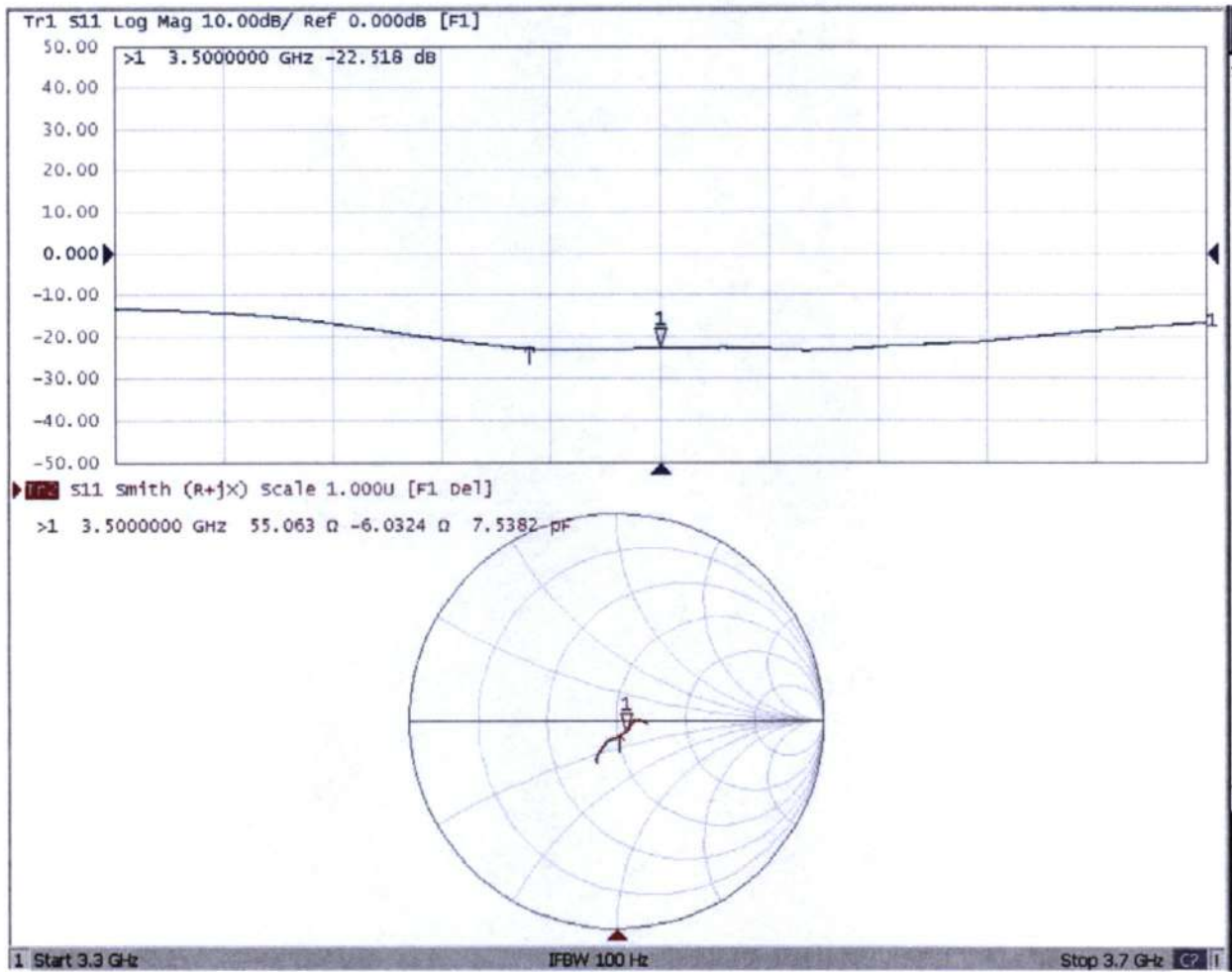



D3500V2, Serial No. 1076 Extended Dipole Calibrations

if dipoles are verified in return loss ($< -20\text{dB}$, within 20% of prior calibration), and in impedance (within 5 ohm of prior calibration), the annual calibration is not necessary and the calibration interval can be extended.

| D3500V2 – serial no. 1076 | | | | | | |
|---------------------------|------------------|-----------|----------------------|-------------|---------------------------|-------------|
| 3500 Head | | | | | | |
| Date of Measurement | Return-Loss (dB) | Delta (%) | Real Impedance (ohm) | Delta (ohm) | Imaginary Impedance (ohm) | Delta (ohm) |
| 2022.5.9 | -22.5 | | 55.1 | | -6 | |
| 2023.5.8 | -22.9 | 1.8% | 54.7 | 0.4 | -5.8 | -0.2 |
| | | | | | | |

<Justification of the extended calibration>

The return loss is $< -20\text{dB}$, within 20% of prior calibration; the impedance is within 5 ohm of prior calibration. Therefore the verification result should support extended calibration.

Dipole Verification Data> D3500V2, serial no. 1076

3500MHz - Head----2023.5.8

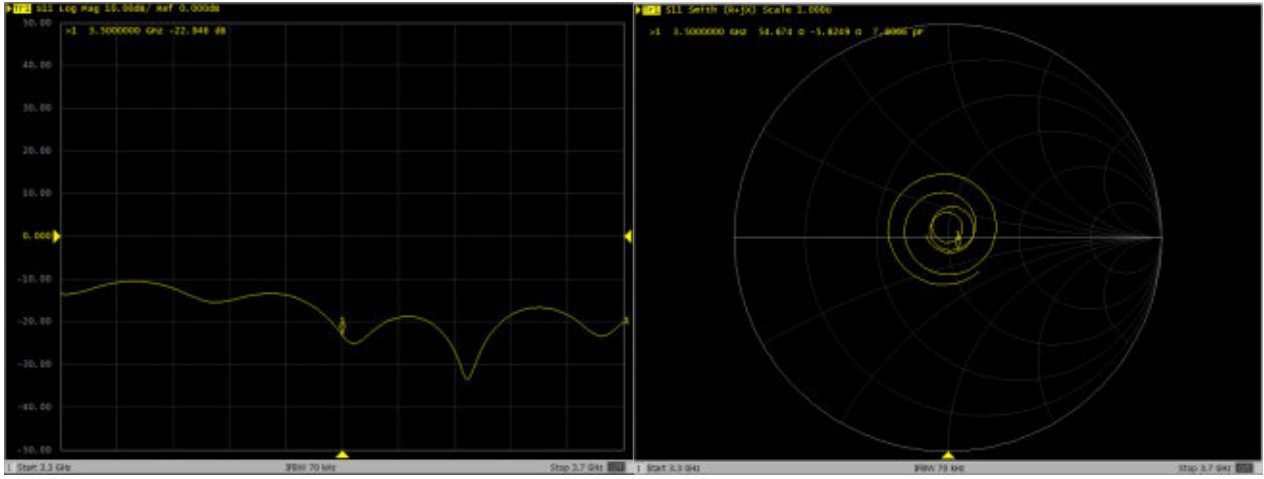

Client

Sporton

Certificate No:

Z22-60146

CALIBRATION CERTIFICATE

Object **D3700V2 - SN: 1037**

Calibration Procedure(s)
FF-Z11-003-01
Calibration Procedures for dipole validation kits

Calibration date: **May 9, 2022**

This calibration Certificate documents the traceability to national standards, which realize the physical units of measurements (SI). The measurements and the uncertainties with confidence probability are given on the following pages and are part of the certificate.

All calibrations have been conducted in the closed laboratory facility: environment temperature (22±3)°C and humidity<70%.

Calibration Equipment used (M&TE critical for calibration)

| Primary Standards | ID # | Cal Date (Calibrated by, Certificate No.) | Scheduled Calibration |
|-------------------------|------------|---|-----------------------|
| Power Meter NRP2 | 106277 | 24-Sep-21 (CTTL, No.J21X08326) | Sep-22 |
| Power sensor NRP8S | 104291 | 24-Sep-21 (CTTL, No.J21X08326) | Sep-22 |
| Reference Probe EX3DV4 | SN 7307 | 26-May-21(SPEAG,No.EX3-7307_May21) | May-22 |
| DAE4 | SN 1556 | 12-Jan-22(CTTL-SPEAG,No.Z22-60007) | Jan-23 |
| Secondary Standards | ID # | Cal Date (Calibrated by, Certificate No.) | Scheduled Calibration |
| Signal Generator E4438C | MY49071430 | 13-Jan-22 (CTTL, No.J22X00409) | Jan-23 |
| Network Analyzer E5071C | MY46110673 | 14-Jan-22 (CTTL, No.J22X00406) | Jan-23 |

| | Name | Function | Signature |
|----------------|-------------|--------------------|---|
| Calibrated by: | Zhao Jing | SAR Test Engineer |  |
| Reviewed by: | Lin Hao | SAR Test Engineer |  |
| Approved by: | Qi Dianyuan | SAR Project Leader |  |

Issued: May 13, 2022

This calibration certificate shall not be reproduced except in full without written approval of the laboratory.



Glossary:

| | |
|-------|--|
| TSL | tissue simulating liquid |
| ConvF | sensitivity in TSL / NORM _{x,y,z} |
| N/A | not applicable or not measured |

Calibration is Performed According to the Following Standards:

- a) IEC/IEEE 62209-1528, "Measurement Procedure for The Assessment of Specific Absorption Rate of Human Exposure to Radio Frequency Fields from Hand-held and Body-mounted Wireless Communication Devices- Part 1528: Human Models, Instrumentation and Procedures (Frequency range of 4 MHz to 10 GHz)", October 2020
- b) KDB 865664, "SAR Measurement Requirements for 100 MHz to 6 GHz"

Additional Documentation:

- c) DASY4/5 System Handbook

Methods Applied and Interpretation of Parameters:

- *Measurement Conditions:* Further details are available from the Validation Report at the end of the certificate. All figures stated in the certificate are valid at the frequency indicated.
- *Antenna Parameters with TSL:* The dipole is mounted with the spacer to position its feed point exactly below the center marking of the flat phantom section, with the arms oriented parallel to the body axis.
- *Feed Point Impedance and Return Loss:* These parameters are measured with the dipole positioned under the liquid filled phantom. The impedance stated is transformed from the measurement at the SMA connector to the feed point. The Return Loss ensures low reflected power. No uncertainty required.
- *Electrical Delay:* One-way delay between the SMA connector and the antenna feed point. No uncertainty required.
- *SAR measured:* SAR measured at the stated antenna input power.
- *SAR normalized:* SAR as measured, normalized to an input power of 1 W at the antenna connector.
- *SAR for nominal TSL parameters:* The measured TSL parameters are used to calculate the nominal SAR result.

The reported uncertainty of measurement is stated as the standard uncertainty of Measurement multiplied by the coverage factor $k=2$, which for a normal distribution Corresponds to a coverage probability of approximately 95%.



Add: No.52 HuaYuanBei Road, Haidian District, Beijing, 100191, China
Tel: +86-10-62304633-2117
E-mail: cttl@chinattl.com <http://www.caict.ac.cn>

Measurement Conditions

DASY system configuration, as far as not given on page 1.

| | | |
|------------------------------|----------------------------|----------------------------------|
| DASY Version | DASY52 | 52.10.4 |
| Extrapolation | Advanced Extrapolation | |
| Phantom | Triple Flat Phantom 5.1C | |
| Distance Dipole Center - TSL | 10 mm | with Spacer |
| Zoom Scan Resolution | dx, dy = 4 mm, dz = 1.4 mm | Graded Ratio = 1.4 (Z direction) |
| Frequency | 3700 MHz \pm 1 MHz | |

Head TSL parameters at 3700MHz

The following parameters and calculations were applied.

| | Temperature | Permittivity | Conductivity |
|---|---------------------|----------------|----------------------|
| Nominal Head TSL parameters | 22.0 °C | 37.7 | 3.12 mho/m |
| Measured Head TSL parameters | (22.0 \pm 0.2) °C | 37.1 \pm 6 % | 3.11 mho/m \pm 6 % |
| Head TSL temperature change during test | <1.0 °C | --- | --- |

SAR result with Head TSL at 3700MHz

| | | |
|---|--------------------|--|
| SAR averaged over 1 cm³ (1 g) of Head TSL | Condition | |
| SAR measured | 100 mW input power | 6.69 W/kg |
| SAR for nominal Head TSL parameters | normalized to 1W | 66.7 W/kg \pm 24.4 % (k=2) |
| SAR averaged over 10 cm³ (10 g) of Head TSL | Condition | |
| SAR measured | 100 mW input power | 2.47 W/kg |
| SAR for nominal Head TSL parameters | normalized to 1W | 24.6 W/kg \pm 24.2 % (k=2) |



Add: No.52 HuaYuanBei Road, Haidian District, Beijing, 100191, China
Tel: +86-10-62304633-2117
E-mail: cttl@chinattl.com <http://www.caict.ac.cn>

Appendix (Additional assessments outside the scope of CNAS L0570)

Antenna Parameters with Head TSL at 3700MHz

| | |
|--------------------------------------|---------------|
| Impedance, transformed to feed point | 46.2Ω+ 0.31jΩ |
| Return Loss | - 28.1dB |

General Antenna Parameters and Design

| | |
|----------------------------------|----------|
| Electrical Delay (one direction) | 1.048 ns |
|----------------------------------|----------|

After long term use with 100W radiated power, only a slight warming of the dipole near the feed-point can be measured.

The dipole is made of standard semirigid coaxial cable. The center conductor of the feeding line is directly connected to the second arm of the dipole. The antenna is therefore short-circuited for DC-signals. On some of the dipoles, small end caps are added to the dipole arms in order to improve matching when loaded according to the position as explained in the "Measurement Conditions" paragraph. The SAR data are not affected by this change. The overall dipole length is still according to the Standard. No excessive force must be applied to the dipole arms, because they might bend or the soldered connections near the feed-point may be damaged.

Additional EUT Data

| | |
|-----------------|-------|
| Manufactured by | SPEAG |
|-----------------|-------|

Add: No.52 HuaYuanBei Road, Haidian District, Beijing, 100191, China
 Tel: +86-10-62304633-2117
 E-mail: cttl@chinattl.com <http://www.caict.ac.cn>

Date: 2022-05-09

DASY5 Validation Report for Head TSL

Test Laboratory: CTTL, Beijing, China

DUT: Dipole 3700 MHz; Type: D3700V2; Serial: D3700V2 - SN: 1037

Communication System: UID 0, CW; Frequency: 3700 MHz; Duty Cycle: 1:1

Medium parameters used: $f = 3700$ MHz; $\sigma = 3.106$ S/m; $\epsilon_r = 37.12$; $\rho = 1000$ kg/m³

Phantom section: Right Section

Measurement Standard: DASY5 (IEEE/IEC/ANSI C63.19-2007)

DASY5 Configuration:

- Probe: EX3DV4 - SN7307; ConvF(6.73, 6.73, 6.73) @ 3700 MHz; Calibrated: 2021-05-26
- Sensor-Surface: 1.4mm (Mechanical Surface Detection)
- Electronics: DAE4 Sn1556; Calibrated: 2022-01-12
- Phantom: MFP_V5.1C (20deg probe tilt); Type: QD 000 P51 Cx; Serial: 1062
- DASY52 52.10.4(1535); SEMCAD X 14.6.14(7501)

Dipole Calibration /Pin=100mW, d=10mm, f=3700 MHz/Zoom Scan, dist=1.4mm (8x8x7)/Cube 0: Measurement grid: dx=4mm, dy=4mm, dz=1.4mm
 Reference Value = 62.62 V/m; Power Drift = -0.05 dB
 Peak SAR (extrapolated) = 18.1 W/kg
SAR(1 g) = 6.69 W/kg; SAR(10 g) = 2.47 W/kg
 Smallest distance from peaks to all points 3 dB below = 8 mm
 Ratio of SAR at M2 to SAR at M1 = 75%
 Maximum value of SAR (measured) = 12.6 W/kg

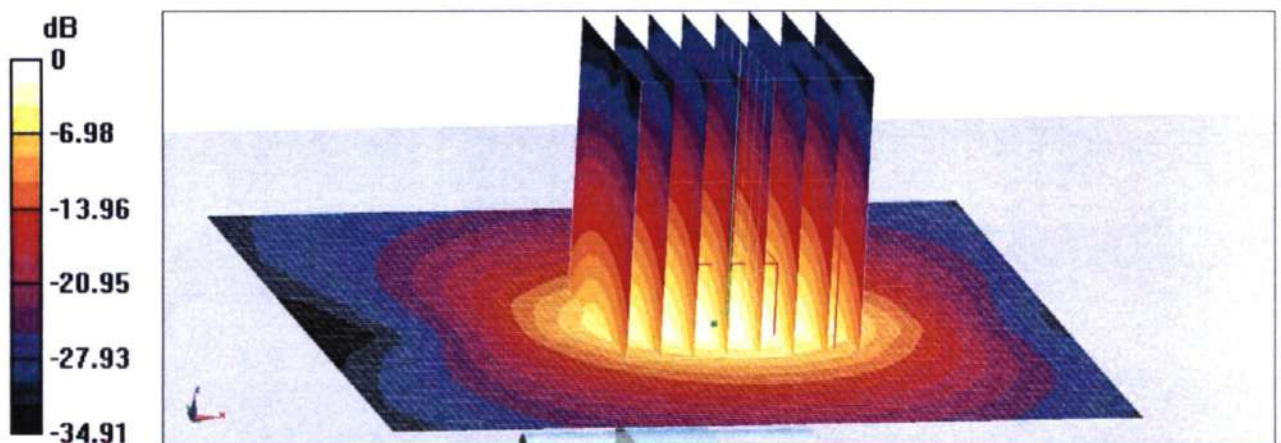

0 dB = 12.6 W/kg = 11.00 dBW/kg



Add: No.52 HuaYuanBei Road, Haidian District, Beijing, 100191, China
Tel: +86-10-62304633-2117
E-mail: cttl@chinattl.com <http://www.caict.ac.cn>

Impedance Measurement Plot for Head TSL

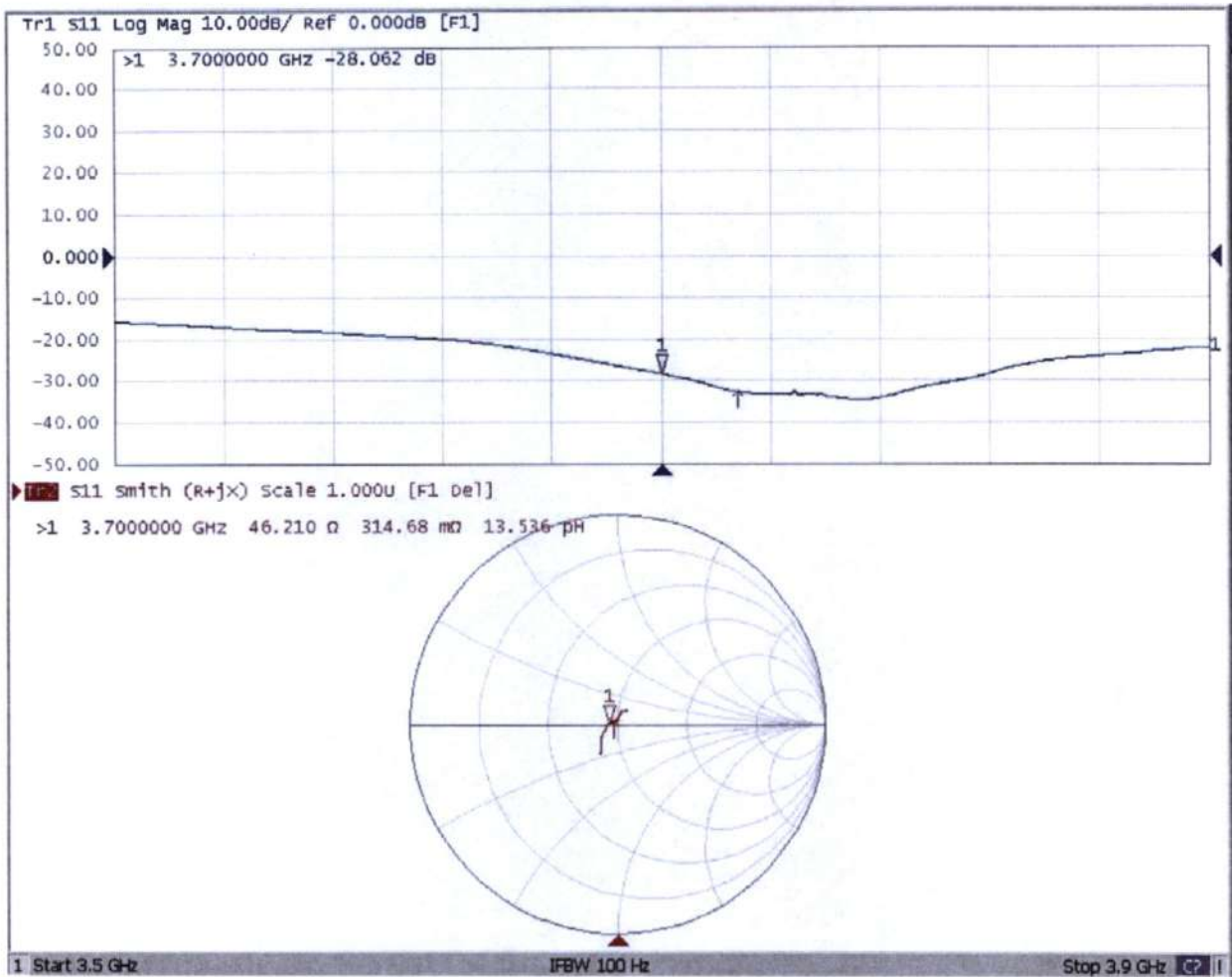



D3700V2, Serial No. 1037 Extended Dipole Calibrations

if dipoles are verified in return loss ($< -20\text{dB}$, within 20% of prior calibration), and in impedance (within 5 ohm of prior calibration), the annual calibration is not necessary and the calibration interval can be extended.

| D3700V2 – serial no. 1037 | | | | | | |
|---------------------------|------------------|-----------|----------------------|-------------|---------------------------|-------------|
| 3700 Head | | | | | | |
| Date of Measurement | Return-Loss (dB) | Delta (%) | Real Impedance (ohm) | Delta (ohm) | Imaginary Impedance (ohm) | Delta (ohm) |
| 2022.5.9 | -28.1 | | 46.2 | | 0.3 | |
| 2023.5.8 | -26.7 | -5.0% | 48.9 | -2.7 | -0.3 | 0.6 |
| | | | | | | |

<Justification of the extended calibration>

The return loss is $< -20\text{dB}$, within 20% of prior calibration; the impedance is within 5 ohm of prior calibration. Therefore the verification result should support extended calibration.

Dipole Verification Data> D3700V2, serial no. 1037

3700MHz - Head----2023.5.8

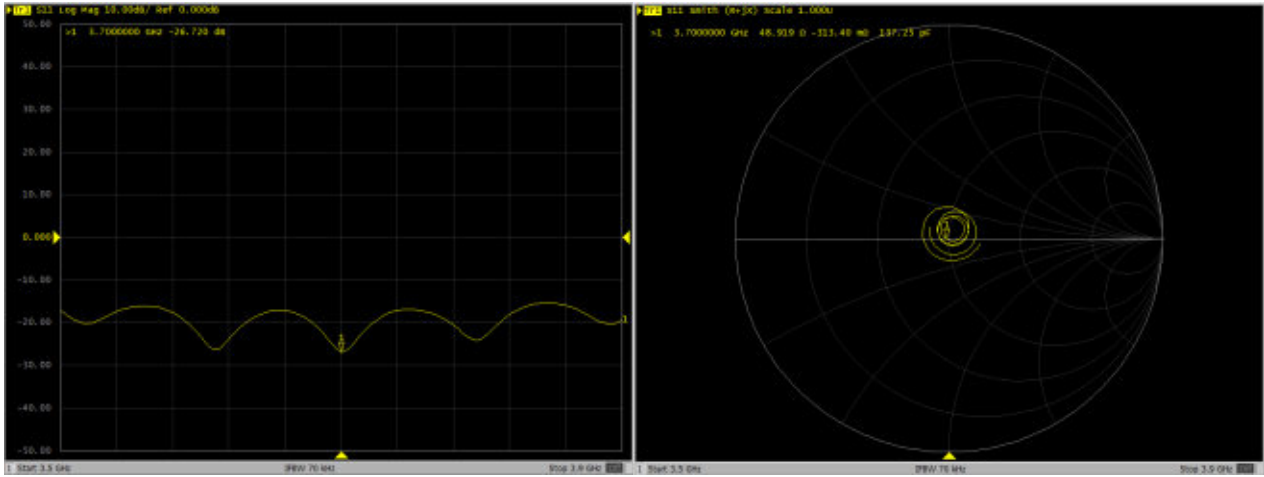

Add: No.52 HuaYuanBei Road, Haidian District, Beijing, 100191
Tel: +86-10-62304633-2117
E-mail: emf@caict.ac.cn http://www.caict.ac.cn

Client **Sporton**

Certificate No: **Z22-60287**

CALIBRATION CERTIFICATE

Object **D3900V2 - SN: 1022**

Calibration Procedure(s) **FF-Z11-003-01**
Calibration Procedures for dipole validation kits



Calibration date: **August 18, 2022**

This calibration Certificate documents the traceability to national standards, which realize the physical units of measurements (SI). The measurements and the uncertainties with confidence probability are given on the following pages and are part of the certificate.

All calibrations have been conducted in the closed laboratory facility: environment temperature (22±3)°C and humidity<70%.

Calibration Equipment used (M&TE critical for calibration)

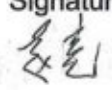
| Primary Standards | ID # | Cal Date (Calibrated by, Certificate No.) | Scheduled Calibration |
|-------------------------|------------|---|-----------------------|
| Power Meter NRP2 | 106277 | 24-Sep-21 (CTTL, No.J21X08326) | Sep-22 |
| Power sensor NRP8S | 104291 | 24-Sep-21 (CTTL, No.J21X08326) | Sep-22 |
| Reference Probe EX3DV4 | SN 7464 | 26-Jan-22(SPEAG,No.EX3-7464_Jan22) | Jan-23 |
| DAE4 | SN 1556 | 12-Jan-22(CTTL-SPEAG,No.Z22-60007) | Jan-23 |
| Secondary Standards | ID # | Cal Date (Calibrated by, Certificate No.) | Scheduled Calibration |
| Signal Generator E4438C | MY49071430 | 13-Jan-22 (CTTL, No.J22X00409) | Jan-23 |
| Network Analyzer E5071C | MY46110673 | 14-Jan-22 (CTTL, No.J22X00406) | Jan-23 |

| | Name | Function | Signature |
|----------------|-------------|--------------------|---|
| Calibrated by: | Zhao Jing | SAR Test Engineer |  |
| Reviewed by: | Lin Hao | SAR Test Engineer |  |
| Approved by: | Qi Dianyuan | SAR Project Leader |  |

Issued: August 23, 2022

This calibration certificate shall not be reproduced except in full without written approval of the laboratory.



Glossary:

| | |
|-------|--|
| TSL | tissue simulating liquid |
| ConvF | sensitivity in TSL / NORM _{x,y,z} |
| N/A | not applicable or not measured |

Calibration is Performed According to the Following Standards:

- IEC/IEEE 62209-1528, "Measurement Procedure for The Assessment of Specific Absorption Rate of Human Exposure to Radio Frequency Fields from Hand-held and Body-mounted Wireless Communication Devices- Part 1528: Human Models, Instrumentation and Procedures (Frequency range of 4 MHz to 10 GHz)", October 2020
- KDB 865664, "SAR Measurement Requirements for 100 MHz to 6 GHz"

Additional Documentation:

- DASY4/5 System Handbook

Methods Applied and Interpretation of Parameters:

- Measurement Conditions:** Further details are available from the Validation Report at the end of the certificate. All figures stated in the certificate are valid at the frequency indicated.
- Antenna Parameters with TSL:** The dipole is mounted with the spacer to position its feed point exactly below the center marking of the flat phantom section, with the arms oriented parallel to the body axis.
- Feed Point Impedance and Return Loss:** These parameters are measured with the dipole positioned under the liquid filled phantom. The impedance stated is transformed from the measurement at the SMA connector to the feed point. The Return Loss ensures low reflected power. No uncertainty required.
- Electrical Delay:** One-way delay between the SMA connector and the antenna feed point. No uncertainty required.
- SAR measured:** SAR measured at the stated antenna input power.
- SAR normalized:** SAR as measured, normalized to an input power of 1 W at the antenna connector.
- SAR for nominal TSL parameters:** The measured TSL parameters are used to calculate the nominal SAR result.

The reported uncertainty of measurement is stated as the standard uncertainty of Measurement multiplied by the coverage factor $k=2$, which for a normal distribution Corresponds to a coverage probability of approximately 95%.



Add: No.52 HuaYuanBei Road, Haidian District, Beijing, 100191, China
Tel: +86-10-62304633-2117
E-mail: cmf@caict.ac.cn <http://www.caict.ac.cn>

Measurement Conditions

DASY system configuration, as far as not given on page 1.

| | | |
|-------------------------------------|----------------------------|----------------------------------|
| DASY Version | DASY52 | 52.10.4 |
| Extrapolation | Advanced Extrapolation | |
| Phantom | Triple Flat Phantom 5.1C | |
| Distance Dipole Center - TSL | 10 mm | with Spacer |
| Zoom Scan Resolution | dx, dy = 4 mm, dz = 1.4 mm | Graded Ratio = 1.4 (Z direction) |
| Frequency | 3900 MHz \pm 1 MHz | |

Head TSL parameters at 3900MHz

The following parameters and calculations were applied.

| | Temperature | Permittivity | Conductivity |
|--|---------------------|----------------|----------------------|
| Nominal Head TSL parameters | 22.0 °C | 37.5 | 3.32 mho/m |
| Measured Head TSL parameters | (22.0 \pm 0.2) °C | 38.3 \pm 6 % | 3.34 mho/m \pm 6 % |
| Head TSL temperature change during test | <1.0 °C | --- | --- |

SAR result with Head TSL at 3900MHz

| | | |
|---|--------------------|--|
| SAR averaged over 1 cm³ (1 g) of Head TSL | Condition | |
| SAR measured | 100 mW input power | 6.62 W/kg |
| SAR for nominal Head TSL parameters | normalized to 1W | 66.4 W/kg \pm 24.4 % (k=2) |
| SAR averaged over 10 cm³ (10 g) of Head TSL | Condition | |
| SAR measured | 100 mW input power | 2.36 W/kg |
| SAR for nominal Head TSL parameters | normalized to 1W | 23.7 W/kg \pm 24.2 % (k=2) |



Add: No.52 HuaYuanBei Road, Haidian District, Beijing, 100191, China
Tel: +86-10-62304633-2117
E-mail: emf@caict.ac.cn <http://www.caict.ac.cn>

Appendix (Additional assessments outside the scope of CNAS L0570)

Antenna Parameters with Head TSL at 3900MHz

| | |
|--------------------------------------|--------------------------------|
| Impedance, transformed to feed point | 47.1 Ω - 5.11j Ω |
| Return Loss | - 24.4dB |

General Antenna Parameters and Design

| | |
|----------------------------------|----------|
| Electrical Delay (one direction) | 1.010 ns |
|----------------------------------|----------|

After long term use with 100W radiated power, only a slight warming of the dipole near the feed-point can be measured.

The dipole is made of standard semirigid coaxial cable. The center conductor of the feeding line is directly connected to the second arm of the dipole. The antenna is therefore short-circuited for DC-signals. On some of the dipoles, small end caps are added to the dipole arms in order to improve matching when loaded according to the position as explained in the "Measurement Conditions" paragraph. The SAR data are not affected by this change. The overall dipole length is still according to the Standard. No excessive force must be applied to the dipole arms, because they might bend or the soldered connections near the feed-point may be damaged.

Additional EUT Data

| | |
|-----------------|-------|
| Manufactured by | SPEAG |
|-----------------|-------|

Add: No.52 HuaYuanBei Road, Haidian District, Beijing, 100191, China
Tel: +86-10-62304633-2117
E-mail: emf@caict.ac.cn <http://www.caict.ac.cn>

DASY5 Validation Report for Head TSL

Date: 2022-08-18

Test Laboratory: CTTL, Beijing, China

DUT: Dipole 3900 MHz; Type: D3900V2; Serial: D3900V2 - SN: 1022

Communication System: UID 0, CW; Frequency: 3900 MHz; Duty Cycle: 1:1

Medium parameters used: $f = 3900$ MHz; $\sigma = 3.34$ S/m; $\epsilon_r = 38.29$; $\rho = 1000$ kg/m³

Phantom section: Right Section

Measurement Standard: DASY5 (IEEE/IEC/ANSI C63.19-2007)

DASY5 Configuration:

- Probe: EX3DV4 - SN7464; ConvF(6.76, 6.76, 6.76) @ 3900 MHz; Calibrated: 2022-01-26
- Sensor-Surface: 1.4mm (Mechanical Surface Detection)
- Electronics: DAE4 Sn1556; Calibrated: 2022-01-12
- Phantom: MFP_V5.1C (20deg probe tilt); Type: QD 000 P51 Cx; Serial: 1062
- DASY52 52.10.4(1535); SEMCAD X 14.6.14(7501)

Dipole Calibration /Pin=100mW, d=10mm, f=3900 MHz/Zoom Scan, dist=1.4mm (8x8x7)/Cube 0: Measurement grid: dx=4mm, dy=4mm, dz=1.4mm
Reference Value = 64.46 V/m; Power Drift = -0.07 dB
Peak SAR (extrapolated) = 17.4 W/kg
SAR(1 g) = 6.62 W/kg; SAR(10 g) = 2.36 W/kg
Smallest distance from peaks to all points 3 dB below = 8 mm
Ratio of SAR at M2 to SAR at M1 = 76.5%
Maximum value of SAR (measured) = 12.6 W/kg

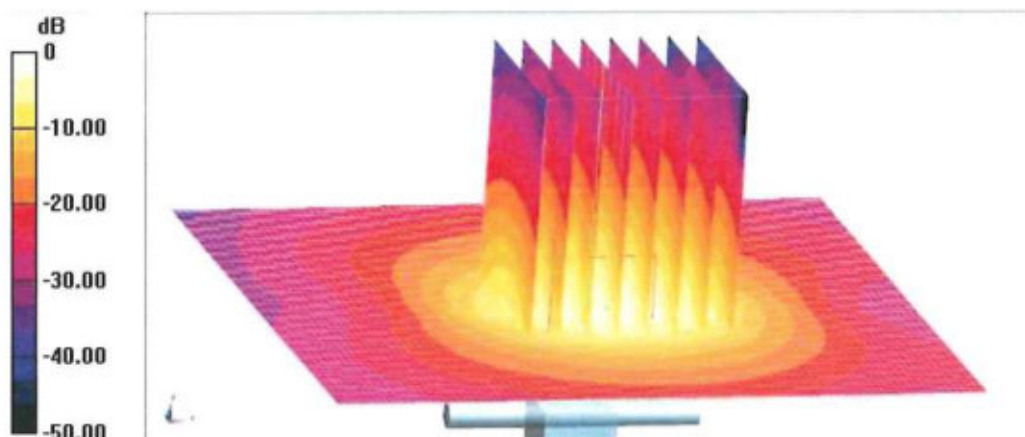

0 dB = 12.6 W/kg = 11.00 dBW/kg



Add: No.52 HuaYuanBei Road, Haidian District, Beijing, 100191, China
Tel: +86-10-62304633-2117
E-mail: emf@caict.ac.cn <http://www.caict.ac.cn>

Impedance Measurement Plot for Head TSL

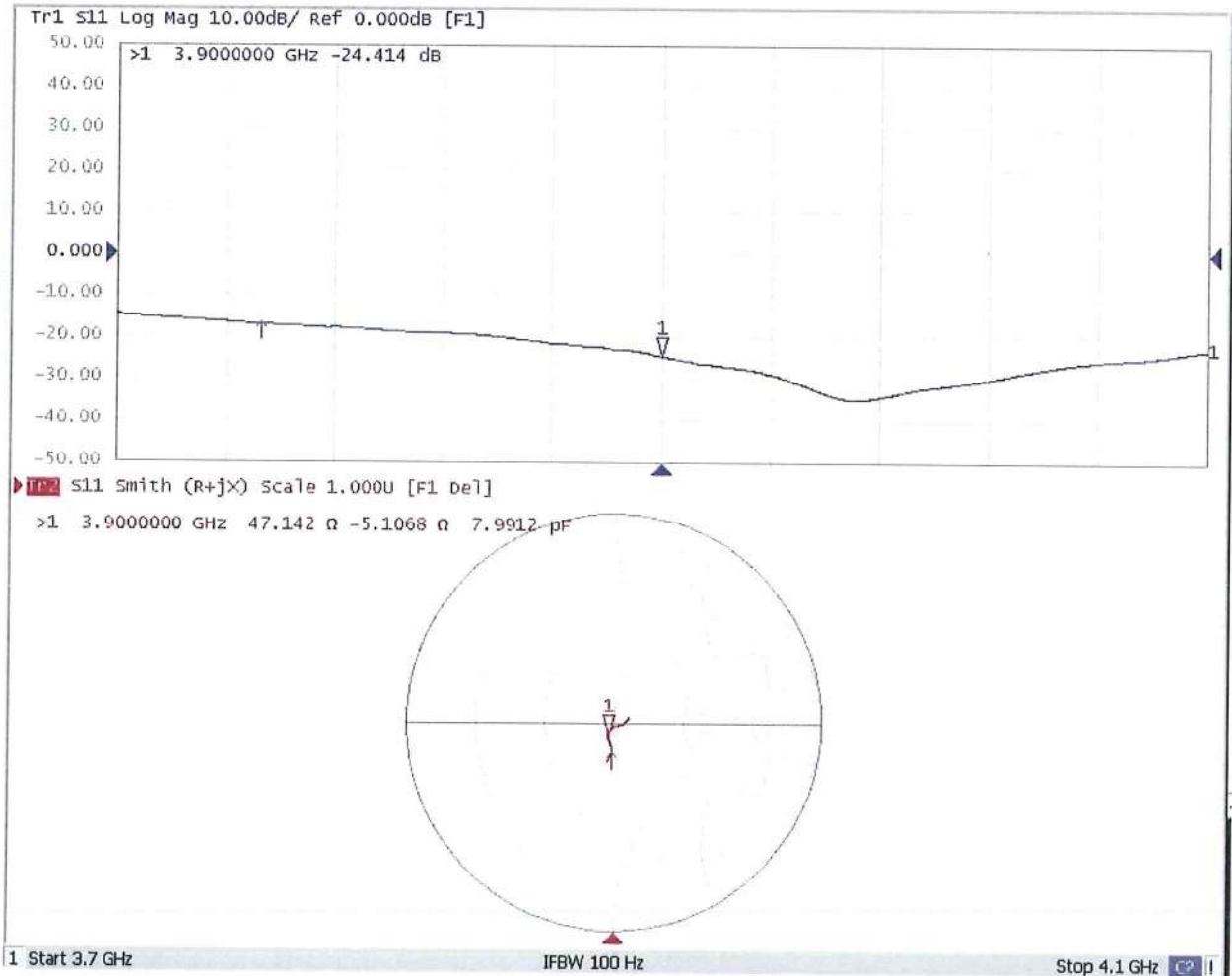



D3900V2, Serial No. 1022 Extended Dipole Calibrations

If dipoles are verified in return loss ($< -20\text{dB}$, within 20% of prior calibration), and in impedance (within 5 ohm of prior calibration), the annual calibration is not necessary and the calibration interval can be extended.

| D3900V2 – serial no. 1022 | | | | | | |
|---------------------------|------------------|-----------|----------------------|-------------|---------------------------|-------------|
| 3900 Head | | | | | | |
| Date of Measurement | Return-Loss (dB) | Delta (%) | Real Impedance (ohm) | Delta (ohm) | Imaginary Impedance (ohm) | Delta (ohm) |
| 2022.8.18 | -24.4 | | 47.1 | | -5.1 | |
| 2023.8.17 | -24.8 | 1.6% | 48.8 | -1.7 | -4.4 | -0.7 |

<Justification of the extended calibration>

The return loss is $< -20\text{dB}$, within 20% of prior calibration; the impedance is within 5 ohm of prior calibration. Therefore the verification result should support extended calibration.

Dipole Verification Data> D3900V2, serial no. 1022

3900MHz – Head----2023.8.17

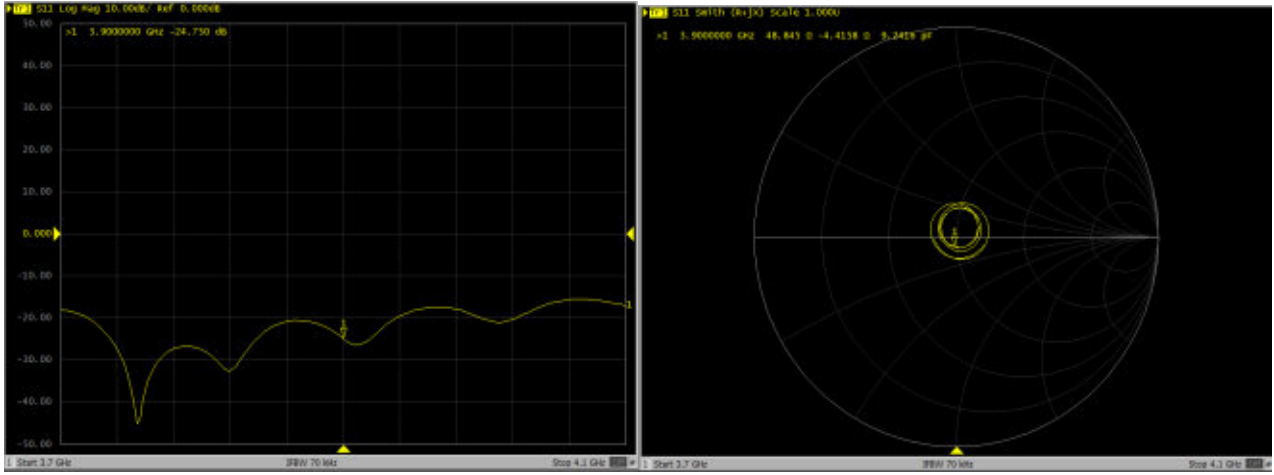



Accredited by the Swiss Accreditation Service (SAS)
The Swiss Accreditation Service is one of the signatories to the EA
Multilateral Agreement for the recognition of calibration certificates

Accreditation No.: **SCS 0108**

Client **Sporton**

Certificate No: **D5GHzV2-1341_Dec21**

CALIBRATION CERTIFICATE

Object **D5GHzV2 - SN:1341**

Calibration procedure(s) **QA CAL-22.v6
Calibration Procedure for SAR Validation Sources between 3-10 GHz**

Calibration date: **December 13, 2021**

This calibration certificate documents the traceability to national standards, which realize the physical units of measurements (SI).
The measurements and the uncertainties with confidence probability are given on the following pages and are part of the certificate.

All calibrations have been conducted in the closed laboratory facility: environment temperature (22 ± 3)°C and humidity < 70%.

Calibration Equipment used (M&TE critical for calibration)

| Primary Standards | ID # | Cal Date (Certificate No.) | Scheduled Calibration |
|---------------------------------|--------------------|-----------------------------------|------------------------|
| Power meter NRP | SN: 104778 | 09-Apr-21 (No. 217-03291/03292) | Apr-22 |
| Power sensor NRP-Z91 | SN: 103244 | 09-Apr-21 (No. 217-03291) | Apr-22 |
| Power sensor NRP-Z91 | SN: 103245 | 09-Apr-21 (No. 217-03292) | Apr-22 |
| Reference 20 dB Attenuator | SN: BH9394 (20k) | 09-Apr-21 (No. 217-03343) | Apr-22 |
| Type-N mismatch combination | SN: 310982 / 06327 | 09-Apr-21 (No. 217-03344) | Apr-22 |
| Reference Probe EX3DV4 | SN: 3503 | 30-Dec-20 (No. EX3-3503_Dec20) | Dec-21 |
| DAE4 | SN: 601 | 01-Nov-21 (No. DAE4-601_Nov21) | Nov-22 |
| Secondary Standards | ID # | Check Date (in house) | Scheduled Check |
| Power meter E4419B | SN: GB39512475 | 30-Oct-14 (in house check Oct-20) | In house check: Oct-22 |
| Power sensor HP 8481A | SN: US37292783 | 07-Oct-15 (in house check Oct-20) | In house check: Oct-22 |
| Power sensor HP 8481A | SN: MY41092317 | 07-Oct-15 (in house check Oct-20) | In house check: Oct-22 |
| RF generator R&S SMT-06 | SN: 100972 | 15-Jun-15 (in house check Oct-20) | In house check: Oct-22 |
| Network Analyzer Agilent E8358A | SN: US41080477 | 31-Mar-14 (in house check Oct-20) | In house check: Oct-22 |

Calibrated by: **Jeffrey Katzman** Function: **Laboratory Technician** Signature: 

Approved by: **Niels Kuster** Quality Manager

Issued: December 14, 2021

This calibration certificate shall not be reproduced except in full without written approval of the laboratory.



Accredited by the Swiss Accreditation Service (SAS)

The Swiss Accreditation Service is one of the signatories to the EA
Multilateral Agreement for the recognition of calibration certificates

Accreditation No.: **SCS 0108**

Glossary:

| | |
|-------|---------------------------------|
| TSL | tissue simulating liquid |
| ConvF | sensitivity in TSL / NORM x,y,z |
| N/A | not applicable or not measured |

Calibration is Performed According to the Following Standards:

- IEC/IEEE 62209-1528, "Measurement Procedure For The Assessment Of Specific Absorption Rate Of Human Exposure To Radio Frequency Fields From Hand-Held And Body-Worn Wireless Communication Devices - Part 1528: Human Models, Instrumentation And Procedures (Frequency Range of 4 MHz to 10 GHz)", October 2020.
- KDB 865664, "SAR Measurement Requirements for 100 MHz to 6 GHz"

Additional Documentation:

- DASY System Handbook

Methods Applied and Interpretation of Parameters:

- Measurement Conditions:* Further details are available from the Validation Report at the end of the certificate. All figures stated in the certificate are valid at the frequency indicated.
- Antenna Parameters with TSL:* The source is mounted in a touch configuration below the center marking of the flat phantom.
- Return Loss:* This parameter is measured with the source positioned under the liquid filled phantom (as described in the measurement condition clause). The Return Loss ensures low reflected power. No uncertainty required.
- SAR measured:* SAR measured at the stated antenna input power.
- SAR normalized:* SAR as measured, normalized to an input power of 1 W at the antenna connector.
- SAR for nominal TSL parameters:* The measured TSL parameters are used to calculate the nominal SAR result.

The reported uncertainty of measurement is stated as the standard uncertainty of measurement multiplied by the coverage factor $k=2$, which for a normal distribution corresponds to a coverage probability of approximately 95%.

Measurement Conditions

DASY system configuration, as far as not given on page 1.

| | | |
|-------------------------------------|--|----------------------------------|
| DASY Version | DASY52 | V52.10.4 |
| Extrapolation | Advanced Extrapolation | |
| Phantom | Modular Flat Phantom V5.0 | |
| Distance Dipole Center - TSL | 10 mm | with Spacer |
| Zoom Scan Resolution | dx, dy = 4.0 mm, dz = 1.4 mm | Graded Ratio = 1.4 (Z direction) |
| Frequency | 5250 MHz ± 1 MHz 5600 MHz ± 1 MHz 5750 MHz ± 1 MHz | |

Head TSL parameters at 5250 MHz

The following parameters and calculations were applied.

| | Temperature | Permittivity | Conductivity |
|--|-----------------|--------------|------------------|
| Nominal Head TSL parameters | 22.0 °C | 35.9 | 4.71 mho/m |
| Measured Head TSL parameters | (22.0 ± 0.2) °C | 34.9 ± 6 % | 4.56 mho/m ± 6 % |
| Head TSL temperature change during test | < 0.5 °C | ---- | ---- |

SAR result with Head TSL at 5250 MHz

| SAR averaged over 1 cm³ (1 g) of Head TSL | Condition | |
|---|--------------------|---------------------------------|
| SAR measured | 100 mW input power | 8.12 W/kg |
| SAR for nominal Head TSL parameters | normalized to 1W | 80.7 W/kg ± 19.9 % (k=2) |

| SAR averaged over 10 cm³ (10 g) of Head TSL | condition | |
|---|--------------------|---------------------------------|
| SAR measured | 100 mW input power | 2.33 W/kg |
| SAR for nominal Head TSL parameters | normalized to 1W | 23.1 W/kg ± 19.5 % (k=2) |

Head TSL parameters at 5600 MHz

The following parameters and calculations were applied.

| | Temperature | Permittivity | Conductivity |
|--|-----------------|--------------|------------------|
| Nominal Head TSL parameters | 22.0 °C | 35.5 | 5.07 mho/m |
| Measured Head TSL parameters | (22.0 ± 0.2) °C | 34.4 ± 6 % | 4.91 mho/m ± 6 % |
| Head TSL temperature change during test | < 0.5 °C | ---- | ---- |

SAR result with Head TSL at 5600 MHz

| SAR averaged over 1 cm³ (1 g) of Head TSL | Condition | |
|---|--------------------|---------------------------------|
| SAR measured | 100 mW input power | 8.52 W/kg |
| SAR for nominal Head TSL parameters | normalized to 1W | 84.5 W/kg ± 19.9 % (k=2) |

| SAR averaged over 10 cm³ (10 g) of Head TSL | condition | |
|---|--------------------|---------------------------------|
| SAR measured | 100 mW input power | 2.42 W/kg |
| SAR for nominal Head TSL parameters | normalized to 1W | 24.0 W/kg ± 19.5 % (k=2) |

Head TSL parameters at 5750 MHz

The following parameters and calculations were applied.

| | Temperature | Permittivity | Conductivity |
|---|-----------------|--------------|------------------|
| Nominal Head TSL parameters | 22.0 °C | 35.4 | 5.22 mho/m |
| Measured Head TSL parameters | (22.0 ± 0.2) °C | 34.2 ± 6 % | 5.06 mho/m ± 6 % |
| Head TSL temperature change during test | < 0.5 °C | ---- | ---- |

SAR result with Head TSL at 5750 MHz

| SAR averaged over 1 cm ³ (1 g) of Head TSL | Condition | |
|---|--------------------|---------------------------------|
| SAR measured | 100 mW input power | 8.13 W/kg |
| SAR for nominal Head TSL parameters | normalized to 1W | 80.6 W/kg ± 19.9 % (k=2) |

| SAR averaged over 10 cm ³ (10 g) of Head TSL | condition | |
|---|--------------------|---------------------------------|
| SAR measured | 100 mW input power | 2.29 W/kg |
| SAR for nominal Head TSL parameters | normalized to 1W | 22.7 W/kg ± 19.5 % (k=2) |

Appendix (Additional assessments outside the scope of SCS 0108)

Antenna Parameters with Head TSL at 5250 MHz

| | |
|--------------------------------------|--------------------------------|
| Impedance, transformed to feed point | 48.4 Ω + 0.1 j Ω |
| Return Loss | - 35.7 dB |

Antenna Parameters with Head TSL at 5600 MHz

| | |
|--------------------------------------|--------------------------------|
| Impedance, transformed to feed point | 53.8 Ω + 7.2 j Ω |
| Return Loss | - 22.2 dB |

Antenna Parameters with Head TSL at 5750 MHz

| | |
|--------------------------------------|--------------------------------|
| Impedance, transformed to feed point | 51.4 Ω + 5.0 j Ω |
| Return Loss | - 25.8 dB |

General Antenna Parameters and Design

| | |
|----------------------------------|----------|
| Electrical Delay (one direction) | 1.211 ns |
|----------------------------------|----------|

After long term use with 100W radiated power, only a slight warming of the dipole near the feedpoint can be measured.

The dipole is made of standard semirigid coaxial cable. The center conductor of the feeding line is directly connected to the second arm of the dipole. The antenna is therefore short-circuited for DC-signals. On some of the dipoles, small end caps are added to the dipole arms in order to improve matching when loaded according to the position as explained in the "Measurement Conditions" paragraph. The SAR data are not affected by this change. The overall dipole length is still according to the Standard.

No excessive force must be applied to the dipole arms, because they might bend or the soldered connections near the feedpoint may be damaged.

Additional EUT Data

| | |
|-----------------|-------|
| Manufactured by | SPEAG |
|-----------------|-------|

DASY5 Validation Report for Head TSL

Date: 13.12.2021

Test Laboratory: SPEAG, Zurich, Switzerland

DUT: Dipole D5GHzV2; Type: D5GHzV2; Serial: D5GHzV2 - SN:1341

Communication System: UID 0 - CW; Frequency: 5250 MHz, Frequency: 5600 MHz, Frequency: 5750 MHz

Medium parameters used: $f = 5250$ MHz; $\sigma = 4.56$ S/m; $\epsilon_r = 34.9$; $\rho = 1000$ kg/m³,

Medium parameters used: $f = 5600$ MHz; $\sigma = 4.91$ S/m; $\epsilon_r = 34.4$; $\rho = 1000$ kg/m³,

Medium parameters used: $f = 5750$ MHz; $\sigma = 5.06$ S/m; $\epsilon_r = 34.2$; $\rho = 1000$ kg/m³

Phantom section: Flat Section

Measurement Standard: DASY5 (IEEE/IEC/ANSI C63.19-2011)

DASY52 Configuration:

- Probe: EX3DV4 - SN3503; ConvF(5.5, 5.5, 5.5) @ 5250 MHz, ConvF(5.1, 5.1, 5.1) @ 5600 MHz, ConvF(5.08, 5.08, 5.08) @ 5750 MHz; Calibrated: 30.12.2020
- Sensor-Surface: 1.4mm (Mechanical Surface Detection)
- Electronics: DAE4 Sn601; Calibrated: 01.11.2021
- Phantom: Flat Phantom 5.0 (front); Type: QD 000 P50 AA; Serial: 1001
- DASY52 52.10.4(1535); SEMCAD X 14.6.14(7501)

Dipole Calibration for Head Tissue/Pin=100mW, dist=10mm, f=5250 MHz/Zoom Scan,

dist=1.4mm (8x8x7)/Cube 0: Measurement grid: dx=4mm, dy=4mm, dz=1.4mm

Reference Value = 77.28 V/m; Power Drift = 0.04 dB

Peak SAR (extrapolated) = 27.0 W/kg

SAR(1 g) = 8.12 W/kg; SAR(10 g) = 2.33 W/kg

Smallest distance from peaks to all points 3 dB below = 7.4 mm

Ratio of SAR at M2 to SAR at M1 = 71.5%

Maximum value of SAR (measured) = 18.5 W/kg

Dipole Calibration for Head Tissue/Pin=100mW, dist=10mm, f=5600 MHz/Zoom Scan,

dist=1.4mm (8x8x7)/Cube 0: Measurement grid: dx=4mm, dy=4mm, dz=1.4mm

Reference Value = 77.67 V/m; Power Drift = -0.00 dB

Peak SAR (extrapolated) = 30.9 W/kg

SAR(1 g) = 8.52 W/kg; SAR(10 g) = 2.42 W/kg

Smallest distance from peaks to all points 3 dB below = 7.2 mm

Ratio of SAR at M2 to SAR at M1 = 68.6%

Maximum value of SAR (measured) = 20.2 W/kg

Dipole Calibration for Head Tissue/Pin=100mW, dist=10mm, f=5750 MHz/Zoom Scan, dist=1.4mm (8x8x7)/Cube 0: Measurement grid: dx=4mm, dy=4mm, dz=1.4mm
Reference Value = 74.44 V/m; Power Drift = -0.00 dB
Peak SAR (extrapolated) = 31.2 W/kg
SAR(1 g) = 8.13 W/kg; SAR(10 g) = 2.29 W/kg
Smallest distance from peaks to all points 3 dB below = 7.4 mm
Ratio of SAR at M2 to SAR at M1 = 66.7%
Maximum value of SAR (measured) = 19.8 W/kg

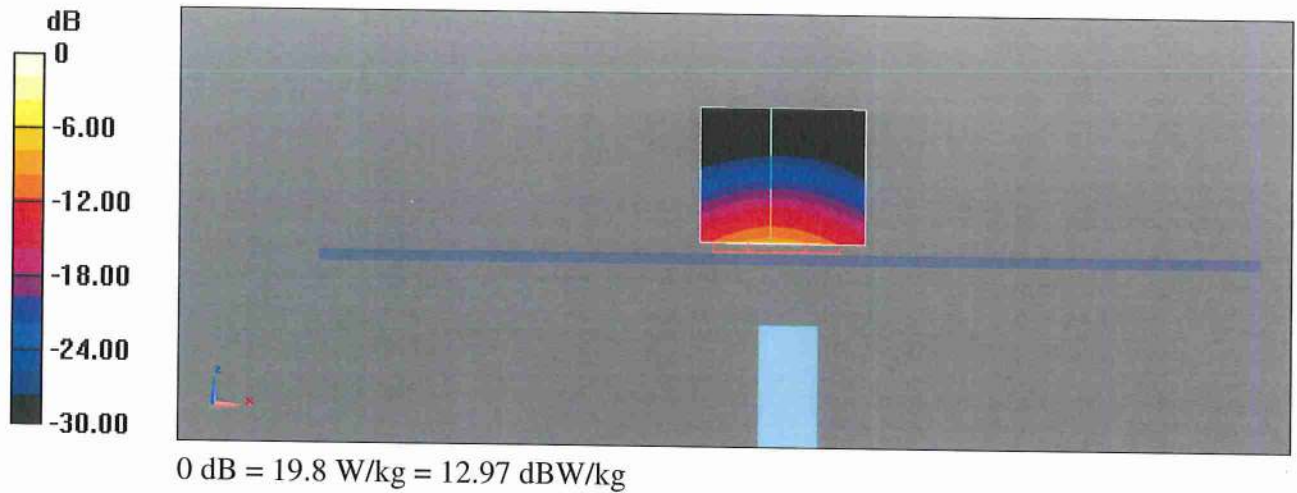

Impedance Measurement Plot for Head TSL

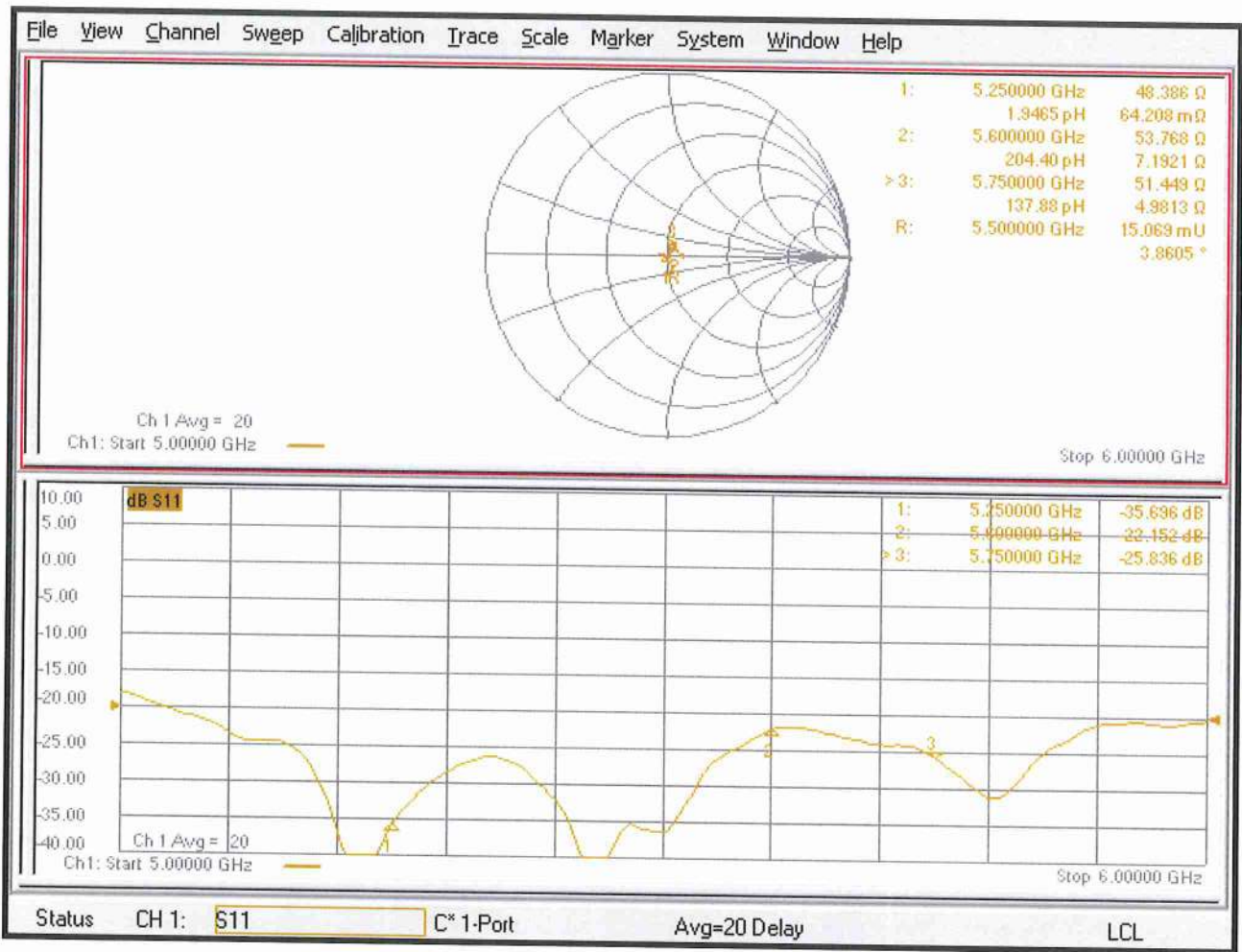



D5GHzV2, Serial No. 1341 Extended Dipole Calibrations

If dipoles are verified in return loss (<-20dB, within 20% of prior calibration), and in impedance (within 5 ohm of prior calibration), the annual calibration is not necessary and the calibration interval can be extended.

5250MHz

| D5GV2 – serial no. 1341 | | | | | | |
|-------------------------|------------------|-----------|----------------------|-------------|---------------------------|-------------|
| 5250 Head | | | | | | |
| Date of Measurement | Return-Loss (dB) | Delta (%) | Real Impedance (ohm) | Delta (ohm) | Imaginary Impedance (ohm) | Delta (ohm) |
| 2021.12.13 | -35.7 | | 48.4 | | 0.1 | |
| 2022.12.12 | -35.7 | 0.0% | 50.1 | -1.7 | -1.6 | 1.7 |
| 2023.12.12 | -34.8 | -2.5% | 48.5 | -0.1 | -0.9 | 1 |

5600MHz

| D5GV2 – serial no. 1341 | | | | | | |
|-------------------------|------------------|-----------|----------------------|-------------|---------------------------|-------------|
| 5600 Head | | | | | | |
| Date of Measurement | Return-Loss (dB) | Delta (%) | Real Impedance (ohm) | Delta (ohm) | Imaginary Impedance (ohm) | Delta (ohm) |
| 2021.12.13 | -22.2 | | 53.8 | | 7.2 | |
| 2022.12.12 | -22.4 | 0.9% | 52.9 | 0.9 | 7.3 | -0.1 |
| 2023.12.12 | -21.3 | -4.1% | 52.8 | 1 | 8.3 | -1.1 |

5750MHz

| D5GV2 – serial no. 1341 | | | | | | |
|-------------------------|------------------|-----------|----------------------|-------------|---------------------------|-------------|
| 5750 Head | | | | | | |
| Date of Measurement | Return-Loss (dB) | Delta (%) | Real Impedance (ohm) | Delta (ohm) | Imaginary Impedance (ohm) | Delta (ohm) |
| 2021.12.13 | -25.8 | | 51.4 | | 5 | |
| 2022.12.12 | -26.1 | 1.2% | 50.1 | 1.3 | 5 | 0 |
| 2023.12.12 | -25.9 | 0.4% | 51.7 | -0.3 | 6.1 | -1.1 |

<Justification of the extended calibration>

The return loss is < -20dB, within 20% of prior calibration; the impedance is within 5 ohm of prior calibration. Therefore the verification result should support extended calibration.

Dipole Verification Data> D5GHzV2, serial no. 1341

5250MHz – Head----2022.12.12

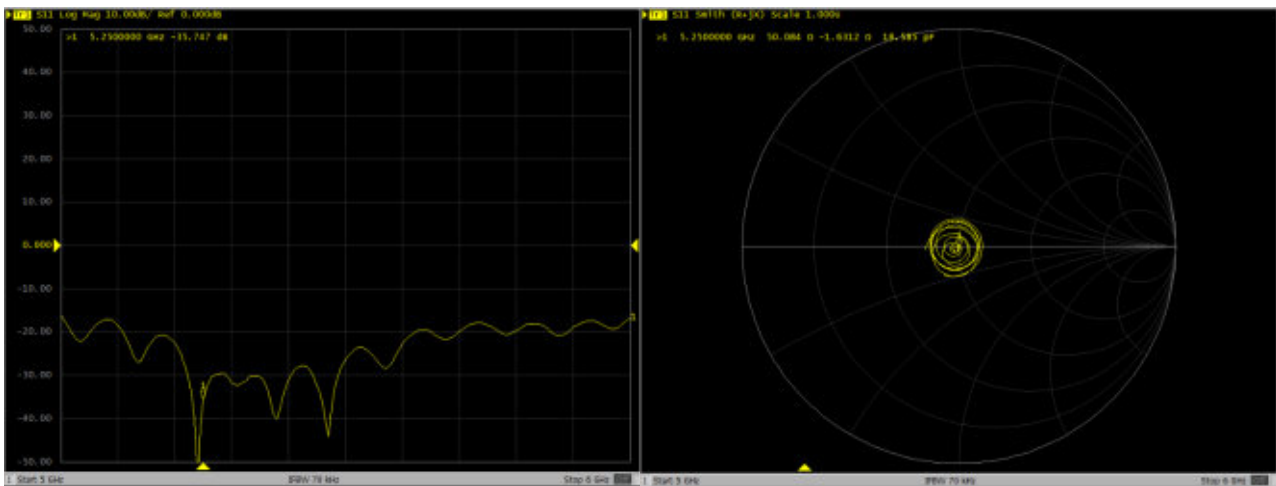

5600MHz – Head----2022.12.12

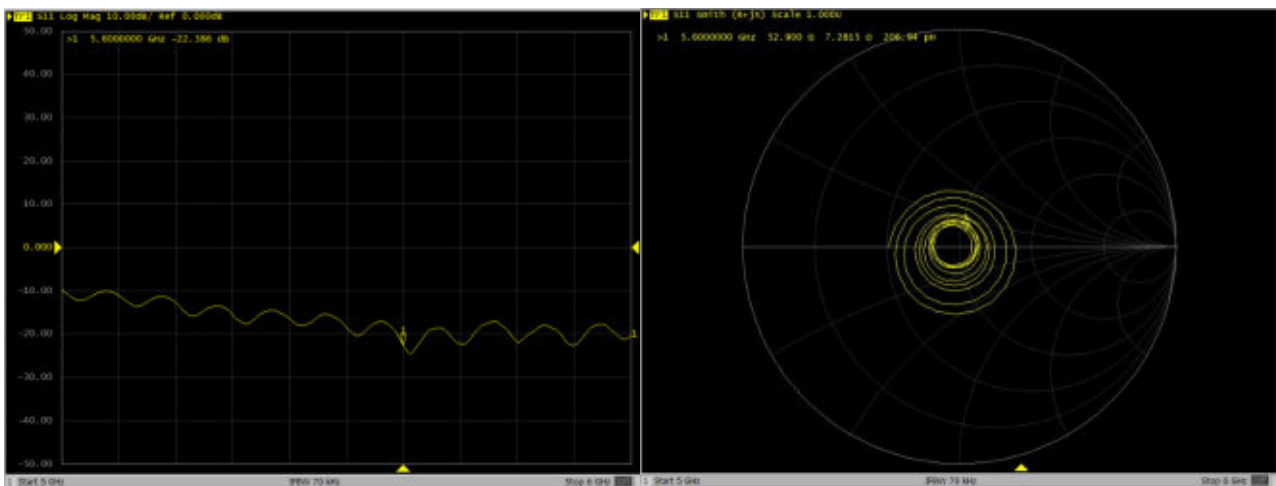

5750MHz – Head---2022.12.12

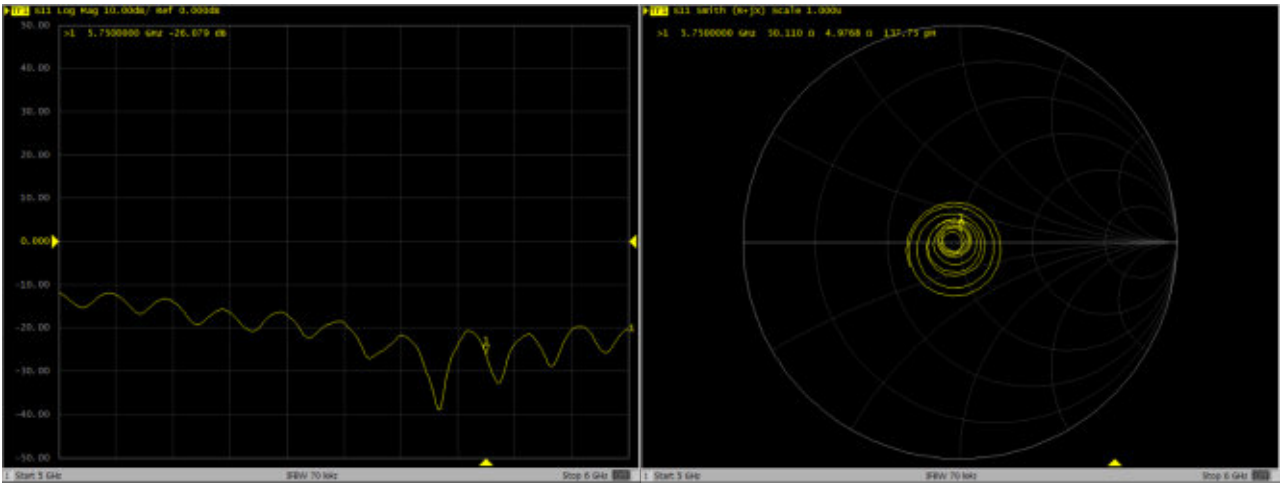

5250MHz – Head---2023.12.12

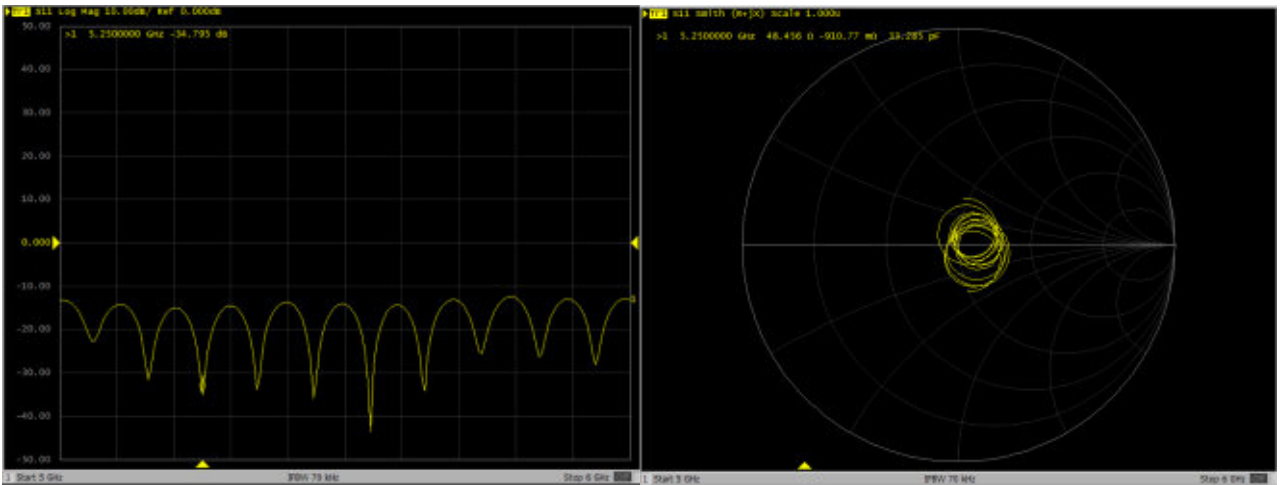

5600MHz – Head---2023.12.12

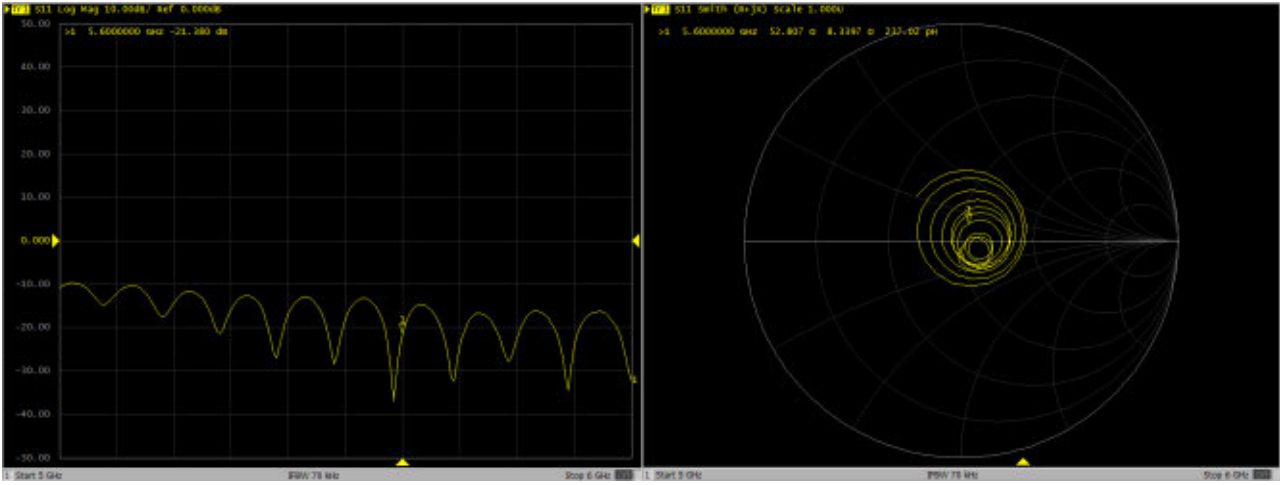

5750MHz – Head---2023.12.12

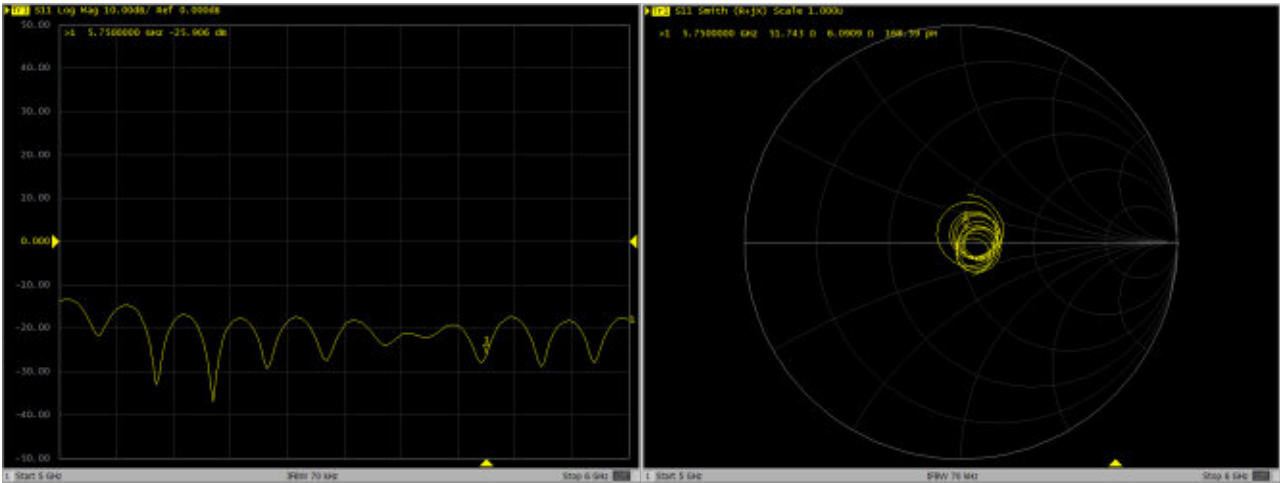

IMPORTANT NOTICE

USAGE OF THE DAE4

The DAE unit is a delicate, high precision instrument and requires careful treatment by the user. There are no serviceable parts inside the DAE. Special attention shall be given to the following points:

Battery Exchange: The battery cover of the DAE4 unit is closed using a screw, over tightening the screw may cause the threads inside the DAE to wear out.

Shipping of the DAE: Before shipping the DAE to SPEAG for calibration, remove the batteries and pack the DAE in an antistatic bag. This antistatic bag shall then be packed into a larger box or container which protects the DAE from impacts during transportation. The package shall be marked to indicate that a fragile instrument is inside.

E-Stop Failures: Touch detection may be malfunctioning due to broken magnets in the E-stop. Rough handling of the E-stop may lead to damage of these magnets. Touch and collision errors are often caused by dust and dirt accumulated in the E-stop. To prevent E-stop failure, the customer shall always mount the probe to the DAE carefully and keep the DAE unit in a non-dusty environment if not used for measurements.

Repair: Minor repairs are performed at no extra cost during the calibration. However, SPEAG reserves the right to charge for any repair especially if rough unprofessional handling caused the defect.

DASY Configuration Files: Since the exact values of the DAE input resistances, as measured during the calibration procedure of a DAE unit, are not used by the DASY software, a nominal value of 200 MOhm is given in the corresponding configuration file.

Important Note:

Warranty and calibration is void if the DAE unit is disassembled partly or fully by the Customer.

Important Note:

Never attempt to grease or oil the E-stop assembly. Cleaning and readjusting of the E-stop assembly is allowed by certified SPEAG personnel only and is part of the calibration procedure.

Important Note:

To prevent damage of the DAE probe connector pins, use great care when installing the probe to the DAE. Carefully connect the probe with the connector notch oriented in the mating position. Avoid any rotational movement of the probe body versus the DAE while turning the locking nut of the connector. The same care shall be used when disconnecting the probe from the DAE.



Accredited by the Swiss Accreditation Service (SAS)
The Swiss Accreditation Service is one of the signatories to the EA
Multilateral Agreement for the recognition of calibration certificates

Accreditation No.: **SCS 0108**

Client **Sporton**
Shenzhen City

Certificate No: **DAE4-1210_Jan24**

CALIBRATION CERTIFICATE

Object **DAE4 - SD 000 D04 BM - SN: 1210**

Calibration procedure(s) **QA CAL-06.v30**
Calibration procedure for the data acquisition electronics (DAE)

Calibration date: **January 15, 2024**

This calibration certificate documents the traceability to national standards, which realize the physical units of measurements (SI).
The measurements and the uncertainties with confidence probability are given on the following pages and are part of the certificate.

All calibrations have been conducted in the closed laboratory facility: environment temperature (22 ± 3)°C and humidity < 70%.

Calibration Equipment used (M&TE critical for calibration)

| Primary Standards | ID # | Cal Date (Certificate No.) | Scheduled Calibration |
|-------------------------------|--------------------|----------------------------|------------------------|
| Keithley Multimeter Type 2001 | SN: 0810278 | 29-Aug-23 (No:37421) | Aug-24 |
| Secondary Standards | ID # | Check Date (in house) | Scheduled Check |
| Auto DAE Calibration Unit | SE UWS 053 AA 1001 | 27-Jan-23 (in house check) | In house check: Jan-24 |
| Calibrator Box V2.1 | SE UMS 006 AA 1002 | 27-Jan-23 (in house check) | In house check: Jan-24 |

| | | | |
|----------------|-------------------|-----------------------|------------------|
| | Name | Function | Signature |
| Calibrated by: | Dominique Steffen | Laboratory Technician | |
| Approved by: | Sven Kühn | Technical Manager | |

Issued: January 15, 2024

This calibration certificate shall not be reproduced except in full without written approval of the laboratory.



Accredited by the Swiss Accreditation Service (SAS)

The Swiss Accreditation Service is one of the signatories to the EA
Multilateral Agreement for the recognition of calibration certificates

Glossary

| | |
|-----------------|---|
| DAE | data acquisition electronics |
| Connector angle | information used in DASY system to align probe sensor X to the robot coordinate system. |

Methods Applied and Interpretation of Parameters

- *DC Voltage Measurement:* Calibration Factor assessed for use in DASY system by comparison with a calibrated instrument traceable to national standards. The figure given corresponds to the full scale range of the voltmeter in the respective range.
- *Connector angle:* The angle of the connector is assessed measuring the angle mechanically by a tool inserted. Uncertainty is not required.
- The following parameters as documented in the Appendix contain technical information as a result from the performance test and require no uncertainty.
 - *DC Voltage Measurement Linearity:* Verification of the Linearity at +10% and -10% of the nominal calibration voltage. Influence of offset voltage is included in this measurement.
 - *Common mode sensitivity:* Influence of a positive or negative common mode voltage on the differential measurement.
 - *Channel separation:* Influence of a voltage on the neighbor channels not subject to an input voltage.
 - *AD Converter Values with inputs shorted:* Values on the internal AD converter corresponding to zero input voltage
 - *Input Offset Measurement:* Output voltage and statistical results over a large number of zero voltage measurements.
 - *Input Offset Current:* Typical value for information; Maximum channel input offset current, not considering the input resistance.
 - *Input resistance:* Typical value for information: DAE input resistance at the connector, during internal auto-zeroing and during measurement.
 - *Low Battery Alarm Voltage:* Typical value for information. Below this voltage, a battery alarm signal is generated.
 - *Power consumption:* Typical value for information. Supply currents in various operating modes.

DC Voltage Measurement

A/D - Converter Resolution nominal

High Range: 1LSB = 6.1 μ V , full range = -100...+300 mV

Low Range: 1LSB = 61nV , full range = -1.....+3mV

DASY measurement parameters: Auto Zero Time: 3 sec; Measuring time: 3 sec

| Calibration Factors | X | Y | Z |
|---------------------|---------------------------|---------------------------|---------------------------|
| High Range | 404.332 \pm 0.02% (k=2) | 405.041 \pm 0.02% (k=2) | 404.472 \pm 0.02% (k=2) |
| Low Range | 3.98872 \pm 1.50% (k=2) | 3.97362 \pm 1.50% (k=2) | 3.98761 \pm 1.50% (k=2) |

Connector Angle

| | |
|---|-------------------------------------|
| Connector Angle to be used in DASY system | 338.5 $^{\circ}$ \pm 1 $^{\circ}$ |
|---|-------------------------------------|

Appendix (Additional assessments outside the scope of SCS0108)

1. DC Voltage Linearity

| High Range | Reading (μV) | Difference (μV) | Error (%) |
|-------------------|---------------------------|------------------------------|-----------|
| Channel X + Input | 200009.44 | 0.24 | 0.00 |
| Channel X + Input | 20019.78 | 1.81 | 0.01 |
| Channel X - Input | -19982.29 | 3.94 | -0.02 |
| Channel Y + Input | 200011.29 | 1.95 | 0.00 |
| Channel Y + Input | 20016.06 | -1.97 | -0.01 |
| Channel Y - Input | -19985.50 | 0.57 | -0.00 |
| Channel Z + Input | 200008.38 | -0.71 | -0.00 |
| Channel Z + Input | 20017.94 | -0.03 | -0.00 |
| Channel Z - Input | -19987.35 | -1.25 | 0.01 |

| Low Range | Reading (μV) | Difference (μV) | Error (%) |
|-------------------|---------------------------|------------------------------|-----------|
| Channel X + Input | 2018.43 | 1.91 | 0.09 |
| Channel X + Input | 219.28 | 2.33 | 1.07 |
| Channel X - Input | -180.78 | 1.98 | -1.08 |
| Channel Y + Input | 2018.00 | 1.32 | 0.07 |
| Channel Y + Input | 217.55 | 0.37 | 0.17 |
| Channel Y - Input | -182.73 | -0.02 | 0.01 |
| Channel Z + Input | 2017.53 | 0.77 | 0.04 |
| Channel Z + Input | 216.53 | -0.77 | -0.35 |
| Channel Z - Input | -183.38 | -0.65 | 0.35 |

2. Common mode sensitivity

DASY measurement parameters: Auto Zero Time: 3 sec; Measuring time: 3 sec

| | Common mode Input Voltage (mV) | High Range Average Reading (μV) | Low Range Average Reading (μV) |
|-----------|--------------------------------|--|---|
| Channel X | 200 | 23.95 | 22.21 |
| | - 200 | -21.54 | -23.21 |
| Channel Y | 200 | -10.99 | -10.86 |
| | - 200 | 10.11 | 9.57 |
| Channel Z | 200 | -15.26 | -15.87 |
| | - 200 | 14.13 | 14.21 |

3. Channel separation

DASY measurement parameters: Auto Zero Time: 3 sec; Measuring time: 3 sec

| | Input Voltage (mV) | Channel X (μV) | Channel Y (μV) | Channel Z (μV) |
|-----------|--------------------|-----------------------------|-----------------------------|-----------------------------|
| Channel X | 200 | - | 3.71 | -4.10 |
| Channel Y | 200 | 8.54 | - | 4.46 |
| Channel Z | 200 | 9.39 | 6.63 | - |

4. AD-Converter Values with inputs shorted

DASY measurement parameters: Auto Zero Time: 3 sec; Measuring time: 3 sec

| | High Range (LSB) | Low Range (LSB) |
|-----------|------------------|-----------------|
| Channel X | 15719 | 15982 |
| Channel Y | 16235 | 17715 |
| Channel Z | 15939 | 17069 |

5. Input Offset Measurement

DASY measurement parameters: Auto Zero Time: 3 sec; Measuring time: 3 sec

Input 10M Ω

| | Average (μ V) | min. Offset (μ V) | max. Offset (μ V) | Std. Deviation (μ V) |
|-----------|--------------------|------------------------|------------------------|---------------------------|
| Channel X | 0.03 | -2.11 | 1.38 | 0.57 |
| Channel Y | -0.16 | -1.49 | 0.95 | 0.42 |
| Channel Z | -0.81 | -1.98 | 0.60 | 0.49 |

6. Input Offset Current

Nominal input circuitry offset current on all channels: <25fA

7. Input Resistance (Typical values for information)

| | Zeroing (kOhm) | Measuring (MOhm) |
|-----------|----------------|------------------|
| Channel X | 200 | 200 |
| Channel Y | 200 | 200 |
| Channel Z | 200 | 200 |

8. Low Battery Alarm Voltage (Typical values for information)

| Typical values | Alarm Level (VDC) |
|----------------|-------------------|
| Supply (+ Vcc) | +7.9 |
| Supply (- Vcc) | -7.6 |

9. Power Consumption (Typical values for information)

| Typical values | Switched off (mA) | Stand by (mA) | Transmitting (mA) |
|----------------|-------------------|---------------|-------------------|
| Supply (+ Vcc) | +0.01 | +6 | +14 |
| Supply (- Vcc) | -0.01 | -8 | -9 |

IMPORTANT NOTICE

USAGE OF THE DAE4

The DAE unit is a delicate, high precision instrument and requires careful treatment by the user. There are no serviceable parts inside the DAE. Special attention shall be given to the following points:

Battery Exchange: The battery cover of the DAE4 unit is closed using a screw, over tightening the screw may cause the threads inside the DAE to wear out.

Shipping of the DAE: Before shipping the DAE to SPEAG for calibration, remove the batteries and pack the DAE in an antistatic bag. This antistatic bag shall then be packed into a larger box or container which protects the DAE from impacts during transportation. The package shall be marked to indicate that a fragile instrument is inside.

E-Stop Failures: Touch detection may be malfunctioning due to broken magnets in the E-stop. Rough handling of the E-stop may lead to damage of these magnets. Touch and collision errors are often caused by dust and dirt accumulated in the E-stop. To prevent E-stop failure, the customer shall always mount the probe to the DAE carefully and keep the DAE unit in a non-dusty environment if not used for measurements.

Repair: Minor repairs are performed at no extra cost during the calibration. However, SPEAG reserves the right to charge for any repair especially if rough unprofessional handling caused the defect.

DASY Configuration Files: Since the exact values of the DAE input resistances, as measured during the calibration procedure of a DAE unit, are not used by the DASY software, a nominal value of 200 MOhm is given in the corresponding configuration file.

Important Note:

Warranty and calibration is void if the DAE unit is disassembled partly or fully by the Customer.

Important Note:

Never attempt to grease or oil the E-stop assembly. Cleaning and readjusting of the E-stop assembly is allowed by certified SPEAG personnel only and is part of the calibration procedure.

Important Note:

To prevent damage of the DAE probe connector pins, use great care when installing the probe to the DAE. Carefully connect the probe with the connector notch oriented in the mating position. Avoid any rotational movement of the probe body versus the DAE while turning the locking nut of the connector. The same care shall be used when disconnecting the probe from the DAE.



Accredited by the Swiss Accreditation Service (SAS)
The Swiss Accreditation Service is one of the signatories to the EA
Multilateral Agreement for the recognition of calibration certificates

Accreditation No.: **SCS 0108**

Client **Sporton**
Shenzhen City

Certificate No: **DAE4-715_Jan24**

CALIBRATION CERTIFICATE

Object **DAE4 - SD 000 D04 BM - SN: 715**

Calibration procedure(s) **QA CAL-06.v30**
Calibration procedure for the data acquisition electronics (DAE)

Calibration date: **January 25, 2024**

This calibration certificate documents the traceability to national standards, which realize the physical units of measurements (SI).
The measurements and the uncertainties with confidence probability are given on the following pages and are part of the certificate.

All calibrations have been conducted in the closed laboratory facility: environment temperature $(22 \pm 3)^\circ\text{C}$ and humidity $< 70\%$.

Calibration Equipment used (M&TE critical for calibration)

| Primary Standards | ID # | Cal Date (Certificate No.) | Scheduled Calibration |
|-------------------------------|--------------------|----------------------------|------------------------|
| Keithley Multimeter Type 2001 | SN: 0810278 | 29-Aug-23 (No:37421) | Aug-24 |
| Secondary Standards | ID # | Check Date (in house) | Scheduled Check |
| Auto DAE Calibration Unit | SE UWS 053 AA 1001 | 23-Jan-24 (in house check) | In house check: Jan-25 |
| Calibrator Box V2.1 | SE UMS 006 AA 1002 | 23-Jan-24 (in house check) | In house check: Jan-25 |

Calibrated by: **Dominique Steffen** Laboratory Technician

Approved by: **Sven Kühn** Technical Manager

Signature

Issued: January 25, 2024

This calibration certificate shall not be reproduced except in full without written approval of the laboratory.