



FCC RF Test Report

APPLICANT : TCL Communication Ltd.
EQUIPMENT : GSM/UMTS/LTE/NR Mobile phone
BRAND NAME : TCL
MODEL NAME : T803E
FCC ID : 2ACCJH183
STANDARD : 47 CFR Part 2, 96
CLASSIFICATION : Citizens Band End User Devices (CBE)
EQUIPMENT TYPE : End User Equipment
TEST DATE(S) : Mar. 20, 2024 ~ Mar. 24, 2024

We, Sporton International Inc. (Shenzhen), would like to declare that the tested sample has been evaluated in accordance with the procedures given in ANSI C63.26 and shown compliance with the applicable technical standards.

The test results in this report apply exclusively to the tested model / sample. Without written approval of Sporton International Inc. (Shenzhen), the test report shall not be reproduced except in full.

Jason Jia



Approved by: Jason Jia

Sporton International Inc. (ShenZhen)

1/F, 2/F, Bldg 5, Shiling Industrial Zone, Xinwei Village, Xili, Nanshan, Shenzhen, 518055

People's Republic of China



Table of Contents

History of this test report..... 3

Summary of Test Result..... 4

1 General Description 5

 1.1 Applicant..... 5

 1.2 Manufacturer 5

 1.3 Feature of Equipment Under Test..... 5

 1.4 Maximum EIRP Power and Emission Designator 6

 1.5 Testing Site..... 6

 1.6 Test Software 7

 1.7 Applied Standards 7

2 Test Configuration of Equipment Under Test 8

 2.1 Test Mode..... 8

 2.2 Connection Diagram of Test System 9

 2.3 Support Unit used in test configuration 9

 2.4 Measurement Results Explanation Example 9

 2.5 Frequency List of Low/Middle/High Channels..... 10

3 Conducted Test Items..... 11

 3.1 Measuring Instruments..... 11

 3.2 Test Setup 11

 3.3 Conducted Output Power 12

 3.4 EIRP 13

 3.5 Occupied Bandwidth 14

 3.6 Conducted Band Edge 15

 3.7 Conducted Spurious Emission 16

 3.8 Frequency Stability..... 17

4 Radiated Test Items 18

 4.1 Measuring Instruments..... 18

 4.2 Test Setup 18

 4.3 Test Result of Radiated Test..... 19

 4.4 Radiated Spurious Emission 20

5 List of Measuring Equipment..... 21

6 Measurement Uncertainty 22

Appendix A. Test Results of Conducted Test

Appendix B. Test Results of Radiated Test

Appendix C. Test Setup Photographs



History of this test report

Report No.	Version	Description	Issued Date
FG422702F	01	Initial issue of report	Apr. 07, 2024



Summary of Test Result

Report Clause	Ref Std. Clause	Test Items	Result (PASS/FAIL)	Remark
3.3	§2.1046	Conducted Output Power	Reporting only	-
-	§96.41	Peak-to-Average Ratio	Not Applicable	Not applicable for End User Devices
3.4	§96.41	Maximum E.I.R.P	Pass	-
		Maximum Power Spectral Density	Not Applicable	Not applicable for End User Devices
3.5	§2.1049 §96.41	Occupied Bandwidth	Reporting only	-
3.6	§2.1051 §96.41	Conducted Band Edge Measurement Adjacent Channel Leakage Ratio	Pass	-
3.7	§2.1051 §96.41	Conducted Spurious Emission	Pass	
3.8	§2.1055	Frequency Stability for Temperature & Voltage	Pass	-
4.4	§2.1051 §96.41	Radiated Spurious Emission	Pass	Under limit 12.58 dB at 10848.00 MHz

Conformity Assessment Condition:
1. The test results (PASS/FAIL) with all measurement uncertainty excluded are presented against the regulation limits or in accordance with the requirements stipulated by the applicant/manufacturer who shall bear all the risks of non-compliance that may potentially occur if measurement uncertainty is taken into account.
2. The measurement uncertainty please refer to each test result in the section "Measurement Uncertainty"
Disclaimer:
The product specifications of the EUT presented in the test report that may affect the test assessments are declared by the manufacturer who shall take full responsibility for the authenticity.



1 General Description

1.1 Applicant

TCL Communication Ltd.

5/F, Building 22E, 22 Science Park East Avenue, Hong Kong Science Park, Shatin, NT, Hong Kong

1.2 Manufacturer

TCL Communication Ltd.

5/F, Building 22E, 22 Science Park East Avenue, Hong Kong Science Park, Shatin, NT, Hong Kong

1.3 Feature of Equipment Under Test

Product Feature	
Equipment	GSM/UMTS/LTE/NR Mobile phone
Brand Name	TCL
Model Name	T803E
FCC ID	2ACCJH183
Tx Frequency	LTE Band 42 : 3550 MHz ~ 3600 MHz LTE Band 48: 3550 MHz ~ 3700 MHz
Rx Frequency	LTE Band 42 : 3550 MHz ~ 3600 MHz LTE Band 48: 3550 MHz ~ 3700 MHz
Bandwidth	5MHz / 10MHz / 15MHz / 20MHz
Maximum Output Power to Antenna	<Ant.2> LTE Band 42: 23.12 dBm LTE Band 48: 23.17 dBm
Antenna Gain	<Ant.2> LTE Band 42: -1.0 dBi LTE Band 48: -1.0 dBi
Type of Modulation	QPSK / 16QAM / 64QAM / 256QAM
IMEI Code/SN	Conducted: YTDMEIJZFYTTOWK Radiation: 353318350121876/353318350121884
HW Version	05
SW Version	AGS7
EUT Stage	Identical Prototype

Remark: The above EUT's information was declared by manufacturer. Please refer to the specifications or user's manual for more detailed description.

1.4 Maximum EIRP Power and Emission Designator

LTE Band 42		QPSK		16QAM/64QAM/256QAM	
BW (MHz)	Frequency Range (MHz)	Maximum EIRP(W)	Emission Designator (99%OBW)	Maximum EIRP(W)	Emission Designator (99%OBW)
5	3552.5~3597.5	0.1581	4M50G7D	0.1337	4M51W7D
10	3555.0~3595.0	0.1542	9M01G7D	0.1346	9M07W7D
15	3557.5~3592.5	0.1560	13M4G7D	0.1358	13M4W7D
20	3560.0~3590.0	0.1629	17M9G7D	0.1393	17M8W7D

LTE Band 48		QPSK		16QAM/64QAM/256QAM	
BW (MHz)	Frequency Range (MHz)	Maximum EIRP(W)	Emission Designator (99%OBW)	Maximum EIRP(W)	Emission Designator (99%OBW)
5	3552.5~3697.5	0.1603	4M50G7D	0.1250	4M51W7D
10	3555~3695	0.1592	9M01G7D	0.1259	9M07W7D
15	3557.5~3692.5	0.1585	13M4G7D	0.1271	13M4W7D
20	3560~3690	0.1648	17M9G7D	0.1303	17M8W7D

Note:

1. All modulations have been tested, only the worst test results of PSK & QAM are shown in the report.
2. LTE Band 48 overlaps the entire frequency range of Band 42, and B48 power > B42 power, therefore the conducted test results of B48 provided in this report cover B42.

1.5 Testing Site

Sporton International Inc. (ShenZhen) is accredited to ISO/IEC 17025:2017 by American Association for Laboratory Accreditation with Certificate Number 5145.01.

Test Firm	Sporton International Inc. (ShenZhen)		
Test Site Location	1/F, 2/F, Bldg 5, Shiling Industrial Zone, Xinwei Village, Xili, Nanshan, Shenzhen, 518055 People’s Republic of China TEL: +86-755-86379589 FAX: +86-755-86379595		
Test Site No.	Sporton Site No.	FCC Designation No.	FCC Test Firm Registration No.
	TH01-SZ	CN1256	421272



Test Firm	Sporton International Inc. (ShenZhen)		
Test Site Location	101, 1st Floor, Block B, Building 1, No. 2, Tengfeng 4th Road, Fenghuang Community, Fuyong Street, Baoan District, Shenzhen City, Guangdong Province 518103 People's Republic of China TEL: +86-755-86066985		
Test Site No.	Sporton Site No.	FCC Designation No.	FCC Test Firm Registration No.
	03CH01-SZ	CN1256	421272

1.6 Test Software

Item	Site	Manufacture	Name	Version
1.	03CH01-SZ	AUDIX	E3	6.2009-8-24

1.7 Applied Standards

According to the specifications of the manufacturer, the EUT must comply with the requirements of the following standards:

- ♦ ANSI C63.26-2015
- ♦ 47 CFR Part 2, 96
- ♦ FCC KDB 971168 D01 Power Meas. License Digital Systems v03r01
- ♦ FCC KDB 940660 D01 Part 96 CBRS v03
- ♦ FCC KDB 412172 D01 Determining ERP and EIRP v01r01

Remark:

1. All test items were verified and recorded according to the standards and without any deviation during the test.
2. This EUT has also been tested and complied with the requirements of FCC Part 15, Subpart B, recorded in a separate test report.



2 Test Configuration of Equipment Under Test

2.1 Test Mode

Antenna port conducted and radiated test items listed below are performed according to KDB 971168 D01 Power Meas. License Digital Systems v03r01 with maximum output power.

For radiated measurement, pre-scanned in three orthogonal panels, X, Y, Z. The worst cases (Y plane) were recorded in this report.

Test Items	Band	Bandwidth (MHz)						Modulation				RB #			Test Channel			
		1.4	3	5	10	15	20	QPSK	16 QAM	64 QAM	256 QAM	1	Half	Full	L	M	H	
Max. Output Power	42	-	-	v	v	v	v	v	v	v	v	v	v	v	v	v	v	v
	48	-	-	v	v	v	v	v	v	v	v	v	v	v	v	v	v	v
Adjacent Channel Leakage Ratio	48	-	-	v	v	v	v	v	v	v			v		v	v	v	v
26dB and 99% Bandwidth	48	-	-	v	v	v	v	v	v					v		v		
Conducted Band Edge	48	-	-	v	v	v	v	v	v	v			v		v	v	v	v
Conducted Spurious Emission	48	-	-	v	v	v	v	v					v		v	v	v	v
E.I.R.P	42	-	-	v	v	v	v	v	v	v	v	v	v	v	v	v	v	v
	48	-	-	v	v	v	v	v	v	v	v	v	v	v	v	v	v	v
Frequency Stability	48	-	-		v			v					v				v	
Radiated Spurious Emission	48	Worst Case															v	
Remark	<ol style="list-style-type: none"> The mark "v" means that this configuration is chosen for testing The mark "-" means that this bandwidth is not supported. The device is investigated from 30MHz to 10 times of fundamental signal for radiated spurious emission test under different RB size/offset and modulations in exploratory test. Subsequently, only the worst case emissions are reported. All the radiated test cases were performed with Adapter 1, USB Cable and Earphone. For QAM modulation mode, the whole testing has assessed 16QAM&64QAM mode by referring to the higher conducted power. 																	

2.2 Connection Diagram of Test System

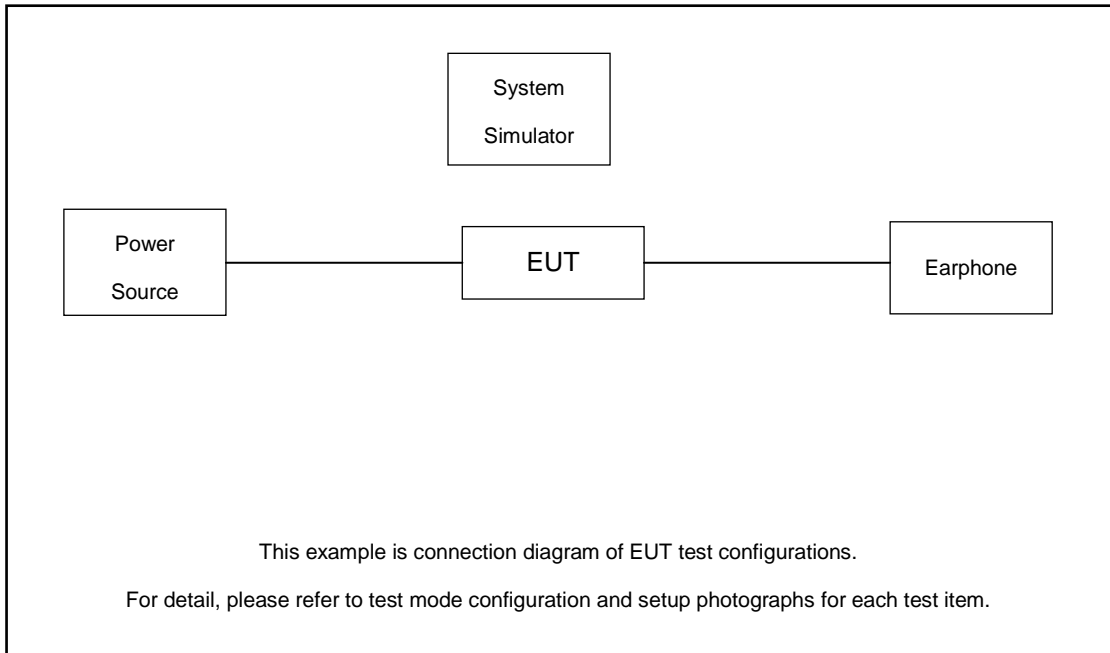

2.3 Support Unit used in test configuration

Item	Equipment	Trade Name	Model No.	FCC ID	Data Cable	Power Cord
1.	Power Supply	GWINSTEK	PSS-2002	N/A	N/A	Unshielded, 1.8 m
2.	LTE Base Station	Anritsu	MT8821C	N/A	N/A	Unshielded, 1.8 m
3.	Earphone	N/A	N/A	N/A	N/A	N/A
4.	Fixture	INTEL	NGFF Card Carrier	N/A	N/A	N/A

2.4 Measurement Results Explanation Example

For all conducted test items:

The offset level is set in the spectrum analyzer to compensate the RF cable loss and attenuator factor between EUT conducted output port and spectrum analyzer. With the offset compensation, the spectrum analyzer reading level is exactly the EUT RF output level.

The spectrum analyzer offset is derived from RF cable loss and attenuator factor.

Offset = RF cable loss + attenuator factor.

Following shows an offset computation example with cable loss 5.5 dB and 10dB attenuator.

Example :

$$\begin{aligned} \text{Offset}(dB) &= \text{RF cable loss}(dB) + \text{attenuator factor}(dB) \\ &= 5.5 + 10 = 15.5 \text{ (dB)} \end{aligned}$$



2.5 Frequency List of Low/Middle/High Channels

LTE Band 48 Channel and Frequency List				
BW [MHz]	Channel/Frequency(MHz)	Lowest	Middle	Highest
20	Channel	55340	55990	56640
	Frequency	3560.0	3625.0	3690.0
15	Channel	55315	55990	56665
	Frequency	3557.5	3625.0	3692.5
10	Channel	55290	55990	56690
	Frequency	3555.0	3625.0	3695.0
5	Channel	55265	55990	56715
	Frequency	3552.5	3625.0	3697.5

LTE Band 42 Channel and Frequency List				
BW [MHz]	Channel/Frequency(MHz)	Lowest	Middle	Highest
20	Channel	43190	43340	43490
	Frequency	3560	3575	3590
15	Channel	43165	43340	43515
	Frequency	3557.5	3575	3592.5
10	Channel	43140	43340	43540
	Frequency	3555	3575	3595
5	Channel	43115	43340	43565
	Frequency	3552.5	3575	3597.5

3 Conducted Test Items

3.1 Measuring Instruments

See list of measuring instruments of this test report.

3.2 Test Setup

3.2.1 Conducted Output Power / ACLR

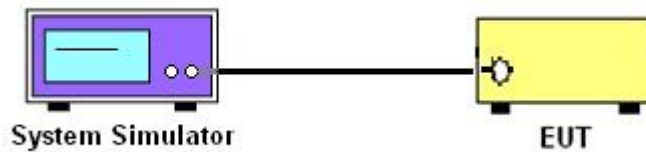

3.2.2 26dB & 99% Occupied Bandwidth, Conducted Band-Edge and Conducted Spurious Emission

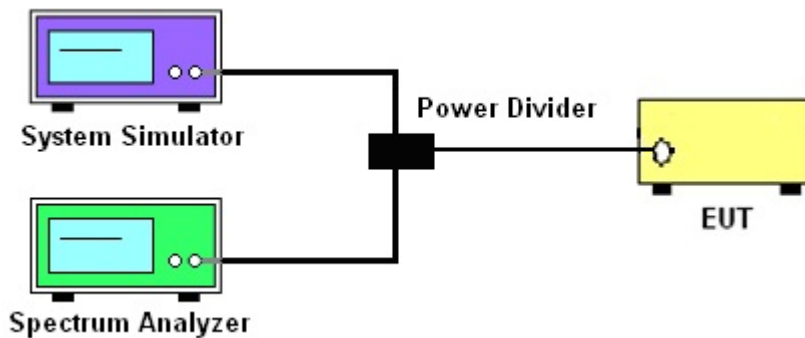

3.2.3 Frequency Stability

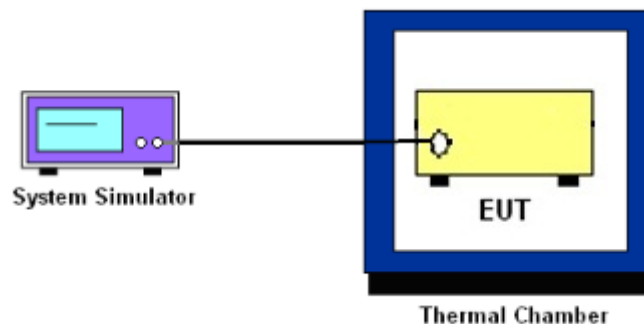

3.2.4 Test Result of Conducted Test

Please refer to Appendix A.



3.3 Conducted Output Power

3.3.1 Description of the Conducted Output Power Measurement

A system simulator was used to establish communication with the EUT. Its parameters were set to force the EUT transmitting at maximum output power. The measured power in the radio frequency on the transmitter output terminals shall be reported.

3.3.2 Test Procedures

1. The transmitter output port was connected to the system simulator.
2. Set EUT at maximum power through the system simulator.
3. Select lowest, middle, and highest channels for each band and different modulation.
4. Measure and record the power level from the system simulator.

3.4 EIRP

3.4.1 Description of the EIRP Measurement

EIRP limits for CBRS equipment as below table:

Device		Maximum EIRP (dBm/10 MHz)	Maximum PSD (dBm/MHz)
Applied	End User Device	23	n/a
<input type="checkbox"/>	Category A CBSD	30	20
<input type="checkbox"/>	Category B CBSD	47	37

Remark: The worst case EIRP shown in this section is found with LTE operating only using 1RB. As such, the EIRP/10MHz and full channel EIRP values will be identical since 1RB is fully contained within all available channel bandwidths for LTE Band 48 (i.e. 5, 10, 15, 20MHz)

3.4.2 Test Procedures for EIRP

1. Establishing a communications link with the call box (Base station) to measure the Maximum conducted power, the parameters were set to force the EUT transmitting at maximum output power level. Use the average power measurement function to measure total channel power of each channel bandwidth (per ANSI C63.26-2015 Section 5.2.1)
2. Determining ERP and/or EIRP from conducted RF output power measurements (Per ANSI C63.26-2015 Section 5.2.5.5)
 - EIRP = $P_T + G_T - L_C$, ERP = EIRP - 2.15, where
 - P_T = transmitter output power in dBm
 - G_T = gain of the transmitting antenna in dBi
 - L_C = signal attenuation in the connecting cable between the transmitter and antenna in dB



3.5 Occupied Bandwidth

3.5.1 Description of Occupied Bandwidth Measurement

The occupied bandwidth is the width of a frequency band such that, below the lower and above the upper frequency limits, the mean powers emitted are each equal to a specified percentage 0.5% of the total mean transmitted power.

The 26 dB emission bandwidth is defined as the frequency range between two points, one above and one below the carrier frequency, at which the spectral density of the emission is attenuated 26 dB below the maximum in-band spectral density of the modulated signal. Spectral density (power per unit bandwidth) is to be measured with a detector of resolution bandwidth equal to approximately 1.0% of the emission bandwidth.

3.5.2 Test Procedures

The testing follows ANSI C63.26-2015 Section 5.4.3 (26dB) and Section 5.4.4 (99OB)

1. The EUT was connected to spectrum analyzer and system simulator via a power divider.
2. The spectrum analyzer center frequency is set to the nominal EUT channel center frequency. The span range for the spectrum analyzer shall be between two and five times the anticipated OBW.
3. The nominal resolution bandwidth (RBW) shall be in the range of 1 to 5 % of the anticipated OBW, and the VBW shall be at least 3 times the RBW.
4. Set the detection mode to peak, and the trace mode to max hold.
5. Determine the reference value: Set the EUT to transmit a modulated signal. Allow the trace to stabilize. Set the spectrum analyzer marker to the highest level of the displayed trace.
(this is the reference value)
6. Determine the “-26 dB down amplitude” as equal to (Reference Value – X).
7. Place two markers, one at the lowest and the other at the highest frequency of the envelope of the spectral display such that each marker is at or slightly below the “-X dB down amplitude” determined in step 6. If a marker is below this “-X dB down amplitude” value it shall be placed as close as possible to this value. The OBW is the positive frequency difference between the two markers.
8. Use the 99 % power bandwidth function of the spectrum analyzer and report the measured bandwidth.

3.6 Conducted Band Edge

3.6.1 Description of Conducted Band Edge Measurement

Part 96.41 (e) (1) (i)

For CBSD the emission limits outside the fundamental are as follows:

Within 0 MHz to 10 MHz above and below the assigned channel ≤ -13 dBm/MHz

Greater than 10 MHz above and below the assigned channel ≤ -25 dBm/MHz

Part 96.41 (e) (1) (ii)

For End User Devices the emission limits outside the fundamental are as follows:

Within 0 MHz to B MHz above and below the assigned channel ≤ -13 dBm/MHz

Greater than B MHz above and below the assigned channel ≤ -25 dBm/MHz

where B is the bandwidth in megahertz of the assigned channel or multiple contiguous channels of the End User Device.

Notwithstanding the emission limits in this paragraph, the Adjacent Channel Leakage Ratio for End User Devices shall be at least 30 dB.

Part 96.41 (e) (2)

For CBSDs and End User Devices, the conducted power of emissions below 3540 MHz or above 3710 MHz shall not exceed -25 dBm/MHz, and the conducted power of emissions below 3530 MHz or above 3720 MHz shall not exceed -40 dBm/MHz

3.6.2 Test Procedures

The testing follows FCC KDB 971168 D01 v03r01 Section 6.1.

1. The EUT was connected to spectrum analyzer and system simulator via a power divider.
2. The band edges of low and high channels for the highest RF powers were measured.
3. Set RBW $\geq 1\%$ EBW in the 1MHz band immediately outside and adjacent to the band edge.
4. Beyond the 1 MHz band from the band edge, RBW=1MHz was used
5. Offset has included the duty factor for LTE Band 48. Duty factor $=10 \log (1/x)$, where x is the measured duty cycle.
6. Set spectrum analyzer with RMS detector.
7. The RF fundamental frequency should be excluded against the limit line in the operating frequency band.



3.7 Conducted Spurious Emission

3.7.1 Description of Conducted Spurious Emission Measurement

96.41 (e)(2)

The conducted power of any emissions below 3530 MHz or above 3720 MHz shall not exceed -40dBm/MHz.

3.7.2 Test Procedures

The testing follows FCC KDB 971168 D01 v03r01 Section 6.1.

1. The EUT was connected to spectrum analyzer and system simulator via a power divider.
2. The RF output of EUT was connected to the spectrum analyzer by RF cable and attenuator. The path loss was compensated to the results for each measurement.
3. The middle channel for the highest RF power within the transmitting frequency was measured.
4. The conducted spurious emission for the whole frequency range was taken.
5. Make the measurement with the spectrum analyzer's RBW = 1MHz, VBW = 3MHz.
6. Set spectrum analyzer with RMS detector.
7. Taking the record of maximum spurious emission.
8. The RF fundamental frequency should be excluded against the limit line in the operating frequency band.
9. The limit line is -40dBm/MHz.



3.8 Frequency Stability

3.8.1 Description of Frequency Stability Measurement

The frequency stability shall be measured by variation of ambient temperature and variation of primary supply voltage to ensure that the fundamental emission stays within the authorized frequency block.

3.8.2 Test Procedures for Temperature Variation

The testing follows FCC KDB 971168 D01 v03r01 Section 9.0.

1. The EUT was set up in the thermal chamber and connected with the system simulator.
2. With power OFF, the temperature was decreased to -30°C and the EUT was stabilized before testing. Power was applied and the maximum change in frequency was recorded within one minute.
3. With power OFF, the temperature was raised in 10°C step up to 50°C. The EUT was stabilized at each step for at least half an hour. Power was applied and the maximum frequency change was recorded within one minute.

3.8.3 Test Procedures for Voltage Variation

The testing follows FCC KDB 971168 D01 v03r01 Section 9.0.

1. The EUT was placed in a temperature chamber at 25±5° C and connected with the system simulator.
2. The power supply voltage to the EUT was varied from 85% to 115% of the nominal value measured at the input to the EUT.
3. The variation in frequency was measured for the worst case.

4 Radiated Test Items

4.1 Measuring Instruments

See list of measuring instruments of this test report.

4.2 Test Setup

4.2.1 For radiated test below 30MHz

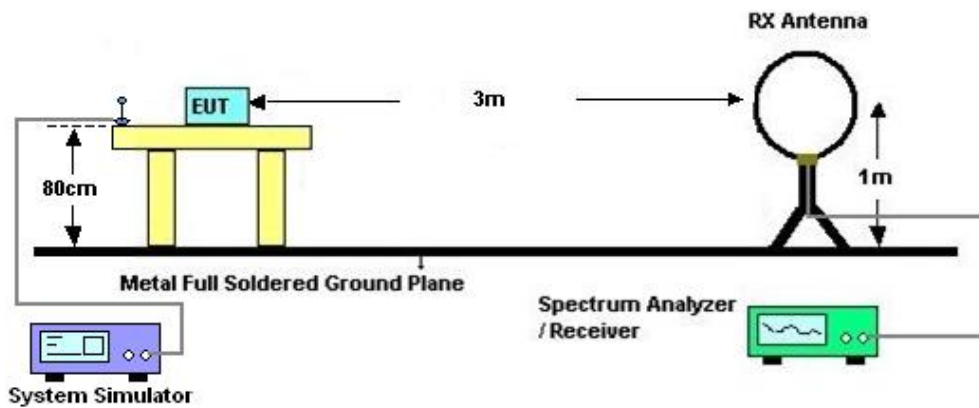

4.2.2 For radiated test from 30MHz to 1GHz

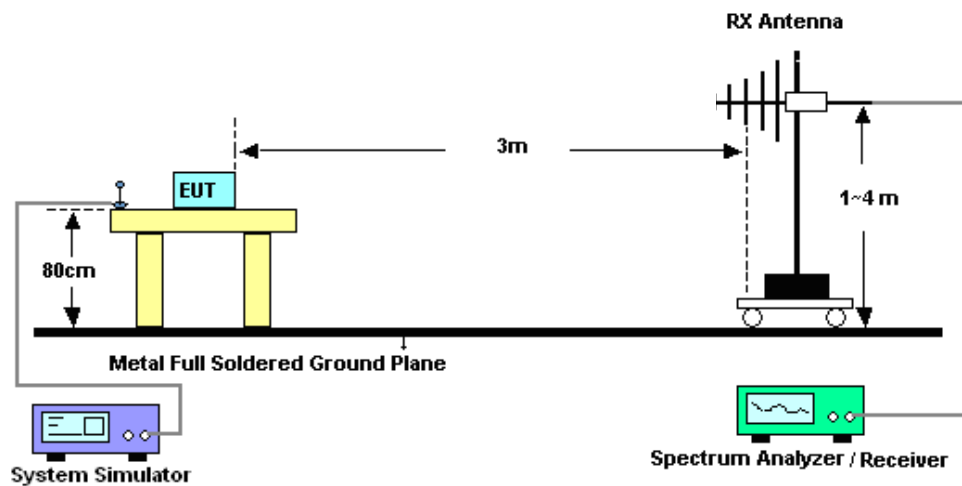

4.2.3 For radiated test above 1GHz

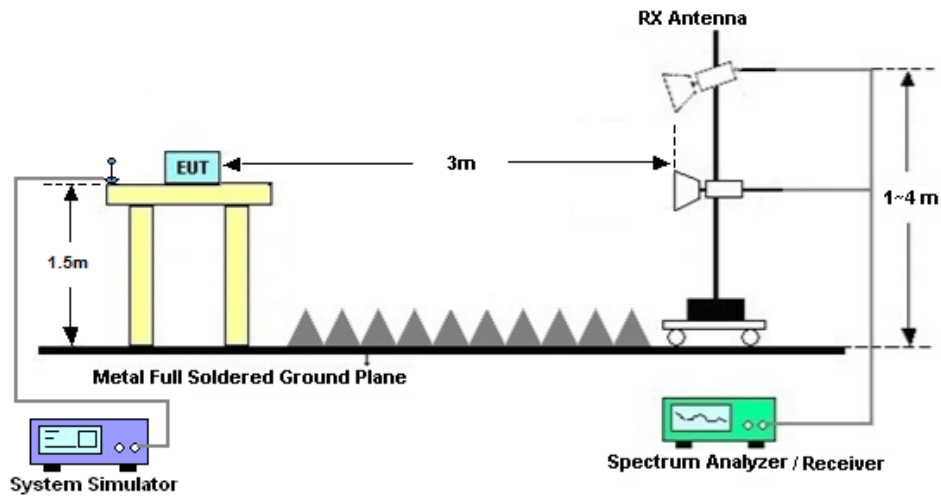

4.3 Test Result of Radiated Test

The low frequency, which started from 9 kHz to 30MHz, was pre-scanned and the result which was 20dB lower than the limit line was not reported.

Please refer to Appendix B.



4.4 Radiated Spurious Emission

4.4.1 Description of Radiated Spurious Emission Measurement

The radiated spurious emission was measured by substitution method according to ANSI C63.26-2015.

The power of any emission outside of the authorized operating frequency ranges must be attenuated below the transmitter power (P) by a factor of at least -40dBm / MHz.

The spectrum is scanned from 30 MHz up to a frequency including its 10th harmonic.

4.4.2 Test Procedures

1. The EUT was placed on a turntable with 0.8 meter height for frequency below 1GHz and 1.5 meter height for frequency above 1GHz respectively above ground.
2. The EUT was set 3 meters from the receiving antenna mounted on the antenna tower.
3. The table was rotated 360 degrees to determine the position of the highest spurious emission.
4. The height of the receiving antenna is varied between 1m to 4m to search the maximum spurious emission for both horizontal and vertical polarizations.
5. During the measurement, the system simulator parameters were set to force the EUT transmitting at maximum output power.
6. Make the measurement with the spectrum analyzer's RBW = 1MHz, VBW = 3MHz, taking the record of maximum spurious emission.
7. A horn antenna was substituted in place of the EUT and was driven by a signal generator. Tune the output power of signal generator to the same emission level with EUT maximum spurious emission.
EIRP (dBm) = S.G. Power – Tx Cable Loss + Tx Antenna Gain
ERP (dBm) = EIRP - 2.15
8. The RF fundamental frequency should be excluded against the limit line in the operating frequency band.
The limit line is -40dBm/MHz



5 List of Measuring Equipment

Instrument	Manufacturer	Model No.	Serial No.	Characteristics	Calibration Date	Test Date	Due Date	Remark
Spectrum Analyzer	R&S	FSV40	101078	10Hz~40GHz	Apr. 06, 2023	Mar. 20, 2024~ Mar. 21, 2024	Apr. 05, 2024	Conducted (TH01-SZ)
DC Power Supply	TTI	PL330P	290070	Max 32V , 3A	Oct. 16, 2023	Mar. 20, 2024~ Mar. 21, 2024	Oct. 15, 2024	Conducted (TH01-SZ)
Power Divider	TOJOIN	PS-2SM-0426 5	60.06.020. 0077	0.4GHz~26.5G Hz	Dec. 25, 2023	Mar. 20, 2024~ Mar. 21, 2024	Dec. 24, 2024	Conducted (TH01-SZ)
Thermal Chamber	Ten Billion Hongzhangrou p	LP-150U	H2014081 803	-40~+150°C	Jul. 05, 2023	Mar. 20, 2024~ Mar. 21, 2024	Jul. 04, 2024	Conducted (TH01-SZ)
EMI Test Receiver&SA	Agilent	N9038A	MY522601 85	20Hz~26.5GHz	Dec. 27, 2023	Mar. 24, 2024	Dec. 26, 2024	Radiation (03CH01-SZ)
Loop Antenna	R&S	HFH2-Z2	100354	9kHz~30MHz	Jul. 28, 2022	Mar. 24, 2024	Jul. 27, 2024	Radiation (03CH01-SZ)
HF Amplifier	KEYSIGHT	83017A	MY532701 05	0.5GHz~26.5Gh z	Oct. 18, 2023	Mar. 24, 2024	Oct. 17, 2024	Radiation (03CH01-SZ)
Bilog Antenna	TeseQ	CBL6112D	35407	30MHz~2GHz	Oct. 24, 2023	Mar. 24, 2024	Oct. 23, 2025	Radiation (03CH01-SZ)
Double Ridge Horn Antenna	ETS-Lindgren	3117	00119436	1GHz~18GHz	Jul. 08, 2023	Mar. 24, 2024	Jul. 07, 2024	Radiation (03CH01-SZ)
SHF-EHF Horn	com-power	AH-840	101071	18Ghz~40GHz	Apr. 08, 2023	Mar. 24, 2024	Apr. 07, 2024	Radiation (03CH01-SZ)
LF Amplifier	Burgeon	BPA-530	102209	0.01~3000Mhz	Apr. 04, 2023	Mar. 24, 2024	Apr. 03, 2024	Radiation (03CH01-SZ)
HF Amplifier	MITEQ	AMF-7D-0010 1800-30-10P- R	1943528	1GHz~18GHz	Oct. 18, 2023	Mar. 24, 2024	Oct. 17, 2024	Radiation (03CH01-SZ)
HF Amplifier	MITEQ	TTA1840-35- HG	1871923	18GHz~40GHz	Jul. 07, 2023	Mar. 24, 2024	Jul. 06, 2024	Radiation (03CH01-SZ)
AC Power Source	Chroma	61601	616010001 985	N/A	Oct. 18, 2023	Mar. 24, 2024	Oct. 17, 2024	Radiation (03CH01-SZ)
Turn Table	EM	EM1000	N/A	0~360 degree	NCR	Mar. 24, 2024	NCR	Radiation (03CH01-SZ)
Antenna Mast	EM	EM1000	N/A	1 m~4 m	NCR	Mar. 24, 2024	NCR	Radiation (03CH01-SZ)

NCR: No Calibration Required



6 Measurement Uncertainty

Uncertainty of Conducted Measurement

Test Item	Uncertainty
Conducted Spurious Emission & Bandedge	±1.34 dB
Occupied Channel Bandwidth	±0.012 MHz
Conducted Power	±1.34 dB
Conducted Power Density	±1.32 dB
Peak to Average Ratio	±1.34 dB
Frequency Stability	±1.3 ppm

Uncertainty of Radiated Emission Measurement (30 MHz ~ 1000 MHz)

Measuring Uncertainty for a Level of Confidence of 95% (U = 2Uc(y))	2.48 dB
---	---------

Uncertainty of Radiated Emission Measurement (1 GHz ~ 18 GHz)

Measuring Uncertainty for a Level of Confidence of 95% (U = 2Uc(y))	3.53 dB
---	---------

Uncertainty of Radiated Emission Measurement (18 GHz ~ 40 GHz)

Measuring Uncertainty for a Level of Confidence of 95% (U = 2Uc(y))	4.02 dB
---	---------

----- THE END -----



Appendix A. Test Results of Conducted Test

Test Engineer :	Lorenzo Liu	Temperature :	24~26°C
		Relative Humidity :	50~53%

Conducted Output Power(Average power) and EIRP

LTE Band 42_Ant.2:

BW [MHz]	Modulation	RB Size	RB Offset	Power Low Ch. / Freq.	Power Middle Ch. / Freq.	Power High Ch. / Freq.	EIRP(W)		
Channel				43190	43340	43490			
Frequency (MHz)				3560	3575	3590	L	M	H
20	QPSK	1	0	22.98	23.12	22.91	0.1578	0.1629	0.1552
20	QPSK	1	49	22.93	22.93	22.82	0.1560	0.1560	0.1521
20	QPSK	1	99	22.79	22.84	22.69	0.1510	0.1528	0.1476
20	QPSK	50	0	22.14	22.22	22.02	0.1300	0.1324	0.1265
20	QPSK	50	24	22.10	22.18	21.96	0.1288	0.1312	0.1247
20	QPSK	50	50	22.01	22.08	21.90	0.1262	0.1282	0.1230
20	QPSK	100	0	22.05	22.12	21.94	0.1274	0.1294	0.1242
20	16QAM	1	0	22.38	22.44	22.28	0.1374	0.1393	0.1343
20	64QAM	1	0	21.26	21.33	21.14	0.1062	0.1079	0.1033
20	256QAM	1	0	18.31	17.94	17.83	0.0538	0.0494	0.0482
Channel				43165	43340	43515	EIRP(W)		
Frequency (MHz)				3557.5	3575	3592.5	L	M	H
15	QPSK	1	0	22.77	22.93	22.75	0.1503	0.1560	0.1496
15	16QAM	1	0	22.19	22.33	22.11	0.1315	0.1358	0.1291
Channel				43140	43340	43540	EIRP(W)		
Frequency (MHz)				3555	3575	3595	L	M	H
10	QPSK	1	0	22.85	22.88	22.73	0.1531	0.1542	0.1489
10	16QAM	1	0	22.24	22.29	22.06	0.1330	0.1346	0.1276
Channel				43115	43340	43565	EIRP(W)		
Frequency (MHz)				3552.5	3575	3597.5	L	M	H
5	QPSK	1	0	22.80	22.99	22.75	0.1514	0.1581	0.1496
5	16QAM	1	0	22.26	22.26	22.08	0.1337	0.1337	0.1282



LTE Band 48_Ant.2:

BW [MHz]	Modulation	RB Size	RB Offset	Power Low Ch. / Freq.	Power Middle Ch. / Freq.	Power High Ch. / Freq.	EIRP(W)		
Channel				55340	55990	56640			
Frequency (MHz)				3560	3625	3690	L	M	H
20	QPSK	1	0	23.17	23.05	22.95	0.1648	0.1603	0.1567
20	QPSK	1	49	23.10	23.01	23.06	0.1622	0.1589	0.1607
20	QPSK	1	99	22.99	23.05	23.06	0.1581	0.1603	0.1607
20	QPSK	50	0	22.15	22.02	21.98	0.1303	0.1265	0.1253
20	QPSK	50	24	22.11	21.98	22.04	0.1291	0.1253	0.1271
20	QPSK	50	50	22.08	21.96	22.05	0.1282	0.1247	0.1274
20	QPSK	100	0	22.10	22.00	22.04	0.1288	0.1259	0.1271
20	16QAM	1	0	22.15	22.08	22.10	0.1303	0.1282	0.1288
20	64QAM	1	0	21.11	21.02	21.01	0.1026	0.1005	0.1002
20	256QAM	1	0	18.00	17.93	17.96	0.0501	0.0493	0.0497
Channel				55315	55990	56665	EIRP(W)		
Frequency (MHz)				3557.5	3625	3692.5	L	M	H
15	QPSK	1	0	23.00	22.93	22.82	0.1585	0.1560	0.1521
15	16QAM	1	0	22.04	21.85	21.87	0.1271	0.1216	0.1222
Channel				55290	55990	56690	EIRP(W)		
Frequency (MHz)				3555	3625	3695	L	M	H
10	QPSK	1	0	23.02	22.89	22.75	0.1592	0.1545	0.1496
10	16QAM	1	0	22.00	21.90	21.89	0.1259	0.1230	0.1227
Channel				55265	55990	56715	EIRP(W)		
Frequency (MHz)				3552.5	3625	3697.5	L	M	H
5	QPSK	1	0	23.05	22.83	22.77	0.1603	0.1524	0.1503
5	16QAM	1	0	21.97	21.89	21.89	0.1250	0.1227	0.1227



LTE Band 48

26dB Bandwidth

Mode	LTE Band 48 : 26dB BW(MHz)											
	BW				5MHz		10MHz		15MHz		20MHz	
Mod.				QPSK	16QAM	QPSK	16QAM	QPSK	16QAM	QPSK	16QAM	
Middle CH				4.93	4.79	9.61	9.63	14.51	14.15	18.66	18.78	



LTE Band 48

Middle Channel / 5MHz / QPSK

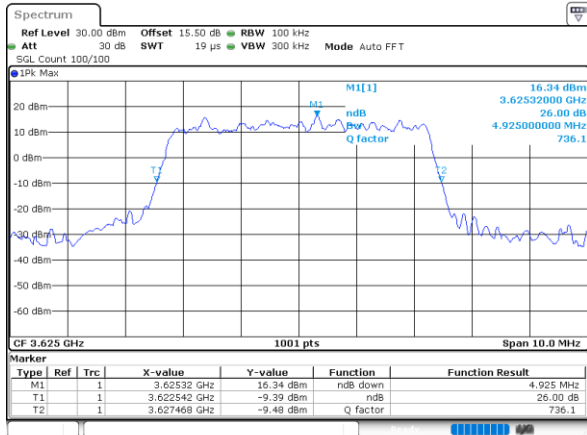

Date: 20_MAR_2024 04:47:44

Middle Channel / 5MHz / 16QAM

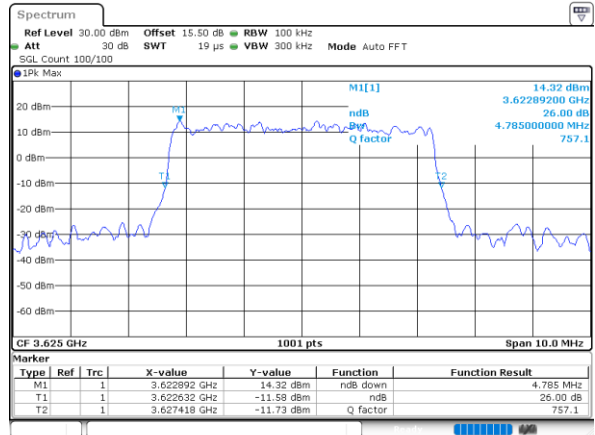

Date: 20_MAR_2024 04:48:10

Middle Channel / 10MHz / QPSK

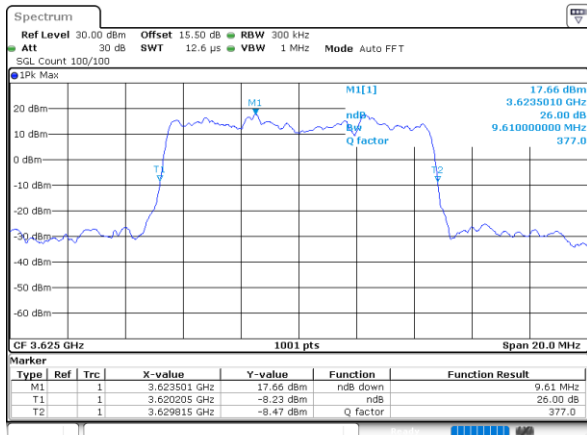

Date: 20_MAR_2024 05:55:16

Middle Channel / 10MHz / 16QAM

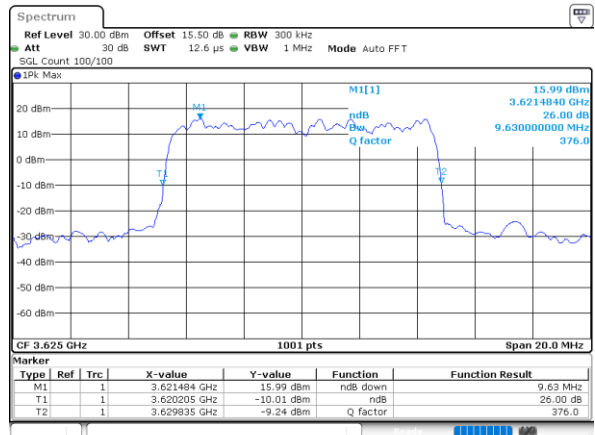

Date: 20_MAR_2024 05:55:43

Middle Channel / 15MHz / QPSK

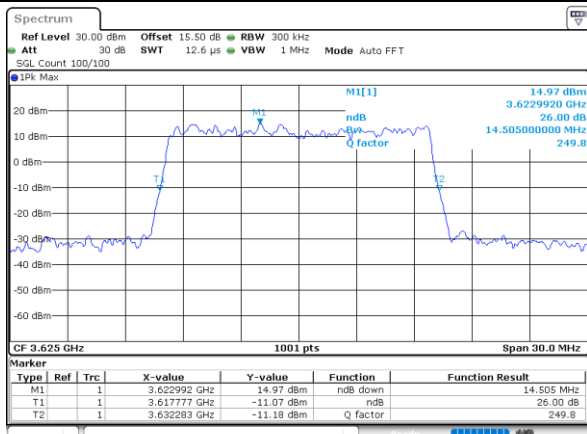

Date: 20_MAR_2024 07:10:25

Middle Channel / 15MHz / 16QAM

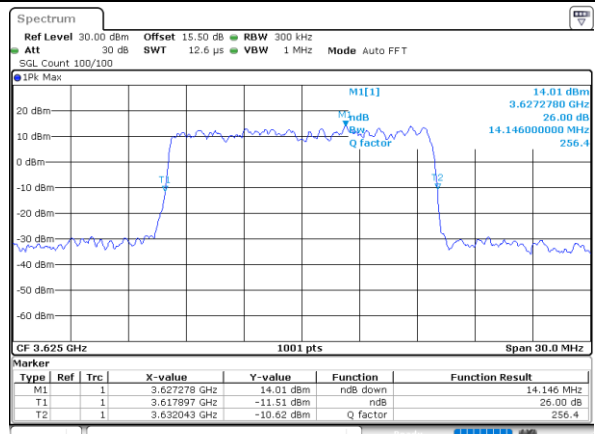

Date: 20_MAR_2024 07:10:52



LTE Band 48

Middle Channel / 20MHz / QPSK

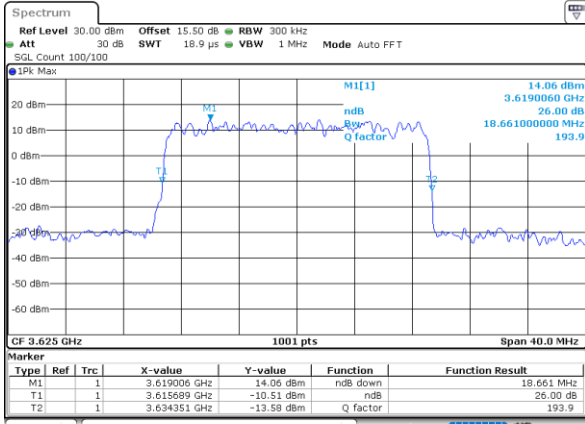

Middle Channel / 20MHz / 16QAM

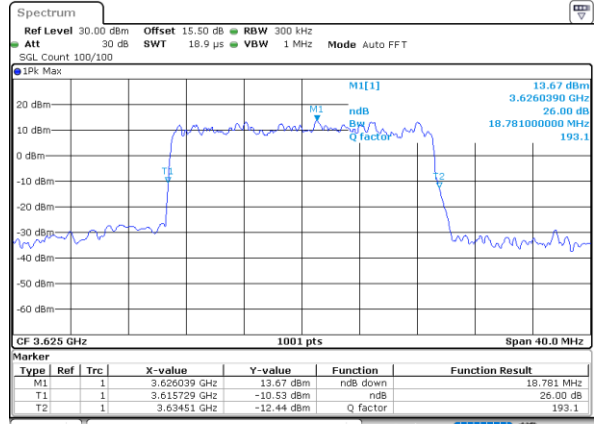



Occupied Bandwidth

Mode	LTE Band 48 : 99%OBW(MHz)											
	BW				5MHz		10MHz		15MHz		20MHz	
Mod.					QPSK	16QAM	QPSK	16QAM	QPSK	16QAM	QPSK	16QAM
Middle CH					4.50	4.51	9.01	9.07	13.43	13.43	17.86	17.82



LTE Band 48

Middle Channel / 5MHz / QPSK

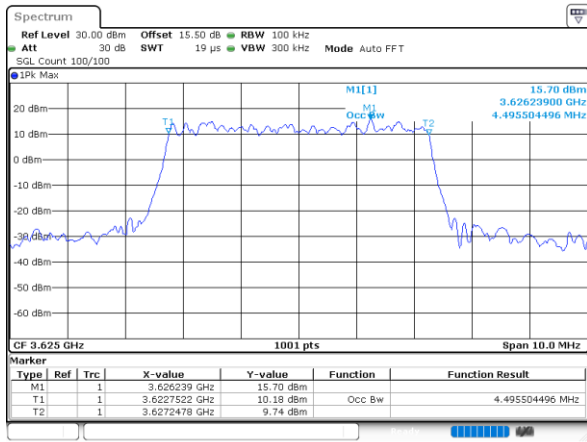

Date: 20_MAR_2024 04:47:30

Middle Channel / 5MHz / 16QAM

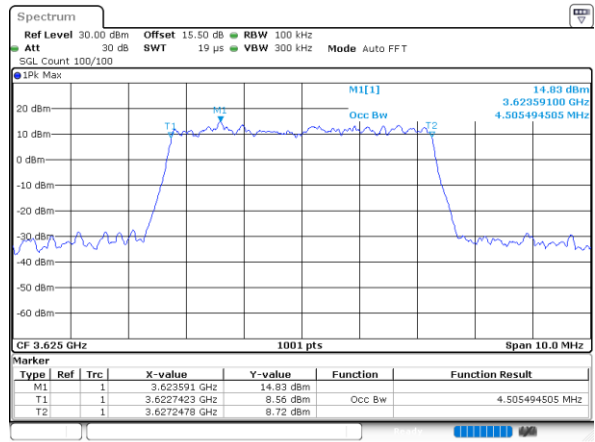

Date: 20_MAR_2024 04:48:24

Middle Channel / 10MHz / QPSK

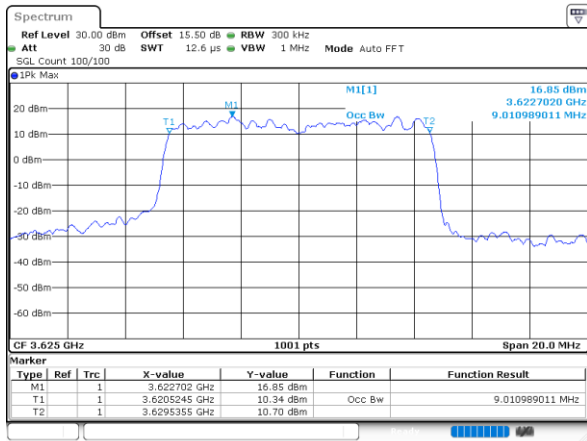

Date: 20_MAR_2024 05:55:03

Middle Channel / 10MHz / 16QAM

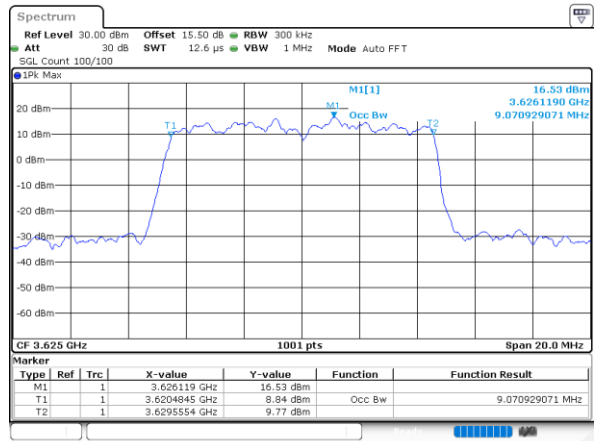

Date: 20_MAR_2024 05:55:57

Middle Channel / 15MHz / QPSK

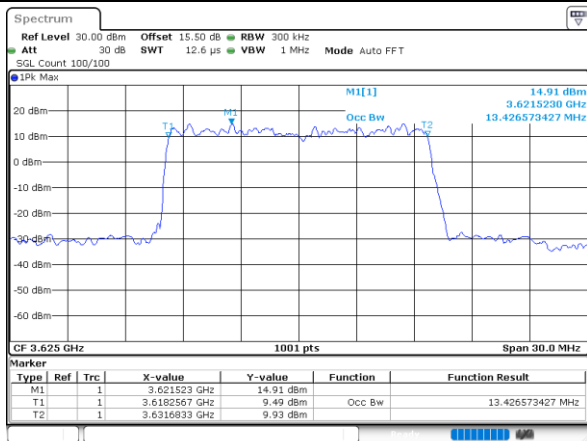

Date: 20_MAR_2024 07:05:11

Middle Channel / 15MHz / 16QAM

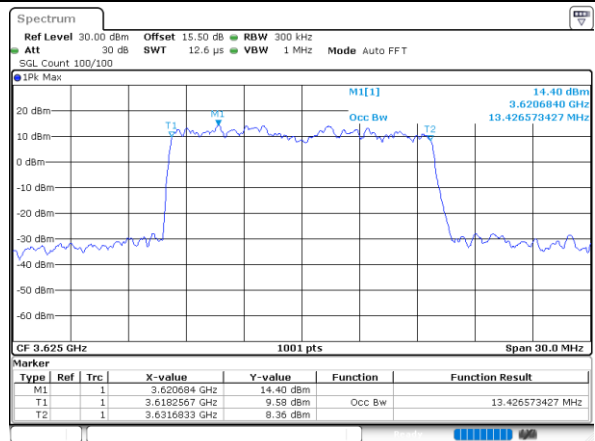

Date: 20_MAR_2024 07:06:06



LTE Band 48

Middle Channel / 20MHz / QPSK

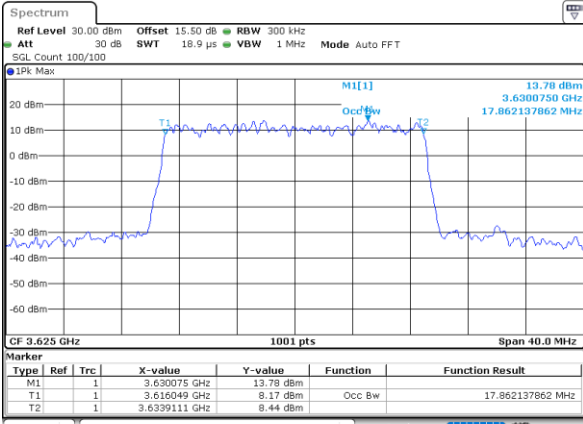

Date: 20.MAR.2024 08:16:07

Middle Channel / 20MHz / 16QAM

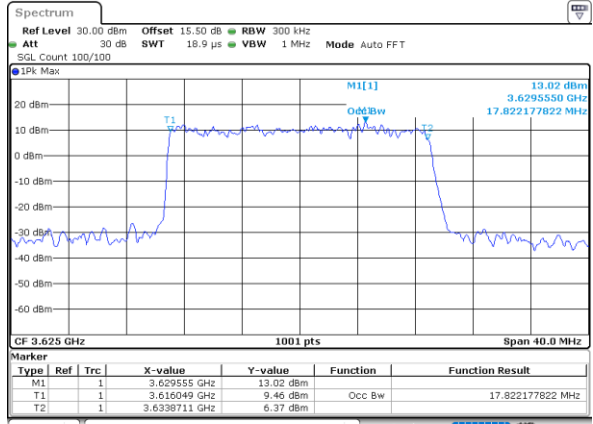

Date: 20.MAR.2024 08:15:13



ACLR

LTE Band 48 / 5MHz

QPSK

Lowest Channel / 1RB0

Lowest Channel / 1RBmax

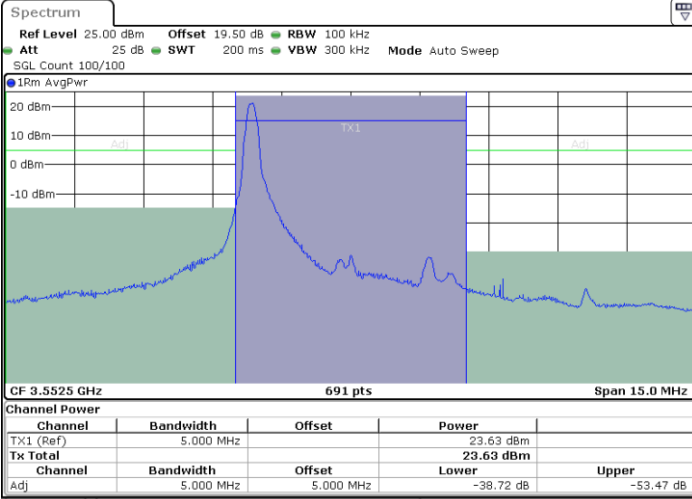

Date: 20.MAR.2024 04:11:03

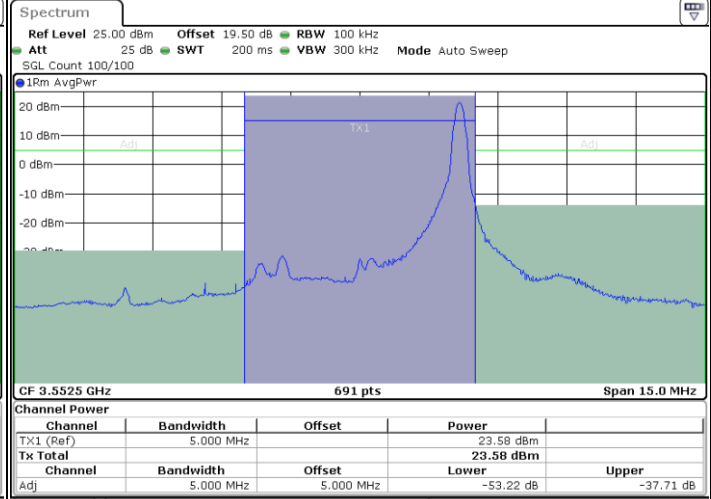

Date: 20.MAR.2024 04:11:49

Lowest Channel / FullIRB

N/A

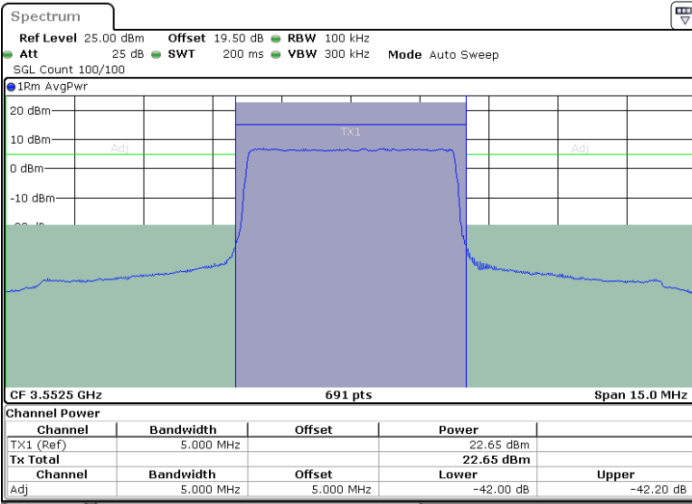

Date: 20.MAR.2024 04:07:11



LTE Band 48 / 5MHz

QPSK

Middle Channel / 1RB0

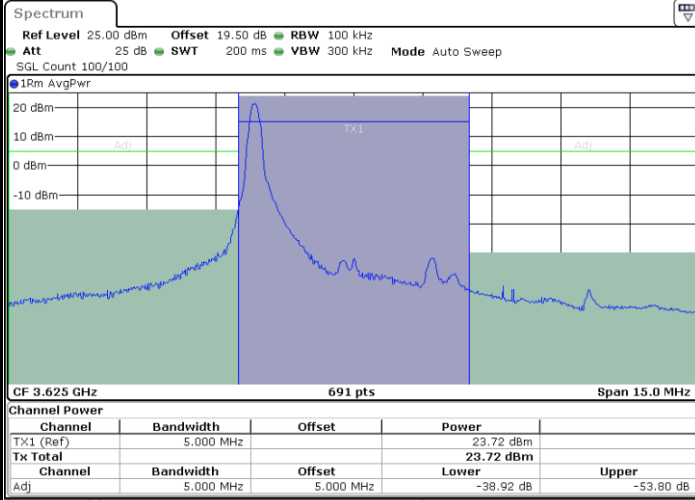

Date: 20.MAR.2024 04:31:20

Middle Channel / 1RBmax

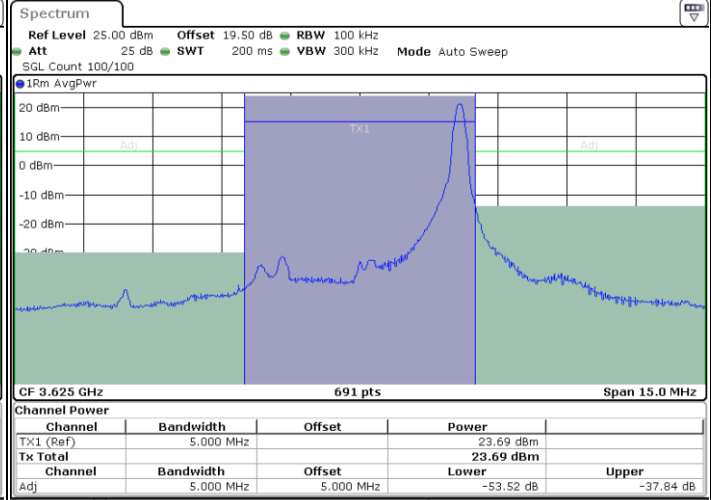

Date: 20.MAR.2024 04:30:35

Middle Channel / FullIRB

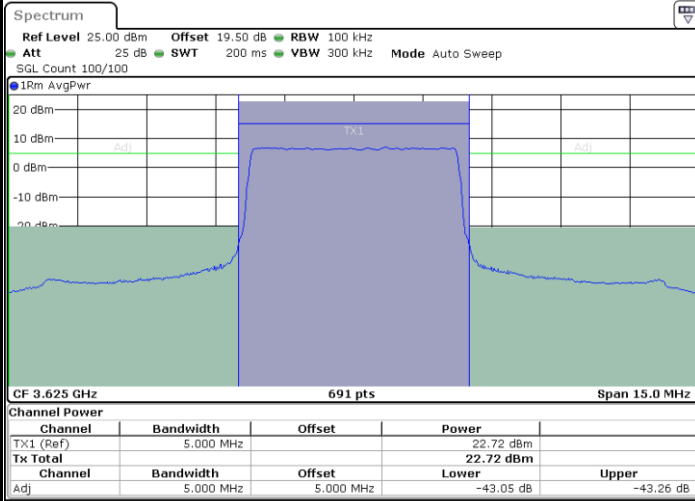

Date: 20.MAR.2024 04:35:08

N/A



LTE Band 48 / 5MHz

QPSK

Highest Channel / 1RB0

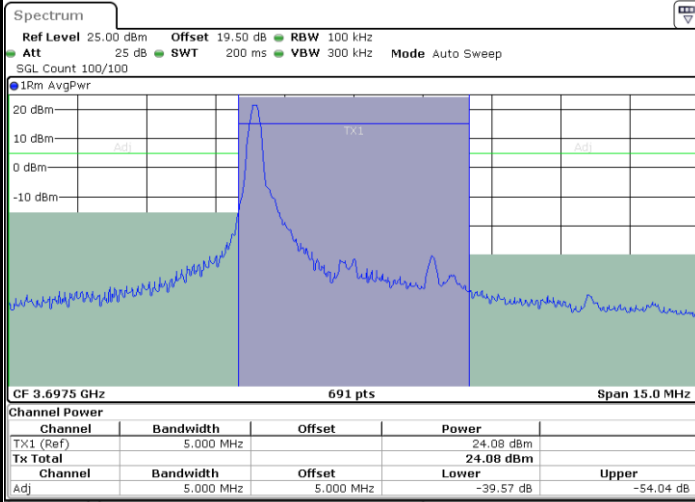

Date: 20.MAR.2024 04:56:42

Highest Channel / 1RBmax

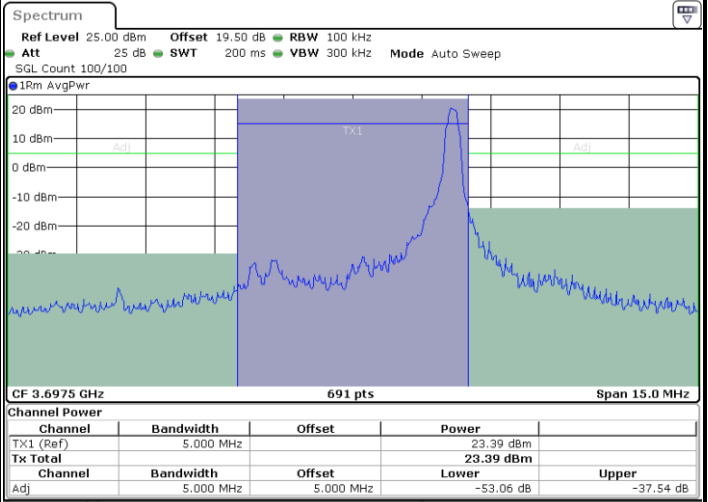

Date: 20.MAR.2024 04:55:55

Highest Channel / FullRB

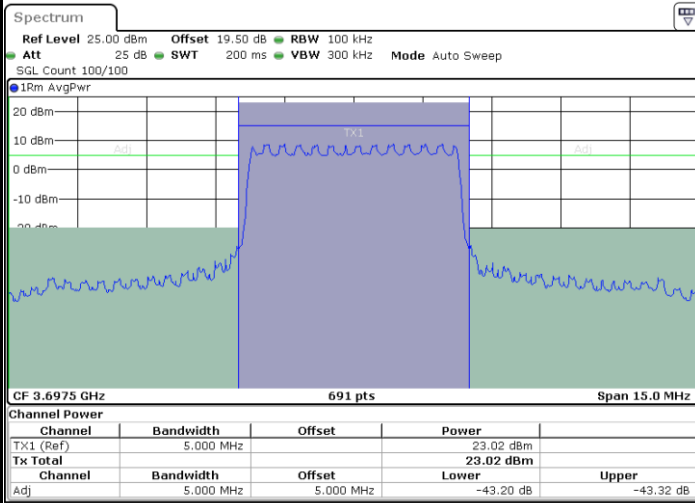

Date: 20.MAR.2024 04:51:59

N/A



LTE Band 48 / 10MHz

QPSK

Lowest Channel / 1RB0

Lowest Channel / 1RBmax

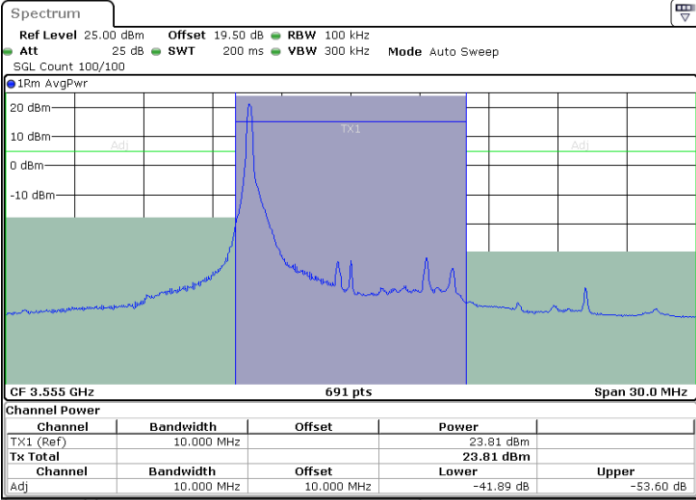

Date: 20.MAR.2024 05:19:27

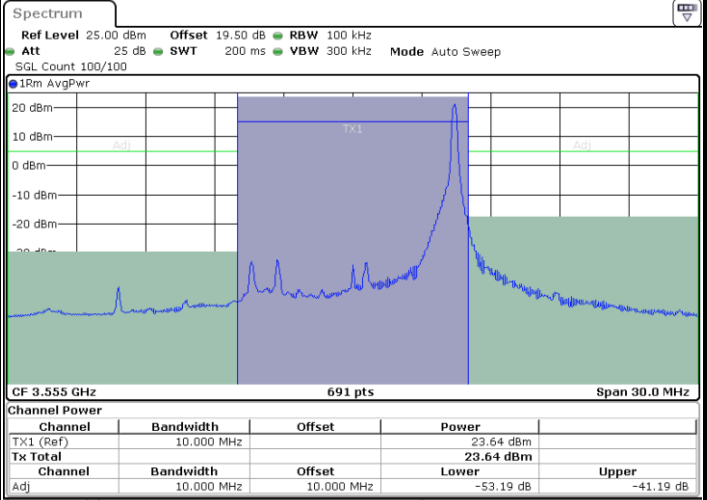

Date: 20.MAR.2024 05:18:41

Lowest Channel / FullIRB

N/A

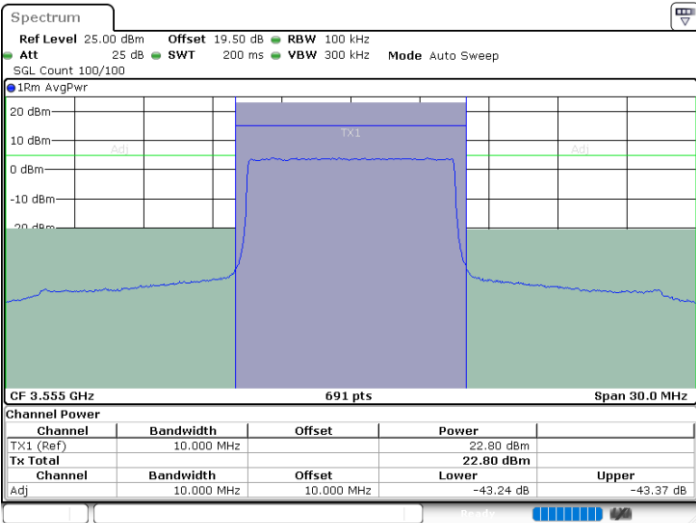

Date: 20.MAR.2024 05:14:49



LTE Band 48 / 10MHz

QPSK

Middle Channel / 1RB0

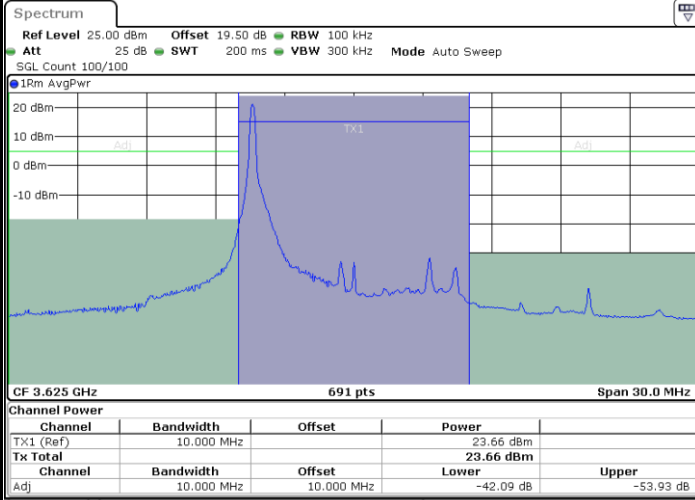

Date: 20.MAR.2024 05:38:03

Middle Channel / 1RBmax

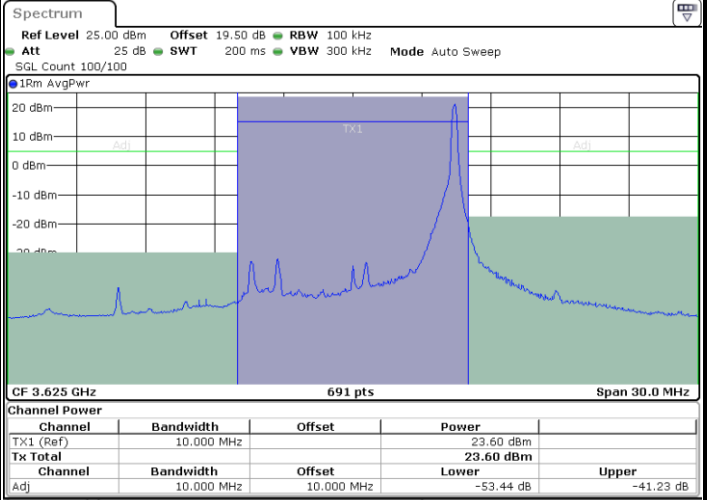

Date: 20.MAR.2024 05:38:49

Middle Channel / FullIRB

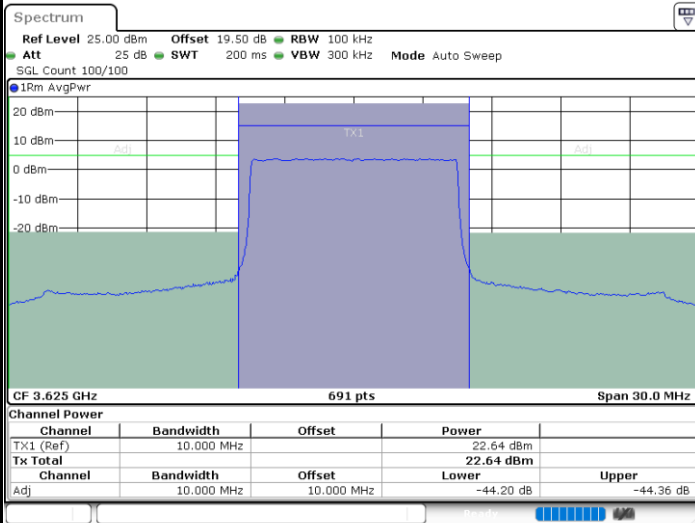

Date: 20.MAR.2024 05:42:40

N/A



LTE Band 48 / 10MHz

QPSK

Highest Channel / 1RB0

Highest Channel / 1RBmax

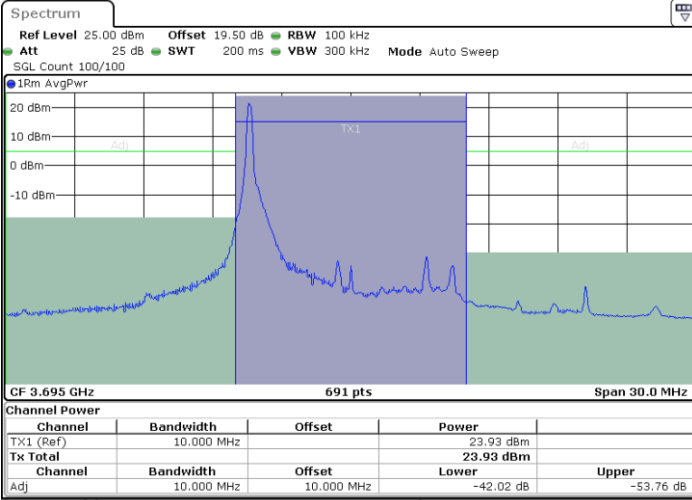

Date: 20.MAR.2024 06:04:16

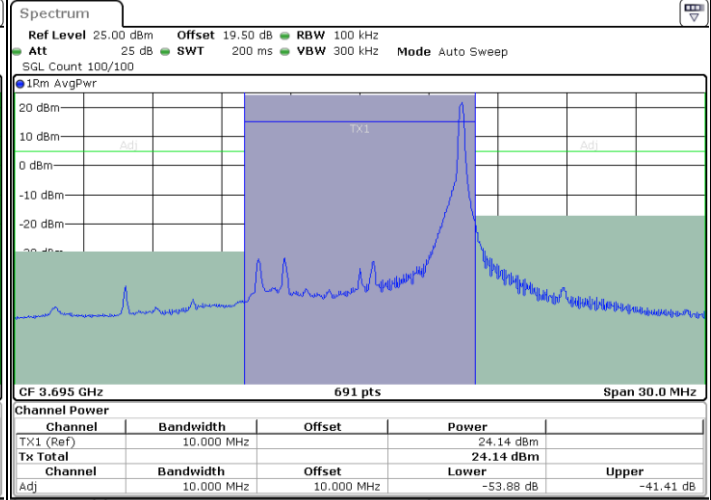

Date: 20.MAR.2024 06:03:28

Highest Channel / FullRB

N/A

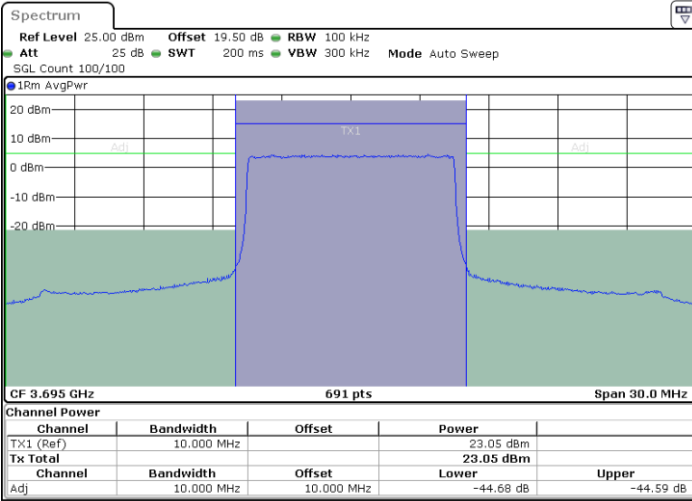

Date: 20.MAR.2024 05:59:32



LTE Band 48 / 15MHz

QPSK

Lowest Channel / 1RB0

Lowest Channel / 1RBmax

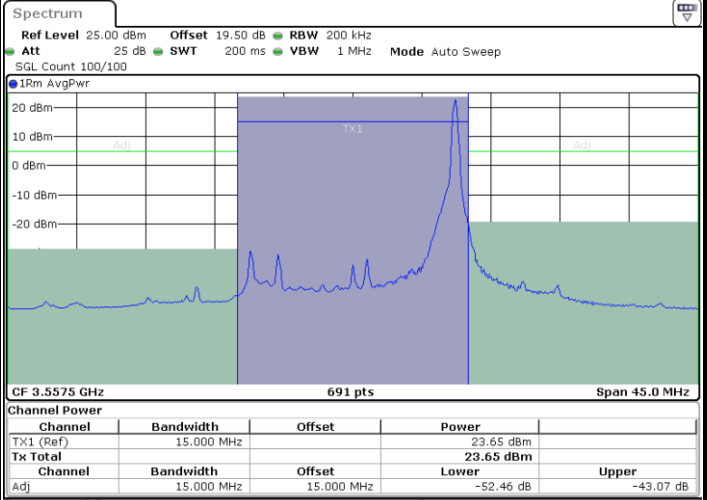
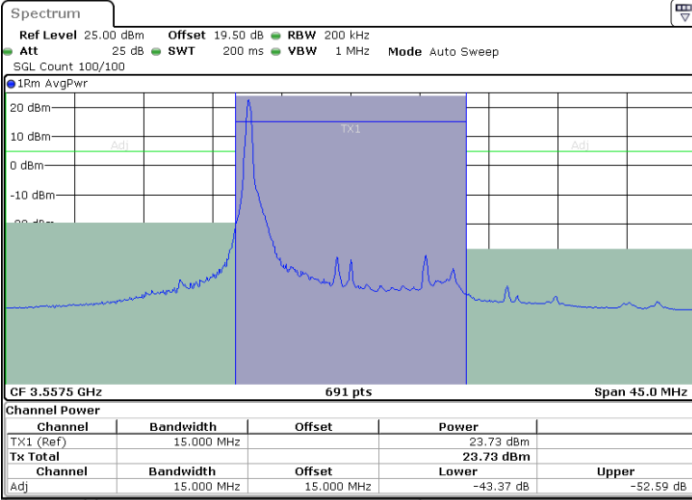

Date: 20.MAR.2024 06:26:53

Date: 20.MAR.2024 06:26:06

Lowest Channel / FullIRB

N/A

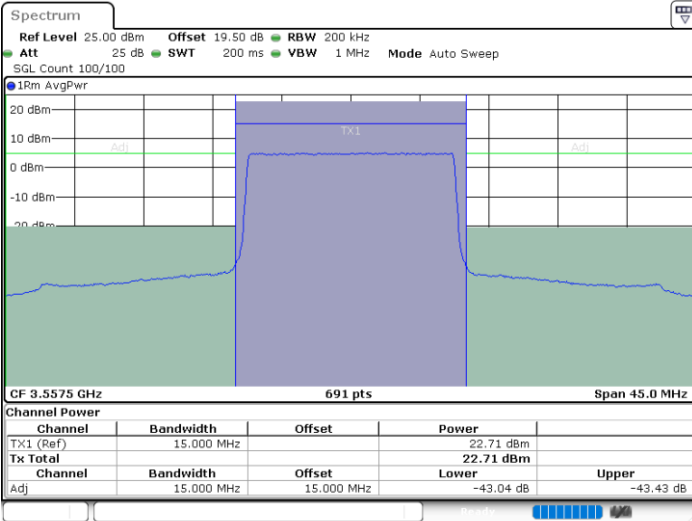

Date: 20.MAR.2024 06:22:11



LTE Band 48 / 15MHz

QPSK

Middle Channel / 1RB0

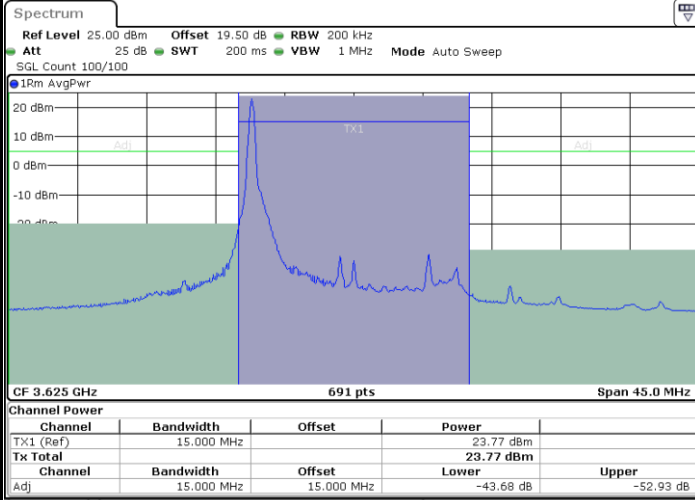

Date: 20.MAR.2024 06:45:32

Middle Channel / 1RBmax

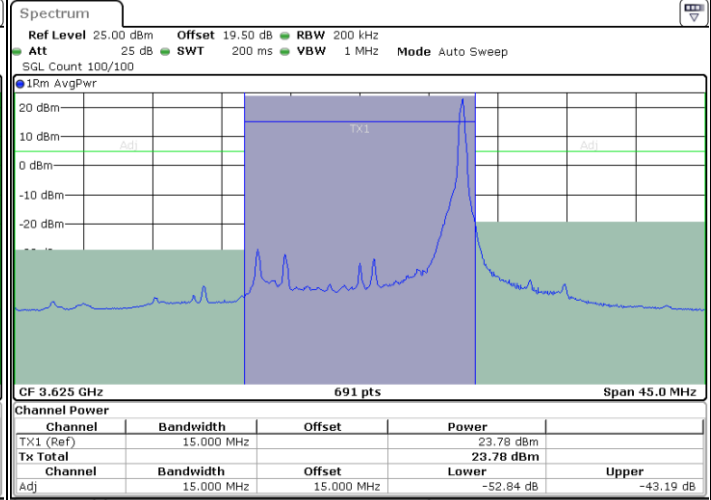

Date: 20.MAR.2024 06:46:18

Middle Channel / FullIRB

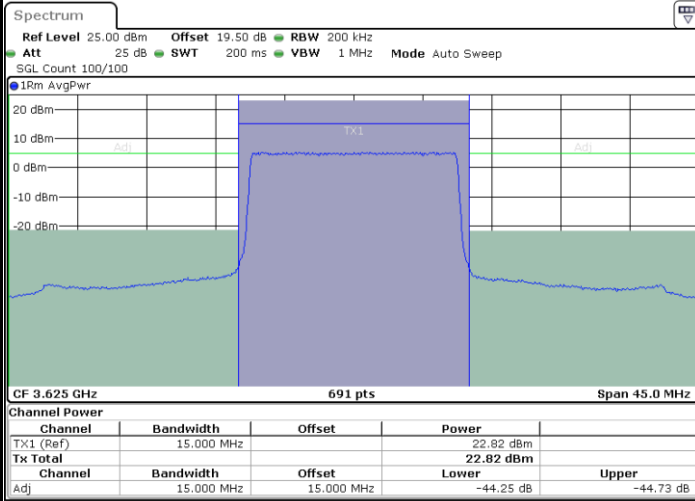

Date: 20.MAR.2024 06:50:09

N/A



LTE Band 48 / 15MHz

QPSK

Highest Channel / 1RB0

Highest Channel / 1RBmax

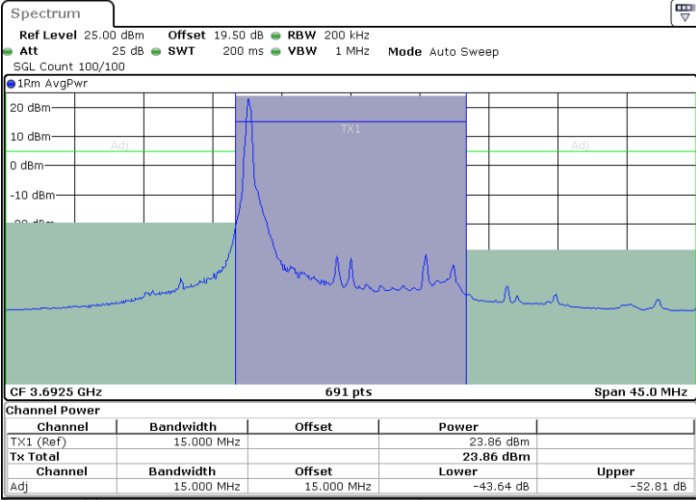

Date: 20.MAR.2024 07:14:26

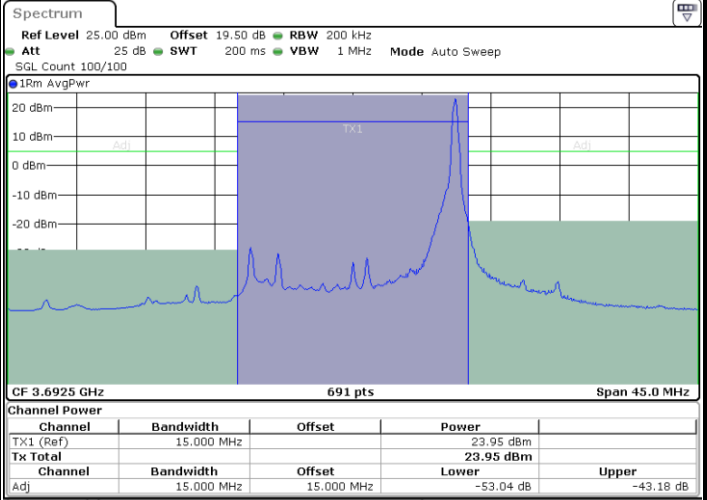

Date: 20.MAR.2024 07:13:38

Highest Channel / FullRB

N/A

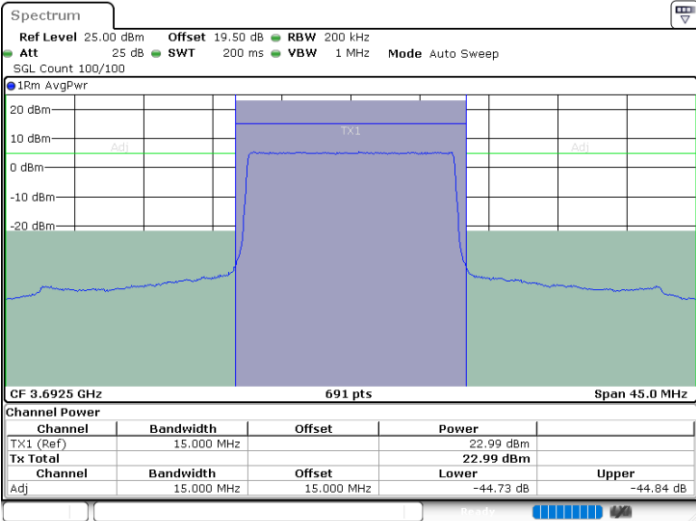

Date: 20.MAR.2024 07:09:40



LTE Band 48 / 20MHz

QPSK

Lowest Channel / 1RB0

Lowest Channel / 1RBmax

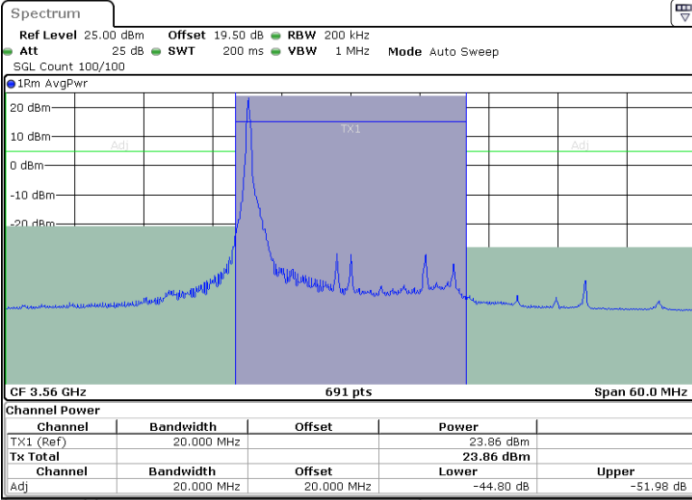

Date: 20.MAR.2024 07:38:30

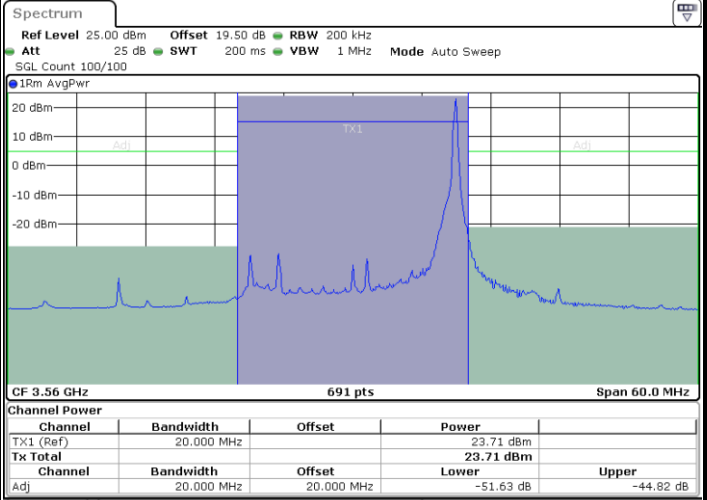

Date: 20.MAR.2024 07:34:40

Lowest Channel / FullIRB

N/A

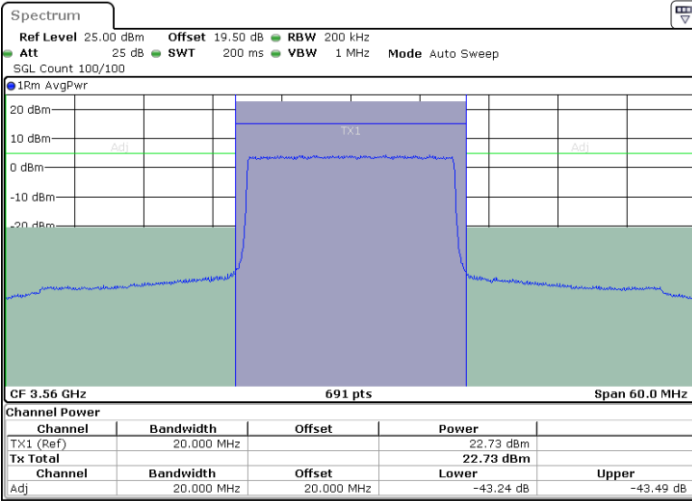

Date: 20.MAR.2024 07:32:21



LTE Band 48 / 20MHz

QPSK

Middle Channel / 1RB0

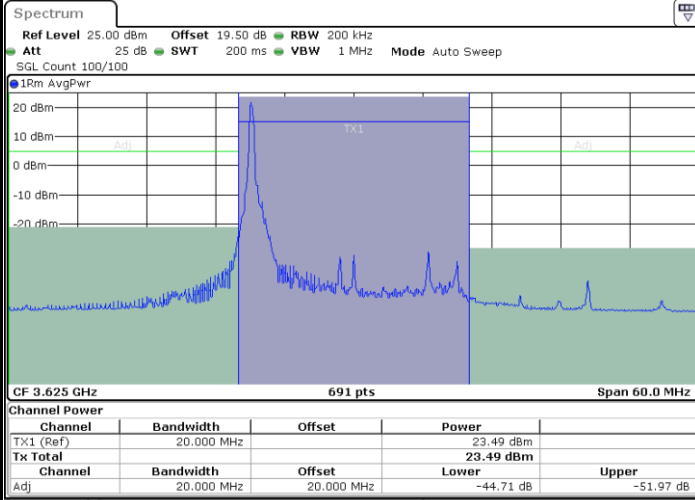

Date: 20.MAR.2024 07:54:05

Middle Channel / 1RBmax

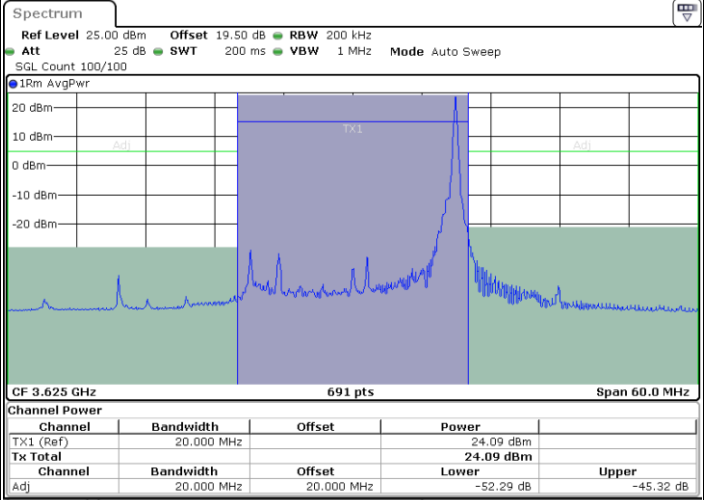

Date: 20.MAR.2024 07:57:53

Middle Channel / FullIRB

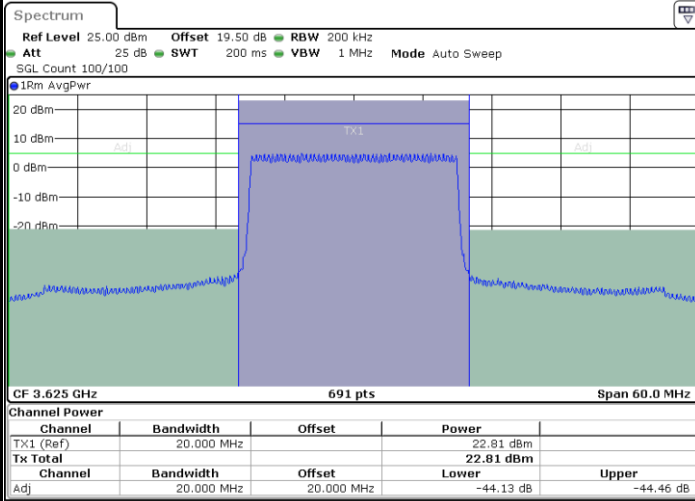

Date: 20.MAR.2024 07:58:39

N/A



LTE Band 48 / 20MHz

QPSK

Highest Channel / 1RB0

Highest Channel / 1RBmax

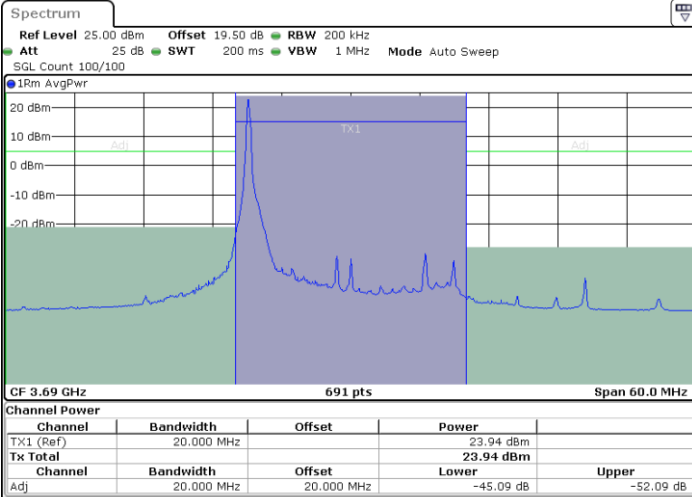

Date: 20.MAR.2024 08:27:12

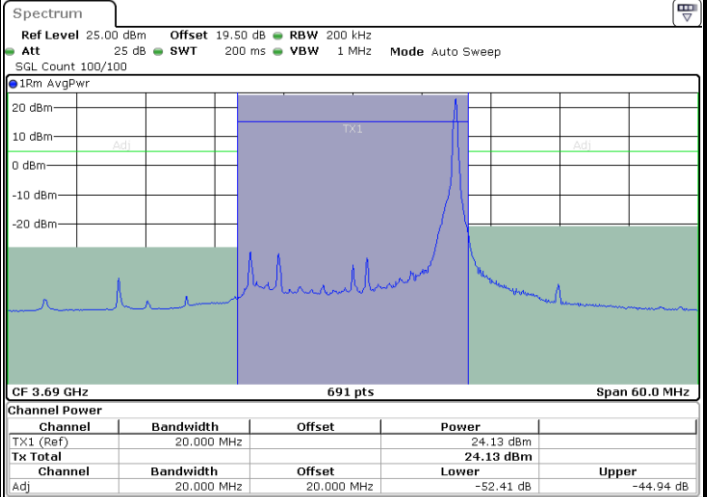

Date: 20.MAR.2024 08:23:21

Highest Channel / FullRB

N/A

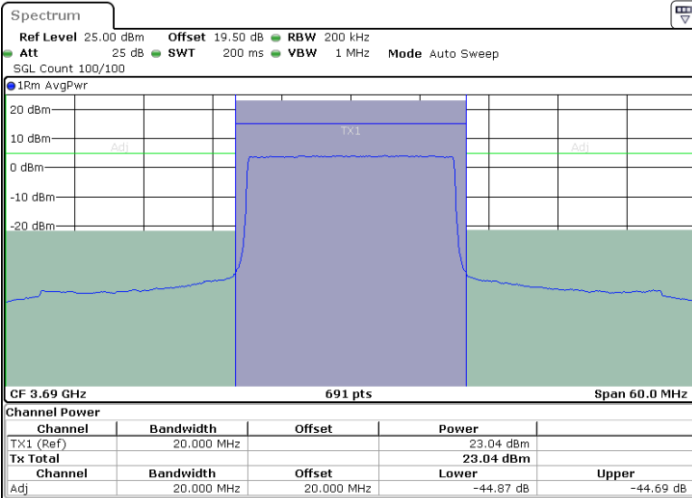

Date: 20.MAR.2024 08:22:35



LTE Band 48 / 5MHz

16QAM

Lowest Channel / 1RB0

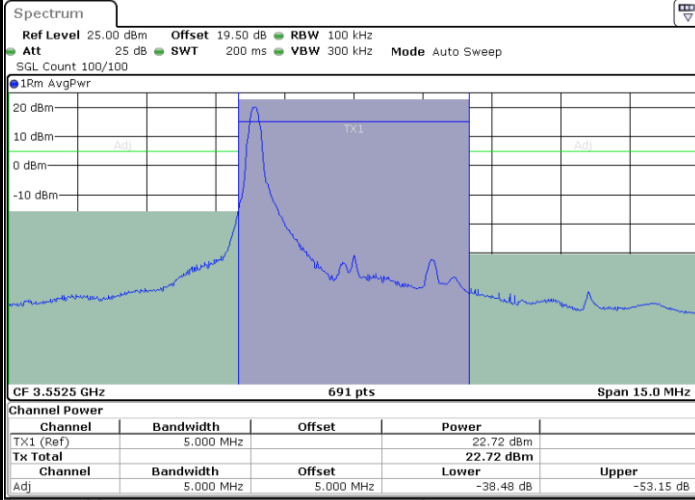

Date: 20.MAR.2024 04:10:16

Lowest Channel / 1RBmax

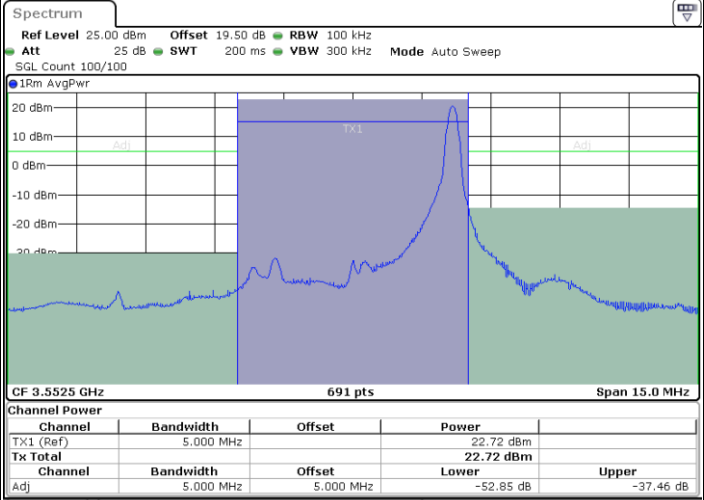

Date: 20.MAR.2024 04:12:35

Lowest Channel / FullIRB

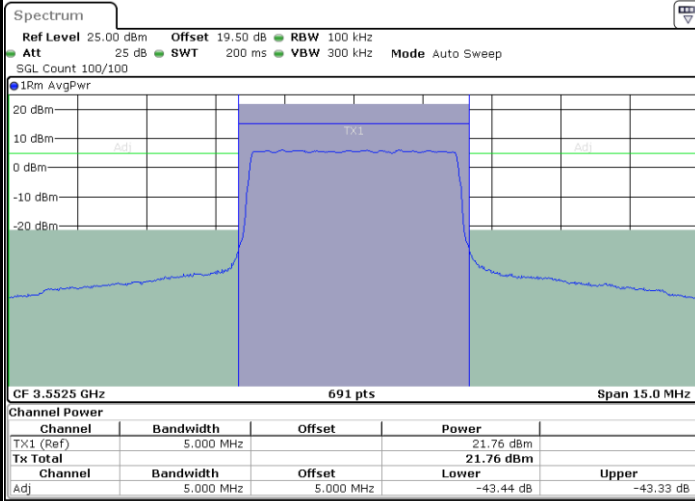

Date: 20.MAR.2024 04:07:57

N/A



LTE Band 48 / 5MHz

16QAM

Middle Channel / 1RB0

Middle Channel / 1RBmax

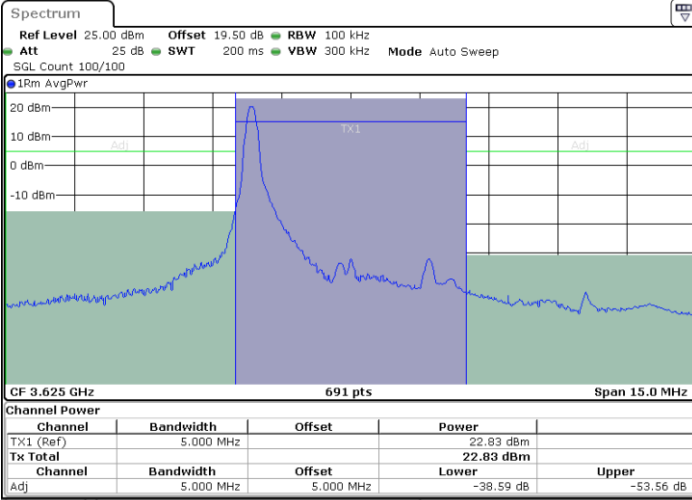

Date: 20.MAR.2024 04:32:06

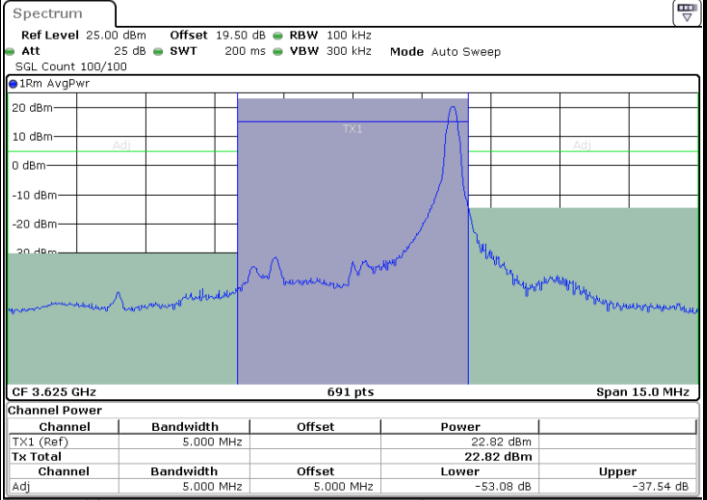

Date: 20.MAR.2024 04:29:49

Middle Channel / FullIRB

N/A

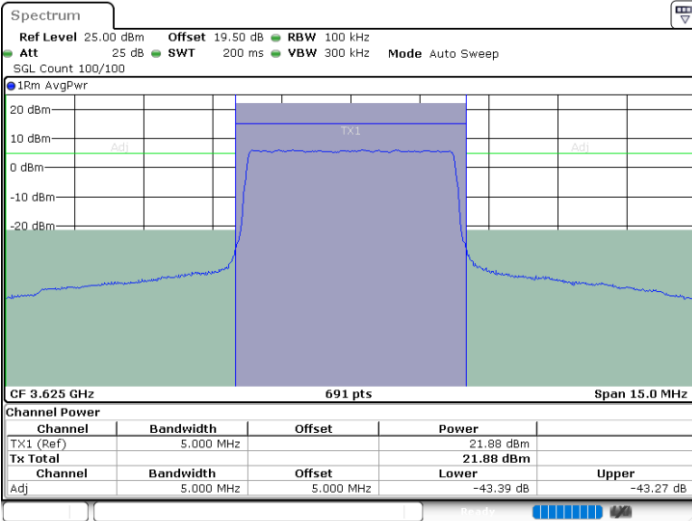

Date: 20.MAR.2024 04:34:22



LTE Band 48 / 5MHz

16QAM

Highest Channel / 1RB0

Highest Channel / 1RBmax

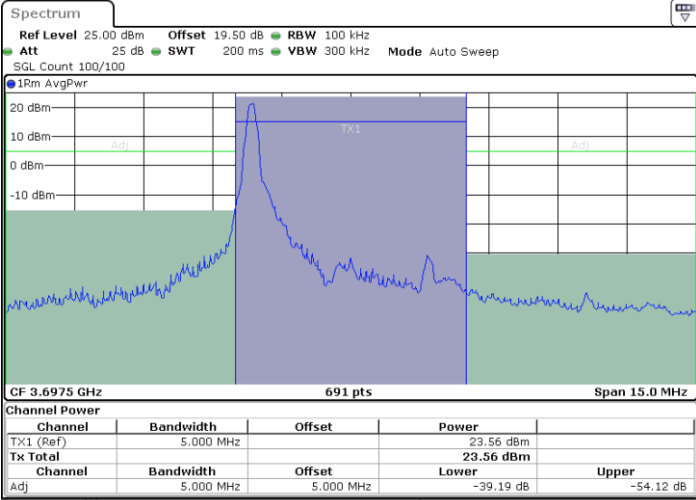

Date: 20.MAR.2024 04:57:29

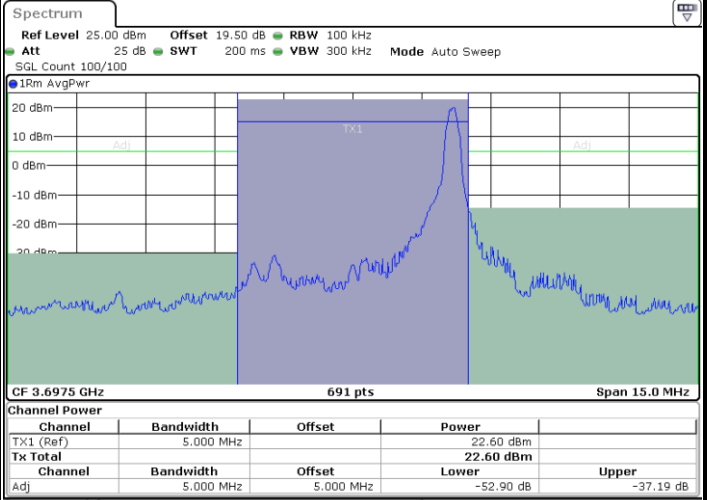

Date: 20.MAR.2024 04:55:08

Highest Channel / FullRB

N/A

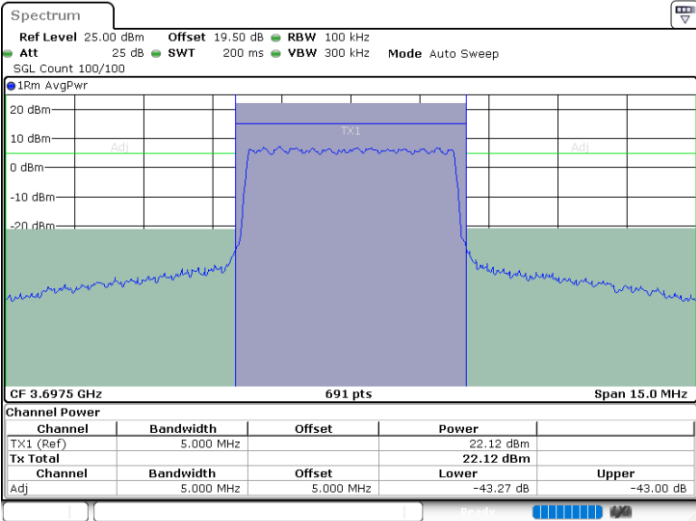

Date: 20.MAR.2024 04:52:46



LTE Band 48 / 10MHz

16QAM

Lowest Channel / 1RB0

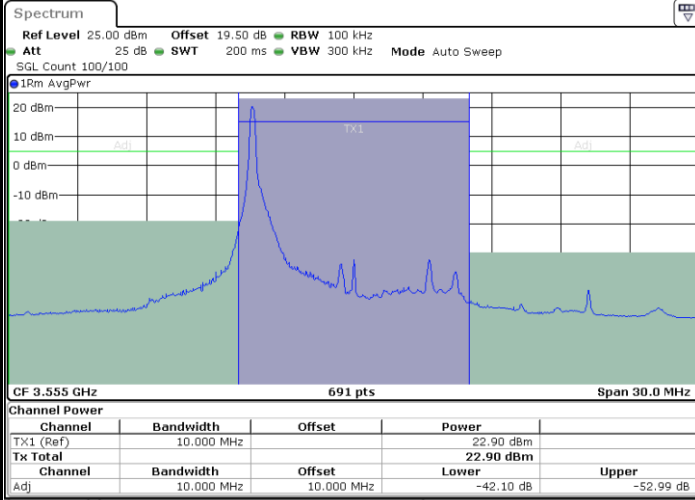

Date: 20.MAR.2024 05:20:14

Lowest Channel / 1RBmax

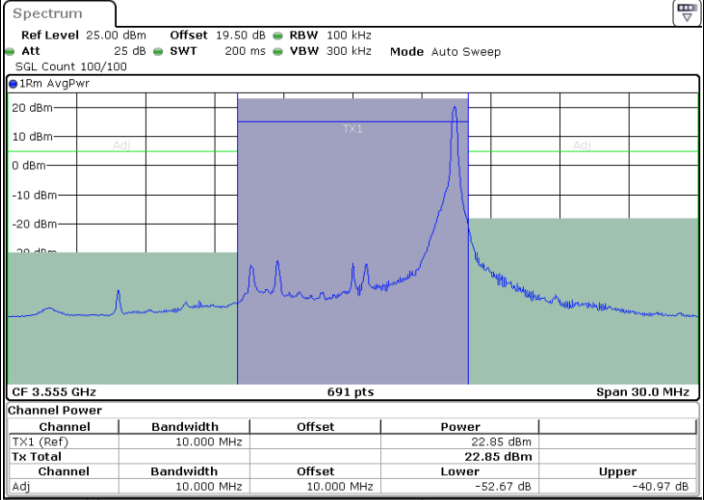

Date: 20.MAR.2024 05:17:55

Lowest Channel / FullIRB

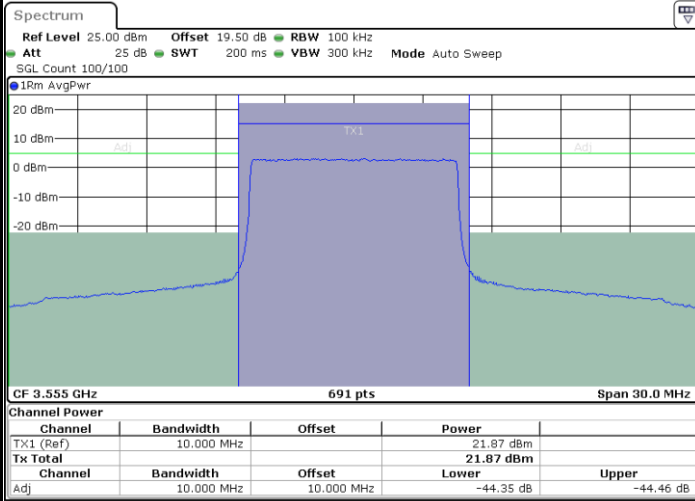

Date: 20.MAR.2024 05:15:35

N/A



LTE Band 48 / 10MHz

16QAM

Middle Channel / 1RB0

Middle Channel / 1RBmax

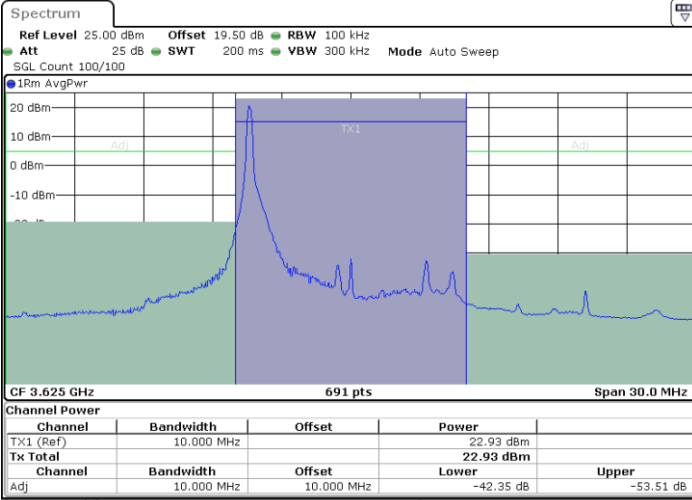

Date: 20.MAR.2024 05:37:17

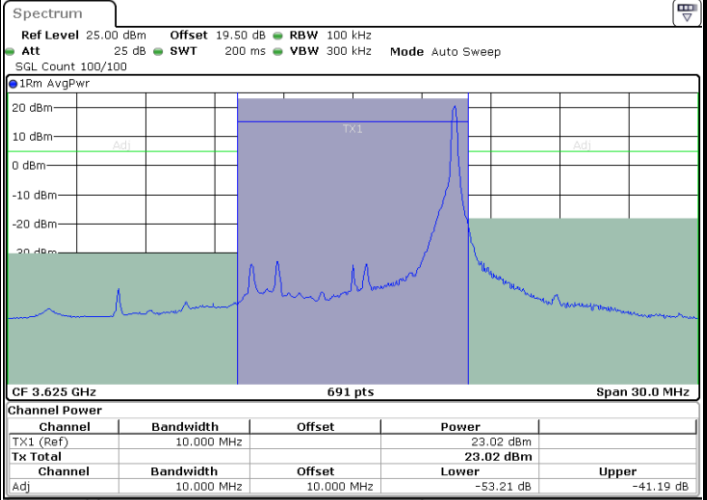

Date: 20.MAR.2024 05:39:35

Middle Channel / FullIRB

N/A

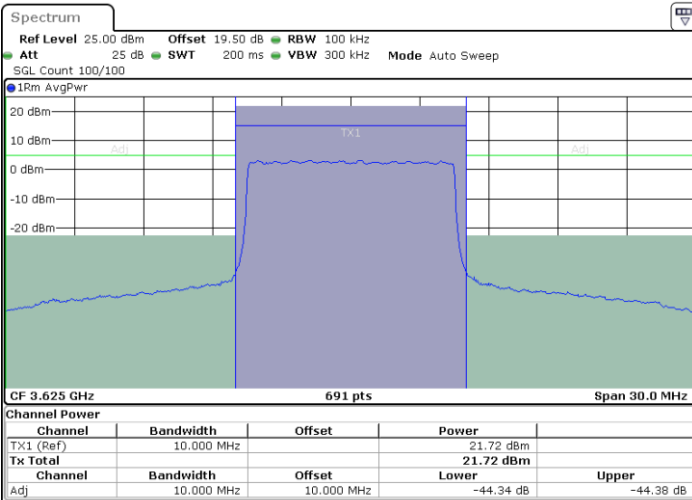

Date: 20.MAR.2024 05:41:53



LTE Band 48 / 10MHz

16QAM

Highest Channel / 1RB0

Highest Channel / 1RBmax

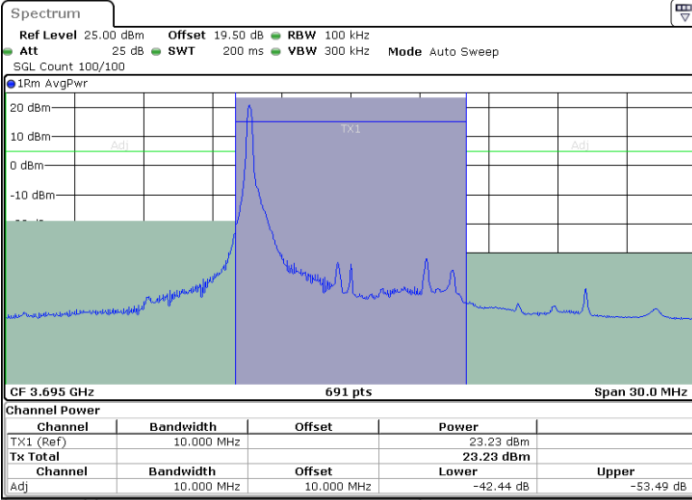

Date: 20.MAR.2024 06:05:03

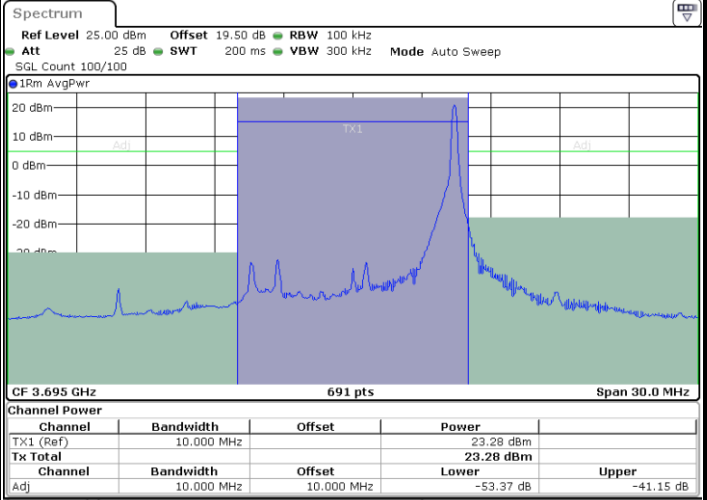

Date: 20.MAR.2024 06:02:41

Highest Channel / FullRB

N/A

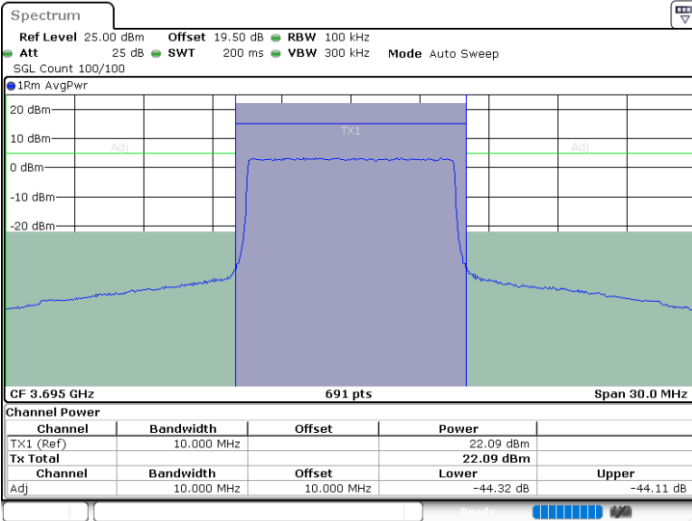

Date: 20.MAR.2024 06:00:19



LTE Band 48 / 15MHz

16QAM

Lowest Channel / 1RB0

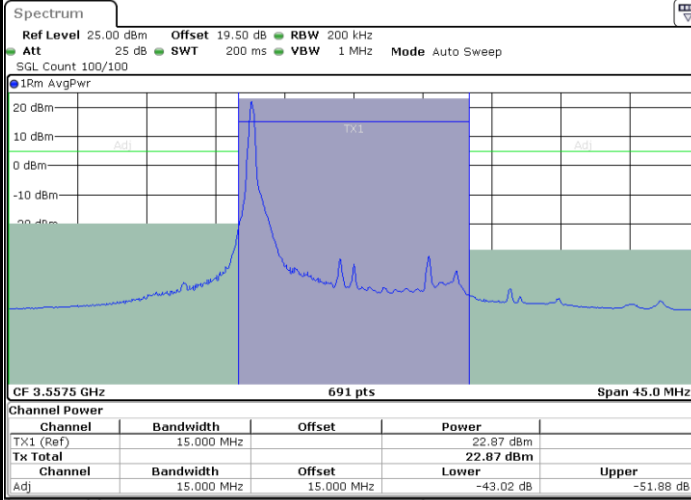

Date: 20.MAR.2024 06:27:40

Lowest Channel / 1RBmax

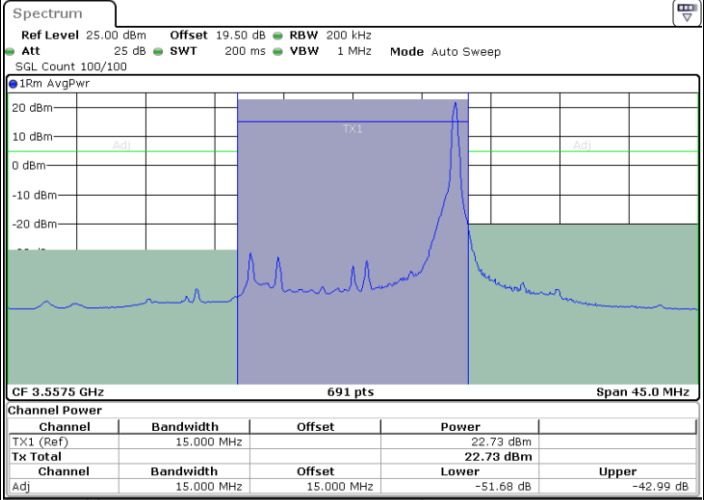

Date: 20.MAR.2024 06:25:19

Lowest Channel / FullIRB

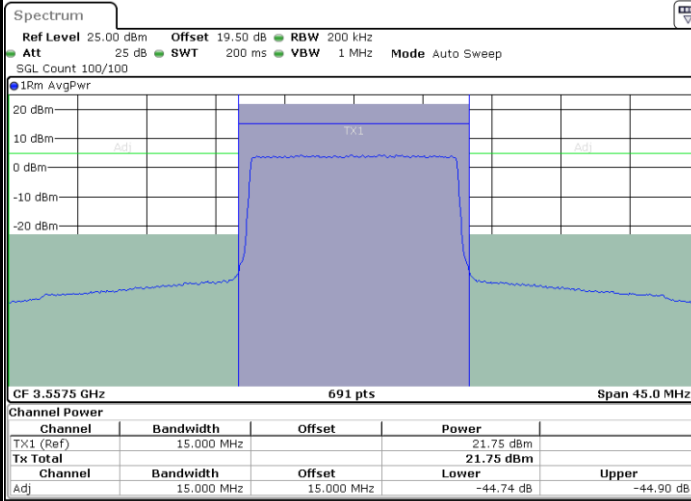

Date: 20.MAR.2024 06:22:57

N/A



LTE Band 48 / 15MHz

16QAM

Middle Channel / 1RB0

Middle Channel / 1RBmax

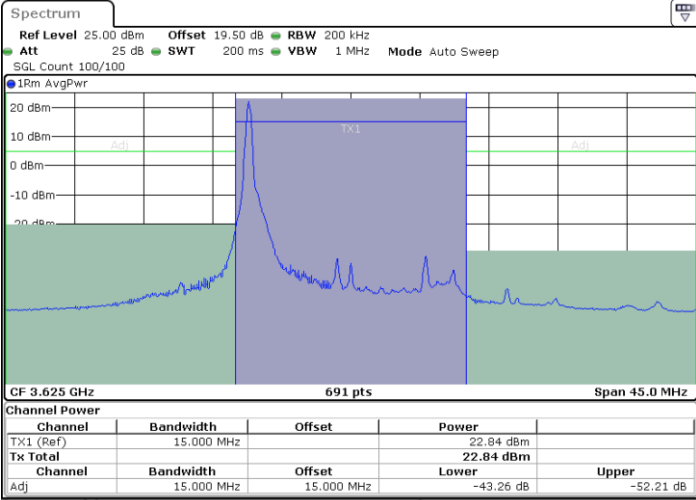

Date: 20.MAR.2024 06:44:45

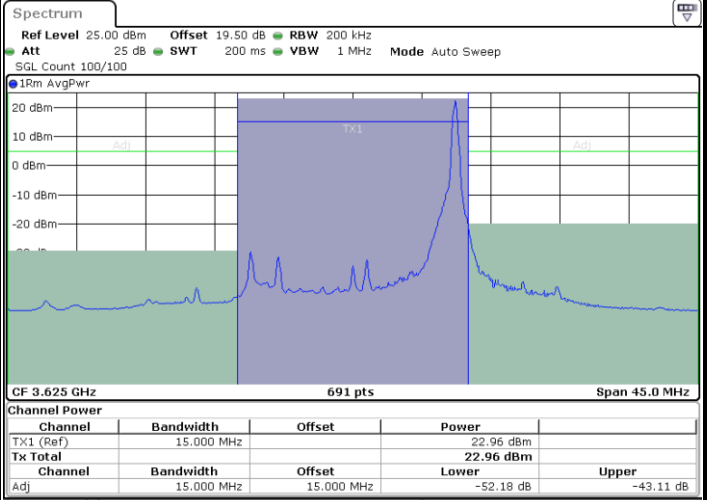

Date: 20.MAR.2024 06:47:04

Middle Channel / FullIRB

N/A

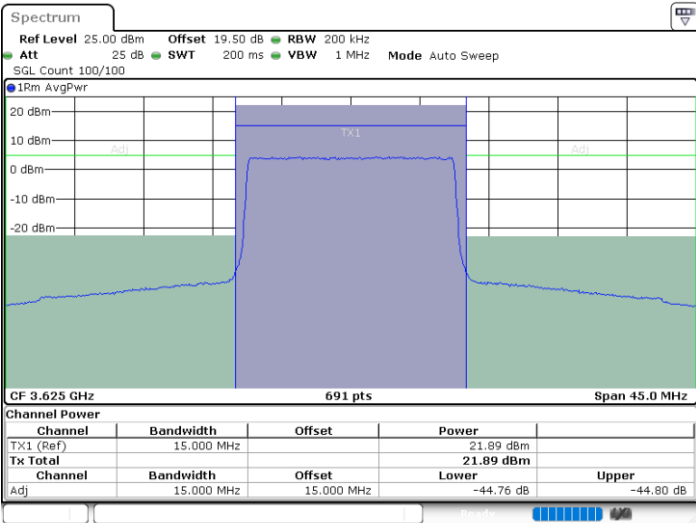

Date: 20.MAR.2024 06:49:23



LTE Band 48 / 15MHz

16QAM

Highest Channel / 1RB0

Highest Channel / 1RBmax

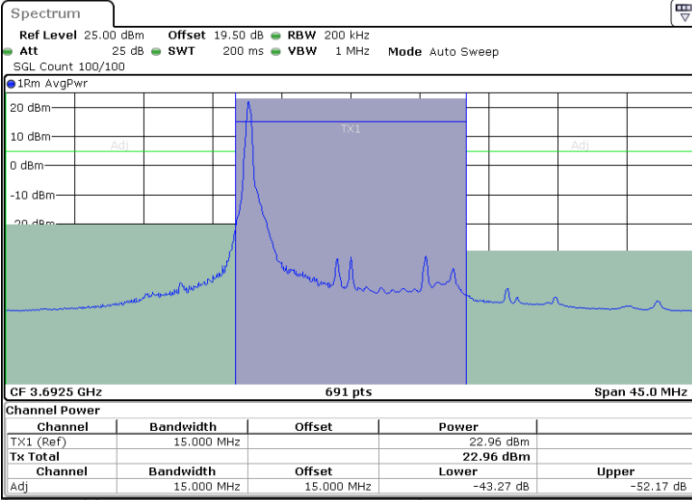

Date: 20.MAR.2024 07:15:14

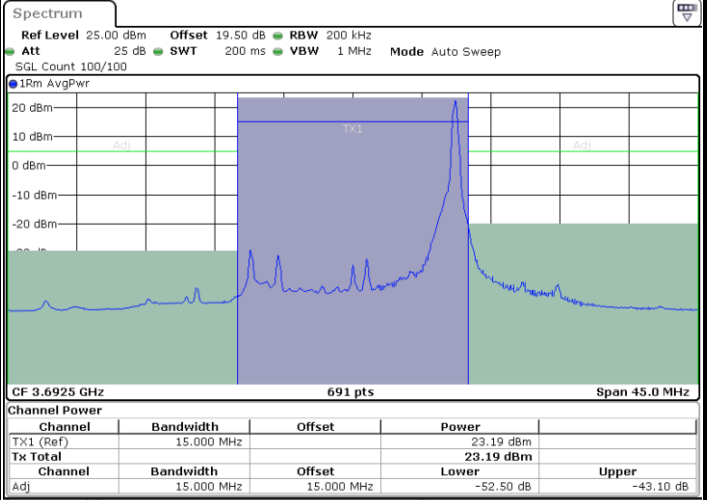

Date: 20.MAR.2024 07:12:51

Highest Channel / FullRB

N/A

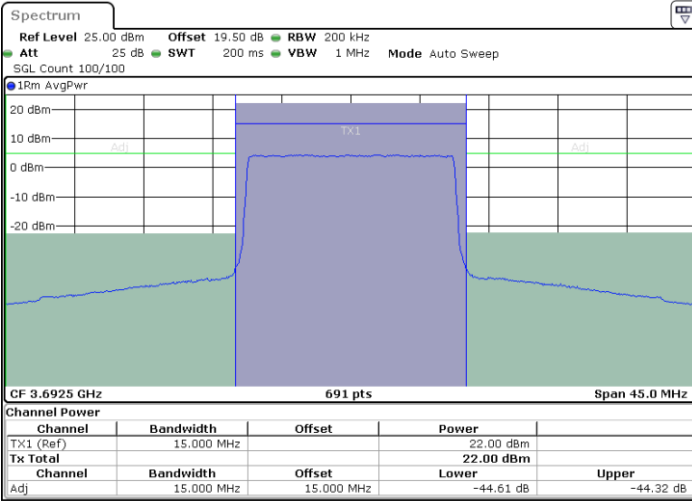

Date: 20.MAR.2024 07:10:28



LTE Band 48 / 20MHz

16QAM

Lowest Channel / 1RB0

Lowest Channel / 1RBmax

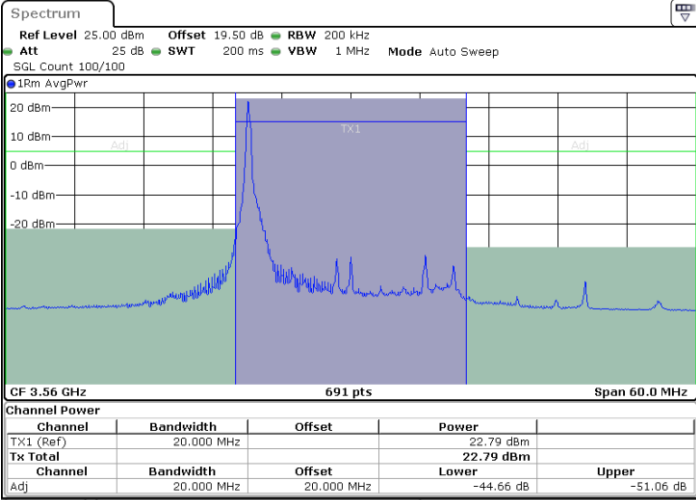

Date: 20.MAR.2024 07:37:44

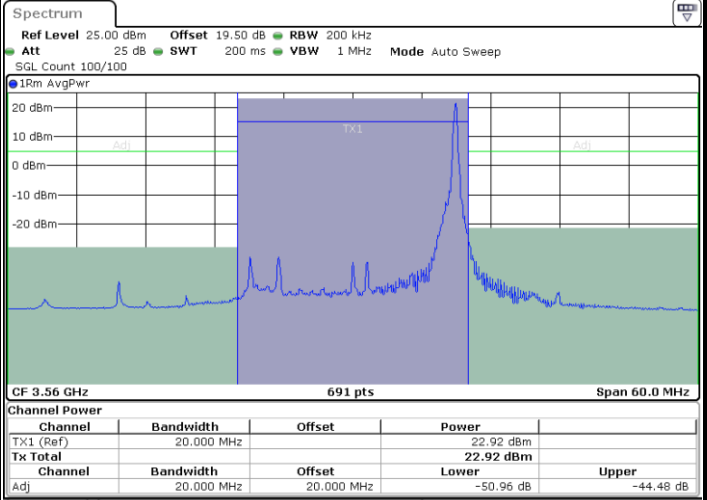

Date: 20.MAR.2024 07:35:26

Lowest Channel / FullIRB

N/A

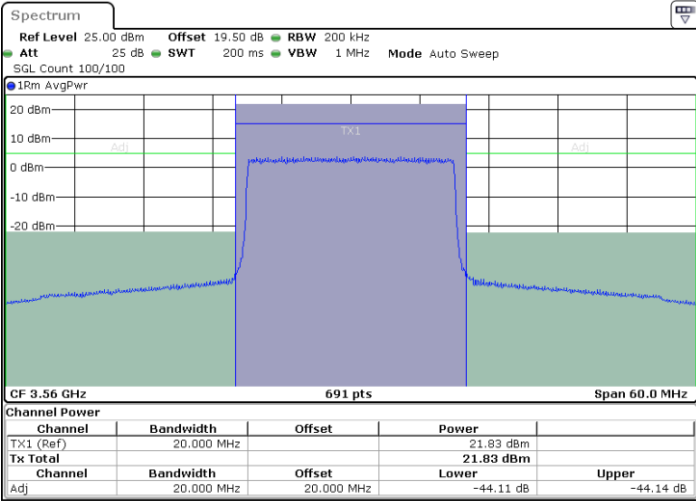

Date: 20.MAR.2024 07:33:07



LTE Band 48 / 20MHz

16QAM

Middle Channel / 1RB0

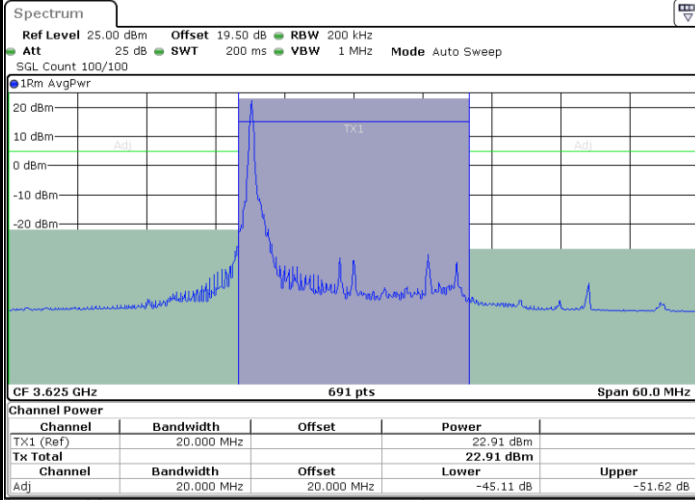

Date: 20.MAR.2024 07:54:51

Middle Channel / 1RBmax

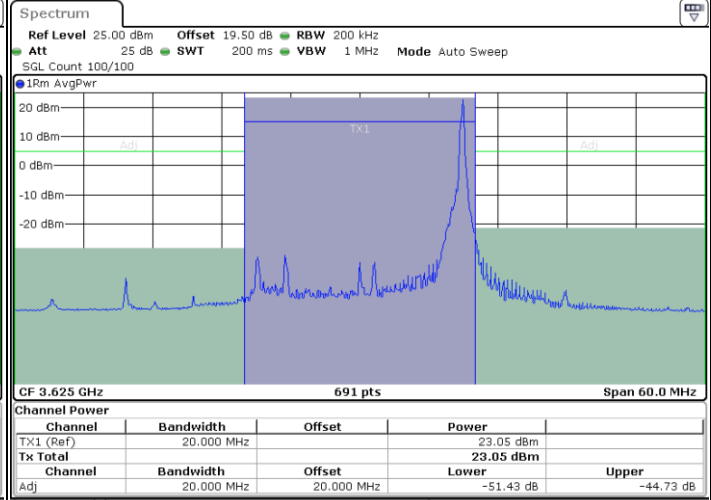

Date: 20.MAR.2024 07:57:08

Middle Channel / FullIRB

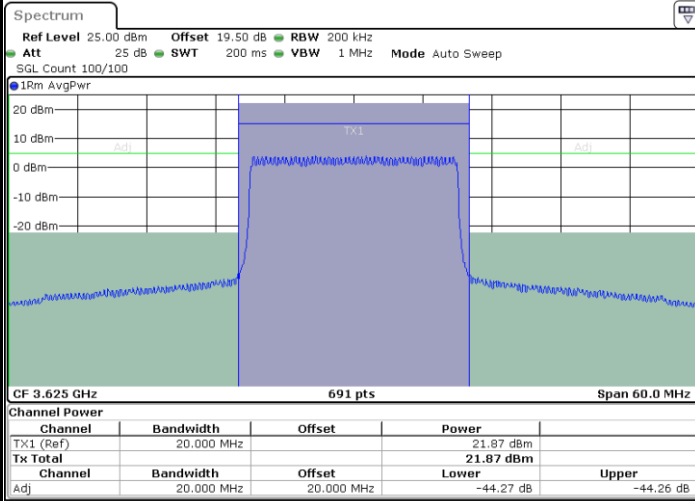

Date: 20.MAR.2024 07:59:24

N/A



LTE Band 48 / 20MHz

16QAM

Highest Channel / 1RB0

Highest Channel / 1RBmax

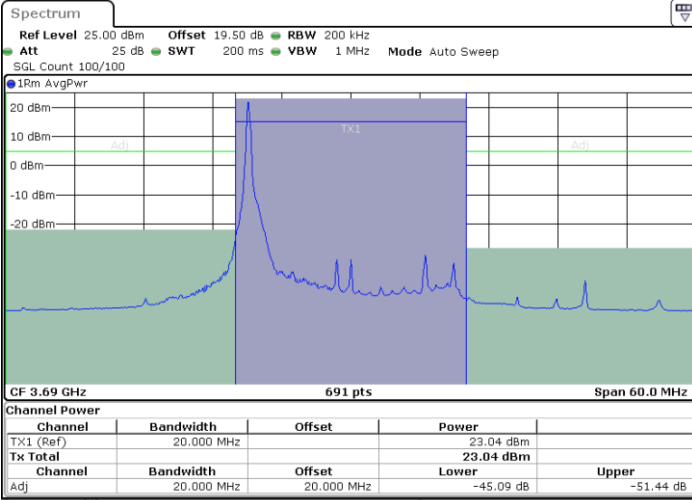

Date: 20.MAR.2024 08:26:26

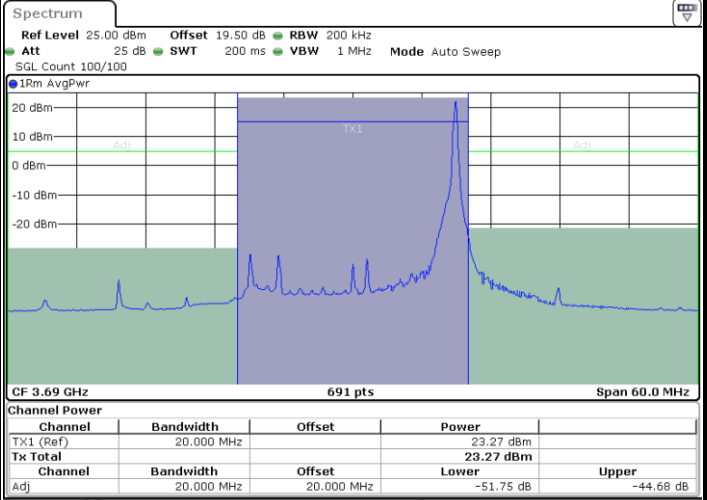

Date: 20.MAR.2024 08:24:07

Highest Channel / FullRB

N/A

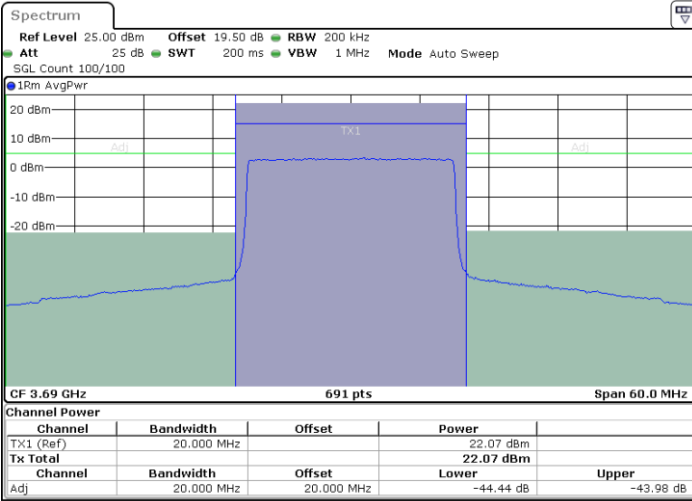

Date: 20.MAR.2024 08:21:50



LTE Band 48 / 5MHz

64QAM

Lowest Channel / 1RB0

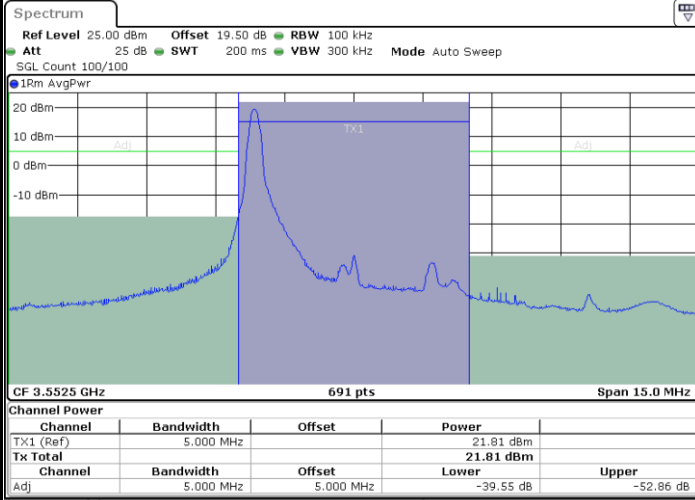

Date: 20.MAR.2024 04:09:30

Lowest Channel / 1RBmax

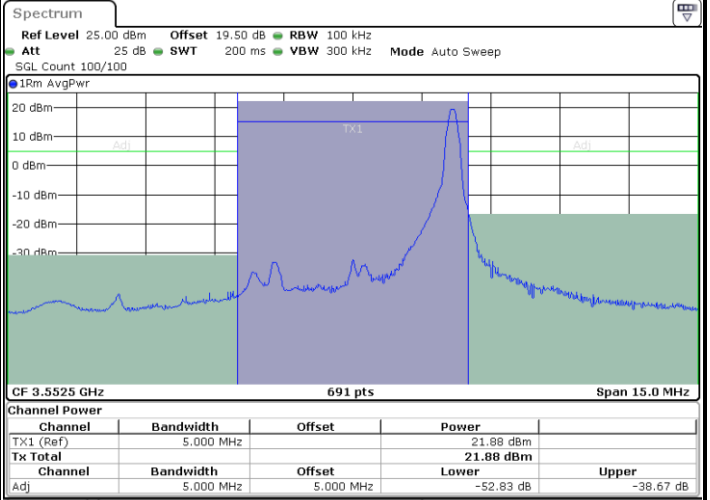

Date: 20.MAR.2024 04:13:21

Lowest Channel / FullIRB

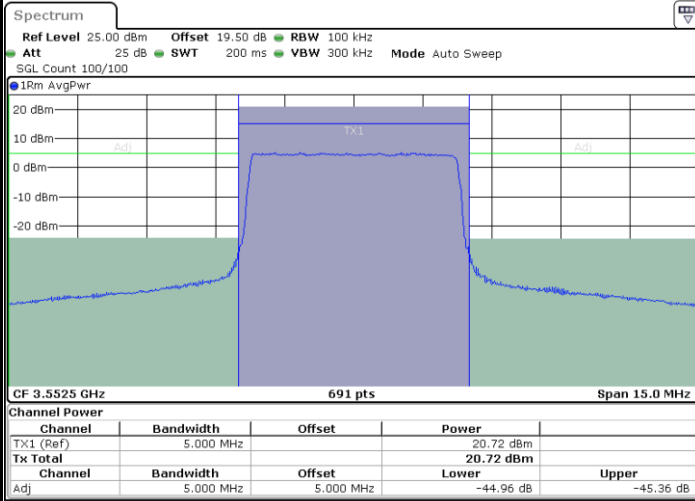

Date: 20.MAR.2024 04:08:44

N/A



LTE Band 48 / 5MHz

64QAM

Middle Channel / 1RB0

Middle Channel / 1RBmax

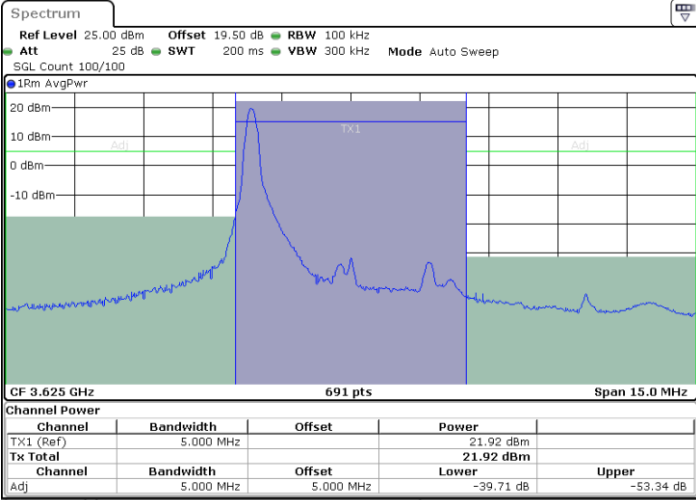

Date: 20.MAR.2024 04:32:51

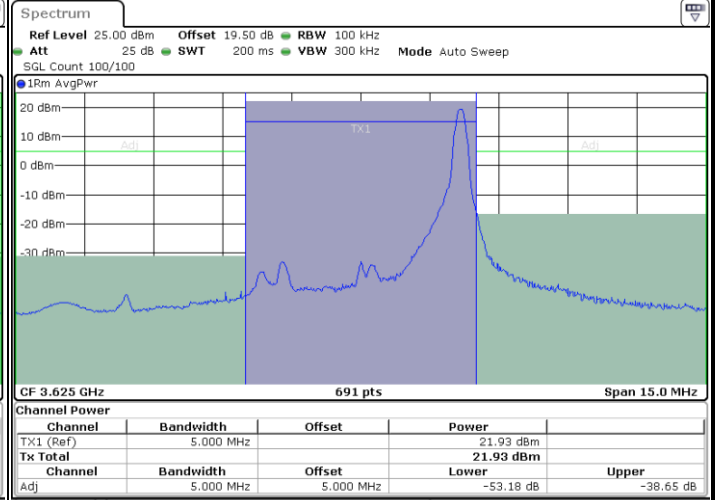

Date: 20.MAR.2024 04:29:04

Middle Channel / FullIRB

N/A

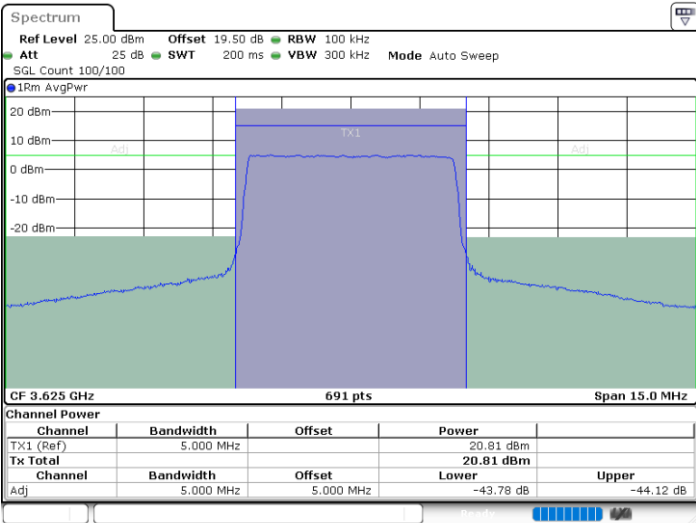

Date: 20.MAR.2024 04:33:37



LTE Band 48 / 5MHz

64QAM

Highest Channel / 1RB0

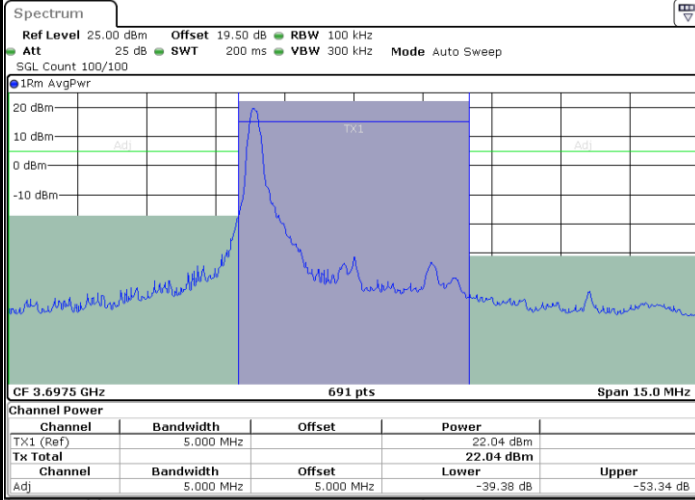

Date: 20.MAR.2024 04:58:17

Highest Channel / 1RBmax

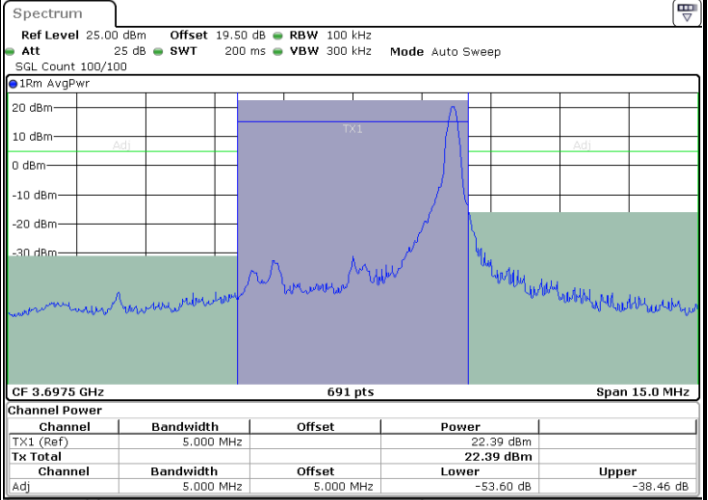

Date: 20.MAR.2024 04:54:20

Highest Channel / FullRB

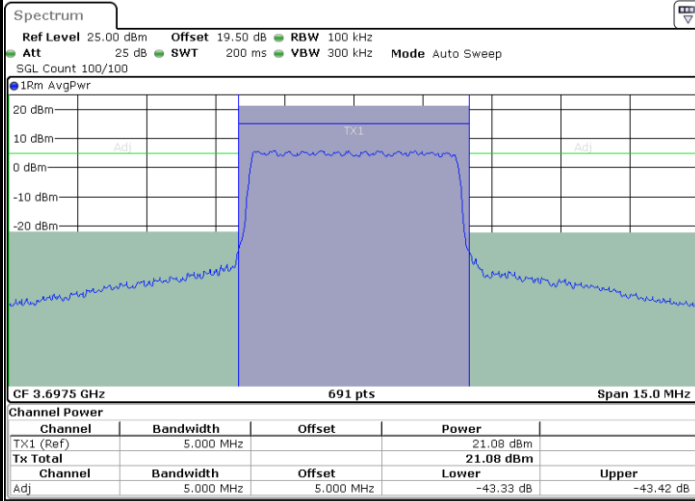

Date: 20.MAR.2024 04:53:33

N/A



LTE Band 48 / 10MHz

64QAM

Lowest Channel / 1RB0

Lowest Channel / 1RBmax

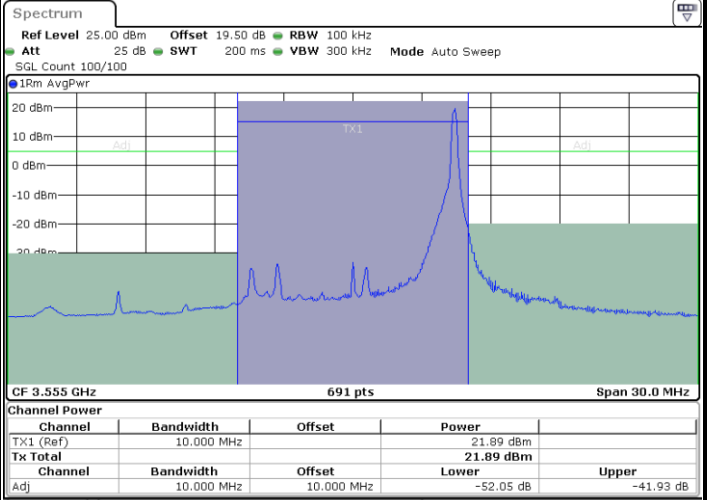
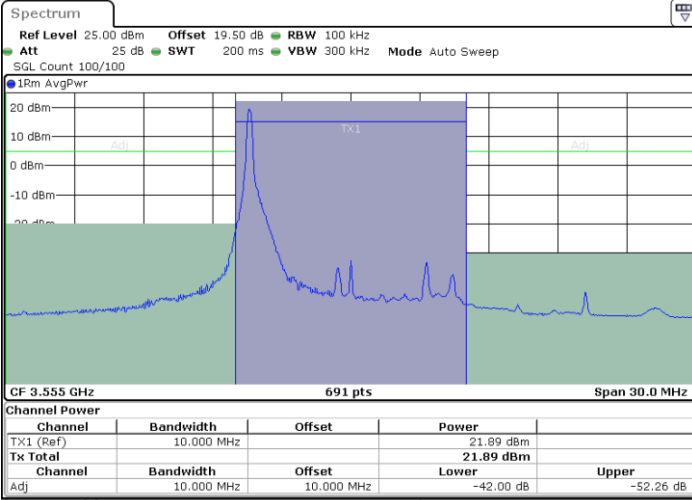

Date: 20.MAR.2024 05:21:00

Date: 20.MAR.2024 05:17:08

Lowest Channel / FullIRB

N/A

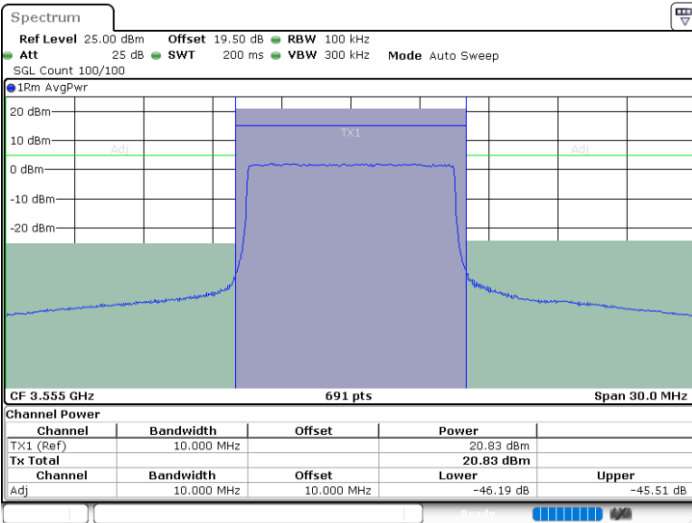

Date: 20.MAR.2024 05:16:22



LTE Band 48 / 10MHz

64QAM

Middle Channel / 1RB0

Middle Channel / 1RBmax

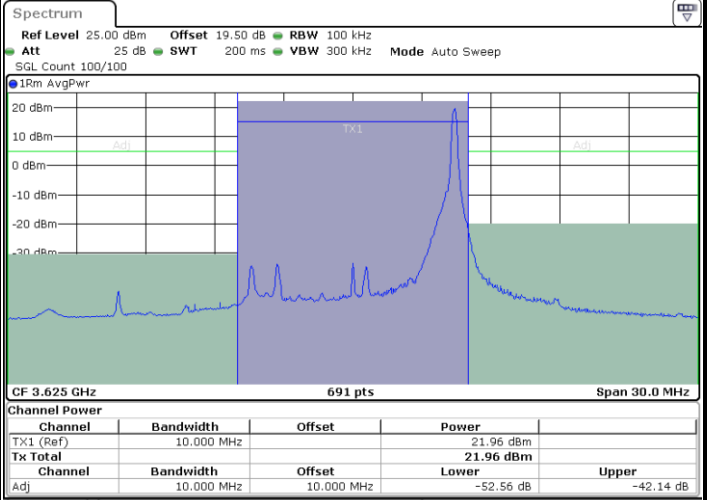
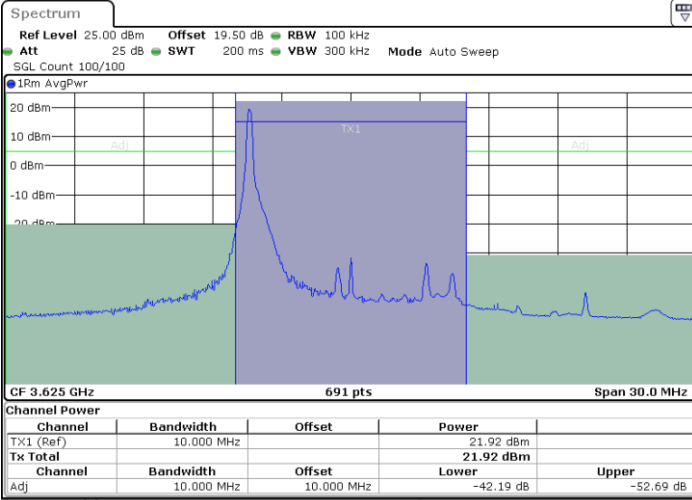

Date: 20.MAR.2024 05:36:30

Date: 20.MAR.2024 05:40:21

Middle Channel / FullIRB

N/A

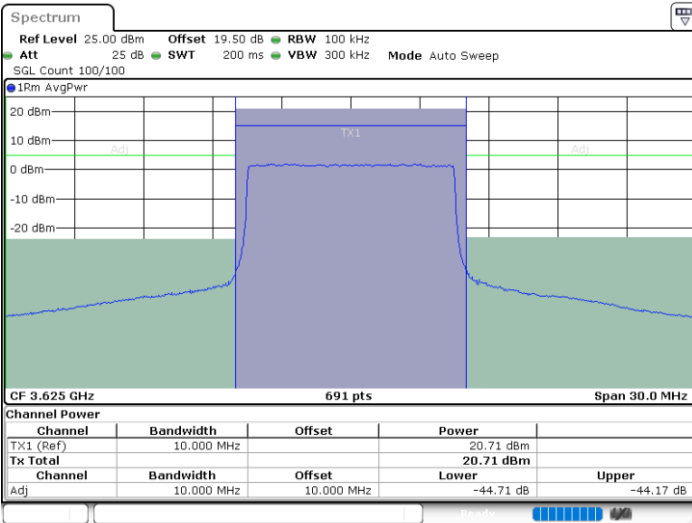

Date: 20.MAR.2024 05:41:07



LTE Band 48 / 10MHz

64QAM

Highest Channel / 1RB0

Highest Channel / 1RBmax

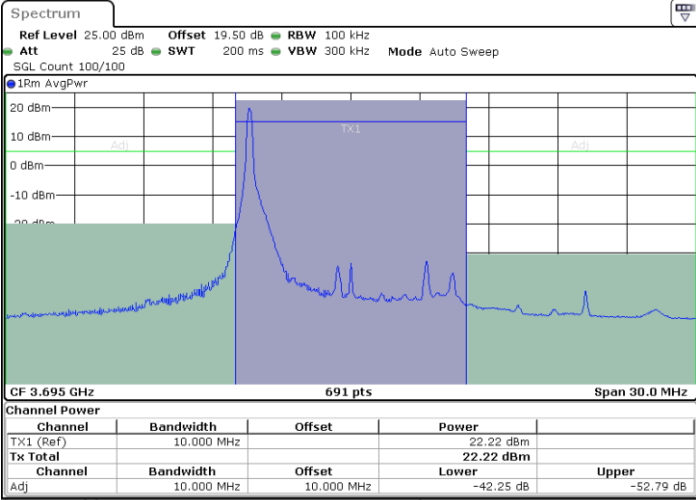

Date: 20.MAR.2024 06:05:50

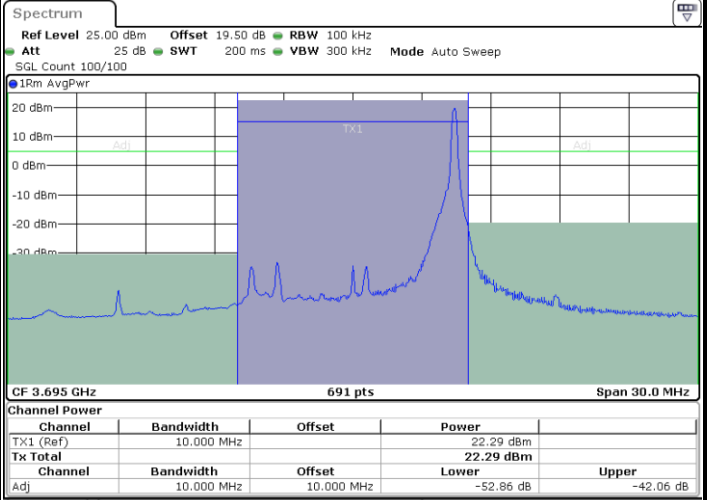

Date: 20.MAR.2024 06:01:54

Highest Channel / FullRB

N/A

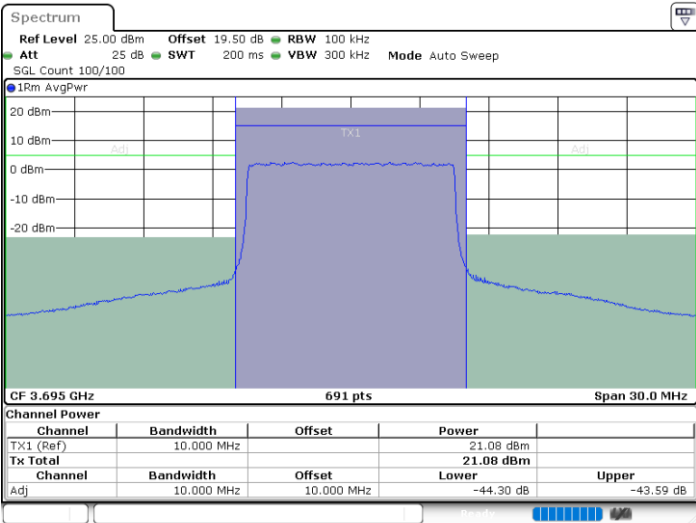

Date: 20.MAR.2024 06:01:06