



FCC RF Test Report

APPLICANT : TCL Communication Ltd.
EQUIPMENT : GSM/UMTS/LTE/NR Mobile phone
BRAND NAME : TCL
MODEL NAME : T803E
FCC ID : 2ACCJH183
STANDARD : 47 CFR Part 2, 27(M), 27(H), 27(F)
CLASSIFICATION : PCS Licensed Transmitter Held to Ear (PCE)
TEST DATE(S) : Mar. 19, 2024 ~ Mar. 28, 2024

We, Sporton International Inc. (Shenzhen), would like to declare that the tested sample has been evaluated in accordance with the procedures given in ANSI C63.26-2015 and shown compliance with the applicable technical standards.

The test results in this report apply exclusively to the tested model / sample. Without written approval of Sporton International Inc. (Shenzhen), the test report shall not be reproduced except in full.

Jason Jia



Approved by: Jason Jia

Sporton International Inc. (ShenZhen)

1/F, 2/F, Bldg 5, Shiling Industrial Zone, Xinwei Village, Xili, Nanshan, Shenzhen, 518055

People's Republic of China



TABLE OF CONTENTS

REVISION HISTORY...3
SUMMARY OF TEST RESULT...4
1 GENERAL DESCRIPTION...5
1.1 Applicant...5
1.2 Manufacturer...5
1.3 Product Feature of Equipment Under Test...5
1.4 Product Specification of Equipment Under Test...6
1.5 Modification of EUT...6
1.6 Maximum ERP/EIRP Power and Emission Designator...7
1.7 Testing Location...9
1.8 Test Software...9
1.9 Applicable Standards...10
2 TEST CONFIGURATION OF EQUIPMENT UNDER TEST...11
2.1 Test Mode...11
2.2 Connection Diagram of Test System...13
2.3 Support Unit used in test configuration and system...13
2.4 Measurement Results Explanation Example...13
2.5 Frequency List of Low/Middle/High Channels...14
3 CONDUCTED TEST ITEMS...17
3.1 Measuring Instruments...17
3.2 Test Setup...17
3.3 Test Result of Conducted Test...17
3.4 Conducted Output Power and ERP/EIRP...18
3.5 Peak-to-Average Ratio...19
3.6 Occupied Bandwidth...20
3.7 Conducted Band Edge...21
3.8 Conducted Spurious Emission...23
3.9 Frequency Stability...24
4 RADIATED TEST ITEMS...25
4.1 Measuring Instruments...25
4.2 Test Setup...25
4.3 Test Result of Radiated Test...26
4.4 Radiated Spurious Emission...27
5 LIST OF MEASURING EQUIPMENT...28
6 MEASUREMENT UNCERTAINTY...29
APPENDIX A. TEST RESULTS OF CONDUCTED TEST
APPENDIX B. TEST RESULTS OF RADIATED TEST
APPENDIX C. TEST SETUP PHOTOGRAPHS



SUMMARY OF TEST RESULT

Report Section	FCC Rule	Description	Limit	Result	Remark
3.4	§2.1046	Conducted Output Power	-	Report Only	-
	§27.50(b)(10) §27.50(c)(10)	Effective Radiated Power (Band 12) (Band 13) (Band 17)	ERP < 3 Watt	PASS	-
	§27.50(h)(2)	Equivalent Isotropic Radiated Power (Band 7) (Band 38) (Band 41)	EIRP < 2Watt		-
3.5	N/A	Peak-to-Average Ratio	<13 dB	PASS	-
3.6	§2.1049	Occupied Bandwidth	-	Report Only	-
3.7	§2.1051 §27.53(c)(2)(4) §27.53(g)	Conducted Band Edge Measurement (Band 12) (Band 13) (Band 17)	< 43+10log ₁₀ (P[Watts])	PASS	-
	§27.53(m)(4)	Conducted Band Edge Measurement (Band 7) (Band 38) (Band 41)	§27.53(m)(4)		
3.8	§2.1051 §27.53(c)(2) §27.53(g)	Conducted Spurious Emission (Band 12) (Band 13) (Band 17)	< 43+10log ₁₀ (P[Watts])	PASS	-
	§2.1051 §27.53(m)(4)	Conducted Spurious Emission (Band 7) (Band 38) (Band 41)	< 55+10log ₁₀ (P[Watts])		
3.9	§2.1055 §27.54	Frequency Stability Temperature & Voltage	Within Authorized Band	PASS	-
4.4	§2.1053 §27.53(c)(2) §27.53(f) §27.53(g)	Radiated Spurious Emission (Band 12) (Band 13) (Band 17)	< 43+10log ₁₀ (P[Watts])	PASS	Under limit 16.04 dB at 10336.00 MHz
	§2.1053 §27.53(m)(4)	Radiated Spurious Emission (Band 7) (Band 38) (Band 41)	< 55+10log ₁₀ (P[Watts])		

Conformity Assessment Condition:

- The test results (PASS/FAIL) with all measurement uncertainty excluded are presented against the regulation limits or in accordance with the requirements stipulated by the applicant/manufacturer who shall bear all the risks of non-compliance that may potentially occur if measurement uncertainty is taken into account.
- The measurement uncertainty please refer to each test result in the section "Measurement Uncertainty"

Disclaimer:

The product specifications of the EUT presented in the test report that may affect the test assessments are declared by the manufacturer who shall take full responsibility for the authenticity.



1 General Description

1.1 Applicant

TCL Communication Ltd.

5/F, Building 22E, 22 Science Park East Avenue, Hong Kong Science Park, Shatin, NT, Hong Kong

1.2 Manufacturer

TCL Communication Ltd.

5/F, Building 22E, 22 Science Park East Avenue, Hong Kong Science Park, Shatin, NT, Hong Kong

1.3 Product Feature of Equipment Under Test

Product Feature	
Equipment	GSM/UMTS/LTE/NR Mobile phone
Brand Name	TCL
Model Name	T803E
FCC ID	2ACCJH183
IMEI Code/SN	Conducted: YTDMEIJZFYYTTOWK Radiation: 353318350121876/353318350121884
HW Version	05
SW Version	AGS7
EUT Stage	Identical Prototype



1.4 Product Specification of Equipment Under Test

Standards-related Product Specification	
Tx Frequency	LTE Band 7 : 2500 MHz ~ 2570 MHz LTE Band 12 : 699 MHz ~ 716 MHz LTE Band 13 : 777 MHz ~ 787 MHz LTE Band 17 : 704 MHz ~ 716 MHz LTE Band 38 : 2570 MHz ~ 2620 MHz LTE Band 41 : 2496 MHz ~ 2690 MHz
Rx Frequency	LTE Band 7 : 2620 MHz ~ 2690 MHz LTE Band 12 : 729 MHz ~ 746 MHz LTE Band 13 : 746 MHz ~ 756 MHz LTE Band 17 : 734 MHz ~ 746 MHz LTE Band 38 : 2570 MHz ~ 2620 MHz LTE Band 41 : 2496 MHz ~ 2690 MHz
Bandwidth	LTE Band 7 : 5MHz/ 10MHz / 15MHz / 20MHz LTE Band 12 : 1.4MHz / 3MHz / 5MHz / 10MHz LTE Band 13 : 5MHz / 10MHz LTE Band 17 : 5MHz / 10MHz LTE Band 38 : 5MHz / 10MHz / 15MHz / 20MHz LTE Band 41 : 5MHz / 10MHz / 15MHz / 20MHz
Maximum Output Power to Antenna	Ant0: LTE Band 12 : 24.18 dBm LTE Band 13 : 24.09 dBm LTE Band 17 : 23.80 dBm Ant4: LTE Band 7 : 22.89 dBm LTE CA_7C : 22.82 dBm LTE Band 38 : 23.22 dBm LTE Band 41 : 23.31 dBm Ant1: LTE Band 7 : 8.12 dBm LTE Band 38 : 23.02 dBm
Antenna Gain	Ant0: LTE Band 12 : -3.2 dBi LTE Band 13 : -4 dBi LTE Band 17 : -3.2 dBi Ant4: LTE Band 7 : -0.1 dBi LTE Band 38 : -0.8 dBi LTE Band 41 : -0.8 dBi Ant1: LTE Band 7 : -1.4 dBi LTE Band 38 : -1.1 dBi
Type of Modulation	QPSK / 16QAM / 64QAM / 256QAM

Note: The EIRP is calculated from Output power and antenna gain, so the maximum EIRP of LTE Band 7/38 for Antenna 4 is shown in the report.

1.5 Modification of EUT

No modifications are made to the EUT during all test items.



1.6 Maximum ERP/EIRP Power and Emission Designator

LTE Band 7		QPSK		16QAM/64QAM/256QAM	
BW (MHz)	Frequency Range (MHz)	Maximum EIRP(W)	Emission Designator (99%OBW)	Maximum EIRP(W)	Emission Designator (99%OBW)
5	2502.5 ~ 2567.5	0.1644	4M50G7D	0.1409	4M48W7D
10	2505.0 ~ 2565.0	0.1611	9M05G7D	0.1416	9M01W7D
15	2507.5 ~ 2562.5	0.1633	13M4G7D	0.1426	13M5W7D
20	2510.0 ~ 2560.0	0.1901	17M9G7D	0.1445	17M8W7D
LTE Band 12		QPSK		16QAM/64QAM/256QAM	
BW (MHz)	Frequency Range (MHz)	Maximum ERP(W)	Emission Designator (99%OBW)	Maximum ERP(W)	Emission Designator (99%OBW)
1.4	699.7 ~ 715.3	0.0741	1M09G7D	0.0627	1M09W7D
3	700.5 ~ 714.5	0.0738	2M72G7D	0.0628	2M72W7D
5	701.5 ~ 713.5	0.0738	4M49G7D	0.0625	4M52W7D
10	704.0 ~ 711.0	0.0764	9M07G7D	0.0637	9M01W7D
LTE Band 13		QPSK		16QAM/64QAM/256QAM	
BW (MHz)	Frequency Range (MHz)	Maximum ERP(W)	Emission Designator (99%OBW)	Maximum ERP(W)	Emission Designator (99%OBW)
5	779.5 ~ 784.5	0.0604	4M47G7D	0.0522	4M50W7D
10	782.0	0.0622	9M09G7D	0.0533	9M01W7D
LTE Band 17		QPSK		16QAM/64QAM/256QAM	
BW (MHz)	Frequency Range (MHz)	Maximum ERP(W)	Emission Designator (99%OBW)	Maximum ERP(W)	Emission Designator (99%OBW)
5	706.5 ~ 713.5	0.0676	4M49G7D	0.0586	4M52W7D
10	709.0 ~ 711.0	0.0700	9M07G7D	0.0582	9M01W7D
LTE Band 38		QPSK		16QAM/64QAM/256QAM	
BW (MHz)	Frequency Range (MHz)	Maximum EIRP(W)	Emission Designator (99%OBW)	Maximum EIRP(W)	Emission Designator (99%OBW)
5	2572.5 ~ 2617.5	0.1698	4M48G7D	0.1330	4M44W7D
10	2575.0 ~ 2615.0	0.1702	9M01G7D	0.1346	9M13W7D
15	2577.5 ~ 2612.5	0.1714	13M5G7D	0.1330	13M4W7D
20	2580.0 ~ 2610.0	0.1746	17M8G7D	0.1365	17M9W7D



LTE Band 41		QPSK		16QAM/64QAM/256QAM	
BW (MHz)	Frequency Range (MHz)	Maximum EIRP(W)	Emission Designator (99%OBW)	Maximum EIRP(W)	Emission Designator (99%OBW)
5	2498.5 ~ 2687.5	0.1718	4M48G7D	0.1340	4M44W7D
10	2501.0 ~ 2685.0	0.1706	9M01G7D	0.1346	9M13W7D
15	2503.5 ~ 2682.5	0.1714	13M5G7D	0.1371	13M4W7D
20	2506.0 ~ 2680.0	0.1782	17M8G7D	0.1406	17M9W7D

LTE Band 7 CA		QPSK		16QAM/64QAM/256QAM	
BW (MHz)		Maximum EIRP(W)	Emission Designator (99%OBW)	Maximum EIRP(W)	Emission Designator (99%OBW)
10MHz+20MHz		0.1799	28M2G7D	0.1445	28M1W7D
15MHz+15MHz		0.1786	28M7G7D	0.1409	28M7W7D
15MHz+20MHz		0.1803	32M9G7D	0.1429	32M7W7D
15MHz+10MHz		0.1828	23M5G7D	0.1429	23M5W7D
20MHz+10MHz		0.1791	28M1G7D	0.1409	28M0W7D
20MHz+15MHz		0.1854	32M8G7D	0.1435	32M8W7D
20MHz+20MHz		0.1871	37M7G7D	0.1479	37M7W7D

Note:

1. LTE Band 12 overlaps the entire frequency range of LTE Band 17. Therefore, the test results provided in this report covers Band 12 as well as Band 17.
2. LTE Band 41 overlaps the entire frequency range of LTE Band 38. Therefore, the test results provided in this report covers Band 41 as well as Band 38.
3. All modulations have been tested, and only the worst test results of PSK & QAM are shown in the report.



1.7 Testing Location

Sporton International Inc. (ShenZhen) is accredited to ISO/IEC 17025:2017 by American Association for Laboratory Accreditation with Certificate Number 5145.01.

Test Firm	Sporton International Inc. (ShenZhen)		
Test Site Location	1/F, 2/F, Bldg 5, Shiling Industrial Zone, Xinwei Village, Xili, Nanshan, Shenzhen, 518055 People's Republic of China TEL: +86-755-86379589 FAX: +86-755-86379595		
Test Site No.	Sporton Site No.	FCC Designation No.	FCC Test Firm Registration No.
	TH01-SZ	CN1256	421272

Test Firm	Sporton International Inc. (ShenZhen)		
Test Site Location	101, 1st Floor, Block B, Building 1, No. 2, Tengfeng 4th Road, Fenghuang Community, Fuyong Street, Baoan District, Shenzhen City, Guangdong Province 518103 People's Republic of China TEL: +86-755-86066985		
Test Site No.	Sporton Site No.	FCC Designation No.	FCC Test Firm Registration No.
	03CH01-SZ	CN1256	421272

1.8 Test Software

Item	Site	Manufacture	Name	Version
1.	03CH01-SZ	AUDIX	E3	6.2009-8-24



1.9 Applicable Standards

According to the specifications of the manufacturer, the EUT must comply with the requirements of the following standards:

- ♦ 47 CFR Part 2, 27(M), 27(H), 27(F)
- ♦ ANSI C63.26-2015
- ♦ FCC KDB 971168 D01 Power Meas License Digital Systems v03r01
- ♦ FCC KDB 412172 D01 Determining ERP and EIRP v01r01

Remark:

1. All test items were verified and recorded according to the standards and without any deviation during the test.
2. This EUT has also been tested and complied with the requirements of FCC Part 15, Subpart B, recorded in a separate test report.



2 Test Configuration of Equipment Under Test

2.1 Test Mode

Antenna port conducted and radiated test items listed below are performed according to KDB 971168 D01 Power Meas License Digital Systems v03r01 with maximum output power.

Radiated measurements are performed by rotating the EUT in three different orthogonal test planes to find the maximum emission. (Y/Z-Plane)

Test Items	Band	Bandwidth (MHz)						Modulation				RB #			Test Channel		
		1.4	3	5	10	15	20	QPSK	16 QAM	64 QAM	256 QAM	1	Half	Full	L	M	H
Max. Output Power	7	-	-	v	v	v	v	v	v	v	v	v	v	v	v	v	v
	12	v	v	v	v	-	-	v	v	v	v	v	v	v	v	v	v
	13	-	-	v	v	-	-	v	v	v	v	v	v	v	v	v	v
	17	-	-	v	v	-	-	v	v	v	v	v	v	v	v	v	v
	38	-	-	v	v	v	v	v	v	v	v	v	v	v	v	v	v
	41	-	-	v	v	v	v	v	v	v	v	v	v	v	v	v	v
Peak-to-Average Ratio	7	-	-				v	v	v				v		v		
	12				v	-	-	v	v	v			v		v		
	13	-	-		v	-	-	v	v	v			v		v		
	41	-	-				v	v	v	v			v		v		
26dB and 99% Bandwidth	7	-	-	v	v	v	v	v	v				v		v		
	12	v	v	v	v	-	-	v	v				v		v		
	13	-	-	v	v	-	-	v	v				v		v		
	41	-	-	v	v	v	v	v	v				v		v		
Conducted Band Edge	7	-	-	v	v	v	v	v	v	v		v		v	v	v	
	12	v	v	v	v	-	-	v	v	v		v		v	v	v	
	13	-	-	v	v	-	-	v	v	v		v		v	v	v	
	41	-	-	v	v	v	v	v	v	v		v		v	v	v	
Conducted Spurious Emission	7	-	-	v	v	v	v	v				v			v	v	
	12	v	v	v	v	-	-	v				v			v	v	
	13	-	-	v	v	-	-	v				v			v	v	
	41	-	-	v	v	v	v	v				v			v	v	
Frequency Stability	7	-	-		v			v						v		v	
	12				v	-	-	v						v		v	
	13	-	-		v	-	-	v						v		v	
	41	-	-		v			v						v		v	



Test Items	Band	Bandwidth (MHz)						Modulation				RB #			Test Channel			
		1.4	3	5	10	15	20	QPSK	16 QAM	64 QAM	256 QAM	1	Half	Full	L	M	H	
E.R.P / E.I.R.P	7	-	-	v	v	v	v	v	v	v	v	v			v	v	v	
	12	v	v	v	v	-	-	v	v	v	v	v			v	v	v	
	13	-	-	v	v	-	-	v	v	v	v	v			v	v	v	
	17	-	-	v	v	-	-	v	v	v	v	v			v	v	v	
	38	-	-	v	v	v	v	v	v	v	v	v			v	v	v	
	41	-	-	v	v	v	v	v	v	v	v	v			v	v	v	
Radiated Spurious Emission	7	Worst Case															v	
	12	Worst Case															v	
	13	Worst Case															v	
	41	Worst Case															v	
Note	<ol style="list-style-type: none"> The mark "v" means that this configuration is chosen for testing The mark "-" means that this bandwidth is not supported. The device is investigated from 30MHz to 10 times of fundamental signal for radiated spurious emission test under different RB size/offset and modulations in exploratory test. Subsequently, only the worst case emissions are reported. LTE Band 12 overlaps the entire frequency range of LTE Band 17. Therefore, the test results provided in this report covers Band 12 as well as Band 17. LTE Band 41 overlaps the entire frequency range of LTE Band 38. Therefore, the test results provided in this report covers Band 41 as well as Band 38. For QAM modulation mode, the whole testing has assessed 16QAM&64QAM mode by referring to the higher conducted power 																	

Test Items	Band	Bandwidth (MHz)										Modulation			RB #			Test Channel			
		20+20	20+15	15+20	20+10	10+20	20+5	5+20	15+15	15+10	10+15	QPSK	16 QAM	64 QAM	256 QAM	1	Half	Full	L	M	H
Max. Output Power	7C_CA	v	v	v	v	v	-	-	v	v	-	v	v	v	v	v	v	v	v	v	v
26dB and 99% Bandwidth	7C_CA	v	v	v	v	v	-	-	v	v	-	v	v					v		v	
Conducted Band Edge	7C_CA	v	v	v	v	v	-	-	v	v	-	v	v	v		v		v	v		v
Conducted Spurious Emission	7C_CA	v	v	v	v	v	-	-	v	v	-	v				v			v	v	v
E.I.R.P.	7C_CA	v	v	v	v	v	-	-	v	v	-	v	v	v	v	v			v	v	v
Radiated Spurious Emission	7C_CA	Worst Case																		v	
Note	<ol style="list-style-type: none"> The mark "v" means that this configuration is chosen for testing The mark "-" means that this bandwidth is not supported. The device is investigated from 30MHz to 10 times of fundamental signal for radiated spurious emission test under different RB size/offset and modulations in exploratory test. Subsequently, only the worst case emissions are reported. 																				

4. For QAM modulation mode, the whole testing has assessed 16QAM&64QAM mode by referring to the higher conducted power

2.2 Connection Diagram of Test System

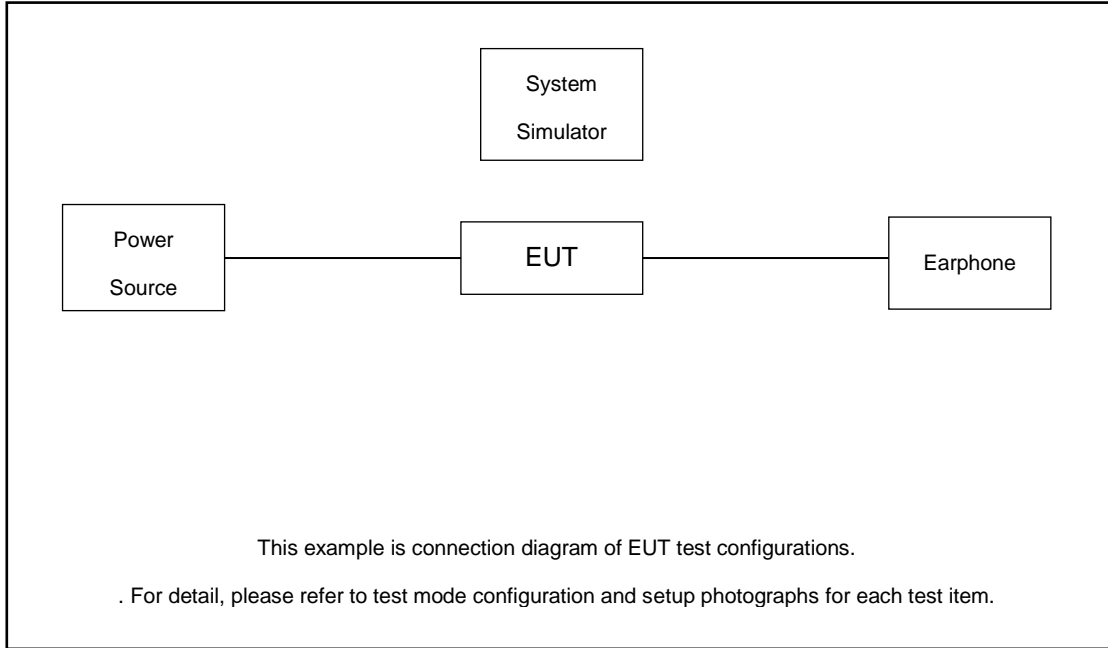

2.3 Support Unit used in test configuration and system

Item	Equipment	Trade Name	Model No.	FCC ID	Data Cable	Power Cord
1.	Power Supply	GWINSTEK	PSS-2002	N/A	N/A	Unshielded, 1.8 m
2.	LTE Base Station	Anritsu	MT8820C	N/A	N/A	Unshielded, 1.8 m
3.	Earphone	apple	N/A	N/A	N/A	N/A

2.4 Measurement Results Explanation Example

For all conducted test items:

The offset level is set in the spectrum analyzer to compensate the RF cable loss and attenuator factor between EUT conducted output port and spectrum analyzer. With the offset compensation, the spectrum analyzer reading level is exactly the EUT RF output level.

The spectrum analyzer offset is derived from RF cable loss and attenuator factor.

$$Offset = RF\ cable\ loss + attenuator\ factor.$$

Following shows an offset computation example with cable loss 5.0 dB and 10dB attenuator.

Example :

$$Offset(dB) = RF\ cable\ loss(dB) + attenuator\ factor(dB). \\ = 5.0 + 10 = 15.0\ (dB)$$



2.5 Frequency List of Low/Middle/High Channels

LTE Band 7 Channel and Frequency List				
BW [MHz]	Channel/Frequency(MHz)	Lowest	Middle	Highest
20	Channel	20850	21100	21350
	Frequency	2510	2535	2560
15	Channel	20825	21100	21375
	Frequency	2507.5	2535	2562.5
10	Channel	20800	21100	21400
	Frequency	2505	2535	2565
5	Channel	20775	21100	21425
	Frequency	2502.5	2535	2567.5

LTE Band 12 Channel and Frequency List				
BW [MHz]	Channel/Frequency(MHz)	Lowest	Middle	Highest
10	Channel	23060	23095	23130
	Frequency	704	707.5	711
5	Channel	23035	23095	23155
	Frequency	701.5	707.5	713.5
3	Channel	23025	23095	23165
	Frequency	700.5	707.5	714.5
1.4	Channel	23017	23095	23173
	Frequency	699.7	707.5	715.3

LTE Band 13 Channel and Frequency List				
BW [MHz]	Channel/Frequency(MHz)	Lowest	Middle	Highest
10	Channel	-	23230	-
	Frequency	-	782	-
5	Channel	23205	23230	23255
	Frequency	779.5	782	784.5



LTE Band 17 Channel and Frequency List				
BW [MHz]	Channel/Frequency(MHz)	Lowest	Middle	Highest
10	Channel	23780	23790	23800
	Frequency	709	710	711
5	Channel	23755	23790	23825
	Frequency	706.5	710	713.5

LTE Band 38 Channel and Frequency List				
BW [MHz]	Channel/Frequency(MHz)	Lowest	Middle	Highest
20	Channel	37850	38000	38150
	Frequency	2580	2595	2610
15	Channel	37825	38000	38175
	Frequency	2577.5	2595	2612.5
10	Channel	37800	38000	38200
	Frequency	2575	2595	2615
5	Channel	37775	38000	38225
	Frequency	2572.5	2595	2617.5

LTE Band 41 Channel and Frequency List				
BW [MHz]	Channel/Frequency(MHz)	Lowest	Middle	Highest
20	Channel	39750	40620	41490
	Frequency	2506	2593	2680
15	Channel	39725	40620	41515
	Frequency	2503.5	2593	2682.5
10	Channel	39700	40620	41540
	Frequency	2501	2593	2685
5	Channel	39675	40620	41565
	Frequency	2498.5	2593	2687.5



LTE Band 7C_CA Channel and Frequency List					
BW [MHz]	Channel/Frequency(MHz)		Lowest	Middle	Highest
20 + 20	PCC	Channel	20850	21001	21152
		Frequency	2510.0	2525.1	2540.2
	SCC	Channel	21048	21199	21350
		Frequency	2529.8	2544.9	2560.0
20 + 15	PCC	Channel	20850	21026	21201
		Frequency	2510.0	2527.6	2545.1
	SCC	Channel	21021	21197	21372
		Frequency	2527.1	2544.7	2562.2
15 + 20	PCC	Channel	20828	21003	21179
		Frequency	2507.8	2525.3	2542.9
	SCC	Channel	20999	21174	21350
		Frequency	2524.9	2542.4	2560.0
20 + 10	PCC	Channel	20850	21051	21251
		Frequency	2510.0	2530.1	2550.1
	SCC	Channel	20994	21195	21395
		Frequency	2524.4	2544.5	2564.5
10 + 20	PCC	Channel	20805	21006	21206
		Frequency	2505.5	2525.6	2545.6
	SCC	Channel	20949	21150	21350
		Frequency	2519.9	2540.0	2560.0
15 + 15	PCC	Channel	20825	21025	21225
		Frequency	2507.5	2527.5	2547.5
	SCC	Channel	20975	21175	21375
		Frequency	2522.5	2542.5	2562.5
15 + 10	PCC	Channel	20825	21051	21277
		Frequency	2507.5	2530.1	2552.7
	SCC	Channel	20945	21171	21397
		Frequency	2519.5	2542.1	2564.7

3 Conducted Test Items

3.1 Measuring Instruments

See list of measuring instruments of this test report.

3.2 Test Setup

3.2.1 Conducted Output Power



3.2.2 Peak-to-Average Ratio, Occupied Bandwidth ,Conducted Band-Edge and Conducted Spurious Emission



3.2.3 Frequency Stability

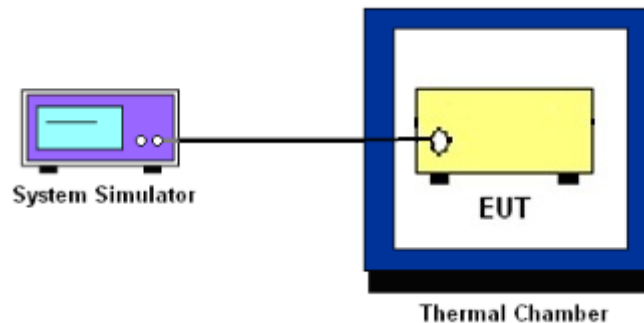

3.3 Test Result of Conducted Test

Please refer to Appendix A.



3.4 Conducted Output Power and ERP/EIRP

3.4.1 Description of the Conducted Output Power Measurement and ERP/EIRP Measurement

A system simulator was used to establish communication with the EUT. Its parameters were set to force the EUT transmitting at maximum output power. The measured power in the radio frequency on the transmitter output terminals shall be reported.

The ERP of mobile transmitters must not exceed 3 Watts for LTE Band 12, Band 13 and Band 17.

The EIRP of mobile transmitters must not exceed 2 Watts for LTE Band 7 and Band 38 and Band 41.

According to KDB 412172 D01 Power Approach,

$EIRP = P_T + G_T - L_C$, $ERP = EIRP - 2.15$, where

P_T = transmitter output power in dBm

G_T = gain of the transmitting antenna in dBi

L_C = signal attenuation in the connecting cable between the transmitter and antenna in dB

3.4.2 Test Procedures

1. The testing follows ANSI C63.26 Section 5.2
2. The transmitter output port was connected to the system simulator.
3. Set EUT at maximum power through the system simulator.
4. Select lowest, middle, and highest channels for each band and different modulation.
5. Measure and record the power level from the system simulator.



3.5 Peak-to-Average Ratio

3.5.1 Description of the PAR Measurement

Power Complementary Cumulative Distribution Function (CCDF) curves provide a means for characterizing the power peaks of a digitally modulated signal on a statistical basis. A CCDF curve depicts the probability of the peak signal amplitude exceeding the average power level. Most contemporary measurement instrumentation include the capability to produce CCDF curves for an input signal provided that the instrument's resolution bandwidth can be set wide enough to accommodate the entire input signal bandwidth. In measuring transmissions in this band using an average power technique, the peak-to-average ratio (PAR) of the transmission may not exceed 13 dB.

3.5.2 Test Procedures

1. The testing follows ANSI C63.26 Section 5.2.3.4 (CCDF).
2. The EUT was connected to spectrum and system simulator via a power divider.
3. Set the CCDF (Complementary Cumulative Distribution Function) option in spectrum analyzer.
4. The highest RF powers were measured and recorded the maximum PAPR level associated with a probability of 0.1 %.
5. Record the deviation as Peak to Average Ratio.



3.6 Occupied Bandwidth

3.6.1 Description of Occupied Bandwidth Measurement

The occupied bandwidth is the width of a frequency band such that, below the lower and above the upper frequency limits, the mean powers emitted are each equal to a specified percentage 0.5% of the total mean transmitted power.

The 26 dB emission bandwidth is defined as the frequency range between two points, one above and one below the carrier frequency, at which the spectral density of the emission is attenuated 26 dB below the maximum in-band spectral density of the modulated signal. Spectral density (power per unit bandwidth) is to be measured with a detector of resolution bandwidth equal to approximately 1.0% of the emission bandwidth.

3.6.2 Test Procedures

1. The testing follows ANSI C63.26 Section 5.4
2. The EUT was connected to spectrum analyzer and system simulator via a power divider.
3. The spectrum analyzer center frequency is set to the nominal EUT channel center frequency. The span range for the spectrum analyzer shall be between two and five times the anticipated OBW.
4. The nominal resolution bandwidth (RBW) shall be in the range of 1 to 5 % of the anticipated OBW, and the VBW shall be at least 3 times the RBW.
5. Set the detection mode to peak, and the trace mode to max hold.
6. Determine the reference value: Set the EUT to transmit a modulated signal. Allow the trace to stabilize. Set the spectrum analyzer marker to the highest level of the displayed trace.
(this is the reference value)
7. Determine the “-26 dB down amplitude” as equal to (Reference Value – X).
8. Place two markers, one at the lowest and the other at the highest frequency of the envelope of the spectral display such that each marker is at or slightly below the “-X dB down amplitude” determined in step 6. If a marker is below this “-X dB down amplitude” value it shall be placed as close as possible to this value. The OBW is the positive frequency difference between the two markers.
9. Use the 99 % power bandwidth function of the spectrum analyzer and report the measured bandwidth.



3.7 Conducted Band Edge

3.7.1 Description of Conducted Band Edge Measurement

27.53 (c)

For operations in the 776-788 MHz band, the FCC limit is $43 + 10\log_{10}(P[\text{Watts}])$ dB below the transmitter power P(Watts) in a 100 kHz bandwidth. However, in the 100 kHz bands immediately outside and adjacent to the frequency block, a resolution bandwidth of at least 30 kHz may be employed. In addition, the power of any unwanted emissions in any 6.25 kHz bandwidth for all frequencies between 763-775 MHz and 793-806 MHz shall be attenuated below the transmitter power, P (dBW), by at least $65 + 10 \log_{10} p(\text{watts})$, dB, for mobile and portable equipment.

27.53 (g)

For operations in the 600MHz band and 698 -746 MHz band, the FCC limit is $43 + 10\log_{10}(P[\text{Watts}])$ dB below the transmitter power P(Watts) in a 100 kHz bandwidth. However, in the 100 kilohertz bands immediately outside and adjacent to a licensee's frequency block, a resolution bandwidth of at least 30 kHz may be employed.

27.53(m)(4)

For mobile digital stations, the attenuation factor shall be not less than $40 + 10 \log (P)$ dB on all frequencies between the channel edge and 5 megahertz from the channel edge, $43 + 10 \log (P)$ dB on all frequencies between 5 megahertz and X megahertz from the channel edge, and $55 + 10 \log (P)$ dB on all frequencies more than X megahertz from the channel edge, where X is the greater of 6 megahertz or the actual emission bandwidth as defined in paragraph (m)(6) of this section. In addition, the attenuation factor shall not be less that $43 + 10 \log (P)$ dB on all frequencies between 2490.5 MHz and 2496 MHz and $55 + 10 \log (P)$ dB at or below 2490.5 MHz. Mobile Satellite Service licensees operating on frequencies below 2495 MHz may also submit a documented interference complaint against BRS licensees operating on channel BRS Channel 1 on the same terms and conditions as adjacent channel BRS or EBS licensees.



3.7.2 Test Procedures

1. The testing follows ANSI C63.26 section 5.7
2. The EUT was connected to spectrum analyzer and system simulator via a power divider.
3. The band edges of low and high channels for the highest RF powers were measured.
4. Set RBW \geq 1%/2% EBW in the 1MHz band immediately outside and adjacent to the band edge.
5. Beyond the 1 MHz band from the band edge, RBW=1MHz was used
6. Set spectrum analyzer with RMS detector.
7. The RF fundamental frequency should be excluded against the limit line in the operating frequency band.
8. Checked that all the results comply with the emission limit line.

Example:

The limit line is derived from $43 + 10\log(P)$ dB below the transmitter power P(Watts)
 $= P(W) - [43 + 10\log(P)]$ (dB)
 $= [30 + 10\log(P)]$ (dBm) - $[43 + 10\log(P)]$ (dB) = -13dBm.

9. For LTE Band 7, 38, 41, the other 40 dB, and 55 dB have additionally applied same calculation above.
10. When using the integration method, the starting frequency of the integration shall be centered at one-half of the RBW away from the band edge.



3.8 Conducted Spurious Emission

3.8.1 Description of Conducted Spurious Emission Measurement

The power of any emission outside of the authorized operating frequency ranges must be lower than the transmitter power (P) by a factor of at least $43 + 10 \log (P)$ dB.

For Band 7,38,41:

The power of any emission outside of the authorized operating frequency ranges must be lower than the transmitter power (P) by a factor of at least $55 + 10 \log (P)$ dB.

It is measured by means of a calibrated spectrum analyzer and scanned from 30 MHz up to a frequency including its 10th harmonic.

3.8.2 Test Procedures

1. The testing follows ANSI C63.26 section 5.7
2. The EUT was connected to spectrum analyzer and system simulator via a power divider.
3. The RF output of EUT was connected to the spectrum analyzer by RF cable and attenuator. The path loss was compensated to the results for each measurement.
4. The middle channel for the highest RF power within the transmitting frequency was measured.
5. The conducted spurious emission for the whole frequency range was taken.
6. Make the measurement with the spectrum analyzer's RBW = 1MHz, VBW = 3MHz.
7. Set spectrum analyzer with RMS detector.
8. Taking the record of maximum spurious emission.
9. The RF fundamental frequency should be excluded against the limit line in the operating frequency band.
10. The limit line is derived from $43 + 10\log(P)$ dB below the transmitter power P(Watts)
 $= P(W) - [43 + 10\log(P)]$ (dB)
 $= [30 + 10\log(P)]$ (dBm) - $[43 + 10\log(P)]$ (dB)
 $= -13$ dBm.
11. For Band 7, 38, 41
The limit line is derived from $55 + 10\log(P)$ dB below the transmitter power P(Watts)
 $= P(W) - [55 + 10\log(P)]$ (dB)
 $= [30 + 10\log(P)]$ (dBm) - $[55 + 10\log(P)]$ (dB)
 $= -25$ dBm.



3.9 Frequency Stability

3.9.1 Description of Frequency Stability Measurement

The frequency stability shall be measured by variation of ambient temperature and variation of primary supply voltage to ensure that the fundamental emission stays within the authorized frequency block.

3.9.2 Test Procedures for Temperature Variation

1. The testing follows ANSI C63.26 section 5.6.4
2. The EUT was set up in the thermal chamber and connected with the system simulator.
3. With power OFF, the temperature was decreased to -30°C and the EUT was stabilized before testing. Power was applied and the maximum change in frequency was recorded within one minute.
4. With power OFF, the temperature was raised in 10°C step up to 50°C . The EUT was stabilized at each step for at least half an hour. Power was applied and the maximum frequency change was recorded within one minute.

3.9.3 Test Procedures for Voltage Variation

1. The testing follows ANSI C63.26 section 5.6.5
2. The EUT was placed in a temperature chamber at $20\pm 5^{\circ}\text{C}$ and connected with the system simulator.
3. The power supply voltage to the EUT was varied from 85% to 115% of the nominal value for other than hand carried battery equipment.
4. For hand carried, battery powered equipment, reduce the primary ac or dc supply voltage to the battery operating end point, which shall be specified by the manufacturer.
5. The variation in frequency was measured for the worst case.

4 Radiated Test Items

4.1 Measuring Instruments

See list of measuring instruments of this test report.

4.2 Test Setup

4.2.1 For radiated test below 30MHz

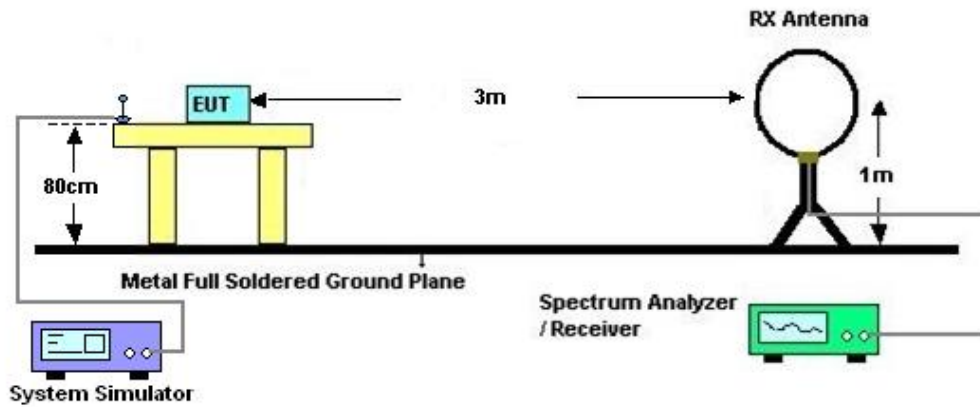

4.2.2 For radiated test from 30MHz to 1GHz

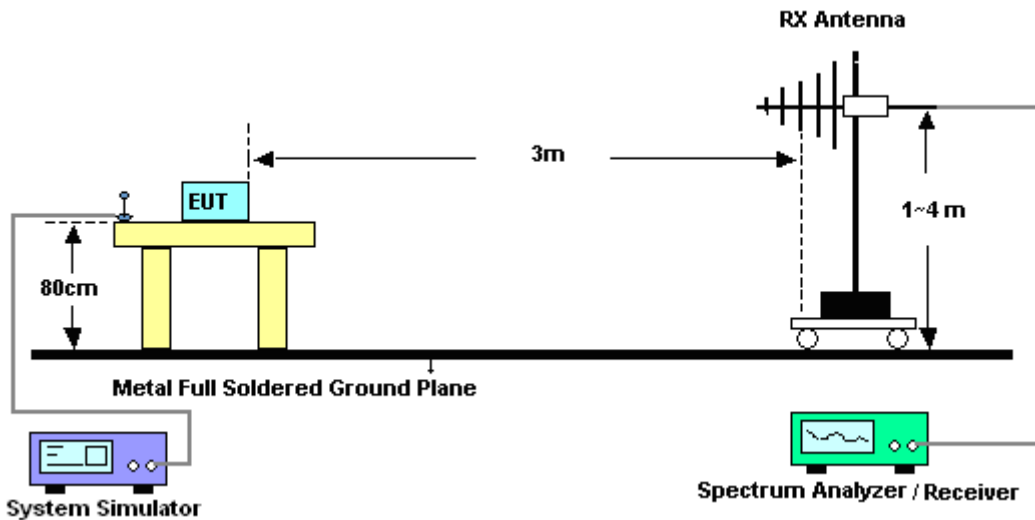

4.2.3 For radiated test above 1GHz

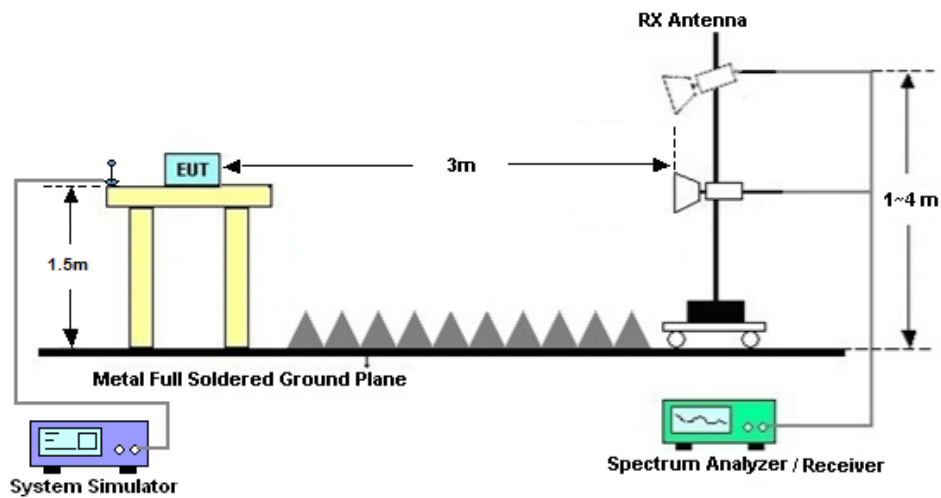

4.3 Test Result of Radiated Test

The low frequency, which started from 9 kHz to 30MHz, was pre-scanned and the result which was 20dB lower than the limit line was not reported.

Please refer to Appendix B.



4.4 Radiated Spurious Emission

4.4.1 Description of Radiated Spurious Emission

The radiated spurious emission was measured by substitution method according to ANSI C63.26. The power of any emission outside of the authorized operating frequency ranges must be attenuated below the transmitter power (P) by a factor of at least $43 + 10 \log (P)$ dB.

For Band 7, 38, 41

The power of any emission outside of the authorized operating frequency ranges must be attenuated below the transmitter power (P) by a factor of at least $55 + 10 \log (P)$ dB.

For LTE Band 13

For operations in the 746-758 MHz, 775-788 MHz, and 805-806 MHz bands, emissions in the band 1559-1610 MHz shall be limited to -70 dBW/MHz equivalent isotropically radiated power (EIRP) for wideband signals, and -80 dBW EIRP for discrete emissions of less than 700 Hz bandwidth.

The spectrum is scanned from 30 MHz up to a frequency including its 10th harmonic.

4.4.2 Test Procedures

1. The testing follows ANSI C63.26 Section 5.5
2. The EUT was placed on a turntable with 0.8 meter height for frequency below 1GHz and 1.5 meter height for frequency above 1GHz respectively above ground.
3. The EUT was set 3 meters from the receiving antenna mounted on the antenna tower.
4. The table was rotated 360 degrees to determine the position of the highest spurious emission.
5. The height of the receiving antenna is varied between 1m to 4m to search the maximum spurious emission for both horizontal and vertical polarizations.
6. During the measurement, the system simulator parameters were set to force the EUT transmitting at maximum output power.
7. Make the measurement with the spectrum analyzer's RBW = 1MHz, VBW = 3MHz, taking the record of maximum spurious emission.
8. A horn antenna was substituted in place of the EUT and was driven by a signal generator.
9. Tune the output power of signal generator to the same emission level with EUT maximum spurious emission.
10. $EIRP (dBm) = S.G. Power - Tx Cable Loss + Tx Antenna Gain$
11. $ERP (dBm) = EIRP - 2.15$
12. The RF fundamental frequency should be excluded against the limit line in the operating frequency band.
The limit line is derived from $43 + 10\log(P)$ dB below the transmitter power P(Watts)
 $= P(W) - [43 + 10\log(P)] (dB)$
 $= [30 + 10\log(P)] (dBm) - [43 + 10\log(P)] (dB)$
 $= -13dBm.$
13. For Band 7, 38, 41:
The limit line is derived from $55 + 10\log(P)$ dB below the transmitter power P(Watts)



5 List of Measuring Equipment

Instrument	Manufacturer	Model No.	Serial No.	Characteristics	Calibration Date	Test Date	Due Date	Remark
Spectrum Analyzer	R&S	FSV40	101078	10Hz~40GHz	Apr. 06, 2023	Mar. 19, 2024~ Mar. 25, 2024	Apr. 05, 2024	Conducted (TH01-SZ)
Power Divider	TOJOIN	PS-2SM-04 265	60.06.020.007 7	0.4GHz~26.5GHz	Dec. 25, 2023	Mar. 19, 2024~ Mar. 25, 2024	Dec. 24, 2024	Conducted (TH01-SZ)
Thermal Chamber	Ten Billion Hongzhangroup	LP-150U	H2014081803	-40~+150°C	Jul. 05, 2023	Mar. 19, 2024~ Mar. 25, 2024	Jul. 04, 2024	Conducted (TH01-SZ)
EMI Test Receiver&SA	Agilent	N9038A	MY52260185	20Hz~26.5GHz	Dec. 27, 2023	Mar. 24, 2024~ Mar. 28, 2024	Dec. 26, 2024	Radiation (03CH01-SZ)
Loop Antenna	R&S	HFH2-Z2	100354	9kHz~30MHz	Jul. 28, 2022	Mar. 24, 2024~ Mar. 28, 2024	Jul. 27, 2024	Radiation (03CH01-SZ)
HF Amplifier	KEYSIGHT	83017A	MY53270105	0.5GHz~26.5GHz	Oct. 18, 2023	Mar. 24, 2024~ Mar. 28, 2024	Oct. 17, 2024	Radiation (03CH01-SZ)
Bilog Antenna	TeseQ	CBL6112D	35407	30MHz-2GHz	Oct. 24, 2023	Mar. 24, 2024~ Mar. 28, 2024	Oct. 23, 2025	Radiation (03CH01-SZ)
Double Ridge Horn Antenna	ETS-Lindgren	3117	00119436	1GHz~18GHz	Jul. 08, 2023	Mar. 24, 2024~ Mar. 28, 2024	Jul. 07, 2024	Radiation (03CH01-SZ)
SHF-EHF Horn	com-power	AH-840	101071	18GHz-40GHz	Apr. 08, 2023	Mar. 24, 2024~ Mar. 28, 2024	Apr. 07, 2024	Radiation (03CH01-SZ)
LF Amplifier	Burgeon	BPA-530	102209	0.01~3000Mhz	Apr. 04, 2023	Mar. 24, 2024~ Mar. 28, 2024	Apr. 03, 2024	Radiation (03CH01-SZ)
HF Amplifier	MITEQ	AMF-7D-00 101800-30-1 0P-R	1943528	1GHz~18GHz	Oct. 18, 2023	Mar. 24, 2024~ Mar. 28, 2024	Oct. 17, 2024	Radiation (03CH01-SZ)
HF Amplifier	MITEQ	TTA1840-35 -HG	1871923	18GHz~40GHz	Jul. 07, 2023	Mar. 24, 2024~ Mar. 28, 2024	Jul. 06, 2024	Radiation (03CH01-SZ)
AC Power Source	Chroma	61601	61601000198 5	N/A	Oct. 18, 2023	Mar. 24, 2024~ Mar. 28, 2024	Oct. 17, 2024	Radiation (03CH01-SZ)
Turn Table	EM	EM1000	N/A	0~360 degree	NCR	Mar. 24, 2024~ Mar. 28, 2024	NCR	Radiation (03CH01-SZ)
Antenna Mast	EM	EM1000	N/A	1 m~4 m	NCR	Mar. 24, 2024~ Mar. 28, 2024	NCR	Radiation (03CH01-SZ)

NCR: No Calibration Required



6 Measurement Uncertainty

The measurement uncertainties shown below were calculated in accordance with the requirements of ANSI 63.26-2015. All the measurement uncertainty value were shown with a coverage K=2 to indicate 95% level of confidence. The measurement data show herein meets or exceeds the CISPR measurement uncertainty values specified in CISPR 16-4-2 and can be compared directly to specified limit to determine compliance.

Uncertainty of Conducted Measurement

Test Item	Uncertainty
Conducted Spurious Emission & Bandedge	±1.34 dB
Occupied Channel Bandwidth	±0.012 MHz
Conducted Power	±1.34 dB
Peak to Average Ratio	±1.34 dB
Frequency Stability	±1.3 ppm

Uncertainty of Radiated Emission Measurement (9 KHz ~ 30 MHz)

Measuring Uncertainty for a Level of Confidence of 95% (U = 2Uc(y))	2.8dB
---------------------------------------------------------------------	-------

Uncertainty of Radiated Emission Measurement (30 MHz ~ 1000 MHz)

Measuring Uncertainty for a Level of Confidence of 95% (U = 2Uc(y))	2.48 dB
---------------------------------------------------------------------	---------

Uncertainty of Radiated Emission Measurement (1 GHz ~ 18 GHz)

Measuring Uncertainty for a Level of Confidence of 95% (U = 2Uc(y))	3.53dB
---------------------------------------------------------------------	--------

Uncertainty of Radiated Emission Measurement (18 GHz ~ 40 GHz)

Measuring Uncertainty for a Level of Confidence of 95% (U = 2Uc(y))	4.02dB
---------------------------------------------------------------------	--------

----- THE END -----



Appendix A. Test Results of Conducted Test

Test Engineer :	Lorenzo Liu	Temperature :	24~26°C
		Relative Humidity :	50~53%

Conducted Output Power(Average power) and ERP/EIRP

LTE Band 7_Ant4:

BW [MHz]	Modulation	RB Size	RB Offset	Power Low Ch. / Freq.	Power Middle Ch. / Freq.	Power High Ch. / Freq.	EIRP(W)		
Channel				20850	20850	21350	EIRP(W)		
Frequency (MHz)				2510	2535	2560	L	M	H
20	QPSK	1	0	22.05	22.29	22.33	0.1567	0.1656	0.1671
20	QPSK	1	49	22.16	22.42	22.70	0.1607	0.1706	0.1820
20	QPSK	1	99	22.25	22.42	22.89	0.1641	0.1706	0.1901
20	QPSK	50	0	21.18	21.37	21.55	0.1282	0.1340	0.1396
20	QPSK	50	24	21.25	21.42	21.66	0.1303	0.1355	0.1432
20	QPSK	50	50	21.28	21.45	21.83	0.1312	0.1365	0.1489
20	QPSK	100	0	21.27	21.40	21.67	0.1309	0.1349	0.1435
20	16QAM	1	0	21.49	21.70	21.60	0.1377	0.1445	0.1413
20	64QAM	1	0	20.37	20.54	20.44	0.1064	0.1107	0.1081
20	256QAM	1	0	17.66	17.76	17.64	0.0570	0.0583	0.0568
Channel				20825	21100	21375	EIRP(W)		
Frequency (MHz)				2507.5	2535	2562.5	L	M	H
15	QPSK	1	0	21.86	22.15	22.23	0.1500	0.1603	0.1633
15	16QAM	1	0	21.32	21.64	21.43	0.1324	0.1426	0.1358
Channel				20800	21100	21400	EIRP(W)		
Frequency (MHz)				2505	2535	2565	L	M	H
10	QPSK	1	0	21.88	22.17	22.15	0.1507	0.1611	0.1603
10	16QAM	1	0	21.32	21.61	21.47	0.1324	0.1416	0.1371
Channel				20775	21100	21425	EIRP(W)		
Frequency (MHz)				2502.5	2535	2567.5	L	M	H
5	QPSK	1	0	21.95	22.12	22.26	0.1531	0.1592	0.1644
5	16QAM	1	0	21.41	21.59	21.42	0.1352	0.1409	0.1355



LTE Band 12_Ant0:

BW [MHz]	Modulation	RB Size	RB Offset	Power Low Ch. / Freq.	Power Middle Ch. / Freq.	Power High Ch. / Freq.	ERP(W)		
Channel				23060	23095	23130			
Frequency (MHz)				704	707.5	711	L	M	H
10	QPSK	1	0	24.15	24.18	24.15	0.0759	0.0764	0.0759
10	QPSK	1	25	24.07	24.15	24.03	0.0745	0.0759	0.0738
10	QPSK	1	49	24.12	24.07	24.10	0.0753	0.0745	0.0750
10	QPSK	25	0	23.10	23.13	23.11	0.0596	0.0600	0.0597
10	QPSK	25	12	23.00	23.07	23.09	0.0582	0.0592	0.0594
10	QPSK	25	25	23.09	23.10	23.10	0.0594	0.0596	0.0596
10	QPSK	50	0	23.11	23.12	23.11	0.0597	0.0598	0.0597
10	16QAM	1	0	23.30	23.37	23.39	0.0624	0.0634	0.0637
10	64QAM	1	0	22.34	22.16	22.35	0.0500	0.0480	0.0501
10	256QAM	1	0	18.69	18.63	18.67	0.0216	0.0213	0.0215
Channel				23035	23095	23155	ERP(W)		
Frequency (MHz)				701.5	707.5	713.5	L	M	H
5	QPSK	1	0	24.03	24.03	24.03	0.0738	0.0738	0.0738
5	16QAM	1	0	23.15	23.27	23.31	0.0603	0.0619	0.0625
Channel				23025	23095	23165			
Frequency (MHz)				700.5	707.5	714.5	L	M	H
3	QPSK	1	0	23.97	24.03	24.01	0.0728	0.0738	0.0735
3	16QAM	1	0	23.19	23.29	23.33	0.0608	0.0622	0.0628
Channel				23017	23095	23173	ERP(W)		
Frequency (MHz)				699.7	707.5	715.3	L	M	H
1.4	QPSK	1	0	24.04	24.03	24.05	0.0740	0.0738	0.0741
1.4	16QAM	1	0	23.11	23.24	23.32	0.0597	0.0615	0.0627

LTE Band 13_Ant0:

BW [MHz]	Modulation	RB Size	RB Offset	Power Low Ch. / Freq.	Power Middle Ch. / Freq.	Power High Ch. / Freq.	ERP(W)		
Channel				23230					
Frequency (MHz)				782				M	
10	QPSK	1	0		24.09			0.0622	
10	QPSK	1	25		24.07			0.0619	
10	QPSK	1	49		24.08			0.0621	
10	QPSK	25	0		23.07			0.0492	
10	QPSK	25	12		23.03			0.0488	
10	QPSK	25	25		23.05			0.0490	
10	QPSK	50	0		23.06			0.0491	
10	16QAM	1	0		23.42			0.0533	
10	64QAM	1	0		22.23			0.0406	
10	256QAM	1	0		18.44			0.0169	
Channel				23205	23230	23255	ERP(W)		
Frequency (MHz)				779.5	782	784.5	L	M	H
5	QPSK	1	0	23.93	23.96	23.91	0.0600	0.0604	0.0597
5	16QAM	1	0	23.33	23.31	23.33	0.0522	0.0520	0.0522



LTE Band 17_Ant0:

BW [MHz]	Modulation	RB Size	RB Offset	Power Low Ch. / Freq.	Power Middle Ch. / Freq.	Power High Ch. / Freq.	ERP(W)		
Channel				23780	23790	23800			
Frequency (MHz)				709	710	711	L	M	H
10	QPSK	1	0	23.74	23.80	23.76	0.0690	0.0700	0.0693
10	QPSK	1	25	23.60	23.70	23.68	0.0668	0.0684	0.0681
10	QPSK	1	49	23.70	23.73	23.71	0.0684	0.0689	0.0685
10	QPSK	25	0	22.62	22.70	22.69	0.0533	0.0543	0.0542
10	QPSK	25	12	22.60	22.67	22.67	0.0531	0.0540	0.0540
10	QPSK	25	25	22.60	22.66	22.66	0.0531	0.0538	0.0538
10	QPSK	50	0	22.61	22.67	22.63	0.0532	0.0540	0.0535
10	16QAM	1	0	23.00	22.98	22.97	0.0582	0.0579	0.0578
10	64QAM	1	0	21.90	21.85	21.87	0.0452	0.0447	0.0449
10	256QAM	1	0	18.68	18.65	18.60	0.0215	0.0214	0.0211
Channel				23755	23790	23825	ERP(W)		
Frequency (MHz)				706.5	710	713.5	L	M	H
5	QPSK	1	0	23.60	23.65	23.64	0.0668	0.0676	0.0675
5	16QAM	1	0	22.89	23.03	23.02	0.0568	0.0586	0.0585

LTE Band 38_Ant4:

BW [MHz]	Modulation	RB Size	RB Offset	Power Low Ch. / Freq.	Power Middle Ch. / Freq.	Power High Ch. / Freq.	EIRP(W)		
Channel				37850	38000	38150			
Frequency (MHz)				2580	2595	2610	L	M	H
20	QPSK	1	0	23.14	23.22	23.20	0.1714	0.1746	0.1738
20	QPSK	1	49	23.07	23.18	23.17	0.1687	0.1730	0.1726
20	QPSK	1	99	22.85	22.91	23.11	0.1603	0.1626	0.1702
20	QPSK	50	0	22.11	22.20	22.19	0.1352	0.1380	0.1377
20	QPSK	50	24	22.10	22.14	22.16	0.1349	0.1361	0.1368
20	QPSK	50	50	22.09	22.15	22.13	0.1346	0.1365	0.1358
20	QPSK	100	0	22.03	22.18	22.17	0.1327	0.1374	0.1371
20	16QAM	1	0	22.00	22.04	22.15	0.1318	0.1330	0.1365
20	64QAM	1	0	20.71	20.76	20.93	0.0979	0.0991	0.1030
20	256QAM	1	0	18.39	18.45	18.32	0.0574	0.0582	0.0565
Channel				37825	38000	38175	EIRP(W)		
Frequency (MHz)				2577.5	2595	2612.5	L	M	H
15	QPSK	1	0	23.04	23.13	23.14	0.1675	0.1710	0.1714
15	16QAM	1	0	21.86	21.97	22.04	0.1276	0.1309	0.1330
Channel				37800	38000	38200	EIRP(W)		
Frequency (MHz)				2575	2595	2615	L	M	H
10	QPSK	1	0	23.00	23.08	23.11	0.1660	0.1690	0.1702
10	16QAM	1	0	21.95	21.89	22.09	0.1303	0.1285	0.1346
Channel				37775	38000	38225	EIRP(W)		
Frequency (MHz)				2572.5	2595	2617.5	L	M	H
5	QPSK	1	0	23.04	23.10	23.06	0.1675	0.1698	0.1683
5	16QAM	1	0	21.94	21.96	22.04	0.1300	0.1306	0.1330



LTE Band 41_Ant4:

BW [MHz]	Modulation	RB Size	RB Offset	Power Low Ch. / Freq.	Power Middle Ch. / Freq.	Power High Ch. / Freq.	EIRP(W)		
Channel				39750	40620	41490			
Frequency (MHz)				2506	2593	2680	L	M	H
20	QPSK	1	0	22.88	23.31	22.93	0.1614	0.1782	0.1633
20	QPSK	1	49	22.82	23.27	22.89	0.1592	0.1766	0.1618
20	QPSK	1	99	22.83	23.16	22.78	0.1596	0.1722	0.1578
20	QPSK	50	0	21.91	22.40	22.05	0.1291	0.1445	0.1334
20	QPSK	50	24	21.88	22.32	22.02	0.1282	0.1419	0.1324
20	QPSK	50	50	21.89	22.30	21.97	0.1285	0.1413	0.1309
20	QPSK	100	0	21.85	22.38	21.98	0.1274	0.1439	0.1312
20	16QAM	1	0	21.99	22.28	22.14	0.1315	0.1406	0.1361
20	64QAM	1	0	20.77	21.15	21.06	0.0993	0.1084	0.1062
20	256QAM	1	0	18.23	17.86	17.92	0.0553	0.0508	0.0515
Channel				39725	40620	41515	EIRP(W)		
Frequency (MHz)				2503.5	2593	2682.5	L	M	H
15	QPSK	1	0	22.74	23.14	22.82	0.1563	0.1714	0.1592
15	16QAM	1	0	21.88	22.17	21.92	0.1282	0.1371	0.1294
Channel				39700	40620	41540	EIRP(W)		
Frequency (MHz)				2501	2593	2685	L	M	H
10	QPSK	1	0	22.75	23.12	22.79	0.1567	0.1706	0.1581
10	16QAM	1	0	21.85	22.09	21.91	0.1274	0.1346	0.1291
Channel				39675	40620	41565	EIRP(W)		
Frequency (MHz)				2498.5	2593	2687.5	L	M	H
5	QPSK	1	0	22.75	23.15	22.71	0.1567	0.1718	0.1552
5	16QAM	1	0	21.75	22.07	21.96	0.1245	0.1340	0.1306



CA Power

LTE CA_7C_Ant4:

Combination 20MHz+20MHz (100RB+100RB)							
Channel	Modulation	PCC		SCC		Measured Power	EIRP(W)
		RB Size	RB offset	RB Size	RB offset		
L	QPSK	1	Max	1	0	22.82	0.1871
M	QPSK	1	Max	1	0	22.76	0.1845
H	QPSK	1	Max	1	0	22.74	0.1837
L	16QAM	1	Max	1	0	21.69	0.1442
M	16QAM	1	Max	1	0	21.80	0.1479
H	16QAM	1	Max	1	0	21.75	0.1462
L	64QAM	1	Max	1	0	20.81	0.1178
M	64QAM	1	Max	1	0	20.83	0.1183
H	64QAM	1	Max	1	0	20.79	0.1172
L	256QAM	1	Max	1	0	17.72	0.0578
M	256QAM	1	Max	1	0	17.69	0.0574
H	256QAM	1	Max	1	0	17.64	0.0568
Combination 20MHz+15MHz (100RB+75RB)							
Channel	Modulation	PCC		SCC		Measured Power	EIRP(W)
		RB Size	RB offset	RB Size	RB offset		
L	QPSK	1	Max	1	0	22.78	0.1854
M	16QAM	1	Max	1	0	21.67	0.1435
Combination 15MHz+20MHz (75RB+100RB)							
Channel	Modulation	PCC		SCC		Measured Power	EIRP(W)
		RB Size	RB offset	RB Size	RB offset		
L	QPSK	1	Max	1	0	22.66	0.1803
M	16QAM	1	Max	1	0	21.65	0.1429
Combination 15MHz+15MHz (75RB+75RB)							
Channel	Modulation	PCC		SCC		Measured Power	EIRP(W)
		RB Size	RB offset	RB Size	RB offset		
L	QPSK	1	Max	1	0	22.62	0.1786
M	16QAM	1	Max	1	0	21.59	0.1409
Combination 20MHz+10MHz (100RB+50RB)							
Channel	Modulation	PCC		SCC		Measured Power	EIRP(W)
		RB Size	RB offset	RB Size	RB offset		
L	QPSK	1	Max	1	0	22.63	0.1791
M	16QAM	1	Max	1	0	21.59	0.1409
Combination 10MHz+20MHz (50RB+100RB)							
Channel	Modulation	PCC		SCC		Measured Power	EIRP(W)
		RB Size	RB offset	RB Size	RB offset		
L	QPSK	1	Max	1	0	22.65	0.1799
M	16QAM	1	Max	1	0	21.70	0.1445
Combination 15MHz+10MHz (75RB+50RB)							
Channel	Modulation	PCC		SCC		Measured Power	EIRP(W)
		RB Size	RB offset	RB Size	RB offset		
L	QPSK	1	Max	1	0	22.72	0.1828
M	16QAM	1	Max	1	0	21.65	0.1429



LTE Band 7

Peak-to-Average Ratio

Mode	LTE Band 7 / 20MHz			
Mod.	QPSK	16QAM	64QAM	Limit: 13dB
RB Size	Full RB	Full RB	Full RB	Result
Middle CH	5.07	6.12	6.29	PASS

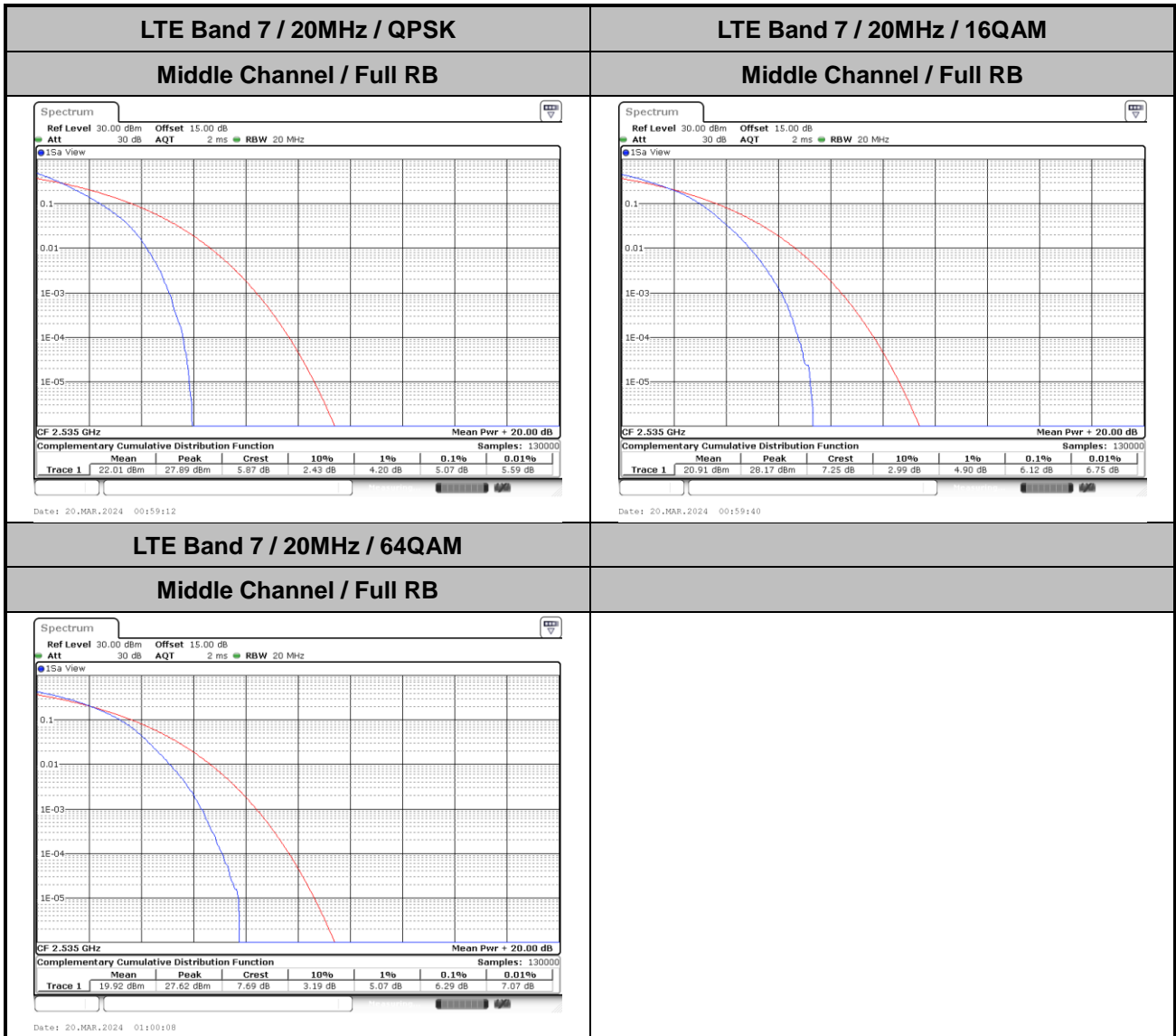



26dB Bandwidth

Mode	LTE Band 7 : 26dB BW(MHz)							
	5MHz		10MHz		15MHz		20MHz	
BW								
Mod.	QPSK	16QAM	QPSK	16QAM	QPSK	16QAM	QPSK	16QAM
Middle CH	4.95	4.91	9.79	9.83	14.54	14.57	18.82	18.66



LTE Band 7

Middle Channel / 5MHz / QPSK

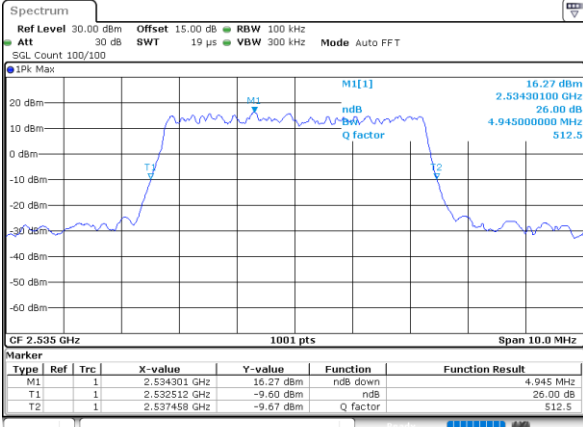

Date: 19_MAR_2024 23:24:38

Middle Channel / 5MHz / 16QAM

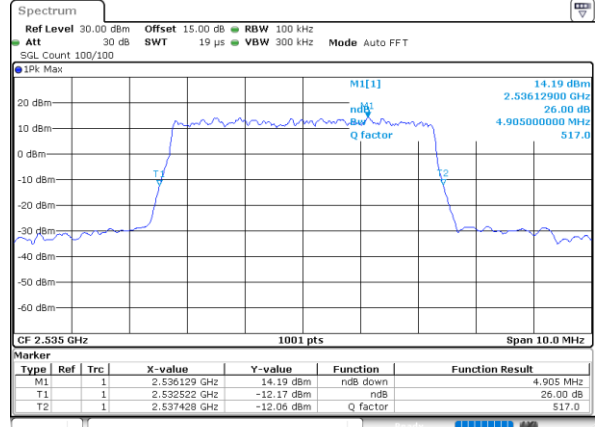

Date: 19_MAR_2024 23:25:25

Middle Channel / 10MHz / QPSK

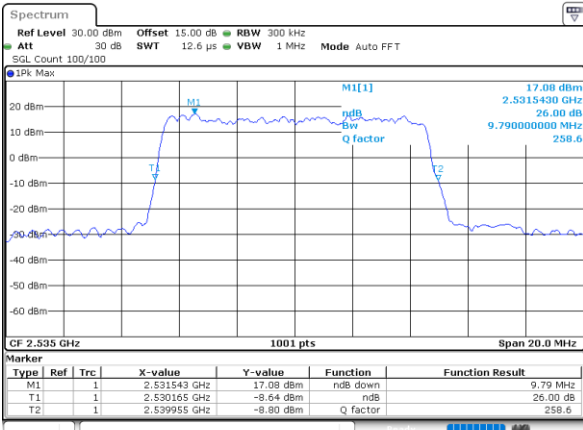

Date: 20_MAR_2024 00:20:40

Middle Channel / 10MHz / 16QAM

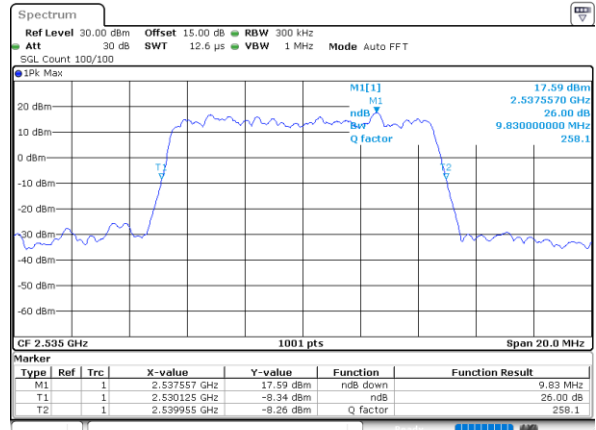

Date: 20_MAR_2024 00:21:20

Middle Channel / 15MHz / QPSK

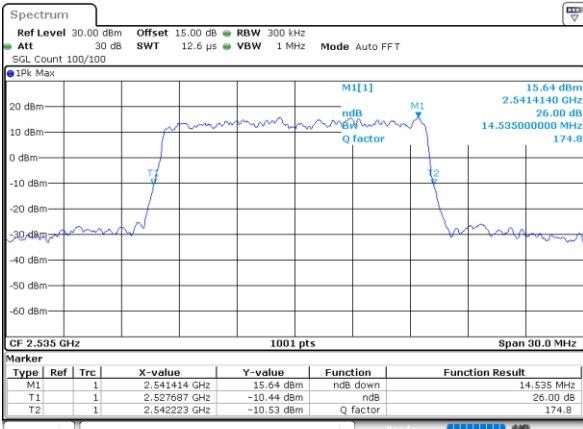

Date: 20_MAR_2024 00:36:40

Middle Channel / 15MHz / 16QAM

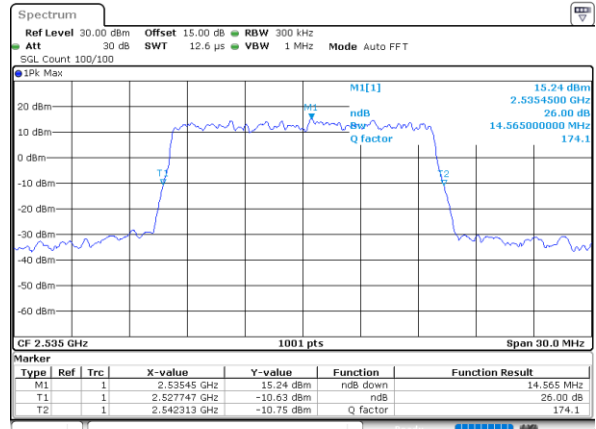

Date: 20_MAR_2024 00:37:21



LTE Band 7

Middle Channel / 20MHz / QPSK

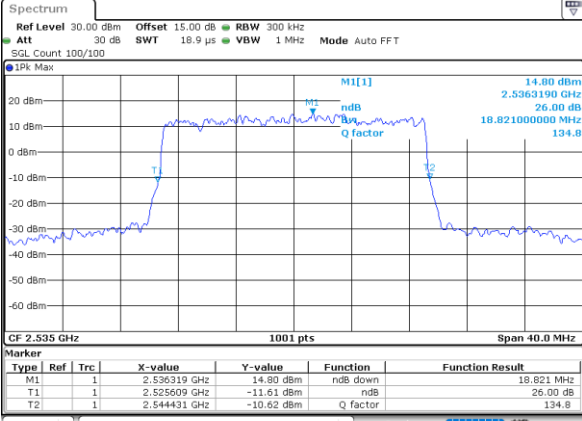

Date: 20_MAR_2024 00:58:04

Middle Channel / 20MHz / 16QAM

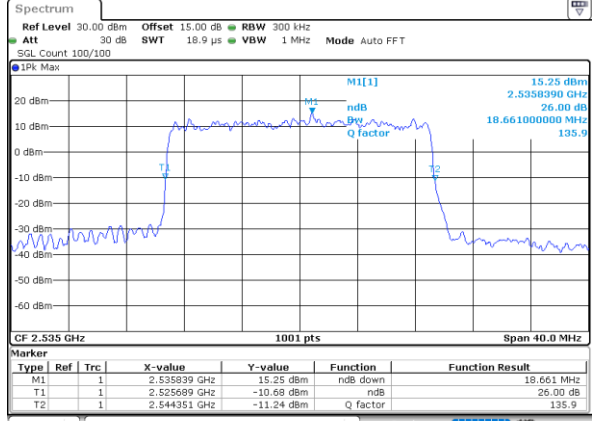

Date: 20_MAR_2024 00:58:45



Occupied Bandwidth

Mode	LTE Band 7 : 99%OBW(MHz)							
	5MHz		10MHz		15MHz		20MHz	
BW								
Mod.	QPSK	16QAM	QPSK	16QAM	QPSK	16QAM	QPSK	16QAM
Middle CH	4.50	4.48	9.05	9.01	13.43	13.46	17.86	17.82



LTE Band 7

Middle Channel / 5MHz / QPSK

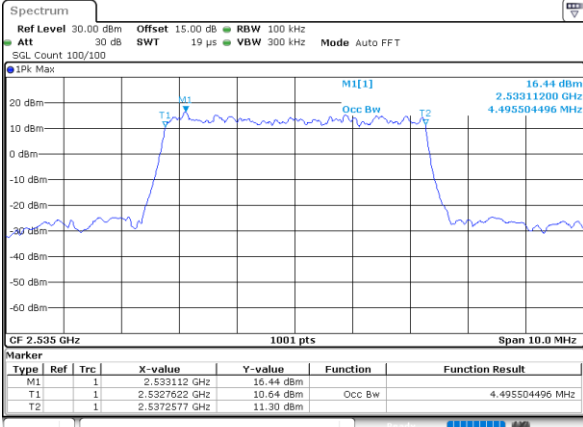

Date: 19_MAR_2024 23:24:24

Middle Channel / 5MHz / 16QAM

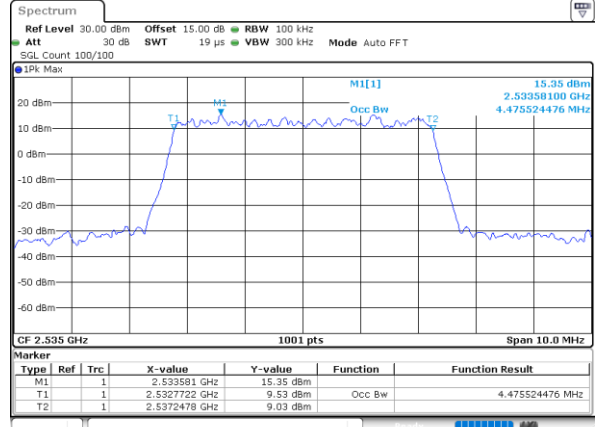

Date: 19_MAR_2024 23:25:07

Middle Channel / 10MHz / QPSK

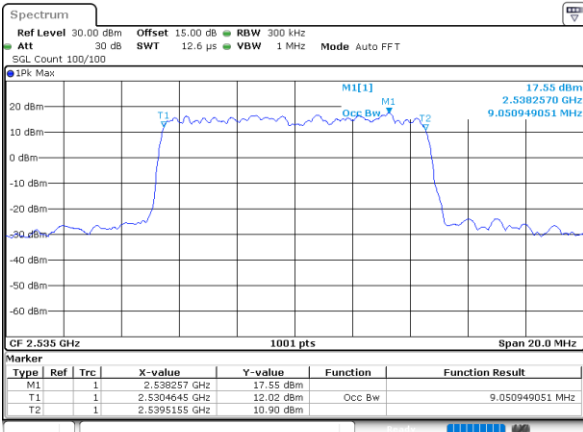

Date: 20_MAR_2024 00:20:26

Middle Channel / 10MHz / 16QAM

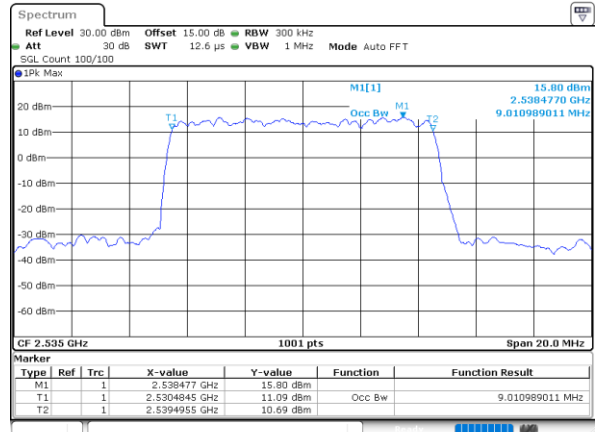

Date: 20_MAR_2024 00:21:06

Middle Channel / 15MHz / QPSK

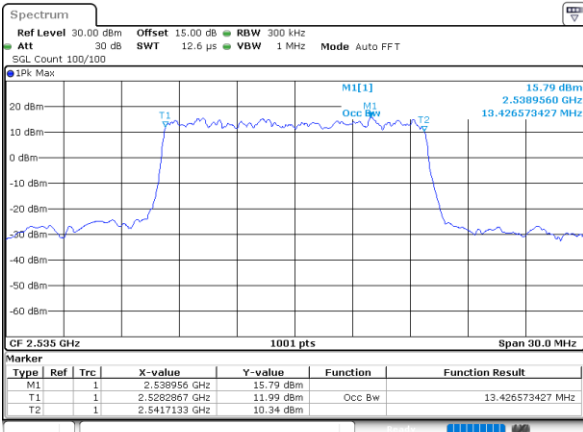

Date: 20_MAR_2024 00:36:27

Middle Channel / 15MHz / 16QAM

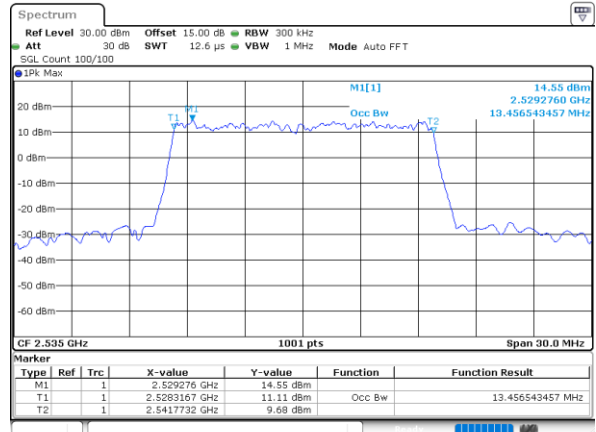

Date: 20_MAR_2024 00:37:07



LTE Band 7

Middle Channel / 20MHz / QPSK

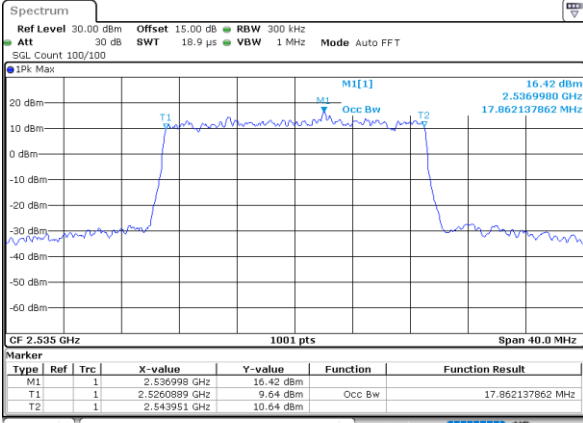

Date: 20.MAR.2024 00:57:50

Middle Channel / 20MHz / 16QAM

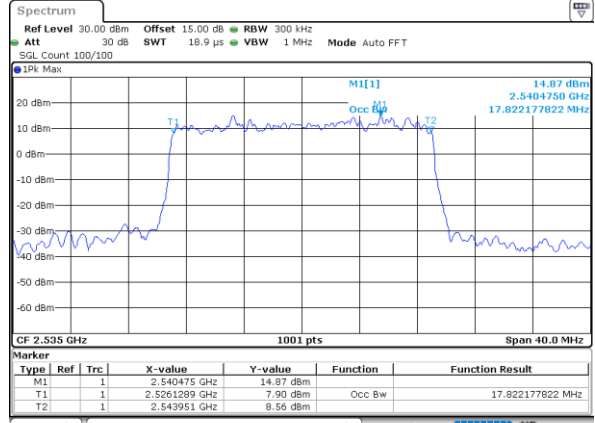

Date: 20.MAR.2024 00:58:31



Conducted Band Edge

LTE Band 7 / 5MHz / QPSK

Lowest Band Edge / 1 RB

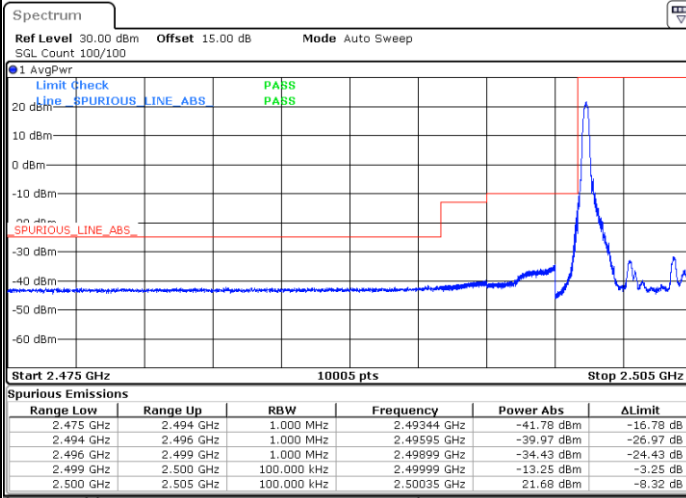

Date: 19.MAR.2024 23:17:14

Highest Band Edge / 1 RB

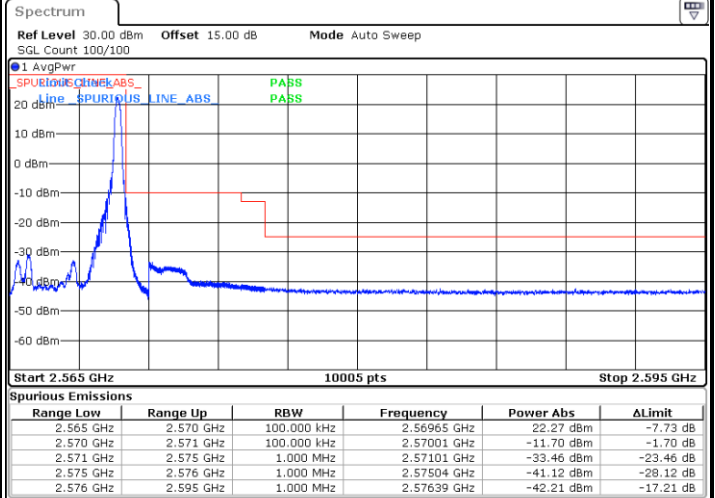

Date: 19.MAR.2024 23:26:15

Lowest Band Edge / Full RB

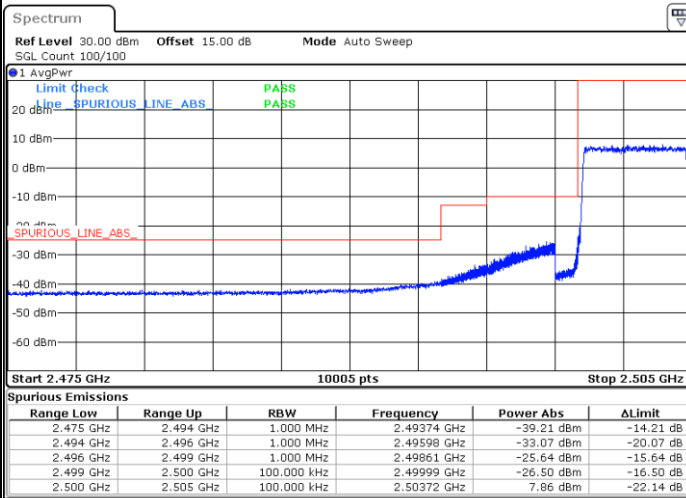

Date: 19.MAR.2024 23:19:51

Highest Band Edge / Full RB

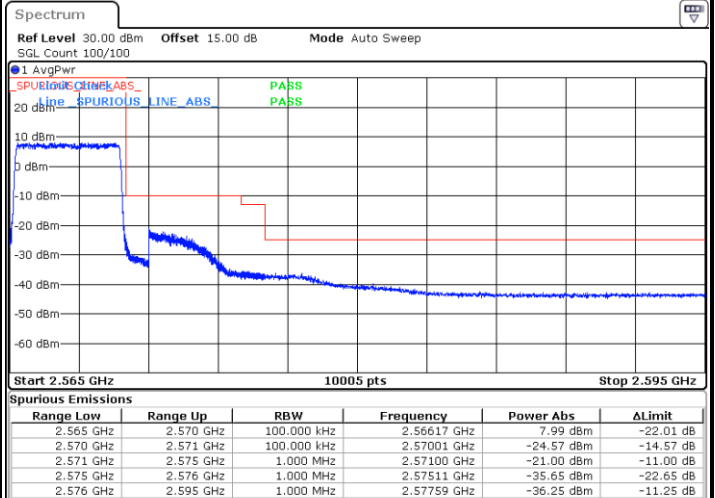

Date: 19.MAR.2024 23:28:47



LTE Band 7 / 5MHz / 16QAM

Lowest Band Edge / 1RB

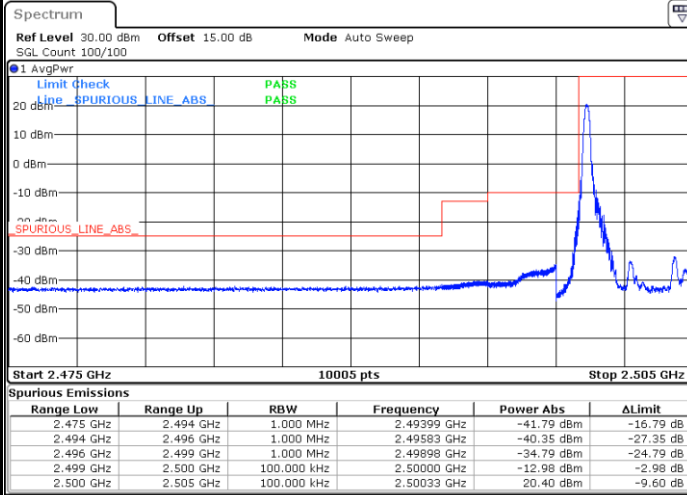

Date: 19.MAR.2024 23:18:06

Highest Band Edge / 1 RB

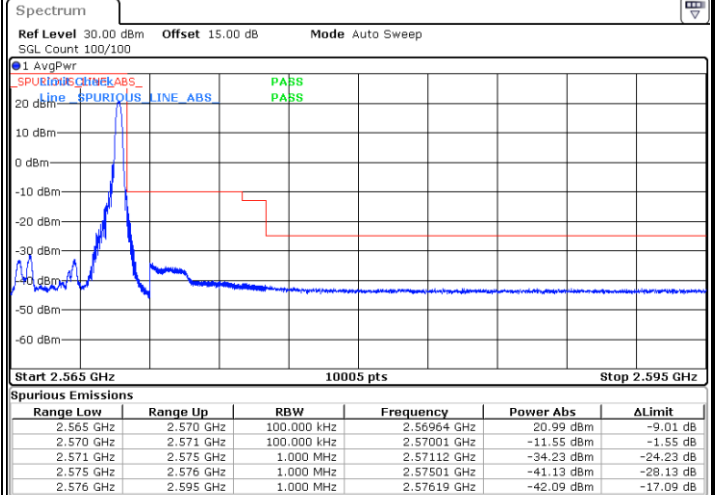

Date: 19.MAR.2024 23:27:06

Lowest Band Edge / Full RB

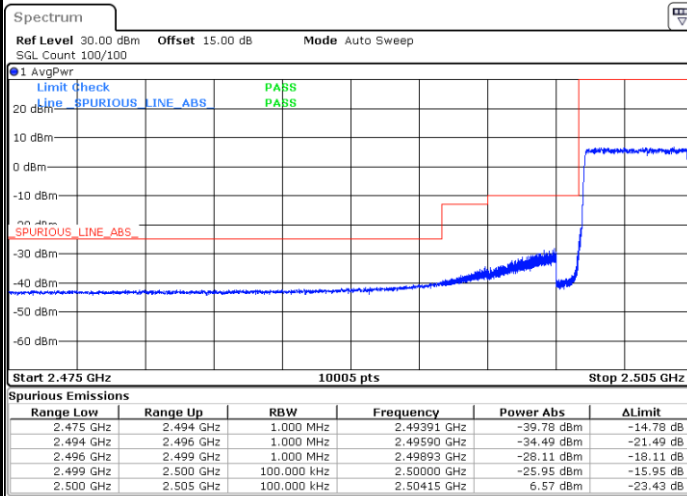

Date: 19.MAR.2024 23:20:43

Highest Band Edge / Full RB

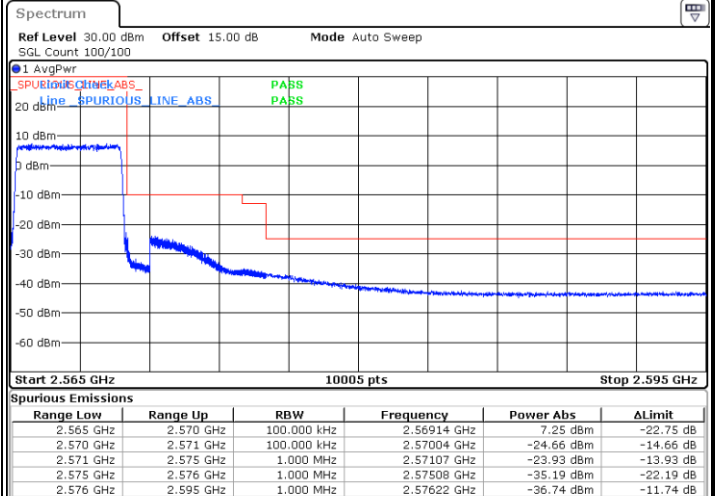

Date: 19.MAR.2024 23:29:38



LTE Band 7 / 5MHz / 64QAM

Lowest Band Edge / 1RB

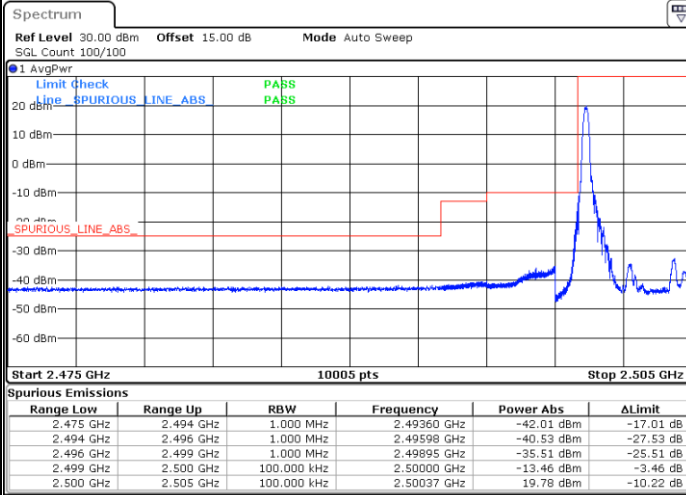

Date: 19.MAR.2024 23:18:59

Highest Band Edge / 1 RB

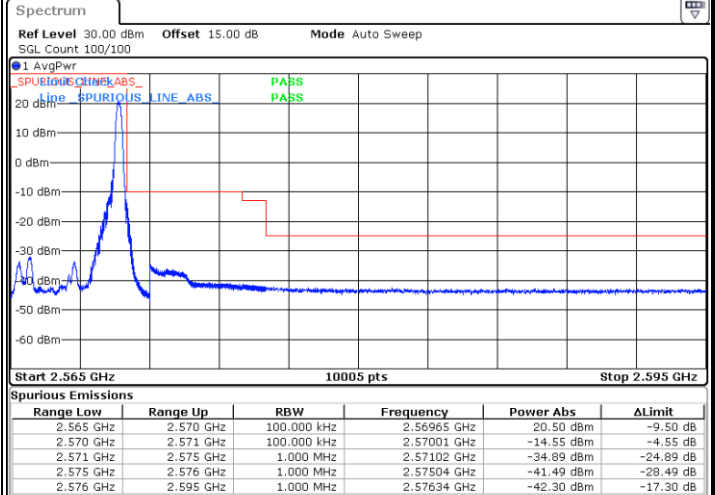

Date: 19.MAR.2024 23:27:57

Lowest Band Edge / Full RB

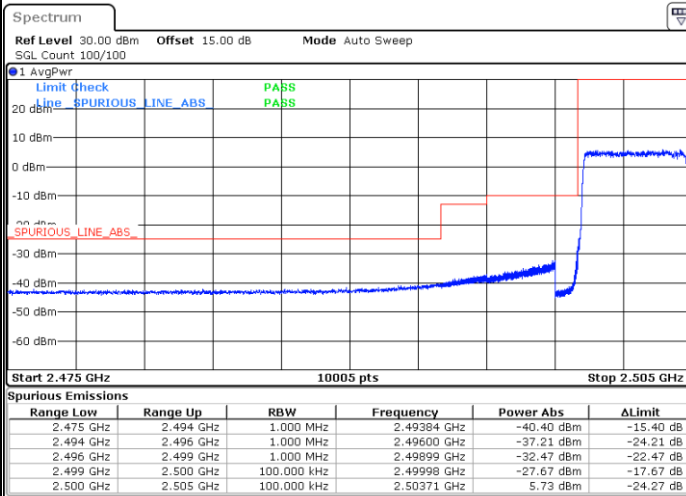

Date: 19.MAR.2024 23:21:37

Highest Band Edge / Full RB

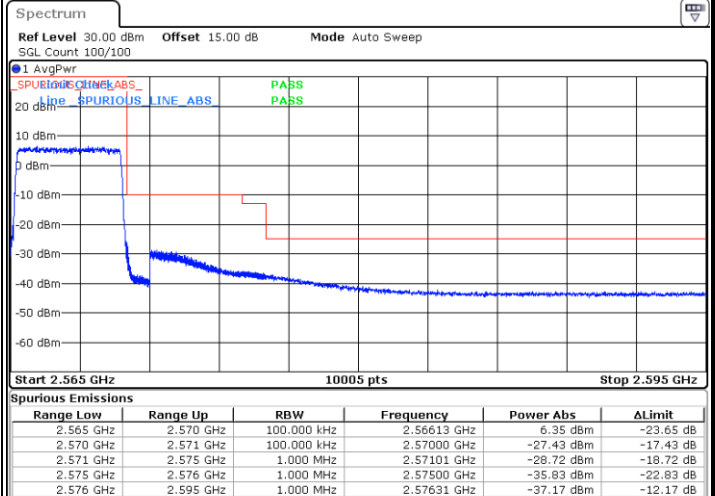

Date: 19.MAR.2024 23:30:29



LTE Band 7 / 10MHz / QPSK

Lowest Band Edge / 1 RB

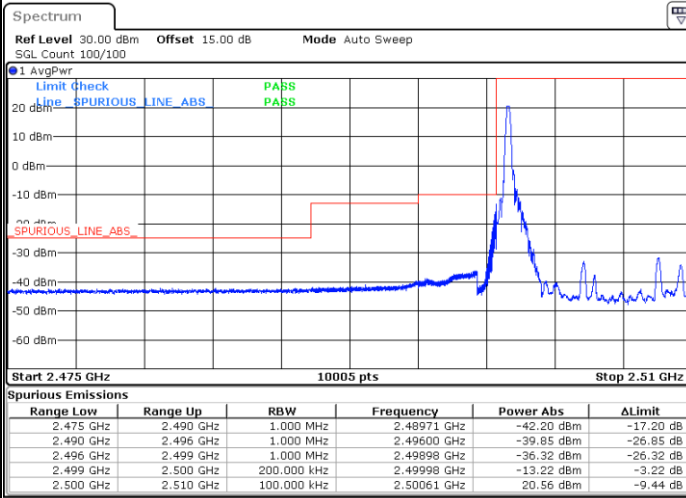

Date: 20.MAR.2024 00:13:21

Highest Band Edge / 1 RB

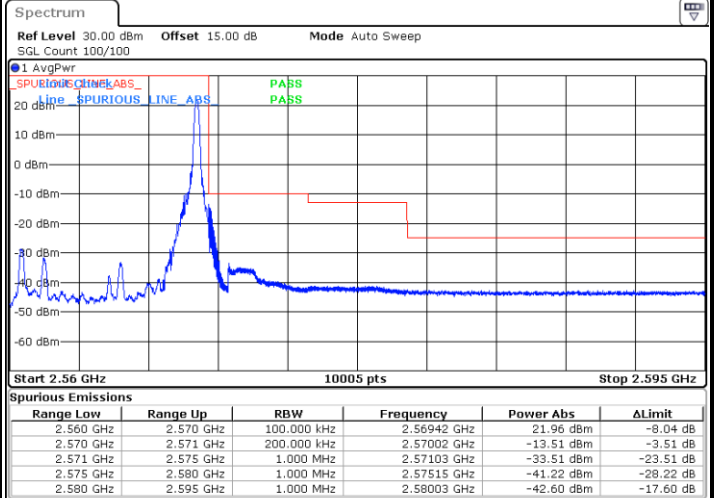

Date: 20.MAR.2024 00:22:11

Lowest Band Edge / Full RB

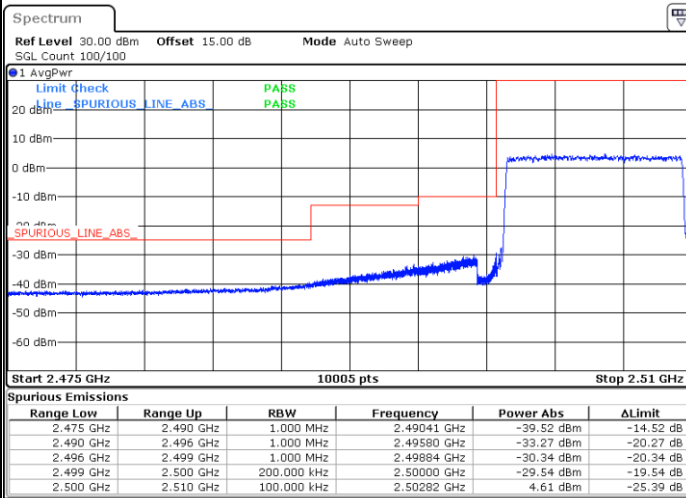

Date: 20.MAR.2024 00:15:55

Highest Band Edge / Full RB

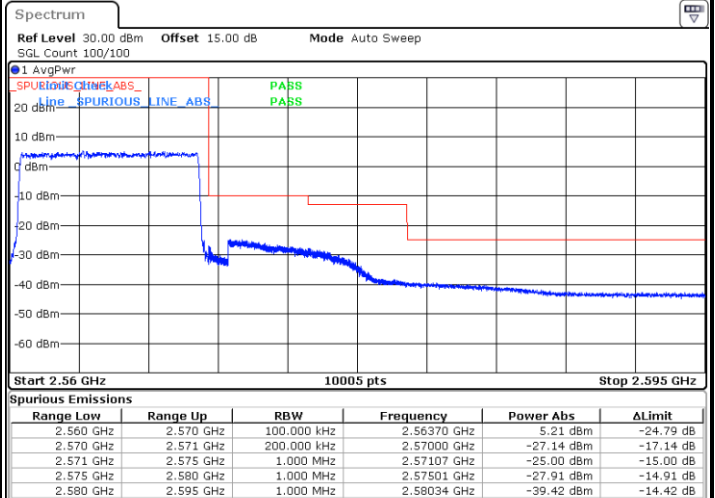

Date: 20.MAR.2024 00:24:46



LTE Band 7 / 10MHz / 16QAM

Lowest Band Edge / 1RB

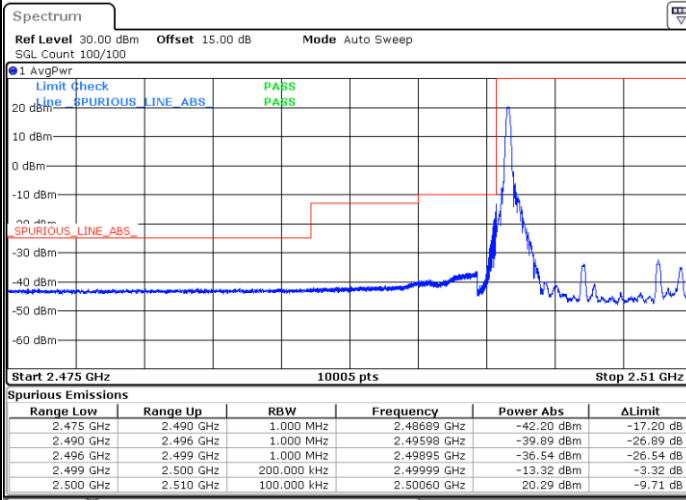

Date: 20.MAR.2024 00:14:12

Highest Band Edge / 1 RB

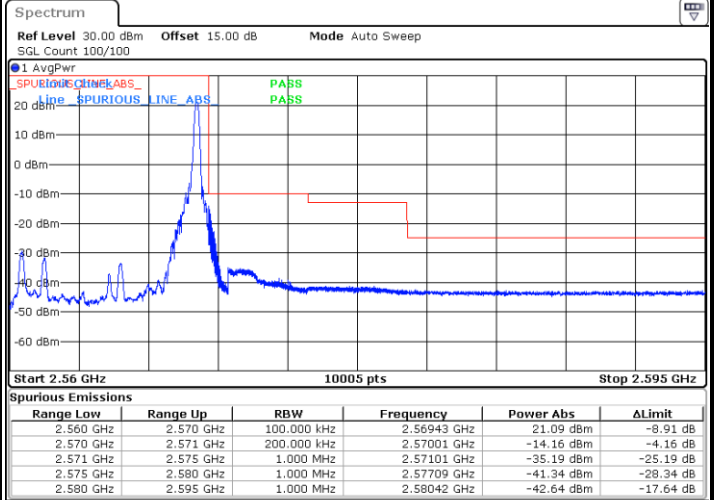

Date: 20.MAR.2024 00:23:02

Lowest Band Edge / Full RB

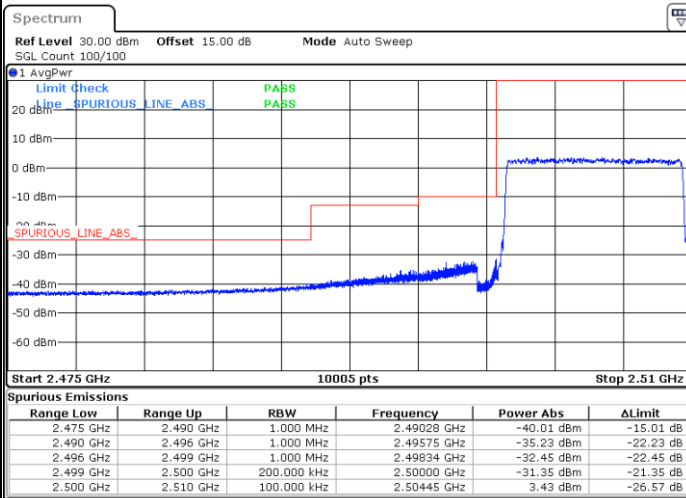

Date: 20.MAR.2024 00:16:46

Highest Band Edge / Full RB

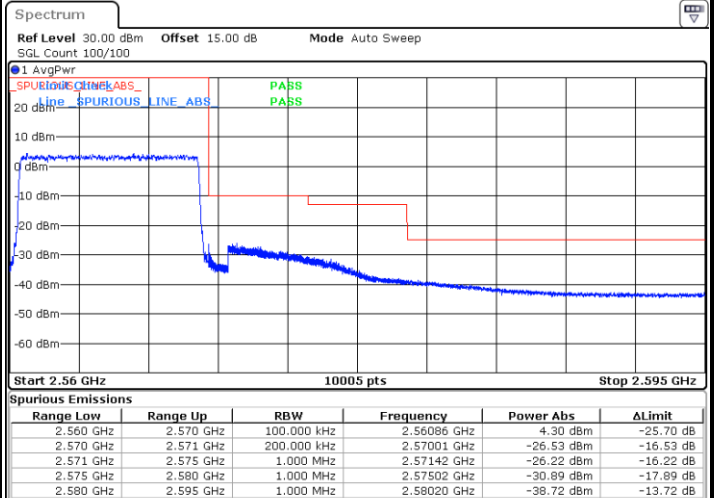

Date: 20.MAR.2024 00:25:38



LTE Band 7 / 10MHz / 64QAM

Lowest Band Edge / 1RB

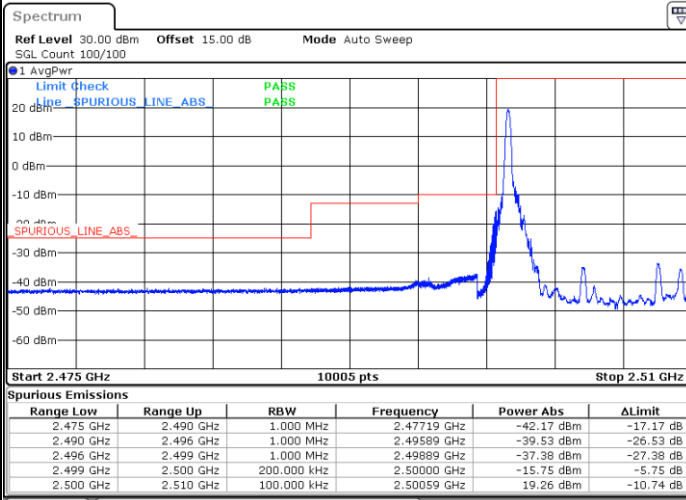

Date: 20.MAR.2024 00:15:04

Highest Band Edge / 1 RB

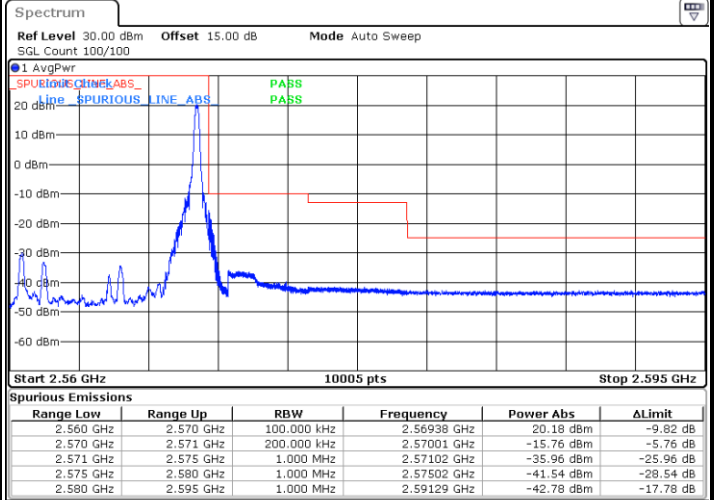

Date: 20.MAR.2024 00:23:54

Lowest Band Edge / Full RB

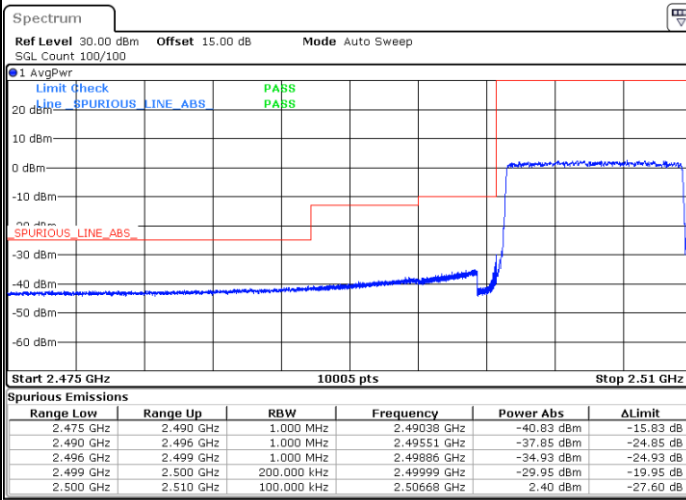

Date: 20.MAR.2024 00:17:38

Highest Band Edge / Full RB

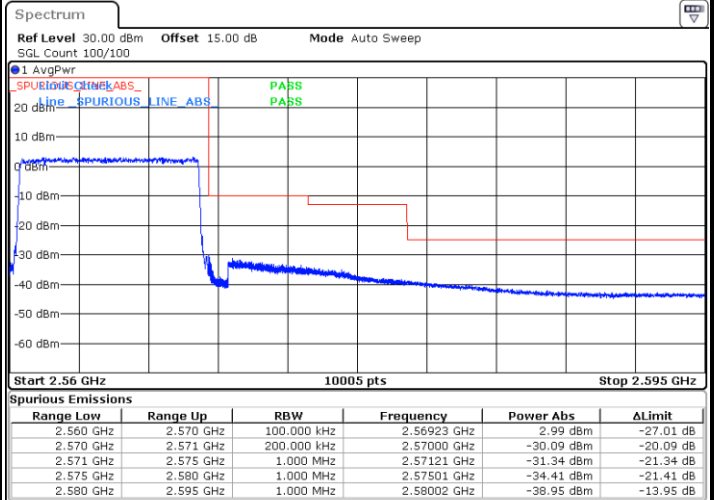

Date: 20.MAR.2024 00:26:29



LTE Band 7 / 15MHz / QPSK

Lowest Band Edge / 1 RB

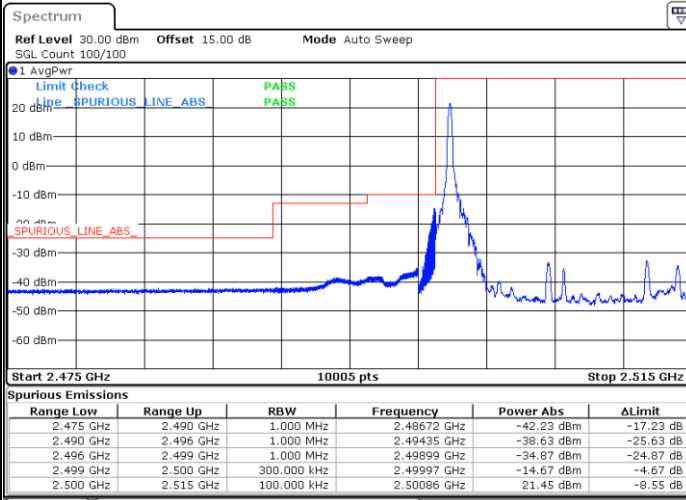

Date: 20.MAR.2024 00:29:20

Highest Band Edge / 1 RB

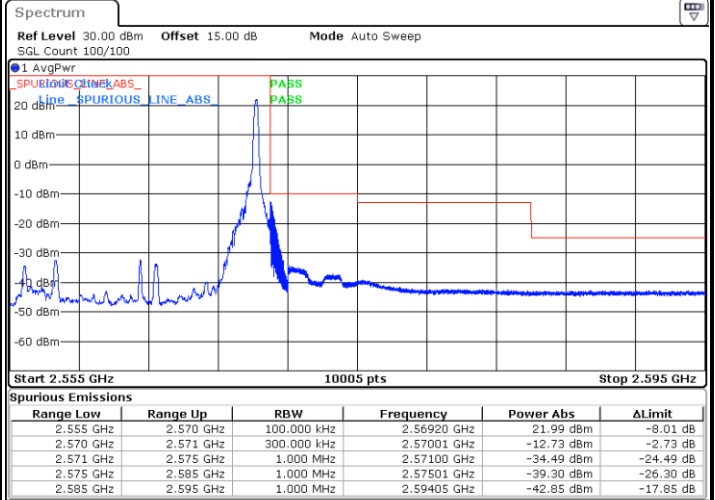

Date: 20.MAR.2024 00:38:12

Lowest Band Edge / Full RB

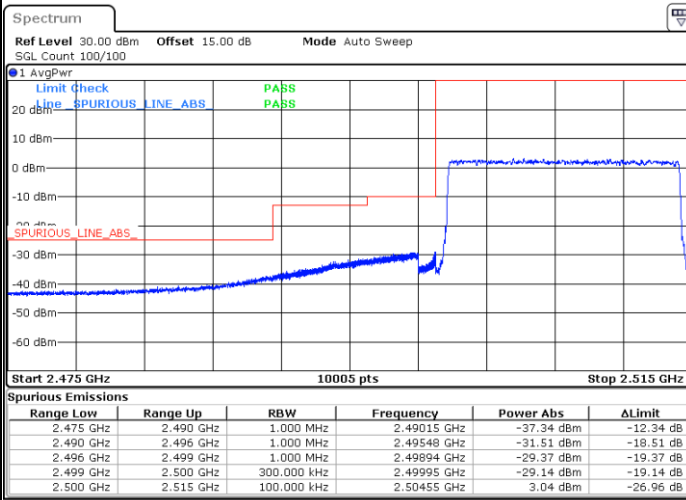

Date: 20.MAR.2024 00:31:55

Highest Band Edge / Full RB

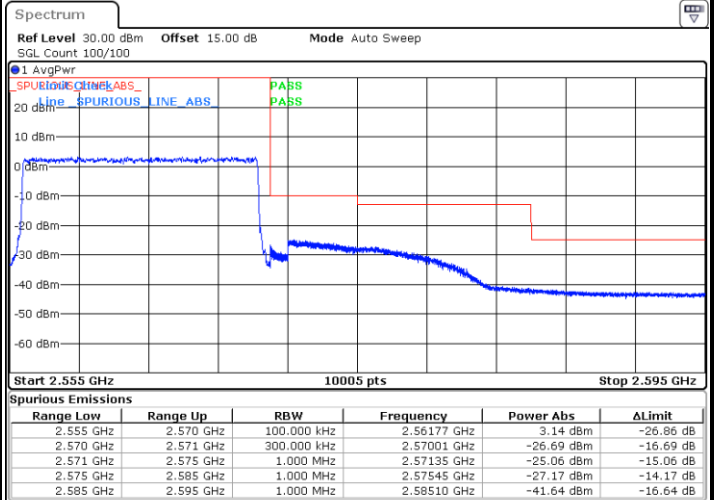

Date: 20.MAR.2024 00:40:46



LTE Band 7 / 15MHz / 16QAM

Lowest Band Edge / 1RB

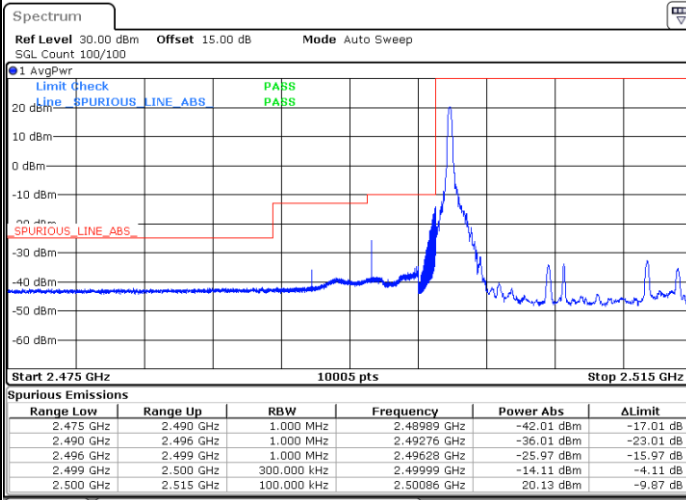

Date: 20.MAR.2024 00:30:12

Highest Band Edge / 1 RB

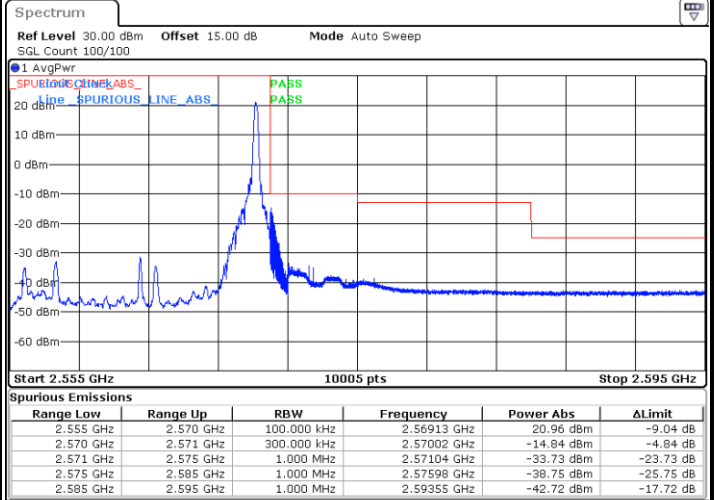

Date: 20.MAR.2024 00:39:03

Lowest Band Edge / Full RB

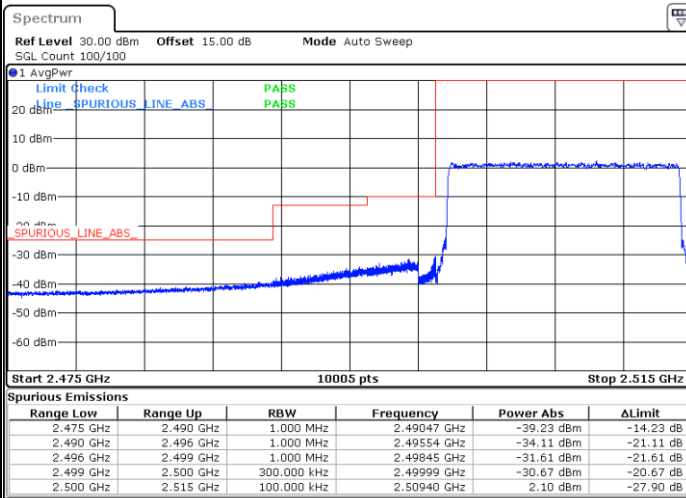

Date: 20.MAR.2024 00:32:47

Highest Band Edge / Full RB

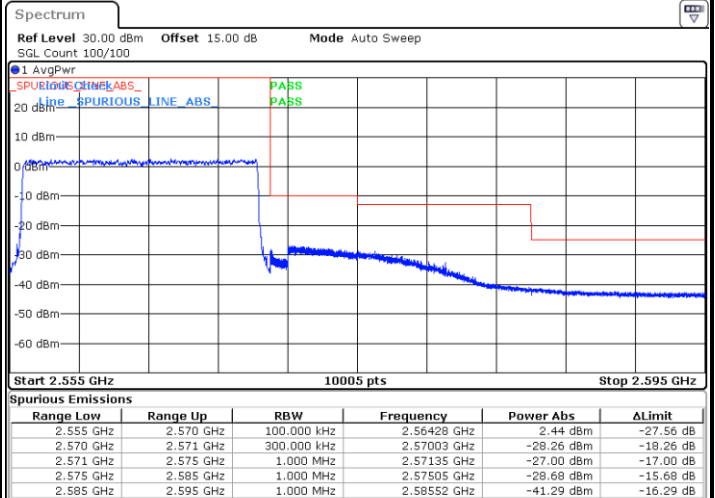

Date: 20.MAR.2024 00:41:36



LTE Band 7 / 15MHz / 64QAM

Lowest Band Edge / 1RB

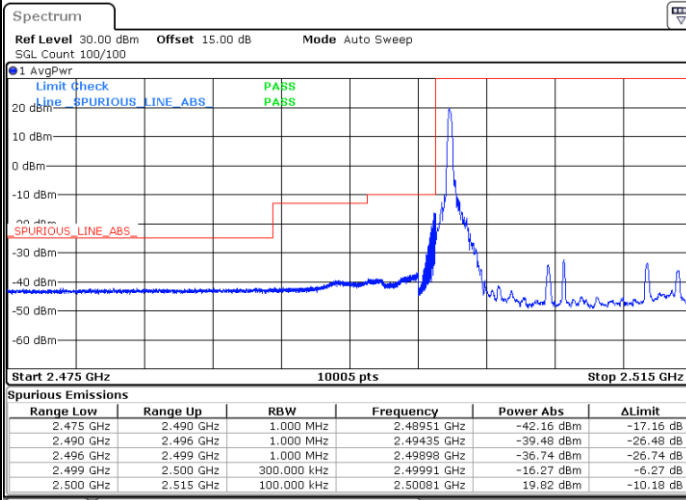

Date: 20.MAR.2024 00:31:03

Highest Band Edge / 1 RB

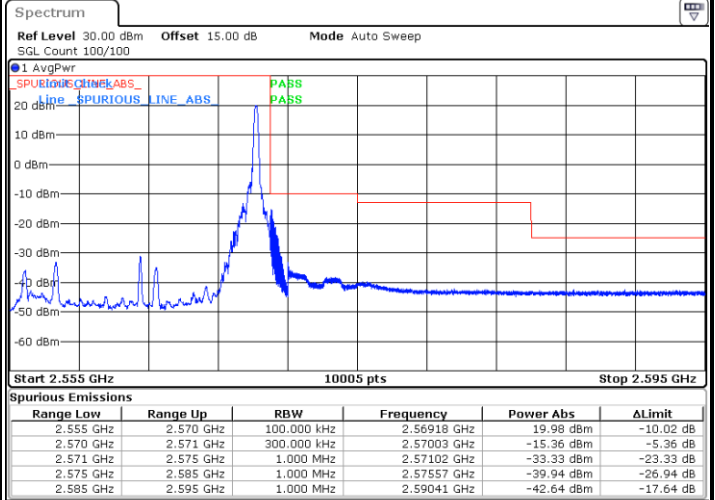

Date: 20.MAR.2024 00:39:55

Lowest Band Edge / Full RB

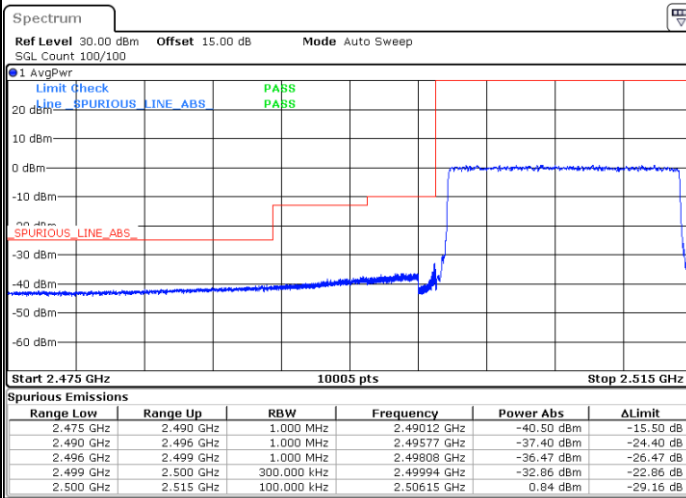

Date: 20.MAR.2024 00:33:39

Highest Band Edge / Full RB

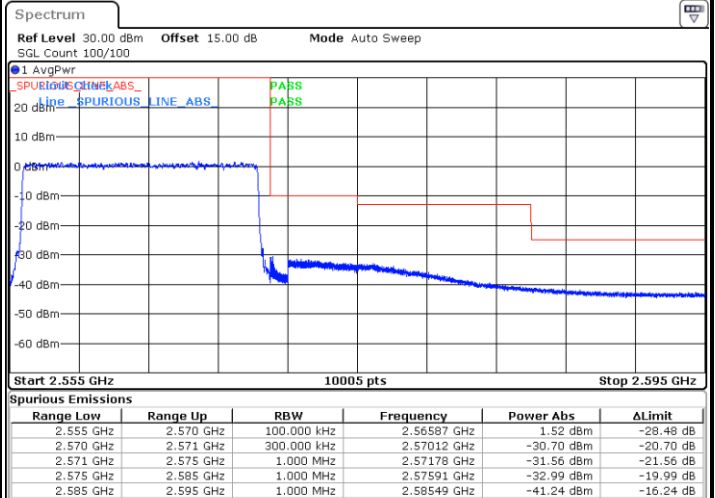

Date: 20.MAR.2024 00:42:27



LTE Band 7 / 20MHz / QPSK

Lowest Band Edge / 1 RB

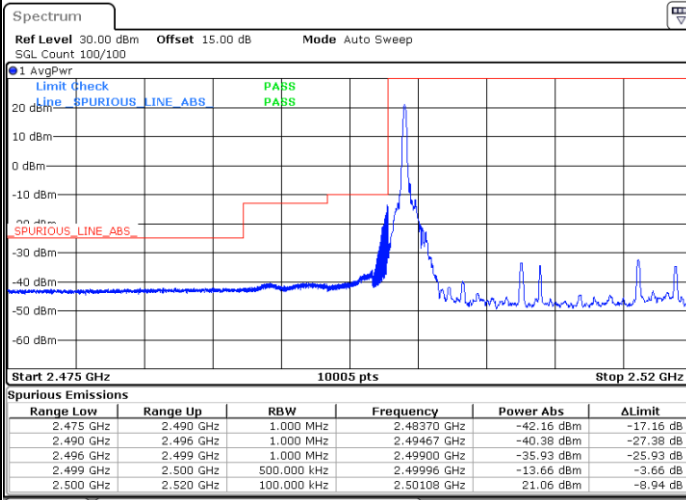

Date: 20.MAR.2024 00:50:44

Highest Band Edge / 1 RB

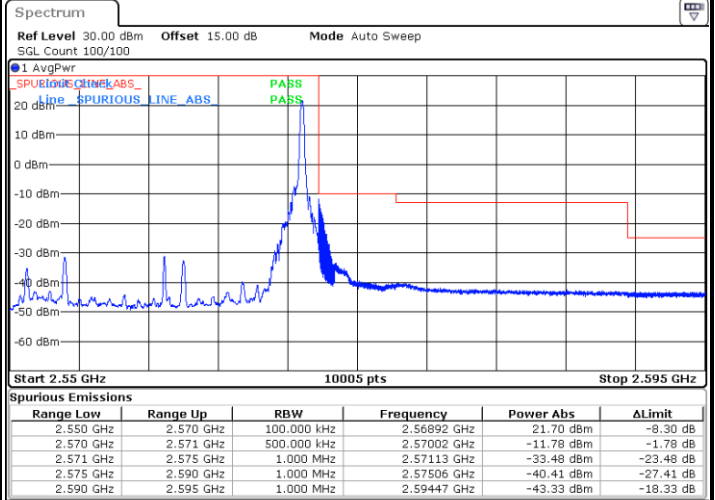

Date: 20.MAR.2024 01:00:58

Lowest Band Edge / Full RB

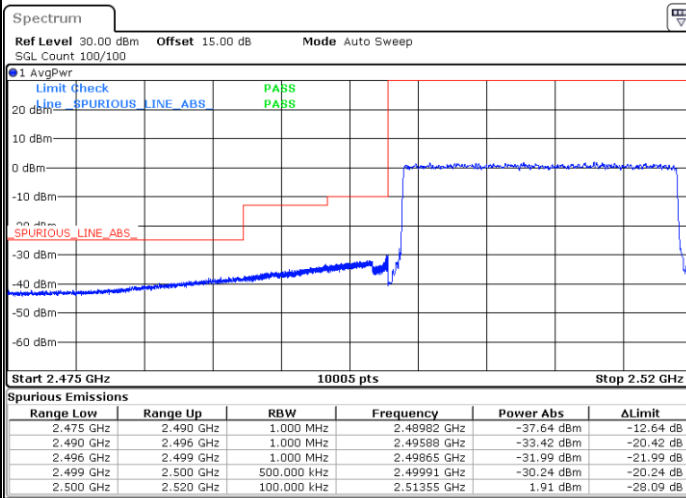

Date: 20.MAR.2024 00:53:19

Highest Band Edge / Full RB

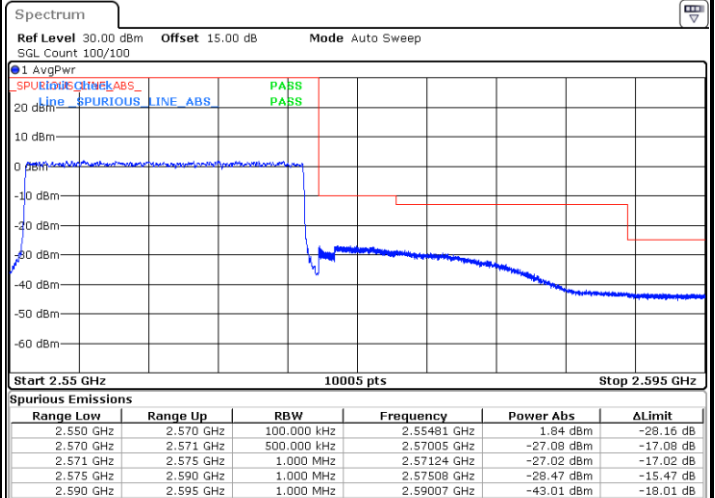

Date: 20.MAR.2024 01:03:34



LTE Band 7 / 20MHz / 16QAM

Lowest Band Edge / 1RB

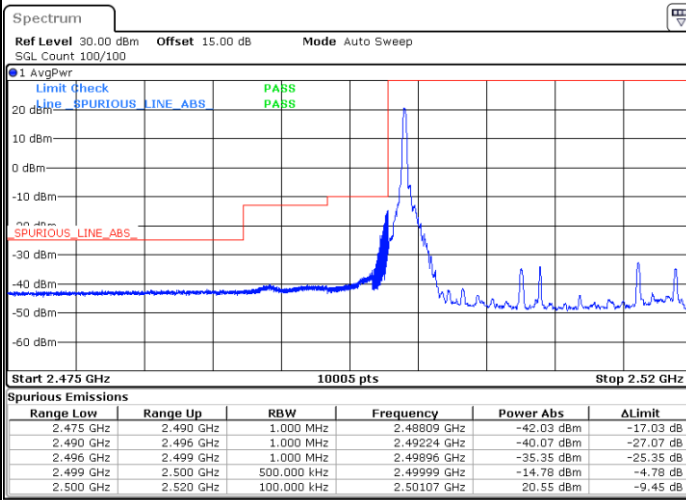

Date: 20.MAR.2024 00:51:36

Highest Band Edge / 1 RB

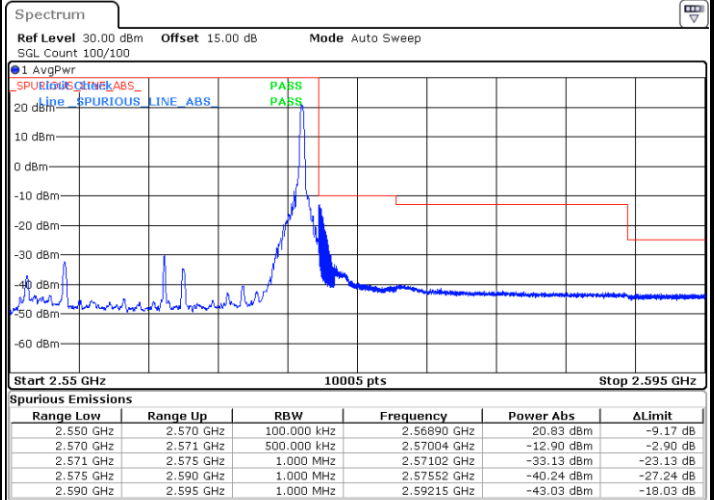

Date: 20.MAR.2024 01:01:50

Lowest Band Edge / Full RB

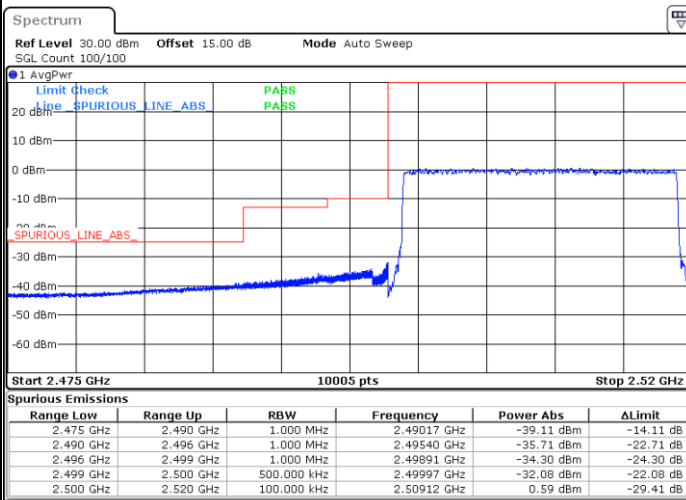

Date: 20.MAR.2024 00:54:11

Highest Band Edge / Full RB

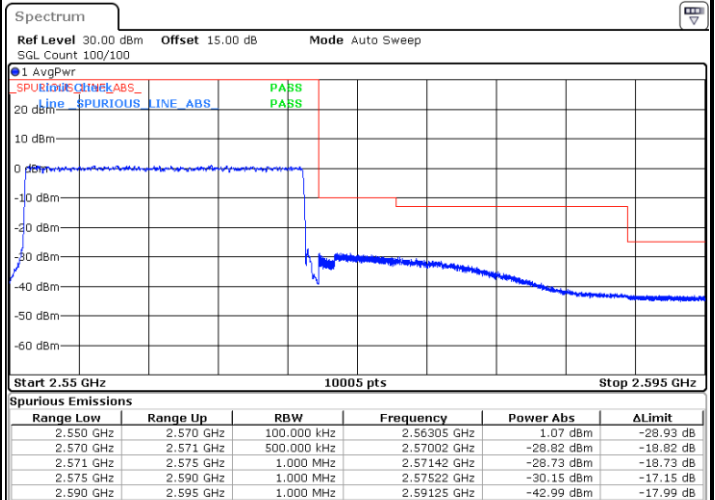

Date: 20.MAR.2024 01:04:25



LTE Band 7 / 20MHz / 64QAM

Lowest Band Edge / 1RB

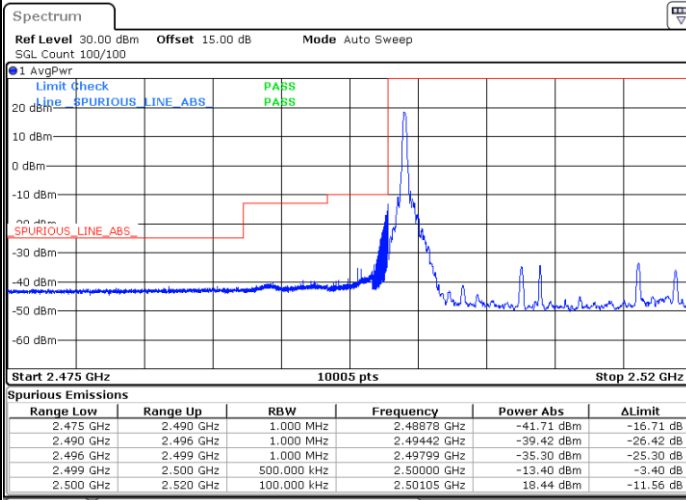

Date: 20.MAR.2024 00:52:27

Highest Band Edge / 1 RB

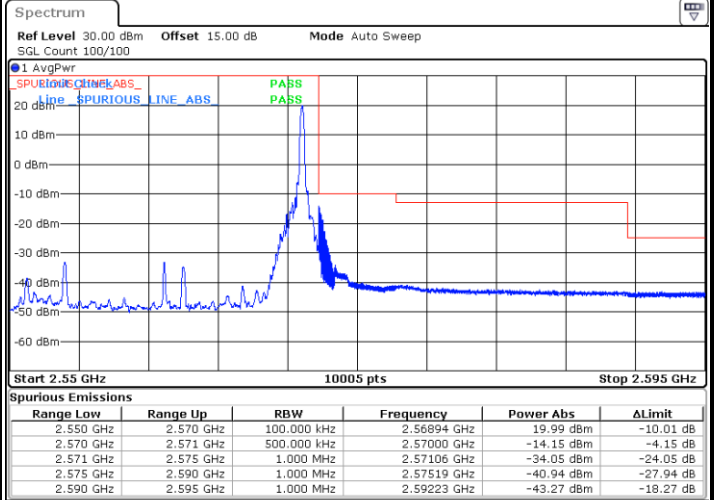

Date: 20.MAR.2024 01:02:42

Lowest Band Edge / Full RB

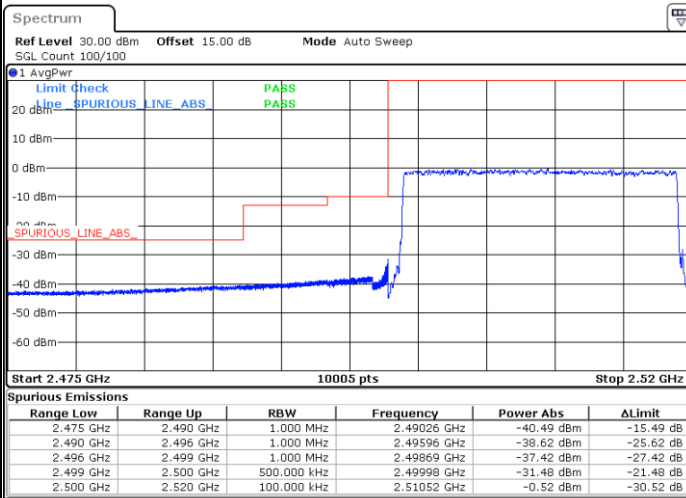

Date: 20.MAR.2024 00:55:03

Highest Band Edge / Full RB

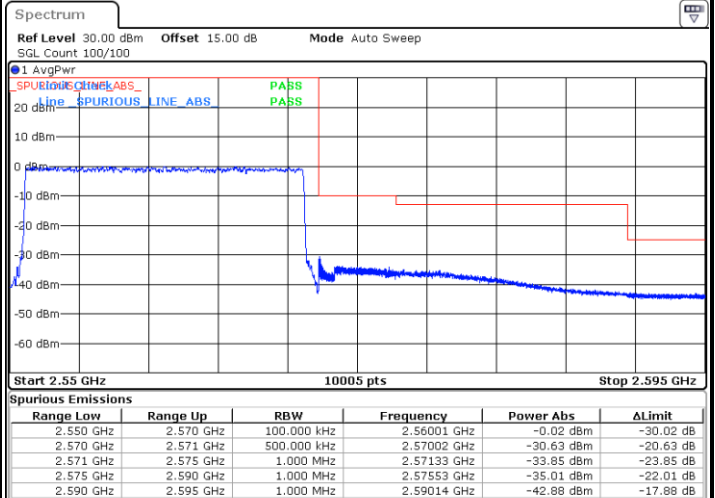

Date: 20.MAR.2024 01:05:17



Conducted Spurious Emission

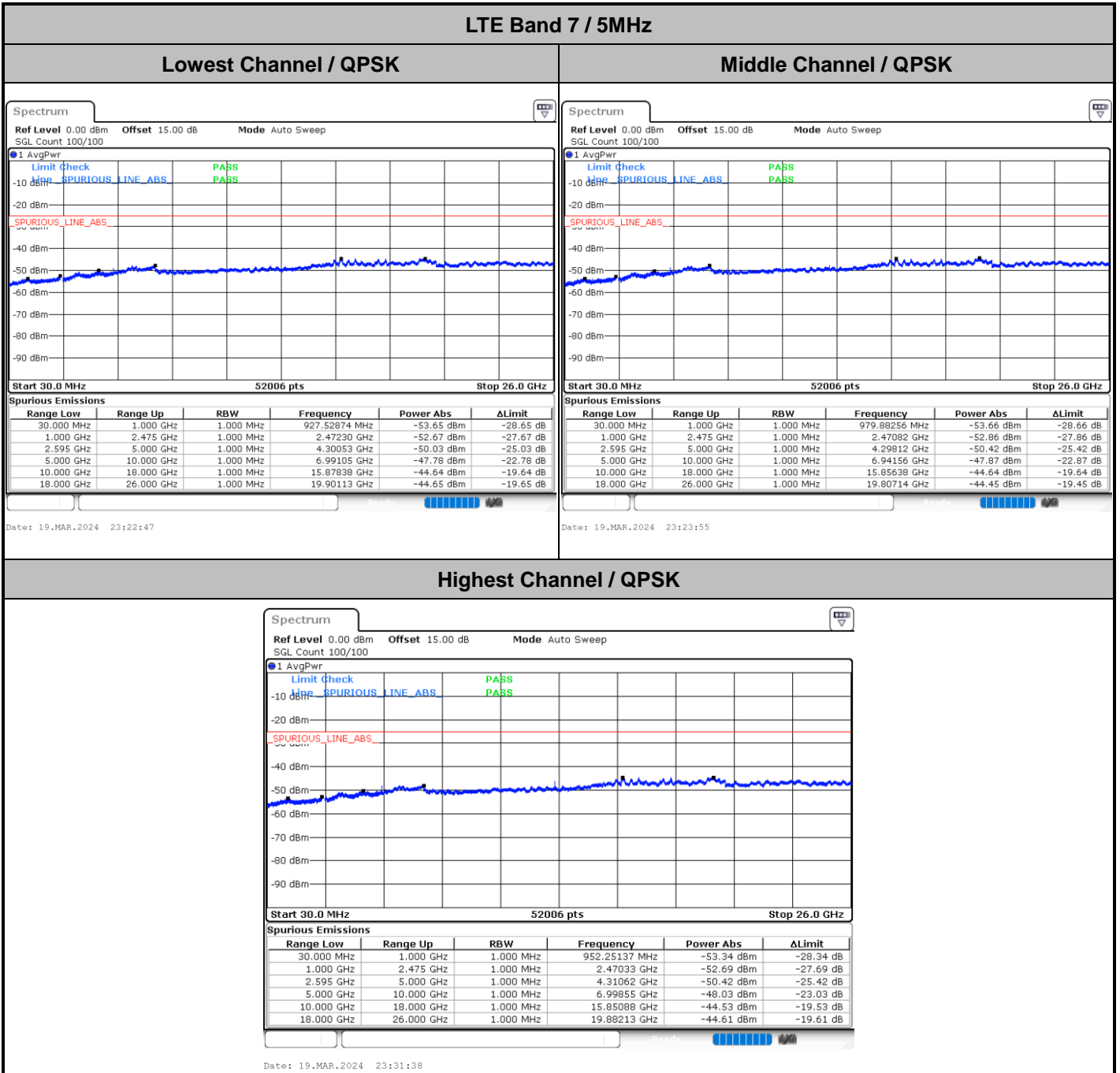



LTE Band 7 / 10MHz

Lowest Channel / QPSK

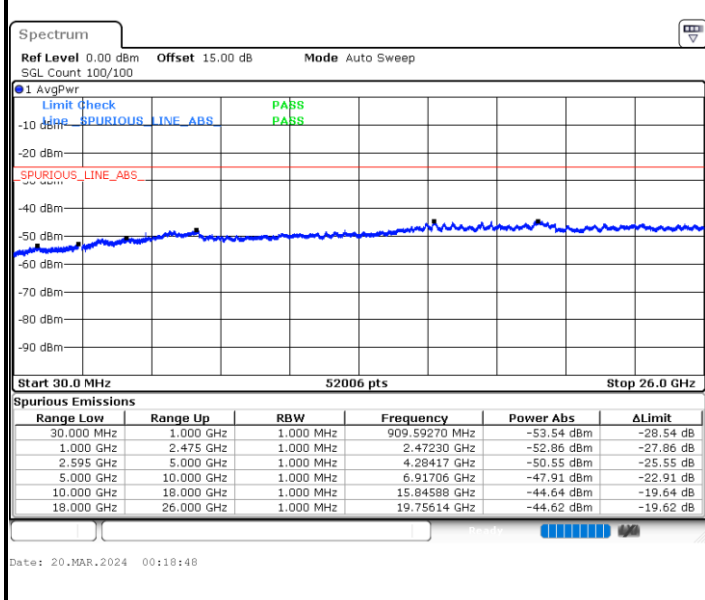

Middle Channel / QPSK

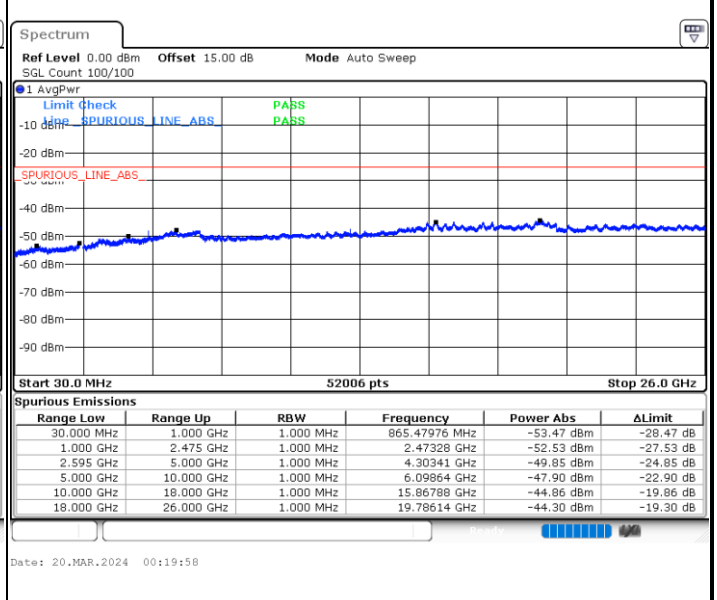

Highest Channel / QPSK

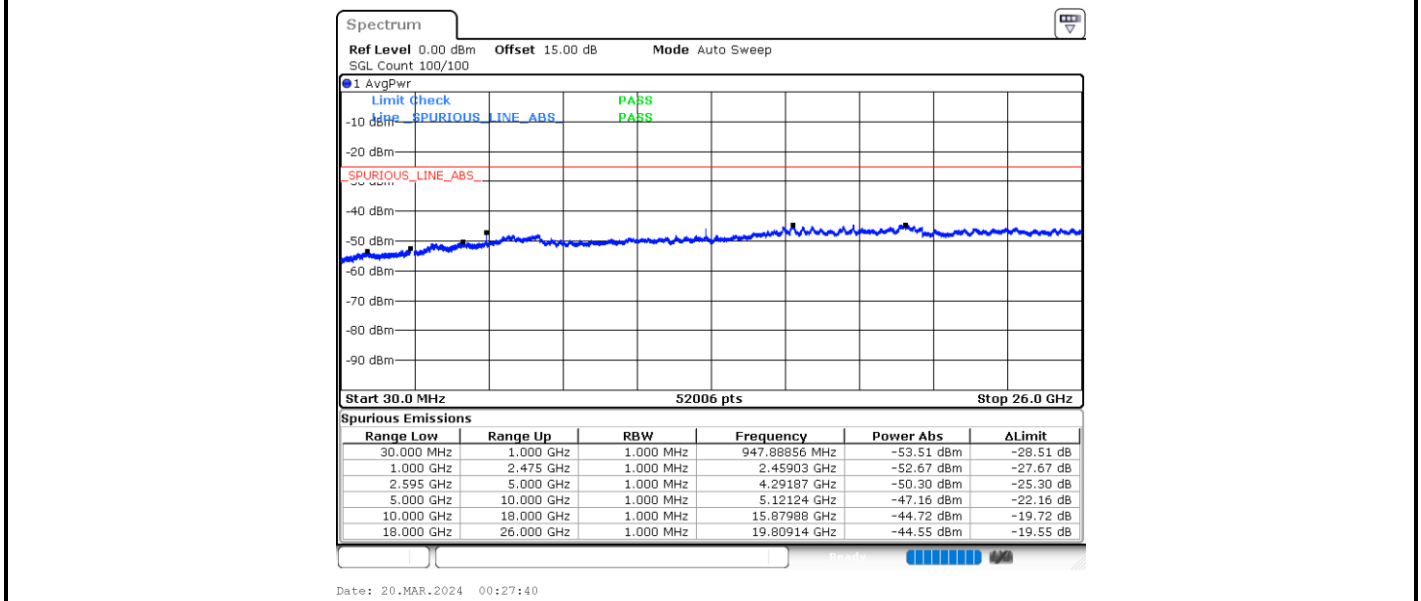



LTE Band 7 / 15MHz

Lowest Channel / QPSK

Middle Channel / QPSK

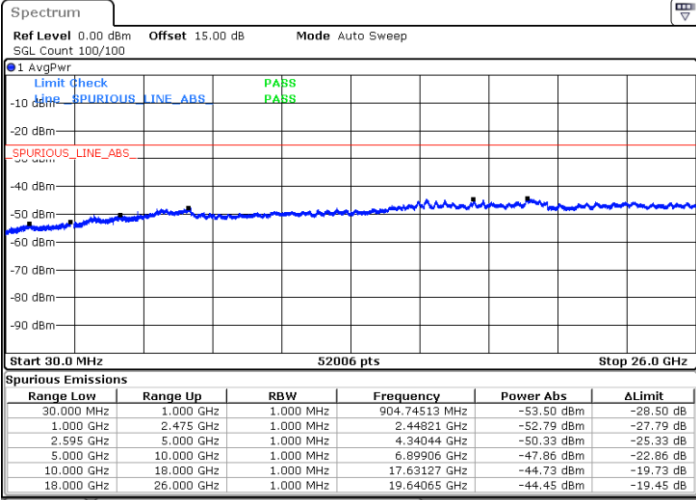

Date: 20.MAR.2024 00:34:50

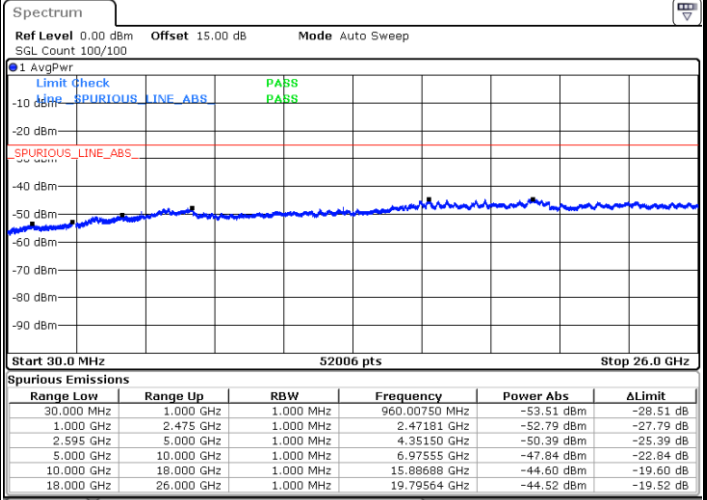

Date: 20.MAR.2024 00:35:59

Highest Channel / QPSK

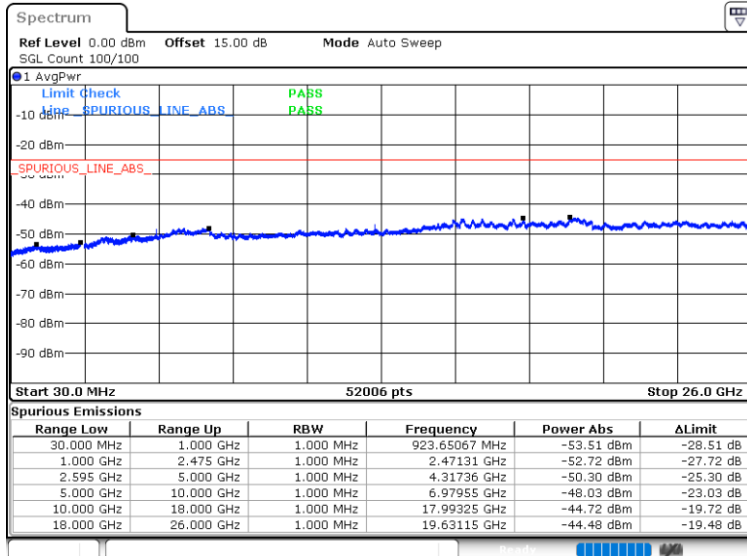

Date: 20.MAR.2024 00:43:37



LTE Band 7 / 20MHz

Lowest Channel / QPSK

Middle Channel / QPSK

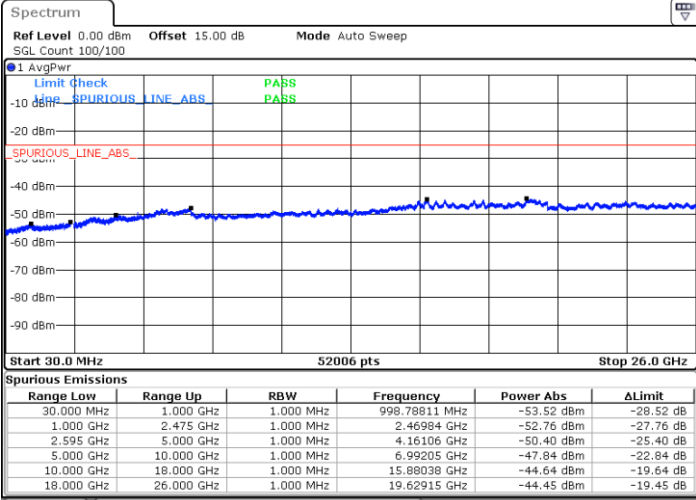

Date: 20.MAR.2024 00:56:13

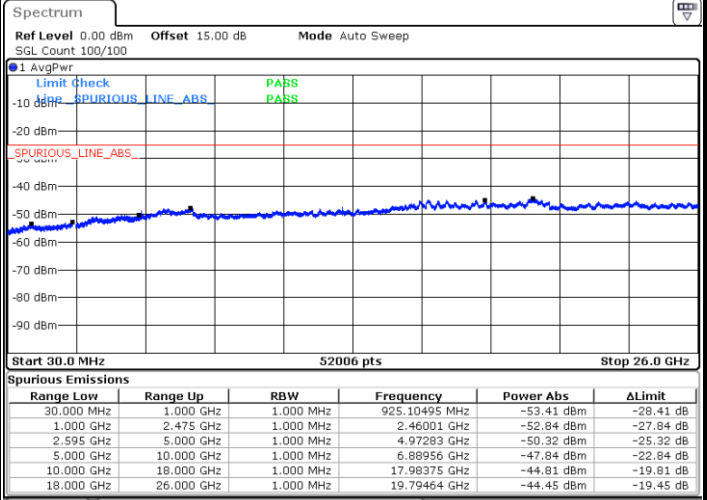

Date: 20.MAR.2024 00:57:23

Highest Channel / QPSK

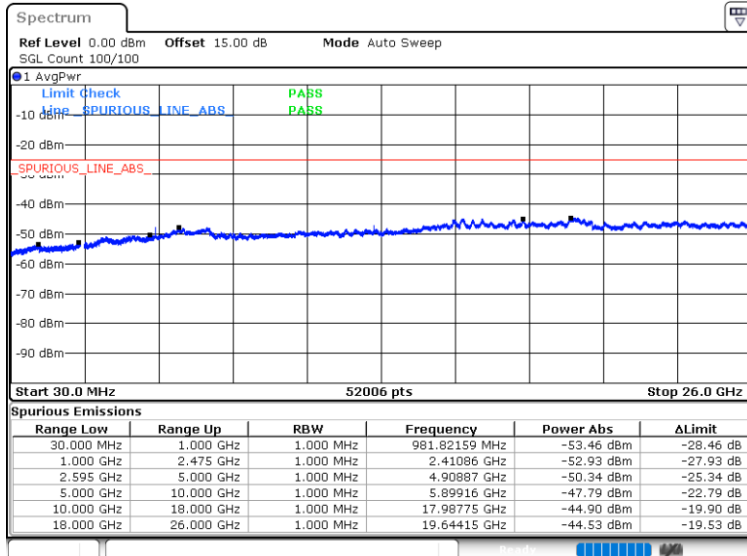

Date: 20.MAR.2024 01:06:27



Frequency Stability

Test Conditions		LTE Band 7 (QPSK) / Middle Channel	Limit
Temperature (°C)	Voltage (Volt)	BW 10MHz	Note 2.
		Deviation (ppm)	Result
50	Normal Voltage	0.0002	PASS
40	Normal Voltage	0.0001	
30	Normal Voltage	0.0001	
20(Ref.)	Normal Voltage	0.0000	
10	Normal Voltage	0.0004	
0	Normal Voltage	0.0004	
-10	Normal Voltage	0.0007	
-20	Normal Voltage	0.0009	
-30	Normal Voltage	0.0007	
20	Maximum Voltage	0.0004	
20	Normal Voltage	0.0000	
20	Battery End Point	0.0005	

Note:

1. Normal Voltage = 3.85 V. ; Battery End Point (BEP) = 3.6 V. ; Maximum Voltage = 4.4 V.
2. The frequency fundamental emissions stay within the authorized frequency block.



LTE Band 12

Peak-to-Average Ratio

Mode	LTE Band 12 / 10MHz			
Mod.	QPSK	16QAM	64QAM	Limit: 13dB
RB Size	Full RB	Full RB	Full RB	Result
Middle CH	4.72	5.77	6.06	PASS



LTE Band 12 / 10MHz / QPSK

Middle Channel / Full RB

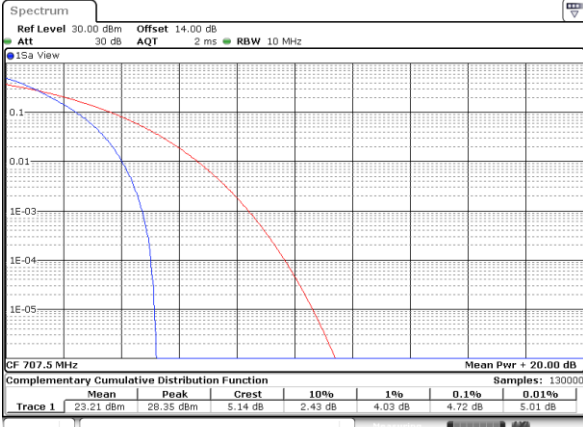

Date: 19_MAR_2024 23:13:30

LTE Band 12 / 10MHz / 16QAM

Middle Channel / Full RB

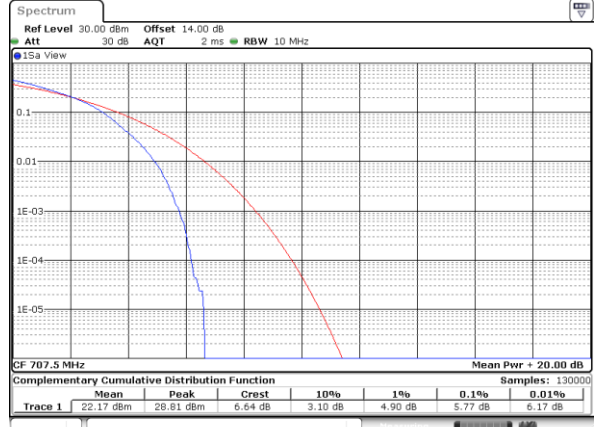

Date: 19_MAR_2024 23:13:58

LTE Band 12 / 10MHz / 64QAM

Middle Channel / Full RB

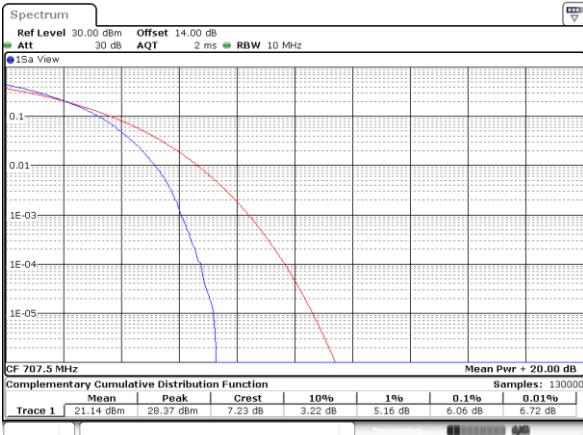

Date: 19_MAR_2024 23:14:26



26dB Bandwidth

Mode	LTE Band 12 : 26dB BW(MHz)							
	1.4MHz		3MHz		5MHz		10MHz	
BW								
Mod.	QPSK	16QAM	QPSK	16QAM	QPSK	16QAM	QPSK	16QAM
Middle CH	1.28	1.30	3.02	2.96	4.87	4.85	9.79	9.71



LTE Band 12

Middle Channel / 1.4MHz / QPSK

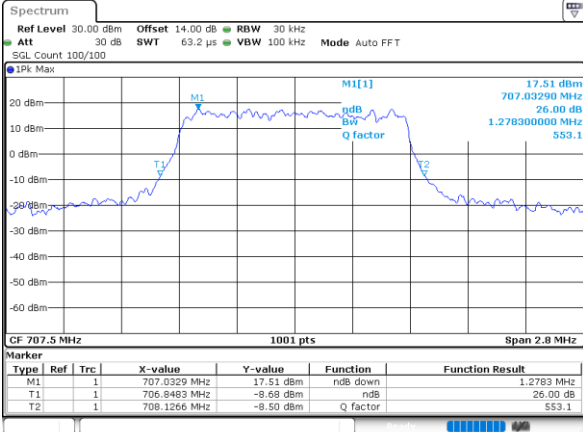

Date: 19_MAR.2024 21:14:26

Middle Channel / 1.4MHz / 16QAM

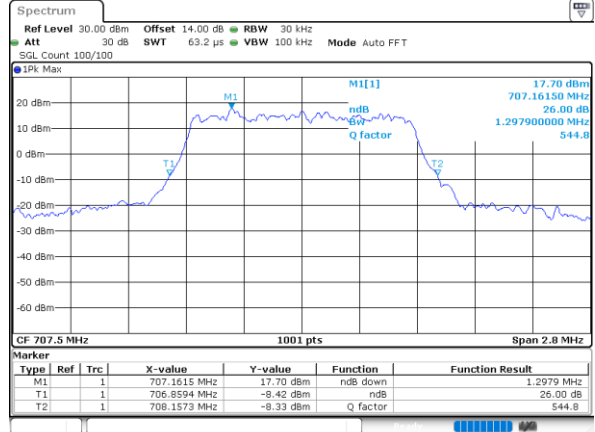

Date: 19_MAR.2024 21:15:06

Middle Channel / 3MHz / QPSK

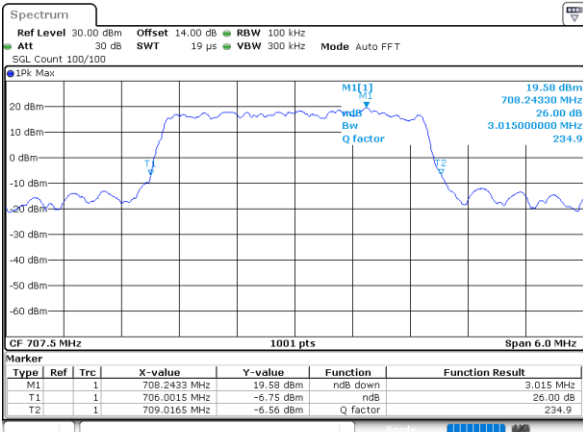

Date: 19_MAR.2024 21:33:00

Middle Channel / 3MHz / 16QAM

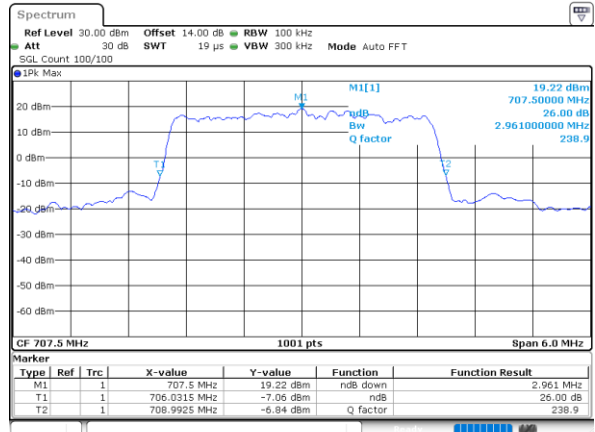

Date: 19_MAR.2024 21:33:40

Middle Channel / 5MHz / QPSK

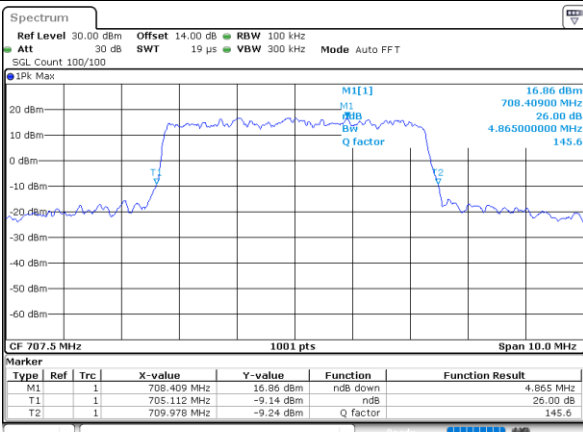

Date: 19_MAR.2024 21:51:30

Middle Channel / 5MHz / 16QAM

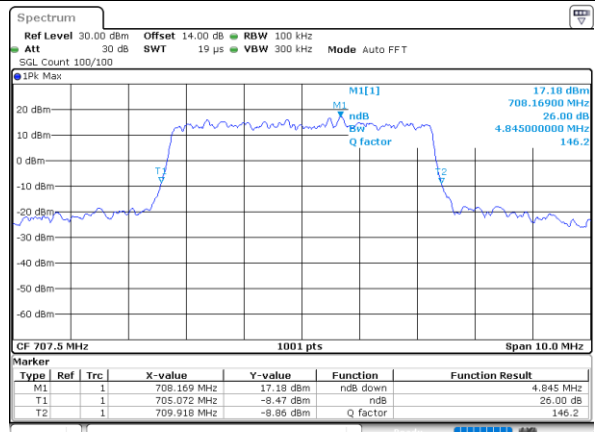

Date: 19_MAR.2024 21:52:10



LTE Band 12

Middle Channel / 10MHz / QPSK

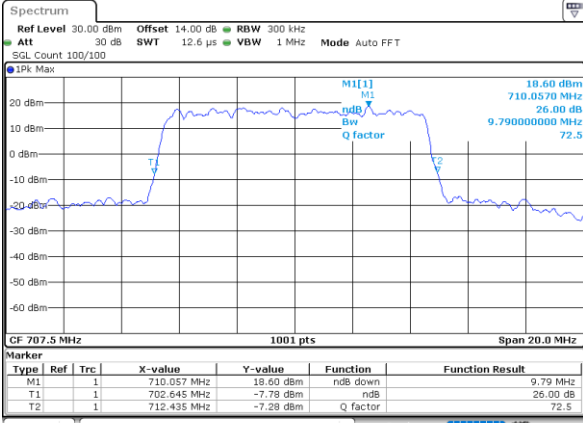

Date: 19_MAR_2024 22:38:29

Middle Channel / 10MHz / 16QAM

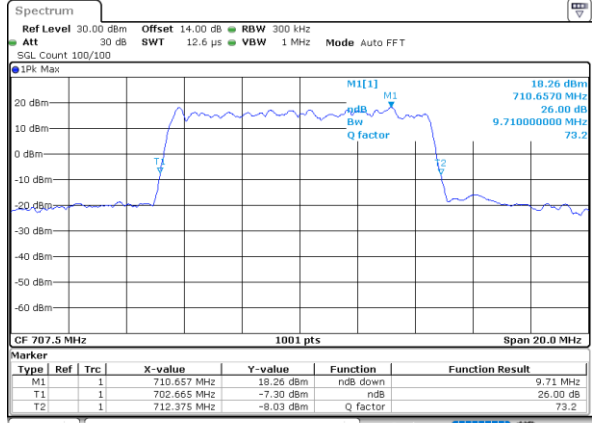

Date: 19_MAR_2024 22:39:14



Occupied Bandwidth

Mode	LTE Band 12 : 99%OBW(MHz)							
	1.4MHz		3MHz		5MHz		10MHz	
BW								
Mod.	QPSK	16QAM	QPSK	16QAM	QPSK	16QAM	QPSK	16QAM
Middle CH	1.09	1.09	2.72	2.72	4.49	4.52	9.07	9.01