



FCC RF Test Report

APPLICANT : TCL Communication Ltd.
EQUIPMENT : GSM/UMTS/LTE/NR Mobile phone
BRAND NAME : TCL
MODEL NAME : T803E
FCC ID : 2AC CJH183
STANDARD : 47 CFR Part 2, 22, 24, 27
CLASSIFICATION : PCS Licensed Transmitter Held to Ear (PCE)
TEST DATE(S) : Mar. 14, 2024 ~ Apr. 03, 2024

We, Sporton International Inc. (ShenZhen), would like to declare that the tested sample has been evaluated in accordance with the procedures given in ANSI C63.26-2015 and shown compliance with the applicable technical standards.

The test results in this report apply exclusively to the tested model / sample. Without written approval of Sporton International Inc. (ShenZhen), the test report shall not be reproduced except in full.

Jason Jia



Approved by: Jason Jia

Sporton International Inc. (ShenZhen)

1/F, 2/F, Bldg 5, Shiling Industrial Zone, Xinwei Village, Xili, Nanshan, Shenzhen, 518055

People's Republic of China



TABLE OF CONTENTS

REVISION HISTORY... 3
SUMMARY OF TEST RESULT ... 4
1 GENERAL DESCRIPTION ... 5
1.1 Applicant ... 5
1.2 Manufacturer ... 5
1.3 Product Feature of Equipment Under Test ... 5
1.4 Product Specification of Equipment Under Test ... 5
1.5 Modification of EUT ... 6
1.6 Maximum ERP/EIRP and Emission Designator ... 6
1.7 Testing Location ... 8
1.8 Test Software ... 8
1.9 Applicable Standards ... 8
2 TEST CONFIGURATION OF EQUIPMENT UNDER TEST ... 9
2.1 Test Mode ... 9
2.2 Connection Diagram of Test System ... 11
2.3 Support Unit used in test configuration and system ... 11
2.4 Measurement Results Explanation Example ... 12
2.5 Frequency List of Low/Middle/High Channels ... 12
3 CONDUCTED TEST ITEMS ... 15
3.1 Measuring Instruments ... 15
3.2 Test Setup ... 15
3.3 Test Result of Conducted Test ... 15
3.4 Conducted Output Power and ERP/EIRP ... 16
3.5 Peak-to-Average Ratio ... 17
3.6 Occupied Bandwidth ... 18
3.7 Conducted Band Edge ... 19
3.8 Conducted Spurious Emission ... 21
3.9 Frequency Stability ... 22
4 RADIATED TEST ITEMS ... 23
4.1 Measuring Instruments ... 23
4.2 Test Setup ... 23
4.3 Test Result of Radiated Test ... 24
4.4 Radiated Spurious Emission ... 25
5 LIST OF MEASURING EQUIPMENT ... 26
6 MEASUREMENT UNCERTAINTY ... 27
APPENDIX A. TEST RESULTS OF CONDUCTED TEST
APPENDIX B. TEST RESULTS OF RADIATED TEST
APPENDIX C. TEST SETUP PHOTOGRAPHS



SUMMARY OF TEST RESULT

Report Section	FCC Rule	Description	Limit	Result	Remark
3.4	§2.1046	Conducted Output Power	Reporting Only	PASS	-
	§22.913(a)(5)	Effective Radiated Power (5G NR n5)	ERP < 7 Watt		
	§24.232(c) §27.50(h)(2)	Equivalent Isotropic Radiated Power (5G NR n2) (5G NR n7)	EIRP < 2Watt		
	§27.50(d)(4)	Equivalent Isotropic Radiated Power (5G NR n66)	EIRP < 1Watt		
3.5	§24.232(d)	Peak-to-Average Ratio	<13 dB	PASS	-
3.6	§2.1049	Occupied Bandwidth	Reporting Only	PASS	-
3.7	§2.1051 §22.917(a) §24.238(a) §27.53(h)	Conducted Band Edge Measurement (5G NR n5) (5G NR n2) (5G NR n66)	< 43+10log10(P[Watts])	PASS	-
	§27.53(m)(4)	Conducted Band Edge Measurement (5G NR n7)	§27.53(m)(4)	PASS	-
3.8	§2.1051 §22.917(a) §24.238(a) §27.53(h)	Conducted Spurious Emission (5G NR n5) (5G NR n2) (5G NR n66)	< 43+10log10(P[Watts])	PASS	-
	§2.1051 §27.53(m)(4)	Conducted Spurious Emission (5G NR n7)	< 55+10log ₁₀ (P[Watts])		
3.9	§2.1055 §22.355	Frequency Stability Temperature & Voltage	< 2.5 ppm for Part 22	PASS	-
	§24.235 §27.54		Within Authorized Band		
4.4	§2.1053 §22.917(a) §24.238(a) §27.53(h)	Radiated Spurious Emission (5G NR n5) (5G NR n2) (5G NR n66)	< 43+10log ₁₀ (P[Watts])	PASS	Under limit 23.69 dB at 10122.36 MHz
	§2.1053 §27.53(m)(4)	Radiated Spurious Emission (5G NR n7)	< 55+10log ₁₀ (P[Watts])		

Conformity Assessment Condition:

- The test results (PASS/FAIL) with all measurement uncertainty excluded are presented against the regulation limits or in accordance with the requirements stipulated by the applicant/manufacturer who shall bear all the risks of non-compliance that may potentially occur if measurement uncertainty is taken into account.
- The measurement uncertainty please refer to each test result in the section "Measurement Uncertainty"

Disclaimer:

The product specifications of the EUT presented in the test report that may affect the test assessments are declared by the manufacturer who shall take full responsibility for the authenticity.



1 General Description

1.1 Applicant

TCL Communication Ltd.

5/F, Building 22E, 22 Science Park East Avenue, Hong Kong Science Park, Shatin, NT, Hong Kong

1.2 Manufacturer

TCL Communication Ltd.

5/F, Building 22E, 22 Science Park East Avenue, Hong Kong Science Park, Shatin, NT, Hong Kong

1.3 Product Feature of Equipment Under Test

Product Feature	
Equipment	GSM/UMTS/LTE/NR Mobile phone
Brand Name	TCL
Model Name	T803E
FCC ID	2ACCJH183
IMEI Code/SN	Conducted : YTDMEIJZFYYTTOWK Radiation : 353318350121876/353318350121884
HW Version	05
SW Version	AGS7
EUT Stage	Identical Prototype

1.4 Product Specification of Equipment Under Test

Standards-related Product Specification	
Tx Frequency	5G NR n2 : 1850 MHz ~ 1910 MHz 5G NR n5 : 824 MHz ~ 849 MHz 5G NR n7 : 2500 MHz ~ 2570 MHz 5G NR n66 : 1710 MHz ~ 1780 MHz
Rx Frequency	5G NR n2 : 1930 MHz ~ 1990 MHz 5G NR n5 : 869 MHz ~ 894 MHz 5G NR n7 : 2620 MHz ~ 2690 MHz 5G NR n66 : 2110 MHz~ 2200 MHz
Bandwidth	n2 : 5MHz / 10MHz / 15MHz / 20MHz / 25MHz / 30MHz / 35MHz / 40MHz n5 : 5MHz / 10MHz / 15MHz / 20MHz / 25MHz n7 : 5MHz / 10MHz / 15MHz / 20MHz / 25MHz / 30MHz / 35MHz / 40MHz / 50MHz n66 : 5MHz / 10MHz / 15MHz / 20MHz / 25MHz / 30MHz / 35MHz / 40MHz / 45MHz
SCS	15kHz
Antenna Gain	<Ant. 2>: n2 : -1.5 dBi n66 : -1.6 dBi



	<p><Ant. 4>: n7 : -0.1 dBi</p> <p><Ant. 0>: n5 : -4.3 dBi</p>
Type of Modulation	<p>CP-OFDM: QPSK / 16QAM / 64QAM / 256QAM</p> <p>DFT-s-OFDM: PI/2 BPSK / QPSK / 16QAM / 64QAM / 256QAM</p>

Remark:

1. All the supported ENDC combinations are verified conducted power, only the ENDC combination with highest power are shown in the report.
2. 5G NR n2/n5/n66 only support SA mode, and n7 supports NSA mode.
3. The EN-DC mode combination could be referred to the product spec.

1.5 Modification of EUT

No modifications are made to the EUT during all test items.

1.6 Maximum ERP/EIRP and Emission Designator

5G NR n2		PI/2 BPSK / QPSK		16QAM / 64QAM / 256QAM	
BW (MHz)	Frequency Range (MHz)	Maximum EIRP(W)	Emission Designator (99%OBW)	Maximum EIRP(W)	Emission Designator (99%OBW)
5	1852.5 ~ 1907.5	0.1932	4M46G7D	0.1483	4M49W7D
10	1855.0 ~ 1905.0	0.1897	9M28G7D	0.1483	9M28W7D
15	1857.5 ~ 1902.5	0.1795	14M1G7D	0.1452	14M1W7D
20	1860.0 ~ 1900.0	0.1766	18M9G7D	0.1439	18M9W7D
25	1862.5 ~ 1897.5	0.1766	23M8G7D	0.1416	23M8W7D
30	1865.0 ~ 1895.0	0.1770	28M6G7D	0.1435	28M6W7D
35	1867.5 ~ 1892.5	0.1730	33M5G7D	0.1365	33M5W7D
40	1870.0 ~ 1890.0	0.1936	38M6G7D	0.1570	38M6W7D



5G NR n5		PI/2 BPSK / QPSK		16QAM / 64QAM / 256QAM	
BW (MHz)	Frequency Range (MHz)	Maximum ERP(W)	Emission Designator (99%OBW)	Maximum ERP(W)	Emission Designator (99%OBW)
5	826.5 ~ 846.5	0.0590	4M47G7D	0.0452	4M49W7D
10	829.0 ~ 844.0	0.0586	9M30G7D	0.0447	9M30W7D
15	831.5 ~ 841.5	0.0574	14M1G7D	0.0448	14M2W7D
20	834.0 ~ 839.0	0.0585	18M9G7D	0.0439	19M0W7D
25	836.5	0.0592	23M8G7D	0.0447	23M8W7D

5G NR n66		PI/2 BPSK / QPSK		16QAM / 64QAM / 256QAM	
BW (MHz)	Frequency Range (MHz)	Maximum EIRP(W)	Emission Designator (99%OBW)	Maximum EIRP(W)	Emission Designator (99%OBW)
5	1712.5 ~ 1777.5	0.1824	4M46G7D	0.1455	4M48W7D
10	1715.0 ~ 1775.0	0.1849	9M28G7D	0.1459	9M28W7D
15	1717.5 ~ 1772.5	0.1791	14M1G7D	0.1422	14M1W7D
20	1720.0 ~ 1770.0	0.1754	18M9G7D	0.1422	18M9W7D
25	1722.5 ~ 1767.5	0.1766	23M7G7D	0.1429	23M8W7D
30	1725.0 ~ 1765.0	0.1774	28M6G7D	0.1422	28M6W7D
35	1727.5 ~ 1762.5	0.1738	33M5G7D	0.1406	33M6W7D
40	1730.0 ~ 1760.0	0.1754	38M5G7D	0.1387	38M6W7D
45	1732.5 ~ 1757.5	0.1854	43M2G7D	0.1439	43M2W7D

EN DC_7A-n7A		PI/2 BPSK / QPSK		16QAM / 64QAM / 256QAM	
BW (MHz)	Frequency Range (MHz)	Maximum EIRP(W)	Emission Designator (99%OBW)	Maximum EIRP(W)	Emission Designator (99%OBW)
5	2502.5 ~ 2567.5	0.0059	4M46G7D	0.0058	4M48W7D
10	2505.0 ~ 2565.0	0.0060	9M27G7D	0.0060	9M27W7D
15	2507.5 ~ 2562.5	0.0060	14M1G7D	0.0057	14M1W7D
20	2510.0 ~ 2560.0	0.0061	18M9G7D	0.0060	18M9W7D
25	2512.5 ~ 2557.5	0.0059	23M7G7D	0.0058	23M7W7D
30	2515.0 ~ 2555.0	0.0059	28M5G7D	0.0057	28M5W7D
35	2517.5 ~ 2552.5	0.0061	33M4G7D	0.0059	33M4W7D
40	2520.0 ~ 2550.0	0.0060	38M4G7D	0.0058	38M4W7D
50	2525.0 ~ 2545.0	0.0062	48M1G7D	0.0061	48M2W7D

Note: All modulations have been tested, only the worst test results of PSK & QAM are shown in the report.



1.7 Testing Location

Sporton International Inc. (ShenZhen) is accredited to ISO/IEC 17025:2017 by American Association for Laboratory Accreditation with Certificate Number 5145.01.

Test Firm	Sporton International Inc. (ShenZhen)		
Test Site Location	1/F, 2/F, Bldg 5, Shiling Industrial Zone, Xinwei Village, Xili, Nanshan, Shenzhen, 518055 People's Republic of China TEL: +86-755-86379589 FAX: +86-755-86379595		
Test Site No.	Sporton Site No.	FCC Designation No.	FCC Test Firm Registration No.
	TH01-SZ	CN1256	421272

Test Firm	Sporton International Inc. (ShenZhen)		
Test Site Location	101, 1st Floor, Block B, Building 1, No. 2, Tengfeng 4th Road, Fenghuang Community, Fuyong Street, Baoan District, Shenzhen City, Guangdong Province 518103 People's Republic of China TEL: +86-755-86066985		
Test Site No.	Sporton Site No.	FCC Designation No.	FCC Test Firm Registration No.
	03CH01-SZ	CN1256	421272

1.8 Test Software

Item	Site	Manufacture	Name	Version
1.	03CH01-SZ	AUDIX	E3	6.2009-8-24

1.9 Applicable Standards

According to the specifications of the manufacturer, the EUT must comply with the requirements of the following standards:

- ♦ 47 CFR Part 2, 22, 24, 27
- ♦ ANSI C63.26-2015
- ♦ FCC KDB 971168 D01 Power Meas License Digital Systems v03r01
- ♦ FCC KDB 412172 D01 Determining ERP and EIRP v01r01

Remark:

All test items were verified and recorded according to the standards and without any deviation during the test.



2 Test Configuration of Equipment Under Test

2.1 Test Mode

Antenna port conducted and radiated test items are performed according to KDB 971168 D01 Power Meas License Digital Systems v03r01 with maximum output power.

For radiated measurement, pre-scanned in three orthogonal panels, X, Y, Z. The worst cases (X/Y/Z plane) were recorded in this report.

The device is investigated from 30MHz to 10 times of fundamental signal for radiated spurious emission test under different RB size/offset and modulations in exploratory test. Subsequently, only the worst case emissions are reported.

Orthogonal Planes of EUT	X Plane	Y Plane	Z Plane

Test Items	5G NR	Bandwidth (MHz)													Modulation					RB #		Test Channel					
		5	10	15	20	25	30	35	40	45	50	80	90	100	PI/2 BPSK	QPSK	16QAM	64QAM	256QAM	1	Full	L	M	H			
Max. Output Power	n2	v	v	v	v	v	v	v	v	-	-	-	-	-	v	v	v	v	v	v	v	v	v	v	v	v	
	n5	v	v	v	v	v	-	-	-	-	-	-	-	-	v	v	v	v	v	v	v	v	v	v	v	v	v
	n7	v	v	v	v	v	v	v	v	-	v	-	-	-	v	v	v	v	v	v	v	v	v	v	v	v	v
	n66	v	v	v	v	v	v	v	v	v	-	-	-	-	v	v	v	v	v	v	v	v	v	v	v	v	v
Peak-to-Average Ratio	n2				v					-	-	-	-	-	v	v					v			v			
	n5				v		-	-	-	-	-	-	-	-	v	v					v			v			
	n7				v					-		-	-	-	v	v					v			v			
	n66				v						-	-	-	-	v	v					v			v			
26dB and 99% Bandwidth	n2	v	v	v	v	v	v	v	v	-	-	-	-	-		v	v	v	v		v			v			
	n5	v	v	v	v	-	-	-	-	-	-	-	-	-		v	v	v	v		v			v			
	n7	v	v	v	v	v	v	v	v	-	v	-	-	-		v	v	v	v		v			v			
	n66	v	v	v	v	v	v	v	v	v	-	-	-	-		v	v	v	v		v			v			
Conducted Band Edge	n2	v			v				v	-	-	-	-	-	v	v					v	v	v			v	
	n5	v		v		v	-	-	-	-	-	-	-	-	v	v					v	v	v			v	
	n7	v			v					-	v	-	-	-	v	v					v	v	v			v	
	n66	v			v					v	-	-	-	-	v	v					v	v	v			v	
Conducted Spurious Emission	n2	v			v				v	-	-	-	-	-	v	v					v			v	v	v	
	n5	v		v		v	-	-	-	-	-	-	-	-	v	v					v			v	v	v	



Test Items	5G NR	Bandwidth (MHz)												Modulation					RB #		Test Channel			
		5	10	15	20	25	30	35	40	45	50	80	90	100	PI/2 BPSK	QPSK	16QAM	64QAM	256QAM	1	Full	L	M	H
Test Items	n7	v				v				-	v	-	-	-	v	v				v		v	v	v
	n66	v				v				v	-	-	-	-	v	v				v		v	v	v
Frequency Stability	n2				v					-	-	-	-		v					v		v		
	n5				v		-	-	-	-	-	-	-		v							v		
	n7				v					-		-	-	-		v						v		
	n66				v						-	-	-	-		v						v		
E.R.P / E.I.R.P	n2	v	v	v	v	v	v	v	v	-	-	-	-	-	v	v	v	v	v	v	v	v	v	
	n5	v	v	v	v	v	-	-	-	-	-	-	-	-	v	v	v	v	v	v	v	v	v	
	n7	v	v	v	v	v	v	v	v		v	-	-	-	v	v	v	v	v	v	v	v	v	
	n66	v	v	v	v	v	v	v	v	v	-	-	-	-	v	v	v	v	v	v	v	v	v	
Radiated Spurious Emission	n2	Worst Case																				v		
	n5	Worst Case																				v		
	n7	Worst Case																				v		
	n66	Worst Case																				v		
Note	<ol style="list-style-type: none"> The mark "v" means that this configuration is chosen for testing The mark "-" means that this bandwidth is not supported. The device is investigated from 30MHz to 10 times of fundamental signal for radiated spurious emission test under different RB size/offset and modulations in exploratory test. Subsequently, only the worst case emissions are reported. For QAM modulation mode, the whole testing has assessed 16QAM&64QAM mode by referring to the higher conducted power Frequency Stability : Normal Voltage = 3.85V ; Low Voltage =3.60V. ; High Voltage =4.40V 																							

2.2 Connection Diagram of Test System

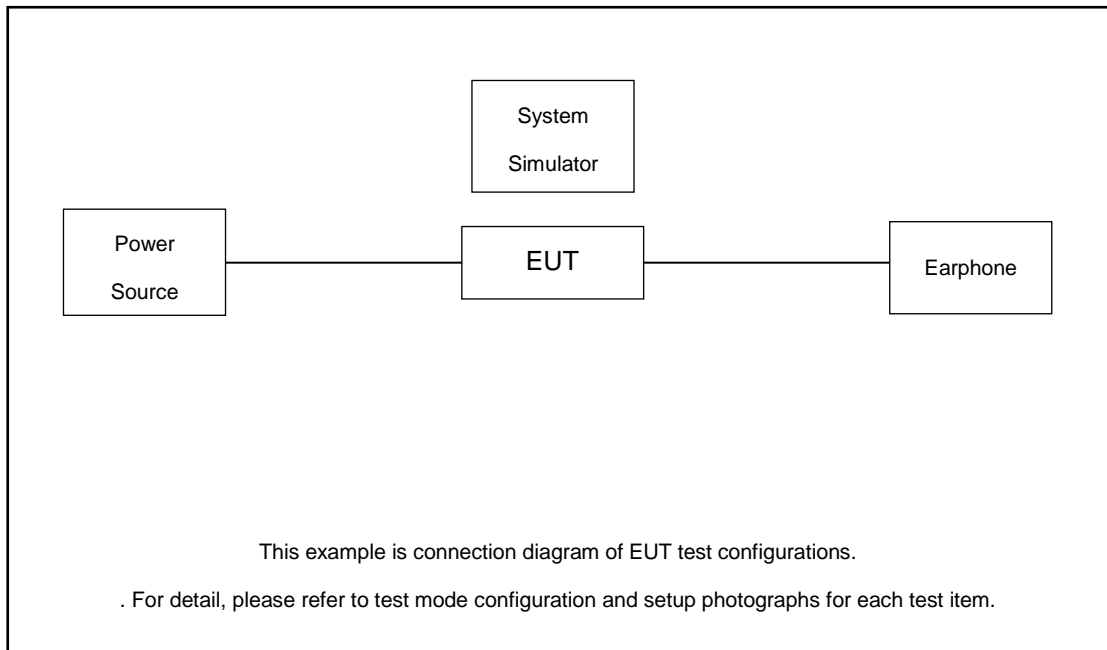

The EUT has been configuration operated in a manner tended to maximize its emission characteristics in a typical application.

2.3 Support Unit used in test configuration and system

Item	Equipment	Trade Name	Model No.	FCC ID	Data Cable	Power Cord
1.	DC Power Supply	GW	GPS-3030D	N/A	N/A	Unshielded, 1.8 m
2.	LTE Base Station	Anritsu	MT8821C	N/A	N/A	Unshielded, 1.8 m
3.	NR Base Station	Anritsu	MT8000A	N/A	N/A	Unshielded, 1.8 m
4.	Earphone	N/A	N/A	N/A	N/A	N/A



2.4 Measurement Results Explanation Example

For all conducted test items:

The offset level is set in the spectrum analyzer to compensate the RF cable loss between EUT conducted output port and spectrum analyzer. With the offset compensation, the spectrum analyzer reading level is exactly the EUT RF output level.

The spectrum analyzer offset is derived from RF cable loss.

$$\text{Offset} = \text{RF cable loss.}$$

Following shows an offset computation example with cable loss 8.0 dB.

Example :

$$\begin{aligned} \text{Offset(dB)} &= \text{RF cable loss(dB)} \\ &= 8.0(\text{dB}) \end{aligned}$$

2.5 Frequency List of Low/Middle/High Channels

5G NR n2 Channel and Frequency List				
BW [MHz]	Channel/Frequency(MHz)	Lowest	Middle	Highest
40	Channel	374000	376000	378000
	Frequency	1870	1880	1890
35	Channel	373500	376000	378500
	Frequency	1867.5	1880	1892.5
30	Channel	373000	376000	379000
	Frequency	1865	1880	1895
25	Channel	372500	376000	379500
	Frequency	1862.5	1880	1897.5
20	Channel	372000	376000	380000
	Frequency	1860	1880	1900
15	Channel	371500	376000	380500
	Frequency	1857.5	1880	1902.5
10	Channel	371000	376000	381000
	Frequency	1855	1880	1905
5	Channel	370500	376000	381500
	Frequency	1852.5	1880	1907.5



5G NR n5 Channel and Frequency List				
BW [MHz]	Channel/Frequency(MHz)	Lowest	Middle	Highest
25	Channel	-	167300	-
	Frequency	-	836.5	-
20	Channel	166800	167300	167800
	Frequency	834	836.5	839
15	Channel	166300	167300	168300
	Frequency	831.5	836.5	841.5
10	Channel	165800	167300	168800
	Frequency	829	836.5	844
5	Channel	165300	167300	169300
	Frequency	826.5	836.5	846.5

5G NR n7 Channel and Frequency List				
BW [MHz]	Channel/Frequency(MHz)	Lowest	Middle	Highest
50	Channel	505000	507000	509000
	Frequency	2525	2535	2545
40	Channel	504000	507000	510000
	Frequency	2520	2535	2550
35	Channel	503500	507000	501500
	Frequency	2517.5	2535	2552.5
30	Channel	503000	507000	511000
	Frequency	2515	2535	2555
25	Channel	502500	507000	511500
	Frequency	2512.5	2535	2557.5
20	Channel	502000	507000	512000
	Frequency	2510	2535	2560
15	Channel	501500	507000	512500
	Frequency	2507.5	2535	2562.5
10	Channel	501000	507000	513000
	Frequency	2505	2535	2565
5	Channel	500500	507000	513500
	Frequency	2502.5	2535	2567.5



5G NR n66 Channel and Frequency List				
BW [MHz]	Channel/Frequency(MHz)	Lowest	Middle	Highest
45	Channel	246500	349000	351500
	Frequency	1732.5	1745	1757.5
40	Channel	346000	349000	352000
	Frequency	1730	1745	1760
35	Channel	345500	349000	352500
	Frequency	1727.5	1745	1762.5
30	Channel	345000	349000	353000
	Frequency	1725	1745	1765
25	Channel	344500	349000	353500
	Frequency	1722.5	1745	1767.5
20	Channel	344000	349000	354000
	Frequency	1720	1745	1770
15	Channel	343500	349000	354500
	Frequency	1717.5	1745	1772.5
10	Channel	343000	349000	355000
	Frequency	1715	1745	1775
5	Channel	342500	349000	355500
	Frequency	1712.5	1745	1777.5

3 Conducted Test Items

3.1 Measuring Instruments

See list of measuring instruments of this test report.

3.2 Test Setup

3.2.1 Conducted Output Power



3.2.2 Peak-to-Average Ratio, Occupied Bandwidth ,Conducted Band-Edge and Conducted Spurious Emission



3.2.3 Frequency Stability

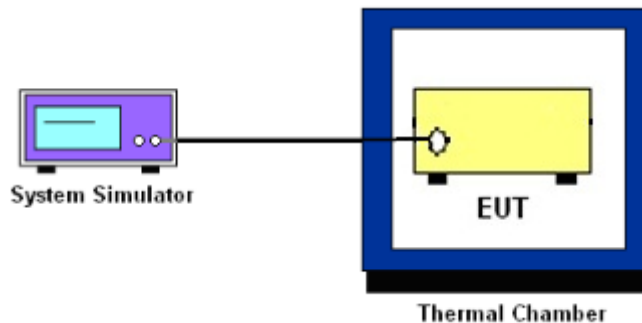

3.3 Test Result of Conducted Test

Please refer to Appendix A.



3.4 Conducted Output Power and ERP/EIRP

3.4.1 Description of the Conducted Output Power Measurement and ERP/EIRP Measurement

A system simulator was used to establish communication with the EUT. Its parameters were set to force the EUT transmitting at maximum output power. The measured power in the radio frequency on the transmitter output terminals shall be reported.

The ERP of mobile transmitters must not exceed 7 Watts for 5G NR n5.

The EIRP of mobile transmitters must not exceed 2 Watts for 5G NR n2, n7.

The EIRP of mobile transmitters must not exceed 1 Watts for 5G NR n66.

According to KDB 412172 D01 Power Approach,

$EIRP = P_T + G_T - L_C$, $ERP = EIRP - 2.15$, where

P_T = transmitter output power in dBm

G_T = gain of the transmitting antenna in dBi

L_C = signal attenuation in the connecting cable between the transmitter and antenna in dB

3.4.2 Test Procedures

1. The testing follows ANSI C63.26 Section 5.2
2. The transmitter output port was connected to the system simulator.
3. Set EUT at maximum power through the system simulator.
4. Select lowest, middle, and highest channels for each band and different modulation.
5. Measure and record the power level from the system simulator.



3.5 Peak-to-Average Ratio

3.5.1 Description of the PAR Measurement

Power Complementary Cumulative Distribution Function (CCDF) curves provide a means for characterizing the power peaks of a digitally modulated signal on a statistical basis. A CCDF curve depicts the probability of the peak signal amplitude exceeding the average power level. Most contemporary measurement instrumentation include the capability to produce CCDF curves for an input signal provided that the instrument's resolution bandwidth can be set wide enough to accommodate the entire input signal bandwidth. In measuring transmissions in this band using an average power technique, the peak-to-average ratio (PAR) of the transmission may not exceed 13 dB.

3.5.2 Test Procedures

1. The testing follows ANSI C63.26 Section 5.2.3.4 (CCDF).
2. The EUT was connected to spectrum and system simulator via a power divider.
3. Set the CCDF (Complementary Cumulative Distribution Function) option in spectrum analyzer.
4. The highest RF powers were measured and recorded the maximum PAPR level associated with a probability of 0.1 %.
5. Record the deviation as Peak to Average Ratio.



3.6 Occupied Bandwidth

3.6.1 Description of Occupied Bandwidth Measurement

The occupied bandwidth is the width of a frequency band such that, below the lower and above the upper frequency limits, the mean powers emitted are each equal to a specified percentage 0.5% of the total mean transmitted power.

The 26 dB emission bandwidth is defined as the frequency range between two points, one above and one below the carrier frequency, at which the spectral density of the emission is attenuated 26 dB below the maximum in-band spectral density of the modulated signal. Spectral density (power per unit bandwidth) is to be measured with a detector of resolution bandwidth equal to approximately 1.0% of the emission bandwidth.

3.6.2 Test Procedures

1. The testing follows ANSI C63.26 Section 5.4
2. The EUT was connected to spectrum analyzer and system simulator via a power divider.
3. The spectrum analyzer center frequency is set to the nominal EUT channel center frequency. The span range for the spectrum analyzer shall be between two and five times the anticipated OBW.
4. The nominal resolution bandwidth (RBW) shall be in the range of 1 to 5 % of the anticipated OBW, and the VBW shall be at least 3 times the RBW.
5. Set the detection mode to peak, and the trace mode to max hold.
6. Determine the reference value: Set the EUT to transmit a modulated signal. Allow the trace to stabilize. Set the spectrum analyzer marker to the highest level of the displayed trace.
(this is the reference value)
7. Determine the “-26 dB down amplitude” as equal to (Reference Value – X).
8. Place two markers, one at the lowest and the other at the highest frequency of the envelope of the spectral display such that each marker is at or slightly below the “-X dB down amplitude” determined in step 6. If a marker is below this “-X dB down amplitude” value it shall be placed as close as possible to this value. The OBW is the positive frequency difference between the two markers.
9. Use the 99 % power bandwidth function of the spectrum analyzer and report the measured bandwidth.



3.7 Conducted Band Edge

3.7.1 Description of Conducted Band Edge Measurement

22.917(a)

For operations in the 824 – 849 MHz band, the FCC limit is $43 + 10\log_{10}(P[\text{Watts}])$ dB below the transmitter power $P(\text{Watts})$ in a 100kHz bandwidth. However, in the 1MHz bands immediately outside and adjacent to the licensee's frequency block, a resolution bandwidth of at least one percent of the emission bandwidth of the fundamental emission of the transmitter may be employed.

24.238 (a)

For operations in the 1850-1910 and 1930-1990 MHz band, the FCC limit is $43 + 10\log_{10}(P[\text{Watts}])$ dB below the transmitter power $P(\text{Watts})$ in a 1MHz bandwidth. However, in the 1 MHz bands immediately outside and adjacent to the frequency block a resolution bandwidth of at least one percent of the emission bandwidth of the fundamental emission of the transmitter may be employed.

27.53 (h)

For operations in the 1710 – 1755 MHz band, the FCC limit is $43 + 10\log_{10}(P[\text{Watts}])$ dB below the transmitter power $P(\text{Watts})$ in a 1 MHz bandwidth. However, in the 1MHz bands immediately outside and adjacent to the licensee's frequency block, a resolution bandwidth of at least one percent of the emission bandwidth of the fundamental emission of the transmitter may be employed.

27.53(m)(4)

For mobile digital stations, the attenuation factor shall be not less than $40 + 10 \log (P)$ dB on all frequencies between the channel edge and 5 megahertz from the channel edge, $43 + 10 \log (P)$ dB on all frequencies between 5 megahertz and X megahertz from the channel edge, and $55 + 10 \log (P)$ dB on all frequencies more than X megahertz from the channel edge, where X is the greater of 6 megahertz or the actual emission bandwidth as defined in paragraph (m)(6) of this section. In addition, the attenuation factor shall not be less that $43 + 10 \log (P)$ dB on all frequencies between 2490.5 MHz and 2496 MHz and $55 + 10 \log (P)$ dB at or below 2490.5 MHz. Mobile Satellite Service licensees operating on frequencies below 2495 MHz may also submit a documented interference complaint against BRS licensees operating on channel BRS Channel 1 on the same terms and conditions as adjacent channel BRS or EBS licensees.



3.7.2 Test Procedures

1. The testing follows ANSI C63.26 section 5.7
2. The EUT was connected to spectrum analyzer and system simulator via a power divider.
3. The band edges of low and high channels for the highest RF powers were measured.
4. Set RBW \geq 1%/2% EBW in the 1MHz band immediately outside and adjacent to the band edge.
5. Beyond the 1 MHz band from the band edge, RBW=1MHz was used or a narrower RBW was used (generally limited to no less than 1% of the OBW) and the measured power was integrated over the full required measurement bandwidth.
6. Set spectrum analyzer with RMS detector.
7. The RF fundamental frequency should be excluded against the limit line in the operating frequency band.
8. Checked that all the results comply with the emission limit line.

Example:

The limit line is derived from $43 + 10\log(P)$ dB below the transmitter power P(Watts)
 $= P(W) - [43 + 10\log(P)]$ (dB)
 $= [30 + 10\log(P)]$ (dBm) - $[43 + 10\log(P)]$ (dB) = -13dBm.

9. For 5G NR n7, the other 40 dB, and 55 dB have additionally applied same calculation above.
10. When using the integration method, the starting frequency of the integration shall be centered at one-half of the RBW away from the band edge.



3.8 Conducted Spurious Emission

3.8.1 Description of Conducted Spurious Emission Measurement

The power of any emission outside of the authorized operating frequency ranges must be lower than the transmitter power (P) by a factor of at least $43 + 10 \log (P)$ dB.

For 5G NR n7:

The power of any emission outside of the authorized operating frequency ranges must be lower than the transmitter power (P) by a factor of at least $55 + 10 \log (P)$ dB.

It is measured by means of a calibrated spectrum analyzer and scanned from 30 MHz up to a frequency including its 10th harmonic.

3.8.2 Test Procedures

1. The testing follows ANSI C63.26 section 5.7
2. The EUT was connected to spectrum analyzer and system simulator via a power divider.
3. The RF output of EUT was connected to the spectrum analyzer by RF cable and attenuator. The path loss was compensated to the results for each measurement.
4. The middle channel for the highest RF power within the transmitting frequency was measured.
5. The conducted spurious emission for the whole frequency range was taken.
6. Make the measurement with the spectrum analyzer's RBW = 1MHz, VBW = 3MHz.
7. Set spectrum analyzer with RMS detector.
8. Taking the record of maximum spurious emission.
9. The RF fundamental frequency should be excluded against the limit line in the operating frequency band.
10. The limit line is derived from $43 + 10\log(P)$ dB below the transmitter power P(Watts)
 $= P(W) - [43 + 10\log(P)]$ (dB)
 $= [30 + 10\log(P)]$ (dBm) - $[43 + 10\log(P)]$ (dB)
 $= -13$ dBm.
11. For 5G NR n7
The limit line is derived from $55 + 10\log(P)$ dB below the transmitter power P(Watts)
 $= P(W) - [55 + 10\log(P)]$ (dB)
 $= [30 + 10\log(P)]$ (dBm) - $[55 + 10\log(P)]$ (dB)
 $= -25$ dBm.



3.9 Frequency Stability

3.9.1 Description of Frequency Stability Measurement

The frequency stability shall be measured by variation of ambient temperature and variation of primary supply voltage to ensure that the fundamental emission stays within the authorized frequency block. The frequency stability of the transmitter shall be maintained within $\pm 0.00025\%$ ($\pm 2.5\text{ppm}$) of the center frequency.

3.9.2 Test Procedures for Temperature Variation

1. The testing follows ANSI C63.26 section 5.6.4
2. The EUT was set up in the thermal chamber and connected with the system simulator.
3. With power OFF, the temperature was decreased to -30°C and the EUT was stabilized before testing. Power was applied and the maximum change in frequency was recorded within one minute.
4. With power OFF, the temperature was raised in 10°C step up to 50°C . The EUT was stabilized at each step for at least half an hour. Power was applied and the maximum frequency change was recorded within one minute.

3.9.3 Test Procedures for Voltage Variation

1. The testing follows ANSI C63.26 section 5.6.5
2. The EUT was placed in a temperature chamber at $20\pm 5^{\circ}\text{C}$ and connected with the system simulator.
3. The power supply voltage to the EUT was varied from 85% to 115% of the nominal value for other than hand carried battery equipment.
4. For hand carried, battery powered equipment, reduce the primary ac or dc supply voltage to the battery operating end point, which shall be specified by the manufacturer.
5. The variation in frequency was measured for the worst case.

4 Radiated Test Items

4.1 Measuring Instruments

See list of measuring instruments of this test report.

4.2 Test Setup

4.2.1 For radiated test below 30MHz

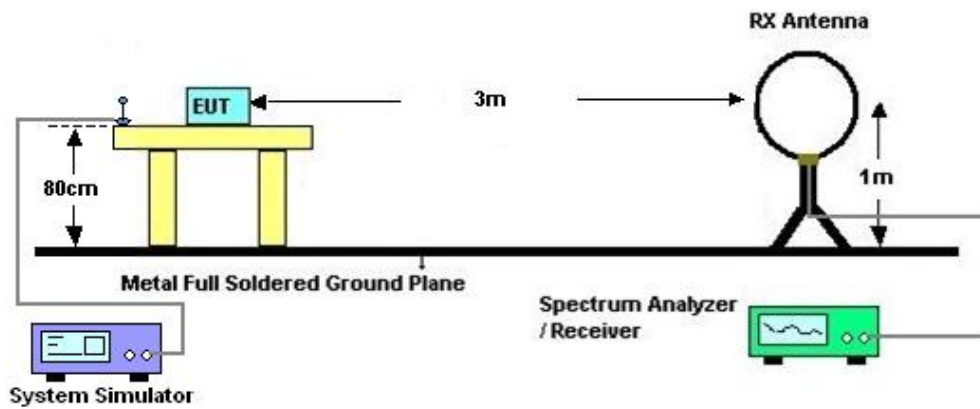

4.2.2 For radiated test from 30MHz to 1GHz

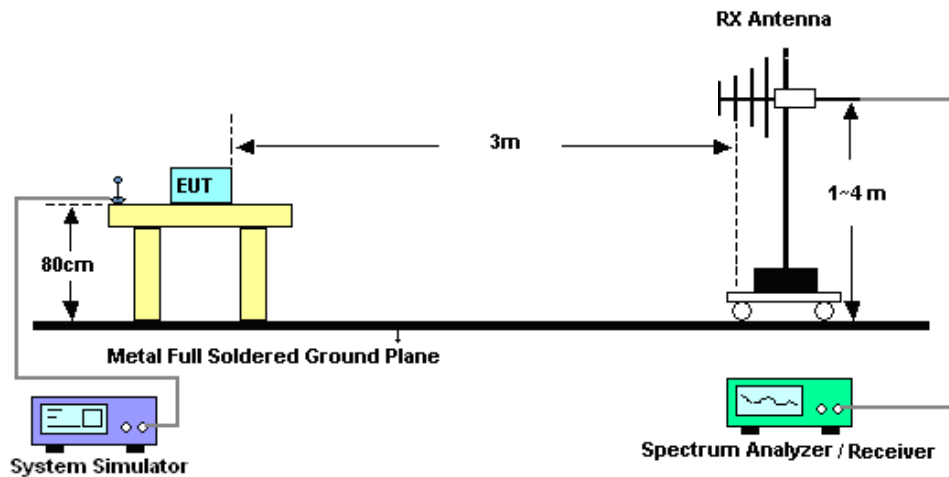

4.2.3 For radiated test above 1GHz

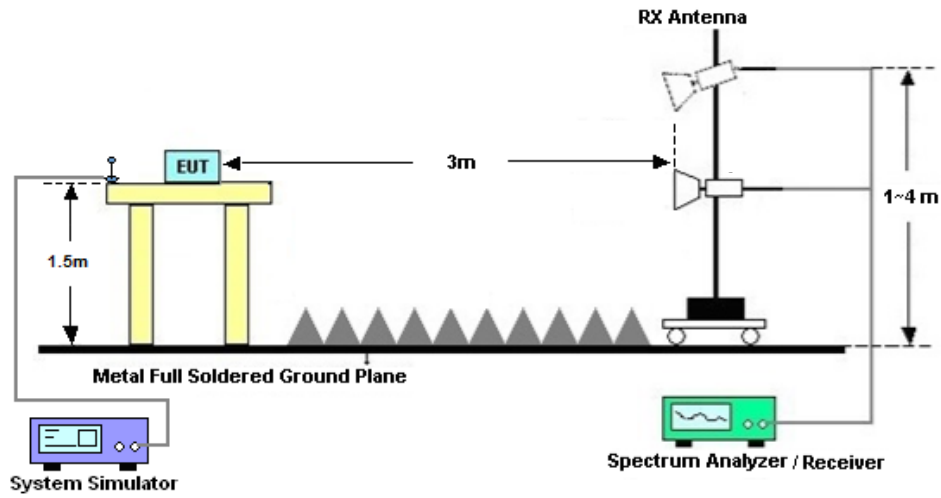

4.3 Test Result of Radiated Test

The low frequency, which started from 9 kHz to 30MHz, was pre-scanned and the result which was 20dB lower than the limit line was not reported.

Please refer to Appendix B.



4.4 Radiated Spurious Emission

4.4.1 Description of Radiated Spurious Emission

The radiated spurious emission was measured by substitution method according to ANSI C63.26. The power of any emission outside of the authorized operating frequency ranges must be attenuated below the transmitter power (P) by a factor of at least $43 + 10 \log (P)$ dB.

For 5G NR n7

The power of any emission outside of the authorized operating frequency ranges must be attenuated below the transmitter power (P) by a factor of at least $55 + 10 \log (P)$ dB.

The spectrum is scanned from 30 MHz up to a frequency including its 10th harmonic.

4.4.2 Test Procedures

1. The testing follows ANSI C63.26 Section 5.5
2. The EUT was placed on a turntable with 0.8 meter height for frequency below 1GHz and 1.5 meter height for frequency above 1GHz respectively above ground.
3. The EUT was set 3 meters from the receiving antenna mounted on the antenna tower.
4. The table was rotated 360 degrees to determine the position of the highest spurious emission.
5. The height of the receiving antenna is varied between 1m to 4m to search the maximum spurious emission for both horizontal and vertical polarizations.
6. During the measurement, the system simulator parameters were set to force the EUT transmitting at maximum output power.
7. Make the measurement with the spectrum analyzer's RBW = 1MHz, VBW = 3MHz, taking the record of maximum spurious emission.
8. A horn antenna was substituted in place of the EUT and was driven by a signal generator.
9. Tune the output power of signal generator to the same emission level with EUT maximum spurious emission.
10. $EIRP (dBm) = S.G. Power - Tx Cable Loss + Tx Antenna Gain$
11. $ERP (dBm) = EIRP - 2.15$
12. The RF fundamental frequency should be excluded against the limit line in the operating frequency band.

The limit line is derived from $43 + 10\log(P)$ dB below the transmitter power P(Watts)
 $= P(W) - [43 + 10\log(P)] (dB)$
 $= [30 + 10\log(P)] (dBm) - [43 + 10\log(P)] (dB)$
 $= -13dBm.$

13. For 5G NR n7:

The limit line is derived from $55 + 10\log(P)$ dB below the transmitter power P(Watts)The limit line is derived from $55 + 10\log(P)$ dB below the transmitter power P(Watts)



5 List of Measuring Equipment

Instrument	Manufacturer	Model No.	Serial No.	Characteristics	Calibration Date	Test Date	Due Date	Remark
EMI Test Receiver&SA	Agilent	N9038A	MY52260185	20Hz~26.5GHz	Dec. 27, 2023	Mar. 14, 2024~Apr. 03, 2024	Dec. 26, 2024	Conducted (TH01-SZ)
Power Divider	TOJOIN	PS-2SM-04 265	60.06.020.007 7	0.4GHz~26.5GHz	Dec. 25, 2023	Mar. 14, 2024~Apr. 03, 2024	Dec. 24, 2024	Conducted (TH01-SZ)
Thermal Chamber	Ten Billion Hongzhangroup	LP-150U	H2014081803	-40~+150°C	Jul. 05, 2023	Mar. 14, 2024~Apr. 03, 2024	Jul. 04, 2024	Conducted (TH01-SZ)
EMI Test Receiver&SA	Agilent	N9038A	MY52260185	20Hz~26.5GHz	Dec. 27, 2023	Mar. 24, 2024~Mar. 28, 2024	Dec. 26, 2024	Radiation (03CH01-SZ)
Loop Antenna	R&S	HFH2-Z2	100354	9kHz~30MHz	Jul. 28, 2022	Mar. 24, 2024~Mar. 28, 2024	Jul. 27, 2024	Radiation (03CH01-SZ)
HF Amplifier	KEYSIGHT	83017A	MY53270105	0.5GHz~26.5Ghz	Oct. 18, 2023	Mar. 24, 2024~Mar. 28, 2024	Oct. 17, 2024	Radiation (03CH01-SZ)
Bilog Antenna	TeseQ	CBL6112D	35407	30MHz-2GHz	Oct. 24, 2023	Mar. 24, 2024~Mar. 28, 2024	Oct. 23, 2025	Radiation (03CH01-SZ)
Double Ridge Horn Antenna	ETS-Lindgren	3117	00119436	1GHz~18GHz	Jul. 08, 2023	Mar. 24, 2024~Mar. 28, 2024	Jul. 07, 2024	Radiation (03CH01-SZ)
SHF-EHF Horn	com-power	AH-840	101071	18Ghz-40GHz	Apr. 08, 2023	Mar. 24, 2024~Mar. 28, 2024	Apr. 07, 2024	Radiation (03CH01-SZ)
LF Amplifier	Burgeon	BPA-530	102209	0.01~3000Mhz	Apr. 04, 2023	Mar. 24, 2024~Mar. 28, 2024	Apr. 03, 2024	Radiation (03CH01-SZ)
HF Amplifier	MITEQ	AMF-7D-00 101800-30-1 0P-R	1943528	1GHz~18GHz	Oct. 18, 2023	Mar. 24, 2024~Mar. 28, 2024	Oct. 17, 2024	Radiation (03CH01-SZ)
HF Amplifier	MITEQ	TTA1840-35 -HG	1871923	18GHz~40GHz	Jul. 07, 2023	Mar. 24, 2024~Mar. 28, 2024	Jul. 06, 2024	Radiation (03CH01-SZ)
AC Power Source	Chroma	61601	616010001985	N/A	Oct. 18, 2023	Mar. 24, 2024~Mar. 28, 2024	Oct. 17, 2024	Radiation (03CH01-SZ)
Turn Table	EM	EM1000	N/A	0~360 degree	NCR	Mar. 24, 2024~Mar. 28, 2024	NCR	Radiation (03CH01-SZ)
Antenna Mast	EM	EM1000	N/A	1 m~4 m	NCR	Mar. 24, 2024~Mar. 28, 2024	NCR	Radiation (03CH01-SZ)

NCR: No Calibration Required



6 Measurement Uncertainty

The measurement uncertainties shown below were calculated in accordance with the requirements of ANSI 63.26-2015. All the measurement uncertainty value were shown with a coverage K=2 to indicate 95% level of confidence. The measurement data show herein meets or exceeds the CISPR measurement uncertainty values specified in CISPR 16-4-2 and can be compared directly to specified limit to determine compliance.

Uncertainty of Conducted Measurement

Test Item	Uncertainty
Conducted Spurious Emission & Bandedge	±1.34 dB
Occupied Channel Bandwidth	±0.012 MHz
Conducted Power	±1.34 dB
Peak to Average Ratio	±1.34 dB
Frequency Stability	±1.3 ppm

Uncertainty of Radiated Emission Measurement (9 KHz ~ 30 MHz)

Measuring Uncertainty for a Level of Confidence of 95% (U = 2Uc(y))	2.8dB
---	-------

Uncertainty of Radiated Emission Measurement (30 MHz ~ 1000 MHz)

Measuring Uncertainty for a Level of Confidence of 95% (U = 2Uc(y))	2.48 dB
---	---------

Uncertainty of Radiated Emission Measurement (1 GHz ~ 18 GHz)

Measuring Uncertainty for a Level of Confidence of 95% (U = 2Uc(y))	3.53dB
---	--------

Uncertainty of Radiated Emission Measurement (18 GHz ~ 40 GHz)

Measuring Uncertainty for a Level of Confidence of 95% (U = 2Uc(y))	4.02dB
---	--------

----- THE END -----



Appendix A. Test Results of Conducted Test

Test Engineer :	Khan Zhen	Temperature :	24~26°C
		Relative Humidity :	50~53%

FR1 N2 (ANT2)

Transmitter Conducted Output Power And EIRP, (G_T - L_C)=-1.5dB

NR Band	SCS (kHz)	Bandwidth (MHz)	Arfcn	Freq (MHz)	Modulation	RB	Conducted Power(dBm)	EIRP (dBm)	EIRP (W)
2	15	5	370500	1852.5	DFT-s-OFDM QPSK	1@1	23.99	22.49	0.1774
2	15	5	370500	1852.5	DFT-s-OFDM 16 QAM	1@1	22.96	21.46	0.1400
2	15	5	376000	1880	DFT-s-OFDM QPSK	1@1	24.04	22.54	0.1795
2	15	5	376000	1880	DFT-s-OFDM 16 QAM	1@1	23.04	21.54	0.1426
2	15	5	381500	1907.5	DFT-s-OFDM QPSK	1@1	24.36	22.86	0.1932
2	15	5	381500	1907.5	DFT-s-OFDM 16 QAM	1@1	23.21	21.71	0.1483
2	15	10	371000	1855	DFT-s-OFDM QPSK	1@1	24.08	22.58	0.1811
2	15	10	371000	1855	DFT-s-OFDM 16 QAM	1@1	23.11	21.61	0.1449
2	15	10	376000	1880	DFT-s-OFDM QPSK	1@1	24.07	22.57	0.1807
2	15	10	376000	1880	DFT-s-OFDM 16 QAM	1@1	23.04	21.54	0.1426
2	15	10	381000	1905	DFT-s-OFDM QPSK	1@1	24.28	22.78	0.1897
2	15	10	381000	1905	DFT-s-OFDM 16 QAM	1@1	23.21	21.71	0.1483
2	15	15	371500	1857.5	DFT-s-OFDM QPSK	1@1	24	22.5	0.1778
2	15	15	371500	1857.5	DFT-s-OFDM 16 QAM	1@1	22.93	21.43	0.1390
2	15	15	376000	1880	DFT-s-OFDM QPSK	1@1	24.04	22.54	0.1795
2	15	15	376000	1880	DFT-s-OFDM 16 QAM	1@1	23	21.5	0.1413
2	15	15	380500	1902.5	DFT-s-OFDM QPSK	1@1	24.04	22.54	0.1795
2	15	15	380500	1902.5	DFT-s-OFDM 16 QAM	1@1	23.12	21.62	0.1452
2	15	20	372000	1860	DFT-s-OFDM QPSK	1@1	23.93	22.43	0.1750
2	15	20	372000	1860	DFT-s-OFDM 16 QAM	1@1	22.91	21.41	0.1384
2	15	20	376000	1880	DFT-s-OFDM QPSK	1@1	23.94	22.44	0.1754
2	15	20	376000	1880	DFT-s-OFDM 16 QAM	1@1	22.96	21.46	0.1400
2	15	20	380000	1900	DFT-s-OFDM QPSK	1@1	23.97	22.47	0.1766
2	15	20	380000	1900	DFT-s-OFDM 16 QAM	1@1	23.08	21.58	0.1439
2	15	25	372500	1862.5	DFT-s-OFDM QPSK	1@1	23.78	22.28	0.1690
2	15	25	372500	1862.5	DFT-s-OFDM 16 QAM	1@1	22.82	21.32	0.1355
2	15	25	376000	1880	DFT-s-OFDM QPSK	1@1	23.82	22.32	0.1706
2	15	25	376000	1880	DFT-s-OFDM 16 QAM	1@1	22.91	21.41	0.1384
2	15	25	379500	1897.5	DFT-s-OFDM QPSK	1@1	23.97	22.47	0.1766
2	15	25	379500	1897.5	DFT-s-OFDM 16 QAM	1@1	23.01	21.51	0.1416
2	15	30	373000	1865	DFT-s-OFDM QPSK	1@1	23.86	22.36	0.1722
2	15	30	373000	1865	DFT-s-OFDM 16 QAM	1@1	22.88	21.38	0.1374
2	15	30	376000	1880	DFT-s-OFDM QPSK	1@1	23.88	22.38	0.1730
2	15	30	376000	1880	DFT-s-OFDM 16 QAM	1@1	22.87	21.37	0.1371
2	15	30	379000	1895	DFT-s-OFDM QPSK	1@1	23.98	22.48	0.1770
2	15	30	379000	1895	DFT-s-OFDM 16 QAM	1@1	23.07	21.57	0.1435

2	15	35	373500	1867.5	DFT-s-OFDM QPSK	1@1	23.88	22.38	0.1730
2	15	35	373500	1867.5	DFT-s-OFDM 16 QAM	1@1	22.85	21.35	0.1365
2	15	35	376000	1880	DFT-s-OFDM QPSK	1@1	23.68	22.18	0.1652
2	15	35	376000	1880	DFT-s-OFDM 16 QAM	1@1	22.76	21.26	0.1337
2	15	35	378500	1892.5	DFT-s-OFDM QPSK	1@1	23.84	22.34	0.1714
2	15	35	378500	1892.5	DFT-s-OFDM 16 QAM	1@1	22.84	21.34	0.1361
2	15	40	374000	1870	DFT-s-OFDM PI/2 BPSK	108@54	24.18	22.68	0.1854
2	15	40	374000	1870	DFT-s-OFDM PI/2 BPSK	1@1	23.83	22.33	0.1710
2	15	40	374000	1870	DFT-s-OFDM PI/2 BPSK	1@214	24.11	22.61	0.1824
2	15	40	374000	1870	DFT-s-OFDM QPSK	108@54	24.23	22.73	0.1875
2	15	40	374000	1870	DFT-s-OFDM QPSK	1@1	24.1	22.6	0.1820
2	15	40	374000	1870	DFT-s-OFDM QPSK	1@214	24.13	22.63	0.1832
2	15	40	374000	1870	DFT-s-OFDM 16 QAM	108@54	23.29	21.79	0.1510
2	15	40	374000	1870	DFT-s-OFDM 16 QAM	1@1	23.1	21.6	0.1445
2	15	40	374000	1870	DFT-s-OFDM 16 QAM	1@214	23.33	21.83	0.1524
2	15	40	374000	1870	DFT-s-OFDM 64 QAM	108@54	21.77	20.27	0.1064
2	15	40	374000	1870	DFT-s-OFDM 64 QAM	1@1	21.28	19.78	0.0951
2	15	40	374000	1870	DFT-s-OFDM 64 QAM	1@214	21.52	20.02	0.1005
2	15	40	374000	1870	DFT-s-OFDM 256 QAM	108@54	19.79	18.29	0.0675
2	15	40	374000	1870	DFT-s-OFDM 256 QAM	1@1	19.4	17.9	0.0617
2	15	40	374000	1870	DFT-s-OFDM 256 QAM	1@214	19.65	18.15	0.0653
2	15	40	374000	1870	CP-OFDM QPSK	108@54	22.71	21.21	0.1321
2	15	40	374000	1870	CP-OFDM QPSK	1@1	22.51	21.01	0.1262
2	15	40	374000	1870	CP-OFDM QPSK	1@214	22.85	21.35	0.1365
2	15	40	376000	1880	DFT-s-OFDM PI/2 BPSK	108@54	24.18	22.68	0.1854
2	15	40	376000	1880	DFT-s-OFDM PI/2 BPSK	1@1	23.9	22.4	0.1738
2	15	40	376000	1880	DFT-s-OFDM PI/2 BPSK	1@214	24.12	22.62	0.1828
2	15	40	376000	1880	DFT-s-OFDM QPSK	108@54	24.21	22.71	0.1866
2	15	40	376000	1880	DFT-s-OFDM QPSK	1@1	24.14	22.64	0.1837
2	15	40	376000	1880	DFT-s-OFDM QPSK	1@214	24.15	22.65	0.1841
2	15	40	376000	1880	DFT-s-OFDM 16 QAM	108@54	23.29	21.79	0.1510
2	15	40	376000	1880	DFT-s-OFDM 16 QAM	1@1	23.16	21.66	0.1466
2	15	40	376000	1880	DFT-s-OFDM 16 QAM	1@214	23.31	21.81	0.1517
2	15	40	376000	1880	DFT-s-OFDM 64 QAM	108@54	21.82	20.32	0.1076
2	15	40	376000	1880	DFT-s-OFDM 64 QAM	1@1	21.31	19.81	0.0957
2	15	40	376000	1880	DFT-s-OFDM 64 QAM	1@214	21.52	20.02	0.1005
2	15	40	376000	1880	DFT-s-OFDM 256 QAM	108@54	19.81	18.31	0.0678
2	15	40	376000	1880	DFT-s-OFDM 256 QAM	1@1	19.48	17.98	0.0628
2	15	40	376000	1880	DFT-s-OFDM 256 QAM	1@214	19.72	18.22	0.0664
2	15	40	376000	1880	CP-OFDM QPSK	108@54	22.76	21.26	0.1337
2	15	40	376000	1880	CP-OFDM QPSK	1@1	22.42	20.92	0.1236
2	15	40	376000	1880	CP-OFDM QPSK	1@214	22.67	21.17	0.1309
2	15	40	378000	1890	DFT-s-OFDM PI/2 BPSK	108@54	24.29	22.79	0.1901
2	15	40	378000	1890	DFT-s-OFDM PI/2 BPSK	1@1	23.98	22.48	0.1770

2	15	40	378000	1890	DFT-s-OFDM PI/2 BPSK	1@214	24.28	22.78	0.1897
2	15	40	378000	1890	DFT-s-OFDM QPSK	108@54	24.37	22.87	0.1936
2	15	40	378000	1890	DFT-s-OFDM QPSK	1@1	24.27	22.77	0.1892
2	15	40	378000	1890	DFT-s-OFDM QPSK	1@214	24.21	22.71	0.1866
2	15	40	378000	1890	DFT-s-OFDM 16 QAM	108@54	23.41	21.91	0.1552
2	15	40	378000	1890	DFT-s-OFDM 16 QAM	1@1	23.19	21.69	0.1476
2	15	40	378000	1890	DFT-s-OFDM 16 QAM	1@214	23.46	21.96	0.1570
2	15	40	378000	1890	DFT-s-OFDM 64 QAM	108@54	21.91	20.41	0.1099
2	15	40	378000	1890	DFT-s-OFDM 64 QAM	1@1	21.39	19.89	0.0975
2	15	40	378000	1890	DFT-s-OFDM 64 QAM	1@214	21.67	20.17	0.1040
2	15	40	378000	1890	DFT-s-OFDM 256 QAM	108@54	19.95	18.45	0.0700
2	15	40	378000	1890	DFT-s-OFDM 256 QAM	1@1	19.6	18.1	0.0646
2	15	40	378000	1890	DFT-s-OFDM 256 QAM	1@214	19.89	18.39	0.0690
2	15	40	378000	1890	CP-OFDM QPSK	108@54	22.9	21.4	0.1380
2	15	40	378000	1890	CP-OFDM QPSK	1@1	22.49	20.99	0.1256
2	15	40	378000	1890	CP-OFDM QPSK	1@214	22.91	21.41	0.1384

Frequency Stability

NR Band	SCS (kHz)	Bandwidth (MHz)	Arfcn	Freq (MHz)	Modulation	RB	Deviation (ppm)	Verdict	Environment
2	15	20	376000	1880.0	DFT-s-OFDM QPSK	100@0	0.0068	PASS	NV
2	15	20	376000	1880.0	DFT-s-OFDM QPSK	100@0	0.0028	PASS	LV
2	15	20	376000	1880.0	DFT-s-OFDM QPSK	100@0	0.0053	PASS	HV
2	15	20	376000	1880.0	DFT-s-OFDM QPSK	100@0	0.0043	PASS	-30°C
2	15	20	376000	1880.0	DFT-s-OFDM QPSK	100@0	0.0031	PASS	-20°C
2	15	20	376000	1880.0	DFT-s-OFDM QPSK	100@0	0.0021	PASS	-10°C
2	15	20	376000	1880.0	DFT-s-OFDM QPSK	100@0	0.0025	PASS	0°C
2	15	20	376000	1880.0	DFT-s-OFDM QPSK	100@0	0.0039	PASS	10°C
2	15	20	376000	1880.0	DFT-s-OFDM QPSK	100@0	0.0068	PASS	20°C
2	15	20	376000	1880.0	DFT-s-OFDM QPSK	100@0	0.0033	PASS	30°C
2	15	20	376000	1880.0	DFT-s-OFDM QPSK	100@0	0.0042	PASS	40°C
2	15	20	376000	1880.0	DFT-s-OFDM QPSK	100@0	0.0040	PASS	50°C

Peak to Average Ratio

NR Band	SCS (kHz)	Bandwidth (MHz)	Arfcn	Freq (MHz)	Modulation	RB	Result (dB)	Limit (dB)	Verdict
2	15	20	376000	1880.0	DFT-s-OFDM PI/2 BPSK	100@0	4.19	13	PASS
2	15	20	376000	1880.0	DFT-s-OFDM QPSK	100@0	5.14	13	PASS

N2(20M)_DFT-s-OFDM_PI_2- BPSK_Outer_Full_Mid_CH

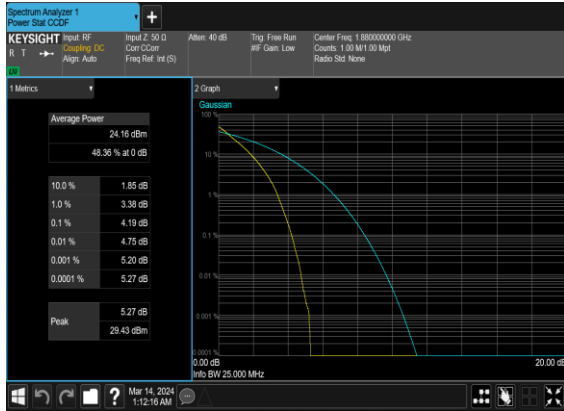

N2(20M)_DFT-s- OFDM_QPSK_Outer_Full_Mid_CH



Occupied Bandwidth

NR Band	SCS (kHz)	Bandwidth (MHz)	Arfcn	Freq (MHz)	Modulation	RB	OBW (MHz)	26dB BW (MHz)
2	15	5	376000	1880.0	CP-OFDM QPSK	25@0	4.4643	4.796
2	15	5	376000	1880.0	CP-OFDM 16 QAM	25@0	4.4679	4.814
2	15	5	376000	1880.0	CP-OFDM 64 QAM	25@0	4.4884	4.866
2	15	5	376000	1880.0	CP-OFDM 256 QAM	25@0	4.4701	4.786
2	15	10	376000	1880.0	CP-OFDM QPSK	52@0	9.275	9.668
2	15	10	376000	1880.0	CP-OFDM 16 QAM	52@0	9.2723	9.726
2	15	10	376000	1880.0	CP-OFDM 64 QAM	52@0	9.2846	9.705
2	15	10	376000	1880.0	CP-OFDM 256 QAM	52@0	9.2631	9.706
2	15	15	376000	1880.0	CP-OFDM QPSK	79@0	14.091	14.6
2	15	15	376000	1880.0	CP-OFDM 16 QAM	79@0	14.091	14.62
2	15	15	376000	1880.0	CP-OFDM 64 QAM	79@0	14.132	14.69
2	15	15	376000	1880.0	CP-OFDM 256 QAM	79@0	14.125	14.69
2	15	20	376000	1880.0	CP-OFDM QPSK	106@0	18.902	19.78
2	15	20	376000	1880.0	CP-OFDM 16 QAM	106@0	18.923	19.7
2	15	20	376000	1880.0	CP-OFDM 64 QAM	106@0	18.928	19.61
2	15	20	376000	1880.0	CP-OFDM 256 QAM	106@0	18.868	19.62
2	15	25	376000	1880.0	CP-OFDM QPSK	133@0	23.791	24.59
2	15	25	376000	1880.0	CP-OFDM 16 QAM	133@0	23.747	24.66
2	15	25	376000	1880.0	CP-OFDM 64 QAM	133@0	23.772	24.69
2	15	25	376000	1880.0	CP-OFDM 256 QAM	133@0	23.772	24.62
2	15	30	376000	1880.0	CP-OFDM QPSK	160@0	28.602	29.62
2	15	30	376000	1880.0	CP-OFDM 16 QAM	160@0	28.561	29.67
2	15	30	376000	1880.0	CP-OFDM 64 QAM	160@0	28.506	29.66
2	15	30	376000	1880.0	CP-OFDM 256 QAM	160@0	28.494	29.52
2	15	35	376000	1880.0	CP-OFDM QPSK	188@0	33.522	34.69

2	15	35	376000	1880.0	CP-OFDM 16 QAM	188@0	33.485	34.66
2	15	35	376000	1880.0	CP-OFDM 64 QAM	188@0	33.458	34.73
2	15	35	376000	1880.0	CP-OFDM 256 QAM	188@0	33.499	34.68
2	15	40	376000	1880.0	CP-OFDM QPSK	216@0	38.551	39.86
2	15	40	376000	1880.0	CP-OFDM 16 QAM	216@0	38.528	39.84
2	15	40	376000	1880.0	CP-OFDM 64 QAM	216@0	38.502	39.89
2	15	40	376000	1880.0	CP-OFDM 256 QAM	216@0	38.585	39.99

N2(5M)_CP-OFDM_QPSK_Outer_Full_Mid_CH

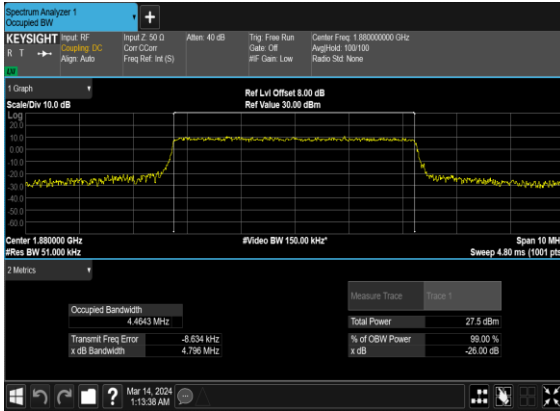

N2(5M)_CP-OFDM_16 QAM_Outer_Full_Mid_CH

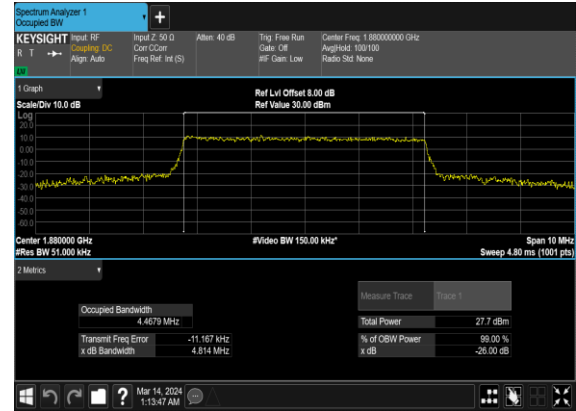

N2(5M)_CP-OFDM_64 QAM_Outer_Full_Mid_CH



N2(5M)_CP-OFDM_256 QAM_Outer_Full_Mid_CH

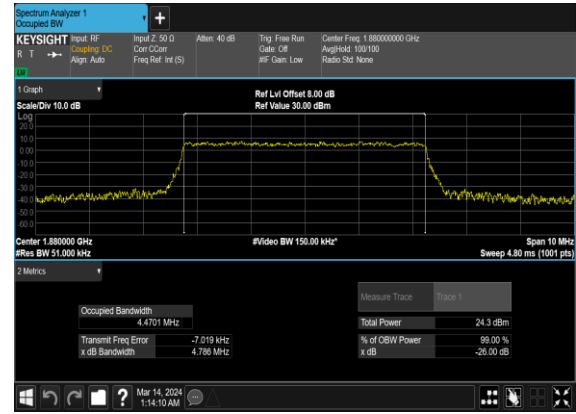

N2(10M)_CP-OFDM_QPSK_Outer_Full_Mid_CH

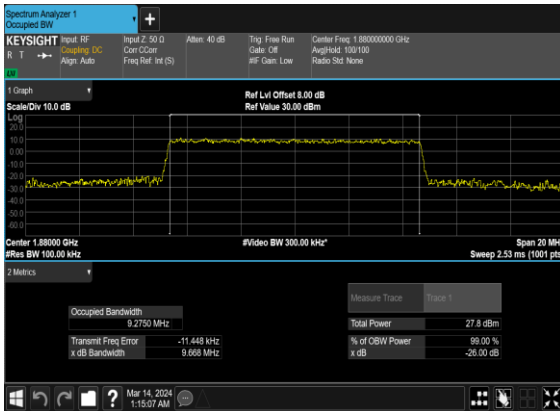

N2(10M)_CP-OFDM_16 QAM_Outer_Full_Mid_CH

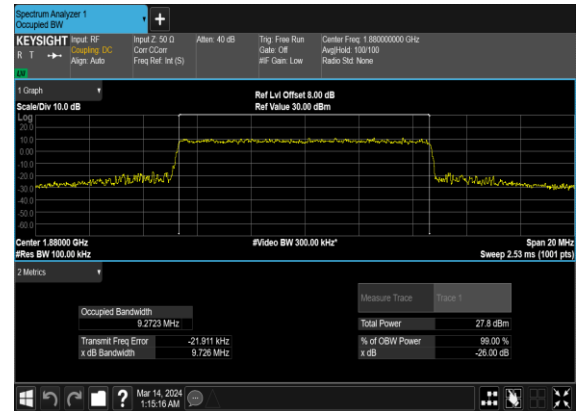

N2(10M)_CP-OFDM_64 QAM_Outer_Full_Mid_CH

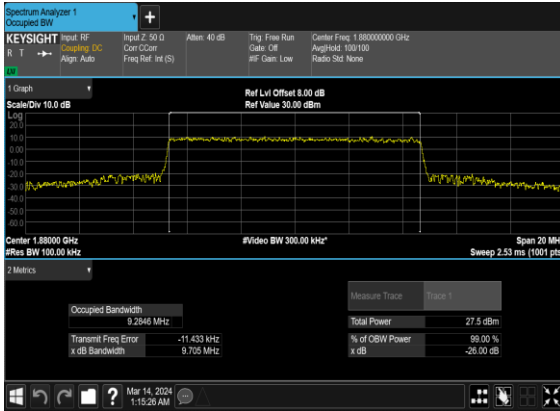

N2(10M)_CP-OFDM_256 QAM_Outer_Full_Mid_CH

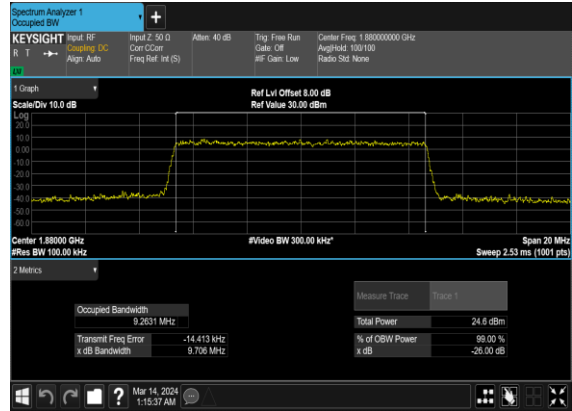

N2(15M)_CP- OFDM_QPSK_Outer_Full_Mid_CH

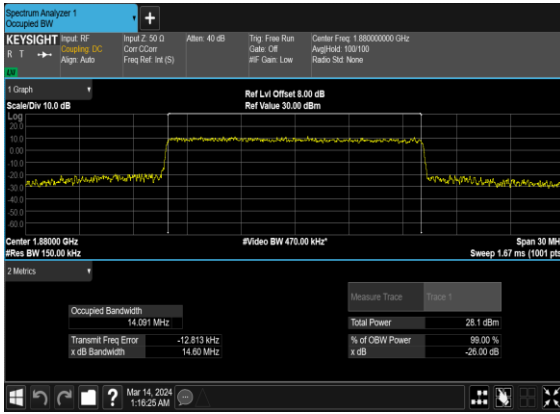

N2(15M)_CP-OFDM_16 QAM_Outer_Full_Mid_CH

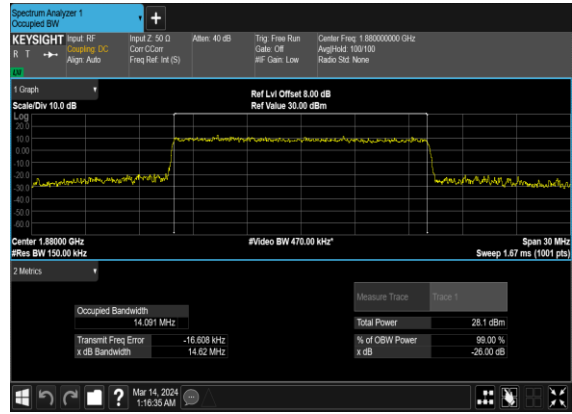

N2(15M)_CP-OFDM_64 QAM_Outer_Full_Mid_CH

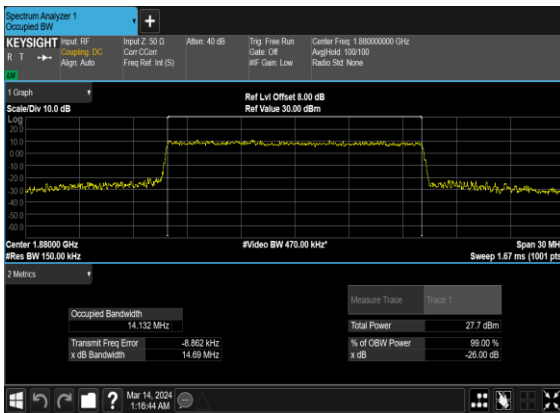

N2(15M)_CP-OFDM_256 QAM_Outer_Full_Mid_CH

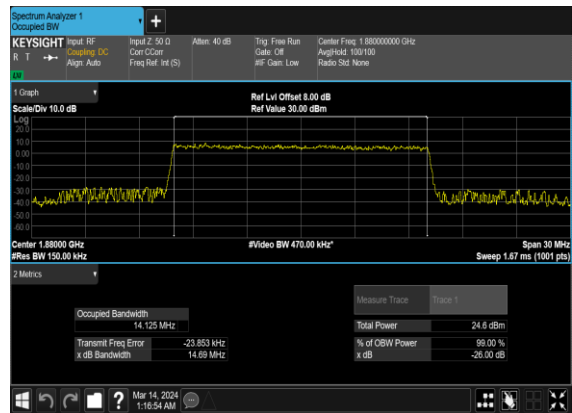

N2(20M)_CP-OFDM_QPSK_Outer_Full_Mid_CH



N2(20M)_CP-OFDM_16QAM_Outer_Full_Mid_CH

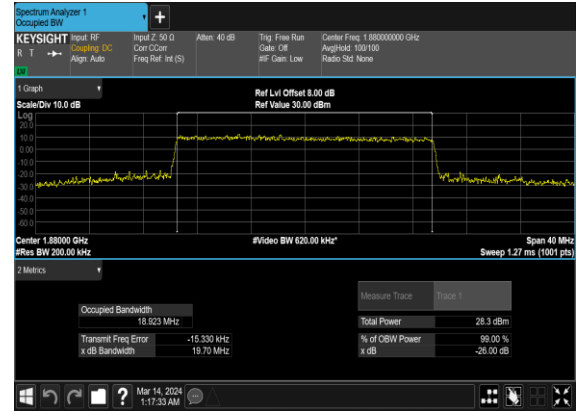

N2(20M)_CP-OFDM_64QAM_Outer_Full_Mid_CH



N2(20M)_CP-OFDM_256QAM_Outer_Full_Mid_CH



N2(25M)_CP-OFDM_QPSK_Outer_Full_Mid_CH

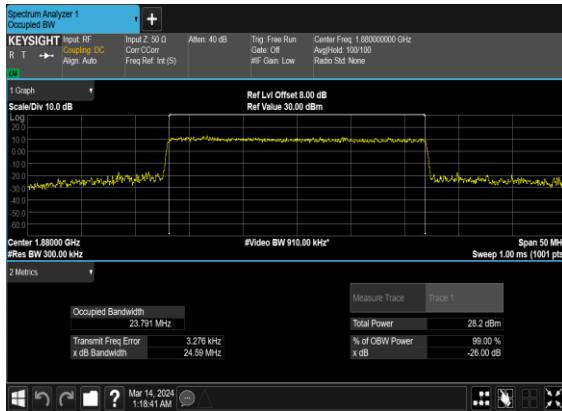

N2(25M)_CP-OFDM_16QAM_Outer_Full_Mid_CH

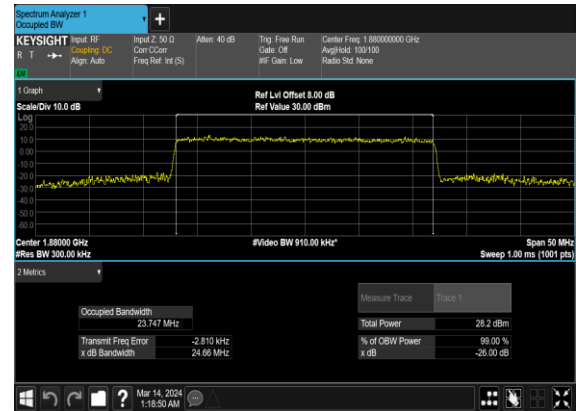

N2(25M)_CP-OFDM_64 QAM_Outer_Full_Mid_CH

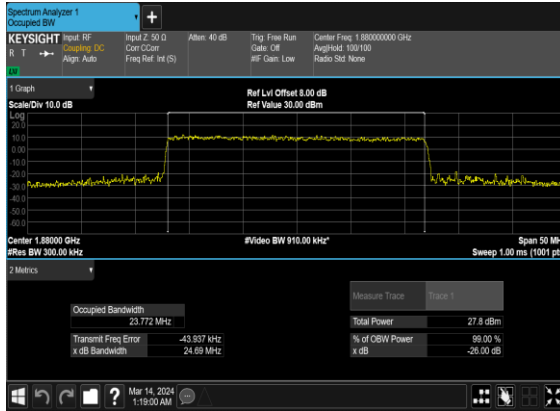

N2(25M)_CP-OFDM_256 QAM_Outer_Full_Mid_CH

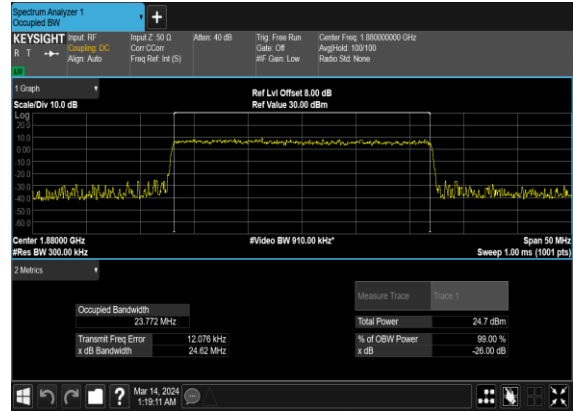

N2(30M)_CP- OFDM_QPSK_Outer_Full_Mid_CH

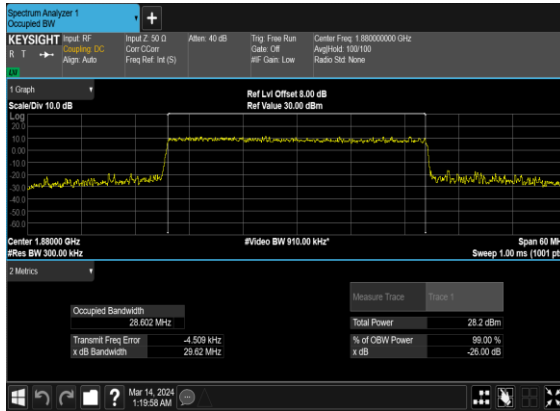

N2(30M)_CP-OFDM_16 QAM_Outer_Full_Mid_CH

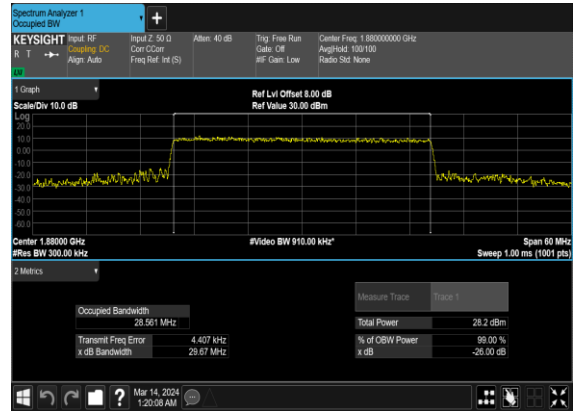

N2(30M)_CP-OFDM_64 QAM_Outer_Full_Mid_CH

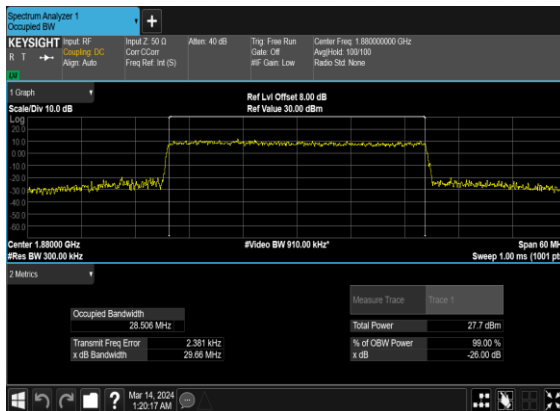

N2(30M)_CP-OFDM_256 QAM_Outer_Full_Mid_CH

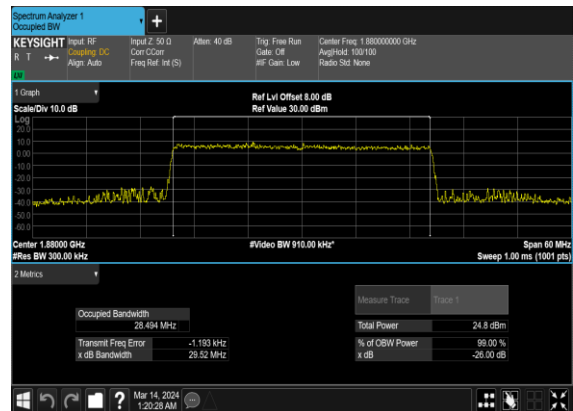

N2(35M)_CP-OFDM_QPSK_Outer_Full_Mid_CH

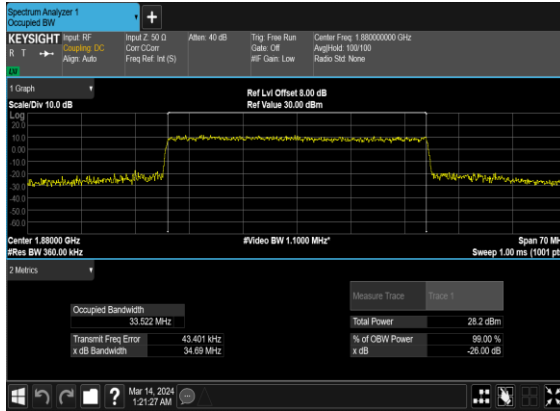

N2(35M)_CP-OFDM_16QAM_Outer_Full_Mid_CH

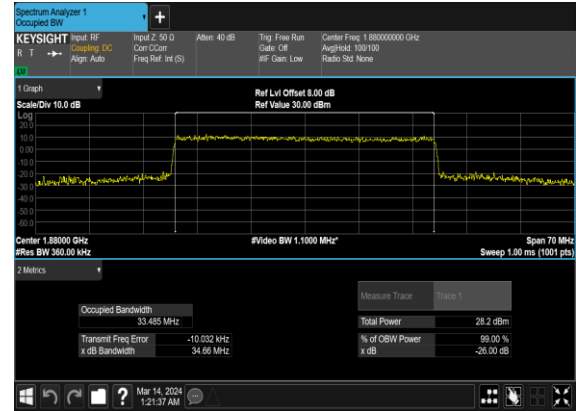

N2(35M)_CP-OFDM_64QAM_Outer_Full_Mid_CH

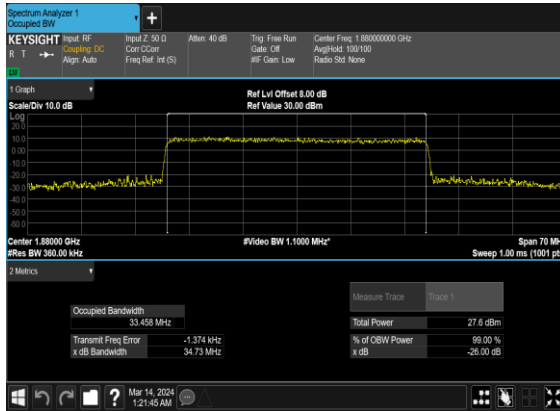

N2(35M)_CP-OFDM_256QAM_Outer_Full_Mid_CH

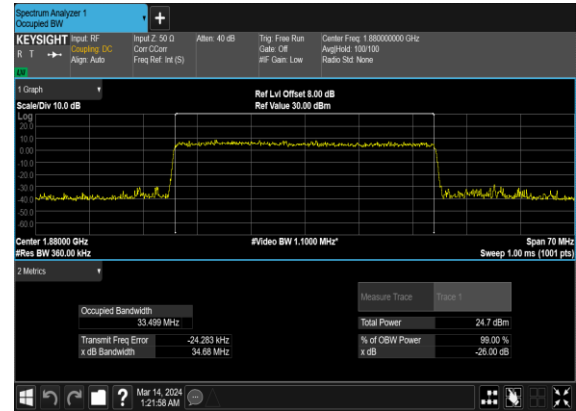

N2(40M)_CP-OFDM_QPSK_Outer_Full_Mid_CH

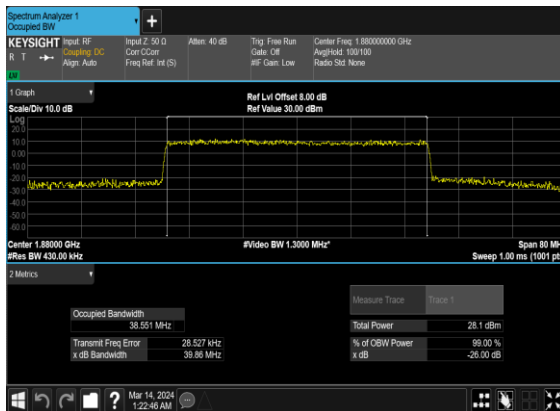

N2(40M)_CP-OFDM_16QAM_Outer_Full_Mid_CH

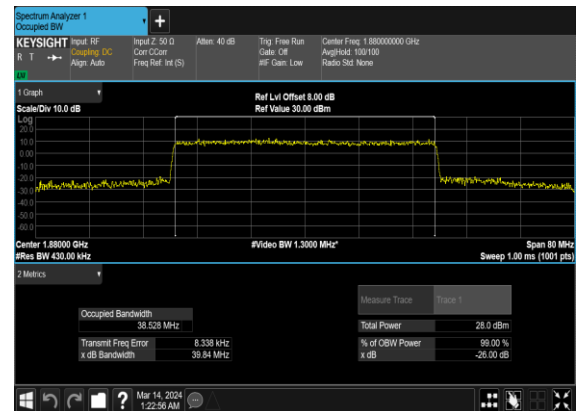

N2(40M)_CP-OFDM_64 QAM_Outer_Full_Mid_CH

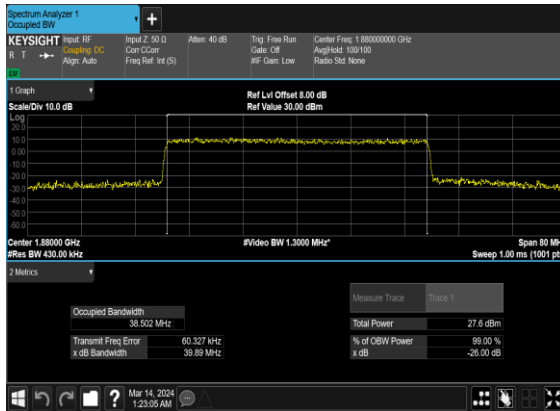

N2(40M)_CP-OFDM_256 QAM_Outer_Full_Mid_CH

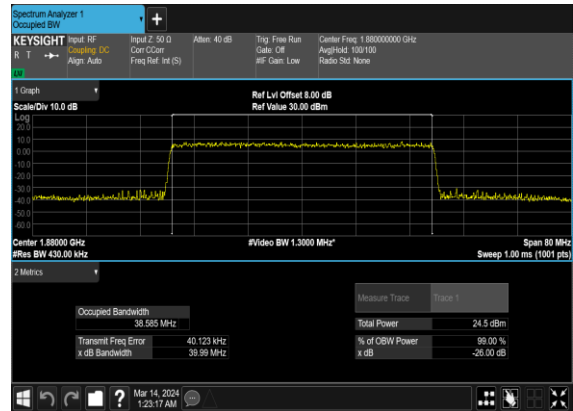

Conducted Spurious Emissions

NR Band	SCS (kHz)	Bandwidth (MHz)	Arfcn	Freq (MHz)	Modulation	RB	Result	Verdict
2	15	5	370500	1852.5	DFT-s-OFDM BPSK	1@0	see graph	---
2	15	5	370500	1852.5	DFT-s-OFDM BPSK	1@0	see graph	PASS
2	15	5	370500	1852.5	DFT-s-OFDM QPSK	1@0	see graph	---
2	15	5	370500	1852.5	DFT-s-OFDM QPSK	1@0	see graph	PASS
2	15	5	376000	1880.0	DFT-s-OFDM BPSK	1@0	see graph	---
2	15	5	376000	1880.0	DFT-s-OFDM BPSK	1@0	see graph	PASS
2	15	5	376000	1880.0	DFT-s-OFDM QPSK	1@0	see graph	---
2	15	5	376000	1880.0	DFT-s-OFDM QPSK	1@0	see graph	PASS
2	15	5	381500	1907.5	DFT-s-OFDM BPSK	1@0	see graph	---
2	15	5	381500	1907.5	DFT-s-OFDM BPSK	1@0	see graph	PASS
2	15	5	381500	1907.5	DFT-s-OFDM QPSK	1@0	see graph	---
2	15	5	381500	1907.5	DFT-s-OFDM QPSK	1@0	see graph	PASS
2	15	20	372000	1860.0	DFT-s-OFDM BPSK	1@0	see graph	---
2	15	20	372000	1860.0	DFT-s-OFDM BPSK	1@0	see graph	PASS
2	15	20	372000	1860.0	DFT-s-OFDM QPSK	1@0	see graph	---
2	15	20	372000	1860.0	DFT-s-OFDM QPSK	1@0	see graph	PASS
2	15	20	376000	1880.0	DFT-s-OFDM BPSK	1@0	see graph	---
2	15	20	376000	1880.0	DFT-s-OFDM BPSK	1@0	see graph	PASS
2	15	20	376000	1880.0	DFT-s-OFDM QPSK	1@0	see graph	---
2	15	20	376000	1880.0	DFT-s-OFDM QPSK	1@0	see graph	PASS
2	15	20	380000	1900.0	DFT-s-OFDM BPSK	1@0	see graph	---
2	15	20	380000	1900.0	DFT-s-OFDM BPSK	1@0	see graph	PASS

2	15	20	380000	1900.0	DFT-s-OFDM QPSK	1@0	see graph	---
2	15	20	380000	1900.0	DFT-s-OFDM QPSK	1@0	see graph	PASS
2	15	40	374000	1870.0	DFT-s-OFDM BPSK	1@0	see graph	---
2	15	40	374000	1870.0	DFT-s-OFDM BPSK	1@0	see graph	PASS
2	15	40	374000	1870.0	DFT-s-OFDM QPSK	1@0	see graph	---
2	15	40	374000	1870.0	DFT-s-OFDM QPSK	1@0	see graph	PASS
2	15	40	376000	1880.0	DFT-s-OFDM BPSK	1@0	see graph	---
2	15	40	376000	1880.0	DFT-s-OFDM BPSK	1@0	see graph	PASS
2	15	40	376000	1880.0	DFT-s-OFDM QPSK	1@0	see graph	---
2	15	40	376000	1880.0	DFT-s-OFDM QPSK	1@0	see graph	PASS
2	15	40	378000	1890.0	DFT-s-OFDM BPSK	1@0	see graph	---
2	15	40	378000	1890.0	DFT-s-OFDM BPSK	1@0	see graph	PASS
2	15	40	378000	1890.0	DFT-s-OFDM QPSK	1@0	see graph	---
2	15	40	378000	1890.0	DFT-s-OFDM QPSK	1@0	see graph	PASS

N2(5M)_DFT-s-OFDM_BPSK_Edge_1RB_Left_Low_CH

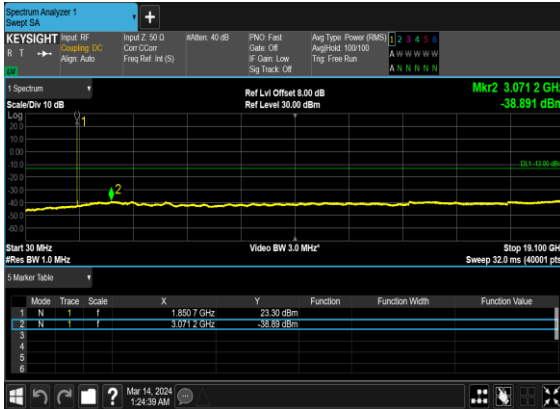

N2(5M)_DFT-s-OFDM_QPSK_Edge_1RB_Left_Low_CH

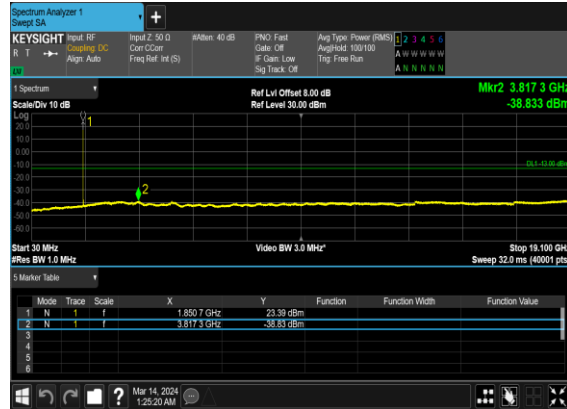

N2(5M)_DFT-s-OFDM_BPSK_Edge_1RB_Left_Mid_CH



N2(5M)_DFT-s-OFDM_QPSK_Edge_1RB_Left_Mid_CH

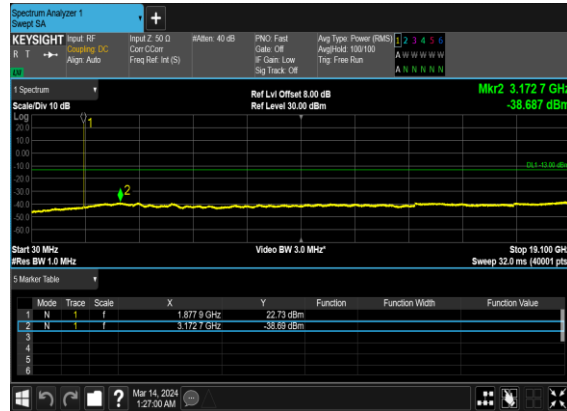

N2(5M)_DFT-s-OFDM_BPSK_Edge_1RB_Left_High_CH

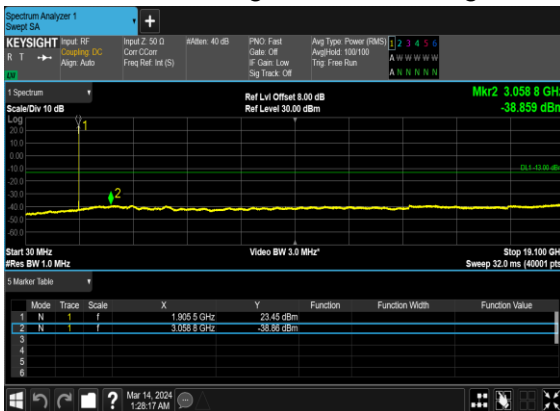

N2(5M)_DFT-s-OFDM_QPSK_Edge_1RB_Left_High_CH

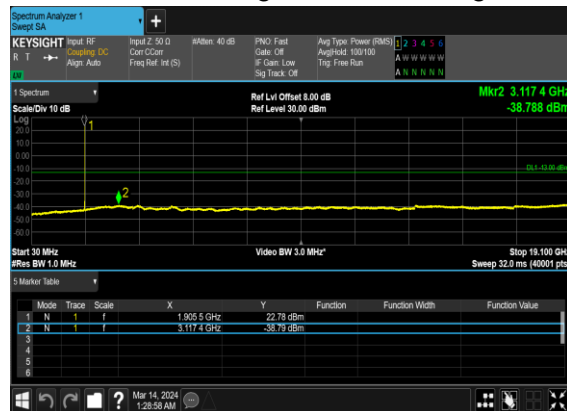

N2(20M)_DFT-s-OFDM_BPSK_Edge_1RB_Left_Low_CH

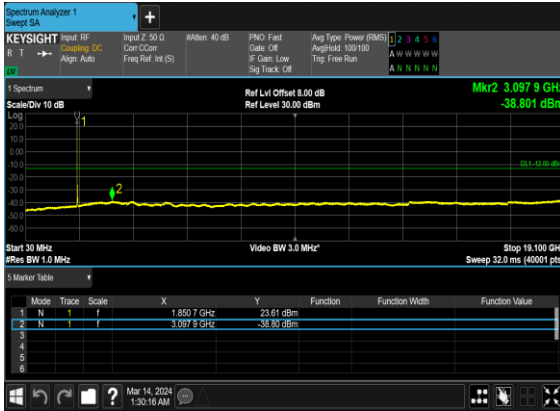

N2(20M)_DFT-s-OFDM_QPSK_Edge_1RB_Left_Low_CH

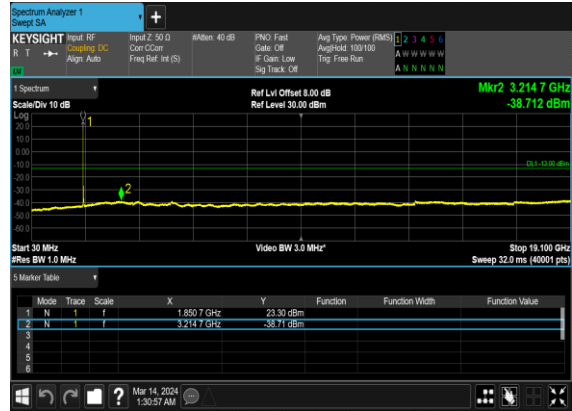

N2(20M)_DFT-s-OFDM_BPSK_Edge_1RB_Left_Mid_CH

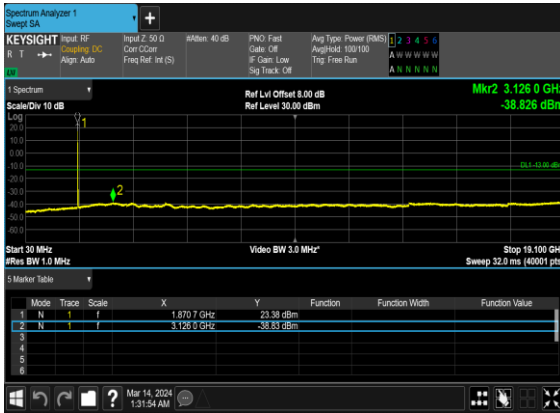

N2(20M)_DFT-s-OFDM_QPSK_Edge_1RB_Left_Mid_CH



N2(20M)_DFT-s-OFDM_BPSK_Edge_1RB_Left_High_CH



N2(20M)_DFT-s-OFDM_QPSK_Edge_1RB_Left_High_CH

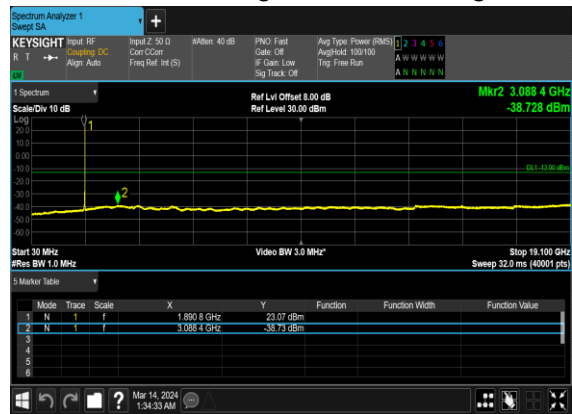

N2(40M)_DFT-s-
OFDM_BPSK_Edge_1RB_Left_Low_CH

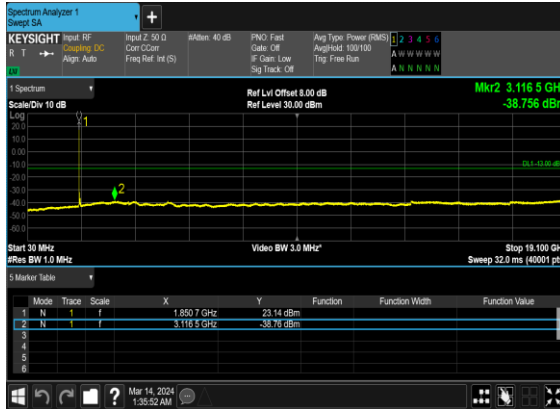

N2(40M)_DFT-s-
OFDM_QPSK_Edge_1RB_Left_Low_CH

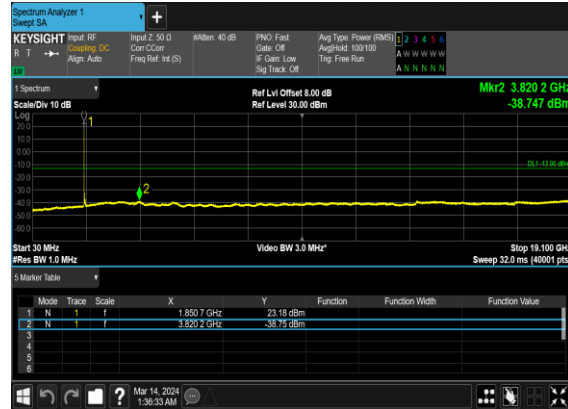

N2(40M)_DFT-s-
OFDM_BPSK_Edge_1RB_Left_Mid_CH

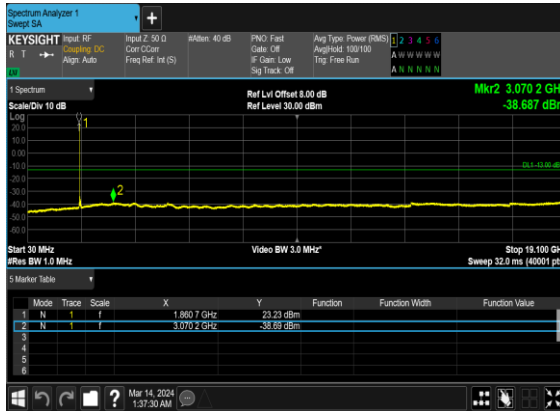

N2(40M)_DFT-s-
OFDM_QPSK_Edge_1RB_Left_Mid_CH

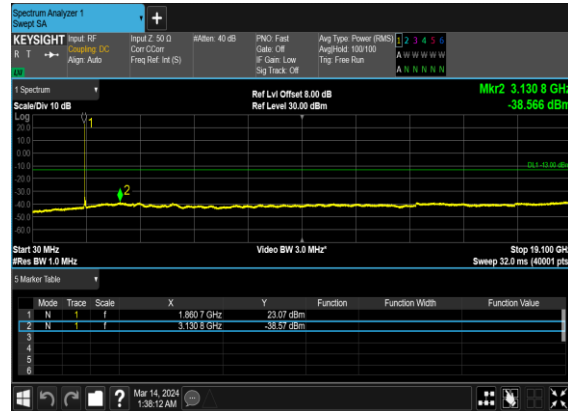

N2(40M)_DFT-s-
OFDM_BPSK_Edge_1RB_Left_High_CH

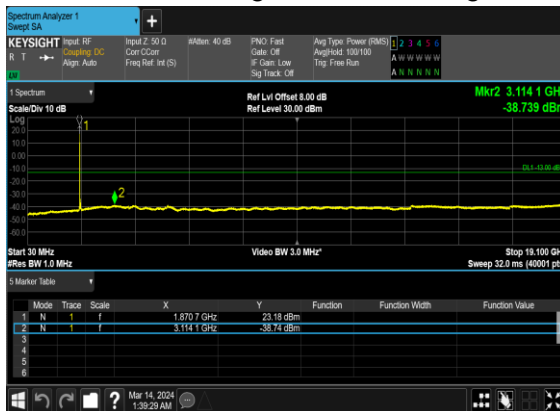

N2(40M)_DFT-s-
OFDM_QPSK_Edge_1RB_Left_High_CH

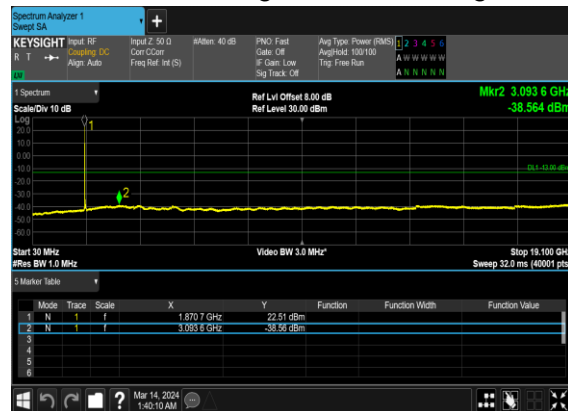

Conducted Band Edge

NR Band	SCS (kHz)	Bandwidth (MHz)	Arfcn	Freq (MHz)	Modulation	RB	Result	Verdict
2	15	5	370500	1852.5	DFT-s-OFDM BPSK	1@0	see graph	PASS
2	15	5	370500	1852.5	DFT-s-OFDM QPSK	1@0	see graph	PASS
2	15	5	370500	1852.5	DFT-s-OFDM BPSK	25@0	see graph	PASS
2	15	5	370500	1852.5	DFT-s-OFDM QPSK	25@0	see graph	PASS
2	15	5	381500	1907.5	DFT-s-OFDM BPSK	1@24	see graph	PASS
2	15	5	381500	1907.5	DFT-s-OFDM QPSK	1@24	see graph	PASS
2	15	5	381500	1907.5	DFT-s-OFDM BPSK	25@0	see graph	PASS
2	15	5	381500	1907.5	DFT-s-OFDM QPSK	25@0	see graph	PASS
2	15	20	372000	1860.0	DFT-s-OFDM BPSK	1@0	see graph	PASS
2	15	20	372000	1860.0	DFT-s-OFDM QPSK	1@0	see graph	PASS
2	15	20	372000	1860.0	DFT-s-OFDM BPSK	100@0	see graph	PASS
2	15	20	372000	1860.0	DFT-s-OFDM QPSK	100@0	see graph	PASS
2	15	20	380000	1900.0	DFT-s-OFDM BPSK	1@105	see graph	PASS
2	15	20	380000	1900.0	DFT-s-OFDM QPSK	1@105	see graph	PASS
2	15	20	380000	1900.0	DFT-s-OFDM BPSK	100@0	see graph	PASS
2	15	20	380000	1900.0	DFT-s-OFDM QPSK	100@0	see graph	PASS
2	15	40	374000	1870.0	DFT-s-OFDM BPSK	1@0	see graph	PASS
2	15	40	374000	1870.0	DFT-s-OFDM QPSK	1@0	see graph	PASS
2	15	40	374000	1870.0	DFT-s-OFDM BPSK	216@0	see graph	PASS
2	15	40	374000	1870.0	DFT-s-OFDM QPSK	216@0	see graph	PASS
2	15	40	378000	1890.0	DFT-s-OFDM BPSK	1@215	see graph	PASS
2	15	40	378000	1890.0	DFT-s-OFDM QPSK	1@215	see graph	PASS

2	15	40	378000	1890.0	DFT-s-OFDM BPSK	216@0	see graph	PASS
2	15	40	378000	1890.0	DFT-s-OFDM QPSK	216@0	see graph	PASS

N2(5M)_DFT-s-
OFDM_BPSK_Edge_1RB_Left_Low_CH

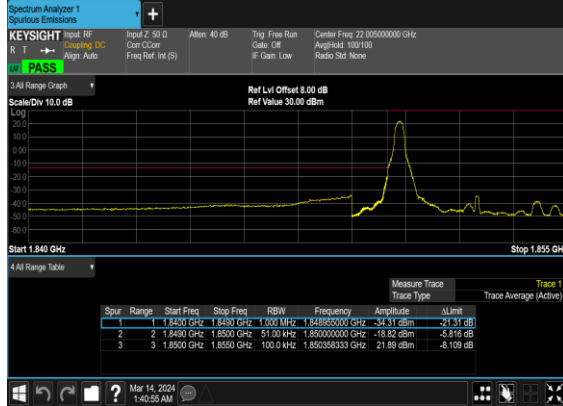

N2(5M)_DFT-s-
OFDM_QPSK_Edge_1RB_Left_Low_CH

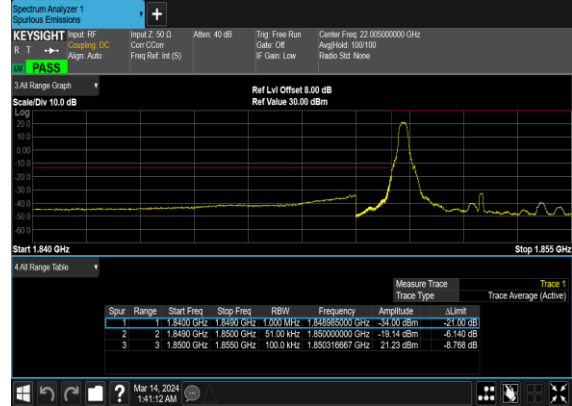

N2(5M)_DFT-s-
OFDM_BPSK_Outer_Full_Low_CH

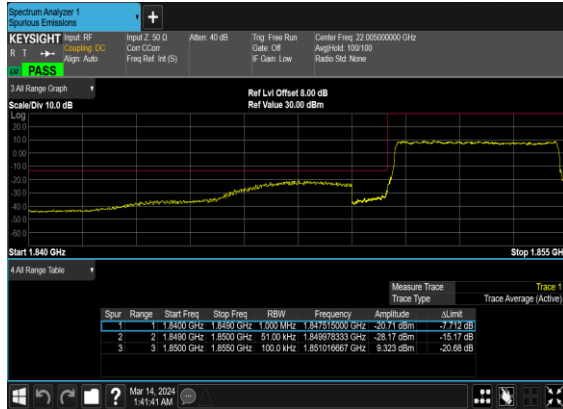

N2(5M)_DFT-s-
OFDM_QPSK_Outer_Full_Low_CH

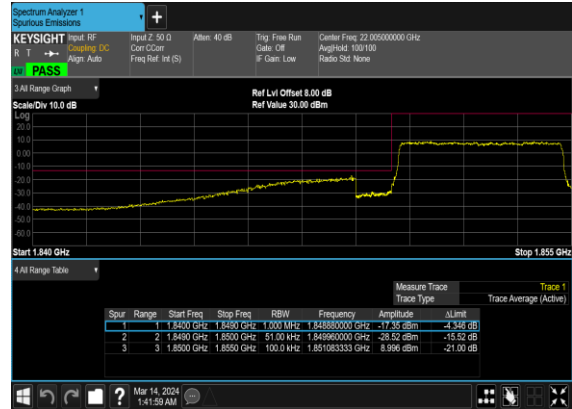

N2(5M)_DFT-s-
OFDM_BPSK_Edge_1RB_Right_High_CH

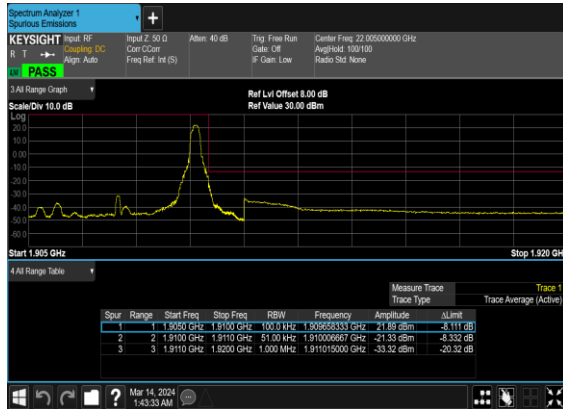

N2(5M)_DFT-s-
OFDM_QPSK_Edge_1RB_Right_High_CH

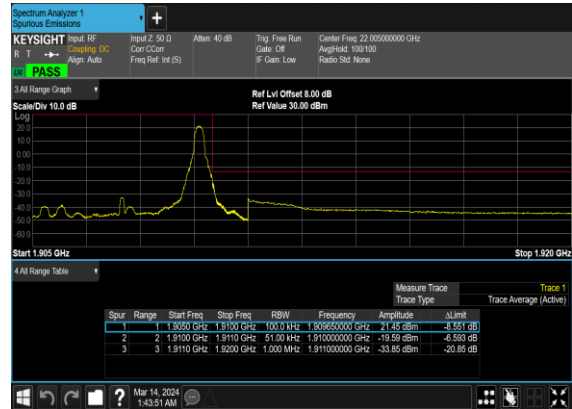

N2(5M)_DFT-s-OFDM_BPSK_Outer_Full_High_CH



N2(5M)_DFT-s-OFDM_QPSK_Outer_Full_High_CH



N2(20M)_DFT-s-OFDM_BPSK_Edge_1RB_Left_Low_CH

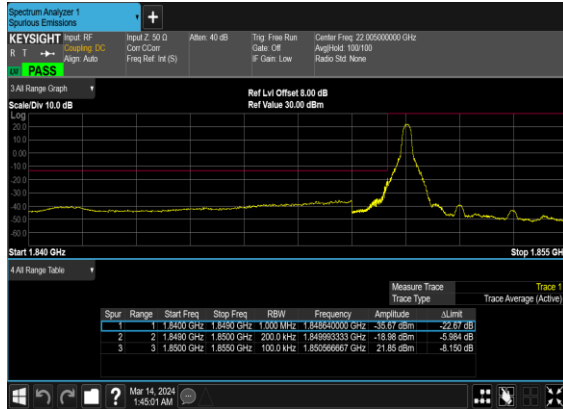

N2(20M)_DFT-s-OFDM_QPSK_Edge_1RB_Left_Low_CH

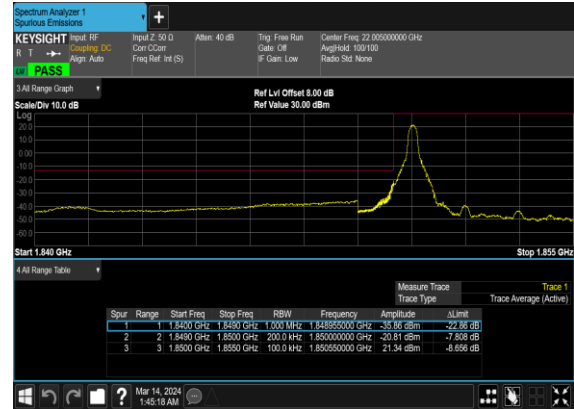

N2(20M)_DFT-s-OFDM_BPSK_Outer_Full_Low_CH

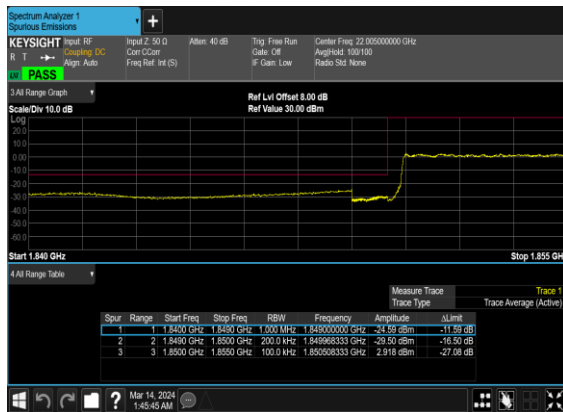

N2(20M)_DFT-s-OFDM_QPSK_Outer_Full_Low_CH

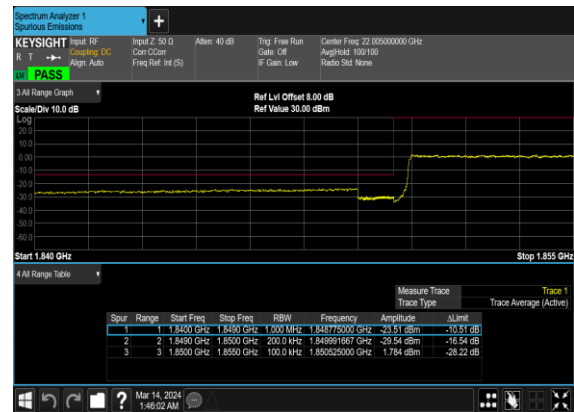

N2(20M)_DFT-s- OFDM_BPSK_Edge_1RB_Right_High_CH

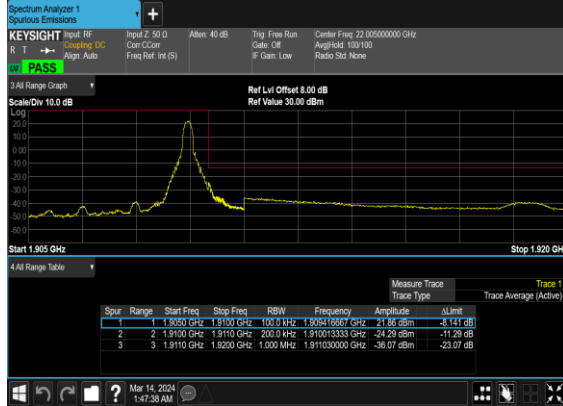

N2(20M)_DFT-s- OFDM_QPSK_Edge_1RB_Right_High_CH

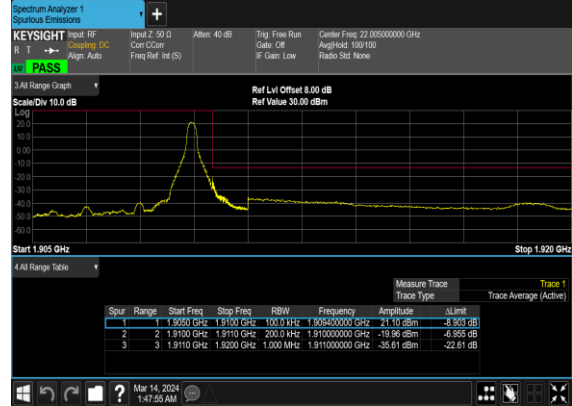

N2(20M)_DFT-s- OFDM_BPSK_Outer_Full_High_CH

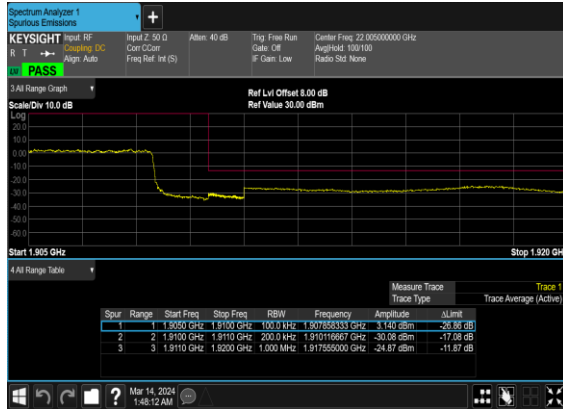

N2(20M)_DFT-s- OFDM_QPSK_Outer_Full_High_CH

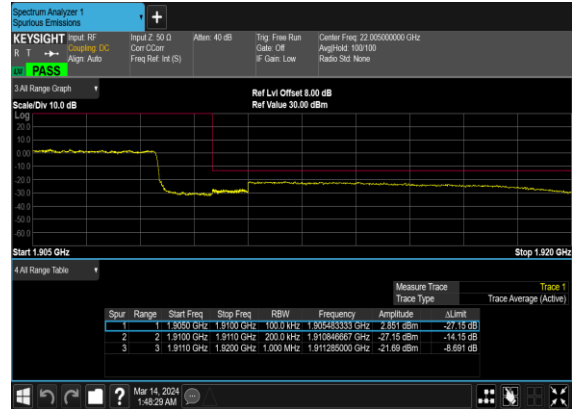

N2(40M)_DFT-s- OFDM_BPSK_Edge_1RB_Left_Low_CH

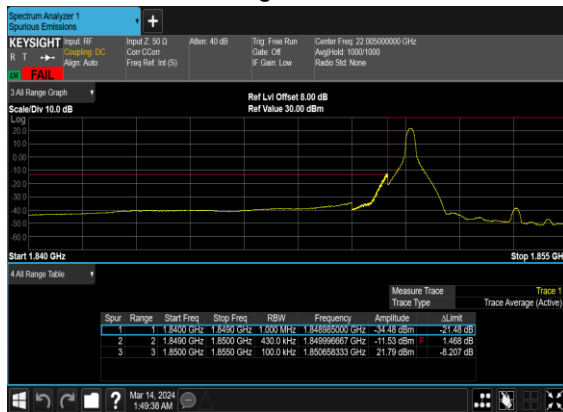

N2(40M)_DFT-s- OFDM_BPSK_Edge_1RB_Left_Low_CH_CHP_

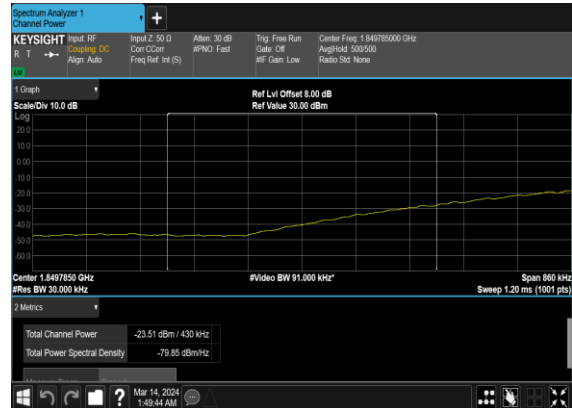

N2(40M)_DFT-s-
OFDM_QPSK_Edge_1RB_Left_Low_CH

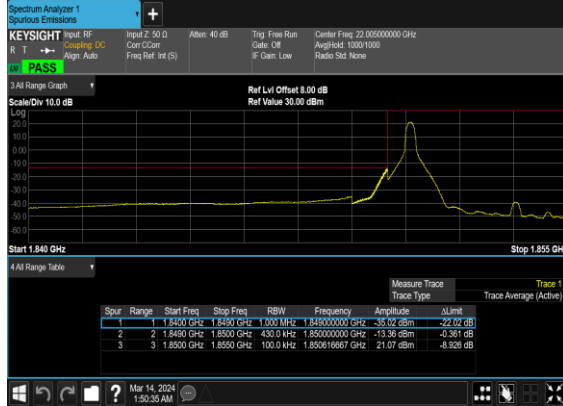

N2(40M)_DFT-s-
OFDM_BPSK_Outer_Full_Low_CH



N2(40M)_DFT-s-
OFDM_QPSK_Outer_Full_Low_CH

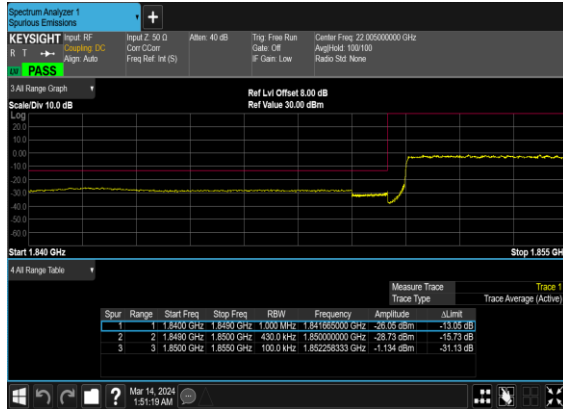

N2(40M)_DFT-s-
OFDM_BPSK_Edge_1RB_Right_High_CH

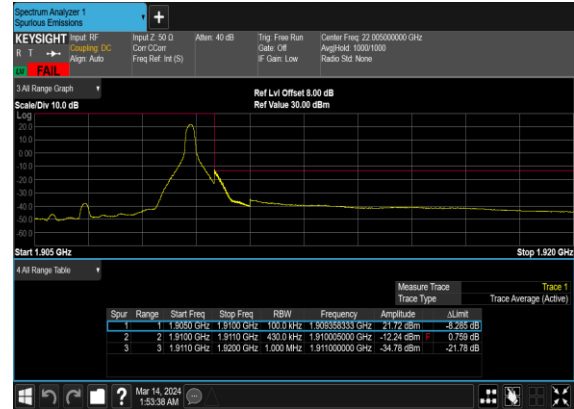

N2(40M)_DFT-s-
OFDM_BPSK_Edge_1RB_Right_High_CH_CHP
_PASS

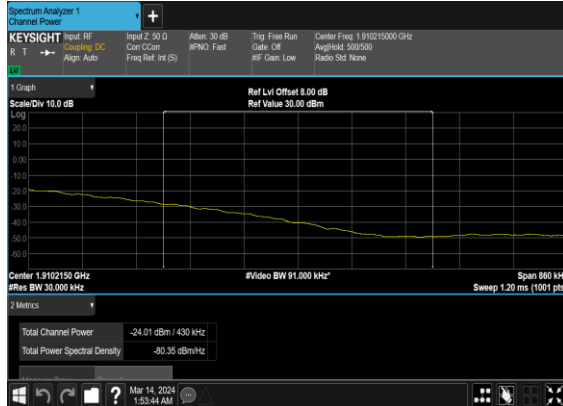

N2(40M)_DFT-s-
OFDM_QPSK_Edge_1RB_Right_High_CH

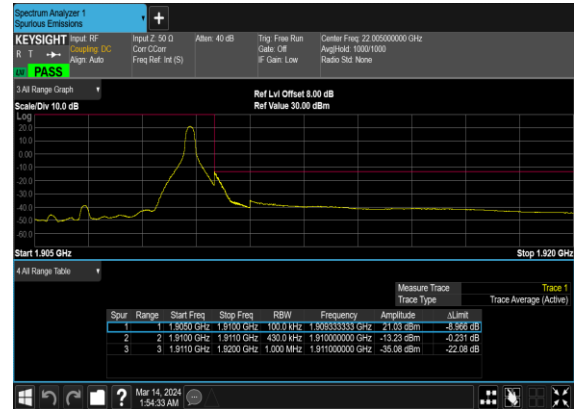

N2(40M)_DFT-s-OFDM_BPSK_Outer_Full_High_CH

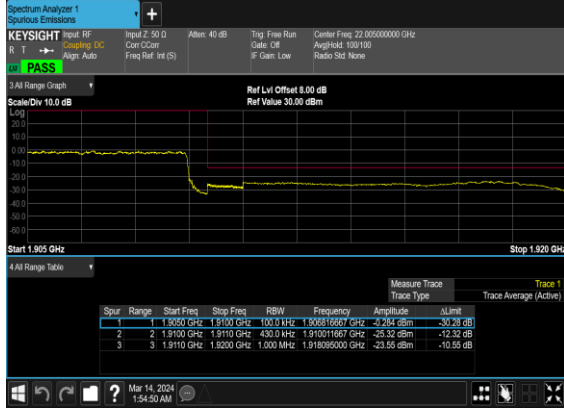

N2(40M)_DFT-s-OFDM_QPSK_Outer_Full_High_CH

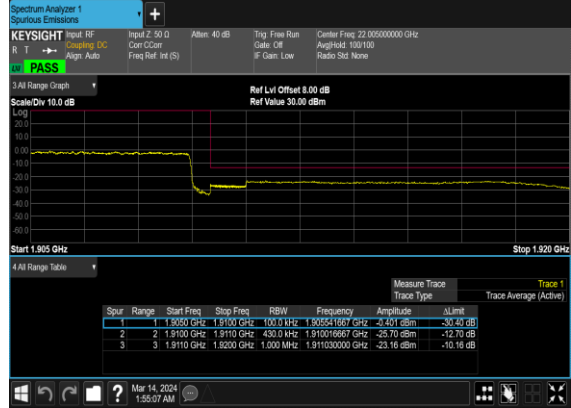

FR1 N5 (ANT0)

Transmitter Conducted Output Power And ERP, (G_T - L_C)=-4.3dB

NR Band	SCS (kHz)	Bandwidth (MHz)	Arfcn	Freq (MHz)	Modulation	RB	Conducted Power(dBm)	ERP (dBm)	ERP (W)
5	15	5	165300	826.5	DFT-s-OFDM QPSK	1@1	24.16	17.71	0.0590
5	15	5	165300	826.5	DFT-s-OFDM 16 QAM	1@1	23	16.55	0.0452
5	15	5	167300	836.5	DFT-s-OFDM QPSK	1@1	23.72	17.27	0.0533
5	15	5	167300	836.5	DFT-s-OFDM 16 QAM	1@1	22.95	16.5	0.0447
5	15	5	169300	846.5	DFT-s-OFDM QPSK	1@1	23.56	17.11	0.0514
5	15	5	169300	846.5	DFT-s-OFDM 16 QAM	1@1	22.81	16.36	0.0433
5	15	10	165800	829	DFT-s-OFDM QPSK	1@1	24.13	17.68	0.0586
5	15	10	165800	829	DFT-s-OFDM 16 QAM	1@1	22.95	16.5	0.0447
5	15	10	167300	836.5	DFT-s-OFDM QPSK	1@1	23.6	17.15	0.0519
5	15	10	167300	836.5	DFT-s-OFDM 16 QAM	1@1	22.94	16.49	0.0446
5	15	10	168800	844	DFT-s-OFDM QPSK	1@1	23.53	17.08	0.0511
5	15	10	168800	844	DFT-s-OFDM 16 QAM	1@1	22.81	16.36	0.0433
5	15	15	166300	831.5	DFT-s-OFDM QPSK	1@1	24.04	17.59	0.0574
5	15	15	166300	831.5	DFT-s-OFDM 16 QAM	1@1	22.83	16.38	0.0435
5	15	15	167300	836.5	DFT-s-OFDM QPSK	1@1	23.57	17.12	0.0515
5	15	15	167300	836.5	DFT-s-OFDM 16 QAM	1@1	22.89	16.44	0.0441
5	15	15	168300	841.5	DFT-s-OFDM QPSK	1@1	23.99	17.54	0.0568
5	15	15	168300	841.5	DFT-s-OFDM 16 QAM	1@1	22.96	16.51	0.0448
5	15	20	166800	834	DFT-s-OFDM QPSK	1@1	24.07	17.62	0.0578
5	15	20	166800	834	DFT-s-OFDM 16 QAM	1@1	22.84	16.39	0.0436
5	15	20	167300	836.5	DFT-s-OFDM QPSK	1@1	23.64	17.19	0.0524
5	15	20	167300	836.5	DFT-s-OFDM 16 QAM	1@1	22.86	16.41	0.0438
5	15	20	167800	839	DFT-s-OFDM QPSK	1@1	24.12	17.67	0.0585
5	15	20	167800	839	DFT-s-OFDM 16 QAM	1@1	22.87	16.42	0.0439
5	15	25	167300	836.5	DFT-s-OFDM PI/2 BPSK	64@32	23.82	17.37	0.0546
5	15	25	167300	836.5	DFT-s-OFDM PI/2 BPSK	1@1	23.64	17.19	0.0524
5	15	25	167300	836.5	DFT-s-OFDM PI/2 BPSK	1@131	23.56	17.11	0.0514
5	15	25	167300	836.5	DFT-s-OFDM QPSK	64@32	23.85	17.4	0.0550
5	15	25	167300	836.5	DFT-s-OFDM QPSK	1@1	24.17	17.72	0.0592
5	15	25	167300	836.5	DFT-s-OFDM QPSK	1@131	23.49	17.04	0.0506
5	15	25	167300	836.5	DFT-s-OFDM 16 QAM	64@32	22.89	16.44	0.0441
5	15	25	167300	836.5	DFT-s-OFDM 16 QAM	1@1	22.94	16.49	0.0446
5	15	25	167300	836.5	DFT-s-OFDM 16 QAM	1@131	22.95	16.5	0.0447
5	15	25	167300	836.5	DFT-s-OFDM 64 QAM	64@32	21.5	15.05	0.0320
5	15	25	167300	836.5	DFT-s-OFDM 64 QAM	1@1	21.2	14.75	0.0299
5	15	25	167300	836.5	DFT-s-OFDM 64 QAM	1@131	21.12	14.67	0.0293

5	15	25	167300	836.5	DFT-s-OFDM 256 QAM	64@32	19.48	13.03	0.0201
5	15	25	167300	836.5	DFT-s-OFDM 256 QAM	1@1	19.43	12.98	0.0199
5	15	25	167300	836.5	DFT-s-OFDM 256 QAM	1@131	19.36	12.91	0.0195
5	15	25	167300	836.5	CP-OFDM QPSK	67@33	22.42	15.97	0.0395
5	15	25	167300	836.5	CP-OFDM QPSK	1@1	22.49	16.04	0.0402
5	15	25	167300	836.5	CP-OFDM QPSK	1@131	22.16	15.71	0.0372

Frequency Stability

NR Band	SCS (kHz)	Bandwidth (MHz)	Arfcn	Freq (MHz)	Modulation	RB	Deviation (ppm)	Verdict	Environment
5	15	20	167300	836.5	DFT-s-OFDM QPSK	100@0	0.0067	PASS	NV
5	15	20	167300	836.5	DFT-s-OFDM QPSK	100@0	0.0067	PASS	LV
5	15	20	167300	836.5	DFT-s-OFDM QPSK	100@0	0.0028	PASS	HV
5	15	20	167300	836.5	DFT-s-OFDM QPSK	100@0	0.0041	PASS	-30°C
5	15	20	167300	836.5	DFT-s-OFDM QPSK	100@0	0.0042	PASS	-20°C
5	15	20	167300	836.5	DFT-s-OFDM QPSK	100@0	0.0038	PASS	-10°C
5	15	20	167300	836.5	DFT-s-OFDM QPSK	100@0	0.0037	PASS	0°C
5	15	20	167300	836.5	DFT-s-OFDM QPSK	100@0	0.0063	PASS	10°C
5	15	20	167300	836.5	DFT-s-OFDM QPSK	100@0	0.0067	PASS	20°C
5	15	20	167300	836.5	DFT-s-OFDM QPSK	100@0	0.0030	PASS	30°C
5	15	20	167300	836.5	DFT-s-OFDM QPSK	100@0	0.0065	PASS	40°C
5	15	20	167300	836.5	DFT-s-OFDM QPSK	100@0	0.0040	PASS	50°C

Peak to Average Ratio

NR Band	SCS (kHz)	Bandwidth (MHz)	Arfcn	Freq (MHz)	Modulation	RB	Result (dB)	Limit (dB)	Verdict
5	15	20	167300	836.5	DFT-s-OFDM PI/2 BPSK	100@0	4.1	13	PASS
5	15	20	167300	836.5	DFT-s-OFDM QPSK	100@0	4.85	13	PASS

N5(20M)_DFT-s-OFDM_PI_2-BPSK_Outer_Full_Mid_CH



N5(20M)_DFT-s-OFDM_QPSK_Outer_Full_Mid_CH

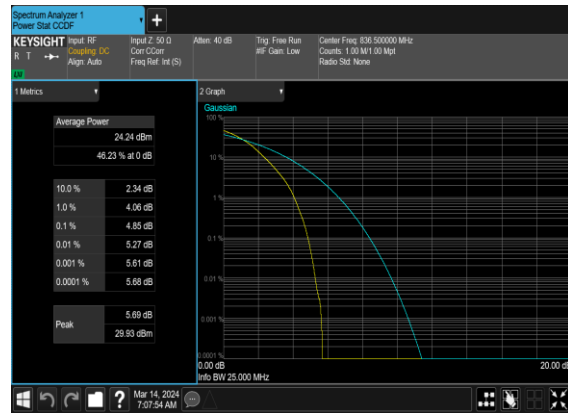

Occupied Bandwidth

NR Band	SCS (kHz)	Bandwidth (MHz)	Arfcn	Freq (MHz)	Modulation	RB	OBW (MHz)	26dB BW (MHz)
5	15	5	167300	836.5	CP-OFDM QPSK	25@0	4.4694	4.937
5	15	5	167300	836.5	CP-OFDM 16 QAM	25@0	4.4794	4.913
5	15	5	167300	836.5	CP-OFDM 64 QAM	25@0	4.4915	4.821
5	15	5	167300	836.5	CP-OFDM 256 QAM	25@0	4.4768	4.83
5	15	10	167300	836.5	CP-OFDM QPSK	52@0	9.3015	9.729
5	15	10	167300	836.5	CP-OFDM 16 QAM	52@0	9.2954	9.736
5	15	10	167300	836.5	CP-OFDM 64 QAM	52@0	9.2956	9.661
5	15	10	167300	836.5	CP-OFDM 256 QAM	52@0	9.2802	9.705
5	15	15	167300	836.5	CP-OFDM QPSK	79@0	14.11	14.64
5	15	15	167300	836.5	CP-OFDM 16 QAM	79@0	14.133	14.76
5	15	15	167300	836.5	CP-OFDM 64 QAM	79@0	14.162	14.74
5	15	15	167300	836.5	CP-OFDM 256 QAM	79@0	14.131	14.71
5	15	20	167300	836.5	CP-OFDM QPSK	106@0	18.934	21.39
5	15	20	167300	836.5	CP-OFDM 16 QAM	106@0	18.972	21.43
5	15	20	167300	836.5	CP-OFDM 64 QAM	106@0	18.937	19.67
5	15	20	167300	836.5	CP-OFDM 256 QAM	106@0	18.915	19.7
5	15	25	167300	836.5	CP-OFDM QPSK	133@0	23.829	27.11
5	15	25	167300	836.5	CP-OFDM 16 QAM	133@0	23.82	25.78
5	15	25	167300	836.5	CP-OFDM 64 QAM	133@0	23.813	24.7
5	15	25	167300	836.5	CP-OFDM 256 QAM	133@0	23.777	24.65

N5(5M)_CP-OFDM_QPSK_Outer_Full_Mid_CH

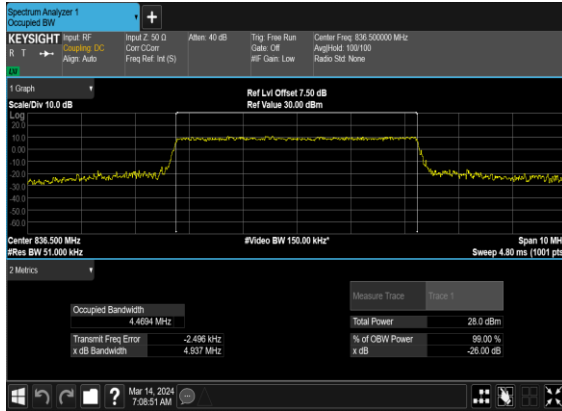

N5(5M)_CP-OFDM_16QAM_Outer_Full_Mid_CH

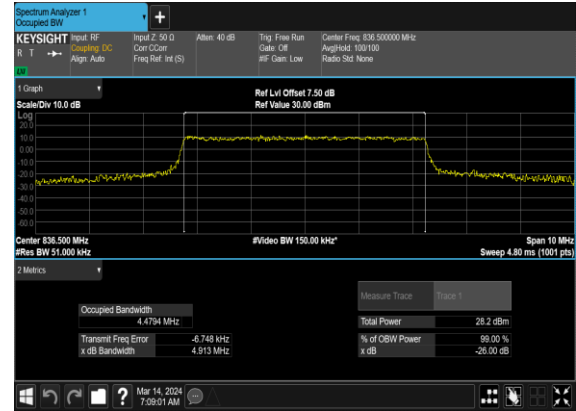

N5(5M)_CP-OFDM_64QAM_Outer_Full_Mid_CH



N5(5M)_CP-OFDM_256QAM_Outer_Full_Mid_CH



N5(10M)_CP-OFDM_QPSK_Outer_Full_Mid_CH

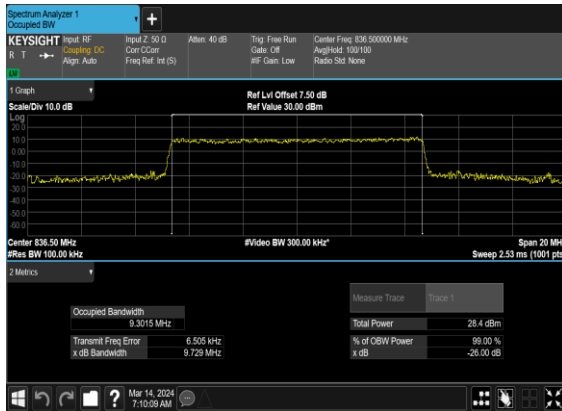

N5(10M)_CP-OFDM_16QAM_Outer_Full_Mid_CH

