



No. 23T04Z80397-013



SAR TEST REPORT

No. 23T04Z80397-013

For

TCL Communication Ltd.

GSM/UMTS/LTE Mobile phone

Model name: T435D,T435SP,T435S,T435V,T435WS

With

Hardware Version: 03

Software Version: 9JS6

FCC ID: 2ACCJH178

Issued Date: 2024-01-19

Note:

The test results in this test report relate only to the devices specified in this report. This report shall not be reproduced except in full without the written approval of CTTL.

Test Laboratory:

CTTL, Telecommunication Technology Labs, CAICT

No. 52, Huayuan North Road, Haidian District, Beijing, P. R. China 100191.

Tel:+86(0)10-62304633-2512, Fax:+86(0)10-62304633-2504

Email: ctl_terminals@caict.ac.cn, website: www.caict.ac.cn



No. 23T04Z80397-013

REPORT HISTORY

Report Number	Revision	Issue Date	Description
23T04Z80397-013	Rev.0	2024-01-19	Initial creation of test report

TABLE OF CONTENT

1 TEST LABORATORY	5
1.1. INTRODUCTION & ACCREDITATION.....	5
1.2. TESTING LOCATION.....	5
1.3. TESTING ENVIRONMENT.....	5
1.4. PROJECT DATA	5
1.5. SIGNATURE.....	5
2 STATEMENT OF COMPLIANCE	6
3 CLIENT INFORMATION.....	8
3.1 APPLICANT INFORMATION	8
3.2 MANUFACTURER INFORMATION	8
4 EQUIPMENT UNDER TEST (EUT) AND ANCILLARY EQUIPMENT (AE)	9
4.1 ABOUT EUT	9
4.2 INTERNAL IDENTIFICATION OF EUT USED DURING THE TEST	9
4.3 INTERNAL IDENTIFICATION OF AE USED DURING THE TEST.....	9
5 TEST METHODOLOGY	10
5.1 APPLICABLE LIMIT REGULATIONS	10
5.2 APPLICABLE MEASUREMENT STANDARDS.....	10
6 SPECIFIC ABSORPTION RATE (SAR).....	11
6.1 INTRODUCTION.....	11
6.2 SAR DEFINITION.....	11
7 TISSUE SIMULATING LIQUIDS	12
7.1 TARGETS FOR TISSUE SIMULATING LIQUID	12
7.2 DIELECTRIC PERFORMANCE	12
8 SYSTEM VERIFICATION.....	14
8.1 SYSTEM SETUP.....	14
8.2 SYSTEM VERIFICATION.....	15
9 MEASUREMENT PROCEDURES	16
9.1 TESTS TO BE PERFORMED	16
9.2 GENERAL MEASUREMENT PROCEDURE.....	18
9.3 WCDMA MEASUREMENT PROCEDURES FOR SAR	19
9.4 SAR MEASUREMENT FOR LTE.....	20
9.5 BLUETOOTH & WI-FI MEASUREMENT PROCEDURES FOR SAR	22
9.6 POWER DRIFT.....	22
10 AREA SCAN BASED 1-G SAR	23



10.1 REQUIREMENT OF KDB.....	23
10.2 FAST SAR ALGORITHMS	23
11 CONDUCTED OUTPUT POWER.....	24
11.1 GSM MEASUREMENT RESULT	24
11.2 WCDMA MEASUREMENT RESULT.....	26
11.3 LTE MEASUREMENT RESULT	29
11.4 WI-FI AND BT MEASUREMENT RESULT	103
12 ANTENNA LOCATION.....	105
12.1 TRANSMIT ANTENNA SEPARATION DISTANCES	105
12.2 EVALUATION OF SIMULTANEOUS	105
13 SAR TEST RESULT.....	106
13.1 SAR RESULTS	107
13.2 SAR RESULTS FOR WLAN	114
14 SAR MEASUREMENT VARIABILITY.....	116
15 MEASUREMENT UNCERTAINTY	117
15.1 MEASUREMENT UNCERTAINTY FOR NORMAL SAR TESTS (300MHZ~3GHZ)	117
15.2 MEASUREMENT UNCERTAINTY FOR FAST SAR TESTS (300MHZ~3GHZ)	118
16 MAIN TEST INSTRUMENTS	119
ANNEX A GRAPH RESULTS.....	120
ANNEX B SYSTEM VERIFICATION RESULTS.....	168
ANNEX C SAR MEASUREMENT SETUP	174
ANNEX D POSITION OF THE WIRELESS DEVICE IN RELATION TO THE PHANTOM	179
ANNEX E EQUIVALENT MEDIA RECIPES	183
ANNEX F SYSTEM VALIDATION	184
ANNEX G PROBE CALIBRATION CERTIFICATE	185
ANNEX H DIPOLE CALIBRATION CERTIFICATE.....	194
ANNEX I ACCREDITATION CERTIFICATE.....	230

1 Test Laboratory

1.1. Introduction & Accreditation

Telecommunication Technology Labs, CAICT is an ISO/IEC 17025:2017 accredited test laboratory under American Association for Laboratory Accreditation (A2LA) with lab code 7049.01, and is also an FCC accredited test laboratory (CN1349), and ISED accredited test laboratory (CAB identifier:CN0066). The detail accreditation scope can be found on A2LA website.

1.2. Testing Location

Location 1: CTTL(huayuan North Road)

Address: No. 52, Huayuan North Road, Haidian District, Beijing,
P. R. China 100191

1.3. Testing Environment

Normal Temperature: 15-35°C
Extreme Temperature: -10/+55°C
Relative Humidity: 20-75%

1.4. Project data

Testing Start Date: 2024-01-01
Testing End Date: 2024-01-19

1.5. Signature

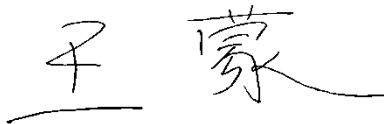

Wang Meng
(Prepared this test report)

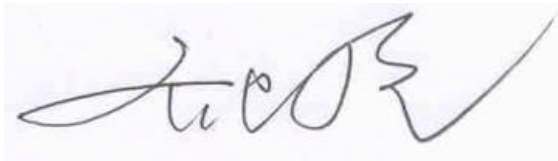

Qi Dianyuan
(Reviewed this test report)

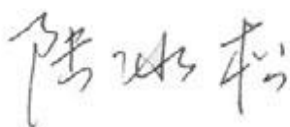

Lu Bingsong
Deputy Director of the laboratory
(Approved this test report)

2 Statement of Compliance

The maximum results of Specific Absorption Rate (SAR) found during testing for TCL Communication Ltd. GSM/UMTS/LTE mobile phone T435D,T435SP,T435S,T435V,T435WS are as follows:

Table 2.1: Highest Reported SAR -Standalone(1g)

Mode		Highest Reported SAR (1g)		
		1g SAR Head	1g SAR Hotspot 10mm	1g SAR Body-worn 15mm
GSM	GSM 850	0.47	0.65	0.48
	PCS 1900	0.18	0.81	0.51
WCDMA	UMTS FDD 2	<0.01	0.73	0.53
	UMTS FDD 4	0.27	0.81	0.46
	UMTS FDD 5	0.68	0.86	0.67
LTE	LTE Band 2	1.35	0.74	0.75
	LTE Band 4	0.32	0.77	0.55
	LTE Band 5	0.74	0.65	0.47
	LTE Band 12	0.39	0.54	0.38
	LTE Band 13	0.38	0.75	0.57
	LTE Band 25	1.36	0.74	0.79
	LTE Band 26	0.94	0.94	0.60
	LTE Band 41 PC2	0.21	0.21	0.16
	LTE Band 41 PC3	0.11	0.49	0.28
	LTE Band 66	0.26	0.91	0.62
LTE Band 71	0.26	0.31	0.20	
WLAN 2.4 GHz		0.47	0.53	0.32
BT		0.03	<0.01	<0.01

Note1: SAR result at 10mm is used for conservative evaluation.

The SAR values found for the Mobile Phone are below the maximum recommended levels of 1.6 W/kg as averaged over any 1g tissue according to the ANSI C95.1-1992.

For body operation, this device has been tested and meets FCC RF exposure guidelines when used with any accessory that contains no metal and which provides a minimum separation distance of 10 mm for hotspot and 15mm for body worn between this device and the body of the user. Use of other accessories may not ensure compliance with FCC RF exposure guidelines.

The EUT battery must be fully charged and checked periodically during the test to ascertain uniform power output.

The measurement together with the test system set-up is described in annex C. A detailed description of the equipment under test can be found in chapter 4 of this test report. The highest reported SAR value is obtained at the case of **(Table 2.1)**, and the values are:

Head: 1.36 W/kg(1g).

Hotspot:0.94W/kg(1g)

Body worn:0.79 W/kg(1g).

Table 2.2: The sum of SAR values for Main antenna + WiFi

	Position	Main antenna	WiFi 2.4G	Sum
Highest SAR value for Head	Left head, Cheek (LTE Band 25)	1.36	0.20	1.56

According to the above tables, The sum of reported SAR values is 1.6W/kg. So the simultaneous transmission SAR with volume scans is not required.

According to the above tables, the highest sum of reported SAR values is **1.56W/kg (1g)**.The detail for simultaneous transmission consideration is described in chapter 12.2.



3 Client Information

3.1 Applicant Information

Company Name:	TCL Communication Ltd.
Address /Post:	5/F, Building 22E, 22 Science Park East Avenue, Hong Kong Science Park, Shatin, NT, Hong Kong
Contact Person:	Annie Jiang
E-mail:	nianxiang.jiang@tcl.com
Telephone:	0086-755-3661 1621
Fax:	0086-755-36612000-81722

3.2 Manufacturer Information

Company Name:	TCL Communication Ltd.
Address /Post:	5/F, Building 22E, 22 Science Park East Avenue, Hong Kong Science Park, Shatin, NT, Hong Kong
Contact Person:	Annie Jiang
E-mail:	nianxiang.jiang@tcl.com
Telephone:	0086-755-3661 1621
Fax:	0086-755-36612000-81722

4 Equipment Under Test (EUT) and Ancillary Equipment (AE)

4.1 About EUT

Description:	GSM/UMTS/LTE mobile phone
Model name:	T435D,T435SP,T435S,T435V,T435WS
Tested Band:	GSM850/1900, WCDMA B2/4/5 LTE Band FDD:2/4/5/12/13/25/26/41/66/71 BT, Wi-Fi(2.4G)
Tested Tx Frequency:	824 – 849 MHz (GSM 850)
	1850 – 1910 MHz (GSM 1900)
	824–849 MHz (WCDMA 850 Band V)
	1710 – 1755 MHz (WCDMA 1700 Band IV)
	1850–1910 MHz (WCDMA1900 Band II)
	1850 – 1910 MHz(LTE Band 2)
	1710 – 1755 MHz (LTE Band 4)
	824 – 849 MHz (LTE Band 5)
	699 – 716 MHz (LTE Band 12)
	777 –787 MHz (LTE Band 13)
	1850 – 1915 MHz(LTE Band 25)
	814 – 849 MHz (LTE Band 26)
	2496 – 2690 MHz (LTE Band 41)
	1710 – 1780 MHz (LTE Band 66)
	663 – 698 MHz (LTE Band 71)
2402 – 2480 MHz (Bluetooth)	
2412 – 2462 MHz (Wi-Fi 2.4G)	
GPRS/EGPRS Multislot Class:	12
GPRS capability Class:	B
Antenna type:	Integrated antenna
Hotspot mode:	Support

4.2 Internal Identification of EUT used during the test

EUT ID*	IMEI	HW	SW Version
EUT1	016495000011605	03	9JS6
EUT2	016495000011290	03	9JS6
EUT3	016495000011639	03	9JS6

*EUT ID: is used to identify the test sample in the lab internally.

Note: It is performed to test SAR with the EUT1&2 and conducted power with the EUT3.

4.3 Internal Identification of AE used during the test

AE ID*	Description	Model	SN	Manufacturer
AE1	Battery	TLi017D7	/	Veken
AE2	Battery	TLi017DA	/	TIANMAO

*AE ID: is used to identify the test sample in the lab internally.

5 TEST METHODOLOGY

5.1 Applicable Limit Regulations

ANSI C95.1–1992: IEEE Standard for Safety Levels with Respect to Human Exposure to Radio Frequency Electromagnetic Fields, 3 kHz to 300 GHz.

It specifies the maximum exposure limit of **1.6 W/kg** as averaged over any 1 gram of tissue for portable devices being used within 20 cm of the user in the uncontrolled environment.

5.2 Applicable Measurement Standards

IEEE 1528–2013: Recommended Practice for Determining the Peak Spatial-Average Specific Absorption Rate (SAR) in the Human Head from Wireless Communications Devices: Measurement Techniques.

KDB447498 D01: General RF Exposure Guidance v06: Mobile and Portable Devices RF Exposure Procedures and Equipment Authorization Policies.

KDB648474 D04 Handset SAR v01r03: SAR Evaluation Considerations for Wireless Handsets.

KDB941225 D01 SAR test for 3G devices v03r01: SAR Measurement Procedures for 3G Devices

KDB941225 D05 SAR for LTE Devices v02r05: SAR Evaluation Considerations for LTE Devices

KDB941225 D06 Hotspot Mode SAR v02r01: SAR Evaluation Procedures for Portable Devices with Wireless Router Capabilities

KDB248227 D01 802.11 Wi-Fi SAR v02r02: SAR GUIDANCE FOR IEEE 802.11 (Wi-Fi) TRANSMITTERS

KDB865664 D01 SAR measurement 100 MHz to 6 GHz v01r04: SAR Measurement Requirements for 100 MHz to 6 GHz.

KDB865664 D02 RF Exposure Reporting v01r02: RF Exposure Compliance Reporting and Documentation Considerations

6 Specific Absorption Rate (SAR)

6.1 Introduction

SAR is related to the rate at which energy is absorbed per unit mass in an object exposed to a radio field. The SAR distribution in a biological body is complicated and is usually carried out by experimental techniques or numerical modeling. The standard recommends limits for two tiers of groups, occupational/controlled and general population/uncontrolled, based on a person's awareness and ability to exercise control over his or her exposure. In general, occupational/controlled exposure limits are higher than the limits for general population/uncontrolled.

6.2 SAR Definition

The SAR definition is the time derivative (rate) of the incremental energy (dW) absorbed by (dissipated in) an incremental mass (dm) contained in a volume element (dv) of a given density (ρ). The equation description is as below:

$$SAR = \frac{d}{dt} \left(\frac{dW}{dm} \right) = \frac{d}{dt} \left(\frac{dW}{\rho dv} \right)$$

SAR is expressed in units of Watts per kilogram (W/kg)

SAR measurement can be either related to the temperature elevation in tissue by

$$SAR = c \left(\frac{\delta T}{\delta t} \right)$$

Where: C is the specific heat capacity, δT is the temperature rise and δt is the exposure duration, or related to the electrical field in the tissue by

$$SAR = \frac{\sigma |E|^2}{\rho}$$

Where: σ is the conductivity of the tissue, ρ is the mass density of tissue and E is the RMS electrical field strength.

However for evaluating SAR of low power transmitter, electrical field measurement is typically applied.

7 Tissue Simulating Liquids

The temperature of the tissue-equivalent medium used during measurement must also be within 18 °C to 25 °C and within ± 2 °C of the temperature when the tissue parameters are characterized. The dielectric parameters must be measured before the tissue-equivalent medium is used in a series of SAR measurements. The parameters should be re-measured after each 3 – 4 days of use; or earlier if the dielectric parameters can become out of tolerance; for example, when the parameters are marginal at the beginning of the measurement series.

The dielectric constant (ϵ_r) and conductivity (σ) of typical tissue-equivalent media recipes are expected to be within $\pm 5\%$ of the required target values; but for SAR measurement systems that have implemented the SAR error compensation algorithms documented in IEEE Std 1528-2013, to automatically compensate the measured SAR results for deviations between the measured and required tissue dielectric parameters, the tolerance for ϵ_r and σ may be relaxed to $\pm 10\%$. This is limited to frequencies ≤ 3 GHz.

7.1 Targets for tissue simulating liquid

Table 7.1: Targets for tissue simulating liquid

Frequency(MHz)	Liquid Type	Conductivity(σ)	$\pm 5\%$ Range	Permittivity(ϵ)	$\pm 5\%$ Range
750	Head	0.89	0.85~0.93	41.94	39.8~44.0
835	Head	0.90	0.86~0.95	41.5	39.4~43.6
1750	Head	1.37	1.30~1.44	40.08	38.1~42.1
1900	Head	1.40	1.33~1.47	40.0	38.0~42.0
2450	Head	1.80	1.62~1.98	39.2	35.28~43.12
2600	Head	1.96	1.76~2.16	39.01	35.11~42.91

7.2 Dielectric Performance

Table 7.2: Dielectric Performance of Tissue Simulating Liquid

Measurement Date (yyyy-mm-dd)	Type	Frequency	Permittivity ϵ	Drift (%)	Conductivity σ (S/m)	Drift (%)
2024/1/1	Head	750MHz	44.99	7.27	0.8315	-6.57
2024/1/4	Head	835MHz	44.69	7.69	0.8727	-3.03
2024/1/7	Head	1750MHz	42.13	5.11	1.381	0.80
2024/1/10	Head	1900MHz	41.85	4.63	1.483	5.93
2024/1/12	Head	2450MHz	40.7	3.83	1.908	6.00
2024/1/14	Head	2600MHz	40.49	3.79	2.05	4.59

Note: The liquid temperature is 22.0 °C

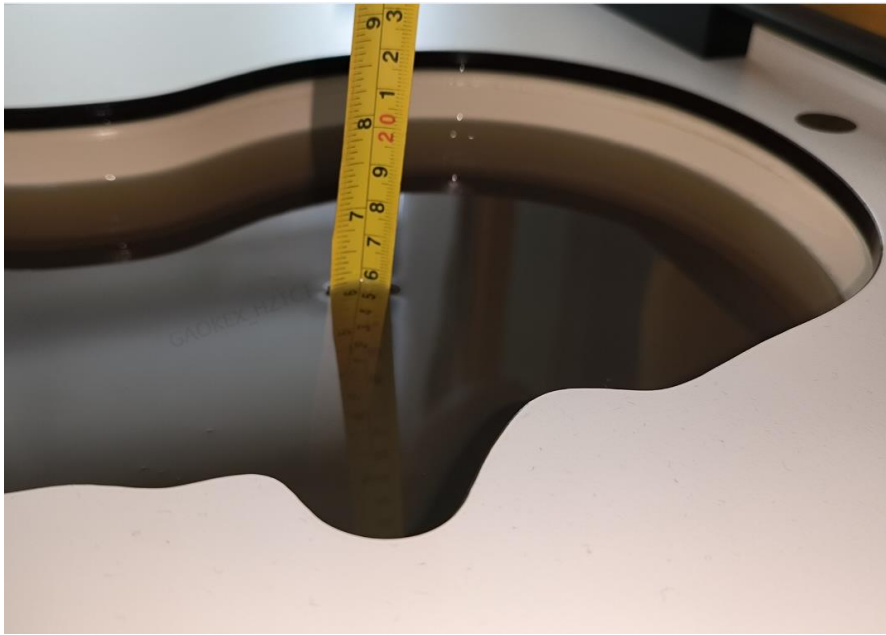

Picture 7-1 Liquid depth in the Head Phantom

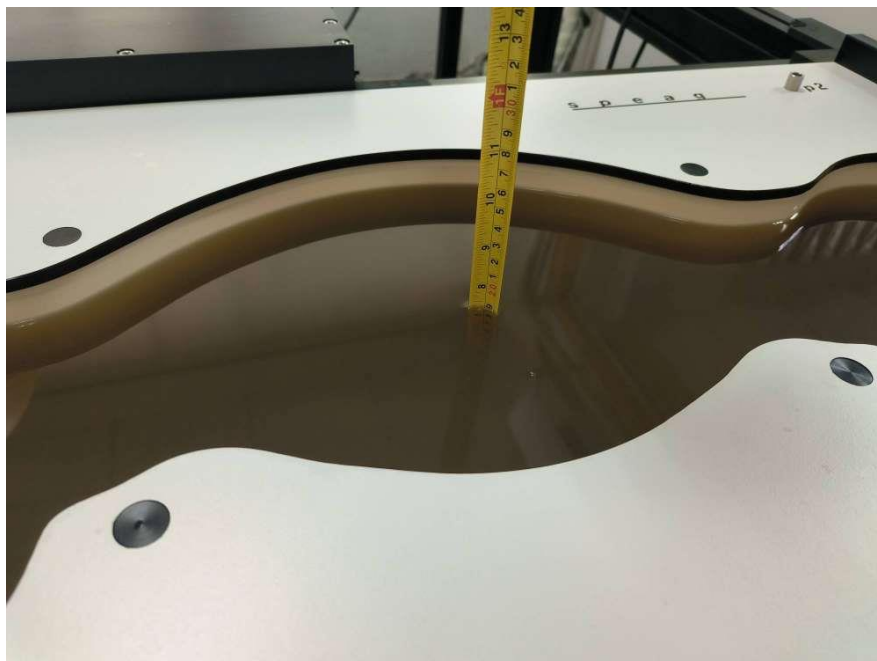

Picture 7-2 Liquid depth in the Flat Phantom

8 System verification

8.1 System Setup

In the simplified setup for system evaluation, the DUT is replaced by a calibrated dipole and the power source is replaced by a continuous wave that comes from a signal generator. The calibrated dipole must be placed beneath the flat phantom section of the SAM twin phantom with the correct distance holder. The distance holder should touch the phantom surface with a light pressure at the reference marking and be oriented parallel to the long side of the phantom. The equipment setup is shown below:

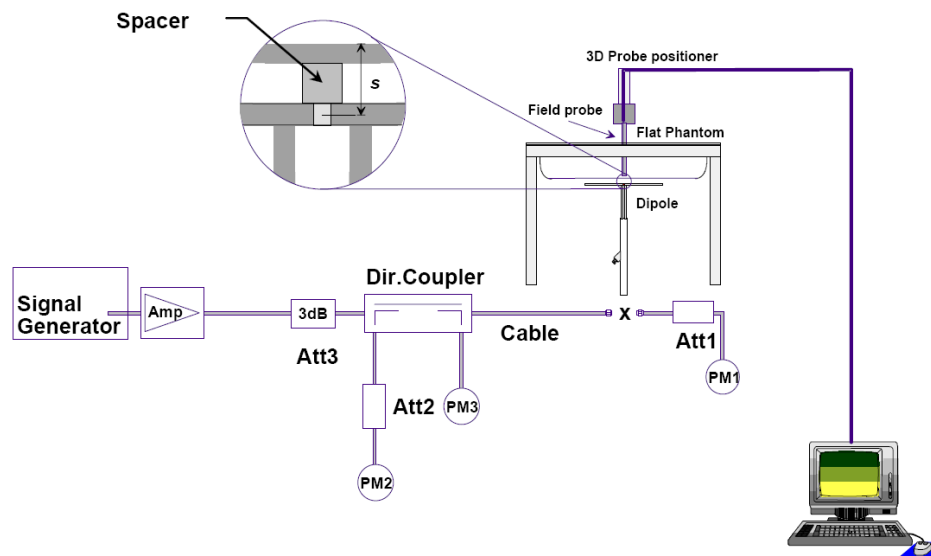

Picture 8.1 System Setup for System Evaluation

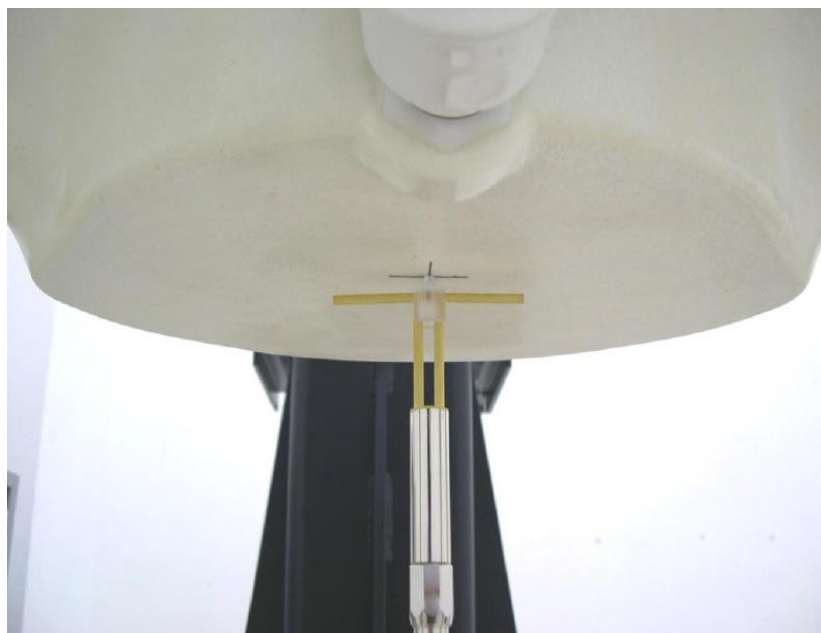

Picture 8.2 Photo of Dipole Setup

8.2 System Verification

SAR system verification is required to confirm measurement accuracy, according to the tissue dielectric media, probe calibration points and other system operating parameters required for measuring the SAR of a test device. The system verification must be performed for each frequency band and within the valid range of each probe calibration point required for testing the device.

Table 9.1: System Verification of Head

Measurement Date (yyyy-mm-dd)	Frequency	Target value (W/kg)		Measured value(W/kg)		Deviation	
		10 g Average	1 g Average	10 g Average	1 g Average	10 g Average	1 g Average
2024/1/1	750 MHz	5.54	8.48	5.21	9.07	-6.00%	7.00%
2024/1/4	835 MHz	6.32	9.55	6.51	9.84	3.00%	3.00%
2024/1/7	1750 MHz	18.9	35.8	18.3	36.9	-3.00%	3.00%
2024/1/10	1900 MHz	21.0	40.4	21.8	43.6	4.00%	7.92%
2024/1/12	2450 MHz	24.5	52.4	26.0	54.4	6.00%	3.82%
2024/1/14	2600 MHz	25.2	55.8	27.2	57.2	8.00%	2.51%

9 Measurement Procedures

9.1 Tests to be performed

In order to determine the highest value of the peak spatial-average SAR of a handset, all device positions, configurations and operational modes shall be tested for each frequency band according to steps 1 to 3 below. A flowchart of the test process is shown in picture 9.1.

Step 1: The tests described in 9.2 shall be performed at the channel that is closest to the centre of the transmit frequency band (f_c) for:

- a) all device positions (cheek and tilt, for both left and right sides of the SAM phantom, as described in annex D),
- b) all configurations for each device position in a), e.g., antenna extended and retracted, and
- c) all operational modes, e.g., analogue and digital, for each device position in a) and configuration in b) in each frequency band.

If more than three frequencies need to be tested according to 11.1 (i.e., $N_c > 3$), then all frequencies, configurations and modes shall be tested for all of the above test conditions.

Step 2: For the condition providing highest peak spatial-average SAR determined in Step 1, perform all tests described in 9.2 at all other test frequencies, i.e., lowest and highest frequencies. In addition, for all other conditions (device position, configuration and operational mode) where the peak spatial-average SAR value determined in Step 1 is within 3 dB of the applicable SAR limit, it is recommended that all other test frequencies shall be tested as well.

Step 3: Examine all data to determine the highest value of the peak spatial-average SAR found in Steps 1 to 2.

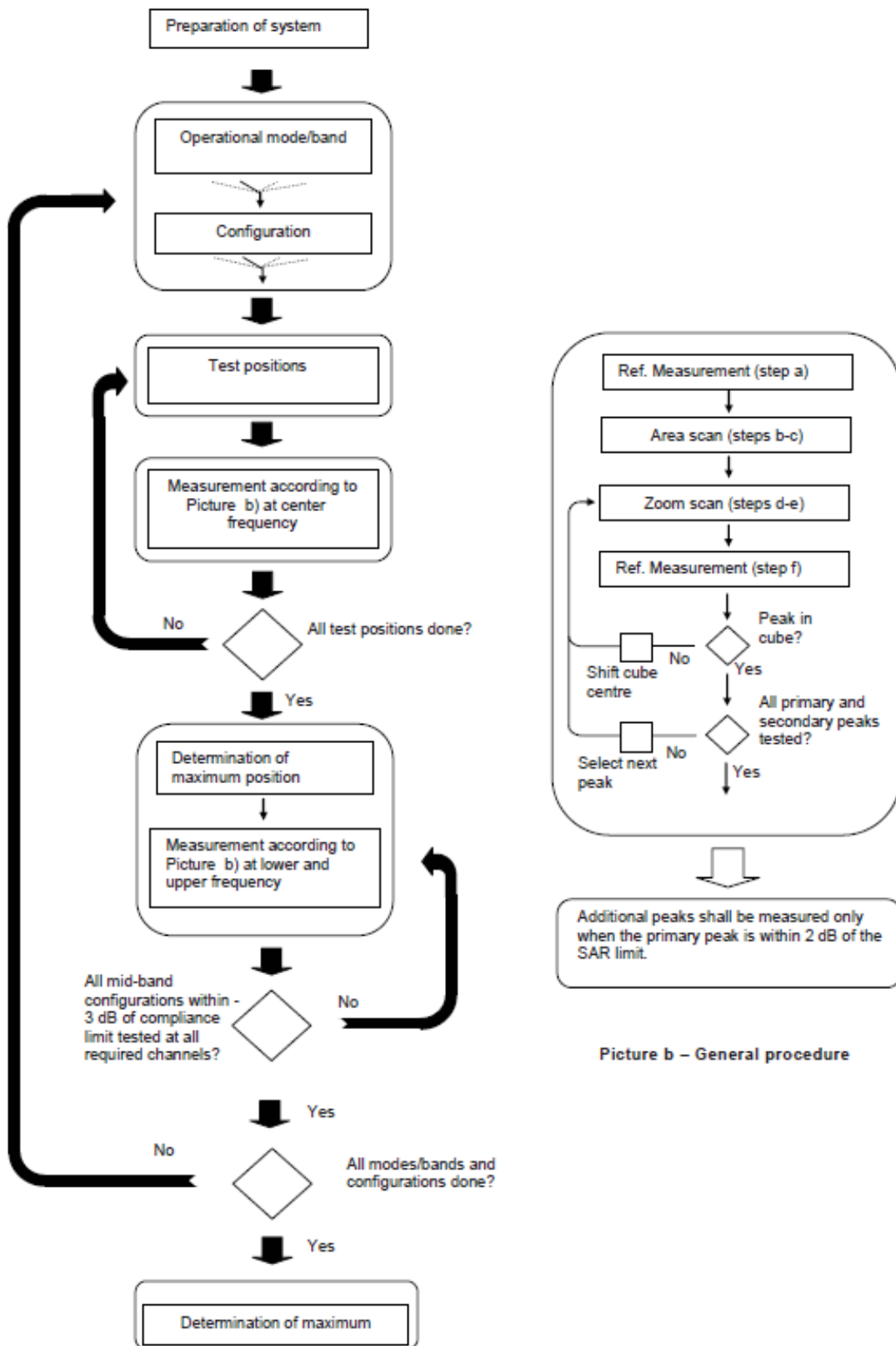

Picture a – Tests to be performed

Picture b – General procedure

Picture 10-1 Block diagram of the tests to be performed

9.2 General Measurement Procedure

The area and zoom scan resolutions specified in the table below must be applied to the SAR measurements and fully documented in SAR reports to qualify for TCB approval. Probe boundary effect error compensation is required for measurements with the probe tip closer than half a probe tip diameter to the phantom surface. Both the probe tip diameter and sensor offset distance must satisfy measurement protocols; to ensure probe boundary effect errors are minimized and the higher fields closest to the phantom surface can be correctly measured and extrapolated to the phantom surface for computing 1-g SAR. Tolerances of the post-processing algorithms must be verified by the test laboratory for the scan resolutions used in the SAR measurements, according to the reference distribution functions specified in IEEE Std 1528-2003. The results should be documented as part of the system validation records and may be requested to support test results when all the measurement parameters in the following table are not satisfied.

		≤ 3 GHz	> 3 GHz	
Maximum distance from closest measurement point (geometric center of probe sensors) to phantom surface		5 ± 1 mm	$\frac{1}{2} \delta \ln(2) \pm 0.5$ mm	
Maximum probe angle from probe axis to phantom surface normal at the measurement location		$30^\circ \pm 1^\circ$	$20^\circ \pm 1^\circ$	
Maximum area scan spatial resolution: Δx_{Area} , Δy_{Area}		≤ 2 GHz: ≤ 15 mm 2 – 3 GHz: ≤ 12 mm	3 – 4 GHz: ≤ 12 mm 4 – 6 GHz: ≤ 10 mm	
		When the x or y dimension of the test device, in the measurement plane orientation, is smaller than the above, the measurement resolution must be \leq the corresponding x or y dimension of the test device with at least one measurement point on the test device.		
Maximum zoom scan spatial resolution: Δx_{Zoom} , Δy_{Zoom}		≤ 2 GHz: ≤ 8 mm 2 – 3 GHz: ≤ 5 mm*	3 – 4 GHz: ≤ 5 mm* 4 – 6 GHz: ≤ 4 mm*	
Maximum zoom scan spatial resolution, normal to phantom surface	uniform grid: $\Delta z_{Zoom}(n)$	≤ 5 mm	3 – 4 GHz: ≤ 4 mm 4 – 5 GHz: ≤ 3 mm 5 – 6 GHz: ≤ 2 mm	
	graded grid	$\Delta z_{Zoom}(1)$: between 1 st two points closest to phantom surface	≤ 4 mm	3 – 4 GHz: ≤ 3 mm 4 – 5 GHz: ≤ 2.5 mm 5 – 6 GHz: ≤ 2 mm
		$\Delta z_{Zoom}(n>1)$: between subsequent points	$\leq 1.5 \cdot \Delta z_{Zoom}(n-1)$	
Minimum zoom scan volume	x, y, z	≥ 30 mm	3 – 4 GHz: ≥ 28 mm 4 – 5 GHz: ≥ 25 mm 5 – 6 GHz: ≥ 22 mm	
Note: δ is the penetration depth of a plane-wave at normal incidence to the tissue medium; see draft standard IEEE P1528-2011 for details.				
* When zoom scan is required and the <i>reported</i> SAR from the area scan based 1-g SAR estimation procedures of KDB 447498 is ≤ 1.4 W/kg, ≤ 8 mm, ≤ 7 mm and ≤ 5 mm zoom scan resolution may be applied, respectively, for 2 GHz to 3 GHz, 3 GHz to 4 GHz and 4 GHz to 6 GHz.				

9.3 WCDMA Measurement Procedures for SAR

The following procedures are applicable to WCDMA handsets operating under 3GPP Release99, Release 5 and Release 6. The default test configuration is to measure SAR with an established radio link between the DUT and a communication test set using a 12.2kbps RMC (reference measurement channel) configured in Test Loop Mode 1. SAR is selectively confirmed for other physical channel configurations (DPCCH & DPDCH_n), HSDPA and HSPA (HSUPA/HSDPA) modes according to output power, exposure conditions and device operating capabilities. Both uplink and downlink should be configured with the same RMC or AMR, when required. SAR for Release 5 HSDPA and Release 6 HSPA are measured using the applicable FRC (fixed reference channel) and E-DCH reference channel configurations. Maximum output power is verified according to applicable versions of 3GPP TS 34.121 and SAR must be measured according to these maximum output conditions. When Maximum Power Reduction (MPR) is not implemented according to Cubic Metric (CM) requirements for Release 6 HSPA, the following procedures do not apply.

For Release 5 HSDPA Data Devices:

Sub-test	β_c	β_d	β_d (SF)	β_c / β_d	β_{hs}	CM/dB
1	2/15	15/15	64	2/15	4/15	0.0
2	12/15	15/15	64	12/15	24/25	1.0
3	15/15	8/15	64	15/8	30/15	1.5
4	15/15	4/15	64	15/4	30/15	1.5

For Release 6 HSPA Data Devices

Sub-test	β_c	β_d	β_d (SF)	β_c / β_d	β_{hs}	β_{ec}	β_{ed}	β_{ed} (SF)	β_{ed} (codes)	CM (dB)	MPR (dB)	AG Index	E-TFCI
1	11/15	15/15	64	11/15	22/15	209/225	1039/225	4	1	1.5	1.5	20	75
2	6/15	15/15	64	6/15	12/15	12/15	12/15	4	1	1.5	1.5	12	67
3	15/15	9/15	64	15/9	30/15	30/15	$\beta_{ed1}:47/15$ $\beta_{ed2}:47/15$	4	2	1.5	1.5	15	92
4	2/15	15/15	64	2/15	4/15	4/15	56/75	4	1	1.5	1.5	17	71
5	15/15	15/15	64	15/15	24/15	30/15	134/15	4	1	1.5	1.5	21	81

Rel.8 DC-HSDPA (Cat 24)

SAR test exclusion for Rel.8 DC-HSDPA must satisfy the SAR test exclusion requirements of Rel.5 HSDPA. SAR test exclusion for DC-HSDPA devices is determined by power measurements according to the H-Set 12, Fixed Reference Channel (FRC) configuration in Table C.8.1.12 of 3GPP TS 34.121-1. A primary and a secondary serving HS-DSCH Cell are required to perform the power measurement and for the results to qualify for SAR test exclusion.

9.4 SAR Measurement for LTE

SAR tests for LTE are performed with a base station simulator, Rohde & Schwarz CMW500. Closed loop power control was used so the UE transmits with maximum output power during SAR testing. All powers were measured with the CMW 500.

It is performed for conducted power and SAR based on the KDB941225 D05.

SAR is evaluated separately according to the following procedures for the different test positions in each exposure condition – head, body, body-worn accessories and other use conditions. The procedures in the following subsections are applied separately to test each LTE frequency band.

1) QPSK with 1 RB allocation

Start with the largest channel bandwidth and measure SAR for QPSK with 1 RB allocation, using the RB offset and required test channel combination with the highest maximum output power among RB offsets at the upper edge, middle and lower edge of each required test channel. When the reported SAR is ≤ 0.8 W/kg, testing of the remaining RB offset configurations and required test channels is not required for 1 RB allocation; otherwise, SAR is required for the remaining required test channels and only for the RB offset configuration with the highest output power for that channel. When the reported SAR of a required test channel is > 1.45 W/kg, SAR is required for all three RB offset configurations for that required test channel.

2) QPSK with 50% RB allocation

The procedures required for 1 RB allocation in 1) are applied to measure the SAR for QPSK with 50% RB allocation.

3) QPSK with 100% RB allocation

For QPSK with 100% RB allocation, SAR is not required when the highest maximum output power for 100 % RB allocation is less than the highest maximum output power in 50% and 1 RB allocations and the highest reported SAR for 1 RB and 50% RB allocation in 1) and 2) are ≤ 0.8 W/kg. Otherwise, SAR is measured for the highest output power channel; and if the reported SAR is > 1.45 W/kg, the remaining required test channels must also be tested.

TDD test:

TDD testing is performed using guidance from FCC KDB 941225 D05 and the SAR test guidance provided in April 2013 TCB works hop notes. TDD is tested at the highest duty factor using UL-DL configuration 0 with special subframe configuration 6 and applying the FDD LTE procedures in KDB 941225 D05. SAR testing is performed using the extended cyclic prefix listed in 3GPP TS 36.211.

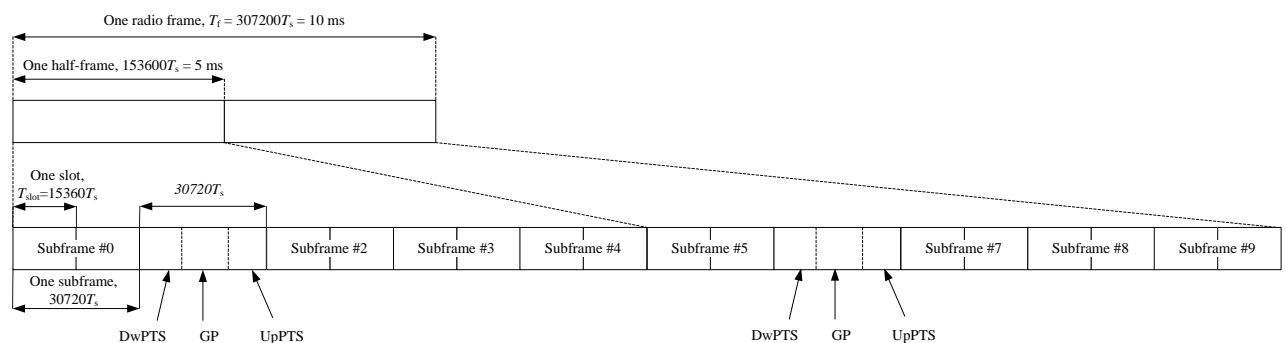

Figure 9.2: Frame structure type 2 (for 5 ms switch-point periodicity)

Table 9.1: Configuration of special subframe (lengths of DwPTS/GP/UpPTS)

Special subframe configuration	Normal cyclic prefix in downlink			Extended cyclic prefix in downlink		
	DwPTS	UpPTS		DwPTS	UpPTS	
		Normal cyclic prefix in uplink	Extended cyclic prefix in uplink		Normal cyclic prefix in uplink	Extended cyclic prefix in uplink
0	$6592 \cdot T_s$	$2192 \cdot T_s$	$2560 \cdot T_s$	$7680 \cdot T_s$	$2192 \cdot T_s$	$2560 \cdot T_s$
1	$19760 \cdot T_s$			$20480 \cdot T_s$		
2	$21952 \cdot T_s$			$23040 \cdot T_s$		
3	$24144 \cdot T_s$			$25600 \cdot T_s$		
4	$26336 \cdot T_s$	$4384 \cdot T_s$	$5120 \cdot T_s$	$7680 \cdot T_s$	$4384 \cdot T_s$	$5120 \cdot T_s$
5	$6592 \cdot T_s$			$20480 \cdot T_s$		
6	$19760 \cdot T_s$			$23040 \cdot T_s$		
7	$21952 \cdot T_s$			$12800 \cdot T_s$		
8	$24144 \cdot T_s$			-		
9	$13168 \cdot T_s$			-	-	-

Table 9.2: Uplink-downlink configurations

Uplink-downlink configuration	Downlink-to-Uplink Switch-point periodicity	Subframe number										
		0	1	2	3	4	5	6	7	8	9	
0	5 ms	D	S	U	U	U	D	S	U	U	U	
1	5 ms	D	S	U	U	D	D	S	U	U	D	
2	5 ms	D	S	U	D	D	D	S	U	D	D	
3	10 ms	D	S	U	U	U	D	D	D	D	D	
4	10 ms	D	S	U	U	D	D	D	D	D	D	
5	10 ms	D	S	U	D	D	D	D	D	D	D	
6	5 ms	D	S	U	U	U	D	S	U	U	D	

Duty factor is calculated by:

$$\begin{aligned}
 \text{Duty factor} &= \text{uplink frame} \cdot 6 + \text{UpPTS} \cdot 2 / \text{one frame length} \\
 &= (30720 \cdot T_s \cdot 6 + 5120 \cdot T_s \cdot 2) / 307200 \cdot T_s \\
 &= 0.633
 \end{aligned}$$

9.5 Bluetooth & Wi-Fi Measurement Procedures for SAR

Normal network operating configurations are not suitable for measuring the SAR of 802.11 transmitters in general. Unpredictable fluctuations in network traffic and antenna diversity conditions can introduce undesirable variations in SAR results. The SAR for these devices should be measured using chipset based test mode software to ensure that the results are consistent and reliable.

Chipset based test mode software is hardware dependent and generally varies among manufacturers. The device operating parameters established in a test mode for SAR measurements must be identical to those programmed in production units, including output power levels, amplifier gain settings and other RF performance tuning parameters. The test frequencies should correspond to actual channel frequencies defined for domestic use. SAR for devices with switched diversity should be measured with only one antenna transmitting at a time during each SAR measurement, according to a fixed modulation and data rate. The same data pattern should be used for all measurements.

9.6 Power Drift

To control the output power stability during the SAR test, DASY5 system calculates the power drift by measuring the E-field at the same location at the beginning and at the end of the measurement for each test position. These drift values can be found in section 14 labeled as: (Power Drift [dB]). This ensures that the power drift during one measurement is within 5%.

10 Area Scan Based 1-g SAR

10.1 Requirement of KDB

According to the KDB447498 D01, when the implementation is based the specific polynomial fit algorithm as presented at the 29th Bioelectromagnetics Society meeting (2007) and the estimated 1-gSAR is ≤ 1.2 W/kg, a zoom scan measurement is not required provided it is also not needed for any other purpose; for example, if the peak SAR location required for simultaneous transmission SAR test exclusion can be determined accurately by the SAR system or manually to discriminate between distinctive peaks and scattered noisy SAR distributions from area scans.

There must not be any warning or alert messages due to various measurement concerns identified by the SAR system; for example, noise in measurements, peaks too close to scan boundary, peaks are too sharp, spatial resolution and uncertainty issues etc. The SAR system verification must also demonstrate that the area scan estimated 1-g SAR is within 3% of the zoom scan 1-g SAR. When all the SAR results for each exposure condition in a frequency band and wireless mode are based on estimated 1-g SAR, the 1-g SAR for the highest SAR configuration must be determined by a zoom scan.

10.2 Fast SAR Algorithms

The approach is based on the area scan measurement applying a frequency dependent attenuation parameter. This attenuation parameter was empirically determined by analyzing a large number of phones. The MOTOROLA FAST SAR was developed and validated by the MOTOROLA Research Group in Ft. Lauderdale.

In the initial study, an approximation algorithm based on Linear fit was developed. The accuracy of the algorithm has been demonstrated across a broad frequency range (136-2450 MHz) and for both 1- and 10-g averaged SAR using a sample of 264 SAR measurements from 55 wireless handsets. For the sample size studied, the root-mean-squared errors of the algorithm are 1.2% and 5.8% for 1- and 10-g averaged SAR, respectively. The paper describing the algorithm in detail is expected to be published in August 2004 within the Special Issue of Transactions on MTT.

In the second step, the same research group optimized the fitting algorithm to an Polynomial fit whereby the frequency validity was extended to cover the range 30-6000MHz. Details of this study can be found in the BEMS 2007 Proceedings.

Both algorithms are implemented in DASY software.

11 Conducted Output Power

This device has several different power modes for head, body-worn, hotspot SAR compliance; power selection is determined by the device's positioning and usage scenarios. The details of test scenarios categorization in the table below

Antenna	Head receiver on	Hotspot	Body worn receiver off
Main antenna	DSI1	DSI2	DSIO

11.1 GSM Measurement result

GSM850 DSI0/1/2

GSM850(speech)	Conducted Power (dBm)			TUNE UP
	Channel 251(848.8MHz)	Channel 190(836.6MHz)	Channel 128(824.2MHz)	
GSM 850				33.30
GPRS (GMSK)	251	190	128	
1 Txslot	33.14	32.93	32.76	33.30
2 Txslots	30.41	30.45	30.47	30.50
3Txslots	28.46	28.48	28.35	28.50
4 Txslots	27.22	27.23	27.25	27.50
GSM 850				
EGPRS (GMSK)	251	190	128	
1 Txslot	33.03	32.85	32.70	33.30
2 Txslots	30.49	30.45	30.45	30.50
3Txslots	28.46	28.43	28.43	28.50
4 Txslots	27.20	27.23	27.27	27.50
GSM 850				
EGPRS (8PSK)	251	190	128	
1 Txslot	26.46	26.47	26.43	26.50
2 Txslots	24.42	24.43	24.49	24.50
3Txslots	22.86	22.96	22.81	23.00
4 Txslots	20.31	20.41	20.47	21.00

calculation (dB)	Frame Power (dBm)		
	251	190	128
-9.03	24.11	23.90	23.73
-6.02	24.39	24.43	24.45
-4.26	24.20	24.22	24.09
-3.01	24.21	24.22	24.24

calculation (dB)	Frame Power (dBm)		
	251	190	128
-9.03	24.00	23.82	23.67
-6.02	24.47	24.43	24.43
-4.26	24.20	24.17	24.17
-3.01	24.19	24.22	24.26

calculation (dB)	Frame Power (dBm)		
	251	190	128
-9.03	17.43	17.44	17.40
-6.02	18.40	18.41	18.47
-4.26	18.60	18.70	18.55
-3.01	17.30	17.40	17.46

GSM1900 DSI0

PCS1900(speech)	Conducted Power (dBm)			TUNE UP
	Channel 810(1909.8MHz)	Channel 661(1880MHz)	Channel 512(1850.2MHz)	
PCS1900				28.80
GPRS (GMSK)	810	661	512	
1 Txslot	28.27	28.28	27.96	28.80
2 Txslots	25.75	26.75	26.32	27.00
3Txslots	24.75	24.71	24.33	25.00
4 Txslots	22.71	22.74	22.34	23.00
PCS1900				
EGPRS (GMSK)	810	661	512	
1 Txslot	28.26	28.28	27.96	28.80
2 Txslots	26.74	26.74	26.31	27.00
3Txslots	24.74	24.70	24.32	25.00
4 Txslots	22.70	22.73	22.34	23.00
PCS1900				
EGPRS (8PSK)	810	661	512	
1 Txslot	23.14	23.08	23.26	23.50
2 Txslots	21.77	21.82	21.76	21.00
3Txslots	18.76	18.42	18.73	19.00
4 Txslots	17.91	17.86	17.93	18.00

calculation (dB)	Frame Power (dBm)		
	810	661	512
-9.03	19.24	19.25	18.93
-6.02	19.73	20.73	20.30
-4.26	20.49	20.45	20.07
-3.01	19.70	19.73	19.33

calculation (dB)	Frame Power (dBm)		
	810	661	512
-9.03	19.23	19.25	18.93
-6.02	20.72	20.72	20.29
-4.26	20.48	20.44	20.06
-3.01	19.69	19.72	19.33

calculation (dB)	Frame Power (dBm)		
	810	661	512
-9.03	14.11	14.05	14.23
-6.02	15.75	15.80	15.74
-4.26	14.50	14.16	14.47
-3.01	14.90	14.85	14.92

GSM1900 DSI1

PCS1900(speech)	Conducted Power (dBm)			TUNE UP
	Channel 810(1909.8MHz)	Channel 661(1880MHz)	Channel 512(1850.2MHz)	
PCS1900				30.30
GPRS (GMSK)	810	661	512	
1 Txslot	30.23	30.23	30.27	30.30
2 Txslots	28.48	28.45	28.45	28.50
3Txslots	27.33	27.35	26.82	27.50
4 Txslots	25.58	25.77	25.21	26.00
PCS1900				
EGPRS (GMSK)	810	661	512	
1 Txslot	30.24	30.24	30.26	30.30
2 Txslots	28.47	28.39	28.46	28.50
3Txslots	27.40	27.41	26.87	27.50
4 Txslots	25.66	25.84	25.27	26.00
PCS1900				
EGPRS (8PSK)	810	661	512	
1 Txslot	26.37	26.49	26.20	26.50
2 Txslots	24.90	24.79	24.66	25.00
3Txslots	23.36	23.44	23.81	24.00
4 Txslots	22.81	22.65	22.53	23.00

calculation (dB)	Frame Power (dBm)		
	810	661	512
-9.03	21.20	21.20	21.24
-6.02	22.46	22.43	22.43
-4.26	23.07	23.09	22.56
-3.01	22.57	22.76	22.20

calculation (dB)	Frame Power (dBm)		
	810	661	512
-9.03	21.21	21.21	21.23
-6.02	22.45	22.37	22.44
-4.26	23.14	23.15	22.61
-3.01	22.65	22.83	22.26

calculation (dB)	Frame Power (dBm)		
	810	661	512
-9.03	17.34	17.46	17.17
-6.02	18.88	18.77	18.64
-4.26	19.10	19.18	19.55
-3.01	19.80	19.64	19.52



GSM1900 DSI2

PCS1900(speech)	Conducted Power (dBm)		
	Channel 810(1909.8MHz)	Channel 661(1880MHz)	Channel 512(1850.2MHz)
	27.14	27.22	27.08
PCS1900	Burst Power (dBm)		
GPRS (GMSK)	810	661	512
1 Txslot	27.23	27.23	26.91
2 Txslots	25.53	25.51	25.45
3Txslots	23.46	23.36	23.27
4 Txslots	21.88	21.83	21.51
PCS1900	Burst Power (dBm)		
EGPRS (GMSK)	810	661	512
1 Txslot	27.23	27.25	26.92
2 Txslots	25.53	25.52	25.16
3Txslots	23.41	23.47	23.28
4 Txslots	21.89	21.84	21.52
PCS1900	Burst Power (dBm)		
EGPRS (8PSK)	810	661	512
1 Txslot	21.86	21.79	21.93
2 Txslots	19.88	19.76	19.82
3Txslots	17.37	17.42	17.49
4 Txslots	16.83	16.71	16.85

TUNE UP

TUNE UP	calculation (dB)	Frame Power (dBm)		
		810	661	512
27.30	-9.03	18.20	18.20	17.88
26.00	-6.02	19.51	19.49	19.43
23.50	-4.26	19.20	19.10	19.01
22.00	-3.01	18.87	18.82	18.50
	calculation (dB)	Frame Power (dBm)		
		810	661	512
27.30	-9.03	18.20	18.22	17.89
26.00	-6.02	19.51	19.50	19.14
23.50	-4.26	19.15	19.21	19.02
22.00	-3.01	18.88	18.83	18.51
	calculation (dB)	Frame Power (dBm)		
		810	661	512
22.50	-9.03	12.83	12.76	12.90
20.00	-6.02	13.86	13.74	13.80
18.00	-4.26	13.11	13.16	13.23
17.00	-3.01	13.82	13.70	13.84

11.2 WCDMA Measurement result

WCDMA1900 DSI0

WCDMA1900	FDDII result (dBm)			TUNE UP
	9538/9938 (1907.6MHz)	9400/9800 (1880MHz)	9262/9662 (1852.4MHz)	
		21.47	21.41	
HSUPA	20.01	20.03	19.97	21.00
	20.14	20.10	20.17	21.00
	20.8	20.76	20.69	21.50
	19.39	19.45	19.52	20.00
	20.08	20.16	20.16	21.00
HSPA+	21.39	21.32	21.38	22.00
DC-HSDPA	20.57	20.57	20.58	21.50
	20.51	20.56	20.52	21.50
	20.47	20.44	20.52	21.00
	20.37	20.42	20.43	21.00

WCDMA1900 DSI1

WCDMA1900	FDDII result (dBm)			TUNE UP
	9538/9938 (1907.6MHz)	9400/9800 (1880MHz)	9262/9662 (1852.4MHz)	
		23.79	23.92	
HSUPA	22.78	22.87	22.75	23.50
	21.96	21.86	21.99	23.50
	21.57	21.53	21.63	23.00
	22.26	22.34	22.16	23.00
	22.68	22.81	22.90	23.50
HSPA+	21.86	21.66	21.52	22.50
DC-HSDPA	22.09	22.10	22.24	22.50
	21.61	21.73	21.68	23.50
	20.66	20.82	20.71	21.50
	21.93	21.81	21.77	23.50

WCDMA1900 DSI2

WCDMA1900	FDDII result (dBm)			TUNE UP
	9538/9938 (1907.6MHz)	9400/9800 (1880MHz)	9262/9662 (1852.4MHz)	
		20.93	20.84	
HSUPA	18.99	19.04	19.10	19.50
	18.55	18.63	18.67	19.50
	19.87	19.83	19.74	20.50
	17.54	17.62	17.66	18.50
	19.37	19.27	19.31	20.00
HSPA+	19.64	19.57	19.67	20.50
DC-HSDPA	19.97	20.05	19.98	20.50
	19.79	19.70	19.60	20.50
	19.26	19.23	19.27	20.00
	19.37	19.34	19.38	20.00

WCDMA1700 DSI0

WCDMA1700	FDDIV result (dBm)			TUNE UP
	1513/1738 (1752.6MHz)	1412/1637 (1732.4MHz)	1312/1537 (1712.4MHz)	
	21.49	21.42	21.43	
HSUPA	19.96	20.03	20.00	20.50
	19.76	19.78	19.79	20.50
	19.92	19.85	19.77	20.50
	19	19.01	18.92	19.50
	20.26	20.20	20.20	21.00
HSPA+	20.41	20.35	20.29	21.00
DC-HSDPA	19.95	20.00	19.98	20.50
	20.02	19.98	20.06	21.00
	19.95	19.95	20.05	20.50
	19.72	19.66	19.62	20.50

WCDMA1700 DSI1

WCDMA1700	FDDIV result (dBm)			TUNE UP
	1513/1738 (1752.6MHz)	1412/1637 (1732.4MHz)	1312/1537 (1712.4MHz)	
	23.48	23.57	23.52	
HSUPA	21.08	21.06	20.98	22.00
	20.71	20.66	20.59	21.50
	21.96	21.95	21.89	22.50
	20.59	20.65	20.68	21.50
	21.76	21.79	21.83	22.50
HSPA+	22.63	22.73	22.69	23.50
DC-HSDPA	22	21.97	21.88	22.50
	21.61	21.54	21.61	22.50
	22.14	22.13	22.16	23.00
	20.5	20.45	20.36	21.00

WCDMA1700 DSI2

WCDMA1700	FDDIV result (dBm)			TUNE UP
	1513/1738 (1752.6MHz)	1412/1637 (1732.4MHz)	1312/1537 (1712.4MHz)	
	20.42	20.43	20.39	
HSUPA	18.65	18.60	18.58	19.50
	18.36	18.28	18.19	19.00
	18.27	18.29	18.28	19.00
	18.12	18.19	18.21	19.00
	19.31	19.34	19.26	20.00
HSPA+	19.78	19.88	19.93	20.50
DC-HSDPA	19.32	19.42	19.37	20.00
	19.49	19.49	19.39	20.00
	19.23	19.26	19.24	20.00
	19.22	19.30	19.32	20.00



WCDMA850 DSI0/1/2

WCDMA850	FDDV result (dBm)			TUNE UP
	4233/4458 (846.6MHz)	4183/4408 (836.6MHz)	4132/4357 (826.4MHz)	
	22.62	22.68	22.73	
HSUPA	20.94	20.92	20.89	21.50
	20.03	20.08	20.06	21.50
	20.61	20.66	20.67	22.50
	20.98	20.81	20.92	21.00
	21.79	21.75	21.77	22.00
HSPA+	20.81	20.86	20.92	22.50
DC-HSDPA	20.95	20.94	20.86	22.00
	20.11	20.08	20.03	22.00
	19.86	19.78	19.81	21.50
	19.83	19.76	19.77	21.50

11.3 LTE Measurement result

The maximum output power(Tune-up Limit)

Band	Tune up		
	DSI0	DSI1	DSI2
LTE Band 2	22	25	21
LTE Band 4	22	25	21
LTE Band 5	24	24	24
LTE Band 12	24	24	24
LTE Band 13	24	24	24
LTE Band 25	22	25	21
LTE Band 26	25	25	25
LTE Band 41 PC2	23	26.5	22
LTE Band 41 PC3	24	24	23
LTE Band 66	22	25	21
LTE Band 71	24	24	24

LTE Band2 DSI0

BANDWIDTH	Number of RBs	Frequency	QPSK	16QAM
1.4MHz	1RB-High (5)	1909.3 (19193)	20.45	20.68
		1880 (18900)	20.52	20.14
		1850.7 (18607)	20.59	20.15
	1RB-Middle (3)	1909.3 (19193)	20.45	20.00
		1880 (18900)	20.58	20.10
		1850.7 (18607)	20.64	20.20
	1RB-Low (0)	1909.3 (19193)	20.43	20.15
		1880 (18900)	20.37	20.14
		1850.7 (18607)	20.57	20.01
	3RB-High (3)	1909.3 (19193)	20.66	20.22
		1880 (18900)	20.63	20.32
		1850.7 (18607)	20.77	20.63
	3RB-Middle (1)	1909.3 (19193)	20.52	20.35
		1880 (18900)	20.56	20.48
		1850.7 (18607)	20.72	20.60
	3RB-Low (0)	1909.3 (19193)	20.64	20.25
		1880 (18900)	20.78	20.38
		1850.7 (18607)	20.78	20.49
	6RB (0)	1909.3 (19193)	20.46	20.41
		1880 (18900)	20.49	20.52
		1850.7 (18607)	20.65	20.55
3MHz	1RB-High (14)	1908.5 (19185)	20.36	20.06
		1880 (18900)	20.34	20.13
		1851.5 (18615)	20.54	20.69
	1RB-Middle (7)	1908.5 (19185)	20.27	20.18
		1880 (18900)	20.50	20.25
		1851.5 (18615)	20.65	20.27
	1RB-Low (0)	1908.5 (19185)	20.24	20.04
		1880 (18900)	20.50	20.00
		1851.5 (18615)	20.59	20.10
	8RB-High (7)	1908.5 (19185)	20.64	20.67
		1880 (18900)	20.56	20.60
		1851.5 (18615)	20.60	20.43
	8RB-Middle (4)	1908.5 (19185)	20.51	20.76
		1880 (18900)	20.58	20.65
		1851.5 (18615)	20.64	20.68
	8RB-Low (0)	1908.5 (19185)	20.54	20.85

	15RB (0)	1880 (18900)	20.63	20.68	
		1851.5 (18615)	20.62	20.74	
		1908.5 (19185)	20.47	20.54	
		1880 (18900)	20.54	20.55	
		1851.5 (18615)	20.61	20.59	
5MHz	1RB-High (24)	1907.5 (19175)	20.22	20.33	
		1880 (18900)	20.43	20.75	
		1852.5 (18625)	20.46	20.13	
	1RB-Middle (12)	1907.5 (19175)	20.23	20.12	
		1880 (18900)	20.55	20.25	
		1852.5 (18625)	20.78	20.23	
	1RB-Low (0)	1907.5 (19175)	20.21	20.15	
		1880 (18900)	20.48	20.13	
		1852.5 (18625)	20.62	20.13	
	12RB-High (13)	1907.5 (19175)	20.50	20.67	
		1880 (18900)	20.47	20.45	
		1852.5 (18625)	20.54	20.53	
	12RB-Middle (6)	1907.5 (19175)	20.55	20.44	
		1880 (18900)	20.59	20.37	
		1852.5 (18625)	20.62	20.42	
	12RB-Low (0)	1907.5 (19175)	20.47	20.56	
		1880 (18900)	20.56	20.47	
		1852.5 (18625)	20.60	20.40	
	25RB (0)	1907.5 (19175)	20.51	20.61	
		1880 (18900)	20.57	20.56	
		1852.5 (18625)	20.57	20.75	
	10MHz	1RB-High (49)	1905 (19150)	20.64	20.15
			1880 (18900)	20.51	20.08
			1855 (18650)	20.65	21.05
1RB-Middle (24)		1905 (19150)	20.64	20.30	
		1880 (18900)	20.64	20.16	
		1855 (18650)	20.64	20.18	
1RB-Low (0)		1905 (19150)	20.57	20.18	
		1880 (18900)	20.57	20.33	
		1855 (18650)	20.49	20.19	
25RB-High (25)		1905 (19150)	20.53	20.61	
		1880 (18900)	20.47	20.65	
		1855 (18650)	20.59	20.85	
25RB-Middle (12)	1905 (19150)	20.51	20.61		
	1880 (18900)	20.54	20.62		

	25RB-Low (0)	1855 (18650)	20.61	20.70	
		1905 (19150)	20.59	20.59	
		1880 (18900)	20.60	20.59	
		1855 (18650)	20.61	20.68	
	50RB (0)	1905 (19150)	20.55	20.65	
		1880 (18900)	20.62	20.61	
1855 (18650)		20.66	20.68		
15MHz	1RB-High (74)	1902.5 (19125)	20.55	20.35	
		1880 (18900)	20.33	20.58	
		1857.5 (18675)	20.56	20.10	
	1RB-Middle (37)	1902.5 (19125)	20.58	20.16	
		1880 (18900)	20.50	20.72	
		1857.5 (18675)	20.57	20.23	
	1RB-Low (0)	1902.5 (19125)	20.58	20.10	
		1880 (18900)	20.56	20.17	
		1857.5 (18675)	20.67	20.15	
	36RB-High (38)	1902.5 (19125)	20.58	20.49	
		1880 (18900)	20.53	20.49	
		1857.5 (18675)	20.59	20.73	
	36RB-Middle (19)	1902.5 (19125)	20.55	20.68	
		1880 (18900)	20.55	20.59	
		1857.5 (18675)	20.57	20.80	
	36RB-Low (0)	1902.5 (19125)	20.53	20.55	
		1880 (18900)	20.47	20.50	
		1857.5 (18675)	20.52	20.55	
	75RB (0)	1902.5 (19125)	20.55	20.57	
		1880 (18900)	20.54	20.47	
		1857.5 (18675)	20.65	20.67	
	20MHz	1RB-High (99)	1900 (19100)	20.31	20.09
			1880 (18900)	20.37	20.23
			1860 (18700)	20.61	20.20
1RB-Middle (50)		1900 (19100)	20.65	20.13	
		1880 (18900)	20.63	21.00	
		1860 (18700)	20.63	20.17	
1RB-Low (0)		1900 (19100)	20.38	20.12	
		1880 (18900)	20.37	20.30	
		1860 (18700)	20.60	20.27	
50RB-High (50)		1900 (19100)	20.56	20.44	
		1880 (18900)	20.53	20.53	
		1860 (18700)	20.56	20.71	

	50RB-Middle (25)	1900 (19100)	20.64	20.71
		1880 (18900)	20.59	20.58
		1860 (18700)	20.57	20.64
	50RB-Low (0)	1900 (19100)	20.55	20.56
		1880 (18900)	20.54	20.52
		1860 (18700)	20.57	20.63
	100RB (0)	1900 (19100)	20.63	20.63
		1880 (18900)	20.56	20.54
		1860 (18700)	20.61	20.46

LTE Band2 DSI1

BANDWIDTH	Number of RBs	Frequency	QPSK	16QAM	
1.4MHz	1RB-High (5)	1909.3 (19193)	23.50	23.04	
		1880 (18900)	23.65	22.02	
		1850.7 (18607)	23.74	22.28	
	1RB-Middle (3)	1909.3 (19193)	23.44	23.27	
		1880 (18900)	23.86	22.31	
		1850.7 (18607)	23.65	22.52	
	1RB-Low (0)	1909.3 (19193)	23.34	22.27	
		1880 (18900)	23.73	22.06	
		1850.7 (18607)	23.54	22.11	
	3RB-High (3)	1909.3 (19193)	23.73	22.86	
		1880 (18900)	23.83	22.98	
		1850.7 (18607)	23.71	22.51	
	3RB-Middle (1)	1909.3 (19193)	23.73	22.42	
		1880 (18900)	23.82	22.85	
		1850.7 (18607)	23.92	22.54	
	3RB-Low (0)	1909.3 (19193)	23.68	22.41	
		1880 (18900)	23.92	22.80	
		1850.7 (18607)	23.65	22.52	
	6RB (0)	1909.3 (19193)	22.62	21.53	
		1880 (18900)	22.74	21.45	
		1850.7 (18607)	22.60	21.57	
	3MHz	1RB-High (14)	1908.5 (19185)	23.69	22.40
			1880 (18900)	23.61	22.77
			1851.5 (18615)	23.70	22.10
1RB-Middle (7)		1908.5 (19185)	23.56	22.18	
		1880 (18900)	23.51	22.85	
		1851.5 (18615)	23.80	22.18	

	1RB-Low (0)	1908.5 (19185)	23.60	22.04	
		1880 (18900)	23.37	22.19	
		1851.5 (18615)	23.60	22.10	
	8RB-High (7)	1908.5 (19185)	22.71	21.79	
		1880 (18900)	22.78	21.77	
		1851.5 (18615)	22.82	21.65	
	8RB-Middle (4)	1908.5 (19185)	22.74	21.81	
		1880 (18900)	22.69	21.70	
		1851.5 (18615)	22.73	21.65	
	8RB-Low (0)	1908.5 (19185)	22.69	21.68	
		1880 (18900)	22.70	21.69	
		1851.5 (18615)	22.63	21.85	
15RB (0)	1908.5 (19185)	22.60	21.55		
	1880 (18900)	22.64	21.81		
	1851.5 (18615)	22.68	21.65		
5MHz	1RB-High (24)	1907.5 (19175)	23.57	22.64	
		1880 (18900)	23.55	22.03	
		1852.5 (18625)	23.64	22.05	
	1RB-Middle (12)	1907.5 (19175)	23.88	22.72	
		1880 (18900)	23.57	22.41	
		1852.5 (18625)	23.61	22.18	
	1RB-Low (0)	1907.5 (19175)	23.54	22.65	
		1880 (18900)	23.48	22.14	
		1852.5 (18625)	23.51	22.01	
	12RB-High (13)	1907.5 (19175)	22.68	21.80	
		1880 (18900)	22.67	21.51	
		1852.5 (18625)	22.74	21.63	
	12RB-Middle (6)	1907.5 (19175)	22.63	21.75	
		1880 (18900)	22.76	21.48	
		1852.5 (18625)	22.66	21.55	
	12RB-Low (0)	1907.5 (19175)	22.53	21.53	
		1880 (18900)	22.58	21.42	
		1852.5 (18625)	22.64	21.51	
	25RB (0)	1907.5 (19175)	22.51	21.62	
		1880 (18900)	22.63	21.59	
		1852.5 (18625)	22.70	21.65	
	10MHz	1RB-High (49)	1905 (19150)	23.80	22.96
			1880 (18900)	23.54	22.01
			1855 (18650)	23.84	22.51
1RB-Middle (24)		1905 (19150)	23.76	22.75	

		1880 (18900)	23.59	22.68
		1855 (18650)	23.70	22.29
		1905 (19150)	23.48	22.28
	1RB-Low (0)	1880 (18900)	23.76	22.38
		1855 (18650)	23.48	22.54
		1905 (19150)	22.65	21.76
	25RB-High (25)	1880 (18900)	22.71	21.65
		1855 (18650)	22.64	21.69
		1905 (19150)	22.64	21.66
	25RB-Middle (12)	1880 (18900)	22.72	21.84
		1855 (18650)	22.71	21.75
		1905 (19150)	22.59	21.60
	25RB-Low (0)	1880 (18900)	22.58	21.53
		1855 (18650)	22.67	21.63
		1905 (19150)	22.71	21.64
50RB (0)	1880 (18900)	22.68	21.72	
	1855 (18650)	22.73	21.60	
	1902.5 (19125)	23.47	22.01	
15MHz	1RB-High (74)	1880 (18900)	23.62	22.05
		1857.5 (18675)	23.69	22.07
		1902.5 (19125)	23.56	22.01
	1RB-Middle (37)	1880 (18900)	23.60	22.34
		1857.5 (18675)	23.66	22.82
		1902.5 (19125)	23.47	22.06
	1RB-Low (0)	1880 (18900)	23.53	22.27
		1857.5 (18675)	23.42	22.38
		1902.5 (19125)	22.71	21.58
	36RB-High (38)	1880 (18900)	22.74	21.68
		1857.5 (18675)	22.71	21.56
		1902.5 (19125)	22.76	21.64
	36RB-Middle (19)	1880 (18900)	22.78	21.60
		1857.5 (18675)	22.75	21.61
		1902.5 (19125)	22.63	21.50
36RB-Low (0)	1880 (18900)	22.71	21.54	
	1857.5 (18675)	22.72	21.57	
	1902.5 (19125)	22.74	21.55	
75RB (0)	1880 (18900)	22.82	21.65	
	1857.5 (18675)	22.77	21.72	
	1900 (19100)	23.72	22.16	
20MHz	1RB-High (99)	1880 (18900)	23.61	22.42

	1RB-Middle (50)	1860 (18700)	23.76	22.15	
		1900 (19100)	23.85	22.28	
		1880 (18900)	23.59	22.57	
	1RB-Low (0)	1860 (18700)	23.81	22.36	
		1900 (19100)	23.67	22.19	
		1880 (18900)	23.44	22.23	
	50RB-High (50)	1860 (18700)	23.96	22.34	
		1900 (19100)	22.71	21.86	
		1880 (18900)	22.73	21.82	
	50RB-Middle (25)	1860 (18700)	22.82	21.56	
		1900 (19100)	22.74	21.83	
		1880 (18900)	22.72	21.72	
	50RB-Low (0)	1860 (18700)	22.79	21.63	
		1900 (19100)	22.67	21.78	
		1880 (18900)	22.72	21.63	
	100RB (0)	1860 (18700)	22.70	21.73	
		1900 (19100)	22.82	21.74	
		1880 (18900)	22.72	21.70	
			1860 (18700)	22.86	21.69

LTE Band2 DSI2

BANDWIDTH	Number of RBs	Frequency	QPSK	16QAM
1.4MHz	1RB-High (5)	1909.3 (19193)	20.54	20.93
		1880 (18900)	20.85	20.89
		1850.7 (18607)	20.79	20.88
	1RB-Middle (3)	1909.3 (19193)	20.61	20.42
		1880 (18900)	20.78	20.49
		1850.7 (18607)	20.69	20.34
	1RB-Low (0)	1909.3 (19193)	20.51	20.47
		1880 (18900)	20.67	19.97
		1850.7 (18607)	20.58	20.33
	3RB-High (3)	1909.3 (19193)	20.86	20.86
		1880 (18900)	20.87	20.57
		1850.7 (18607)	20.98	20.74
	3RB-Middle (1)	1909.3 (19193)	20.87	20.85
		1880 (18900)	20.87	20.60
		1850.7 (18607)	20.98	20.73
	3RB-Low (0)	1909.3 (19193)	20.81	20.73
		1880 (18900)	20.81	20.66

	6RB (0)	1850.7 (18607)	20.92	20.68	
		1909.3 (19193)	20.72	20.79	
		1880 (18900)	20.73	20.65	
		1850.7 (18607)	20.84	20.85	
3MHz	1RB-High (14)	1908.5 (19185)	20.78	20.12	
		1880 (18900)	20.65	20.54	
		1851.5 (18615)	20.80	20.43	
	1RB-Middle (7)	1908.5 (19185)	20.74	20.62	
		1880 (18900)	20.62	20.40	
		1851.5 (18615)	20.78	20.48	
	1RB-Low (0)	1908.5 (19185)	20.61	20.29	
		1880 (18900)	20.65	20.30	
		1851.5 (18615)	20.79	20.02	
	8RB-High (7)	1908.5 (19185)	20.69	20.95	
		1880 (18900)	20.90	20.85	
		1851.5 (18615)	20.88	20.73	
	8RB-Middle (4)	1908.5 (19185)	20.70	20.79	
		1880 (18900)	20.79	20.84	
		1851.5 (18615)	20.76	20.81	
	8RB-Low (0)	1908.5 (19185)	20.83	20.74	
		1880 (18900)	20.80	20.87	
		1851.5 (18615)	20.77	20.72	
	15RB (0)	1908.5 (19185)	20.65	20.82	
		1880 (18900)	20.75	20.75	
		1851.5 (18615)	20.82	20.72	
	5MHz	1RB-High (24)	1907.5 (19175)	20.47	20.81
			1880 (18900)	20.70	20.73
			1852.5 (18625)	20.78	20.22
1RB-Middle (12)		1907.5 (19175)	20.82	20.26	
		1880 (18900)	20.73	20.74	
		1852.5 (18625)	20.89	20.36	
1RB-Low (0)		1907.5 (19175)	20.66	20.15	
		1880 (18900)	20.66	20.11	
		1852.5 (18625)	20.50	20.06	
12RB-High (13)		1907.5 (19175)	20.65	20.80	
		1880 (18900)	20.79	20.62	
		1852.5 (18625)	20.82	20.62	
12RB-Middle (6)		1907.5 (19175)	20.68	20.63	
		1880 (18900)	20.77	20.58	
		1852.5 (18625)	20.80	20.53	

	12RB-Low (0)	1907.5 (19175)	20.67	20.62	
		1880 (18900)	20.70	20.52	
		1852.5 (18625)	20.67	20.41	
	25RB (0)	1907.5 (19175)	20.84	20.71	
		1880 (18900)	20.84	20.74	
		1852.5 (18625)	20.73	20.74	
10MHz	1RB-High (49)	1905 (19150)	20.87	20.76	
		1880 (18900)	20.57	20.86	
		1855 (18650)	20.80	20.52	
	1RB-Middle (24)	1905 (19150)	20.96	20.12	
		1880 (18900)	20.79	20.19	
		1855 (18650)	20.85	20.62	
	1RB-Low (0)	1905 (19150)	20.62	20.24	
		1880 (18900)	20.82	20.30	
		1855 (18650)	20.58	19.81	
	25RB-High (25)	1905 (19150)	20.65	20.53	
		1880 (18900)	20.76	20.73	
		1855 (18650)	20.76	20.99	
	25RB-Middle (12)	1905 (19150)	20.68	20.78	
		1880 (18900)	20.77	20.83	
		1855 (18650)	20.80	20.73	
	25RB-Low (0)	1905 (19150)	20.65	20.66	
		1880 (18900)	20.65	20.70	
		1855 (18650)	20.76	20.74	
	50RB (0)	1905 (19150)	20.78	20.70	
		1880 (18900)	20.74	20.79	
		1855 (18650)	20.74	20.82	
	15MHz	1RB-High (74)	1902.5 (19125)	20.76	20.15
			1880 (18900)	20.70	20.76
			1857.5 (18675)	20.78	20.80
1RB-Middle (37)		1902.5 (19125)	20.81	20.01	
		1880 (18900)	20.80	20.83	
		1857.5 (18675)	20.81	20.23	
1RB-Low (0)		1902.5 (19125)	20.66	19.94	
		1880 (18900)	20.72	20.30	
		1857.5 (18675)	20.80	20.34	
36RB-High (38)		1902.5 (19125)	20.87	20.82	
		1880 (18900)	20.80	20.80	
		1857.5 (18675)	20.82	20.70	
36RB-Middle (19)	1902.5 (19125)	20.78	20.86		

		1880 (18900)	20.84	20.72
		1857.5 (18675)	20.77	20.75
		1902.5 (19125)	20.77	20.64
	36RB-Low (0)	1880 (18900)	20.70	20.68
		1857.5 (18675)	20.74	20.70
		1902.5 (19125)	20.73	20.77
	75RB (0)	1880 (18900)	20.79	20.77
		1857.5 (18675)	20.78	20.76
20MHz	1RB-High (99)	1900 (19100)	20.80	20.91
		1880 (18900)	20.68	20.13
		1860 (18700)	20.81	20.86
	1RB-Middle (50)	1900 (19100)	20.91	20.77
		1880 (18900)	20.84	20.52
		1860 (18700)	20.62	20.94
	1RB-Low (0)	1900 (19100)	20.76	20.37
		1880 (18900)	20.76	20.22
		1860 (18700)	20.59	20.34
	50RB-High (50)	1900 (19100)	20.79	20.79
		1880 (18900)	20.85	20.76
		1860 (18700)	20.89	20.69
	50RB-Middle (25)	1900 (19100)	20.81	20.73
		1880 (18900)	20.81	20.63
		1860 (18700)	20.87	20.74
	50RB-Low (0)	1900 (19100)	20.71	20.61
		1880 (18900)	20.86	20.74
		1860 (18700)	20.77	20.67
	100RB (0)	1900 (19100)	20.77	20.74
		1880 (18900)	20.86	20.74
		1860 (18700)	20.72	20.82

LTE Band4 DSI0

BANDWIDTH	Number of RBs	Frequency	QPSK	16QAM
1.4MHz	1RB-High (5)	1754.3 (20393)	20.95	20.33
		1732.5 (20175)	20.97	21.19
		1710.7 (19957)	21.17	20.75
	1RB-Middle (3)	1754.3 (20393)	20.97	20.63
		1732.5 (20175)	21.02	20.94
		1710.7 (19957)	21.40	21.05
	1RB-Low (0)	1754.3 (20393)	20.92	21.16

		1732.5 (20175)	21.03	20.86	
		1710.7 (19957)	21.43	20.97	
		1754.3 (20393)	21.17	20.89	
	3RB-High (3)	1732.5 (20175)	21.16	21.01	
		1710.7 (19957)	21.26	21.13	
		1754.3 (20393)	21.13	21.12	
	3RB-Middle (1)	1732.5 (20175)	21.18	20.99	
		1710.7 (19957)	21.49	21.06	
		1754.3 (20393)	21.17	20.81	
	3RB-Low (0)	1732.5 (20175)	21.13	21.03	
		1710.7 (19957)	21.31	21.15	
		1754.3 (20393)	20.95	20.81	
6RB (0)	1732.5 (20175)	21.04	21.18		
	1710.7 (19957)	21.23	21.07		
	1753.5 (20385)	20.85	20.98		
3MHz	1RB-High (14)	1732.5 (20175)	21.09	20.87	
		1711.5 (19965)	21.18	21.44	
		1753.5 (20385)	20.85	20.70	
	1RB-Middle (7)	1732.5 (20175)	21.12	20.90	
		1711.5 (19965)	21.24	21.03	
		1753.5 (20385)	20.71	20.56	
	1RB-Low (0)	1732.5 (20175)	21.18	20.90	
		1711.5 (19965)	21.32	20.91	
		1753.5 (20385)	21.02	21.22	
	8RB-High (7)	1732.5 (20175)	21.19	21.19	
		1711.5 (19965)	21.30	21.40	
		1753.5 (20385)	21.09	21.11	
	8RB-Middle (4)	1732.5 (20175)	21.21	21.20	
		1711.5 (19965)	21.23	21.33	
		1753.5 (20385)	20.89	21.00	
	8RB-Low (0)	1732.5 (20175)	21.04	21.23	
		1711.5 (19965)	21.36	21.30	
		1753.5 (20385)	21.04	21.01	
	15RB (0)	1732.5 (20175)	21.14	21.22	
		1711.5 (19965)	21.27	21.36	
		1752.5 (20375)	21.12	20.98	
	5MHz	1RB-High (24)	1732.5 (20175)	21.01	21.04
			1712.5 (19975)	21.05	20.81
			1752.5 (20375)	21.11	20.77
1RB-Middle (12)		1732.5 (20175)	21.16	20.91	

	1RB-Low (0)	1712.5 (19975)	21.38	21.08
		1752.5 (20375)	20.71	20.47
		1732.5 (20175)	21.07	20.90
	12RB-High (13)	1712.5 (19975)	21.25	20.98
		1752.5 (20375)	21.00	21.07
		1732.5 (20175)	21.06	20.95
	12RB-Middle (6)	1712.5 (19975)	21.21	21.22
		1752.5 (20375)	21.01	20.92
		1732.5 (20175)	21.19	21.10
	12RB-Low (0)	1712.5 (19975)	21.33	21.24
		1752.5 (20375)	21.02	21.05
		1732.5 (20175)	21.18	21.00
	25RB (0)	1712.5 (19975)	21.25	21.14
		1752.5 (20375)	21.05	21.15
		1732.5 (20175)	21.12	21.19
10MHz	1RB-High (49)	1712.5 (19975)	21.17	21.27
		1750 (20350)	21.26	21.56
		1732.5 (20175)	21.28	20.78
	1RB-Middle (24)	1715 (20000)	21.20	20.79
		1750 (20350)	20.99	21.22
		1732.5 (20175)	21.06	20.97
	1RB-Low (0)	1715 (20000)	21.41	20.99
		1750 (20350)	21.03	20.96
		1732.5 (20175)	20.97	20.86
	25RB-High (25)	1715 (20000)	21.08	20.93
		1750 (20350)	21.10	21.17
		1732.5 (20175)	21.12	21.09
	25RB-Middle (12)	1715 (20000)	21.17	21.33
		1750 (20350)	20.99	21.08
		1732.5 (20175)	21.16	21.16
25RB-Low (0)	1715 (20000)	21.26	21.25	
	1750 (20350)	21.01	21.11	
	1732.5 (20175)	21.23	21.15	
50RB (0)	1715 (20000)	21.21	21.20	
	1750 (20350)	21.08	21.28	
	1732.5 (20175)	21.16	21.11	
15MHz	1RB-High (74)	1715 (20000)	21.31	21.36
		1747.5 (20325)	20.85	21.39
		1732.5 (20175)	21.03	21.20
		1717.5 (20025)	21.32	20.78

	1RB-Middle (37)	1747.5 (20325)	21.02	21.26	
		1732.5 (20175)	21.06	20.87	
		1717.5 (20025)	21.31	20.76	
	1RB-Low (0)	1747.5 (20325)	20.98	20.95	
		1732.5 (20175)	20.98	20.91	
		1717.5 (20025)	21.34	20.99	
	36RB-High (38)	1747.5 (20325)	21.20	21.16	
		1732.5 (20175)	21.08	21.04	
		1717.5 (20025)	21.23	21.26	
	36RB-Middle (19)	1747.5 (20325)	21.08	21.01	
		1732.5 (20175)	21.12	21.26	
		1717.5 (20025)	21.29	21.38	
	36RB-Low (0)	1747.5 (20325)	21.06	21.03	
		1732.5 (20175)	21.16	21.26	
		1717.5 (20025)	21.20	21.33	
	75RB (0)	1747.5 (20325)	21.02	21.09	
		1732.5 (20175)	21.18	21.19	
		1717.5 (20025)	21.22	21.34	
	20MHz	1RB-High (99)	1745 (20300)	20.91	20.81
			1732.5 (20175)	20.98	21.18
			1720 (20050)	21.30	20.82
		1RB-Middle (50)	1745 (20300)	21.00	20.92
			1732.5 (20175)	21.03	20.96
			1720 (20050)	21.19	21.22
1RB-Low (0)		1745 (20300)	21.10	20.97	
		1732.5 (20175)	20.99	21.10	
		1720 (20050)	20.99	20.93	
50RB-High (50)		1745 (20300)	21.17	21.27	
		1732.5 (20175)	21.11	21.16	
		1720 (20050)	21.29	21.40	
50RB-Middle (25)		1745 (20300)	21.14	21.24	
		1732.5 (20175)	21.14	21.18	
		1720 (20050)	21.18	21.34	
50RB-Low (0)		1745 (20300)	21.10	21.00	
		1732.5 (20175)	21.15	21.23	
		1720 (20050)	21.28	21.39	
100RB (0)		1745 (20300)	21.12	21.01	
		1732.5 (20175)	21.07	21.08	
		1720 (20050)	21.23	21.33	

LTE Band4 DSI1

BANDWIDTH	Number of RBs	Frequency	QPSK	16QAM	
1.4MHz	1RB-High (5)	1754.3 (20393)	23.40	22.86	
		1732.5 (20175)	23.52	22.27	
		1710.7 (19957)	23.21	22.18	
	1RB-Middle (3)	1754.3 (20393)	23.61	23.18	
		1732.5 (20175)	23.65	22.25	
		1710.7 (19957)	23.25	22.10	
	1RB-Low (0)	1754.3 (20393)	23.35	22.20	
		1732.5 (20175)	23.52	22.18	
		1710.7 (19957)	23.46	22.04	
	3RB-High (3)	1754.3 (20393)	23.65	22.36	
		1732.5 (20175)	23.60	22.53	
		1710.7 (19957)	23.47	22.67	
	3RB-Middle (1)	1754.3 (20393)	23.70	22.44	
		1732.5 (20175)	23.74	22.37	
		1710.7 (19957)	23.49	22.40	
	3RB-Low (0)	1754.3 (20393)	23.56	22.35	
		1732.5 (20175)	23.68	22.32	
		1710.7 (19957)	23.44	22.40	
	6RB (0)	1754.3 (20393)	22.60	21.66	
		1732.5 (20175)	22.48	21.31	
		1710.7 (19957)	22.30	21.27	
	3MHz	1RB-High (14)	1753.5 (20385)	23.65	22.12
			1732.5 (20175)	23.42	22.10
			1711.5 (19965)	23.45	22.27
		1RB-Middle (7)	1753.5 (20385)	23.49	22.31
			1732.5 (20175)	23.59	22.37
			1711.5 (19965)	23.47	22.15
1RB-Low (0)		1753.5 (20385)	23.43	22.07	
		1732.5 (20175)	23.68	22.13	
		1711.5 (19965)	23.41	22.07	
8RB-High (7)		1753.5 (20385)	22.52	21.58	
		1732.5 (20175)	22.52	21.55	
		1711.5 (19965)	22.38	21.53	
8RB-Middle (4)		1753.5 (20385)	22.46	21.64	
		1732.5 (20175)	22.66	21.69	
		1711.5 (19965)	22.42	21.56	
8RB-Low (0)		1753.5 (20385)	22.44	21.51	

	15RB (0)	1732.5 (20175)	22.61	21.65	
		1711.5 (19965)	22.48	21.48	
		1753.5 (20385)	22.51	21.55	
		1732.5 (20175)	22.50	21.60	
		1711.5 (19965)	22.36	21.27	
5MHz	1RB-High (24)	1752.5 (20375)	23.59	22.23	
		1732.5 (20175)	23.35	22.67	
		1712.5 (19975)	23.26	22.57	
	1RB-Middle (12)	1752.5 (20375)	23.65	22.33	
		1732.5 (20175)	23.63	22.22	
		1712.5 (19975)	23.37	22.02	
	1RB-Low (0)	1752.5 (20375)	23.41	22.20	
		1732.5 (20175)	23.46	22.35	
		1712.5 (19975)	23.47	22.06	
	12RB-High (13)	1752.5 (20375)	22.61	21.75	
		1732.5 (20175)	22.50	21.50	
		1712.5 (19975)	22.35	21.25	
	12RB-Middle (6)	1752.5 (20375)	22.49	21.55	
		1732.5 (20175)	22.56	21.35	
		1712.5 (19975)	22.36	21.43	
	12RB-Low (0)	1752.5 (20375)	22.48	21.54	
		1732.5 (20175)	22.57	21.49	
		1712.5 (19975)	22.36	21.38	
	25RB (0)	1752.5 (20375)	22.54	21.69	
		1732.5 (20175)	22.49	21.66	
		1712.5 (19975)	22.31	21.49	
	10MHz	1RB-High (49)	1750 (20350)	23.61	23.01
			1732.5 (20175)	23.76	22.50
			1715 (20000)	23.41	22.08
1RB-Middle (24)		1750 (20350)	23.69	22.50	
		1732.5 (20175)	23.47	22.48	
		1715 (20000)	23.37	22.56	
1RB-Low (0)		1750 (20350)	23.80	22.35	
		1732.5 (20175)	23.49	22.30	
		1715 (20000)	23.19	22.12	
25RB-High (25)		1750 (20350)	22.63	21.57	
		1732.5 (20175)	22.62	21.59	
		1715 (20000)	22.36	21.44	
25RB-Middle (12)		1750 (20350)	22.58	21.51	
		1732.5 (20175)	22.55	21.42	

	25RB-Low (0)	1715 (20000)	22.37	21.52	
		1750 (20350)	22.56	21.62	
		1732.5 (20175)	22.47	21.44	
		1715 (20000)	22.36	21.42	
	50RB (0)	1750 (20350)	22.67	21.74	
		1732.5 (20175)	22.58	21.56	
1715 (20000)		22.49	21.58		
15MHz	1RB-High (74)	1747.5 (20325)	23.40	22.90	
		1732.5 (20175)	23.57	22.88	
		1717.5 (20025)	23.51	22.06	
	1RB-Middle (37)	1747.5 (20325)	23.78	22.30	
		1732.5 (20175)	23.63	22.09	
		1717.5 (20025)	23.54	22.13	
	1RB-Low (0)	1747.5 (20325)	23.57	22.27	
		1732.5 (20175)	23.49	22.09	
		1717.5 (20025)	23.50	22.19	
	36RB-High (38)	1747.5 (20325)	22.63	21.73	
		1732.5 (20175)	22.66	21.62	
		1717.5 (20025)	22.56	21.55	
	36RB-Middle (19)	1747.5 (20325)	22.66	21.55	
		1732.5 (20175)	22.56	21.52	
		1717.5 (20025)	22.52	21.71	
	36RB-Low (0)	1747.5 (20325)	22.54	21.56	
		1732.5 (20175)	22.50	21.54	
		1717.5 (20025)	22.36	21.44	
	75RB (0)	1747.5 (20325)	22.52	21.65	
		1732.5 (20175)	22.58	21.54	
		1717.5 (20025)	22.41	21.58	
	20MHz	1RB-High (99)	1745 (20300)	23.64	22.16
			1732.5 (20175)	23.30	22.16
			1720 (20050)	23.45	22.04
1RB-Middle (50)		1745 (20300)	23.67	22.27	
		1732.5 (20175)	23.40	22.31	
		1720 (20050)	23.55	22.67	
1RB-Low (0)		1745 (20300)	23.78	22.51	
		1732.5 (20175)	23.29	22.25	
		1720 (20050)	23.30	22.06	
50RB-High (50)		1745 (20300)	22.63	21.57	
		1732.5 (20175)	22.59	21.66	
		1720 (20050)	22.60	21.55	

	50RB-Middle (25)	1745 (20300)	22.59	21.45
		1732.5 (20175)	22.53	21.59
		1720 (20050)	22.51	21.45
	50RB-Low (0)	1745 (20300)	22.65	21.59
		1732.5 (20175)	22.54	21.58
		1720 (20050)	22.44	21.38
	100RB (0)	1745 (20300)	22.54	21.57
		1732.5 (20175)	22.53	21.46
		1720 (20050)	22.57	21.39

LTE Band4 DS12

BANDWIDTH	Number of RBs	Frequency	QPSK	16QAM	
1.4MHz	1RB-High (5)	1754.3 (20393)	20.66	19.99	
		1732.5 (20175)	20.40	20.11	
		1710.7 (19957)	20.20	20.34	
	1RB-Middle (3)	1754.3 (20393)	20.69	20.38	
		1732.5 (20175)	20.56	20.26	
		1710.7 (19957)	20.45	20.18	
	1RB-Low (0)	1754.3 (20393)	20.50	20.31	
		1732.5 (20175)	20.45	20.03	
		1710.7 (19957)	20.25	19.93	
	3RB-High (3)	1754.3 (20393)	20.77	20.89	
		1732.5 (20175)	20.70	20.40	
		1710.7 (19957)	20.60	20.37	
	3RB-Middle (1)	1754.3 (20393)	20.80	20.46	
		1732.5 (20175)	20.62	20.54	
		1710.7 (19957)	20.42	20.17	
	3RB-Low (0)	1754.3 (20393)	20.57	20.43	
		1732.5 (20175)	20.77	20.48	
		1710.7 (19957)	20.38	20.27	
	6RB (0)	1754.3 (20393)	20.54	20.43	
		1732.5 (20175)	20.47	20.50	
		1710.7 (19957)	20.37	20.32	
	3MHz	1RB-High (14)	1753.5 (20385)	20.38	20.49
			1732.5 (20175)	20.50	20.13
			1711.5 (19965)	20.41	19.99
1RB-Middle (7)		1753.5 (20385)	20.43	20.21	
		1732.5 (20175)	20.68	20.24	
		1711.5 (19965)	20.42	20.18	

	1RB-Low (0)	1753.5 (20385)	20.25	19.94	
		1732.5 (20175)	20.78	20.20	
		1711.5 (19965)	20.39	20.14	
	8RB-High (7)	1753.5 (20385)	20.53	20.70	
		1732.5 (20175)	20.55	20.61	
		1711.5 (19965)	20.40	20.61	
	8RB-Middle (4)	1753.5 (20385)	20.57	20.65	
		1732.5 (20175)	20.67	20.77	
		1711.5 (19965)	20.42	20.53	
	8RB-Low (0)	1753.5 (20385)	20.55	20.62	
		1732.5 (20175)	20.71	20.83	
		1711.5 (19965)	20.46	20.47	
15RB (0)	1753.5 (20385)	20.62	20.57		
	1732.5 (20175)	20.61	20.56		
	1711.5 (19965)	20.46	20.44		
5MHz	1RB-High (24)	1752.5 (20375)	20.70	20.28	
		1732.5 (20175)	20.33	20.56	
		1712.5 (19975)	20.39	20.25	
	1RB-Middle (12)	1752.5 (20375)	20.50	20.37	
		1732.5 (20175)	20.41	20.33	
		1712.5 (19975)	20.47	20.20	
	1RB-Low (0)	1752.5 (20375)	20.48	20.24	
		1732.5 (20175)	20.57	20.17	
		1712.5 (19975)	20.33	20.10	
	12RB-High (13)	1752.5 (20375)	20.69	20.62	
		1732.5 (20175)	20.50	20.53	
		1712.5 (19975)	20.32	20.36	
	12RB-Middle (6)	1752.5 (20375)	20.67	20.57	
		1732.5 (20175)	20.64	20.57	
		1712.5 (19975)	20.41	20.45	
	12RB-Low (0)	1752.5 (20375)	20.57	20.59	
		1732.5 (20175)	20.56	20.49	
		1712.5 (19975)	20.33	20.35	
	25RB (0)	1752.5 (20375)	20.62	20.52	
		1732.5 (20175)	20.57	20.68	
		1712.5 (19975)	20.36	20.40	
	10MHz	1RB-High (49)	1750 (20350)	20.87	20.69
			1732.5 (20175)	20.77	20.23
			1715 (20000)	20.60	19.88
1RB-Middle (24)		1750 (20350)	20.78	20.60	

		1732.5 (20175)	20.80	20.70
		1715 (20000)	20.67	20.19
		1750 (20350)	20.82	20.60
	1RB-Low (0)	1732.5 (20175)	20.52	20.47
		1715 (20000)	20.33	20.12
		1750 (20350)	20.65	20.76
	25RB-High (25)	1732.5 (20175)	20.61	20.65
		1715 (20000)	20.40	20.50
		1750 (20350)	20.57	20.69
	25RB-Middle (12)	1732.5 (20175)	20.62	20.68
		1715 (20000)	20.41	20.47
		1750 (20350)	20.56	20.70
	25RB-Low (0)	1732.5 (20175)	20.53	20.58
		1715 (20000)	20.41	20.53
		1750 (20350)	20.68	20.62
	50RB (0)	1732.5 (20175)	20.64	20.60
		1715 (20000)	20.46	20.55
		1747.5 (20325)	20.57	20.23
15MHz	1RB-High (74)	1732.5 (20175)	20.72	20.82
		1717.5 (20025)	20.49	20.75
		1747.5 (20325)	20.78	20.05
	1RB-Middle (37)	1732.5 (20175)	20.59	20.18
		1717.5 (20025)	20.42	20.64
		1747.5 (20325)	20.73	20.00
	1RB-Low (0)	1732.5 (20175)	20.35	20.21
		1717.5 (20025)	20.48	20.12
		1747.5 (20325)	20.73	20.73
	36RB-High (38)	1732.5 (20175)	20.74	20.78
		1717.5 (20025)	20.56	20.50
		1747.5 (20325)	20.64	20.53
	36RB-Middle (19)	1732.5 (20175)	20.65	20.76
		1717.5 (20025)	20.58	20.62
		1747.5 (20325)	20.53	20.62
	36RB-Low (0)	1732.5 (20175)	20.56	20.60
		1717.5 (20025)	20.43	20.59
		1747.5 (20325)	20.61	20.61
75RB (0)	1732.5 (20175)	20.65	20.70	
	1717.5 (20025)	20.49	20.55	
	1745 (20300)	20.70	20.44	
20MHz	1RB-High (99)	1732.5 (20175)	20.65	20.89

		1720 (20050)	20.53	20.25
1RB-Middle (50)		1745 (20300)	20.81	20.81
		1732.5 (20175)	20.60	20.75
		1720 (20050)	20.50	20.27
1RB-Low (0)		1745 (20300)	20.72	20.44
		1732.5 (20175)	20.36	20.64
		1720 (20050)	20.20	20.20
50RB-High (50)		1745 (20300)	20.62	20.76
		1732.5 (20175)	20.65	20.75
		1720 (20050)	20.63	20.67
50RB-Middle (25)		1745 (20300)	20.65	20.69
		1732.5 (20175)	20.65	20.64
		1720 (20050)	20.59	20.50
50RB-Low (0)		1745 (20300)	20.61	20.67
		1732.5 (20175)	20.66	20.79
		1720 (20050)	20.45	20.37
100RB (0)		1745 (20300)	20.61	20.65
		1732.5 (20175)	20.63	20.62
		1720 (20050)	20.58	20.50

LTE Band5 DSI0/1/2

BANDWIDTH	Number of RBs	Frequency	QPSK	16QAM
1.4MHz	1RB-High (5)	848.3 (20643)	23.92	22.31
		836.5 (20525)	23.63	23.17
		824.7 (20407)	23.77	22.61
	1RB-Middle (3)	848.3 (20643)	23.89	22.67
		836.5 (20525)	23.75	23.30
		824.7 (20407)	23.88	22.44
	1RB-Low (0)	848.3 (20643)	23.86	22.47
		836.5 (20525)	23.88	22.60
		824.7 (20407)	23.61	22.30
	3RB-High (3)	848.3 (20643)	24.00	22.52
		836.5 (20525)	23.96	22.42
		824.7 (20407)	23.91	22.62
	3RB-Middle (1)	848.3 (20643)	23.98	22.78
		836.5 (20525)	23.87	22.42
		824.7 (20407)	23.95	22.71
	3RB-Low (0)	848.3 (20643)	23.98	22.76
		836.5 (20525)	23.98	22.77

	6RB (0)	824.7 (20407)	23.99	23.00	
		848.3 (20643)	22.88	22.07	
		836.5 (20525)	22.71	22.35	
		824.7 (20407)	22.72	22.29	
3MHz	1RB-High (14)	847.5 (20635)	23.90	22.37	
		836.5 (20525)	23.68	22.19	
		825.5 (20415)	23.91	22.59	
	1RB-Middle (7)	847.5 (20635)	23.92	22.69	
		836.5 (20525)	23.86	22.46	
		825.5 (20415)	23.88	22.17	
	1RB-Low (0)	847.5 (20635)	23.97	22.58	
		836.5 (20525)	23.72	22.26	
		825.5 (20415)	23.80	22.47	
	8RB-High (7)	847.5 (20635)	23.03	22.15	
		836.5 (20525)	22.78	22.16	
		825.5 (20415)	22.82	22.10	
	8RB-Middle (4)	847.5 (20635)	23.04	22.26	
		836.5 (20525)	22.79	22.04	
		825.5 (20415)	22.77	22.04	
	8RB-Low (0)	847.5 (20635)	22.74	22.15	
		836.5 (20525)	22.81	22.17	
		825.5 (20415)	22.86	22.05	
	15RB (0)	847.5 (20635)	22.97	22.01	
		836.5 (20525)	22.75	22.11	
		825.5 (20415)	22.76	22.20	
	5MHz	1RB-High (24)	846.5 (20625)	23.96	22.47
			836.5 (20525)	23.66	22.92
			826.5 (20425)	23.62	22.48
1RB-Middle (12)		846.5 (20625)	23.97	22.96	
		836.5 (20525)	23.88	23.18	
		826.5 (20425)	23.80	22.65	
1RB-Low (0)		846.5 (20625)	23.83	22.24	
		836.5 (20525)	23.83	22.15	
		826.5 (20425)	23.78	22.46	
12RB-High (13)		846.5 (20625)	23.07	22.16	
		836.5 (20525)	22.72	22.23	
		826.5 (20425)	22.70	22.06	
12RB-Middle (6)		846.5 (20625)	22.89	22.28	
		836.5 (20525)	22.84	22.08	
		826.5 (20425)	22.91	22.17	

	12RB-Low (0)	846.5 (20625)	22.88	22.36
		836.5 (20525)	22.83	22.17
		826.5 (20425)	22.75	22.10
	25RB (0)	846.5 (20625)	22.90	22.31
		836.5 (20525)	22.78	22.30
		826.5 (20425)	22.83	22.26
10MHz	1RB-High (49)	844 (20600)	23.98	22.72
		836.5 (20525)	23.84	22.41
		829 (20450)	23.59	22.41
	1RB-Middle (24)	844 (20600)	23.93	22.20
		836.5 (20525)	23.96	22.67
		829 (20450)	23.79	22.61
	1RB-Low (0)	844 (20600)	23.74	22.50
		836.5 (20525)	23.62	22.52
		829 (20450)	23.97	22.61
	25RB-High (25)	844 (20600)	22.79	22.08
		836.5 (20525)	22.84	22.00
		829 (20450)	22.68	22.25
	25RB-Middle (12)	844 (20600)	22.72	22.33
		836.5 (20525)	22.90	22.35
		829 (20450)	22.74	22.31
	25RB-Low (0)	844 (20600)	22.76	22.31
		836.5 (20525)	22.82	22.07
		829 (20450)	22.79	22.37
	50RB (0)	844 (20600)	22.92	22.04
		836.5 (20525)	22.87	22.33
		829 (20450)	22.81	22.31

LTE Band12 DSI0/1/2

BANDWIDTH	Number of RBs	Frequency	QPSK	16QAM
1.4MHz	1RB-High (5)	715.3 (23173)	23.74	22.31
		707.5 (23095)	23.98	23.12
		699.7 (23017)	23.99	23.30
	1RB-Middle (3)	715.3 (23173)	23.86	22.49
		707.5 (23095)	23.90	22.70
		699.7 (23017)	24.00	23.11
	1RB-Low (0)	715.3 (23173)	23.94	22.55
		707.5 (23095)	23.94	22.55
		699.7 (23017)	23.79	22.44

	3RB-High (3)	715.3 (23173)	23.92	23.02	
		707.5 (23095)	23.88	23.01	
		699.7 (23017)	23.95	22.62	
	3RB-Middle (1)	715.3 (23173)	23.94	23.02	
		707.5 (23095)	23.86	22.93	
		699.7 (23017)	23.99	22.87	
	3RB-Low (0)	715.3 (23173)	23.92	22.95	
		707.5 (23095)	23.72	23.01	
		699.7 (23017)	23.93	22.71	
	6RB (0)	715.3 (23173)	23.05	22.03	
		707.5 (23095)	23.07	22.17	
		699.7 (23017)	22.84	22.09	
3MHz	1RB-High (14)	714.5 (23165)	23.72	22.55	
		707.5 (23095)	23.76	23.12	
		700.5 (23025)	23.84	22.47	
	1RB-Middle (7)	714.5 (23165)	23.83	22.76	
		707.5 (23095)	23.95	22.74	
		700.5 (23025)	23.90	22.61	
	1RB-Low (0)	714.5 (23165)	23.79	22.69	
		707.5 (23095)	23.72	22.76	
		700.5 (23025)	23.59	22.48	
	8RB-High (7)	714.5 (23165)	23.01	22.15	
		707.5 (23095)	23.11	22.19	
		700.5 (23025)	23.11	22.23	
	8RB-Middle (4)	714.5 (23165)	23.10	22.25	
		707.5 (23095)	23.17	22.22	
		700.5 (23025)	23.00	22.23	
	8RB-Low (0)	714.5 (23165)	23.07	22.23	
		707.5 (23095)	23.16	22.23	
		700.5 (23025)	22.98	22.15	
	15RB (0)	714.5 (23165)	23.19	22.15	
		707.5 (23095)	23.13	22.36	
		700.5 (23025)	23.05	22.00	
	5MHz	1RB-High (24)	713.5 (23155)	23.86	22.16
			707.5 (23095)	23.90	22.12
			701.5 (23035)	23.75	22.50
1RB-Middle (12)		713.5 (23155)	23.97	22.74	
		707.5 (23095)	23.94	22.71	
		701.5 (23035)	23.78	22.73	
1RB-Low (0)		713.5 (23155)	23.95	22.56	

		707.5 (23095)	23.92	22.37
		701.5 (23035)	23.84	22.16
		713.5 (23155)	23.00	22.14
	12RB-High (13)	707.5 (23095)	22.96	22.02
		701.5 (23035)	22.97	22.19
		713.5 (23155)	23.06	22.15
	12RB-Middle (6)	707.5 (23095)	23.06	22.12
		701.5 (23035)	23.03	22.17
		713.5 (23155)	23.00	22.15
	12RB-Low (0)	707.5 (23095)	23.04	22.02
		701.5 (23035)	22.86	22.07
		713.5 (23155)	23.01	22.03
	25RB (0)	707.5 (23095)	23.00	22.08
		701.5 (23035)	23.01	22.16
		711 (23130)	23.76	22.60
10MHz	1RB-High (49)	707.5 (23095)	23.77	22.82
		704 (23060)	23.79	22.47
		711 (23130)	23.75	22.48
	1RB-Middle (24)	707.5 (23095)	23.83	23.08
		704 (23060)	23.88	22.40
		711 (23130)	23.99	22.60
	1RB-Low (0)	707.5 (23095)	23.81	22.33
		704 (23060)	23.92	22.40
		711 (23130)	22.96	22.42
	25RB-High (25)	707.5 (23095)	22.96	22.15
		704 (23060)	22.95	22.04
		711 (23130)	22.98	22.14
	25RB-Middle (12)	707.5 (23095)	22.91	22.11
		704 (23060)	22.89	22.09
		711 (23130)	22.97	22.19
	25RB-Low (0)	707.5 (23095)	22.93	22.38
		704 (23060)	22.88	22.14
		711 (23130)	23.00	22.11
	50RB (0)	707.5 (23095)	23.02	22.22
		704 (23060)	23.00	22.03

LTE Band13 DSI0/1/2

BANDWIDTH	Number of RBs	Frequency	QPSK	16QAM
-----------	---------------	-----------	------	-------

5MHz	1RB-High (24)	784.5 (23255)	23.86	22.68	
		782 (23230)	23.76	22.66	
		779.5 (23205)	23.88	22.47	
	1RB-Middle (12)	784.5 (23255)	23.78	22.39	
		782 (23230)	23.79	22.63	
		779.5 (23205)	23.88	22.67	
	1RB-Low (0)	784.5 (23255)	23.76	22.69	
		782 (23230)	23.90	22.35	
		779.5 (23205)	23.94	22.37	
	12RB-High (13)	784.5 (23255)	22.73	22.17	
		782 (23230)	22.66	22.32	
		779.5 (23205)	22.43	22.22	
	12RB-Middle (6)	784.5 (23255)	22.68	22.45	
		782 (23230)	22.35	22.37	
		779.5 (23205)	22.67	22.42	
	12RB-Low (0)	784.5 (23255)	22.38	22.19	
		782 (23230)	22.45	22.08	
		779.5 (23205)	22.46	22.42	
	25RB (0)	784.5 (23255)	22.35	22.53	
		782 (23230)	22.55	22.08	
		779.5 (23205)	22.56	22.17	
	10MHz	1RB-High (49)	782 (23230)	23.92	22.70
		1RB-Middle (24)	782 (23230)	23.95	22.71
		1RB-Low (0)	782 (23230)	23.96	22.68
25RB-High (25)		782 (23230)	22.56	22.22	
25RB-Middle (12)		782 (23230)	22.58	22.52	
25RB-Low (0)		782 (23230)	22.57	22.04	
50RB (0)		782 (23230)	22.37	22.11	

LTE Band25 DSI0

BANDWIDTH	Number of RBs	Frequency	QPSK	16QAM
1.4MHz	1RB-High (5)	1914.3 (26683)	20.30	20.42
		1882.5 (26365)	20.66	20.04
		1850.7 (26047)	20.29	20.16
	1RB-Middle (3)	1914.3 (26683)	20.44	20.23
		1882.5 (26365)	20.64	20.28
		1850.7 (26047)	20.65	20.24

	1RB-Low (0)	1914.3 (26683)	20.55	20.34
		1882.5 (26365)	20.41	20.16
		1850.7 (26047)	20.57	20.00
	3RB-High (3)	1914.3 (26683)	20.61	20.36
		1882.5 (26365)	20.78	20.54
		1850.7 (26047)	20.69	20.56
	3RB-Middle (1)	1914.3 (26683)	20.63	20.38
		1882.5 (26365)	20.83	20.55
		1850.7 (26047)	20.83	20.52
	3RB-Low (0)	1914.3 (26683)	20.53	20.52
		1882.5 (26365)	20.69	20.49
		1850.7 (26047)	20.58	20.49
6RB (0)	1914.3 (26683)	20.54	20.36	
	1882.5 (26365)	20.58	20.68	
	1850.7 (26047)	20.57	20.71	
3MHz	1RB-High (14)	1913.5 (26675)	20.67	20.06
		1882.5 (26365)	20.45	20.17
		1851.5 (26055)	20.73	20.79
	1RB-Middle (7)	1913.5 (26675)	20.78	20.34
		1882.5 (26365)	20.47	20.31
		1851.5 (26055)	20.66	20.82
	1RB-Low (0)	1913.5 (26675)	20.63	20.26
		1882.5 (26365)	20.63	20.33
		1851.5 (26055)	20.37	20.44
	8RB-High (7)	1913.5 (26675)	20.66	20.78
		1882.5 (26365)	20.71	20.82
		1851.5 (26055)	20.70	20.82
	8RB-Middle (4)	1913.5 (26675)	20.67	20.94
		1882.5 (26365)	20.75	20.89
		1851.5 (26055)	20.64	20.76
	8RB-Low (0)	1913.5 (26675)	20.73	20.80
		1882.5 (26365)	20.74	20.78
		1851.5 (26055)	20.72	20.73
15RB (0)	1913.5 (26675)	20.65	20.73	
	1882.5 (26365)	20.73	20.73	
	1851.5 (26055)	20.71	20.68	
5MHz	1RB-High (24)	1912.5 (26665)	20.44	20.18
		1882.5 (26365)	20.69	20.02
		1852.5 (26065)	20.61	20.10
	1RB-Middle (12)	1912.5 (26665)	20.80	20.63

	1RB-Low (0)	1882.5 (26365)	20.86	20.27
		1852.5 (26065)	20.54	20.26
		1912.5 (26665)	20.60	20.13
		1882.5 (26365)	20.62	20.27
		1852.5 (26065)	20.59	20.31
		1912.5 (26665)	20.65	20.42
	12RB-High (13)	1882.5 (26365)	20.66	20.58
		1852.5 (26065)	20.70	20.63
		1912.5 (26665)	20.75	20.54
	12RB-Middle (6)	1882.5 (26365)	20.72	20.66
		1852.5 (26065)	20.68	20.69
		1912.5 (26665)	20.73	20.63
	12RB-Low (0)	1882.5 (26365)	20.70	20.63
		1852.5 (26065)	20.65	20.48
		1912.5 (26665)	20.59	20.58
	25RB (0)	1882.5 (26365)	20.68	20.68
		1852.5 (26065)	20.61	20.62
		1910 (26640)	20.67	20.26
10MHz	1RB-High (49)	1882.5 (26365)	20.75	20.42
		1855 (26090)	20.72	20.26
		1910 (26640)	20.86	20.45
	1RB-Middle (24)	1882.5 (26365)	20.90	20.52
		1855 (26090)	20.83	20.42
		1910 (26640)	20.58	20.32
	1RB-Low (0)	1882.5 (26365)	20.67	20.30
		1855 (26090)	20.74	20.29
		1910 (26640)	20.78	20.79
	25RB-High (25)	1882.5 (26365)	20.74	20.73
		1855 (26090)	20.65	20.78
		1910 (26640)	20.72	20.73
	25RB-Middle (12)	1882.5 (26365)	20.78	20.77
		1855 (26090)	20.67	20.67
		1910 (26640)	20.68	20.71
	25RB-Low (0)	1882.5 (26365)	20.76	20.84
		1855 (26090)	20.74	20.75
		1910 (26640)	20.78	20.70
50RB (0)	1882.5 (26365)	20.74	20.74	
	1855 (26090)	20.74	20.66	
	1907.5 (26615)	20.59	20.26	
15MHz	1RB-High (74)	1882.5 (26365)	20.44	20.89

		1857.5 (26115)	20.62	20.10	
	1RB-Middle (37)	1907.5 (26615)	20.70	20.25	
		1882.5 (26365)	20.76	20.20	
		1857.5 (26115)	20.64	20.19	
	1RB-Low (0)	1907.5 (26615)	20.53	20.38	
		1882.5 (26365)	20.49	20.28	
		1857.5 (26115)	20.63	20.31	
	36RB-High (38)	1907.5 (26615)	20.80	20.65	
		1882.5 (26365)	20.76	20.67	
		1857.5 (26115)	20.66	20.68	
	36RB-Middle (19)	1907.5 (26615)	20.68	20.63	
		1882.5 (26365)	20.77	20.79	
		1857.5 (26115)	20.64	20.75	
	36RB-Low (0)	1907.5 (26615)	20.65	20.63	
		1882.5 (26365)	20.68	20.69	
		1857.5 (26115)	20.62	20.65	
	75RB (0)	1907.5 (26615)	20.67	20.74	
		1882.5 (26365)	20.76	20.78	
		1857.5 (26115)	20.61	20.76	
	20MHz	1RB-High (99)	1905 (26590)	20.54	20.23
			1882.5 (26365)	20.54	20.30
			1860 (26140)	20.77	20.32
		1RB-Middle (50)	1905 (26590)	20.74	20.37
			1882.5 (26365)	20.80	20.53
			1860 (26140)	20.75	20.44
		1RB-Low (0)	1905 (26590)	20.62	20.34
			1882.5 (26365)	20.68	20.31
1860 (26140)			20.79	20.33	
50RB-High (50)		1905 (26590)	20.61	20.65	
		1882.5 (26365)	20.77	20.83	
		1860 (26140)	20.79	20.74	
50RB-Middle (25)		1905 (26590)	20.69	20.66	
		1882.5 (26365)	20.78	20.77	
		1860 (26140)	20.61	20.77	
50RB-Low (0)		1905 (26590)	20.74	20.67	
		1882.5 (26365)	20.73	20.71	
		1860 (26140)	20.71	20.61	
100RB (0)		1905 (26590)	20.61	20.68	
		1882.5 (26365)	20.79	20.75	
		1860 (26140)	20.66	20.68	

LTE Band25 DSI1

BANDWIDTH	Number of RBs	Frequency	QPSK	16QAM
1.4MHz	1RB-High (5)	1914.3 (26683)	23.72	22.50
		1882.5 (26365)	23.56	22.98
		1850.7 (26047)	23.86	22.91
	1RB-Middle (3)	1914.3 (26683)	23.78	22.41
		1882.5 (26365)	23.76	22.36
		1850.7 (26047)	23.81	22.44
	1RB-Low (0)	1914.3 (26683)	23.89	22.24
		1882.5 (26365)	23.70	22.46
		1850.7 (26047)	23.69	22.06
	3RB-High (3)	1914.3 (26683)	23.91	22.91
		1882.5 (26365)	24.00	23.21
		1850.7 (26047)	23.96	22.64
	3RB-Middle (1)	1914.3 (26683)	23.81	22.95
		1882.5 (26365)	23.96	22.79
		1850.7 (26047)	23.77	22.74
	3RB-Low (0)	1914.3 (26683)	23.78	22.98
		1882.5 (26365)	23.99	22.76
		1850.7 (26047)	23.80	22.63
	6RB (0)	1914.3 (26683)	22.82	21.76
		1882.5 (26365)	22.87	21.83
		1850.7 (26047)	22.77	21.89
3MHz	1RB-High (14)	1913.5 (26675)	23.68	22.57
		1882.5 (26365)	23.89	22.33
		1851.5 (26055)	23.86	22.77
	1RB-Middle (7)	1913.5 (26675)	23.96	22.74
		1882.5 (26365)	23.75	22.51
		1851.5 (26055)	23.86	22.61
	1RB-Low (0)	1913.5 (26675)	24.00	22.46
		1882.5 (26365)	23.67	22.47
		1851.5 (26055)	23.74	22.28
	8RB-High (7)	1913.5 (26675)	22.93	21.74
		1882.5 (26365)	22.78	21.94
		1851.5 (26055)	22.88	21.88
	8RB-Middle (4)	1913.5 (26675)	23.07	21.87
		1882.5 (26365)	22.92	21.99
		1851.5 (26055)	22.80	21.80

	8RB-Low (0)	1913.5 (26675)	23.06	21.89	
		1882.5 (26365)	22.89	22.05	
		1851.5 (26055)	22.89	21.81	
	15RB (0)	1913.5 (26675)	22.92	21.55	
		1882.5 (26365)	22.89	21.80	
		1851.5 (26055)	22.85	21.89	
5MHz	1RB-High (24)	1912.5 (26665)	23.84	22.37	
		1882.5 (26365)	23.70	22.36	
		1852.5 (26065)	23.70	22.54	
	1RB-Middle (12)	1912.5 (26665)	23.93	23.01	
		1882.5 (26365)	23.81	22.39	
		1852.5 (26065)	23.77	22.52	
	1RB-Low (0)	1912.5 (26665)	23.71	22.23	
		1882.5 (26365)	23.83	22.32	
		1852.5 (26065)	23.68	22.45	
	12RB-High (13)	1912.5 (26665)	22.78	21.60	
		1882.5 (26365)	22.93	21.80	
		1852.5 (26065)	22.82	21.88	
	12RB-Middle (6)	1912.5 (26665)	22.89	21.76	
		1882.5 (26365)	22.90	21.78	
		1852.5 (26065)	22.84	21.62	
	12RB-Low (0)	1912.5 (26665)	22.91	21.70	
		1882.5 (26365)	22.85	21.78	
		1852.5 (26065)	22.82	21.51	
	25RB (0)	1912.5 (26665)	22.88	21.85	
		1882.5 (26365)	22.94	21.91	
		1852.5 (26065)	22.88	21.74	
	10MHz	1RB-High (49)	1910 (26640)	23.96	22.76
			1882.5 (26365)	23.79	23.06
			1855 (26090)	23.87	23.09
1RB-Middle (24)		1910 (26640)	24.08	22.83	
		1882.5 (26365)	24.06	22.48	
		1855 (26090)	23.92	23.02	
1RB-Low (0)		1910 (26640)	23.89	22.42	
		1882.5 (26365)	24.07	22.48	
		1855 (26090)	23.99	22.64	
25RB-High (25)		1910 (26640)	22.94	21.92	
		1882.5 (26365)	23.02	21.91	
		1855 (26090)	22.95	21.86	
25RB-Middle (12)	1910 (26640)	22.91	21.92		

		1882.5 (26365)	22.98	22.04	
		1855 (26090)	22.83	21.82	
		1910 (26640)	22.83	21.84	
	25RB-Low (0)	1882.5 (26365)	22.88	21.77	
		1855 (26090)	22.88	21.79	
		1910 (26640)	22.90	22.05	
	50RB (0)	1882.5 (26365)	22.99	21.88	
		1855 (26090)	22.95	21.88	
15MHz	1RB-High (74)	1907.5 (26615)	23.56	22.53	
		1882.5 (26365)	23.79	22.54	
		1857.5 (26115)	23.75	23.04	
	1RB-Middle (37)	1907.5 (26615)	23.86	23.12	
		1882.5 (26365)	23.95	23.14	
		1857.5 (26115)	23.93	22.11	
	1RB-Low (0)	1907.5 (26615)	23.64	22.67	
		1882.5 (26365)	23.77	22.49	
		1857.5 (26115)	23.70	22.08	
	36RB-High (38)	1907.5 (26615)	22.82	21.78	
		1882.5 (26365)	22.97	21.89	
		1857.5 (26115)	22.97	21.89	
	36RB-Middle (19)	1907.5 (26615)	22.89	22.05	
		1882.5 (26365)	22.90	22.01	
		1857.5 (26115)	22.93	21.93	
	36RB-Low (0)	1907.5 (26615)	22.86	21.95	
		1882.5 (26365)	22.92	21.82	
		1857.5 (26115)	22.80	21.71	
	75RB (0)	1907.5 (26615)	22.93	22.04	
		1882.5 (26365)	23.03	21.84	
		1857.5 (26115)	22.92	21.76	
	20MHz	1RB-High (99)	1905 (26590)	24.08	22.40
			1882.5 (26365)	24.00	22.42
			1860 (26140)	24.01	22.38
		1RB-Middle (50)	1905 (26590)	24.02	23.13
			1882.5 (26365)	24.03	23.12
			1860 (26140)	23.78	22.38
1RB-Low (0)		1905 (26590)	23.82	22.53	
		1882.5 (26365)	23.93	22.45	
		1860 (26140)	23.95	22.54	
50RB-High (50)		1905 (26590)	22.85	21.75	
		1882.5 (26365)	22.84	21.83	

	50RB-Middle (25)	1860 (26140)	22.88	21.82
		1905 (26590)	22.87	21.80
		1882.5 (26365)	22.90	21.81
		1860 (26140)	22.86	21.79
	50RB-Low (0)	1905 (26590)	22.88	21.83
		1882.5 (26365)	22.89	21.71
		1860 (26140)	22.80	21.81
	100RB (0)	1905 (26590)	22.84	21.86
		1882.5 (26365)	22.91	21.81
		1860 (26140)	22.83	21.83

LTE Band25 DSI2

BANDWIDTH	Number of RBs	Frequency	QPSK	16QAM
1.4MHz	1RB-High (5)	1914.3 (26683)	20.77	20.12
		1882.5 (26365)	20.79	20.99
		1850.7 (26047)	20.55	20.22
	1RB-Middle (3)	1914.3 (26683)	20.78	20.56
		1882.5 (26365)	20.84	20.26
		1850.7 (26047)	20.72	20.57
	1RB-Low (0)	1914.3 (26683)	20.68	20.23
		1882.5 (26365)	20.89	20.12
		1850.7 (26047)	20.79	20.40
	3RB-High (3)	1914.3 (26683)	20.95	20.47
		1882.5 (26365)	20.89	20.81
		1850.7 (26047)	20.86	20.84
	3RB-Middle (1)	1914.3 (26683)	20.87	20.62
		1882.5 (26365)	20.96	20.81
		1850.7 (26047)	20.85	20.71
	3RB-Low (0)	1914.3 (26683)	20.87	20.67
		1882.5 (26365)	20.92	20.74
		1850.7 (26047)	20.79	20.77
	6RB (0)	1914.3 (26683)	20.75	20.64
		1882.5 (26365)	20.82	20.71
		1850.7 (26047)	20.81	20.89
3MHz	1RB-High (14)	1913.5 (26675)	20.68	20.37
		1882.5 (26365)	20.91	20.09
		1851.5 (26055)	20.88	20.16
	1RB-Middle (7)	1913.5 (26675)	20.98	20.59
		1882.5 (26365)	20.99	20.56

	1RB-Low (0)	1851.5 (26055)	20.78	20.30
		1913.5 (26675)	20.83	20.30
		1882.5 (26365)	21.00	20.10
	8RB-High (7)	1851.5 (26055)	20.50	20.28
		1913.5 (26675)	20.98	20.83
		1882.5 (26365)	20.94	20.98
	8RB-Middle (4)	1851.5 (26055)	20.88	20.97
		1913.5 (26675)	21.00	20.97
		1882.5 (26365)	20.98	20.89
	8RB-Low (0)	1851.5 (26055)	20.80	20.88
		1913.5 (26675)	20.88	20.88
		1882.5 (26365)	20.95	21.00
	15RB (0)	1851.5 (26055)	20.77	20.89
		1913.5 (26675)	20.87	20.99
		1882.5 (26365)	20.95	20.96
5MHz	1RB-High (24)	1851.5 (26055)	20.91	20.99
		1912.5 (26665)	20.56	20.28
		1882.5 (26365)	20.91	20.31
	1RB-Middle (12)	1852.5 (26065)	20.73	20.17
		1912.5 (26665)	20.97	20.31
		1882.5 (26365)	20.88	20.43
	1RB-Low (0)	1852.5 (26065)	20.75	20.38
		1912.5 (26665)	20.72	20.52
		1882.5 (26365)	20.88	20.47
	12RB-High (13)	1852.5 (26065)	20.75	20.34
		1912.5 (26665)	20.93	20.78
		1882.5 (26365)	20.98	20.86
	12RB-Middle (6)	1852.5 (26065)	20.89	20.86
		1912.5 (26665)	20.96	20.89
		1882.5 (26365)	20.84	20.84
12RB-Low (0)	1852.5 (26065)	20.75	20.94	
	1912.5 (26665)	21.00	20.76	
	1882.5 (26365)	20.98	20.77	
25RB (0)	1852.5 (26065)	20.83	20.73	
	1912.5 (26665)	20.90	20.83	
	1882.5 (26365)	20.98	20.86	
10MHz	1RB-High (49)	1852.5 (26065)	20.89	20.87
		1910 (26640)	20.87	20.44
		1882.5 (26365)	20.95	20.68
		1855 (26090)	20.89	20.47

	1RB-Middle (24)	1910 (26640)	20.67	20.45	
		1882.5 (26365)	20.99	20.28	
		1855 (26090)	20.66	20.65	
	1RB-Low (0)	1910 (26640)	20.93	20.47	
		1882.5 (26365)	20.85	20.55	
		1855 (26090)	20.88	20.61	
	25RB-High (25)	1910 (26640)	20.91	20.98	
		1882.5 (26365)	20.74	20.88	
		1855 (26090)	20.84	20.99	
	25RB-Middle (12)	1910 (26640)	20.99	20.77	
		1882.5 (26365)	20.84	20.76	
		1855 (26090)	20.79	20.75	
	25RB-Low (0)	1910 (26640)	20.92	20.92	
		1882.5 (26365)	20.96	20.93	
		1855 (26090)	20.86	20.71	
	50RB (0)	1910 (26640)	20.93	20.95	
		1882.5 (26365)	20.97	20.95	
		1855 (26090)	20.94	20.89	
	15MHz	1RB-High (74)	1907.5 (26615)	20.88	20.51
			1882.5 (26365)	20.96	20.32
			1857.5 (26115)	20.87	20.99
		1RB-Middle (37)	1907.5 (26615)	20.92	20.98
			1882.5 (26365)	20.90	20.11
			1857.5 (26115)	20.87	20.92
1RB-Low (0)		1907.5 (26615)	20.99	20.78	
		1882.5 (26365)	20.96	20.16	
		1857.5 (26115)	20.90	20.53	
36RB-High (38)		1907.5 (26615)	20.93	20.91	
		1882.5 (26365)	20.97	20.94	
		1857.5 (26115)	20.92	20.98	
36RB-Middle (19)		1907.5 (26615)	20.95	20.96	
		1882.5 (26365)	20.91	20.98	
		1857.5 (26115)	20.85	20.97	
36RB-Low (0)		1907.5 (26615)	20.84	20.85	
		1882.5 (26365)	20.91	20.87	
		1857.5 (26115)	20.73	20.80	
75RB (0)		1907.5 (26615)	20.96	20.97	
		1882.5 (26365)	20.94	20.90	
		1857.5 (26115)	20.86	20.92	
20MHz		1RB-High (99)	1905 (26590)	20.97	20.48

		1882.5 (26365)	20.81	20.89
		1860 (26140)	20.98	20.38
	1RB-Middle (50)	1905 (26590)	20.89	20.79
		1882.5 (26365)	21.00	20.55
		1860 (26140)	20.87	20.40
	1RB-Low (0)	1905 (26590)	20.96	20.63
		1882.5 (26365)	20.75	20.15
		1860 (26140)	20.69	19.98
	50RB-High (50)	1905 (26590)	20.88	20.99
		1882.5 (26365)	20.96	20.99
		1860 (26140)	20.97	20.96
	50RB-Middle (25)	1905 (26590)	20.97	20.97
		1882.5 (26365)	20.96	20.84
		1860 (26140)	20.95	20.94
	50RB-Low (0)	1905 (26590)	20.99	20.86
		1882.5 (26365)	20.92	20.98
		1860 (26140)	20.86	20.84
	100RB (0)	1905 (26590)	20.77	21.00
		1882.5 (26365)	20.89	20.98
		1860 (26140)	20.92	20.87

LTE Band26 DSI0/1/2

BANDWIDTH	Number of RBs	Frequency	QPSK	16QAM
1.4MHz	1RB-High (5)	848.3 (27033)	23.86	22.76
		831.5 (26865)	23.89	22.81
		814.7 (26697)	23.78	22.09
	1RB-Middle (3)	848.3 (27033)	23.97	22.73
		831.5 (26865)	23.92	22.48
		814.7 (26697)	23.83	22.49
	1RB-Low (0)	848.3 (27033)	23.89	22.90
		831.5 (26865)	23.87	22.43
		814.7 (26697)	23.68	22.45
	3RB-High (3)	848.3 (27033)	23.97	22.84
		831.5 (26865)	23.98	22.80
		814.7 (26697)	23.76	22.83
	3RB-Middle (1)	848.3 (27033)	23.97	22.96
		831.5 (26865)	23.98	22.88
		814.7 (26697)	23.83	22.71
	3RB-Low (0)	848.3 (27033)	23.93	21.96

	6RB (0)	831.5 (26865)	23.94	22.83	
		814.7 (26697)	23.96	22.75	
		848.3 (27033)	22.95	21.94	
		831.5 (26865)	22.84	21.73	
		814.7 (26697)	22.78	21.63	
3MHz	1RB-High (14)	847.5 (27025)	23.13	22.51	
		831.5 (26865)	23.05	22.80	
		815.5 (26705)	23.88	22.23	
	1RB-Middle (7)	847.5 (27025)	23.11	22.68	
		831.5 (26865)	23.04	22.59	
		815.5 (26705)	23.95	22.43	
	1RB-Low (0)	847.5 (27025)	23.22	22.89	
		831.5 (26865)	23.93	22.57	
		815.5 (26705)	23.10	22.40	
	8RB-High (7)	847.5 (27025)	22.20	21.97	
		831.5 (26865)	22.11	21.87	
		815.5 (26705)	22.94	21.92	
	8RB-Middle (4)	847.5 (27025)	22.21	21.89	
		831.5 (26865)	23.00	21.62	
		815.5 (26705)	22.94	21.72	
	8RB-Low (0)	847.5 (27025)	22.20	21.92	
		831.5 (26865)	22.94	21.77	
		815.5 (26705)	22.90	21.69	
	15RB (0)	847.5 (27025)	22.10	21.64	
		831.5 (26865)	22.01	21.65	
		815.5 (26705)	22.88	21.40	
	5MHz	1RB-High (24)	846.5 (27015)	23.09	22.45
			831.5 (26865)	23.62	22.38
			816.5 (26715)	23.93	22.61
1RB-Middle (12)		846.5 (27015)	23.21	22.40	
		831.5 (26865)	23.05	22.48	
		816.5 (26715)	23.86	22.64	
1RB-Low (0)		846.5 (27015)	23.10	22.52	
		831.5 (26865)	23.97	22.25	
		816.5 (26715)	23.81	22.44	
12RB-High (13)		846.5 (27015)	22.01	21.92	
		831.5 (26865)	22.83	21.90	
		816.5 (26715)	22.90	21.86	

	12RB-Middle (6)	846.5 (27015)	22.17	21.86
		831.5 (26865)	22.76	21.84
		816.5 (26715)	22.88	21.93
	12RB-Low (0)	846.5 (27015)	22.23	21.89
		831.5 (26865)	22.90	21.87
		816.5 (26715)	22.88	21.83
	25RB (0)	846.5 (27015)	22.06	21.96
		831.5 (26865)	22.89	21.95
		816.5 (26715)	22.81	21.55
10MHz	1RB-High (49)	844 (26990)	23.28	22.41
		831.5 (26865)	23.06	22.38
		820 (26750)	23.04	22.49
	1RB-Middle (24)	844 (26990)	23.39	22.97
		831.5 (26865)	23.06	22.96
		820 (26750)	23.07	22.40
	1RB-Low (0)	844 (26990)	23.25	22.89
		831.5 (26865)	23.10	22.55
		820 (26750)	23.73	22.37
	25RB-High (25)	844 (26990)	22.16	21.58
		831.5 (26865)	22.96	21.84
		820 (26750)	22.95	21.35
	25RB-Middle (12)	844 (26990)	22.29	21.85
		831.5 (26865)	22.09	21.96
		820 (26750)	22.11	21.90
	25RB-Low (0)	844 (26990)	22.16	21.99
		831.5 (26865)	22.98	21.98
		820 (26750)	22.88	21.81
	50RB (0)	844 (26990)	22.26	21.97
		831.5 (26865)	22.05	21.96
		820 (26750)	22.95	21.98
15MHz	1RB-High (74)	841.5 (26965)	23.03	22.38
		831.5 (26865)	23.03	22.53
		822.5 (26775)	23.01	22.39
	1RB-Middle (37)	841.5 (26965)	23.87	22.35
		831.5 (26865)	23.04	22.17
		822.5 (26775)	23.03	22.27
	1RB-Low (0)	841.5 (26965)	23.23	22.73
		831.5 (26865)	23.14	22.70
		822.5 (26775)	23.42	22.58
	36RB-High (38)	841.5 (26965)	22.23	21.54

		831.5 (26865)	22.95	21.98
		822.5 (26775)	22.02	22.00
	36RB-Middle (19)	841.5 (26965)	22.99	21.56
		831.5 (26865)	22.94	21.89
		822.5 (26775)	22.01	21.99
	36RB-Low (0)	841.5 (26965)	22.06	21.87
		831.5 (26865)	22.02	21.69
		822.5 (26775)	22.92	21.90
	75RB (0)	841.5 (26965)	22.16	21.38
		831.5 (26865)	22.98	22.00
		822.5 (26775)	22.96	21.72

LTE Band41 PC2 DSI0

BANDWIDTH	Number of RBs	Frequency	QPSK	16QAM
5MHz	1RB-High (24)	2687.5 (41565)	22.82	22.27
		2640.3(41093)	22.55	22.20
		2593 (40620)	22.75	22.34
		2545.8(40148)	22.88	22.45
		2498.5 (39675)	22.76	22.69
	1RB-Middle (12)	2687.5 (41565)	22.81	22.56
		2640.3(41093)	22.79	22.30
		2593 (40620)	22.97	22.76
		2545.8(40148)	22.73	22.46
		2498.5 (39675)	22.87	22.82
	1RB-Low (0)	2687.5 (41565)	22.90	22.51
		2640.3(41093)	22.86	22.23
		2593 (40620)	22.76	22.55
		2545.8(40148)	22.93	22.33
		2498.5 (39675)	22.92	22.65
	12RB-High (13)	2687.5 (41565)	22.89	22.85
		2640.3(41093)	22.80	22.73
		2593 (40620)	22.72	22.63
		2545.8(40148)	22.89	22.95
		2498.5 (39675)	22.99	22.54
	12RB-Middle (6)	2687.5 (41565)	22.97	22.62
		2640.3(41093)	22.80	22.74
		2593 (40620)	22.84	22.88

		2545.8(40148)	22.89	22.98	
		2498.5 (39675)	22.73	22.84	
	12RB-Low (0)	2687.5 (41565)	22.95	22.94	
		2640.3(41093)	22.71	22.66	
		2593 (40620)	22.88	22.91	
		2545.8(40148)	22.81	22.81	
		2498.5 (39675)	22.98	22.85	
	25RB (0)	2687.5 (41565)	22.86	22.79	
		2640.3(41093)	22.72	22.95	
		2593 (40620)	22.76	22.70	
		2545.8(40148)	22.92	22.81	
		2498.5 (39675)	22.81	22.97	
	10MHz	1RB-High (49)	2685 (41540)	22.90	22.49
			2639(41080)	22.69	22.26
			2593 (40620)	22.83	22.34
2547(40160)			22.81	22.45	
2501 (39700)			22.90	22.70	
1RB-Middle (24)		2685 (41540)	22.78	22.82	
		2639(41080)	22.95	22.55	
		2593 (40620)	22.83	22.75	
		2547(40160)	22.82	22.70	
		2501 (39700)	23.00	22.76	
1RB-Low (0)		2685 (41540)	22.71	22.56	
		2639(41080)	22.86	22.26	
		2593 (40620)	22.92	22.63	
		2547(40160)	22.72	22.52	
		2501 (39700)	22.75	22.71	
25RB-High (25)		2685 (41540)	22.85	22.83	
		2639(41080)	22.74	22.87	
		2593 (40620)	22.76	22.96	
		2547(40160)	22.92	22.78	
		2501 (39700)	22.86	22.73	
25RB-Middle (12)		2685 (41540)	22.75	22.94	
		2639(41080)	22.78	22.91	
		2593 (40620)	22.85	22.78	
		2547(40160)	22.99	22.93	
		2501 (39700)	22.86	22.80	

	25RB-Low (0)	2685 (41540)	22.97	22.98
		2639(41080)	22.77	22.69
		2593 (40620)	22.90	22.81
		2547(40160)	22.88	22.93
		2501 (39700)	22.73	22.89
	50RB (0)	2685 (41540)	23.00	22.71
		2639(41080)	22.75	22.80
		2593 (40620)	22.82	22.97
		2547(40160)	22.95	22.85
		2501 (39700)	22.93	22.71
15MHz	1RB-High (74)	2682.5 (41515)	22.90	22.49
		2637.8(41068)	22.69	22.26
		2593 (40620)	22.83	22.34
		2548.3(40173)	22.81	22.45
		2503.5 (39725)	22.90	22.70
	1RB-Middle (37)	2682.5 (41515)	22.78	22.82
		2637.8(41068)	22.95	22.55
		2593 (40620)	22.83	22.75
		2548.3(40173)	22.82	22.70
		2503.5 (39725)	23.00	22.76
	1RB-Low (0)	2682.5 (41515)	22.71	22.56
		2637.8(41068)	22.86	22.26
		2593 (40620)	22.92	22.63
		2548.3(40173)	22.72	22.52
		2503.5 (39725)	22.75	22.71
	36RB-High (38)	2682.5 (41515)	22.85	22.83
		2637.8(41068)	22.74	22.87
		2593 (40620)	22.76	22.96
		2548.3(40173)	22.92	22.78
		2503.5 (39725)	22.86	22.73
	36RB-Middle (19)	2682.5 (41515)	22.75	22.94
		2637.8(41068)	22.78	22.91
		2593 (40620)	22.85	22.78
		2548.3(40173)	22.99	22.93
		2503.5 (39725)	22.86	22.80
	36RB-Low (0)	2682.5 (41515)	22.97	22.98
		2637.8(41068)	22.77	22.69

		2593 (40620)	22.90	22.81	
		2548.3(40173)	22.88	22.93	
		2503.5 (39725)	22.73	22.89	
	75RB (0)	2682.5 (41515)	23.00	22.71	
		2637.8(41068)	22.75	22.80	
		2593 (40620)	22.82	22.97	
		2548.3(40173)	22.95	22.85	
		2503.5 (39725)	22.93	22.71	
	20MHz	1RB-High (99)	2680 (41490)	22.74	22.32
			2636.5(41055)	22.57	22.37
2593 (40620)			22.51	22.03	
2549.5(40185)			22.38	22.50	
2506 (39750)			22.64	22.65	
1RB-Middle (50)		2680 (41490)	22.53	22.56	
		2636.5(41055)	22.89	22.53	
		2593 (40620)	22.63	22.69	
		2549.5(40185)	22.95	22.63	
		2506 (39750)	22.48	22.89	
1RB-Low (0)		2680 (41490)	22.77	22.35	
		2636.5(41055)	22.81	22.41	
		2593 (40620)	22.33	22.61	
		2549.5(40185)	22.90	22.43	
		2506 (39750)	22.92	22.45	
50RB-High (50)		2680 (41490)	22.78	22.89	
		2636.5(41055)	22.70	22.67	
		2593 (40620)	22.66	22.62	
		2549.5(40185)	22.82	22.85	
		2506 (39750)	22.94	22.81	
50RB-Middle (25)	2680 (41490)	22.86	22.90		
	2636.5(41055)	22.73	22.81		
	2593 (40620)	22.86	22.83		
	2549.5(40185)	22.90	22.91		
	2506 (39750)	22.51	22.77		
50RB-Low (0)	2680 (41490)	22.84	22.89		
	2636.5(41055)	22.82	22.79		
	2593 (40620)	22.49	23.00		
	2549.5(40185)	22.85	22.88		

		2506 (39750)	22.90	22.93
	100RB (0)	2680 (41490)	22.86	22.89
		2636.5(41055)	22.75	22.81
		2593 (40620)	22.79	22.76
		2549.5(40185)	22.97	22.91
		2506 (39750)	22.88	22.74

LTE Band41 PC2 DSI1

BANDWIDTH	Number of RBs	Frequency	QPSK	16QAM
5MHz	1RB-High (24)	2687.5 (41565)	25.74	24.30
		2640.3(41093)	25.47	24.29
		2593 (40620)	25.56	24.27
		2545.8(40148)	25.67	24.36
		2498.5 (39675)	25.89	24.80
	1RB-Middle (12)	2687.5 (41565)	25.82	24.60
		2640.3(41093)	25.78	24.31
		2593 (40620)	26.01	24.51
		2545.8(40148)	26.06	24.44
		2498.5 (39675)	26.16	24.75
	1RB-Low (0)	2687.5 (41565)	25.68	24.53
		2640.3(41093)	25.59	24.22
		2593 (40620)	25.65	24.58
		2545.8(40148)	25.71	24.40
		2498.5 (39675)	25.74	24.66
	12RB-High (13)	2687.5 (41565)	24.91	23.93
		2640.3(41093)	24.69	23.87
		2593 (40620)	24.75	23.95
		2545.8(40148)	24.92	23.99
		2498.5 (39675)	25.09	23.90
	12RB-Middle (6)	2687.5 (41565)	24.98	24.14
		2640.3(41093)	24.81	23.87
		2593 (40620)	24.88	23.88
		2545.8(40148)	24.93	24.03
		2498.5 (39675)	25.16	24.19
	12RB-Low (0)	2687.5 (41565)	24.97	24.13
		2640.3(41093)	24.72	23.58

		2593 (40620)	24.81	23.82	
		2545.8(40148)	24.87	23.75	
		2498.5 (39675)	25.07	24.09	
	25RB (0)	2687.5 (41565)	25.00	23.93	
		2640.3(41093)	24.73	24.08	
		2593 (40620)	24.79	23.80	
		2545.8(40148)	24.86	24.15	
		2498.5 (39675)	25.00	24.11	
	10MHz	1RB-High (49)	2685 (41540)	25.54	24.65
			2639(41080)	25.52	24.45
			2593 (40620)	25.57	24.32
2547(40160)			25.62	24.49	
2501 (39700)			25.94	24.84	
1RB-Middle (24)		2685 (41540)	25.95	24.85	
		2639(41080)	25.83	24.56	
		2593 (40620)	25.82	24.69	
		2547(40160)	25.93	24.71	
		2501 (39700)	26.17	24.73	
1RB-Low (0)		2685 (41540)	25.79	24.63	
		2639(41080)	25.76	24.46	
		2593 (40620)	25.97	24.51	
		2547(40160)	25.71	24.39	
		2501 (39700)	25.86	24.71	
25RB-High (25)		2685 (41540)	24.90	24.04	
		2639(41080)	24.75	23.80	
		2593 (40620)	24.71	24.05	
		2547(40160)	24.97	24.14	
		2501 (39700)	25.25	24.16	
25RB-Middle (12)		2685 (41540)	25.00	24.33	
		2639(41080)	24.81	23.84	
		2593 (40620)	24.89	24.17	
		2547(40160)	24.94	24.20	
	2501 (39700)	25.17	24.26		
25RB-Low (0)	2685 (41540)	25.03	24.31		
	2639(41080)	24.80	23.84		
	2593 (40620)	24.93	24.19		
	2547(40160)	24.93	23.89		

		2501 (39700)	25.01	24.40
	50RB (0)	2685 (41540)	25.10	24.01
		2639(41080)	24.86	23.77
		2593 (40620)	24.79	23.95
		2547(40160)	25.00	23.90
		2501 (39700)	25.23	24.26
15MHz	1RB-High (74)	2682.5 (41515)	25.67	24.58
		2637.8(41068)	25.56	24.43
		2593 (40620)	25.51	24.33
		2548.3(40173)	25.76	24.40
		2503.5 (39725)	25.96	24.73
	1RB-Middle (37)	2682.5 (41515)	25.85	24.62
		2637.8(41068)	25.69	24.39
		2593 (40620)	25.66	24.59
		2548.3(40173)	25.87	24.60
		2503.5 (39725)	25.86	24.67
	1RB-Low (0)	2682.5 (41515)	25.88	24.66
		2637.8(41068)	25.71	24.52
		2593 (40620)	25.88	24.75
		2548.3(40173)	25.83	24.58
		2503.5 (39725)	25.78	24.61
	36RB-High (38)	2682.5 (41515)	24.99	23.95
		2637.8(41068)	24.85	23.83
		2593 (40620)	24.77	23.79
		2548.3(40173)	24.85	23.96
		2503.5 (39725)	25.04	24.17
	36RB-Middle (19)	2682.5 (41515)	25.01	24.06
		2637.8(41068)	24.82	23.89
		2593 (40620)	24.97	23.90
		2548.3(40173)	24.93	24.03
		2503.5 (39725)	25.09	24.23
	36RB-Low (0)	2682.5 (41515)	25.02	24.05
		2637.8(41068)	24.82	23.80
		2593 (40620)	24.96	23.97
		2548.3(40173)	24.91	24.01
		2503.5 (39725)	25.01	24.13
	75RB (0)	2682.5 (41515)	24.96	24.06

		2637.8(41068)	24.88	24.00
		2593 (40620)	24.88	23.92
		2548.3(40173)	24.99	24.03
		2503.5 (39725)	25.08	24.23
20MHz	1RB-High (99)	2680 (41490)	25.60	24.45
		2636.5(41055)	25.41	24.41
		2593 (40620)	25.56	24.17
		2549.5(40185)	25.67	24.29
		2506 (39750)	26.00	24.74
	1RB-Middle (50)	2680 (41490)	25.88	24.74
		2636.5(41055)	25.72	24.51
		2593 (40620)	25.79	24.70
		2549.5(40185)	25.88	24.69
		2506 (39750)	25.95	24.91
	1RB-Low (0)	2680 (41490)	25.60	24.65
		2636.5(41055)	25.85	24.50
		2593 (40620)	25.95	24.74
		2549.5(40185)	25.74	24.56
		2506 (39750)	25.78	24.50
	50RB-High (50)	2680 (41490)	24.94	23.94
		2636.5(41055)	24.81	23.88
		2593 (40620)	24.67	23.81
		2549.5(40185)	24.83	23.96
		2506 (39750)	25.11	24.25
	50RB-Middle (25)	2680 (41490)	24.88	23.99
		2636.5(41055)	24.82	23.92
		2593 (40620)	24.89	24.01
		2549.5(40185)	24.89	24.01
		2506 (39750)	25.03	24.17
	50RB-Low (0)	2680 (41490)	24.87	23.99
		2636.5(41055)	24.91	23.91
		2593 (40620)	24.93	24.08
		2549.5(40185)	24.94	23.97
		2506 (39750)	24.98	24.04
	100RB (0)	2680 (41490)	24.85	23.98
		2636.5(41055)	24.85	23.85
		2593 (40620)	24.80	23.95

		2549.5(40185)	24.98	24.02
		2506 (39750)	25.13	24.18

LTE Band41 PC2 DSI2

BANDWIDTH	Number of RBs	Frequency	QPSK	16QAM
5MHz	1RB-High (24)	2687.5 (41565)	21.80	21.27
		2640.3(41093)	21.58	21.27
		2593 (40620)	21.67	21.28
		2545.8(40148)	21.88	21.35
		2498.5 (39675)	21.84	21.71
	1RB-Middle (12)	2687.5 (41565)	21.98	21.64
		2640.3(41093)	21.87	21.26
		2593 (40620)	21.81	21.48
		2545.8(40148)	21.97	21.55
		2498.5 (39675)	21.88	21.76
	1RB-Low (0)	2687.5 (41565)	21.85	21.51
		2640.3(41093)	21.60	21.29
		2593 (40620)	21.92	21.43
		2545.8(40148)	21.82	21.40
		2498.5 (39675)	21.91	21.61
	12RB-High (13)	2687.5 (41565)	21.85	21.83
		2640.3(41093)	21.75	21.77
		2593 (40620)	21.79	21.72
		2545.8(40148)	21.88	21.97
		2498.5 (39675)	21.74	21.48
	12RB-Middle (6)	2687.5 (41565)	21.83	21.95
		2640.3(41093)	21.74	21.78
		2593 (40620)	21.91	21.86
		2545.8(40148)	21.87	21.79
		2498.5 (39675)	21.89	21.99
12RB-Low (0)	2687.5 (41565)	21.81	21.83	
	2640.3(41093)	21.66	21.58	
	2593 (40620)	21.85	21.79	
	2545.8(40148)	21.90	22.00	
	2498.5 (39675)	22.00	21.90	
25RB (0)	2687.5 (41565)	21.92	21.86	

		2640.3(41093)	21.76	21.94
		2593 (40620)	21.74	21.66
		2545.8(40148)	21.89	21.90
		2498.5 (39675)	21.81	21.81
10MHz	1RB-High (49)	2685 (41540)	21.89	21.60
		2639(41080)	21.75	21.36
		2593 (40620)	21.71	21.24
		2547(40160)	21.90	21.44
		2501 (39700)	21.99	21.67
	1RB-Middle (24)	2685 (41540)	21.93	21.73
		2639(41080)	21.91	21.57
		2593 (40620)	21.84	21.76
		2547(40160)	21.89	21.66
		2501 (39700)	21.88	21.83
	1RB-Low (0)	2685 (41540)	21.96	21.62
		2639(41080)	21.83	21.46
		2593 (40620)	22.00	21.54
		2547(40160)	21.88	21.55
		2501 (39700)	21.83	21.71
	25RB-High (25)	2685 (41540)	21.88	21.88
		2639(41080)	21.79	21.65
		2593 (40620)	21.78	21.79
		2547(40160)	21.98	21.86
		2501 (39700)	21.93	21.90
	25RB-Middle (12)	2685 (41540)	21.97	21.89
		2639(41080)	21.83	21.81
		2593 (40620)	21.90	21.99
		2547(40160)	21.93	21.96
		2501 (39700)	21.81	21.90
	25RB-Low (0)	2685 (41540)	22.00	21.81
		2639(41080)	21.71	21.78
		2593 (40620)	21.83	21.93
		2547(40160)	21.83	21.90
		2501 (39700)	21.99	21.97
	50RB (0)	2685 (41540)	22.00	21.87
		2639(41080)	21.79	21.79
		2593 (40620)	21.86	21.77

		2547(40160)	21.89	21.91
		2501 (39700)	21.99	22.00
15MHz	1RB-High (74)	2682.5 (41515)	21.82	21.50
		2637.8(41068)	21.88	21.50
		2593 (40620)	21.76	21.18
		2548.3(40173)	21.98	21.60
		2503.5 (39725)	21.92	21.65
	1RB-Middle (37)	2682.5 (41515)	21.91	21.64
		2637.8(41068)	21.86	21.41
		2593 (40620)	21.97	21.56
		2548.3(40173)	21.90	21.45
		2503.5 (39725)	21.83	21.79
	1RB-Low (0)	2682.5 (41515)	21.87	21.45
		2637.8(41068)	21.81	21.46
		2593 (40620)	22.00	21.86
		2548.3(40173)	21.92	21.49
		2503.5 (39725)	21.97	21.52
	36RB-High (38)	2682.5 (41515)	21.95	21.94
		2637.8(41068)	21.78	21.72
		2593 (40620)	21.75	21.61
		2548.3(40173)	21.84	21.87
		2503.5 (39725)	21.86	21.81
	36RB-Middle (19)	2682.5 (41515)	21.83	21.92
		2637.8(41068)	21.83	21.66
		2593 (40620)	21.88	21.92
		2548.3(40173)	21.81	21.84
		2503.5 (39725)	21.83	21.96
	36RB-Low (0)	2682.5 (41515)	21.93	21.82
		2637.8(41068)	21.73	21.66
		2593 (40620)	21.85	22.00
		2548.3(40173)	21.90	21.83
		2503.5 (39725)	21.98	21.91
75RB (0)	2682.5 (41515)	21.98	21.81	
	2637.8(41068)	21.80	21.78	
	2593 (40620)	21.76	21.74	
	2548.3(40173)	21.98	21.94	
	2503.5 (39725)	21.82	22.00	

20MHz	1RB-High (99)	2680 (41490)	21.95	21.44
		2636.5(41055)	21.64	21.28
		2593 (40620)	21.47	21.22
		2549.5(40185)	21.96	21.40
		2506 (39750)	21.92	21.76
	1RB-Middle (50)	2680 (41490)	21.92	21.73
		2636.5(41055)	21.96	21.54
		2593 (40620)	21.86	21.68
		2549.5(40185)	21.98	21.74
		2506 (39750)	21.97	21.94
	1RB-Low (0)	2680 (41490)	21.84	21.46
		2636.5(41055)	21.87	21.52
		2593 (40620)	21.97	21.63
		2549.5(40185)	21.81	21.45
		2506 (39750)	21.94	21.49
	50RB-High (50)	2680 (41490)	21.93	22.00
		2636.5(41055)	21.77	21.77
		2593 (40620)	21.72	21.63
		2549.5(40185)	21.91	21.99
		2506 (39750)	21.95	21.89
	50RB-Middle (25)	2680 (41490)	21.94	21.81
		2636.5(41055)	21.79	21.79
		2593 (40620)	21.94	21.94
		2549.5(40185)	21.94	21.93
		2506 (39750)	21.83	21.81
50RB-Low (0)	2680 (41490)	21.93	22.00	
	2636.5(41055)	21.88	21.89	
	2593 (40620)	21.90	21.92	
	2549.5(40185)	21.90	21.89	
	2506 (39750)	21.94	21.97	
100RB (0)	2680 (41490)	21.93	22.00	
	2636.5(41055)	21.82	21.81	
	2593 (40620)	21.76	21.75	
	2549.5(40185)	21.96	21.93	
	2506 (39750)	21.96	21.93	

LTE Band41 PC3 DSI0

BANDWIDTH	Number of RBs	Frequency	QPSK	16QAM
5MHz	1RB-High (24)	2687.5 (41565)	22.85	21.81
		2640.3(41093)	22.75	21.46
		2593 (40620)	22.57	21.27
		2545.8(40148)	22.88	21.51
		2498.5 (39675)	23.19	21.75
	1RB-Middle (12)	2687.5 (41565)	23.15	21.99
		2640.3(41093)	22.81	21.79
		2593 (40620)	22.99	21.50
		2545.8(40148)	22.96	21.69
		2498.5 (39675)	23.14	21.78
	1RB-Low (0)	2687.5 (41565)	22.89	21.92
		2640.3(41093)	22.63	21.41
		2593 (40620)	22.87	21.39
		2545.8(40148)	22.90	21.45
		2498.5 (39675)	23.15	21.62
	12RB-High (13)	2687.5 (41565)	22.03	20.98
		2640.3(41093)	21.81	20.79
		2593 (40620)	21.87	20.88
		2545.8(40148)	22.09	20.91
		2498.5 (39675)	22.12	21.03
	12RB-Middle (6)	2687.5 (41565)	22.13	21.01
		2640.3(41093)	21.92	20.81
		2593 (40620)	22.01	20.90
		2545.8(40148)	22.02	20.93
		2498.5 (39675)	22.20	21.02
	12RB-Low (0)	2687.5 (41565)	22.10	20.99
		2640.3(41093)	21.82	20.72
		2593 (40620)	21.94	20.97
		2545.8(40148)	21.94	20.85
		2498.5 (39675)	22.12	21.04
	25RB (0)	2687.5 (41565)	22.02	21.24
		2640.3(41093)	21.83	20.96
2593 (40620)		21.92	20.86	
2545.8(40148)		22.03	21.08	

		2498.5 (39675)	22.12	21.29
10MHz	1RB-High (49)	2685 (41540)	22.83	21.73
		2639(41080)	22.73	21.70
		2593 (40620)	22.60	21.51
		2547(40160)	22.91	21.84
		2501 (39700)	23.26	22.04
	1RB-Middle (24)	2685 (41540)	23.19	21.92
		2639(41080)	22.80	21.40
		2593 (40620)	23.08	21.65
		2547(40160)	23.27	21.78
		2501 (39700)	23.42	21.70
	1RB-Low (0)	2685 (41540)	22.92	21.48
		2639(41080)	22.79	21.41
		2593 (40620)	22.96	21.61
		2547(40160)	22.80	21.58
		2501 (39700)	22.99	21.71
	25RB-High (25)	2685 (41540)	21.95	21.18
		2639(41080)	21.79	20.93
		2593 (40620)	21.82	20.90
		2547(40160)	22.02	21.11
		2501 (39700)	22.25	21.27
	25RB-Middle (12)	2685 (41540)	22.03	21.30
		2639(41080)	21.84	20.88
		2593 (40620)	22.00	21.10
		2547(40160)	22.09	20.98
		2501 (39700)	22.26	21.39
25RB-Low (0)	2685 (41540)	22.05	21.23	
	2639(41080)	21.82	20.97	
	2593 (40620)	21.98	21.13	
	2547(40160)	21.96	21.08	
	2501 (39700)	22.13	21.24	
50RB (0)	2685 (41540)	22.07	21.00	
	2639(41080)	21.88	20.78	
	2593 (40620)	21.88	21.01	
	2547(40160)	22.04	20.91	
	2501 (39700)	22.33	21.30	
15MHz	1RB-High (74)	2682.5 (41515)	22.91	21.51

		2637.8(41068)	22.72	21.78
		2593 (40620)	22.75	21.35
		2548.3(40173)	22.77	21.86
		2503.5 (39725)	23.06	22.16
	1RB-Middle (37)	2682.5 (41515)	22.97	22.06
		2637.8(41068)	22.82	21.40
		2593 (40620)	22.88	21.50
		2548.3(40173)	22.99	21.84
		2503.5 (39725)	23.14	21.69
	1RB-Low (0)	2682.5 (41515)	22.91	21.64
		2637.8(41068)	22.84	21.83
		2593 (40620)	22.94	21.96
		2548.3(40173)	22.93	21.88
		2503.5 (39725)	22.94	21.72
	36RB-High (38)	2682.5 (41515)	22.04	20.90
		2637.8(41068)	21.87	20.75
		2593 (40620)	21.77	20.88
		2548.3(40173)	21.99	20.74
		2503.5 (39725)	22.14	21.08
	36RB-Middle (19)	2682.5 (41515)	22.10	21.05
		2637.8(41068)	21.92	20.70
		2593 (40620)	21.99	20.87
		2548.3(40173)	22.06	20.89
		2503.5 (39725)	22.20	21.13
	36RB-Low (0)	2682.5 (41515)	21.99	20.96
		2637.8(41068)	21.82	20.70
		2593 (40620)	22.05	20.88
		2548.3(40173)	21.97	20.80
2503.5 (39725)		22.04	21.07	
75RB (0)	2682.5 (41515)	22.08	20.96	
	2637.8(41068)	21.91	20.83	
	2593 (40620)	21.87	20.94	
	2548.3(40173)	22.14	21.02	
	2503.5 (39725)	22.18	21.08	
20MHz	1RB-High (99)	2680 (41490)	22.69	21.51
		2636.5(41055)	22.57	21.34
		2593 (40620)	22.45	21.05

		2549.5(40185)	22.71	21.92
		2506 (39750)	23.09	21.94
	1RB-Middle (50)	2680 (41490)	22.89	21.78
		2636.5(41055)	22.80	21.81
		2593 (40620)	23.04	21.50
		2549.5(40185)	23.22	21.90
		2506 (39750)	23.03	21.90
	1RB-Low (0)	2680 (41490)	22.89	21.58
		2636.5(41055)	22.78	21.78
		2593 (40620)	23.09	21.73
		2549.5(40185)	22.89	21.43
		2506 (39750)	22.76	21.56
	50RB-High (50)	2680 (41490)	21.97	20.84
		2636.5(41055)	21.82	20.78
		2593 (40620)	21.71	20.70
		2549.5(40185)	21.89	20.90
		2506 (39750)	22.23	21.15
	50RB-Middle (25)	2680 (41490)	21.96	20.96
		2636.5(41055)	21.85	20.70
		2593 (40620)	21.89	20.80
		2549.5(40185)	22.05	21.07
		2506 (39750)	22.12	21.15
	50RB-Low (0)	2680 (41490)	21.95	20.96
2636.5(41055)		21.94	20.81	
2593 (40620)		21.98	20.99	
2549.5(40185)		21.91	20.93	
2506 (39750)		21.99	20.93	
100RB (0)	2680 (41490)	21.95	20.97	
	2636.5(41055)	21.86	20.75	
	2593 (40620)	21.85	20.84	
	2549.5(40185)	22.06	20.97	
	2506 (39750)	22.24	21.10	

LTE Band41 PC3 DSI1

BANDWIDTH	Number of RBs	Frequency	QPSK	16QAM
5MHz	1RB-High (24)	2687.5 (41565)	22.87	21.62

		2640.3(41093)	22.76	21.51
		2593 (40620)	22.66	21.55
		2545.8(40148)	23.04	21.79
		2498.5 (39675)	23.31	22.04
	1RB-Middle (12)	2687.5 (41565)	23.05	22.18
		2640.3(41093)	22.87	21.57
		2593 (40620)	23.17	21.81
		2545.8(40148)	23.14	21.79
		2498.5 (39675)	23.16	22.10
	1RB-Low (0)	2687.5 (41565)	23.08	21.92
		2640.3(41093)	22.76	21.55
		2593 (40620)	22.85	21.39
		2545.8(40148)	22.90	21.54
		2498.5 (39675)	23.07	21.74
	12RB-High (13)	2687.5 (41565)	22.12	20.98
		2640.3(41093)	21.94	20.84
		2593 (40620)	21.86	20.88
		2545.8(40148)	22.10	20.91
		2498.5 (39675)	22.24	21.27
	12RB-Middle (6)	2687.5 (41565)	22.21	21.09
		2640.3(41093)	21.95	20.87
		2593 (40620)	21.99	20.92
		2545.8(40148)	22.10	20.93
		2498.5 (39675)	22.22	21.08
	12RB-Low (0)	2687.5 (41565)	22.19	21.08
		2640.3(41093)	21.86	20.78
		2593 (40620)	22.03	20.86
		2545.8(40148)	22.03	20.96
		2498.5 (39675)	22.14	21.08
	25RB (0)	2687.5 (41565)	22.10	21.14
2640.3(41093)		21.87	21.12	
2593 (40620)		21.91	20.88	
2545.8(40148)		22.03	21.10	
2498.5 (39675)		22.25	21.33	
10MHz	1RB-High (49)	2685 (41540)	22.98	21.86
		2639(41080)	22.79	21.48
		2593 (40620)	22.82	21.34

		2547(40160)	22.87	21.58
		2501 (39700)	23.23	22.14
	1RB-Middle (24)	2685 (41540)	23.54	22.01
		2639(41080)	23.19	21.77
		2593 (40620)	23.19	21.75
		2547(40160)	23.38	21.71
		2501 (39700)	23.60	22.10
	1RB-Low (0)	2685 (41540)	23.10	21.66
		2639(41080)	22.96	21.55
		2593 (40620)	22.97	21.62
		2547(40160)	22.98	21.62
		2501 (39700)	23.04	21.67
	25RB-High (25)	2685 (41540)	22.17	21.26
		2639(41080)	21.97	20.91
		2593 (40620)	21.86	20.81
		2547(40160)	22.00	21.20
		2501 (39700)	22.37	21.36
	25RB-Middle (12)	2685 (41540)	22.27	21.09
		2639(41080)	22.02	20.96
		2593 (40620)	22.07	21.22
		2547(40160)	22.06	21.23
		2501 (39700)	22.37	21.35
	25RB-Low (0)	2685 (41540)	22.19	21.32
		2639(41080)	21.91	20.95
		2593 (40620)	22.12	21.27
		2547(40160)	22.08	20.92
		2501 (39700)	22.25	21.25
	50RB (0)	2685 (41540)	22.11	21.20
		2639(41080)	21.98	20.97
		2593 (40620)	21.93	21.02
2547(40160)		22.15	20.94	
2501 (39700)		22.37	21.28	
15MHz	1RB-High (74)	2682.5 (41515)	22.96	21.67
		2637.8(41068)	22.72	21.45
		2593 (40620)	22.70	21.26
		2548.3(40173)	22.87	21.87
		2503.5 (39725)	23.09	22.11

	1RB-Middle (37)	2682.5 (41515)	23.06	21.76
		2637.8(41068)	22.81	21.55
		2593 (40620)	22.90	21.52
		2548.3(40173)	23.20	21.94
		2503.5 (39725)	23.26	22.03
	1RB-Low (0)	2682.5 (41515)	22.83	22.03
		2637.8(41068)	22.90	21.57
		2593 (40620)	23.08	21.67
		2548.3(40173)	22.78	21.61
		2503.5 (39725)	22.99	21.63
	36RB-High (38)	2682.5 (41515)	22.10	20.99
		2637.8(41068)	21.94	20.92
		2593 (40620)	21.87	20.78
		2548.3(40173)	22.01	20.83
		2503.5 (39725)	22.18	21.12
	36RB-Middle (19)	2682.5 (41515)	22.19	21.08
		2637.8(41068)	21.98	20.86
		2593 (40620)	22.00	20.91
		2548.3(40173)	22.08	20.99
		2503.5 (39725)	22.24	21.09
36RB-Low (0)	2682.5 (41515)	22.09	20.99	
	2637.8(41068)	21.87	20.84	
	2593 (40620)	22.08	21.06	
	2548.3(40173)	22.10	20.90	
	2503.5 (39725)	22.17	21.11	
75RB (0)	2682.5 (41515)	22.12	21.19	
	2637.8(41068)	21.96	20.98	
	2593 (40620)	21.99	21.03	
	2548.3(40173)	22.17	20.92	
	2503.5 (39725)	22.23	21.31	
20MHz	1RB-High (99)	2680 (41490)	22.87	21.41
		2636.5(41055)	22.63	21.31
		2593 (40620)	22.63	21.38
		2549.5(40185)	22.81	21.72
		2506 (39750)	23.28	22.20
	1RB-Middle (50)	2680 (41490)	22.99	21.93
		2636.5(41055)	22.94	21.87

		2593 (40620)	22.93	21.81
		2549.5(40185)	23.49	22.00
		2506 (39750)	23.19	22.07
	1RB-Low (0)	2680 (41490)	22.96	21.49
		2636.5(41055)	22.86	21.99
		2593 (40620)	22.85	21.73
		2549.5(40185)	22.80	21.46
		2506 (39750)	23.00	21.67
	50RB-High (50)	2680 (41490)	22.17	21.04
		2636.5(41055)	21.97	20.94
		2593 (40620)	21.83	20.70
		2549.5(40185)	21.91	20.91
		2506 (39750)	22.32	21.12
	50RB-Middle (25)	2680 (41490)	22.08	21.03
		2636.5(41055)	21.98	20.97
		2593 (40620)	21.92	20.92
		2549.5(40185)	22.18	20.97
		2506 (39750)	22.22	21.23
	50RB-Low (0)	2680 (41490)	22.10	21.18
		2636.5(41055)	22.07	21.15
2593 (40620)		21.98	20.98	
2549.5(40185)		22.06	21.07	
2506 (39750)		22.19	20.99	
100RB (0)	2680 (41490)	22.09	21.08	
	2636.5(41055)	22.02	20.90	
	2593 (40620)	21.97	20.95	
	2549.5(40185)	22.21	21.01	
	2506 (39750)	22.36	21.16	

LTE Band41 PC3 DSI2

BANDWIDTH	Number of RBs	Frequency	QPSK	16QAM
5MHz	1RB-High (24)	2687.5 (41565)	22.95	21.58
		2640.3(41093)	22.72	21.31
		2593 (40620)	22.70	21.33
		2545.8(40148)	22.85	21.52
		2498.5 (39675)	22.90	21.80

	1RB-Middle (12)	2687.5 (41565)	22.88	21.75
		2640.3(41093)	22.90	21.76
		2593 (40620)	22.91	21.85
		2545.8(40148)	22.83	21.74
		2498.5 (39675)	22.82	21.81
	1RB-Low (0)	2687.5 (41565)	22.84	21.99
		2640.3(41093)	22.72	21.71
		2593 (40620)	22.96	21.42
		2545.8(40148)	22.90	21.46
		2498.5 (39675)	22.84	21.64
	12RB-High (13)	2687.5 (41565)	21.87	20.95
		2640.3(41093)	21.88	20.78
		2593 (40620)	21.88	20.80
		2545.8(40148)	21.98	20.92
		2498.5 (39675)	21.81	20.98
	12RB-Middle (6)	2687.5 (41565)	21.78	20.87
		2640.3(41093)	21.87	20.78
		2593 (40620)	21.91	20.76
		2545.8(40148)	21.89	20.94
		2498.5 (39675)	21.89	20.88
	12RB-Low (0)	2687.5 (41565)	21.89	20.55
		2640.3(41093)	21.90	20.73
		2593 (40620)	21.85	20.99
		2545.8(40148)	21.83	20.86
		2498.5 (39675)	21.62	20.84
25RB (0)	2687.5 (41565)	21.92	20.90	
	2640.3(41093)	21.90	20.85	
	2593 (40620)	21.92	20.71	
	2545.8(40148)	21.81	20.81	
	2498.5 (39675)	21.71	20.73	
10MHz	1RB-High (49)	2685 (41540)	21.99	21.55
		2639(41080)	21.72	21.43
		2593 (40620)	21.71	21.24
		2547(40160)	21.95	21.48
		2501 (39700)	22.09	21.81
	1RB-Middle (24)	2685 (41540)	22.44	21.73
		2639(41080)	22.19	21.53

		2593 (40620)	22.10	21.77
		2547(40160)	22.44	21.61
		2501 (39700)	22.45	21.61
	1RB-Low (0)	2685 (41540)	21.96	21.78
		2639(41080)	21.66	21.42
		2593 (40620)	22.09	21.71
		2547(40160)	21.82	21.60
		2501 (39700)	22.12	21.75
	25RB-High (25)	2685 (41540)	21.99	20.99
		2639(41080)	21.90	20.77
		2593 (40620)	21.82	20.73
		2547(40160)	21.85	20.84
		2501 (39700)	21.73	20.88
	25RB-Middle (12)	2685 (41540)	21.94	20.81
		2639(41080)	21.93	20.88
		2593 (40620)	21.94	20.71
		2547(40160)	22.00	20.76
		2501 (39700)	21.83	20.79
	25RB-Low (0)	2685 (41540)	21.76	20.87
		2639(41080)	21.82	20.99
2593 (40620)		21.74	20.97	
2547(40160)		21.78	20.85	
2501 (39700)		21.77	20.94	
50RB (0)	2685 (41540)	20.85	20.75	
	2639(41080)	21.89	20.82	
	2593 (40620)	21.88	20.85	
	2547(40160)	21.87	20.82	
	2501 (39700)	21.88	20.85	
15MHz	1RB-High (74)	2682.5 (41515)	22.00	21.58
		2637.8(41068)	21.76	21.86
		2593 (40620)	21.69	21.35
		2548.3(40173)	21.93	21.97
		2503.5 (39725)	22.03	21.68
	1RB-Middle (37)	2682.5 (41515)	21.95	21.87
		2637.8(41068)	21.83	21.57
		2593 (40620)	21.92	21.39
		2548.3(40173)	21.96	21.91

		2503.5 (39725)	22.02	21.69
	1RB-Low (0)	2682.5 (41515)	21.97	21.55
		2637.8(41068)	21.86	21.54
		2593 (40620)	22.10	21.66
		2548.3(40173)	21.91	21.64
		2503.5 (39725)	21.85	21.61
	36RB-High (38)	2682.5 (41515)	21.88	20.98
		2637.8(41068)	21.88	20.76
		2593 (40620)	21.77	20.68
		2548.3(40173)	21.91	20.91
		2503.5 (39725)	21.96	20.86
	36RB-Middle (19)	2682.5 (41515)	21.87	20.84
		2637.8(41068)	21.93	20.79
		2593 (40620)	21.86	20.80
		2548.3(40173)	21.88	20.96
		2503.5 (39725)	21.87	20.87
	36RB-Low (0)	2682.5 (41515)	21.85	20.96
		2637.8(41068)	21.84	20.80
		2593 (40620)	21.78	20.96
		2548.3(40173)	21.99	20.96
		2503.5 (39725)	21.87	20.91
	75RB (0)	2682.5 (41515)	21.83	20.89
		2637.8(41068)	21.91	20.83
		2593 (40620)	21.87	20.88
		2548.3(40173)	21.86	20.99
2503.5 (39725)		21.88	20.87	
20MHz	1RB-High (99)	2680 (41490)	21.81	21.41
		2636.5(41055)	21.68	21.78
		2593 (40620)	21.46	21.15
		2549.5(40185)	21.92	21.75
		2506 (39750)	22.05	21.78
	1RB-Middle (50)	2680 (41490)	21.97	21.87
		2636.5(41055)	22.10	21.82
		2593 (40620)	21.97	21.52
		2549.5(40185)	22.07	21.63
		2506 (39750)	22.28	21.75
	1RB-Low (0)	2680 (41490)	21.81	21.62

		2636.5(41055)	21.89	21.48
		2593 (40620)	21.93	21.96
		2549.5(40185)	21.91	21.44
		2506 (39750)	21.86	21.61
	50RB-High (50)	2680 (41490)	21.75	20.86
		2636.5(41055)	21.84	20.80
		2593 (40620)	21.73	20.62
		2549.5(40185)	21.90	20.92
		2506 (39750)	21.98	20.83
	50RB-Middle (25)	2680 (41490)	21.93	20.97
		2636.5(41055)	21.85	20.82
		2593 (40620)	21.92	20.81
		2549.5(40185)	21.84	20.98
		2506 (39750)	21.76	20.86
	50RB-Low (0)	2680 (41490)	21.96	20.83
		2636.5(41055)	21.94	20.92
		2593 (40620)	21.84	20.92
		2549.5(40185)	21.91	20.84
		2506 (39750)	21.63	20.87
	100RB (0)	2680 (41490)	21.95	20.89
2636.5(41055)		21.88	20.75	
2593 (40620)		21.85	20.87	
2549.5(40185)		21.75	20.89	
2506 (39750)		21.74	20.88	

LTE Band66 DSI0

BANDWIDTH	Number of RBs	Frequency	QPSK	16QAM
1.4MHz	1RB-High (5)	1779.3 (132665)	20.35	20.32
		1745 (132322)	21.01	20.29
		1710.7 (131979)	21.12	20.75
	1RB-Middle (3)	1779.3 (132665)	20.38	20.41
		1745 (132322)	21.06	20.82
		1710.7 (131979)	21.16	21.11
	1RB-Low (0)	1779.3 (132665)	20.59	20.31
		1745 (132322)	20.90	20.50
		1710.7 (131979)	21.06	20.65
	3RB-High (3)	1779.3 (132665)	20.86	20.40

		1745 (132322)	21.19	21.02	
		1710.7 (131979)	21.31	21.45	
		1779.3 (132665)	20.70	20.80	
	3RB-Middle (1)	1745 (132322)	21.14	20.94	
		1710.7 (131979)	21.22	21.03	
		1779.3 (132665)	20.66	20.58	
	3RB-Low (0)	1745 (132322)	21.09	20.92	
		1710.7 (131979)	21.27	21.05	
		1779.3 (132665)	20.63	20.77	
	6RB (0)	1745 (132322)	20.98	20.92	
		1710.7 (131979)	21.17	21.11	
		1778.5 (132657)	20.70	20.29	
3MHz	1RB-High (14)	1745 (132322)	21.03	21.17	
		1711.5 (131987)	21.13	21.22	
		1778.5 (132657)	20.83	20.34	
	1RB-Middle (7)	1745 (132322)	20.92	20.90	
		1711.5 (131987)	21.15	20.81	
		1778.5 (132657)	20.71	20.35	
	1RB-Low (0)	1745 (132322)	20.82	20.71	
		1711.5 (131987)	21.05	20.79	
		1778.5 (132657)	20.77	20.65	
	8RB-High (7)	1745 (132322)	21.04	21.33	
		1711.5 (131987)	21.22	21.29	
		1778.5 (132657)	20.63	20.55	
	8RB-Middle (4)	1745 (132322)	21.10	21.21	
		1711.5 (131987)	21.24	21.32	
		1778.5 (132657)	20.77	20.50	
	8RB-Low (0)	1745 (132322)	21.07	21.33	
		1711.5 (131987)	21.18	21.27	
		1778.5 (132657)	20.76	20.90	
	15RB (0)	1745 (132322)	21.05	21.11	
		1711.5 (131987)	21.20	21.23	
		1777.5 (132647)	20.51	20.15	
	5MHz	1RB-High (24)	1745 (132322)	20.84	20.33
			1712.5 (131997)	21.07	20.57
			1777.5 (132647)	20.50	20.29
1RB-Middle (12)		1745 (132322)	20.89	20.82	
		1712.5 (131997)	21.20	20.84	
		1777.5 (132647)	20.75	20.19	
1RB-Low (0)		1745 (132322)	20.90	20.75	

	12RB-High (13)	1712.5 (131997)	21.05	20.78	
		1777.5 (132647)	20.66	20.50	
		1745 (132322)	21.03	20.94	
	12RB-Middle (6)	1712.5 (131997)	21.12	21.14	
		1777.5 (132647)	20.65	20.79	
		1745 (132322)	21.11	20.94	
	12RB-Low (0)	1712.5 (131997)	21.13	21.25	
		1777.5 (132647)	20.66	20.59	
		1745 (132322)	21.04	20.97	
	25RB (0)	1712.5 (131997)	21.16	21.15	
		1777.5 (132647)	20.70	20.90	
		1745 (132322)	21.03	21.14	
	10MHz	1RB-High (49)	1712.5 (131997)	21.19	21.19
			1775 (132622)	20.46	20.47
			1745 (132322)	21.02	20.40
1RB-Middle (24)		1715 (132022)	21.10	20.88	
		1775 (132622)	20.70	20.34	
		1745 (132322)	21.07	20.34	
1RB-Low (0)		1715 (132022)	21.21	20.92	
		1775 (132622)	20.64	20.28	
		1745 (132322)	21.16	20.63	
25RB-High (25)		1715 (132022)	21.17	20.65	
		1775 (132622)	20.63	20.61	
		1745 (132322)	20.88	20.93	
25RB-Middle (12)		1715 (132022)	21.06	21.04	
		1775 (132622)	20.66	20.73	
		1745 (132322)	20.99	21.16	
25RB-Low (0)		1715 (132022)	21.14	21.31	
		1775 (132622)	20.66	20.63	
		1745 (132322)	21.14	21.00	
50RB (0)		1715 (132022)	20.99	21.04	
		1775 (132622)	20.70	20.67	
		1745 (132322)	21.05	21.01	
15MHz	1RB-High (74)	1715 (132022)	21.17	21.21	
		1772.5 (132597)	20.56	20.09	
		1745 (132322)	21.13	20.61	
	1RB-Middle (37)	1717.5 (132047)	21.12	20.81	
		1772.5 (132597)	20.64	20.85	
		1745 (132322)	21.09	20.68	
		1717.5 (132047)	21.11	20.51	

	1RB-Low (0)	1772.5 (132597)	20.54	20.14
		1745 (132322)	21.07	20.82
		1717.5 (132047)	21.03	20.22
	36RB-High (38)	1772.5 (132597)	20.76	20.78
		1745 (132322)	21.09	20.99
		1717.5 (132047)	21.08	21.12
	36RB-Middle (19)	1772.5 (132597)	20.70	20.82
		1745 (132322)	21.05	21.15
		1717.5 (132047)	21.11	21.23
	36RB-Low (0)	1772.5 (132597)	20.78	20.68
		1745 (132322)	21.11	21.00
		1717.5 (132047)	21.08	21.17
	75RB (0)	1772.5 (132597)	20.83	20.70
		1745 (132322)	21.15	21.14
		1717.5 (132047)	21.09	21.20
20MHz	1RB-High (99)	1770 (132572)	20.68	20.20
		1745 (132322)	21.03	20.72
		1720 (132072)	20.84	20.67
	1RB-Middle (50)	1770 (132572)	20.85	20.18
		1745 (132322)	21.18	20.45
		1720 (132072)	21.21	21.53
	1RB-Low (0)	1770 (132572)	20.68	20.15
		1745 (132322)	21.15	20.53
		1720 (132072)	20.89	20.07
	50RB-High (50)	1770 (132572)	20.72	20.72
		1745 (132322)	21.02	20.96
		1720 (132072)	20.99	21.01
	50RB-Middle (25)	1770 (132572)	20.79	20.79
		1745 (132322)	21.09	20.95
		1720 (132072)	21.14	21.25
	50RB-Low (0)	1770 (132572)	20.71	20.55
		1745 (132322)	21.17	21.00
		1720 (132072)	21.09	21.20
	100RB (0)	1770 (132572)	20.83	20.66
		1745 (132322)	21.09	21.10
		1720 (132072)	21.14	21.13

LTE Band66 DSI1

BANDWIDTH	Number of RBs	Frequency	QPSK	16QAM
-----------	---------------	-----------	------	-------

1.4MHz	1RB-High (5)	1779.3 (132665)	23.21	22.23
		1745 (132322)	23.54	22.73
		1710.7 (131979)	23.42	22.08
	1RB-Middle (3)	1779.3 (132665)	23.26	22.10
		1745 (132322)	23.59	22.18
		1710.7 (131979)	23.45	22.16
	1RB-Low (0)	1779.3 (132665)	23.29	22.59
		1745 (132322)	23.43	22.47
		1710.7 (131979)	23.37	22.43
	3RB-High (3)	1779.3 (132665)	23.30	22.30
		1745 (132322)	23.61	22.50
		1710.7 (131979)	23.58	22.64
	3RB-Middle (1)	1779.3 (132665)	23.44	22.69
		1745 (132322)	23.66	22.41
		1710.7 (131979)	23.68	22.45
	3RB-Low (0)	1779.3 (132665)	23.55	22.51
		1745 (132322)	23.68	22.52
		1710.7 (131979)	23.55	22.17
	6RB (0)	1779.3 (132665)	22.35	21.40
		1745 (132322)	22.60	21.36
		1710.7 (131979)	22.43	21.40
3MHz	1RB-High (14)	1778.5 (132657)	23.01	22.31
		1745 (132322)	23.56	22.15
		1711.5 (131987)	23.36	22.47
	1RB-Middle (7)	1778.5 (132657)	23.10	22.10
		1745 (132322)	23.61	22.30
		1711.5 (131987)	23.46	22.11
	1RB-Low (0)	1778.5 (132657)	23.09	22.12
		1745 (132322)	23.50	22.29
		1711.5 (131987)	23.42	22.20
	8RB-High (7)	1778.5 (132657)	22.38	21.26
		1745 (132322)	22.61	21.57
		1711.5 (131987)	22.42	21.52
	8RB-Middle (4)	1778.5 (132657)	22.36	21.13
		1745 (132322)	22.56	21.74
		1711.5 (131987)	22.35	21.54
	8RB-Low (0)	1778.5 (132657)	22.34	21.36
		1745 (132322)	22.64	21.61
		1711.5 (131987)	22.30	21.49
	15RB (0)	1778.5 (132657)	22.40	21.30

		1745 (132322)	22.62	21.53	
		1711.5 (131987)	22.31	21.46	
5MHz	1RB-High (24)	1777.5 (132647)	23.20	22.10	
		1745 (132322)	23.27	22.14	
		1712.5 (131997)	23.23	22.10	
	1RB-Middle (12)	1777.5 (132647)	23.37	22.15	
		1745 (132322)	23.47	22.03	
		1712.5 (131997)	23.46	22.18	
	1RB-Low (0)	1777.5 (132647)	23.20	22.24	
		1745 (132322)	23.45	22.23	
		1712.5 (131997)	23.28	22.08	
	12RB-High (13)	1777.5 (132647)	22.36	21.28	
		1745 (132322)	22.59	21.51	
		1712.5 (131997)	22.40	21.46	
	12RB-Middle (6)	1777.5 (132647)	22.31	21.27	
		1745 (132322)	22.57	21.45	
		1712.5 (131997)	22.40	21.34	
	12RB-Low (0)	1777.5 (132647)	22.24	21.28	
		1745 (132322)	22.52	21.57	
		1712.5 (131997)	22.31	21.37	
	25RB (0)	1777.5 (132647)	22.41	21.28	
		1745 (132322)	22.61	21.52	
		1712.5 (131997)	22.36	21.40	
	10MHz	1RB-High (49)	1775 (132622)	23.14	22.26
			1745 (132322)	23.62	22.74
			1715 (132022)	23.53	22.12
1RB-Middle (24)		1775 (132622)	23.34	22.18	
		1745 (132322)	23.64	22.21	
		1715 (132022)	23.57	22.53	
1RB-Low (0)		1775 (132622)	23.34	22.31	
		1745 (132322)	23.67	22.20	
		1715 (132022)	23.55	22.24	
25RB-High (25)		1775 (132622)	22.34	21.40	
		1745 (132322)	22.59	21.60	
		1715 (132022)	22.37	21.31	
25RB-Middle (12)		1775 (132622)	22.31	21.33	
		1745 (132322)	22.64	21.65	
		1715 (132022)	22.48	21.50	
25RB-Low (0)		1775 (132622)	22.34	21.26	
		1745 (132322)	22.58	21.60	

		1715 (132022)	22.26	21.28	
	50RB (0)	1775 (132622)	22.30	21.34	
		1745 (132322)	22.69	21.59	
		1715 (132022)	22.50	21.45	
15MHz	1RB-High (74)	1772.5 (132597)	23.43	22.30	
		1745 (132322)	23.60	22.27	
		1717.5 (132047)	23.42	22.10	
	1RB-Middle (37)	1772.5 (132597)	23.28	22.34	
		1745 (132322)	23.64	22.25	
		1717.5 (132047)	23.43	22.66	
	1RB-Low (0)	1772.5 (132597)	23.21	22.40	
		1745 (132322)	23.68	22.32	
		1717.5 (132047)	23.19	22.34	
	36RB-High (38)	1772.5 (132597)	22.36	21.31	
		1745 (132322)	22.54	21.63	
		1717.5 (132047)	22.54	21.46	
	36RB-Middle (19)	1772.5 (132597)	22.37	21.36	
		1745 (132322)	22.62	21.60	
		1717.5 (132047)	22.43	21.61	
	36RB-Low (0)	1772.5 (132597)	22.32	21.24	
		1745 (132322)	22.62	21.59	
		1717.5 (132047)	22.36	21.44	
	75RB (0)	1772.5 (132597)	22.45	21.29	
		1745 (132322)	22.63	21.61	
		1717.5 (132047)	22.50	21.41	
	20MHz	1RB-High (99)	1770 (132572)	23.44	22.51
			1745 (132322)	23.40	22.01
			1720 (132072)	23.28	22.14
1RB-Middle (50)		1770 (132572)	23.47	22.66	
		1745 (132322)	23.66	22.78	
		1720 (132072)	23.50	22.13	
1RB-Low (0)		1770 (132572)	23.25	22.31	
		1745 (132322)	23.64	22.19	
		1720 (132072)	23.35	22.40	
50RB-High (50)		1770 (132572)	22.40	21.23	
		1745 (132322)	22.44	21.37	
		1720 (132072)	22.33	21.26	
50RB-Middle (25)		1770 (132572)	22.46	21.29	
		1745 (132322)	22.59	21.52	
		1720 (132072)	22.42	21.56	

	50RB-Low (0)	1770 (132572)	22.33	21.15
		1745 (132322)	22.63	21.49
		1720 (132072)	22.28	21.30
	100RB (0)	1770 (132572)	22.42	21.33
		1745 (132322)	22.54	21.47
		1720 (132072)	22.40	21.42

LTE Band66 DSI2

BANDWIDTH	Number of RBs	Frequency	QPSK	16QAM
1.4MHz	1RB-High (5)	1779.3 (132665)	20.00	20.31
		1745 (132322)	20.34	19.73
		1710.7 (131979)	20.20	19.53
	1RB-Middle (3)	1779.3 (132665)	20.19	19.94
		1745 (132322)	20.30	20.05
		1710.7 (131979)	20.34	20.16
	1RB-Low (0)	1779.3 (132665)	20.10	19.67
		1745 (132322)	20.42	19.68
		1710.7 (131979)	20.25	19.82
	3RB-High (3)	1779.3 (132665)	20.28	20.02
		1745 (132322)	20.56	20.73
		1710.7 (131979)	20.50	20.53
	3RB-Middle (1)	1779.3 (132665)	20.32	20.01
		1745 (132322)	20.68	20.84
		1710.7 (131979)	20.43	19.99
	3RB-Low (0)	1779.3 (132665)	20.27	20.00
		1745 (132322)	20.63	20.40
		1710.7 (131979)	20.37	20.34
	6RB (0)	1779.3 (132665)	20.17	20.24
		1745 (132322)	20.44	20.33
		1710.7 (131979)	20.27	20.09
3MHz	1RB-High (14)	1778.5 (132657)	19.95	19.55
		1745 (132322)	20.30	20.05
		1711.5 (131987)	20.22	19.56
	1RB-Middle (7)	1778.5 (132657)	20.03	19.89
		1745 (132322)	20.20	20.30
		1711.5 (131987)	20.36	19.98
	1RB-Low (0)	1778.5 (132657)	19.91	19.51
		1745 (132322)	20.21	20.12
		1711.5 (131987)	20.33	19.91

	8RB-High (7)	1778.5 (132657)	20.13	19.93	
		1745 (132322)	20.45	20.68	
		1711.5 (131987)	20.34	20.41	
	8RB-Middle (4)	1778.5 (132657)	20.17	20.19	
		1745 (132322)	20.49	20.66	
		1711.5 (131987)	20.27	20.35	
	8RB-Low (0)	1778.5 (132657)	20.23	20.22	
		1745 (132322)	20.45	20.49	
		1711.5 (131987)	20.29	20.37	
	15RB (0)	1778.5 (132657)	20.22	20.19	
		1745 (132322)	20.46	20.45	
		1711.5 (131987)	20.31	20.44	
5MHz	1RB-High (24)	1777.5 (132647)	20.02	19.44	
		1745 (132322)	20.12	20.36	
		1712.5 (131997)	20.15	19.64	
	1RB-Middle (12)	1777.5 (132647)	20.31	19.99	
		1745 (132322)	20.26	20.13	
		1712.5 (131997)	20.33	20.00	
	1RB-Low (0)	1777.5 (132647)	20.13	19.77	
		1745 (132322)	20.41	20.10	
		1712.5 (131997)	20.30	19.62	
	12RB-High (13)	1777.5 (132647)	20.26	20.25	
		1745 (132322)	20.52	20.49	
		1712.5 (131997)	20.29	20.31	
	12RB-Middle (6)	1777.5 (132647)	20.18	20.21	
		1745 (132322)	20.49	20.46	
		1712.5 (131997)	20.28	20.28	
	12RB-Low (0)	1777.5 (132647)	20.10	20.14	
		1745 (132322)	20.42	20.38	
		1712.5 (131997)	20.29	20.31	
	25RB (0)	1777.5 (132647)	20.21	20.25	
		1745 (132322)	20.42	20.50	
		1712.5 (131997)	20.34	20.35	
	10MHz	1RB-High (49)	1775 (132622)	19.89	19.71
			1745 (132322)	20.47	20.59
			1715 (132022)	20.35	20.54
1RB-Middle (24)		1775 (132622)	20.35	19.80	
		1745 (132322)	20.54	19.83	
		1715 (132022)	20.45	19.86	
1RB-Low (0)	1775 (132622)	19.97	19.27		

		1745 (132322)	20.58	20.17	
		1715 (132022)	20.29	19.90	
		25RB-High (25)	1775 (132622)	20.21	20.32
			1745 (132322)	20.41	20.42
			1715 (132022)	20.31	20.32
		25RB-Middle (12)	1775 (132622)	20.25	20.31
	1745 (132322)		20.56	20.67	
	1715 (132022)		20.38	20.40	
	25RB-Low (0)	1775 (132622)	20.19	20.25	
		1745 (132322)	20.51	20.59	
		1715 (132022)	20.35	20.17	
	50RB (0)	1775 (132622)	20.28	20.22	
1745 (132322)		20.51	20.60		
1715 (132022)		20.42	20.34		
15MHz	1RB-High (74)	1772.5 (132597)	19.85	20.40	
		1745 (132322)	20.46	20.00	
		1717.5 (132047)	20.49	19.91	
	1RB-Middle (37)	1772.5 (132597)	20.17	19.57	
		1745 (132322)	20.48	19.70	
		1717.5 (132047)	20.30	19.52	
	1RB-Low (0)	1772.5 (132597)	19.92	19.77	
		1745 (132322)	20.43	20.13	
		1717.5 (132047)	20.08	19.96	
	36RB-High (38)	1772.5 (132597)	20.26	20.29	
		1745 (132322)	20.47	20.44	
		1717.5 (132047)	20.37	20.43	
	36RB-Middle (19)	1772.5 (132597)	20.24	20.29	
		1745 (132322)	20.52	20.54	
		1717.5 (132047)	20.40	20.17	
	36RB-Low (0)	1772.5 (132597)	20.21	20.18	
		1745 (132322)	20.53	20.56	
		1717.5 (132047)	20.32	20.29	
	75RB (0)	1772.5 (132597)	20.26	20.23	
		1745 (132322)	20.55	20.57	
		1717.5 (132047)	20.38	20.36	
20MHz	1RB-High (99)	1770 (132572)	20.29	19.68	
		1745 (132322)	20.48	19.86	
		1720 (132072)	20.35	19.81	
	1RB-Middle (50)	1770 (132572)	20.33	20.03	
		1745 (132322)	20.62	20.09	

		1720 (132072)	20.46	20.00
1RB-Low (0)		1770 (132572)	20.27	19.83
		1745 (132322)	20.46	20.08
		1720 (132072)	20.22	19.29
50RB-High (50)		1770 (132572)	20.27	20.27
		1745 (132322)	20.43	20.62
		1720 (132072)	20.29	20.41
50RB-Middle (25)		1770 (132572)	20.30	20.40
		1745 (132322)	20.53	20.57
		1720 (132072)	20.37	20.47
50RB-Low (0)		1770 (132572)	20.09	20.09
		1745 (132322)	20.52	20.60
		1720 (132072)	20.31	20.23
100RB (0)		1770 (132572)	20.29	20.34
		1745 (132322)	20.52	20.59
		1720 (132072)	20.35	20.45

LTE Band71 DSI0/1/2

BANDWIDTH	Number of RBs	Frequency	QPSK	16QAM
5MHz	1RB-High (24)	695.5 (133447)	22.72	21.19
		680.5 (133297)	22.98	22.87
		665.5 (133147)	23.26	22.10
	1RB-Middle (12)	695.5 (133447)	23.28	21.52
		680.5 (133297)	23.26	22.36
		665.5 (133147)	23.51	22.13
	1RB-Low (0)	695.5 (133447)	23.06	22.02
		680.5 (133297)	23.15	21.90
		665.5 (133147)	23.42	21.91
	12RB-High (13)	695.5 (133447)	22.08	21.12
		680.5 (133297)	22.20	21.18
		665.5 (133147)	22.34	21.33
	12RB-Middle (6)	695.5 (133447)	22.27	21.03
		680.5 (133297)	22.21	21.36
		665.5 (133147)	22.52	21.34
	12RB-Low (0)	695.5 (133447)	22.39	21.12
		680.5 (133297)	22.20	21.24
		665.5 (133147)	22.40	21.43
	25RB (0)	695.5 (133447)	22.33	21.30
		680.5 (133297)	22.13	21.31

		665.5 (133147)	22.52	21.29	
10MHz	1RB-High (49)	693 (133422)	22.85	21.31	
		680.5 (133297)	22.97	22.96	
		668 (133172)	23.26	22.19	
	1RB-Middle (24)	693 (133422)	23.17	21.46	
		680.5 (133297)	23.30	22.51	
		668 (133172)	23.58	21.98	
	1RB-Low (0)	693 (133422)	22.90	21.96	
		680.5 (133297)	23.20	22.00	
		668 (133172)	23.42	21.91	
	25RB-High (25)	693 (133422)	22.24	21.09	
		680.5 (133297)	22.18	21.12	
		668 (133172)	22.40	21.51	
	25RB-Middle (12)	693 (133422)	22.33	21.02	
		680.5 (133297)	22.23	21.20	
		668 (133172)	22.47	21.48	
	25RB-Low (0)	693 (133422)	22.37	21.25	
		680.5 (133297)	22.28	21.20	
		668 (133172)	22.33	21.31	
	50RB (0)	693 (133422)	22.44	21.16	
		680.5 (133297)	22.33	21.33	
		668 (133172)	22.43	21.40	
	15MHz	1RB-High (74)	690.5 (133397)	22.89	21.32
			680.5 (133297)	22.83	23.00
			670.5 (133197)	23.15	22.18
1RB-Middle (37)		690.5 (133397)	23.21	21.55	
		680.5 (133297)	23.34	22.40	
		670.5 (133197)	23.59	22.02	
1RB-Low (0)		690.5 (133397)	23.03	21.91	
		680.5 (133297)	23.17	21.95	
		670.5 (133197)	23.25	21.78	
36RB-High (38)		690.5 (133397)	22.13	21.13	
		680.5 (133297)	22.09	21.17	
		670.5 (133197)	22.49	21.48	
36RB-Middle (19)		690.5 (133397)	22.30	21.06	
		680.5 (133297)	22.21	21.31	
		670.5 (133197)	22.62	21.43	
36RB-Low (0)		690.5 (133397)	22.47	21.29	
		680.5 (133297)	22.29	21.17	
		670.5 (133197)	22.45	21.44	

	75RB (0)	690.5 (133397)	22.42	21.28
		680.5 (133297)	22.27	21.29
		670.5 (133197)	22.35	21.32
20MHz	1RB-High (99)	688 (133372)	22.80	21.26
		683 (133322)	22.92	22.97
		673 (133222)	23.18	22.18
	1RB-Middle (50)	688 (133372)	23.21	21.49
		683 (133322)	23.33	22.43
		673 (133222)	23.50	22.08
	1RB-Low (0)	688 (133372)	22.97	21.92
		683 (133322)	23.19	21.94
		673 (133222)	23.34	21.86
	50RB-High (50)	688 (133372)	22.14	21.05
		683 (133322)	22.10	21.21
		673 (133222)	22.42	21.41
	50RB-Middle (25)	688 (133372)	22.30	21.12
		683 (133322)	22.27	21.26
		673 (133222)	22.52	21.40
	50RB-Low (0)	688 (133372)	22.39	21.21
		683 (133322)	22.24	21.19
		673 (133222)	22.38	21.37
	100RB (0)	688 (133372)	22.34	21.26
		683 (133322)	22.23	21.25
		673 (133222)	22.42	21.39

11.4 Wi-Fi and BT Measurement result

The maximum output power of BT antenna is 11.29dBm.

The maximum tune up of BT antenna is 12dBm.

WIFI2.4G -Standalone

2.4GHz			
		power setting	tune up
FCC			
802.11b(dBm)			
Channel\data	1Mbps		
11(2462MHz)	17.73	18.00	19.50
6(2437MHz)	18.90	18.00	20.00
1(2412MHz)	18.13	18.00	20.00
802.11g(dBm)			
Channel\data	6Mbps		
11(2462MHz)	16.73	17.00	18.50
6(2437MHz)	17.49	17.00	19.00
1(2412MHz)	17.28	17.00	19.00
802.11n(dBm)-20MHz			
Channel\data	MCS0		
11(2462MHz)	16.78	16.00	18.00
6(2437MHz)	16.68	16.00	18.00
1(2412MHz)	16.16	16.00	18.00
802.11n(dBm)-40MHz			
Channel\data	MCS0		
9(2452MHz)	14.13	12.00	16.00
6(2437MHz)	14.73	12.00	16.00
3(2422MHz)	14.68	12.00	16.00

WIFI2.4G -WWAN+WIFI

2.4GHz			
		power setting	tune up
FCC			
802.11b(dBm)			
Channel\data	1Mbps		
11(2462MHz)	14.54	15.00	16.50
6(2437MHz)	15.68	15.00	17.00
1(2412MHz)	15.35	15.00	17.00
802.11g(dBm)			
Channel\data	6Mbps		
11(2462MHz)	13.62	14.00	15.50
6(2437MHz)	14.61	14.00	16.00
1(2412MHz)	14.53	14.00	16.00
802.11n(dBm)-20MHz			
Channel\data	MCS0		
11(2462MHz)	12.53	13.00	14.50
6(2437MHz)	13.62	13.00	15.00
1(2412MHz)	13.13	13.00	15.00
802.11n(dBm)-40MHz			
Channel\data	MCS0		
9(2452MHz)	10.85	9.00	12.50
6(2437MHz)	11.56	9.00	13.00
3(2422MHz)	11.53	9.00	13.00

12 Antenna Location

12.1 Transmit Antenna Separation Distances

The detail for transmit antenna separation distances is described in the additional document:

Appendix to test report No.23T04Z80397-013

The photos of SAR test

12.2 Evaluation of Simultaneous

Test Position	MFR 1a/1b/1c/1d	WLAN															simultaneous transmission						
		GSMS50	GSML900	WCDMA1900	WCDMA1700	WCDMA50	LTE B2	LTE B4	LTE B5	LTE B12	LTE B13	LTE B25	LTE B26	LTE B41 PC2	LTE B41 PC3	LTE B66	LTE B71	WLAN	WiFi2.4G	BT	1+2	1+4	
Head	Left Cheek	0.47	0.18	<0.01	0.27	0.68	1.35	0.32	0.56	0.39	0.26	1.36	0.81	0.21	0.11	0.26	0.24	1.360	0.200	0.030	1.580	1.390	
	Left Tilt	0.26	0.04	<0.01	0.11	0.42	0.42	0.12	0.37	0.13	0.17	0.37	0.58	0.11	0.05	0.06	0.10	0.580	0.000	0.000	0.580	0.580	
	Right Cheek	0.41	0.08	<0.01	0.15	0.59	0.78	0.15	0.74	0.24	0.38	0.78	0.91	0.14	0.07	0.13	0.28	0.940	0.140	0.000	1.080	0.940	
	Right Tilt	0.28	0.06	<0.01	0.09	0.43	0.67	0.12	0.48	0.10	0.20	0.26	0.49	0.11	0.05	0.09	0.11	0.670	0.000	0.000	0.670	0.670	
	Front 10mm	0.27	0.25	0.25	0.18	0.39	0.25	0.17	0.27	0.17	0.29	0.24	0.58	0.07	0.15	0.19	0.09	0.390	0.000	0.000	0.390	0.390	
	Rear on 10mm	0.38	0.30	0.25	0.39	0.65	0.59	0.63	0.61	0.45	0.44	0.48	0.74	0.17	0.24	0.45	0.26	0.740	0.140	0.000	0.880	0.740	
Body	Rear off 10mm	0.63	0.81	0.73	0.81	0.86	0.74	0.77	0.65	0.54	0.75	0.74	0.84	0.21	0.49	0.91	0.31	0.940	0.300	0.000	1.240	0.940	
	Left 10mm	0.17	0.20	0.20	0.18	0.32	0.20	0.18	0.28	0.17	0.31	0.18	0.36	0.14	0.28	0.21	0.10	0.360	0.000	0.000	0.360	0.360	
	Right 10mm	0.47	0.10	0.10	0.06	0.59	0.10	0.06	0.48	0.27	0.48	0.10	0.67	0.06	0.12	0.07	0.17	0.670	0.180	0.000	0.850	0.670	
	Bottom 10mm	0.33	0.54	0.47	0.63	0.74	0.46	0.58	0.71	0.37	0.35	0.46	0.30	0.30	0.42	0.71	0.68	0.710	0.000	0.000	0.710	0.710	
	Top 10mm	<0.01	<0.01	<0.01	<0.01	<0.01	<0.01	<0.01	<0.01	<0.01	<0.01	<0.01	<0.01	<0.01	<0.01	<0.01	<0.01	<0.01	0.000	0.000	0.000	0.000	0.000
	Front 15mm	0.21	0.10	0.19	0.14	0.28	0.27	0.17	0.21	0.12	0.23	0.29	0.27	0.06	0.10	0.19	0.07	0.290	0.000	0.000	0.290	0.290	
Rear on 10mm	0.22	0.27	0.23	0.19	0.33	0.26	0.45	0.39	0.36	0.35	0.49	0.45	0.13	0.21	0.35	0.14	0.490	0.130	0.000	0.620	0.490		
Rear off 10mm	0.49	0.51	0.53	0.46	0.67	0.76	0.53	0.47	0.58	0.57	0.79	0.60	0.16	0.28	0.62	0.20	0.790	0.160	0.000	0.950	0.790		

13 SAR Test Result

It is determined by user manual for the distance between the EUT and the phantom bottom. The distance is 10 mm and just applied to the condition of body worn accessory.

It is performed for all SAR measurements with area scan based 1-g SAR estimation (Fast SAR). A zoom scan measurement is added when the estimated 1-g SAR is the highest measured SAR in each exposure configuration, wireless mode and frequency band combination or more than 1.2W/kg.

The calculated SAR is obtained by the following formula:

$$\text{Reported SAR} = \text{Measured SAR} \times 10^{(P_{\text{Target}} - P_{\text{Measured}})/10}$$

Where P_{Target} is the power of manufacturing upper limit;

P_{Measured} is the measured power in chapter 11.

Duty Cycle

Mode	Duty Cycle
Speech for GSM	1:8.3
GPRS&EGPRS 1 Slot	1:8.3
GPRS&EGPRS 2 Slot	1:4
GPRS&EGPRS 3 Slot	1:2.67
GPRS&EGPRS 4 Slot	1:2
WCDMA<E FDD	1:1
TDD PC3	1:1.58

13.1 SAR results

B2=battery2 (TIANMAO)

RF Exposure Conditions	Frequency Band	Channel Number	Frequency (MHz)	Mode/RB	Test Position	Distance	Figure No./Note	EUT Measured Power (dBm)	Tune up (dBm)	Measured SAR 1g (W/kg)	Reported SAR 1g (W/kg)	Measured SAR 10g (W/kg)	Reported SAR 10g (W/kg)	Power Drift
Head	GSM850	251	848.8	VOIP(2TX)	Cheek Left	0mm	\	32.99	33.30	0.394	0.42	0.264	0.28	0.08
Head	GSM850	190	836.6	VOIP(2TX)	Cheek Left	0mm	F.1	33.02	33.30	0.443	0.47	0.29	0.31	-0.09
Head	GSM850	128	824.2	VOIP(2TX)	Cheek Left	0mm	\	32.88	33.30	0.422	0.46	0.270	0.30	0.01
Head	GSM850	190	836.6	VOIP(2TX)	Tilt Left	0mm	\	33.02	33.30	0.245	0.26	0.176	0.19	0.03
Head	GSM850	190	836.6	VOIP(2TX)	Cheek Right	0mm	\	33.02	33.30	0.384	0.41	0.249	0.27	-0.08
Head	GSM850	190	836.6	VOIP(2TX)	Tilt Right	0mm	\	33.02	33.30	0.265	0.28	0.187	0.20	-0.08
Hotspot	GSM850	190	836.6	GPRS(2TX)	Front	10mm	\	30.45	30.5	0.267	0.27	0.211	0.21	0.1
Hotspot	GSM850	251	848.8	GPRS(2TX)	Rear Off	10mm	\	30.41	30.5	0.523	0.53	0.37	0.38	-0.18
Hotspot	GSM850	190	836.6	GPRS(2TX)	Rear Off	10mm	\	30.45	30.5	0.634	0.64	0.463	0.47	0.1
Hotspot	GSM850	128	824.2	GPRS(2TX)	Rear Off	10mm	F.2	30.47	30.5	0.65	0.65	0.488	0.49	-0.03
Hotspot	GSM850	190	836.6	GPRS(2TX)	Rear On	10mm	\	30.45	30.5	0.377	0.38	0.237	0.24	0.12
Hotspot	GSM850	190	836.6	GPRS(2TX)	Left	10mm	\	30.45	30.5	0.17	0.17	0.106	0.11	0.08
Hotspot	GSM850	190	836.6	GPRS(2TX)	Right	10mm	\	30.45	30.5	0.46	0.47	0.331	0.33	-0.17
Hotspot	GSM850	190	836.6	GPRS(2TX)	Top	10mm	\	30.45	30.5	<0.01	<0.01	<0.01	<0.01	\
Hotspot	GSM850	190	836.6	GPRS(2TX)	Bottom	10mm	\	30.45	30.5	0.128	0.13	0.080	0.08	-0.03
Hotspot	GSM850	128	824.2	EGPRS(2TX)	Rear Off	10mm	\	30.45	30.5	0.649	0.66	0.485	0.49	0.14
Body	GSM850	190	836.6	GPRS(2TX)	Front	15mm	\	30.45	30.5	0.205	0.21	0.154	0.16	0.11
Body	GSM850	251	848.8	GPRS(2TX)	Rear Off	15mm	\	30.41	30.5	0.394	0.40	0.279	0.28	-0.05
Body	GSM850	190	836.6	GPRS(2TX)	Rear Off	15mm	\	30.45	30.5	0.467	0.47	0.327	0.33	0.18
Body	GSM850	128	824.2	GPRS(2TX)	Rear Off	15mm	F.3	30.47	30.5	0.473	0.48	0.355	0.36	0.05
Body	GSM850	190	836.6	GPRS(2TX)	Rear On	15mm	\	30.45	30.5	0.214	0.22	0.127	0.13	0.14
Head	GSM1900	810	1909.8	VOIP(3TX)	Cheek Left	0mm	\	30.12	30.3	0.128	0.13	0.084	0.09	-0.17
Head	GSM1900	661	1880	VOIP(3TX)	Cheek Left	0mm	\	30.23	30.3	0.131	0.13	0.091	0.09	0.17
Head	GSM1900	512	1850	VOIP(3TX)	Cheek Left	0mm	F.4	30.02	30.3	0.169	0.18	0.112	0.12	0.04
Head	GSM1900	661	1880	VOIP(3TX)	Tilt Left	0mm	\	30.23	30.3	0.035	0.04	0.028	0.03	-0.05
Head	GSM1900	661	1880	VOIP(3TX)	Cheek Right	0mm	\	30.23	30.3	0.076	0.08	0.049	0.05	0.01
Head	GSM1900	661	1880	VOIP(3TX)	Tilt Right	0mm	\	30.23	30.3	0.059	0.06	0.044	0.04	0.1
Hotspot	GSM1900	661	1880	GPRS(3TX)	Front	10mm	\	23.36	23.5	0.241	0.25	0.145	0.15	-0.17
Hotspot	GSM1900	810	1909.8	GPRS(3TX)	Rear Off	10mm	\	23.46	23.5	0.671	0.68	0.4	0.40	0.04
Hotspot	GSM1900	661	1880	GPRS(3TX)	Rear Off	10mm	\	23.36	23.5	0.711	0.73	0.43	0.44	-0.01
Hotspot	GSM1900	512	1850	GPRS(3TX)	Rear Off	10mm	F.5	23.27	23.5	0.771	0.81	0.464	0.49	0.15
Hotspot	GSM1900	661	1880	GPRS(3TX)	Rear On	10mm	\	23.36	23.5	0.481	0.50	0.298	0.31	-0.08
Hotspot	GSM1900	661	1880	GPRS(3TX)	Left	10mm	\	23.36	23.5	0.189	0.20	0.116	0.12	0.05
Hotspot	GSM1900	661	1880	GPRS(3TX)	Right	10mm	\	23.36	23.5	0.093	0.10	0.059	0.06	0.06
Hotspot	GSM1900	661	1880	GPRS(3TX)	Top	10mm	\	23.36	23.5	<0.01	<0.01	<0.01	<0.01	\
Hotspot	GSM1900	661	1880	GPRS(3TX)	Bottom	10mm	\	23.36	23.5	0.527	0.54	0.298	0.31	-0.09
Hotspot	GSM1900	512	1850	EGPRS(3TX)	Rear Off	10mm	\	23.28	23.5	0.743	0.78	0.458	0.48	-0.08
Body	GSM1900	661	1880	GPRS(3TX)	Front	15mm	\	24.71	25	0.093	0.10	0.054	0.06	0.13
Body	GSM1900	810	1909.8	GPRS(3TX)	Rear Off	15mm	\	24.75	25	0.399	0.42	0.248	0.26	0.12
Body	GSM1900	661	1880	GPRS(3TX)	Rear Off	15mm	\	24.71	25	0.388	0.41	0.24	0.26	0.03
Body	GSM1900	512	1850	GPRS(3TX)	Rear Off	15mm	F.6	24.33	25	0.435	0.51	0.269	0.31	0.13
Body	GSM1900	661	1880	GPRS(3TX)	Rear On	15mm	\	24.71	25	0.253	0.27	0.151	0.16	0.18
Head	WCDMA 850	4183	836.6	RMC	Cheek Left	0mm	F.7	22.68	24.5	0.444	0.68	0.299	0.45	-0.11
Head	WCDMA 850	4183	836.6	RMC	Tilt Left	0mm	\	22.68	24.5	0.275	0.42	0.200	0.30	0.16
Head	WCDMA 850	4233	846.6	RMC	Cheek Right	0mm	\	22.62	24.5	0.291	0.45	0.208	0.32	-0.1
Head	WCDMA 850	4183	836.6	RMC	Cheek Right	0mm	\	22.68	24.5	0.389	0.59	0.26	0.40	0.07
Head	WCDMA 850	4132	826.4	RMC	Cheek Right	0mm	\	22.73	24.5	0.257	0.39	0.186	0.28	0.18
Head	WCDMA 850	4183	836.6	RMC	Tilt Right	0mm	\	22.68	24.5	0.283	0.43	0.203	0.31	-0.1
Hotspot	WCDMA 850	4183	836.6	RMC	Front	10mm	\	22.68	24.5	0.258	0.39	0.201	0.31	0.01
Hotspot	WCDMA 850	4233	846.6	RMC	Rear Off	10mm	\	22.62	24.5	0.456	0.70	0.33	0.51	-0.15
Hotspot	WCDMA 850	4183	836.6	RMC	Rear Off	10mm	\	22.68	24.5	0.524	0.80	0.387	0.59	0.19
Hotspot	WCDMA 850	4132	826.4	RMC	Rear Off	10mm	F.8	22.73	24.5	0.569	0.86	0.426	0.64	0.01
Hotspot	WCDMA 850	4183	836.6	RMC	Rear On	10mm	\	22.68	24.5	0.428	0.65	0.26	0.40	0.07
Hotspot	WCDMA 850	4183	836.6	RMC	Left	10mm	\	22.68	24.5	0.211	0.32	0.158	0.24	-0.18
Hotspot	WCDMA 850	4183	836.6	RMC	Right	10mm	\	22.68	24.5	0.39	0.59	0.286	0.43	0.03
Hotspot	WCDMA 850	4183	836.6	RMC	Top	10mm	\	22.68	24.5	<0.01	<0.01	<0.01	<0.01	\
Hotspot	WCDMA 850	4183	836.6	RMC	Bottom	10mm	\	22.68	24.5	0.155	0.24	0.092	0.14	-0.15
Body	WCDMA 850	4183	836.6	RMC	Front	15mm	\	22.68	24.5	0.187	0.28	0.146	0.22	-0.15
Body	WCDMA 850	4233	846.6	RMC	Rear Off	15mm	\	22.62	24.5	0.37	0.57	0.272	0.42	0.11
Body	WCDMA 850	4183	836.6	RMC	Rear Off	15mm	\	22.68	24.5	0.419	0.64	0.312	0.47	-0.08
Body	WCDMA 850	4132	826.4	RMC	Rear Off	15mm	F.9	22.73	24.5	0.446	0.67	0.335	0.50	-0.05
Body	WCDMA 850	4183	836.6	RMC	Rear On	15mm	\	22.68	24.5	0.214	0.33	0.137	0.21	-0.17



Head	WCDMA1700	1513	1752.6	RMC	Cheek Left	0mm	\	23.48	24.5	0.204	0.26	0.113	0.14	-0.08
Head	WCDMA1700	1412	1732.6	RMC	Cheek Left	0mm	F.10	23.57	24.5	0.217	0.27	0.121	0.15	0.04
Head	WCDMA1700	1312	1712.4	RMC	Cheek Left	0mm	\	23.52	24.5	0.195	0.24	0.109	0.14	-0.04
Head	WCDMA1700	1412	1732.6	RMC	Tilt Left	0mm	\	23.57	24.5	0.089	0.11	0.057	0.07	-0.08
Head	WCDMA1700	1412	1732.6	RMC	Cheek Right	0mm	\	23.57	24.5	0.119	0.15	0.062	0.08	0.17
Head	WCDMA1700	1412	1732.6	RMC	Tilt Right	0mm	\	23.57	24.5	0.075	0.09	0.050	0.06	0.18
Hotspot	WCDMA1700	1412	1732.6	RMC	Front	10mm	\	20.43	20.5	0.173	0.18	0.108	0.11	-0.04
Hotspot	WCDMA1700	1513	1752.6	RMC	Rear Off	10mm	F.11	20.42	20.5	0.798	0.81	0.462	0.47	0.06
Hotspot	WCDMA1700	1412	1732.6	RMC	Rear Off	10mm	\	20.43	20.5	0.751	0.76	0.436	0.44	-0.08
Hotspot	WCDMA1700	1312	1712.4	RMC	Rear Off	10mm	\	20.39	20.5	0.749	0.77	0.434	0.45	-0.13
Hotspot	WCDMA1700	1412	1732.6	RMC	Rear On	10mm	\	20.43	20.5	0.382	0.39	0.235	0.24	-0.13
Hotspot	WCDMA1700	1412	1732.6	RMC	Left	10mm	\	20.43	20.5	0.179	0.18	0.101	0.10	0.06
Hotspot	WCDMA1700	1412	1732.6	RMC	Right	10mm	\	20.43	20.5	0.06	0.06	0.039	0.04	-0.03
Hotspot	WCDMA1700	1412	1732.6	RMC	Top	10mm	\	20.43	20.5	<0.01	<0.01	<0.01	<0.01	\
Hotspot	WCDMA1700	1412	1732.6	RMC	Bottom	10mm	\	20.43	20.5	0.617	0.63	0.337	0.34	-0.03
Body	WCDMA1700	1412	1732.6	RMC	Front	15mm	\	21.42	21.5	0.133	0.14	0.084	0.09	0.08
Body	WCDMA1700	1513	1752.6	RMC	Rear Off	15mm	F.12	21.49	21.5	0.455	0.46	0.274	0.27	-0.09
Body	WCDMA1700	1412	1732.6	RMC	Rear Off	15mm	\	21.42	21.5	0.433	0.44	0.26	0.26	-0.07
Body	WCDMA1700	1312	1712.4	RMC	Rear Off	15mm	\	21.43	21.5	0.437	0.44	0.262	0.27	0.05
Body	WCDMA1700	1412	1732.6	RMC	Rear On	15mm	\	21.42	21.5	0.187	0.19	0.118	0.12	-0.11
Head	WCDMA1900	9538	1907.6	RMC	Cheek Left	0mm	\	23.79	24.5	<0.01	<0.01	<0.01	<0.01	\
Head	WCDMA1900	9400	1880	RMC	Cheek Left	0mm	\	23.92	24.5	<0.01	<0.01	<0.01	<0.01	\
Head	WCDMA1900	9262	1852.4	RMC	Cheek Left	0mm	\	23.91	24.5	<0.01	<0.01	<0.01	<0.01	\
Head	WCDMA1900	9400	1880	RMC	Tilt Left	0mm	\	23.92	24.5	<0.01	<0.01	<0.01	<0.01	\
Head	WCDMA1900	9400	1880	RMC	Cheek Right	0mm	\	23.92	24.5	<0.01	<0.01	<0.01	<0.01	\
Head	WCDMA1900	9400	1880	RMC	Tilt Right	0mm	\	23.92	24.5	<0.01	<0.01	<0.01	<0.01	\
Hotspot	WCDMA1900	9400	1880	RMC	Front	10mm	\	20.84	21	0.237	0.25	0.138	0.14	-0.09
Hotspot	WCDMA1900	9538	1907.6	RMC	Rear Off	10mm	\	20.93	21	0.622	0.63	0.382	0.39	0.11
Hotspot	WCDMA1900	9400	1880	RMC	Rear Off	10mm	F.13	20.84	21	0.707	0.73	0.429	0.45	0.1
Hotspot	WCDMA1900	9262	1852.4	RMC	Rear Off	10mm	\	20.96	21	0.703	0.71	0.424	0.43	-0.05
Hotspot	WCDMA1900	9400	1880	RMC	Rear On	10mm	\	20.84	21	0.334	0.35	0.194	0.20	-0.08
Hotspot	WCDMA1900	9400	1880	RMC	Left	10mm	\	20.84	21	0.197	0.20	0.119	0.12	0.16
Hotspot	WCDMA1900	9400	1880	RMC	Right	10mm	\	20.84	21	0.098	0.10	0.058	0.06	0.05
Hotspot	WCDMA1900	9400	1880	RMC	Top	10mm	\	20.84	21	<0.01	<0.01	<0.01	<0.01	\
Hotspot	WCDMA1900	9400	1880	RMC	Bottom	10mm	\	20.84	21	0.414	0.43	0.231	0.24	0.05
Body	WCDMA1900	9400	1880	RMC	Front	15mm	\	21.41	21.5	0.189	0.19	0.114	0.12	-0.03
Body	WCDMA1900	9538	1907.6	RMC	Rear Off	15mm	\	21.47	21.5	0.482	0.49	0.301	0.30	-0.15
Body	WCDMA1900	9400	1880	RMC	Rear Off	15mm	F.14	21.41	21.5	0.518	0.53	0.322	0.33	-0.16
Body	WCDMA1900	9262	1852.4	RMC	Rear Off	15mm	\	21.48	21.5	0.488	0.49	0.303	0.30	0.02
Body	WCDMA1900	9400	1880	RMC	Rear On	15mm	\	21.41	21.5	0.229	0.23	0.141	0.14	0.07
Head	LTE Band2	19100	1900	1RB-Low	Cheek Left	0mm	\	23.67	25	0.871	1.18	0.674	0.92	0.04
Head	LTE Band2	18900	1880	1RB-Low	Cheek Left	0mm	\	23.44	25	0.806	1.15	0.634	0.91	0.12
Head	LTE Band2	18700	1860	1RB-Low	Cheek Left	0mm	F.15	23.96	25	1.06	1.35	0.714	0.91	0.06
Head	LTE Band2	18700	1860	1RB-Low	Tilt Left	0mm	\	23.96	25	0.329	0.42	0.230	0.29	0.16
Head	LTE Band2	18700	1860	1RB-Low	Cheek Right	0mm	\	23.96	25	0.616	0.78	0.351	0.45	0.13
Head	LTE Band2	18700	1860	1RB-Low	Tilt Right	0mm	\	23.96	25	0.528	0.67	0.311	0.40	-0.18
Head	LTE Band2	19100	1900	50RB-High	Cheek Left	0mm	\	22.71	24	0.703	0.95	0.528	0.71	0.02
Head	LTE Band2	18900	1880	50RB-High	Cheek Left	0mm	\	22.73	24	0.731	0.98	0.535	0.72	0.02
Head	LTE Band2	18700	1860	50RB-High	Cheek Left	0mm	\	22.82	24	0.784	1.03	0.565	0.74	0.02
Head	LTE Band2	18700	1860	50RB-High	Tilt Left	0mm	\	22.82	24	0.252	0.33	0.179	0.23	0.16
Head	LTE Band2	18700	1860	50RB-High	Cheek Right	0mm	\	22.82	24	0.545	0.72	0.323	0.42	-0.03
Head	LTE Band2	18700	1860	50RB-High	Tilt Right	0mm	\	22.82	24	0.446	0.59	0.302	0.40	0.07
Head	LTE Band2	18700	1860	100RB	Cheek Left	0mm	\	22.86	24	0.609	0.79	0.323	0.42	0.07
Hotspot	LTE Band2	19100	1900	1RB-Mid	Front	10mm	\	20.91	21	0.241	0.25	0.141	0.14	0
Hotspot	LTE Band2	19100	1900	1RB-Mid	Rear Off	10mm	F.16	20.91	21	0.723	0.74	0.44	0.45	0.05
Hotspot	LTE Band2	19100	1900	1RB-Mid	Rear On	10mm	\	20.91	21	0.421	0.43	0.242	0.25	0.01
Hotspot	LTE Band2	19100	1900	1RB-Mid	Left	10mm	\	20.91	21	0.195	0.20	0.118	0.12	-0.01
Hotspot	LTE Band2	19100	1900	1RB-Mid	Right	10mm	\	20.91	21	0.097	0.10	0.059	0.06	-0.06
Hotspot	LTE Band2	19100	1900	1RB-Mid	Top	10mm	\	20.91	21	<0.01	<0.01	<0.01	<0.01	\
Hotspot	LTE Band2	19100	1900	1RB-Mid	Bottom	10mm	\	20.91	21	0.430	0.44	0.240	0.25	-0.04
Hotspot	LTE Band2	18700	1860	50RB-High	Front	10mm	\	20.89	21	0.227	0.23	0.133	0.14	-0.09
Hotspot	LTE Band2	18700	1860	50RB-High	Rear Off	10mm	\	20.89	21	0.691	0.71	0.421	0.43	-0.17
Hotspot	LTE Band2	18700	1860	50RB-High	Rear On	10mm	\	20.89	21	0.488	0.50	0.296	0.30	-0.1
Hotspot	LTE Band2	18700	1860	50RB-High	Left	10mm	\	20.89	21	0.183	0.19	0.111	0.11	0.18
Hotspot	LTE Band2	18700	1860	50RB-High	Right	10mm	\	20.89	21	0.091	0.09	0.055	0.06	-0.17
Hotspot	LTE Band2	18700	1860	50RB-High	Top	10mm	\	20.89	21	<0.01	<0.01	<0.01	<0.01	\
Hotspot	LTE Band2	18700	1860	50RB-High	Bottom	10mm	\	20.89	21	0.445	0.46	0.247	0.25	-0.04
Body	LTE Band2	19100	1900	1RB-Mid	Front	15mm	\	20.65	22	0.195	0.27	0.119	0.16	-0.05
Body	LTE Band2	19100	1900	1RB-Mid	Rear Off	15mm	F.17	20.65	22	0.551	0.75	0.342	0.47	0.04
Body	LTE Band2	19100	1900	1RB-Mid	Rear On	15mm	\	20.65	22	0.23	0.31	0.139	0.19	0
Body	LTE Band2	19100	1900	50RB-Mid	Front	15mm	\	20.64	22	0.187	0.26	0.115	0.16	-0.13
Body	LTE Band2	19100	1900	50RB-Mid	Rear Off	15mm	\	20.64	22	0.533	0.73	0.33	0.45	-0.01
Body	LTE Band2	19100	1900	50RB-Mid	Rear On	15mm	\	20.64	22	0.232	0.32	0.145	0.20	-0.09



No. 23T04Z80397-013

Head	LTE Band4	20300	1745	1RB-Low	Cheek Left	0mm	F.18	23.78	25	0.244	0.32	0.168	0.22	0.06
Head	LTE Band4	20300	1745	1RB-Low	Tilt Left	0mm	\	23.78	25	0.092	0.12	0.071	0.09	0.05
Head	LTE Band4	20300	1745	1RB-Low	Cheek Right	0mm	\	23.78	25	0.114	0.15	0.072	0.10	0.02
Head	LTE Band4	20300	1745	1RB-Low	Tilt Right	0mm	\	23.78	25	0.092	0.12	0.072	0.10	-0.13
Head	LTE Band4	20300	1745	50RB-Low	Cheek Left	0mm	\	22.65	24	0.206	0.28	0.144	0.20	0.17
Head	LTE Band4	20300	1745	50RB-Low	Tilt Left	0mm	\	22.65	24	0.072	0.10	0.056	0.08	0.06
Head	LTE Band4	20300	1745	50RB-Low	Cheek Right	0mm	\	22.65	24	0.092	0.13	0.057	0.08	0
Head	LTE Band4	20300	1745	50RB-Low	Tilt Right	0mm	\	22.65	24	0.072	0.10	0.057	0.08	-0.04
Hotspot	LTE Band4	20300	1745	1RB-Mid	Front	10mm	\	20.81	21	0.161	0.17	0.102	0.11	-0.15
Hotspot	LTE Band4	20300	1745	1RB-Mid	Rear Off	10mm	\	20.81	21	0.686	0.72	0.395	0.41	0.11
Hotspot	LTE Band4	20175	1732.5	1RB-Mid	Rear Off	10mm	F.19	20.60	21	0.688	0.75	0.397	0.44	0.02
Hotspot	LTE Band4	20050	1720	1RB-Mid	Rear Off	10mm	\	20.50	21	0.687	0.77	0.396	0.44	-0.02
Hotspot	LTE Band4	20300	1745	1RB-Mid	Rear On	10mm	\	20.81	21	0.418	0.44	0.262	0.27	0.1
Hotspot	LTE Band4	20300	1745	1RB-Mid	Left	10mm	\	20.81	21	0.169	0.18	0.099	0.10	0.04
Hotspot	LTE Band4	20300	1745	1RB-Mid	Right	10mm	\	20.81	21	0.054	0.06	0.035	0.04	0.13
Hotspot	LTE Band4	20300	1745	1RB-Mid	Top	10mm	\	20.81	21	<0.01	<0.01	<0.01	<0.01	\
Hotspot	LTE Band4	20300	1745	1RB-Mid	Bottom	10mm	\	20.81	21	0.557	0.58	0.303	0.32	-0.18
Hotspot	LTE Band4	20175	1732.5	50RB-Low	Front	10mm	\	20.66	21	0.15	0.16	0.094	0.10	-0.11
Hotspot	LTE Band4	20300	1745	50RB-Low	Rear Off	10mm	\	20.61	21	0.674	0.74	0.388	0.42	-0.16
Hotspot	LTE Band4	20175	1732.5	50RB-Low	Rear Off	10mm	\	20.66	21	0.661	0.71	0.387	0.42	-0.15
Hotspot	LTE Band4	20050	1720	50RB-Low	Rear Off	10mm	\	20.45	21	0.662	0.75	0.383	0.43	-0.06
Hotspot	LTE Band4	20175	1732.5	50RB-Low	Rear On	10mm	\	20.66	21	0.578	0.63	0.352	0.38	-0.14
Hotspot	LTE Band4	20175	1732.5	50RB-Low	Left	10mm	\	20.66	21	0.154	0.17	0.089	0.10	-0.19
Hotspot	LTE Band4	20175	1732.5	50RB-Low	Right	10mm	\	20.66	21	0.053	0.06	0.034	0.04	0.01
Hotspot	LTE Band4	20175	1732.5	50RB-Low	Top	10mm	\	20.66	21	<0.01	<0.01	<0.01	<0.01	\
Hotspot	LTE Band4	20175	1732.5	50RB-Low	Bottom	10mm	\	20.66	21	0.528	0.57	0.288	0.31	0.06
Body	LTE Band4	20050	1720	1RB-High	Front	15mm	\	21.30	22	0.142	0.17	0.086	0.10	0.02
Body	LTE Band4	20050	1720	1RB-High	Rear Off	15mm	F.20	21.30	22	0.472	0.55	0.275	0.32	0.02
Body	LTE Band4	20050	1720	1RB-High	Rear On	15mm	\	21.30	22	0.384	0.45	0.241	0.28	0.12
Body	LTE Band4	20050	1720	50RB-High	Front	15mm	\	21.29	22	0.14	0.16	0.084	0.10	-0.16
Body	LTE Band4	20050	1720	50RB-High	Rear Off	15mm	\	21.29	22	0.447	0.53	0.256	0.30	-0.12
Body	LTE Band4	20050	1720	50RB-High	Rear On	15mm	\	21.29	22	0.251	0.30	0.154	0.18	0.07
Head	LTE Band5	20600	844	1RB-High	Cheek Left	0mm	\	23.98	24	0.561	0.56	0.395	0.40	-0.02
Head	LTE Band5	20600	844	1RB-High	Tilt Left	0mm	\	23.98	24	0.369	0.37	0.292	0.29	-0.05
Head	LTE Band5	20600	844	1RB-High	Cheek Right	0mm	F.21	23.98	24	0.734	0.74	0.535	0.54	-0.17
Head	LTE Band5	20600	844	1RB-High	Tilt Right	0mm	\	23.98	24	0.475	0.48	0.373	0.37	-0.13
Head	LTE Band5	20525	836.5	25RB-Mid	Cheek Left	0mm	\	22.90	23	0.402	0.41	0.282	0.29	0.08
Head	LTE Band5	20525	836.5	25RB-Mid	Tilt Left	0mm	\	22.90	23	0.267	0.27	0.212	0.22	0.16
Head	LTE Band5	20525	836.5	25RB-Mid	Cheek Right	0mm	\	22.90	23	0.574	0.59	0.417	0.43	0.01
Head	LTE Band5	20525	836.5	25RB-Mid	Tilt Right	0mm	\	22.90	23	0.338	0.35	0.265	0.27	-0.16
Hotspot	LTE Band5	20600	844	1RB-High	Front	10mm	\	23.98	24	0.273	0.27	0.208	0.21	0.1
Hotspot	LTE Band5	20600	844	1RB-High	Rear Off	10mm	F.22	23.98	24	0.647	0.65	0.469	0.47	0.11
Hotspot	LTE Band5	20600	844	1RB-High	Rear On	10mm	\	23.98	24	0.611	0.61	0.367	0.37	-0.04
Hotspot	LTE Band5	20600	844	1RB-High	Left	10mm	\	23.98	24	0.278	0.28	0.193	0.19	-0.01
Hotspot	LTE Band5	20600	844	1RB-High	Right	10mm	\	23.98	24	0.473	0.48	0.335	0.34	0
Hotspot	LTE Band5	20600	844	1RB-High	Top	10mm	\	23.98	24	<0.01	<0.01	<0.01	<0.01	\
Hotspot	LTE Band5	20600	844	1RB-High	Bottom	10mm	\	23.98	24	0.213	0.21	0.122	0.12	-0.11
Hotspot	LTE Band5	20525	836.5	25RB-Mid	Front	10mm	\	22.90	23	0.212	0.22	0.162	0.17	-0.06
Hotspot	LTE Band5	20525	836.5	25RB-Mid	Rear Off	10mm	\	22.90	23	0.479	0.49	0.348	0.36	-0.15
Hotspot	LTE Band5	20525	836.5	25RB-Mid	Rear On	10mm	\	22.90	23	0.458	0.47	0.273	0.28	0.03
Hotspot	LTE Band5	20525	836.5	25RB-Mid	Left	10mm	\	22.90	23	0.2	0.20	0.139	0.14	-0.13
Hotspot	LTE Band5	20525	836.5	25RB-Mid	Right	10mm	\	22.90	23	0.339	0.35	0.242	0.25	0.16
Hotspot	LTE Band5	20525	836.5	25RB-Mid	Top	10mm	\	22.90	23	<0.01	<0.01	<0.01	<0.01	\
Hotspot	LTE Band5	20525	836.5	25RB-Mid	Bottom	10mm	\	22.90	23	0.163	0.17	0.095	0.10	-0.15
Body	LTE Band5	20600	844	1RB-High	Front	15mm	\	23.98	24	0.211	0.21	0.162	0.16	-0.02
Body	LTE Band5	20600	844	1RB-High	Rear Off	15mm	F.23	23.98	24	0.465	0.47	0.343	0.34	-0.06
Body	LTE Band5	20600	844	1RB-High	Rear On	15mm	\	23.98	24	0.389	0.39	0.244	0.25	-0.09
Body	LTE Band5	20525	836.5	25RB-Mid	Front	15mm	\	22.90	23	0.157	0.16	0.123	0.13	0.14
Body	LTE Band5	20525	836.5	25RB-Mid	Rear Off	15mm	\	22.90	23	0.348	0.36	0.259	0.27	0.1
Body	LTE Band5	20525	836.5	25RB-Mid	Rear On	15mm	\	22.90	23	0.264	0.27	0.163	0.17	-0.09
Head	LTE Band12	23130	711	1RB-Low	Cheek Left	0mm	\	23.99	24	0.344	0.34	0.266	0.27	0.07
Head	LTE Band12	23130	711	1RB-Low	Tilt Left	0mm	\	23.99	24	0.130	0.13	0.140	0.14	-0.09
Head	LTE Band12	23130	711	1RB-Low	Cheek Right	0mm	\	23.99	24	0.335	0.34	0.266	0.27	-0.16
Head	LTE Band12	23130	711	1RB-Low	Tilt Right	0mm	\	23.99	24	0.103	0.10	0.105	0.11	-0.18
Head	LTE Band12	23130	711	25RB-Mid	Cheek Left	0mm	F.24	22.98	23	0.385	0.39	0.282	0.28	0.03
Head	LTE Band12	23130	711	25RB-Mid	Tilt Left	0mm	\	22.98	23	0.102	0.10	0.109	0.11	-0.07
Head	LTE Band12	23130	711	25RB-Mid	Cheek Right	0mm	\	22.98	23	0.26	0.26	0.251	0.25	0.11
Head	LTE Band12	23130	711	25RB-Mid	Tilt Right	0mm	\	22.98	23	0.080	0.08	0.082	0.08	-0.08

Hotspot	LTE Band12	23130	711	1RB-Low	Front	10mm	\	23.99	24	0.169	0.17	0.132	0.13	-0.1
Hotspot	LTE Band12	23130	711	1RB-Low	Rear Off	10mm	F.25	23.99	24	0.535	0.54	0.4	0.40	-0.07
Hotspot	LTE Band12	23130	711	1RB-Low	Rear On	10mm	\	23.99	24	0.446	0.45	0.34	0.34	-0.01
Hotspot	LTE Band12	23130	711	1RB-Low	Left	10mm	\	23.99	24	0.173	0.17	0.126	0.13	-0.09
Hotspot	LTE Band12	23130	711	1RB-Low	Right	10mm	\	23.99	24	0.266	0.27	0.197	0.20	-0.06
Hotspot	LTE Band12	23130	711	1RB-Low	Top	10mm	\	23.99	24	<0.01	<0.01	<0.01	<0.01	\
Hotspot	LTE Band12	23130	711	1RB-Low	Bottom	10mm	\	23.99	24	0.122	0.12	0.069	0.07	-0.17
Hotspot	LTE Band12	23130	711	25RB-Mid	Front	10mm	\	22.98	23	0.119	0.12	0.093	0.09	-0.01
Hotspot	LTE Band12	23130	711	25RB-Mid	Rear Off	10mm	\	22.98	23	0.407	0.41	0.306	0.31	-0.11
Hotspot	LTE Band12	23130	711	25RB-Mid	Rear On	10mm	\	22.98	23	0.342	0.34	0.256	0.26	0.14
Hotspot	LTE Band12	23130	711	25RB-Mid	Left	10mm	\	22.98	23	0.127	0.13	0.093	0.09	0.03
Hotspot	LTE Band12	23130	711	25RB-Mid	Right	10mm	\	22.98	23	0.205	0.21	0.153	0.15	0.1
Hotspot	LTE Band12	23130	711	25RB-Mid	Top	10mm	\	22.98	23	<0.01	<0.01	<0.01	<0.01	\
Hotspot	LTE Band12	23130	711	25RB-Mid	Bottom	10mm	\	22.98	23	0.119	0.12	0.060	0.06	0.16
Body	LTE Band12	23130	711	1RB-Low	Front	15mm	\	23.99	24	0.124	0.12	0.093	0.09	-0.06
Body	LTE Band12	23130	711	1RB-Low	Rear Off	15mm	F.26	23.99	24	0.375	0.38	0.271	0.27	0.09
Body	LTE Band12	23130	711	1RB-Low	Rear On	15mm	\	23.99	24	0.364	0.36	0.261	0.26	0.02
Body	LTE Band12	23130	711	25RB-Mid	Front	15mm	\	22.98	23	0.101	0.10	0.075	0.08	-0.16
Body	LTE Band12	23130	711	25RB-Mid	Rear Off	15mm	\	22.98	23	0.304	0.31	0.218	0.22	0.05
Body	LTE Band12	23130	711	25RB-Mid	Rear On	15mm	\	22.98	23	0.269	0.27	0.193	0.19	-0.03
Head	LTE Band13	23230	782	1RB-Low	Cheek Left	0mm	\	23.96	24	0.258	0.26	0.164	0.17	0.17
Head	LTE Band13	23230	782	1RB-Low	Tilt Left	0mm	\	23.96	24	0.172	0.17	0.129	0.13	-0.15
Head	LTE Band13	23230	782	1RB-Low	Cheek Right	0mm	F.27	23.96	24	0.38	0.38	0.258	0.26	-0.12
Head	LTE Band13	23230	782	1RB-Low	Tilt Right	0mm	\	23.96	24	0.198	0.20	0.144	0.15	0.16
Head	LTE Band13	23230	782	25RB-Mid	Cheek Left	0mm	\	22.58	23	0.233	0.26	0.15	0.17	0.05
Head	LTE Band13	23230	782	25RB-Mid	Tilt Left	0mm	\	22.58	23	0.143	0.16	0.108	0.12	-0.06
Head	LTE Band13	23230	782	25RB-Mid	Cheek Right	0mm	\	22.58	23	0.263	0.29	0.181	0.20	-0.13
Head	LTE Band13	23230	782	25RB-Mid	Tilt Right	0mm	\	22.58	23	0.165	0.18	0.120	0.13	-0.01
Hotspot	LTE Band13	23230	782	1RB-Low	Front	10mm	\	23.96	24	0.292	0.29	0.214	0.22	-0.11
Hotspot	LTE Band13	23230	782	1RB-Low	Rear Off	10mm	F.28	23.96	24	0.745	0.75	0.531	0.54	-0.05
Hotspot	LTE Band13	23230	782	1RB-Low	Rear On	10mm	\	23.96	24	0.436	0.44	0.265	0.27	0.19
Hotspot	LTE Band13	23230	782	1RB-Low	Left	10mm	\	23.96	24	0.307	0.31	0.214	0.22	-0.14
Hotspot	LTE Band13	23230	782	1RB-Low	Right	10mm	\	23.96	24	0.471	0.48	0.33	0.33	-0.18
Hotspot	LTE Band13	23230	782	1RB-Low	Top	10mm	\	23.96	24	<0.01	<0.01	<0.01	<0.01	\
Hotspot	LTE Band13	23230	782	1RB-Low	Bottom	10mm	\	23.96	24	0.153	0.15	0.084	0.08	-0.06
Hotspot	LTE Band13	23230	782	25RB-Mid	Front	10mm	\	22.58	23	0.23	0.25	0.169	0.19	0.02
Hotspot	LTE Band13	23230	782	25RB-Mid	Rear Off	10mm	\	22.58	23	0.591	0.65	0.421	0.46	0.16
Hotspot	LTE Band13	23230	782	25RB-Mid	Rear On	10mm	\	22.58	23	0.294	0.32	0.179	0.20	0.01
Hotspot	LTE Band13	23230	782	25RB-Mid	Left	10mm	\	22.58	23	0.233	0.26	0.163	0.18	-0.04
Hotspot	LTE Band13	23230	782	25RB-Mid	Right	10mm	\	22.58	23	0.377	0.42	0.262	0.29	0.13
Hotspot	LTE Band13	23230	782	25RB-Mid	Top	10mm	\	22.58	23	<0.01	<0.01	<0.01	<0.01	\
Hotspot	LTE Band13	23230	782	25RB-Mid	Bottom	10mm	\	22.58	23	0.131	0.14	0.074	0.08	0.12
Body	LTE Band13	23230	782	1RB-Low	Front	15mm	\	23.96	24	0.225	0.23	0.166	0.17	0.07
Body	LTE Band13	23230	782	1RB-Low	Rear Off	15mm	F.29	23.96	24	0.561	0.57	0.403	0.41	0.07
Body	LTE Band13	23230	782	1RB-Low	Rear On	15mm	\	23.96	24	0.349	0.35	0.247	0.25	0.08
Body	LTE Band13	23230	782	25RB-Mid	Front	15mm	\	22.58	23	0.181	0.20	0.134	0.15	0.19
Body	LTE Band13	23230	782	25RB-Mid	Rear Off	15mm	\	22.58	23	0.306	0.34	0.216	0.24	-0.06
Body	LTE Band13	23230	782	25RB-Mid	Rear On	15mm	\	22.58	23	0.266	0.29	0.188	0.21	0
Head	LTE Band25	26590	1905	1RB-High	Cheek Left	0mm	F.30	24.08	25	1.1	1.36	0.75	0.93	0.02
Head	LTE Band25	26365	1882.5	1RB-High	Cheek Left	0mm	\	24.00	25	0.742	0.93	0.436	0.55	0.03
Head	LTE Band25	26140	1860	1RB-High	Cheek Left	0mm	\	24.01	25	0.759	0.95	0.448	0.56	0.17
Head	LTE Band25	26590	1905	1RB-High	Tilt Left	0mm	\	24.08	25	0.301	0.37	0.210	0.26	-0.03
Head	LTE Band25	26590	1905	1RB-High	Cheek Right	0mm	\	24.08	25	0.634	0.78	0.396	0.49	0.07
Head	LTE Band25	26590	1905	1RB-High	Tilt Right	0mm	\	24.08	25	0.210	0.26	0.132	0.16	-0.12
Head	LTE Band25	26365	1882.5	50RB-Mid	Cheek Left	0mm	\	22.90	24	0.852	1.10	0.579	0.75	-0.03
Head	LTE Band25	26365	1882.5	50RB-Mid	Tilt Left	0mm	\	22.90	24	0.231	0.30	0.163	0.21	0.02
Head	LTE Band25	26365	1882.5	50RB-Mid	Cheek Right	0mm	\	22.90	24	0.565	0.73	0.357	0.46	0.12
Head	LTE Band25	26365	1882.5	50RB-Mid	Tilt Right	0mm	\	22.90	24	0.194	0.25	0.106	0.14	0.02
Head	LTE Band25	26590	1905	100RB	Cheek Left	0mm	\	22.91	24	0.733	0.94	0.415	0.53	0.17
Head	LTE Band25	26590	1905	1RB-High	Cheek Left	0mm	B2	24.08	25	0.961	1.19	0.714	0.88	0.15
Hotspot	LTE Band25	26365	1882.5	1RB-Mid	Front	10mm	\	21.00	21	0.242	0.24	0.138	0.14	-0.03
Hotspot	LTE Band25	26590	1905	1RB-Mid	Rear Off	10mm	\	20.89	21	0.669	0.69	0.406	0.42	0
Hotspot	LTE Band25	26365	1882.5	1RB-Mid	Rear Off	10mm	F.31	21.00	21	0.742	0.74	0.446	0.45	0.02
Hotspot	LTE Band25	26140	1860	1RB-Mid	Rear Off	10mm	\	20.87	21	0.705	0.73	0.427	0.44	-0.1
Hotspot	LTE Band25	26365	1882.5	1RB-Mid	Rear On	10mm	\	21.00	21	0.373	0.37	0.214	0.21	0.05
Hotspot	LTE Band25	26365	1882.5	1RB-Mid	Left	10mm	\	21.00	21	0.179	0.18	0.106	0.11	0
Hotspot	LTE Band25	26365	1882.5	1RB-Mid	Right	10mm	\	21.00	21	0.095	0.10	0.055	0.06	0.07
Hotspot	LTE Band25	26365	1882.5	1RB-Mid	Top	10mm	\	21.00	21	<0.01	<0.01	<0.01	<0.01	\
Hotspot	LTE Band25	26365	1882.5	1RB-Mid	Bottom	10mm	\	21.00	21	0.415	0.42	0.227	0.23	0.15
Hotspot	LTE Band25	26590	1905	50RB-Low	Front	10mm	\	20.99	21	0.227	0.23	0.129	0.13	-0.05
Hotspot	LTE Band25	26590	1905	50RB-Low	Rear Off	10mm	\	20.99	21	0.664	0.67	0.403	0.40	-0.08
Hotspot	LTE Band25	26365	1882.5	50RB-Low	Rear Off	10mm	\	20.92	21	0.707	0.72	0.415	0.42	-0.08
Hotspot	LTE Band25	26140	1860	50RB-Low	Rear Off	10mm	\	20.86	21	0.669	0.69	0.404	0.42	-0.13
Hotspot	LTE Band25	26590	1905	50RB-Low	Rear On	10mm	\	20.99	21	0.476	0.48	0.261	0.26	0.01
Hotspot	LTE Band25	26590	1905	50RB-Low	Left	10mm	\	20.99	21	0.182	0.18	0.107	0.11	-0.11
Hotspot	LTE Band25	26590	1905	50RB-Low	Right	10mm	\	20.99	21	0.088	0.09	0.053	0.05	0.03
Hotspot	LTE Band25	26590	1905	50RB-Low	Top	10mm	\	20.99	21	<0.01	<0.01	<0.01	<0.01	\
Hotspot	LTE Band25	26590	1905	50RB-Low	Bottom	10mm	\	20.99	21	0.420	0.42	0.230	0.23	-0.05



Body	LTE Band25	26365	1882.5	1RB-Mid	Front	15mm	\	20.80	22	0.223	0.29	0.134	0.18	0.14
Body	LTE Band25	26365	1882.5	1RB-Mid	Rear Off	15mm	F.32	20.80	22	0.597	0.79	0.366	0.48	0.12
Body	LTE Band25	26365	1882.5	1RB-Mid	Rear On	15mm	\	20.80	22	0.375	0.49	0.234	0.31	-0.01
Body	LTE Band25	26140	1860	50RB-High	Front	15mm	\	20.79	22	0.219	0.29	0.131	0.17	-0.12
Body	LTE Band25	26140	1860	50RB-High	Rear Off	15mm	\	20.79	22	0.561	0.74	0.342	0.45	0.07
Body	LTE Band25	26140	1860	50RB-High	Rear On	15mm	\	20.79	22	0.251	0.33	0.163	0.22	0.09
Head	LTE Band26	26965	841.5	1RB-Mid	Cheek Left	0mm	\	23.87	25	0.627	0.81	0.461	0.60	0.04
Head	LTE Band26	26965	841.5	1RB-Mid	Tilt Left	0mm	\	23.87	25	0.372	0.48	0.299	0.39	0.11
Head	LTE Band26	26965	841.5	1RB-Mid	Cheek Right	0mm	F.33	23.87	25	0.727	0.94	0.526	0.68	0.07
Head	LTE Band26	26965	841.5	1RB-Mid	Tilt Right	0mm	\	23.87	25	0.377	0.49	0.299	0.39	-0.13
Head	LTE Band26	26965	841.5	36RB-Mid	Cheek Left	0mm	\	22.99	24	0.457	0.58	0.328	0.41	0.12
Head	LTE Band26	26965	841.5	36RB-Mid	Tilt Left	0mm	\	22.99	24	0.457	0.58	0.227	0.29	-0.11
Head	LTE Band26	26965	841.5	36RB-Mid	Cheek Right	0mm	\	22.99	24	0.542	0.68	0.391	0.49	0.17
Head	LTE Band26	26965	841.5	36RB-Mid	Tilt Right	0mm	\	22.99	24	0.301	0.38	0.239	0.30	-0.16
Hotspot	LTE Band26	26965	841.5	1RB-Mid	Front	10mm	\	23.87	25	0.295	0.38	0.212	0.28	-0.17
Hotspot	LTE Band26	26965	841.5	1RB-Mid	Rear Off	10mm	F.34	23.87	25	0.721	0.94	0.474	0.61	0.08
Hotspot	LTE Band26	26965	841.5	1RB-Mid	Rear On	10mm	\	23.87	25	0.572	0.74	0.329	0.43	0.11
Hotspot	LTE Band26	26965	841.5	1RB-Mid	Left	10mm	\	23.87	25	0.278	0.36	0.183	0.24	-0.05
Hotspot	LTE Band26	26965	841.5	1RB-Mid	Right	10mm	\	23.87	25	0.517	0.67	0.347	0.45	-0.01
Hotspot	LTE Band26	26965	841.5	1RB-Mid	Top	10mm	\	23.87	25	<0.01	<0.01	<0.01	<0.01	\
Hotspot	LTE Band26	26965	841.5	1RB-Mid	Bottom	10mm	\	23.87	25	0.230	0.30	0.128	0.17	-0.14
Hotspot	LTE Band26	26965	841.5	36RB-Mid	Front	10mm	\	22.99	24	0.224	0.28	0.163	0.21	-0.15
Hotspot	LTE Band26	26965	841.5	36RB-Mid	Rear Off	10mm	\	22.99	24	0.58	0.73	0.381	0.48	-0.12
Hotspot	LTE Band26	26965	841.5	36RB-Mid	Rear On	10mm	\	22.99	24	0.53	0.67	0.3	0.38	-0.17
Hotspot	LTE Band26	26965	841.5	36RB-Mid	Left	10mm	\	22.99	24	0.233	0.29	0.153	0.19	0.08
Hotspot	LTE Band26	26965	841.5	36RB-Mid	Right	10mm	\	22.99	24	0.415	0.52	0.278	0.35	0.01
Hotspot	LTE Band26	26965	841.5	36RB-Mid	Top	10mm	\	22.99	24	<0.01	<0.01	<0.01	<0.01	\
Hotspot	LTE Band26	26965	841.5	36RB-Mid	Bottom	10mm	\	22.99	24	0.187	0.24	0.104	0.13	0.02
Body	LTE Band26	26965	841.5	1RB-Mid	Front	15mm	\	23.87	25	0.207	0.27	0.158	0.20	-0.11
Body	LTE Band26	26965	841.5	1RB-Mid	Rear Off	15mm	F.35	23.87	25	0.461	0.60	0.337	0.44	-0.04
Body	LTE Band26	26965	841.5	1RB-Mid	Rear On	15mm	\	23.87	25	0.331	0.43	0.206	0.27	-0.01
Body	LTE Band26	26965	841.5	36RB-Mid	Front	15mm	\	22.99	24	0.163	0.21	0.123	0.16	0.09
Body	LTE Band26	26965	841.5	36RB-Mid	Rear Off	15mm	\	22.99	24	0.368	0.46	0.265	0.33	0.1
Body	LTE Band26	26965	841.5	36RB-Mid	Rear On	15mm	\	22.99	24	0.25	0.32	0.156	0.20	-0.04
Head	LTE Band41 PC2	39750	2506	1RB-High	Cheek Left	0mm	F.36	26.00	26.5	0.186	0.21	0.095	0.11	-0.09
Head	LTE Band41 PC2	39750	2506	1RB-High	Tilt Left	0mm	\	26.00	26.5	0.099	0.11	0.055	0.06	0.15
Head	LTE Band41 PC2	39750	2506	1RB-High	Cheek Right	0mm	\	26.00	26.5	0.125	0.14	0.054	0.06	0.09
Head	LTE Band41 PC2	39750	2506	1RB-High	Tilt Right	0mm	\	26.00	26.5	0.100	0.11	0.045	0.05	-0.16
Head	LTE Band41 PC2	39750	2506	50RB-High	Cheek Left	0mm	\	25.11	25.5	0.152	0.17	0.079	0.09	0.05
Head	LTE Band41 PC2	39750	2506	50RB-High	Tilt Left	0mm	\	25.11	25.5	0.079	0.09	0.045	0.05	0.08
Head	LTE Band41 PC2	39750	2506	50RB-High	Cheek Right	0mm	\	25.11	25.5	0.093	0.10	0.04	0.04	-0.18
Head	LTE Band41 PC2	39750	2506	50RB-High	Tilt Right	0mm	\	25.11	25.5	0.077	0.08	0.034	0.04	-0.03
Hotspot	LTE Band41 PC2	40185	2549.5	1RB-Mid	Front	10mm	\	21.98	22	0.068	0.07	0.04	0.04	-0.04
Hotspot	LTE Band41 PC2	40185	2549.5	1RB-Mid	Rear Off	10mm	\	21.98	22	0.194	0.19	0.105	0.11	-0.09
Hotspot	LTE Band41 PC2	40185	2549.5	1RB-Mid	Rear On	10mm	\	21.98	22	0.167	0.17	0.096	0.10	0.18
Hotspot	LTE Band41 PC2	40185	2549.5	1RB-Mid	Left	10mm	\	21.98	22	0.129	0.13	0.075	0.08	0.11
Hotspot	LTE Band41 PC2	40185	2549.5	1RB-Mid	Right	10mm	\	21.98	22	0.061	0.06	0.035	0.04	0.07
Hotspot	LTE Band41 PC2	40185	2549.5	1RB-Mid	Top	10mm	\	21.98	22	<0.01	<0.01	<0.01	<0.01	\
Hotspot	LTE Band41 PC2	40185	2549.5	1RB-Mid	Bottom	10mm	\	21.98	22	0.185	0.19	0.103	0.10	-0.03
Hotspot	LTE Band41 PC2	39750	2506	50RB-High	Front	10mm	\	21.95	22	0.071	0.07	0.042	0.04	0.09
Hotspot	LTE Band41 PC2	39750	2506	50RB-High	Rear Off	10mm	\	21.95	22	0.212	0.21	0.116	0.12	0.18
Hotspot	LTE Band41 PC2	39750	2506	50RB-High	Rear On	10mm	\	21.95	22	0.15	0.15	0.083	0.08	-0.08
Hotspot	LTE Band41 PC2	39750	2506	50RB-High	Left	10mm	\	21.95	22	0.136	0.14	0.079	0.08	-0.05
Hotspot	LTE Band41 PC2	39750	2506	50RB-High	Right	10mm	\	21.95	22	0.061	0.06	0.035	0.04	-0.03
Hotspot	LTE Band41 PC2	39750	2506	50RB-High	Top	10mm	\	21.95	22	<0.01	<0.01	<0.01	<0.01	\
Hotspot	LTE Band41 PC2	39750	2506	50RB-High	Bottom	10mm	\	21.95	22	0.193	0.20	0.108	0.11	0.17
Body	LTE Band41 PC2	40185	2549.5	1RB-Mid	Front	15mm	\	22.95	23	0.055	0.06	0.029	0.03	-0.14
Body	LTE Band41 PC2	40185	2549.5	1RB-Mid	Rear Off	15mm	\	22.95	23	0.143	0.14	0.07	0.07	0.06
Body	LTE Band41 PC2	40185	2549.5	1RB-Mid	Rear On	15mm	\	22.95	23	0.128	0.13	0.069	0.07	-0.06
Body	LTE Band41 PC2	39750	2506	50RB-High	Front	15mm	\	22.94	23	0.057	0.06	0.029	0.03	-0.15
Body	LTE Band41 PC2	39750	2506	50RB-High	Rear Off	15mm	\	22.94	23	0.155	0.16	0.076	0.08	0.07
Body	LTE Band41 PC2	39750	2506	50RB-High	Rear On	15mm	\	22.94	23	0.119	0.12	0.063	0.06	-0.12

Head	LTE Band41 PC3	40185	2549.5	1RB-Mid	Cheek Left	0mm	\	23.49	24	0.102	0.11	<0.01	0.05	0.04
Head	LTE Band41 PC3	40185	2549.5	1RB-Mid	Tilt Left	0mm	\	23.49	24	0.042	0.05	<0.01	0.02	-0.16
Head	LTE Band41 PC3	40185	2549.5	1RB-Mid	Cheek Right	0mm	\	23.49	24	0.058	0.07	<0.01	0.03	-0.03
Head	LTE Band41 PC3	40185	2549.5	1RB-Mid	Tilt Right	0mm	\	23.49	24	0.045	0.05	<0.01	0.02	0.17
Head	LTE Band41 PC3	39750	2506	50RB-High	Cheek Left	0mm	\	22.32	23	0.071	0.08	<0.01	0.04	0.02
Head	LTE Band41 PC3	39750	2506	50RB-High	Tilt Left	0mm	\	22.32	23	<0.01	<0.01	<0.01	<0.01	\
Head	LTE Band41 PC3	39750	2506	50RB-High	Cheek Right	0mm	\	22.32	23	0.043	0.05	<0.01	0.02	0
Head	LTE Band41 PC3	39750	2506	50RB-High	Tilt Right	0mm	\	22.32	23	0.034	0.04	<0.01	0.02	0.18
Hotspot	LTE Band41 PC3	39750	2506	1RB-Mid	Front	10mm	\	22.28	23	0.127	0.15	0.064	0.08	-0.11
Hotspot	LTE Band41 PC3	39750	2506	1RB-Mid	Rear Off	10mm	F.37	22.28	23	0.413	0.49	0.194	0.23	0.03
Hotspot	LTE Band41 PC3	39750	2506	1RB-Mid	Rear On	10mm	\	22.28	23	0.186	0.22	0.092	0.11	-0.05
Hotspot	LTE Band41 PC3	39750	2506	1RB-Mid	Left	10mm	\	22.28	23	0.239	0.28	0.121	0.14	-0.04
Hotspot	LTE Band41 PC3	39750	2506	1RB-Mid	Right	10mm	\	22.28	23	0.104	0.12	0.054	0.06	-0.08
Hotspot	LTE Band41 PC3	39750	2506	1RB-Mid	Top	10mm	\	22.28	23	<0.01	<0.01	<0.01	<0.01	\
Hotspot	LTE Band41 PC3	39750	2506	1RB-Mid	Bottom	10mm	\	22.28	23	0.353	0.42	0.171	0.20	0
Hotspot	LTE Band41 PC3	39750	2506	50RB-High	Front	10mm	\	21.98	22	0.127	0.13	0.065	0.07	-0.14
Hotspot	LTE Band41 PC3	39750	2506	50RB-High	Rear Off	10mm	\	21.98	22	0.371	0.37	0.179	0.18	0.01
Hotspot	LTE Band41 PC3	39750	2506	50RB-High	Rear On	10mm	\	21.98	22	0.24	0.24	0.116	0.12	0.18
Hotspot	LTE Band41 PC3	39750	2506	50RB-High	Left	10mm	\	21.98	22	0.143	0.14	0.073	0.07	0.02
Hotspot	LTE Band41 PC3	39750	2506	50RB-High	Right	10mm	\	21.98	22	0.103	0.10	0.054	0.05	0.16
Hotspot	LTE Band41 PC3	39750	2506	50RB-High	Top	10mm	\	21.98	22	<0.01	<0.01	<0.01	<0.01	\
Hotspot	LTE Band41 PC3	39750	2506	50RB-High	Bottom	10mm	\	21.98	22	0.347	0.35	0.169	0.17	0.06
Body	LTE Band41 PC3	40185	2549.5	1RB-Mid	Front	15mm	\	23.22	24	0.081	0.10	0.042	0.05	-0.02
Body	LTE Band41 PC3	40185	2549.5	1RB-Mid	Rear Off	15mm	F.38	23.22	24	0.234	0.28	0.118	0.14	0.02
Body	LTE Band41 PC3	40185	2549.5	1RB-Mid	Rear On	15mm	\	23.22	24	0.228	0.27	0.112	0.13	0.07
Body	LTE Band41 PC3	39750	2506	50RB-High	Front	15mm	\	22.23	23	0.065	0.08	0.034	0.04	-0.17
Body	LTE Band41 PC3	39750	2506	50RB-High	Rear Off	15mm	\	22.23	23	0.182	0.22	0.092	0.11	0.1
Body	LTE Band41 PC3	39750	2506	50RB-High	Rear On	15mm	\	22.23	23	0.174	0.21	0.094	0.11	0.08
Head	LTE Band66	132322	1745	1RB-Mid	Cheek Left	0mm	F.39	23.66	25	0.188	0.26	0.102	0.14	0.15
Head	LTE Band66	132322	1745	1RB-Mid	Tilt Left	0mm	\	23.66	25	0.042	0.06	0.024	0.03	-0.13
Head	LTE Band66	132322	1745	1RB-Mid	Cheek Right	0mm	\	23.66	25	0.099	0.13	0.048	0.07	-0.1
Head	LTE Band66	132322	1745	1RB-Mid	Tilt Right	0mm	\	23.66	25	0.063	0.09	0.037	0.05	-0.07
Head	LTE Band66	132322	1745	50RB-Low	Cheek Left	0mm	\	22.63	24	0.142	0.19	0.075	0.10	0.15
Head	LTE Band66	132322	1745	50RB-Low	Tilt Left	0mm	\	22.63	24	0.036	0.05	0.022	0.03	0.11
Head	LTE Band66	132322	1745	50RB-Low	Cheek Right	0mm	\	22.63	24	0.064	0.09	0.031	0.04	-0.17
Head	LTE Band66	132322	1745	50RB-Low	Tilt Right	0mm	\	22.63	24	0.043	0.06	0.025	0.03	0.01
Hotspot	LTE Band66	132322	1745	1RB-Mid	Front	10mm	\	20.62	21	0.171	0.19	0.105	0.11	0.1
Hotspot	LTE Band66	132572	1770	1RB-Mid	Rear Off	10mm	\	20.33	21	0.631	0.74	0.367	0.43	0.11
Hotspot	LTE Band66	132322	1745	1RB-Mid	Rear Off	10mm	F.40	20.62	21	0.837	0.91	0.477	0.52	-0.09
Hotspot	LTE Band66	132072	1720	1RB-Mid	Rear Off	10mm	\	20.46	21	0.733	0.83	0.424	0.48	-0.07
Hotspot	LTE Band66	132322	1745	1RB-Mid	Rear On	10mm	\	20.62	21	0.408	0.45	0.253	0.28	0.18
Hotspot	LTE Band66	132322	1745	1RB-Mid	Left	10mm	\	20.62	21	0.189	0.21	0.107	0.12	0.12
Hotspot	LTE Band66	132322	1745	1RB-Mid	Right	10mm	\	20.62	21	0.066	0.07	0.042	0.05	0.07
Hotspot	LTE Band66	132322	1745	1RB-Mid	Top	10mm	\	20.62	21	<0.01	<0.01	<0.01	<0.01	\
Hotspot	LTE Band66	132322	1745	1RB-Mid	Bottom	10mm	\	20.62	21	0.650	0.71	0.351	0.38	0.15
Hotspot	LTE Band66	132322	1745	50RB-Mid	Front	10mm	\	20.53	21	0.163	0.18	0.102	0.11	0.14
Hotspot	LTE Band66	132572	1770	50RB-Mid	Rear Off	10mm	\	20.30	21	0.645	0.76	0.374	0.44	-0.03
Hotspot	LTE Band66	132322	1745	50RB-Mid	Rear Off	10mm	\	20.53	21	0.745	0.83	0.427	0.48	-0.14
Hotspot	LTE Band66	132072	1720	50RB-Mid	Rear Off	10mm	\	20.37	21	0.713	0.82	0.412	0.48	0.17
Hotspot	LTE Band66	132322	1745	50RB-Mid	Rear On	10mm	\	20.53	21	0.392	0.44	0.24	0.27	0.11
Hotspot	LTE Band66	132322	1745	50RB-Mid	Left	10mm	\	20.53	21	0.172	0.19	0.098	0.11	0.07
Hotspot	LTE Band66	132322	1745	50RB-Mid	Right	10mm	\	20.53	21	0.064	0.07	0.041	0.05	-0.04
Hotspot	LTE Band66	132322	1745	50RB-Mid	Top	10mm	\	20.53	21	<0.01	<0.01	<0.01	<0.01	\
Hotspot	LTE Band66	132322	1745	50RB-Mid	Bottom	10mm	\	20.53	21	0.589	0.66	0.317	0.35	-0.18
Hotspot	LTE Band66	132322	1745	100RB	Rear Off	10mm	\	20.52	21	0.756	0.84	0.437	0.49	0.04
Hotspot	LTE Band66	132322	1745	1RB-Mid	Rear Off	10mm	B2	20.62	21	0.733	0.80	0.421	0.46	0.08
Body	LTE Band66	132072	1720	1RB-Mid	Front	15mm	\	21.21	22	0.159	0.19	0.1	0.12	-0.13
Body	LTE Band66	132072	1720	1RB-Mid	Rear Off	15mm	F.41	21.21	22	0.514	0.62	0.305	0.37	0.09
Body	LTE Band66	132072	1720	1RB-Mid	Rear On	15mm	\	21.21	22	0.294	0.35	0.193	0.23	-0.13
Body	LTE Band66	132322	1745	50RB-Low	Front	15mm	\	21.17	22	0.16	0.19	0.101	0.12	0
Body	LTE Band66	132322	1745	50RB-Low	Rear Off	15mm	\	21.17	22	0.502	0.61	0.3	0.36	-0.04
Body	LTE Band66	132322	1745	50RB-Low	Rear On	15mm	\	21.17	22	0.226	0.27	0.143	0.17	-0.15



Head	LTE Band71	133222	673	1RB-Mid	Cheek Left	0mm	\	23.50	24	0.217	0.24	0.152	0.17	-0.09
Head	LTE Band71	133222	673	1RB-Mid	Tilt Left	0mm	\	23.50	24	0.090	0.10	0.070	0.08	0.05
Head	LTE Band71	133222	673	1RB-Mid	Cheek Right	0mm	F.42	23.50	24	0.232	0.26	0.162	0.18	-0.16
Head	LTE Band71	133222	673	1RB-Mid	Tilt Right	0mm	\	23.50	24	0.102	0.11	0.077	0.09	0.13
Head	LTE Band71	133222	673	50RB-Mid	Cheek Left	0mm	\	22.52	23	0.163	0.18	0.113	0.13	0
Head	LTE Band71	133222	673	50RB-Mid	Tilt Left	0mm	\	22.52	23	0.069	0.08	0.054	0.06	-0.12
Head	LTE Band71	133222	673	50RB-Mid	Cheek Right	0mm	\	22.52	23	0.21	0.23	0.148	0.17	0.15
Head	LTE Band71	133222	673	50RB-Mid	Tilt Right	0mm	\	22.52	23	0.082	0.09	0.062	0.07	-0.05
Hotspot	LTE Band71	133222	673	1RB-Mid	Front	10mm	\	23.50	24	0.082	0.09	0.064	0.07	-0.07
Hotspot	LTE Band71	133222	673	1RB-Mid	Rear Off	10mm	F.43	23.50	24	0.277	0.31	0.205	0.23	0.1
Hotspot	LTE Band71	133222	673	1RB-Mid	Rear On	10mm	\	23.50	24	0.234	0.26	0.172	0.19	0.1
Hotspot	LTE Band71	133222	673	1RB-Mid	Left	10mm	\	23.50	24	0.089	0.10	0.064	0.07	-0.11
Hotspot	LTE Band71	133222	673	1RB-Mid	Right	10mm	\	23.50	24	0.155	0.17	0.112	0.13	-0.02
Hotspot	LTE Band71	133222	673	1RB-Mid	Top	10mm	\	23.50	24	<0.01	<0.01	<0.01	<0.01	\
Hotspot	LTE Band71	133222	673	1RB-Mid	Bottom	10mm	\	23.50	24	0.072	0.08	0.040	0.04	-0.1
Hotspot	LTE Band71	133222	673	50RB-Mid	Front	10mm	\	22.52	23	0.068	0.08	0.052	0.06	0.14
Hotspot	LTE Band71	133222	673	50RB-Mid	Rear Off	10mm	\	22.52	23	0.236	0.26	0.173	0.19	0.04
Hotspot	LTE Band71	133222	673	50RB-Mid	Rear On	10mm	\	22.52	23	0.207	0.23	0.15	0.17	-0.05
Hotspot	LTE Band71	133222	673	50RB-Mid	Left	10mm	\	22.52	23	0.077	0.09	0.055	0.06	-0.04
Hotspot	LTE Band71	133222	673	50RB-Mid	Right	10mm	\	22.52	23	0.132	0.15	0.095	0.11	0.14
Hotspot	LTE Band71	133222	673	50RB-Mid	Top	10mm	\	22.52	23	<0.01	<0.01	<0.01	<0.01	\
Hotspot	LTE Band71	133222	673	50RB-Mid	Bottom	10mm	\	22.52	23	0.066	0.07	0.036	0.04	0.03
Body	LTE Band71	133222	673	1RB-Mid	Front	15mm	\	23.50	24	0.059	0.07	0.045	0.05	0.16
Body	LTE Band71	133222	673	1RB-Mid	Rear Off	15mm	F.44	23.50	24	0.174	0.20	0.128	0.14	-0.04
Body	LTE Band71	133222	673	1RB-Mid	Rear On	15mm	\	23.50	24	0.122	0.14	0.09	0.10	0.01
Body	LTE Band71	133222	673	50RB-Mid	Front	15mm	\	22.52	23	0.043	0.05	0.034	0.04	-0.06
Body	LTE Band71	133222	673	50RB-Mid	Rear Off	15mm	\	22.52	23	0.132	0.15	0.098	0.11	0.14
Body	LTE Band71	133222	673	50RB-Mid	Rear On	15mm	\	22.52	23	0.134	0.15	0.1	0.11	-0.09

13.2 SAR results for WLAN

The maximum output power specified for production units are determined for all applicable 802.11 transmission modes in each standalone and aggregated frequency band. Maximum output power is measured for the highest maximum output power configuration(s) in each frequency band according to the default power measurement procedures.

When the same transmission mode configurations have the same maximum output power on the same channel for the 802.11 a/g/n/ac/ax modes, the channel in the lower order/sequence 802.11 mode (i.e. a, g, n ac then ax) is selected.

SAR Test reduction was applied from KDB 248227 guidance, when the same maximum power is specified for multiple transmission modes in a frequency band, the largest channel bandwidth, lowest order modulation, lowest data rate and lowest order 802.11a/g/n/ac mode is used for SAR measurement, on the highest measured output power channel in the initial test configuration, for each frequency band. Additional output power measurements were not deemed necessary.

Duty factor plot WIFI2.4G

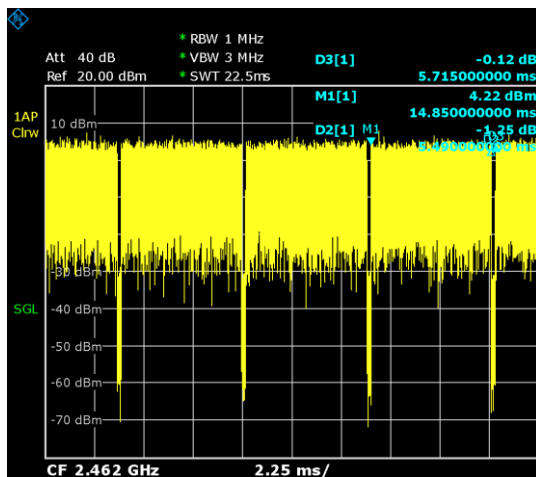

SAR results for WLAN 2.4G

WIFI2.4G-Standalone

RF Exposure Conditions	Frequency Band	Channel Number	Frequency (MHz)	Mode/RB	Test Position	Distance	Figure No./Note	EUT Measured Power (dBm)	Tune up (dBm)	Duty cycle	Measured SAR 1g (W/kg)	Reported SAR 1g (W/kg)	Measured SAR 10g (W/kg)	Reported SAR 10g (W/kg)	Power Drift
Head	WIFI	11	2462	11b 1M	Cheek Left	0mm	\	17.73	19.5	96%	0.287	0.45	0.152	0.24	0.17
Head	WIFI	6	2437	11b 1M	Cheek Left	0mm	F.45	18.9	20	96%	0.348	0.47	0.195	0.26	0.01
Head	WIFI	1	2412	11b 1M	Cheek Left	0mm	\	18.13	20	96%	0.277	0.44	0.148	0.24	0.01
Head	WIFI	6	2437	11b 1M	Tilt Left	0mm	\	18.9	20	96%	0.050	0.07	0.030	0.04	0.06
Head	WIFI	6	2437	11b 1M	Cheek Right	0mm	\	18.9	20	96%	0.299	0.40	0.183	0.25	-0.06
Head	WIFI	6	2437	11b 1M	Tilt Right	0mm	\	18.9	20	96%	0.048	0.06	0.029	0.04	-0.08
Body	WIFI	6	2437	11b 1M	Front	10mm	\	18.90	20	96%	0.053	0.07	0.03	0.04	-0.05
Body	WIFI	11	2462	11b 1M	Rear Off	10mm	\	17.73	19.5	96%	0.265	0.41	0.13	0.20	-0.06
Body	WIFI	6	2437	11b 1M	Rear Off	10mm	F.46	18.90	20	96%	0.397	0.53	0.198	0.27	-0.07
Body	WIFI	1	2412	11b 1M	Rear Off	10mm	\	18.13	20	96%	0.168	0.27	0.084	0.13	0.11
Body	WIFI	6	2437	11b 1M	Rear On	10mm	\	18.90	20	96%	0.264	0.35	0.154	0.21	0.12
Body	WIFI	6	2437	11b 1M	Left	10mm	\	18.90	20	96%	0.041	0.06	0.025	0.03	-0.06
Body	WIFI	6	2437	11b 1M	Right	10mm	\	18.90	20	96%	0.234	0.31	0.111	0.15	0.12
Body	WIFI	6	2437	11b 1M	Top	10mm	\	18.90	20	96%	0.11	0.15	0.059	0.08	0.06
Body	WIFI	6	2437	11b 1M	Bottom	10mm	\	18.90	20	96%	<0.01	<0.01	<0.01	<0.01	\
Body	WIFI	6	2437	11b 1M	Front	15mm	\	18.90	20	96%	<0.01	<0.01	<0.01	<0.01	\
Body	WIFI	11	2462	11b 1M	Rear Off	15mm	\	17.73	19.5	96%	0.12	0.19	0.061	0.10	0.15
Body	WIFI	6	2437	11b 1M	Rear Off	15mm	F.47	18.90	20	96%	0.242	0.32	0.124	0.17	-0.02
Body	WIFI	1	2412	11b 1M	Rear Off	15mm	\	18.13	20	96%	0.143	0.23	0.069	0.11	0.15
Body	WIFI	6	2437	11b 1M	Rear On	15mm	\	18.90	20	96%	0.192	0.26	0.107	0.14	0

WIFI2.4G-WWAN+WIFI

Head	WIFI	11	2462	11b 1M	Cheek Left	0mm	\	14.54	16.5	96%	0.115	0.19	0.065	0.11	-0.17
Head	WIFI	6	2437	11b 1M	Cheek Left	0mm	\	15.68	17	96%	0.141	0.20	0.076	0.11	0.09
Head	WIFI	1	2412	11b 1M	Cheek Left	0mm	\	15.35	17	96%	0.114	0.17	0.052	0.08	0.07
Head	WIFI	6	2437	11b 1M	Tilt Left	0mm	\	15.68	17	96%	<0.01	<0.01	<0.01	<0.01	\
Head	WIFI	6	2437	11b 1M	Cheek Right	0mm	\	15.68	17	96%	0.097	0.14	0.059	0.08	0.08
Head	WIFI	6	2437	11b 1M	Tilt Right	0mm	\	15.68	17	96%	<0.01	<0.01	<0.01	<0.01	\
Body	WIFI	6	2437	11b 1M	Front	10mm	\	15.68	17	96%	<0.01	<0.01	<0.01	<0.01	\
Body	WIFI	11	2462	11b 1M	Rear Off	10mm	\	14.54	16.5	96%	0.142	0.23	0.067	0.11	-0.16
Body	WIFI	6	2437	11b 1M	Rear Off	10mm	\	15.68	17	96%	0.213	0.30	0.103	0.15	-0.05
Body	WIFI	1	2412	11b 1M	Rear Off	10mm	\	15.35	17	96%	0.09	0.14	0.044	0.07	-0.13
Body	WIFI	6	2437	11b 1M	Rear On	10mm	\	15.68	17	96%	0.141	0.20	0.08	0.11	-0.1
Body	WIFI	6	2437	11b 1M	Left	10mm	\	15.68	17	96%	<0.01	<0.01	<0.01	<0.01	\
Body	WIFI	6	2437	11b 1M	Right	10mm	\	15.68	17	96%	0.126	0.18	0.057	0.08	-0.09
Body	WIFI	6	2437	11b 1M	Top	10mm	\	15.68	17	96%	0.059	0.08	0.031	0.04	-0.17
Body	WIFI	6	2437	11b 1M	Bottom	10mm	\	15.68	17	96%	<0.01	<0.01	<0.01	<0.01	\
Body	WIFI	6	2437	11b 1M	Front	15mm	\	15.68	17	96%	<0.01	<0.01	<0.01	<0.01	\
Body	WIFI	11	2462	11b 1M	Rear Off	15mm	\	14.54	16.5	96%	0.058	0.09	0.03	0.05	0.18
Body	WIFI	6	2437	11b 1M	Rear Off	15mm	\	15.68	17	96%	0.116	0.16	0.062	0.09	-0.05
Body	WIFI	1	2412	11b 1M	Rear Off	15mm	\	15.35	17	96%	0.069	0.11	0.035	0.05	-0.03
Body	WIFI	6	2437	11b 1M	Rear On	15mm	\	15.68	17	96%	0.092	0.13	0.054	0.08	0.07

13.3 SAR results for BT

Head	BT	39	2441		Cheek Left	0mm	F.48	11.29	12		0.022	0.03	0.00818	0.01	-0.19
Head	BT	39	2441		Tilt Left	0mm	\	11.29	12		<0.01	<0.01	<0.01	<0.01	\
Head	BT	39	2441		Cheek Right	0mm	\	11.29	12		<0.01	<0.01	<0.01	<0.01	\
Head	BT	39	2441		Tilt Right	0mm	\	11.29	12		<0.01	<0.01	<0.01	<0.01	\
Body	BT	39	2441		Front	10mm	\	11.29	12		<0.01	<0.01	<0.01	<0.01	\
Body	BT	39	2441		Rear Off	10mm	\	11.29	12		<0.01	<0.01	<0.01	<0.01	\
Body	BT	39	2441		Rear On	10mm	\	11.29	12		<0.01	<0.01	<0.01	<0.01	\
Body	BT	39	2441		Left	10mm	\	11.29	12		<0.01	<0.01	<0.01	<0.01	\
Body	BT	39	2441		Right	10mm	\	11.29	12		<0.01	<0.01	<0.01	<0.01	\
Body	BT	39	2441		Top	10mm	\	11.29	12		<0.01	<0.01	<0.01	<0.01	\
Body	BT	39	2441		Bottom	10mm	\	11.29	12		<0.01	<0.01	<0.01	<0.01	\

14 SAR Measurement Variability

SAR measurement variability must be assessed for each frequency band, which is determined by the SAR probe calibration point and tissue-equivalent medium used for the device measurements. When both head and body tissue-equivalent media are required for SAR measurements in a frequency band, the variability measurement procedures should be applied to the tissue medium with the highest measured SAR, using the highest measured SAR configuration for that tissue-equivalent medium.

The following procedures are applied to determine if repeated measurements are required.

- 1) Repeated measurement is not required when the original highest measured SAR is < 0.80 W/kg; steps 2) through 4) do not apply.
- 2) When the original highest measured SAR is ≥ 0.80 W/kg, repeat that measurement once.
- 3) Perform a second repeated measurement only if the ratio of largest to smallest SAR for the original and first repeated measurements is > 1.20 or when the original or repeated measurement is ≥ 1.45 W/kg (~ 10% from the 1-g SAR limit).
- 4) Perform a third repeated measurement only if the original, first or second repeated measurement is ≥ 1.5 W/kg and the ratio of largest to smallest SAR for the original, first and second repeated measurements is > 1.20 .

RF Exposure Conditions	Frequency Band	Channel Number	Frequency (MHz)	Mode/RB	Test Position	Distance	Highest measured SAR (w/kg)	First repeated SAR (w/kg)	The ratio	second repeated sar (w/kg)
Head	LTE Band2	19100	1900	1RB-Low	Cheek Left	0mm	0.871	0.744	1.17	\
Head	LTE Band2	18900	1880	1RB-Low	Cheek Left	0mm	0.806	0.753	1.07	\
Head	LTE Band2	18700	1860	1RB-Low	Cheek Left	0mm	1.06	0.914	1.16	\
Head	LTE Band25	26590	1905	1RB-High	Cheek Left	0mm	1.1	1.09	1.01	\
Head	LTE Band25	26365	1882.5	50RB-Mid	Cheek Left	0mm	0.852	0.761	1.12	\
Head	LTE Band25	26590	1905	1RB-High	Cheek Left	0mm	0.961	0.874	1.1	\
Hotspot	LTE Band66	132322	1745	1RB-Mid	Rear Off	10mm	0.837	0.747	1.12	\

15 Measurement Uncertainty

15.1 Measurement Uncertainty for Normal SAR Tests (300MHz~3GHz)

No.	Error Description	Type	Uncertainty value	Probably Distribution	Div.	(Ci) 1g	(Ci) 10g	Std. Unc. (1g)	Std. Unc. (10g)	Degree of freedom
Measurement system										
1	Probe calibration	B	6.0	N	1	1	1	6.0	6.0	∞
2	Isotropy	B	4.7	R	$\sqrt{3}$	0.7	0.7	1.9	1.9	∞
3	Boundary effect	B	1.0	R	$\sqrt{3}$	1	1	0.6	0.6	∞
4	Linearity	B	4.7	R	$\sqrt{3}$	1	1	2.7	2.7	∞
5	Detection limit	B	1.0	N	1	1	1	0.6	0.6	∞
6	Readout electronics	B	0.3	R	$\sqrt{3}$	1	1	0.3	0.3	∞
7	Response time	B	0.8	R	$\sqrt{3}$	1	1	0.5	0.5	∞
8	Integration time	B	2.6	R	$\sqrt{3}$	1	1	1.5	1.5	∞
9	RF ambient conditions-noise	B	0	R	$\sqrt{3}$	1	1	0	0	∞
10	RFambient conditions-reflection	B	0	R	$\sqrt{3}$	1	1	0	0	∞
11	Probe positioned mech. restrictions	B	0.4	R	$\sqrt{3}$	1	1	0.2	0.2	∞
12	Probe positioning with respect to phantom shell	B	2.9	R	$\sqrt{3}$	1	1	1.7	1.7	∞
13	Post-processing	B	1.0	R	$\sqrt{3}$	1	1	0.6	0.6	∞
Test sample related										
14	Test sample positioning	A	3.3	N	1	1	1	3.3	3.3	71
15	Device holder uncertainty	A	3.4	N	1	1	1	3.4	3.4	5
16	Drift of output power	B	5.0	R	$\sqrt{3}$	1	1	2.9	2.9	∞
Phantom and set-up										
17	Phantom uncertainty	B	4.0	R	$\sqrt{3}$	1	1	2.3	2.3	∞
18	Liquid conductivity (target)	B	5.0	R	$\sqrt{3}$	0.64	0.43	1.8	1.2	∞
19	Liquid conductivity (meas.)	A	2.06	N	1	0.64	0.43	1.32	0.89	43
20	Liquid permittivity (target)	B	5.0	R	$\sqrt{3}$	0.6	0.49	1.7	1.4	∞
21	Liquid permittivity (meas.)	A	1.6	N	1	0.6	0.49	1.0	0.8	521

Combined standard uncertainty	$u_c = \sqrt{\sum_{i=1}^{21} c_i^2 u_i^2}$							9.55	9.43	257
Expanded uncertainty (confidence interval of 95 %)	$u_e = 2u_c$							19.1	18.9	

15.2 Measurement Uncertainty for Fast SAR Tests (300MHz~3GHz)

No.	Error Description	Type	Uncertainty value	Probably Distribution	Div.	(Ci) 1g	(Ci) 10g	Std. Unc. (1g)	Std. Unc. (10g)	Degree of freedom
Measurement system										
1	Probe calibration	B	6.0	N	1	1	1	6.0	6.0	∞
2	Isotropy	B	4.7	R	$\sqrt{3}$	0.7	0.7	1.9	1.9	∞
3	Boundary effect	B	1.0	R	$\sqrt{3}$	1	1	0.6	0.6	∞
4	Linearity	B	4.7	R	$\sqrt{3}$	1	1	2.7	2.7	∞
5	Detection limit	B	1.0	R	$\sqrt{3}$	1	1	0.6	0.6	∞
6	Readout electronics	B	0.3	R	$\sqrt{3}$	1	1	0.3	0.3	∞
7	Response time	B	0.8	R	$\sqrt{3}$	1	1	0.5	0.5	∞
8	Integration time	B	2.6	R	$\sqrt{3}$	1	1	1.5	1.5	∞
9	RF ambient conditions-noise	B	0	R	$\sqrt{3}$	1	1	0	0	∞
10	RF ambient conditions-reflection	B	0	R	$\sqrt{3}$	1	1	0	0	∞
11	Probe positioned mech. Restrictions	B	0.4	R	$\sqrt{3}$	1	1	0.2	0.2	∞
12	Probe positioning with respect to phantom shell	B	2.9	R	$\sqrt{3}$	1	1	1.7	1.7	∞
13	Post-processing	B	1.0	R	$\sqrt{3}$	1	1	0.6	0.6	∞
14	Fast SAR z-Approximation	B	7.0	R	$\sqrt{3}$	1	1	4.0	4.0	∞
Test sample related										
15	Test sample positioning	A	3.3	N	1	1	1	3.3	3.3	71
16	Device holder uncertainty	A	3.4	N	1	1	1	3.4	3.4	5
17	Drift of output power	B	5.0	R	$\sqrt{3}$	1	1	2.9	2.9	∞
Phantom and set-up										
18	Phantom uncertainty	B	4.0	R	$\sqrt{3}$	1	1	2.3	2.3	∞
19	Liquid conductivity (target)	B	5.0	R	$\sqrt{3}$	0.64	0.43	1.8	1.2	∞
20	Liquid conductivity (meas.)	A	2.06	N	1	0.64	0.43	1.32	0.89	43

21	Liquid permittivity (target)	B	5.0	R	$\sqrt{3}$	0.6	0.49	1.7	1.4	∞
22	Liquid permittivity (meas.)	A	1.6	N	1	0.6	0.49	1.0	0.8	521
Combined standard uncertainty		$u_c = \sqrt{\sum_{i=1}^{22} c_i^2 u_i^2}$						10.4	10.3	257
Expanded uncertainty (confidence interval of 95 %)		$u_e = 2u_c$						20.8	20.6	

16 MAIN TEST INSTRUMENTS

No.	Name	Type	Serial Number	Calibration Date	Valid Period
01	Network analyzer	N5239A	MY55491241	June 5, 2023	One year
02	Power sensor	NRP50S	101488	June 14, 2023	One year
03	Power sensor	NRP50S	101489	June 14, 2023	One year
04	Signal Generator	E4438C	MY49071430	January 19, 2023	One year
05	Amplifier	60S1G4	0331848	No Calibration Requested	
06	BTS	CMW500	170672	April 18, 2023	One year
07	E-field Probe	SPEAG EX3DV4	7600	December 19, 2023	One year
08	DAE	SPEAG DAE4	1525	September 14, 2023	One year
09	Dipole Validation Kit	SPEAG D750V3	1017	July 14,2023	One year
10	Dipole Validation Kit	SPEAG D835V2	4d069	July 14,2023	One year
11	Dipole Validation Kit	SPEAG D1750V2	1003	July 12,2023	One year
12	Dipole Validation Kit	SPEAG D1900V2	5d101	July 17,2023	One year
13	Dipole Validation Kit	SPEAG D2450V2	853	July 11,2023	One year
14	Dipole Validation Kit	SPEAG D2600V2	1012	July 11,2023	One year

END OF REPORT BODY

ANNEX A Graph Results

GSM850 Head

Date/Time: 2024/1/4

Electronics: DAE4 Sn1525

Medium: H700-6000M

Medium parameters used (interpolated): $f = 836.6$ MHz; $\sigma = 0.923$ S/m; $\epsilon_r = 45.441$; $\rho = 1000$ kg/m³

Ambient Temperature: 23.3°C Liquid Temperature: 22.5°C

Communication System: UID 0, GSM 850 Glass 12 (0) Frequency: 836.6 MHz Duty Cycle: 1:1.99986

Probe: EX3DV4 - SN7600 ConvF(10.95, 10.95, 10.95)

Area Scan (81x121x1): Interpolated grid: dx=1.500 mm, dy=1.500 mm
Maximum value of SAR (interpolated) = 0.629 W/kg

Zoom Scan (6x6x7)/Cube 0: Measurement grid: dx=8mm, dy=8mm, dz=5mm
Reference Value = 13.03 V/m; Power Drift = -0.09 dB
Peak SAR (extrapolated) = 0.752 W/kg
SAR(1 g) = 0.443 W/kg; SAR(10 g) = 0.290 W/kg
Maximum value of SAR (measured) = 0.616 W/kg



F. 1

GSM850 Body -10mm

Date/Time: 2024/1/4

Electronics: DAE4 Sn1525

Medium: H700-6000M

Medium parameters used: $f = 825 \text{ MHz}$; $\sigma = 0.869 \text{ S/m}$; $\epsilon_r = 44.759$; $\rho = 1000 \text{ kg/m}^3$ Ambient Temperature: 23.3°C Liquid Temperature: 22.5°C Communication System: UID 0, GSM850 2TX (0) Frequency: 824.2 MHz Duty Cycle: 1:4.00037

Probe: EX3DV4 - SN7600 ConvF(10.95, 10.95, 10.95)

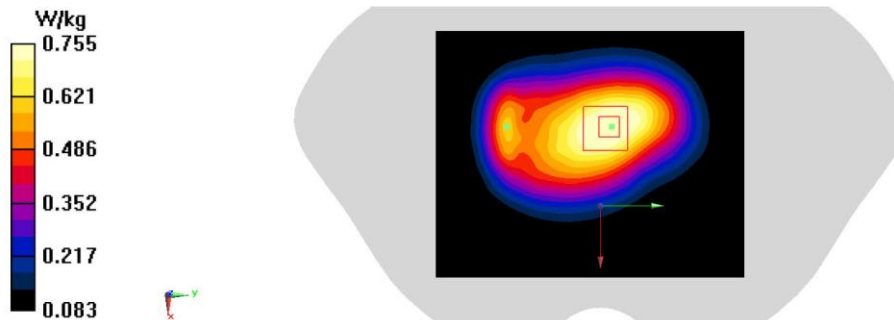
Area Scan (81x101x1): Interpolated grid: $dx=1.500 \text{ mm}$, $dy=1.500 \text{ mm}$ Maximum value of SAR (interpolated) = 0.790 W/kg **Zoom Scan (6x6x7)/Cube 0:** Measurement grid: $dx=8\text{mm}$, $dy=8\text{mm}$, $dz=5\text{mm}$ Reference Value = 30.41 V/m ; Power Drift = -0.03 dB Peak SAR (extrapolated) = 0.796 W/kg **SAR(1 g) = 0.650 W/kg ; SAR(10 g) = 0.488 W/kg** Maximum value of SAR (measured) = 0.755 W/kg 

F. 2

GSM850 Body-15mm

Date/Time: 2024/1/4

Electronics: DAE4 Sn1525

Medium: H700-6000M

Medium parameters used: $f = 825 \text{ MHz}$; $\sigma = 0.869 \text{ S/m}$; $\epsilon_r = 44.759$; $\rho = 1000 \text{ kg/m}^3$ Ambient Temperature: 23.3°C Liquid Temperature: 22.5°C Communication System: UID 0, GSM850 2TX (0) Frequency: 824.2 MHz Duty Cycle: 1:4.00037

Probe: EX3DV4 - SN7600 ConvF(10.95, 10.95, 10.95)

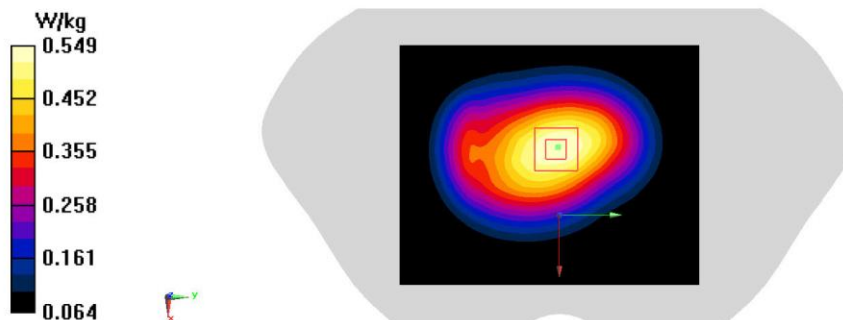
Area Scan (81x101x1): Interpolated grid: $dx=1.500 \text{ mm}$, $dy=1.500 \text{ mm}$ Maximum value of SAR (interpolated) = 0.554 W/kg **Zoom Scan (6x6x7)/Cube 0:** Measurement grid: $dx=8\text{mm}$, $dy=8\text{mm}$, $dz=5\text{mm}$ Reference Value = 26.26 V/m ; Power Drift = 0.05 dB Peak SAR (extrapolated) = 0.581 W/kg **SAR(1 g) = 0.473 W/kg ; SAR(10 g) = 0.355 W/kg** Maximum value of SAR (measured) = 0.549 W/kg 

F. 3

GSM1900 Head

Date/Time: 2024/1/10

Electronics: DAE4 Sn1525

Medium: H700-6000M

Medium parameters used (interpolated): $f = 1850.2$ MHz; $\sigma = 1.465$ S/m; $\epsilon_r = 43.17$; $\rho = 1000$ kg/m³

Ambient Temperature: 23.3°C Liquid Temperature: 22.5°C

Communication System: UID 0, GSM 1900 GPRS-3 (0) Frequency: 1850.2 MHz Duty Cycle: 1:2.66993

Probe: EX3DV4 - SN7600 ConvF(8.63, 8.63, 8.63)

Area Scan (81x121x1): Interpolated grid: dx=1.500 mm, dy=1.500 mm

Maximum value of SAR (interpolated) = 0.218 W/kg

Zoom Scan (7x7x7)/Cube 0: Measurement grid: dx=8mm, dy=8mm, dz=5mm

Reference Value = 4.592 V/m; Power Drift = 0.04 dB

Peak SAR (extrapolated) = 0.251 W/kg

SAR(1 g) = 0.169 W/kg; SAR(10 g) = 0.112 W/kg

Maximum value of SAR (measured) = 0.219 W/kg

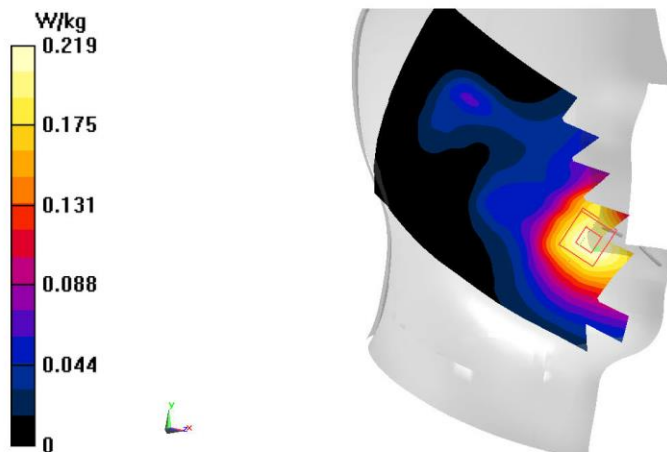

F. 4

GSM1900 Body-10mm

Date/Time: 2024/1/10

Electronics: DAE4 Sn1525

Medium: H700-6000M

Medium parameters used (interpolated): $f = 1850.2$ MHz; $\sigma = 1.447$ S/m; $\epsilon_r = 41.914$; $\rho = 1000$ kg/m³

Ambient Temperature: 23.3°C Liquid Temperature: 22.5°C

Communication System: UID 0, GSM1900 3TX (0) Frequency: 1850.2 MHz Duty Cycle: 1:2.66993

Probe: EX3DV4 - SN7600 ConvF(8.63, 8.63, 8.63)

Area Scan (81x101x1): Interpolated grid: dx=1.500 mm, dy=1.500 mm

Maximum value of SAR (interpolated) = 1.15 W/kg

Zoom Scan (6x6x7)/Cube 0: Measurement grid: dx=8mm, dy=8mm, dz=5mm

Reference Value = 10.90 V/m; Power Drift = 0.15 dB

Peak SAR (extrapolated) = 1.28 W/kg

SAR(1 g) = 0.771 W/kg; SAR(10 g) = 0.464 W/kg

Maximum value of SAR (measured) = 1.08 W/kg

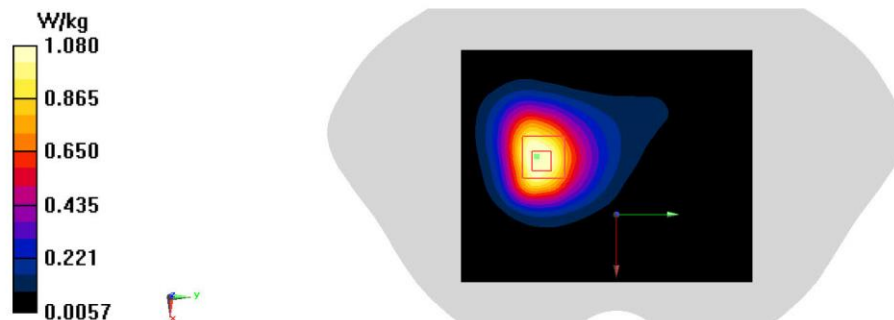

F. 5

GSM1900 Body-15mm

Date/Time: 2024/1/10

Electronics: DAE4 Sn1525

Medium: H700-6000M

Medium parameters used (interpolated): $f = 1850.2$ MHz; $\sigma = 1.447$ S/m; $\epsilon_r = 41.914$; $\rho = 1000$ kg/m³

Ambient Temperature: 23.3°C Liquid Temperature: 22.5°C

Communication System: UID 0, GSM1900 3TX (0) Frequency: 1850.2 MHz Duty Cycle: 1:2.66993

Probe: EX3DV4 - SN7600 ConvF(8.63, 8.63, 8.63)

Area Scan (81x101x1): Interpolated grid: dx=1.500 mm, dy=1.500 mm

Maximum value of SAR (interpolated) = 0.621 W/kg

Zoom Scan (6x6x7)/Cube 0: Measurement grid: dx=8mm, dy=8mm, dz=5mm

Reference Value = 10.17 V/m; Power Drift = 0.13 dB

Peak SAR (extrapolated) = 0.682 W/kg

SAR(1 g) = 0.435 W/kg; SAR(10 g) = 0.269 W/kg

Maximum value of SAR (measured) = 0.592 W/kg

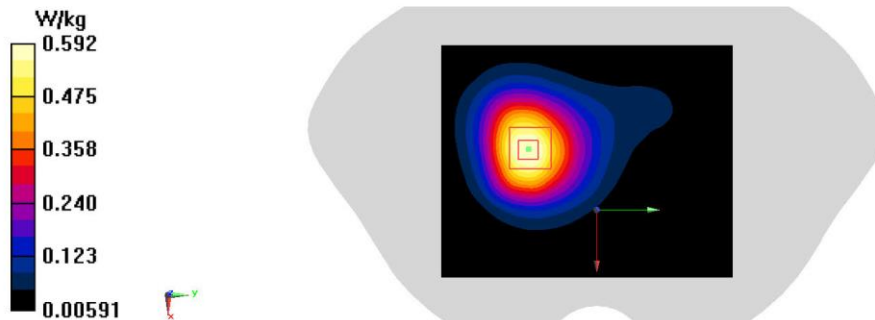

F. 6

WCDMA850 Head

Date/Time: 2024/1/4

Electronics: DAE4 Sn1525

Medium: H700-6000M

Medium parameters used (interpolated): $f = 836.6$ MHz; $\sigma = 0.923$ S/m; $\epsilon_r = 45.441$; $\rho = 1000$ kg/m³

Ambient Temperature: 23.3°C Liquid Temperature: 22.5°C

Communication System: UID 0, WCDMA 850 (0) Frequency: 836.6 MHz Duty Cycle: 1:1

Probe: EX3DV4 - SN7600 ConvF(10.95, 10.95, 10.95)

Area Scan (81x121x1): Interpolated grid: dx=1.500 mm, dy=1.500 mm

Maximum value of SAR (interpolated) = 0.657 W/kg

Zoom Scan (6x7x7)/Cube 0: Measurement grid: dx=8mm, dy=8mm, dz=5mm

Reference Value = 13.45 V/m; Power Drift = -0.11 dB

Peak SAR (extrapolated) = 0.731 W/kg

SAR(1 g) = 0.444 W/kg; SAR(10 g) = 0.299 W/kg

Maximum value of SAR (measured) = 0.613 W/kg

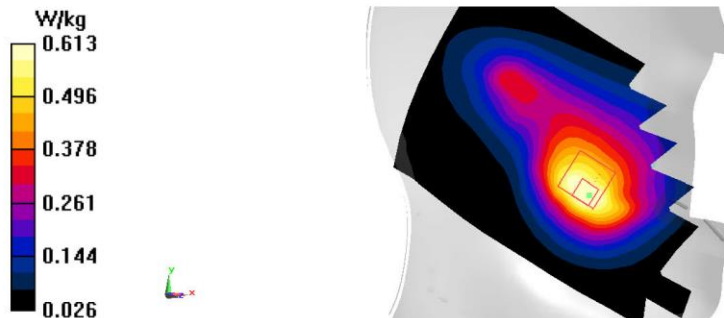

F. 7

WCDMA850 Body -10mm

Date/Time: 2024/1/4

Electronics: DAE4 Sn1525

Medium: H700-6000M

Medium parameters used (interpolated): $f = 826.4$ MHz; $\sigma = 0.869$ S/m; $\epsilon_r = 44.75$; $\rho = 1000$ kg/m³

Ambient Temperature: 23.3°C Liquid Temperature: 22.5°C

Communication System: UID 0, WCDMA850(B5) (0) Frequency: 826.4 MHz Duty Cycle: 1:1

Probe: EX3DV4 - SN7600 ConvF(10.95, 10.95, 10.95)

Area Scan (81x101x1): Interpolated grid: dx=1.500 mm, dy=1.500 mm

Maximum value of SAR (interpolated) = 0.689 W/kg

Zoom Scan (6x6x7)/Cube 0: Measurement grid: dx=8mm, dy=8mm, dz=5mm

Reference Value = 27.23 V/m; Power Drift = 0.01 dB

Peak SAR (extrapolated) = 0.698 W/kg

SAR(1 g) = 0.569 W/kg; SAR(10 g) = 0.426 W/kg

Maximum value of SAR (measured) = 0.663 W/kg

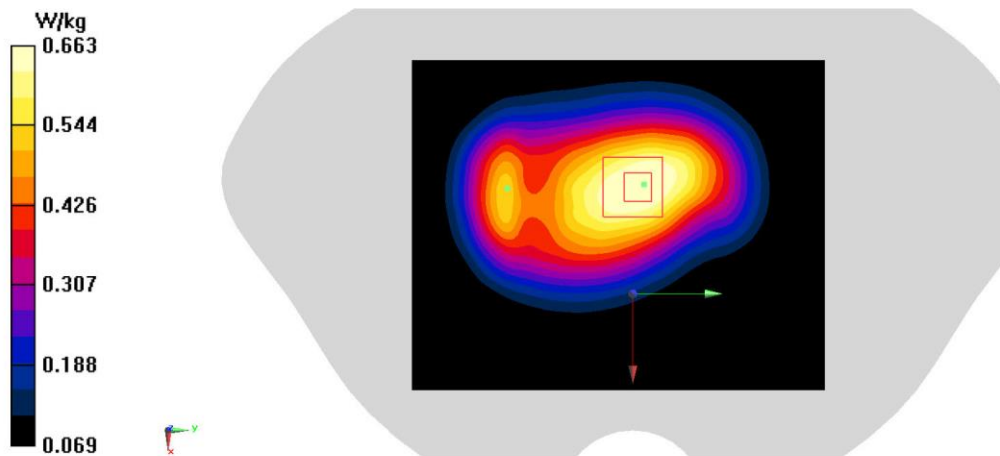

F. 8

WCDMA850 Body-15mm

Date/Time: 2024/1/4

Electronics: DAE4 Sn1525

Medium: H700-6000M

Medium parameters used (interpolated): $f = 826.4$ MHz; $\sigma = 0.869$ S/m; $\epsilon_r = 44.75$; $\rho = 1000$ kg/m³

Ambient Temperature: 23.3°C Liquid Temperature: 22.5°C

Communication System: UID 0, WCDMA850(B5) (0) Frequency: 826.4 MHz Duty Cycle: 1:1

Probe: EX3DV4 - SN7600 ConvF(10.95, 10.95, 10.95)

Area Scan (81x101x1): Interpolated grid: dx=1.500 mm, dy=1.500 mm

Maximum value of SAR (interpolated) = 0.543 W/kg

Zoom Scan (6x6x7)/Cube 0: Measurement grid: dx=8mm, dy=8mm, dz=5mm

Reference Value = 25.40 V/m; Power Drift = -0.05 dB

Peak SAR (extrapolated) = 0.551 W/kg

SAR(1 g) = 0.446 W/kg; SAR(10 g) = 0.335 W/kg

Maximum value of SAR (measured) = 0.521 W/kg

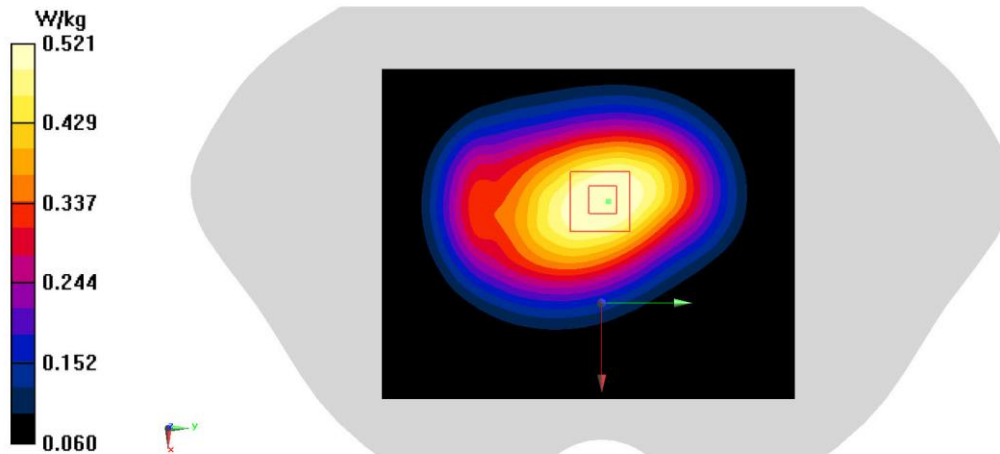

F. 9

W1700 Head

Date/Time: 2024/1/7

Electronics: DAE4 Sn1525

Medium: H700-6000M

Medium parameters used (interpolated): $f = 1732.4$ MHz; $\sigma = 1.394$ S/m; $\epsilon_r = 43.424$; $\rho = 1000$ kg/m³

Ambient Temperature: 23.3°C Liquid Temperature: 22.5°C

Communication System: UID 0, WCDMA 1700 Band4 (0) Frequency: 1732.4 MHz Duty Cycle: 1:1

Probe: EX3DV4 - SN7600 ConvF(8.98, 8.98, 8.98)

Area Scan (81x121x1): Interpolated grid: dx=1.500 mm, dy=1.500 mm

Maximum value of SAR (interpolated) = 0.279 W/kg

Zoom Scan (5x5x7)/Cube 0: Measurement grid: dx=8mm, dy=8mm, dz=5mm

Reference Value = 5.914 V/m; Power Drift = 0.04 dB

Peak SAR (extrapolated) = 0.324 W/kg

SAR(1 g) = 0.217 W/kg; SAR(10 g) = 0.121 W/kg

Maximum value of SAR (measured) = 0.292 W/kg

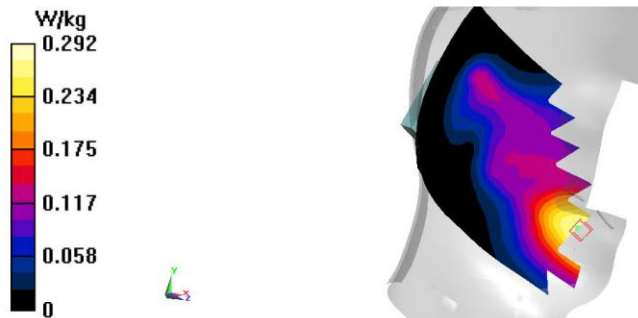

F. 10

WCDMA1700 Body-10mm

Date/Time: 2024/1/7

Electronics: DAE4 Sn1525

Medium: H700-6000M

Medium parameters used (interpolated): $f = 1752.6$ MHz; $\sigma = 1.383$ S/m; $\epsilon_r = 42.123$; $\rho = 1000$ kg/m³

Ambient Temperature: 23.3°C Liquid Temperature: 22.5°C

Communication System: UID 0, WCDMA1700(B4) (0) Frequency: 1752.6 MHz Duty Cycle: 1:1

Probe: EX3DV4 - SN7600 ConvF(8.98, 8.98, 8.98)

Area Scan (81x101x1): Interpolated grid: dx=1.500 mm, dy=1.500 mm

Maximum value of SAR (interpolated) = 1.20 W/kg

Zoom Scan (7x6x7)/Cube 0: Measurement grid: dx=8mm, dy=8mm, dz=5mm

Reference Value = 10.66 V/m; Power Drift = 0.06 dB

Peak SAR (extrapolated) = 1.39 W/kg

SAR(1 g) = 0.798 W/kg; SAR(10 g) = 0.462 W/kg

Maximum value of SAR (measured) = 1.16 W/kg

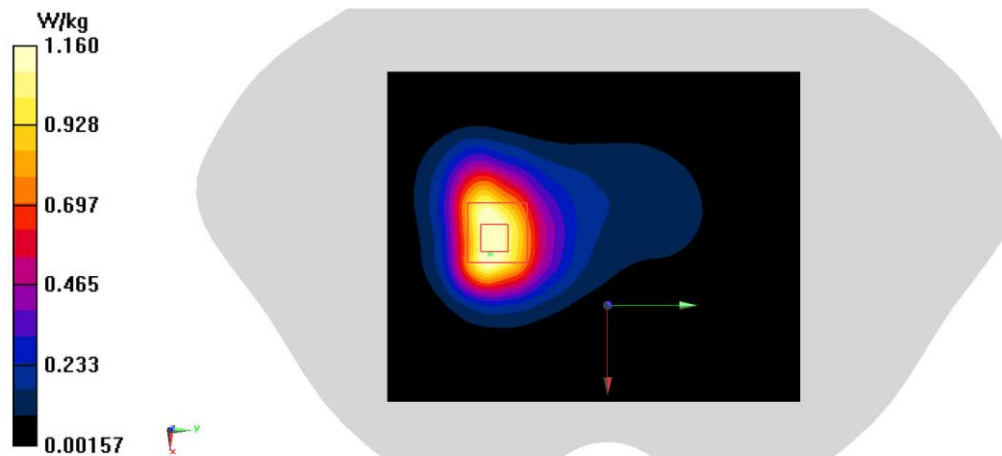

F. 11

WCDMA1700 Body-15mm

Date/Time: 2024/1/7

Electronics: DAE4 Sn1525

Medium: H700-6000M

Medium parameters used (interpolated): $f = 1752.6$ MHz; $\sigma = 1.383$ S/m; $\epsilon_r = 42.123$; $\rho = 1000$ kg/m³

Ambient Temperature: 23.3°C Liquid Temperature: 22.5°C

Communication System: UID 0, WCDMA1700(B4) (0) Frequency: 1752.6 MHz Duty Cycle: 1:1

Probe: EX3DV4 - SN7600 ConvF(8.98, 8.98, 8.98)

Area Scan (81x101x1): Interpolated grid: dx=1.500 mm, dy=1.500 mm

Maximum value of SAR (interpolated) = 0.673 W/kg

Zoom Scan (6x6x7)/Cube 0: Measurement grid: dx=8mm, dy=8mm, dz=5mm

Reference Value = 9.150 V/m; Power Drift = -0.09 dB

Peak SAR (extrapolated) = 0.744 W/kg

SAR(1 g) = 0.455 W/kg; SAR(10 g) = 0.274 W/kg

Maximum value of SAR (measured) = 0.641 W/kg

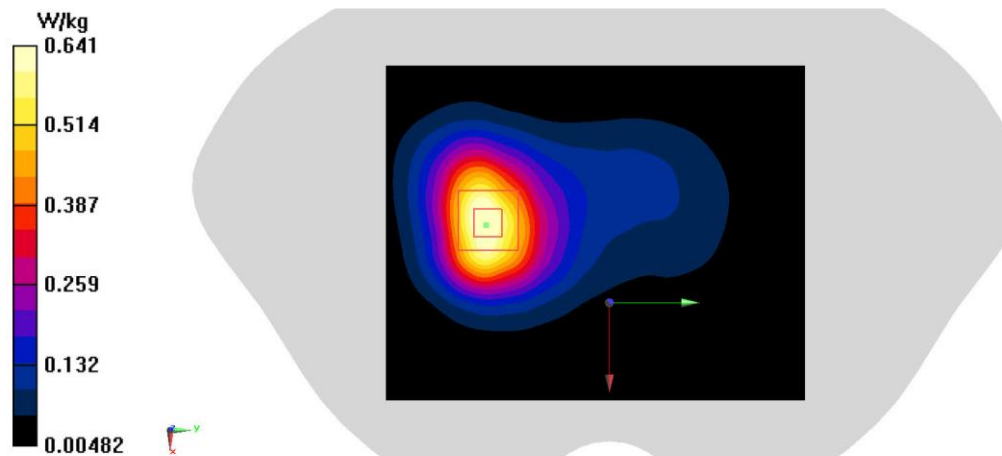

F. 12

WCDMA1900 Body-10mm

Date/Time: 2024/1/10

Electronics: DAE4 Sn1525

Medium: H700-6000M

Medium parameters used: $f = 1880$ MHz; $\sigma = 1.471$ S/m; $\epsilon_r = 41.838$; $\rho = 1000$ kg/m³

Ambient Temperature: 23.3°C Liquid Temperature: 22.5°C

Communication System: UID 0, WCDMA1900(B2) (0) Frequency: 1880 MHz Duty Cycle: 1:1

Probe: EX3DV4 - SN7600 ConvF(8.63, 8.63, 8.63)

Area Scan (81x101x1): Interpolated grid: dx=1.500 mm, dy=1.500 mm

Maximum value of SAR (interpolated) = 1.02 W/kg

Zoom Scan (6x6x7)/Cube 0: Measurement grid: dx=8mm, dy=8mm, dz=5mm

Reference Value = 12.11 V/m; Power Drift = 0.10 dB

Peak SAR (extrapolated) = 1.14 W/kg

SAR(1 g) = 0.707 W/kg; SAR(10 g) = 0.429 W/kg

Maximum value of SAR (measured) = 0.978 W/kg

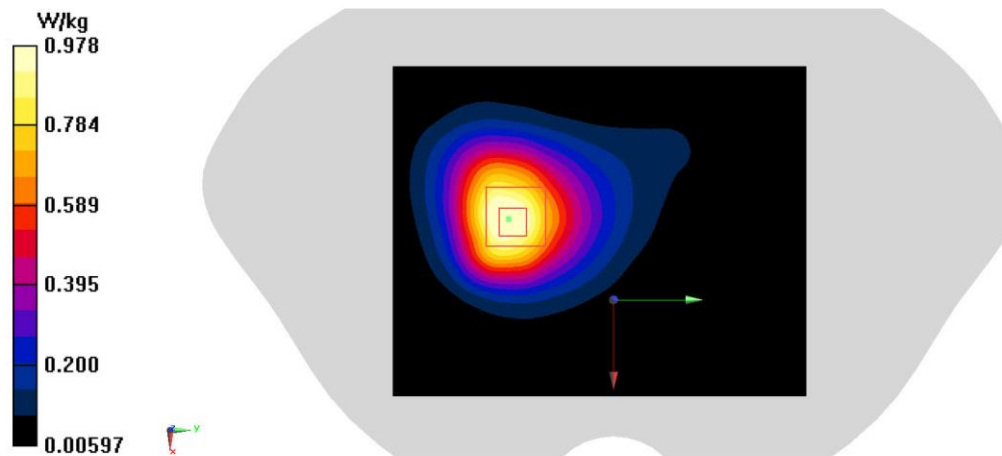

F. 13

WCDMA1900 Body-15mm

Date/Time: 2024/1/10

Electronics: DAE4 Sn1525

Medium: H700-6000M

Medium parameters used: $f = 1880$ MHz; $\sigma = 1.471$ S/m; $\epsilon_r = 41.838$; $\rho = 1000$ kg/m³

Ambient Temperature: 23.3°C Liquid Temperature: 22.5°C

Communication System: UID 0, WCDMA1900(B2) (0) Frequency: 1880 MHz Duty Cycle: 1:1

Probe: EX3DV4 - SN7600 ConvF(8.63, 8.63, 8.63)

Area Scan (81x101x1): Interpolated grid: dx=1.500 mm, dy=1.500 mm

Maximum value of SAR (interpolated) = 0.723 W/kg

Zoom Scan (6x6x7)/Cube 0: Measurement grid: dx=8mm, dy=8mm, dz=5mm

Reference Value = 14.01 V/m; Power Drift = -0.16 dB

Peak SAR (extrapolated) = 0.805 W/kg

SAR(1 g) = 0.518 W/kg; SAR(10 g) = 0.322 W/kg

Maximum value of SAR (measured) = 0.703 W/kg

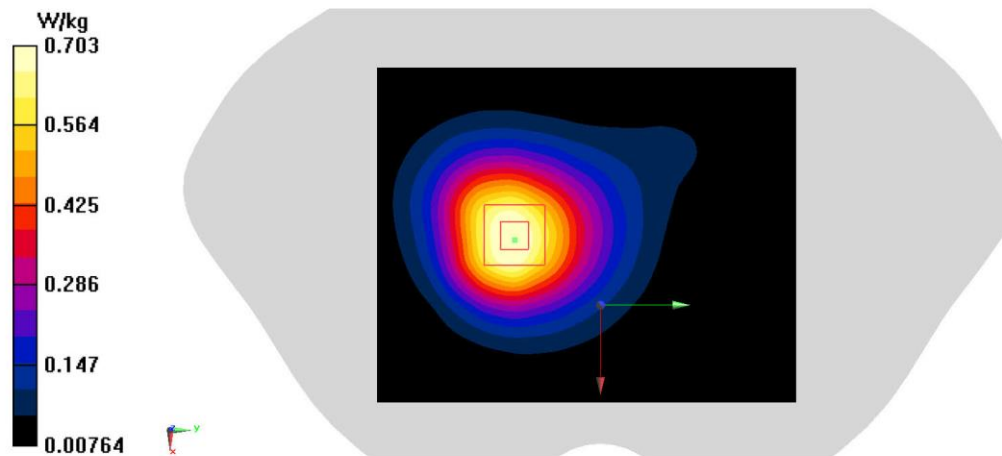

F. 14

LTE B2 Head

Date/Time: 2024/1/10

Electronics: DAE4 Sn1525

Medium: H700-6000M

Medium parameters used: $f = 1880$ MHz; $\sigma = 1.48$ S/m; $\epsilon_r = 43.121$; $\rho = 1000$ kg/m³

Ambient Temperature: 23.3°C Liquid Temperature: 22.5°C

Communication System: UID 0, LTE Band2(20MB) (0) Frequency: 1880 MHz Duty Cycle: 1:1

Probe: EX3DV4 - SN7600 ConvF(8.63, 8.63, 8.63)

Area Scan (71x121x1): Interpolated grid: $dx=1.500$ mm, $dy=1.500$ mm

Maximum value of SAR (interpolated) = 1.42 W/kg

Zoom Scan (6x6x7)/Cube 0: Measurement grid: $dx=8$ mm, $dy=8$ mm, $dz=5$ mm

Reference Value = 1.243 V/m; Power Drift = 0.06 dB

Peak SAR (extrapolated) = 1.59 W/kg

SAR(1 g) = 1.06 W/kg; SAR(10 g) = 0.714 W/kg

Maximum value of SAR (measured) = 1.38 W/kg



F. 15

LTE B2 Body-10mm

Date/Time: 2024/1/10

Electronics: DAE4 Sn1525

Medium: H700-6000M

Medium parameters used: $f = 1880$ MHz; $\sigma = 1.471$ S/m; $\epsilon_r = 41.838$; $\rho = 1000$ kg/m³

Ambient Temperature: 23.3°C Liquid Temperature: 22.5°C

Communication System: UID 0, LTE Band2 (0) Frequency: 1880 MHz Duty Cycle: 1:1

Probe: EX3DV4 - SN7600 ConvF(8.63, 8.63, 8.63)

Area Scan (81x101x1): Interpolated grid: dx=1.500 mm, dy=1.500 mm

Maximum value of SAR (interpolated) = 1.04 W/kg

Zoom Scan (6x6x7)/Cube 0: Measurement grid: dx=8mm, dy=8mm, dz=5mm

Reference Value = 14.34 V/m; Power Drift = 0.05 dB

Peak SAR (extrapolated) = 1.18 W/kg

SAR(1 g) = 0.723 W/kg; SAR(10 g) = 0.440 W/kg

Maximum value of SAR (measured) = 1.01 W/kg

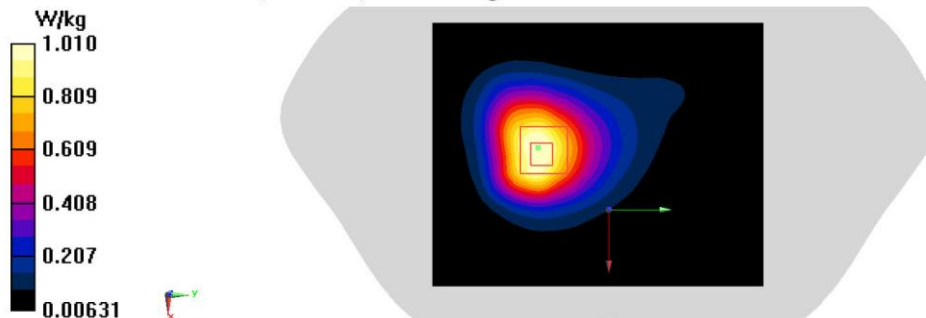

F. 16

LTE B2 Body-15mm

Date/Time: 2024/1/10

Electronics: DAE4 Sn1525

Medium: H700-6000M

Medium parameters used: $f = 1880$ MHz; $\sigma = 1.471$ S/m; $\epsilon_r = 41.838$; $\rho = 1000$ kg/m³

Ambient Temperature: 23.3°C Liquid Temperature: 22.5°C

Communication System: UID 0, LTE Band2 (0) Frequency: 1880 MHz Duty Cycle: 1:1

Probe: EX3DV4 - SN7600 ConvF(8.63, 8.63, 8.63)

Area Scan (81x101x1): Interpolated grid: dx=1.500 mm, dy=1.500 mm

Maximum value of SAR (interpolated) = 0.748 W/kg

Zoom Scan (6x6x7)/Cube 0: Measurement grid: dx=8mm, dy=8mm, dz=5mm

Reference Value = 12.09 V/m; Power Drift = 0.04 dB

Peak SAR (extrapolated) = 0.854 W/kg

SAR(1 g) = 0.551 W/kg; SAR(10 g) = 0.342 W/kg

Maximum value of SAR (measured) = 0.744 W/kg

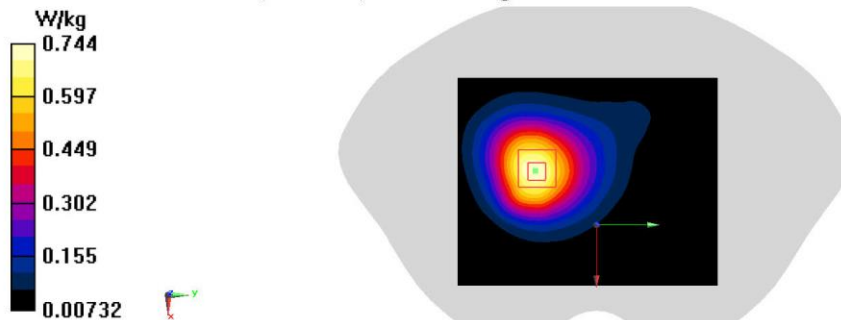

F. 17

LTE B4 Head

Date/Time: 2024/1/7

Electronics: DAE4 Sn1525

Medium: H700-6000M

Medium parameters used: $f = 1745$ MHz; $\sigma = 1.378$ S/m; $\epsilon_r = 42.151$; $\rho = 1000$ kg/m³

Ambient Temperature: 23.3°C Liquid Temperature: 22.5°C

Communication System: UID 0, LTE Band4 (0) Frequency: 1745 MHz Duty Cycle: 1:1

Probe: EX3DV4 - SN7600 ConvF(8.98, 8.98, 8.98)

Area Scan (71x121x1): Interpolated grid: dx=1.500 mm, dy=1.500 mm

Maximum value of SAR (interpolated) = 0.310 W/kg

Zoom Scan (7x6x7)/Cube 0: Measurement grid: dx=8mm, dy=8mm, dz=5mm

Reference Value = 5.662 V/m; Power Drift = 0.06 dB

Peak SAR (extrapolated) = 0.332 W/kg

SAR(1 g) = 0.244 W/kg; SAR(10 g) = 0.168 W/kg

Maximum value of SAR (measured) = 0.304 W/kg

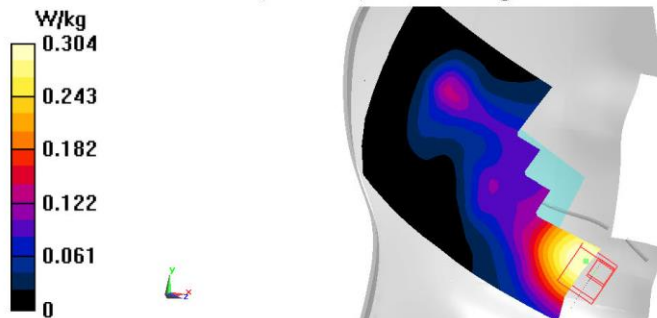

F. 18

LTE B4 Body-10mm

Date/Time: 2024/1/7

Electronics: DAE4 Sn1525

Medium: H700-6000M

Medium parameters used (interpolated): $f = 1732.5$ MHz; $\sigma = 1.37$ S/m; $\epsilon_r = 42.208$; $\rho = 1000$ kg/m³

Ambient Temperature: 23.3°C Liquid Temperature: 22.5°C

Communication System: UID 0, LTE Band4 (0) Frequency: 1732.5 MHz Duty Cycle: 1:1

Probe: EX3DV4 - SN7600 ConvF(8.98, 8.98, 8.98)

Area Scan (81x101x1): Interpolated grid: dx=1.500 mm, dy=1.500 mm

Maximum value of SAR (interpolated) = 1.14 W/kg

Zoom Scan (6x6x7)/Cube 0: Measurement grid: dx=8mm, dy=8mm, dz=5mm

Reference Value = 10.75 V/m; Power Drift = 0.02 dB

Peak SAR (extrapolated) = 1.19 W/kg

SAR(1 g) = 0.688 W/kg; SAR(10 g) = 0.397 W/kg

Maximum value of SAR (measured) = 1.02 W/kg

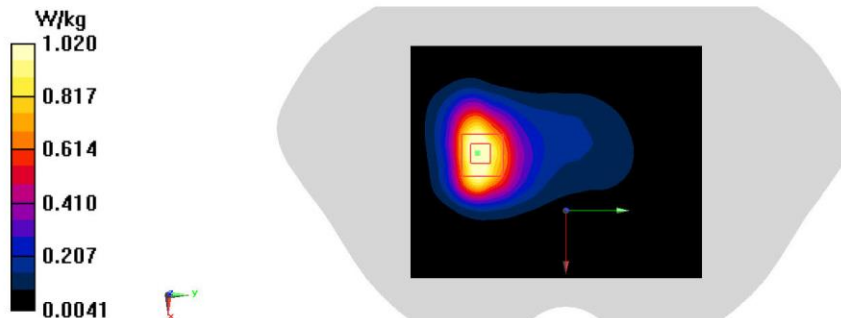

F. 19

LTE B4 Body-15mm

Date/Time: 2024/1/7

Electronics: DAE4 Sn1525

Medium: H700-6000M

Medium parameters used (interpolated): $f = 1732.5$ MHz; $\sigma = 1.37$ S/m; $\epsilon_r = 42.208$; $\rho = 1000$ kg/m³

Ambient Temperature: 23.3°C Liquid Temperature: 22.5°C

Communication System: UID 0, LTE Band4 (0) Frequency: 1732.5 MHz Duty Cycle: 1:1

Probe: EX3DV4 - SN7600 ConvF(8.98, 8.98, 8.98)

Area Scan (81x101x1): Interpolated grid: dx=1.500 mm, dy=1.500 mm

Maximum value of SAR (interpolated) = 0.630 W/kg

Zoom Scan (6x6x7)/Cube 0: Measurement grid: dx=8mm, dy=8mm, dz=5mm

Reference Value = 9.762 V/m; Power Drift = 0.02 dB

Peak SAR (extrapolated) = 0.788 W/kg

SAR(1 g) = 0.472 W/kg; SAR(10 g) = 0.275 W/kg

Maximum value of SAR (measured) = 0.667 W/kg

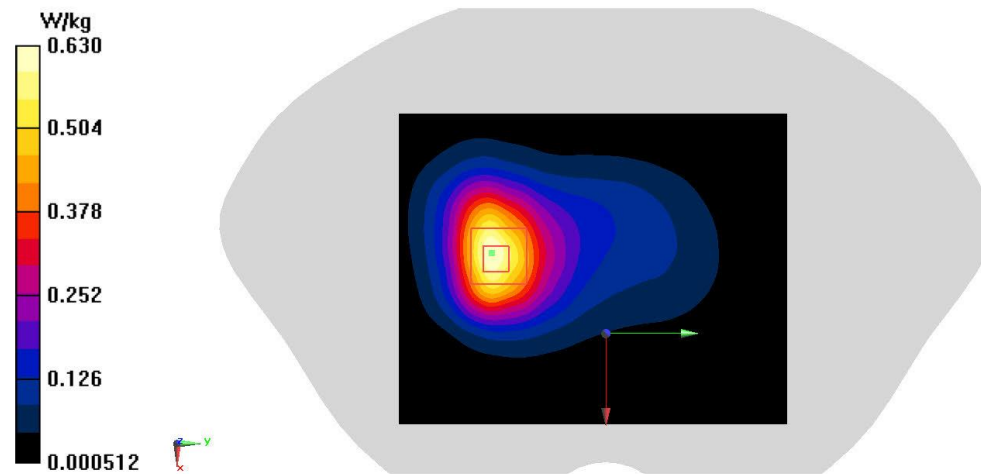

F. 20

LTE B5 Head

Date/Time: 2024/1/4

Electronics: DAE4 Sn1525

Medium: H700-6000M

Medium parameters used (interpolated): $f = 844 \text{ MHz}$; $\sigma = 0.927 \text{ S/m}$; $\epsilon_r = 45.43$; $\rho = 1000 \text{ kg/m}^3$

Ambient Temperature: 23.3°C Liquid Temperature: 22.5°C

Communication System: UID 0, LTE Band5 (0) Frequency: 844 MHz Duty Cycle: 1:1

Probe: EX3DV4 - SN7600 ConvF(10.95, 10.95, 10.95)

Area Scan (81x121x1): Interpolated grid: $dx=1.500 \text{ mm}$, $dy=1.500 \text{ mm}$

Maximum value of SAR (interpolated) = 1.00 W/kg

Zoom Scan (6x6x7)/Cube 0: Measurement grid: $dx=8\text{mm}$, $dy=8\text{mm}$, $dz=5\text{mm}$

Reference Value = 15.85 V/m; Power Drift = -0.17 dB

Peak SAR (extrapolated) = 1.07 W/kg

SAR(1 g) = 0.734 W/kg; SAR(10 g) = 0.535 W/kg

Maximum value of SAR (measured) = 0.934 W/kg

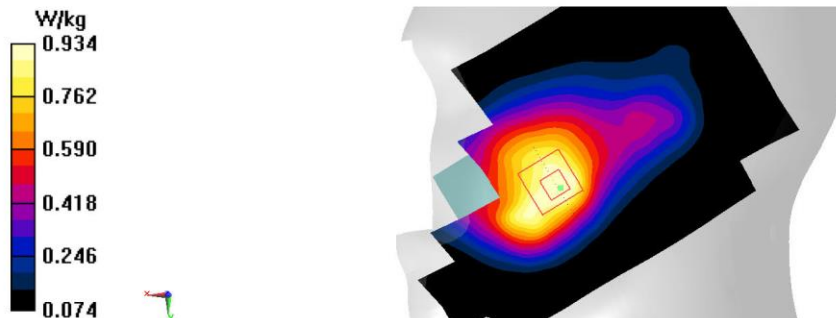

F. 21

LTE B5 Body -10mm

Date/Time: 2024/1/4

Electronics: DAE4 Sn1525

Medium: H700-6000M

Medium parameters used (interpolated): $f = 844 \text{ MHz}$; $\sigma = 0.876 \text{ S/m}$; $\epsilon_r = 44.617$; $\rho = 1000 \text{ kg/m}^3$

Ambient Temperature: 23.3°C Liquid Temperature: 22.5°C

Communication System: UID 0, LTE Band5 (0) Frequency: 844 MHz Duty Cycle: 1:1

Probe: EX3DV4 - SN7600 ConvF(10.95, 10.95, 10.95)

Area Scan (81x101x1): Interpolated grid: $dx=1.500 \text{ mm}$, $dy=1.500 \text{ mm}$

Maximum value of SAR (interpolated) = 0.812 W/kg

Zoom Scan (6x10x7)/Cube 0: Measurement grid: $dx=8\text{mm}$, $dy=8\text{mm}$, $dz=5\text{mm}$

Reference Value = 27.07 V/m; Power Drift = 0.11 dB

Peak SAR (extrapolated) = 0.905 W/kg

SAR(1 g) = 0.647 W/kg; SAR(10 g) = 0.469 W/kg

Maximum value of SAR (measured) = 0.797 W/kg

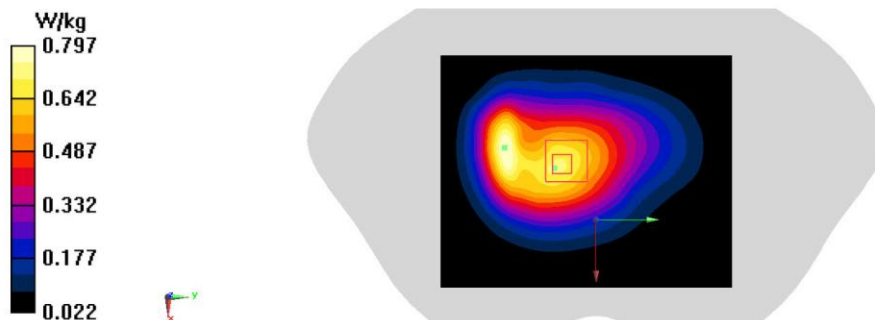

F. 22

LTE B5 Body-15mm

Date/Time: 2024/1/4

Electronics: DAE4 Sn1525

Medium: H700-6000M

Medium parameters used (interpolated): $f = 844 \text{ MHz}$; $\sigma = 0.876 \text{ S/m}$; $\epsilon_r = 44.617$; $\rho = 1000 \text{ kg/m}^3$

Ambient Temperature: 23.3°C Liquid Temperature: 22.5°C

Communication System: UID 0, LTE Band5 (0) Frequency: 844 MHz Duty Cycle: 1:1

Probe: EX3DV4 - SN7600 ConvF(10.95, 10.95, 10.95)

Area Scan (81x101x1): Interpolated grid: $dx=1.500 \text{ mm}$, $dy=1.500 \text{ mm}$

Maximum value of SAR (interpolated) = 0.546 W/kg

Zoom Scan (6x6x7)/Cube 0: Measurement grid: $dx=8\text{mm}$, $dy=8\text{mm}$, $dz=5\text{mm}$

Reference Value = 24.66 V/m; Power Drift = -0.06 dB

Peak SAR (extrapolated) = 0.590 W/kg

SAR(1 g) = 0.465 W/kg; SAR(10 g) = 0.343 W/kg

Maximum value of SAR (measured) = 0.550 W/kg

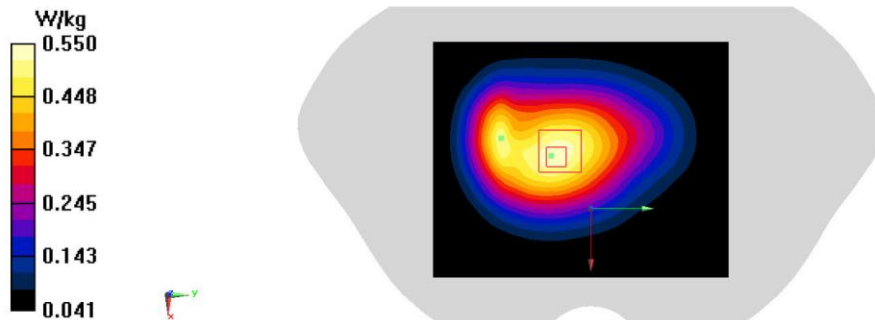

LTE B12 Head

Date/Time: 2024/1/1

Electronics: DAE4 Sn1525

Medium: H700-6000M

Medium parameters used (interpolated): $f = 707.5$ MHz; $\sigma = 0.868$ S/m; $\epsilon_r = 45.816$; $\rho = 1000$ kg/m³

Ambient Temperature: 23.3°C Liquid Temperature: 22.5°C

Communication System: UID 0, LTE Band12 (0) Frequency: 707.5 MHz Duty Cycle: 1:1

Probe: EX3DV4 - SN7600 ConvF(10.95, 10.95, 10.95)

Area Scan (71x121x1): Interpolated grid: dx=1.500 mm, dy=1.500 mm

Maximum value of SAR (interpolated) = 0.562 W/kg

Zoom Scan (7x9x7)/Cube 0: Measurement grid: dx=8mm, dy=8mm, dz=5mm

Reference Value = 3.966 V/m; Power Drift = 0.03 dB

Peak SAR (extrapolated) = 0.656 W/kg

SAR(1 g) = 0.385 W/kg; SAR(10 g) = 0.282 W/kg

Maximum value of SAR (measured) = 0.497 W/kg



F. 24

LTE B12 Body-10mm

Date/Time: 2024/1/1

Electronics: DAE4 Sn1525

Medium: H700-6000M

Medium parameters used (interpolated): $f = 707.5$ MHz; $\sigma = 0.817$ S/m; $\epsilon_r = 45.134$; $\rho = 1000$ kg/m³

Ambient Temperature: 23.3°C Liquid Temperature: 22.5°C

Communication System: UID 0, LTE Band12 (0) Frequency: 707.5 MHz Duty Cycle: 1:1

Probe: EX3DV4 - SN7600 ConvF(10.95, 10.95, 10.95)

Area Scan (81x101x1): Interpolated grid: dx=1.500 mm, dy=1.500 mm

Maximum value of SAR (interpolated) = 0.665 W/kg

Zoom Scan (6x10x7)/Cube 0: Measurement grid: dx=8mm, dy=8mm, dz=5mm

Reference Value = 27.58 V/m; Power Drift = -0.07 dB

Peak SAR (extrapolated) = 0.730 W/kg

SAR(1 g) = 0.535 W/kg; SAR(10 g) = 0.400 W/kg

Maximum value of SAR (measured) = 0.645 W/kg

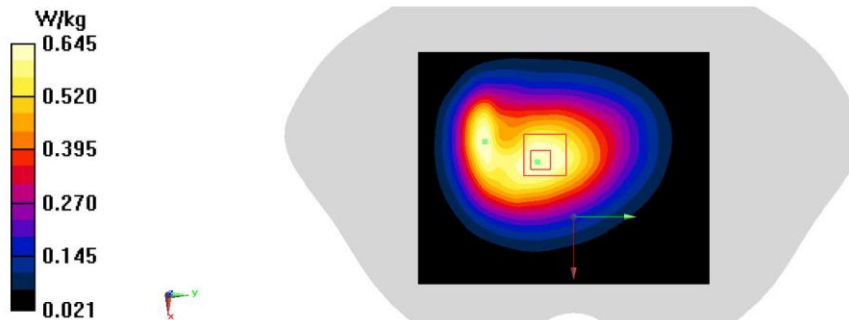

F. 25

LTE B12 Body-15mm

Date/Time: 2024/1/1

Electronics: DAE4 Sn1525

Medium: H700-6000M

Medium parameters used (interpolated): $f = 707.5$ MHz; $\sigma = 0.817$ S/m; $\epsilon_r = 45.134$; $\rho = 1000$ kg/m³

Ambient Temperature: 23.3°C Liquid Temperature: 22.5°C

Communication System: UID 0, LTE Band12 (0) Frequency: 707.5 MHz Duty Cycle: 1:1

Probe: EX3DV4 - SN7600 ConvF(10.95, 10.95, 10.95)

Area Scan (81x101x1): Interpolated grid: dx=1.500 mm, dy=1.500 mm

Maximum value of SAR (interpolated) = 0.420 W/kg

Zoom Scan (6x6x7)/Cube 0: Measurement grid: dx=8mm, dy=8mm, dz=5mm

Reference Value = 22.31 V/m; Power Drift = 0.09 dB

Peak SAR (extrapolated) = 0.476 W/kg

SAR(1 g) = 0.375 W/kg; SAR(10 g) = 0.271 W/kg

Maximum value of SAR (measured) = 0.449 W/kg

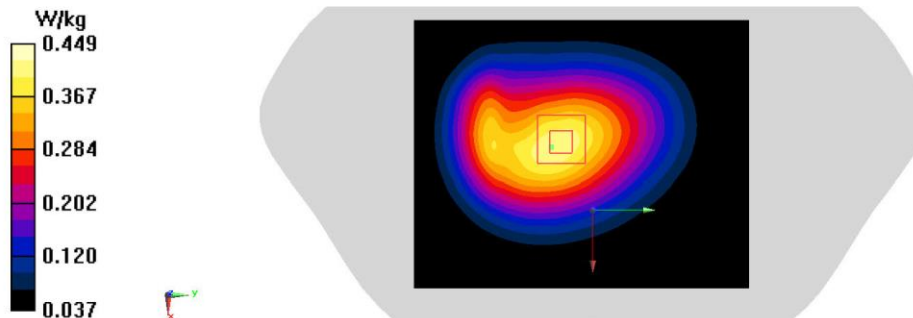

F. 26

LTE B13 Head

Date/Time: 2024/1/1

Electronics: DAE4 Sn1525

Medium: H700-6000M

Medium parameters used (interpolated): $f = 782 \text{ MHz}$; $\sigma = 0.9 \text{ S/m}$; $\epsilon_r = 45.614$; $\rho = 1000 \text{ kg/m}^3$

Ambient Temperature: 23.3°C Liquid Temperature: 22.5°C

Communication System: UID 0, LTE Band13 (0) Frequency: 782 MHz Duty Cycle: 1:1

Probe: EX3DV4 - SN7600 ConvF(10.95, 10.95, 10.95)

Area Scan (81x141x1): Interpolated grid: $dx=1.500 \text{ mm}$, $dy=1.500 \text{ mm}$

Maximum value of SAR (interpolated) = 0.499 W/kg

Zoom Scan (5x6x7)/Cube 0: Measurement grid: $dx=8\text{mm}$, $dy=8\text{mm}$, $dz=5\text{mm}$

Reference Value = 6.106 V/m; Power Drift = -0.12 dB

Peak SAR (extrapolated) = 0.591 W/kg

SAR(1 g) = 0.380 W/kg; SAR(10 g) = 0.258 W/kg

Maximum value of SAR (measured) = 0.510 W/kg

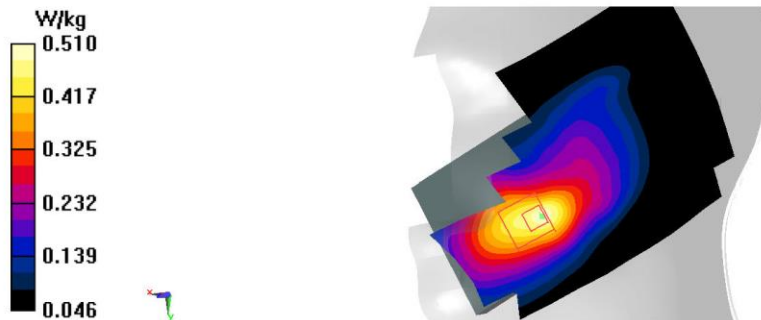

F. 27